



EMPRESS™ 2.4GHz Active RFID Reader
HKRAR-EM02-ETH

User Manual

Revision: 2.0.0.4



Before use, please read these instructions completely

Disclaimer

The information and know-how included in this document are the exclusive property of Hong Kong RFID Limited and are intended for the use of the addressee or the user alone. The addressees shall not forward to another their right of using the information, know-how or document forwarded herewith, in whole or in part in all matters relating or stemming from or involved therein, where for consideration or with consideration, and shall not permit any third party to utilize the information, know-how or the documents forwarded herewith or copies or duplicated thereof, unless at the company's consent in advance and in writing.

Enterprise License

No part of this document may be reproduced, distributed, publicized or made publicly available in part or in total without prior written consent of Hong Kong RFID Ltd. All content herein is solely owned by Hong Kong RFID Ltd. All inquiries should be directed to info@hk-rfid.com

Important Notice

All statements, technical information, and recommendations related to Hong Kong RFID Ltd.'s products are based on information believed to be reliable, but the accuracy or completeness is not guaranteed. Before using this product, you must evaluate it and determine if it is suitable for your intended application. You assume all risks and liabilities associated with such use. Any statements related to the product which are not contained in HKRFID's current publications, or any contrary statements contained on your purchase order shall have no force or effect unless expressly agreed upon, in writing, by an authorized officer of Hong Kong RFID Ltd.

EMPRESS is a trademark of Hong Kong RFID Ltd.

FCC Compliance

This device complies with part 15 of the FCC Rules. Operation is subject to the following two conditions: (1) This device may not cause harmful interference, and (2) this device must accept any interference received, including interference that may cause undesired operation.

Any changes or modifications not expressly approved by the party responsible for compliance could void the user's authority to operate the equipment.

NOTE: This equipment has been tested and found to comply with the limits for a Class B digital device, pursuant to part 15 of the FCC Rules. These limits are designed to provide reasonable protection against harmful interference in a residential installation. This equipment generates, uses and can radiate radio frequency energy and, if not installed and used in accordance with the instructions, may cause harmful interference to radio communications. However, there is no guarantee that interference will not occur in a particular installation. If this equipment does cause harmful interference to radio or television reception, which can be determined by turning the equipment off and on, the user is encouraged to try to correct the interference by one or more of the following measures:

- Reorient or relocate the receiving antenna.
- Increase the separation between the equipment and receiver.
- Connect the equipment into an outlet on a circuit different from that to which the receiver is connected.
- Consult the dealer or an experienced radio/TV technician for help.

CE Compliance:



Use only the power supply listed in the user instructions

Power supply adaptor:

1. Manufacturer: Pihong Technology Co. Ltd, model no.: PSA16U-480(POE)";
2. Manufacturer: Kuantech (Beihai) Co., Ltd, model no.: KSAS0120500200HK";

(Please refer to page 11)

Disposal:

All electrical and electronic products including batteries should be disposed of separately from the municipal waste stream via designated collection facilities appointed by the government or the local authorities.

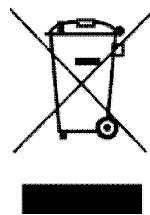

Thank you for purchasing EMPRESS™ Reader, it is wireless and therefore is easy to install with low installation costs. It is a 2.4GHz Gain Adjustable Reader which uses advanced 0.18um CMOS IC, and is well-fitted for being a Data Collector.

Through LAN interface, the Reader gathers and transmits data to the local network. Once powered, HKRAR-EM series is instantly connected and become part of the network.

HKRAR-EM02-ETH Active Reader is operated with standard TCP/IP network interface. You can get data and do analysis with a PC in an efficient way. Its Omni-directional antenna can identify tags from all directions. Users can adjust the identification distance according to actual situations in order to make identification more accurate.

Components of Empress Active RFID System include Readers, Active Tag(s) and PC/Server. For detailed information, you may reference to Start Guide and Appendix.



Table of Contents

Product Features.....	8
Key Features.....	8
Highlighted Applications.....	8
Standard Package Contents	9
Product Details.....	10
<i>Reader Technological Specifications</i>	10
<i>Environmental and Hardware Specifications</i>	10
<i>Power Supply Specifications</i>	11
<i>Compatible AC Adaptor</i>	11
<i>Digital input / output</i>	12
<i>Ethernet LAN Specifications</i>	12
<i>Antenna Specifications</i>	12
Reader Indicators.....	13
Reader Startup Guide	14
<i>Antenna installation onto the Empress™ Reader</i>	14
<i>Reader Installation</i>	15
<i>Step by Step set up procedure</i>	16
Connecting & Configuring Digital Inputs/Outputs	27
<i>What Digital I/O is available on reader</i>	27
<i>How to control digital I/O</i>	27
<i>Example application to Digital I/O</i>	27
Safety Instructions.....	28
<i>Power Disconnect Device</i>	28
<i>Electrostatic Discharge</i>	28



User Manual of HKRAR-EM02 Series Active RFID Reader

Regulatory Compliance.....28

Appendix29

System Requirement for Reader29

Product Features

Key Features

- Connectivity: Ethernet
- RSSI to indicate signal strength of each received tag
- 3 configurable digital Input / Output ports for controlling external devices like LED lights and alarms
- Input pins for controlling the reader to perform certain functions
- Adjustable RF Gain value for setting RF sensibility
- Reading ability: up to 150 tags / second
- Maximum reading range: 60m
- Compatible with various types of 2.4GHz antenna in SMA standard connector

Highlighted Applications

- Temperature monitoring system
- Attendance system
- Door access control system

Standard Package Contents

Standard package of this product consists of following items:

- EMPRESS™ 2.4GHz Active RFID Reader (HKRAR-EM02-ETH) 1 pcs
- 2.4GHz Antenna 1 pcs
- DC Power Adapter 5V 1 pcs
- LAN Cable 1 pcs

Empress™ 2.4GHz Active RFID Reader
(connected with antennas)



Adapter with power cord



LAN cable



Product Details

Reader Technological Specifications

Frequency	2.4-2.5GHz ISM
Maximum reading range	30-60m, depends on environment
Anti-collision	Up to 150 tags within 1 second
RF output power	0dBm
Sensitivity	-90dBm
Modulation	GFSK
Data Rate	1Mbps
Received Signal Strength Indication (RSSI)	-50dBm to -80dBm, 1dB resolution, +/-6dB error

Environmental and Hardware Specifications

Operating Temperature	-20°C to 55°C
Storage Temperature	-40°C to 85°C
Maximum Shock	Drop from 1 foot (0.3 meter) to any corner
Relative Humidity	95% non-condensing
Case Material	Plastic
Case Dimensions	125mm x 102mm x 26mm
Weight	180g

Power Supply Specifications

Supply voltage	5V DC
Current consumption	500mA

Compatible AC Adaptor



Brand: PHIHONG
 Model: PSA16U – 480(POE)
 Input Voltage: 90 – 264VAC
 Output Voltage: 48V



Brand: KUANTECH
 Model: KSAS0120500200HK
 Input Voltage: 90 – 264VAC
 Output Voltage: 5V

Digital input / output

Connector	USB MINI-B
Input high voltage	2.4V – 3.3V
Input low voltage	0V - 0.9V
Output high voltage (0.5mA drive)	>3V
Output low voltage (0.5mA drive)	<0.3V

Ethernet LAN Specifications

Connector	RJ45
Ethernet	10/100 Base-T

Antenna Specifications

Type	AT022 WLAN antenna
Frequency (FDC)	2400-2500MHz
Polarization	Vertical
Gain	3.86 dBi – 2.92 dBi (Avg. 3dBi)
VSWR, maximum	<2 : 1
Input Impedance	50Ω
Power Handling	20 W
Size	Φ10×108mm
Weight	8.5g

(These Antenna Specifications refer to the antenna shipped with standard package)

Reader Indicators

	Name	Function / Description
1	DC Power Jack	Supply power
2	TCP	Connection port between PC and reader
3	Serial Port	
4	Red LED	To signify power on
5	Green LED	For data processing identification
6	Blue LED	Keep on: if in configuration mode via WIFI Flash: if in firmware upgrade mode
7	Entering configuration mode/ upgrading reader's firmware	<p><u>Entering configuration mode:</u> Make sure there is no power supply. Press and hold the button. In the meantime, connect the power. Release the button when reader is powered-on.</p> <p><u>Upgrading reader's firmware:</u> Make sure there is no power supply. Press and hold the button. In the meantime, connect the power. Do not release the button until the blue LED is flashing.</p>



Reader Startup Guide

NOTE:

Check the quality of your *Empress™* Reader before you start the setup!

The below checklist may help:

1. Check if there are any scratches on the Reader. If there are two or more scratches of size larger than 1.5mm x 1.5mm or scratch lines longer than 5mm.
2. Check if the power indication light is on when connected to power source.
3. Check if the antenna port is loose.

If the above situation(s) happened, please return the Reader to HK-RFID for replacement.

*Antenna installation onto the *Empress™* Reader*

1. Screw the antenna to the antenna port. But not too tight.

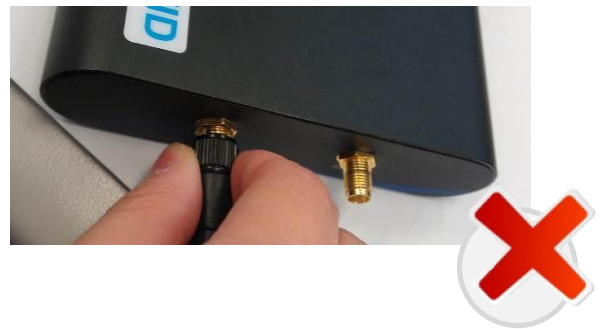
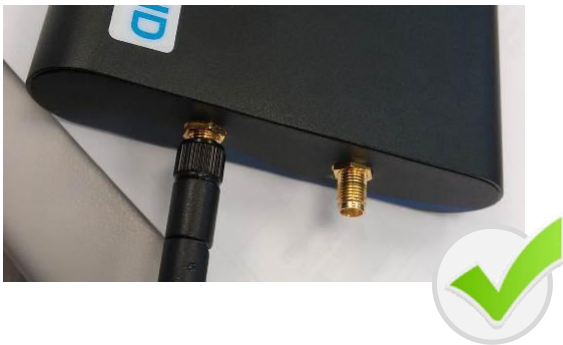

2. Turn the middle part of the antennas (Do not turn the screw part of the antennas)



Reader Installation

Items required for set up

Empress™ 2.4GHz Active RFID Reader (connected with antennas)



Adapter with power cord



LAN cable



NOTE:



Active Transponders are essential to test the system and they are sold separately. Please contact your sales representative if you do not have any active transponders.

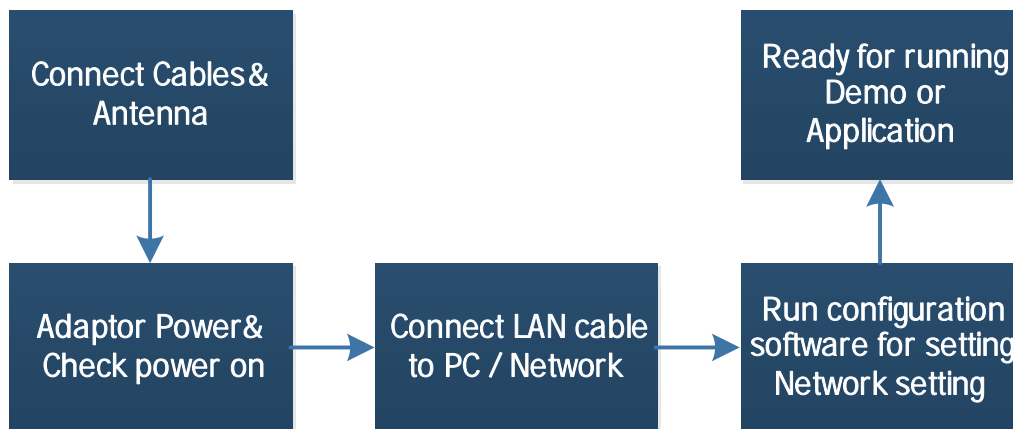

Step by Step set up procedure

1) Connecting power



Connect the power cord and the Reader to the adapter accordingly. The reader is on with a red light.

2) Connecting to PC

Plug the two ends of the LAN cable into the reader and the PC. The connection should now be like this:

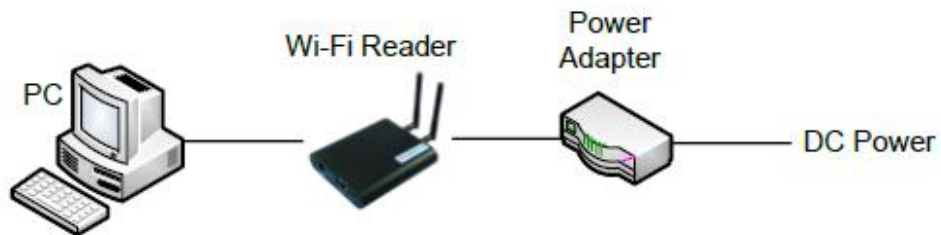

- 3) PC IP configuration
Turn off Wi-Fi function of the PC.
Click 'Start' and choose 'Control Panel'.



Choose 'Network and Internet'.

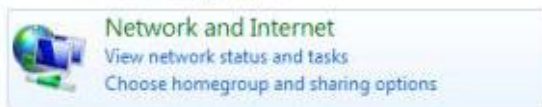

Choose 'Network Sharing Center'.



Click 'Change Adapter Settings' on the left menu

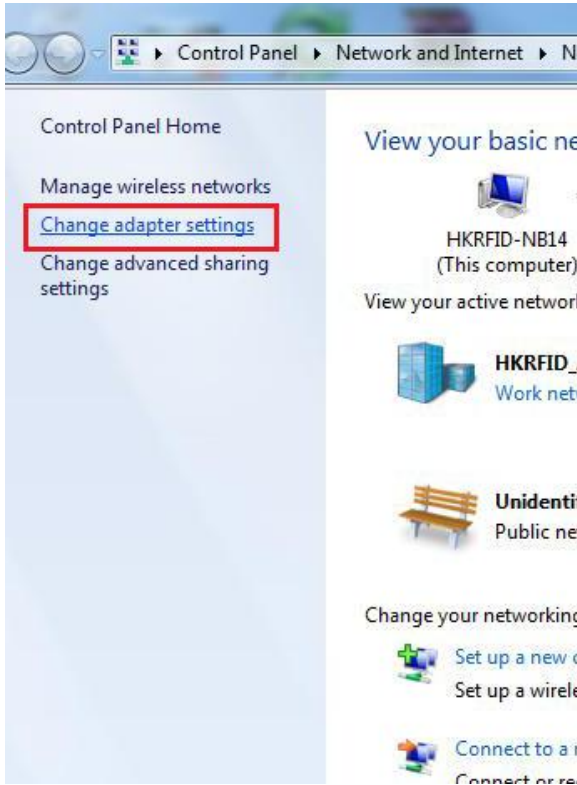

Double click on 'Local Area Connection'.



Click 'Properties' button.

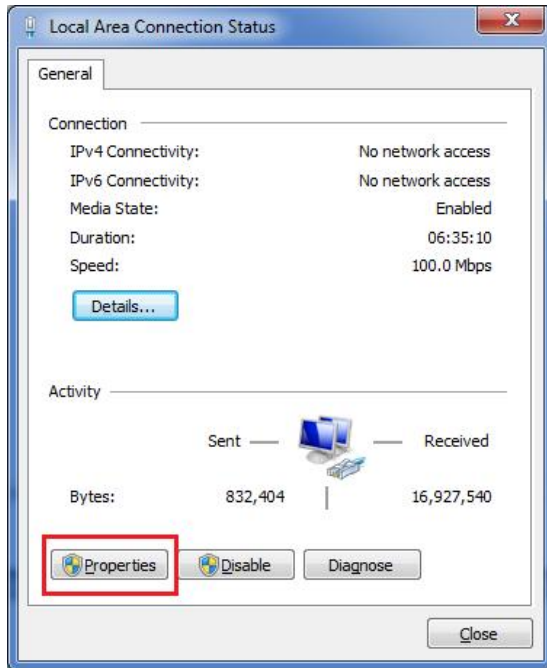

Choose "Internet Protocol Version 4 (TCP/IPv4)" and click the "Properties" button.

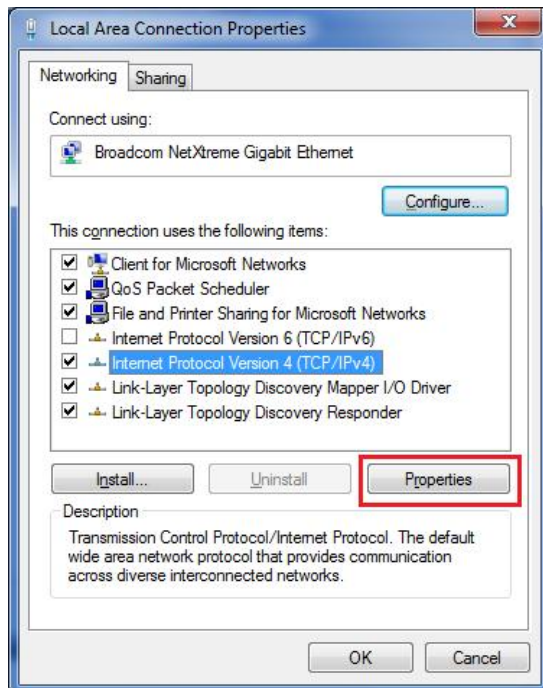

Choose 'Use the following IP address' and type in an IP address. IP address format should be "192.168.P.Q". P and Q is an integer between 1 and 254. For example, '192.168.1.10'.

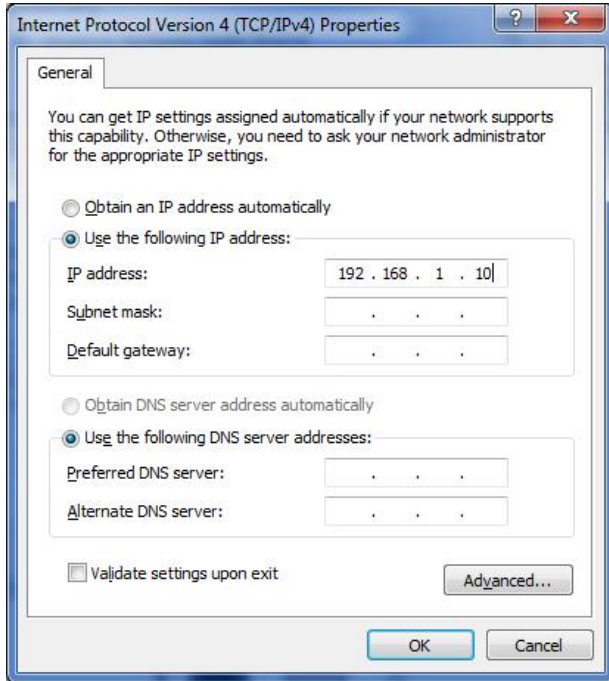

Click the text box of 'Subnet mask', the system will fill in the subnet mask automatically. Click 'OK' to close all windows.

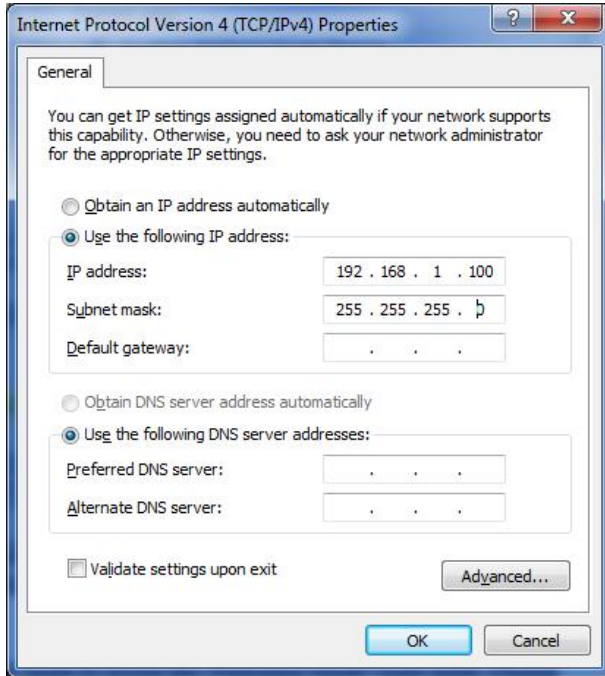

4) Configure the reader

Open the program 'EM02 Configuration Tool.exe'.

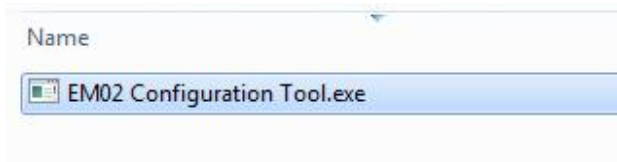

Click 'Find'

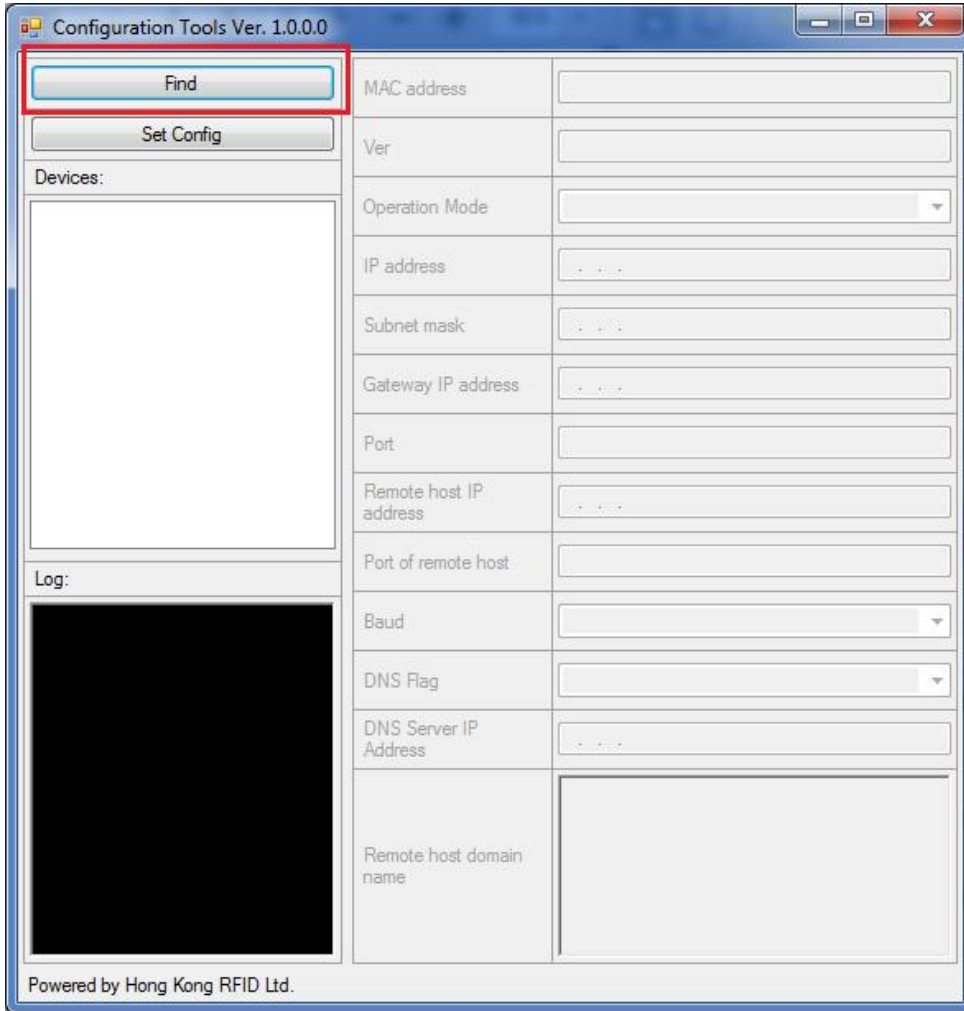

The devices found would be shown on the left column.

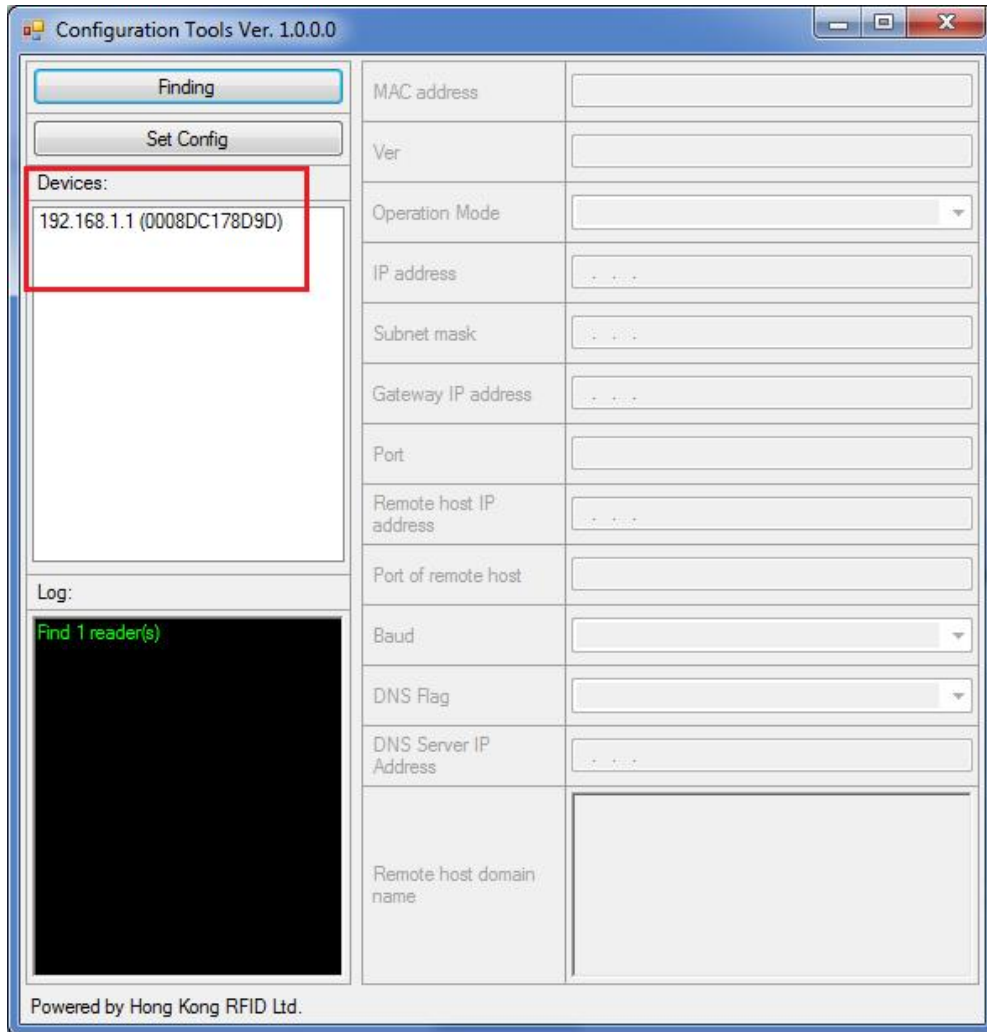

Remark: The IP address of PC (Set in step 3, i.e.192.168.P.Q).The IP address of the device (i.e. 192.168.X.Y). P,Q,X and Y is an integer between 1 to 254. X should equal to P. For example, the IP address of the device is "192.168.1.1". Then, the IP address of PC should be set to "192.168.1.y". And y should not equal to 1. Otherwise, configuration setting will be failed.

The current configurations of the selected reader would be displayed on the right column. Type in the IP address, subnet mask and gateway IP address that you wish to set for the Empres™ 2.4GHz Active RFID Reader inn the corresponding fields.

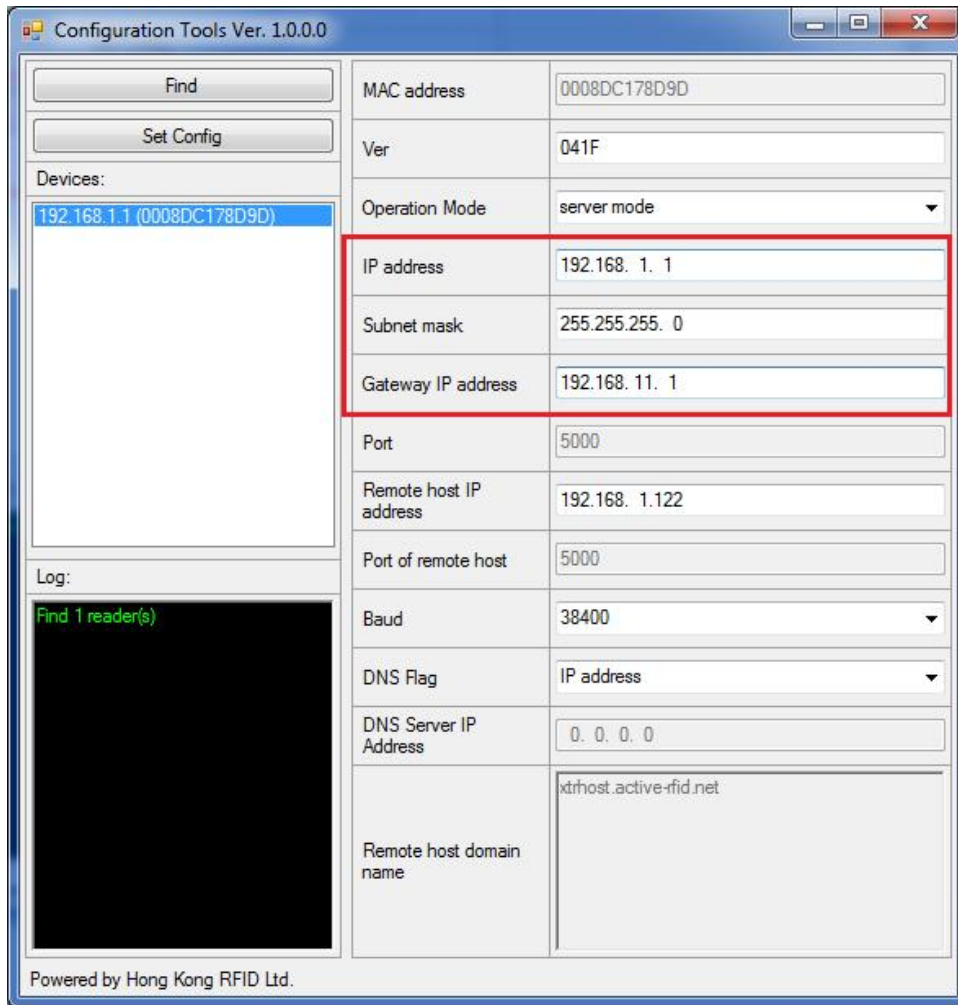

Select the operation mode and the DNS Flag you wish to use.

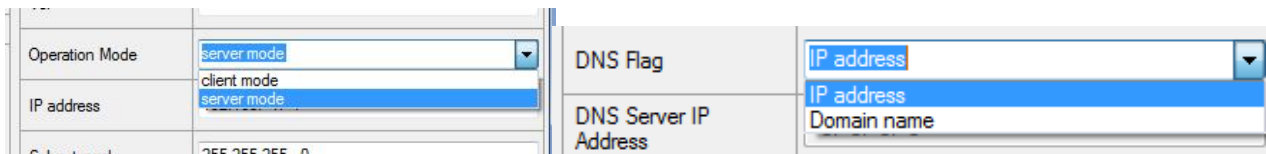

- 5) IP address
Type in the IP address of the remote host.

Remote host IP address	192.168. 1.122
Port of remote host	5000
Baud	38400
DNS Flag	IP address
DNS Server IP Address	0. 0. 0. 0
Remote host domain name	xtrhost.active-rfid.net

- 6) Domain name
Type in the IP address of the DNS server.
Type in the domain names of the remote host.

Remote host IP address	192.168. 1.122
Port of remote host	5000
Baud	38400
DNS Flag	Domain name
DNS Server IP Address	0. 0. 0. 0
Remote host domain name	xtrhost.active-rfid.net

Click 'Set Config' at the top left corner to finish the configuration of the Reader.

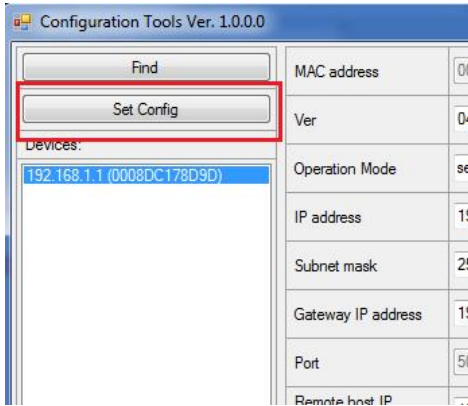

The result would be shown on the bottom left corner. Then click 'Close' to close the browser.

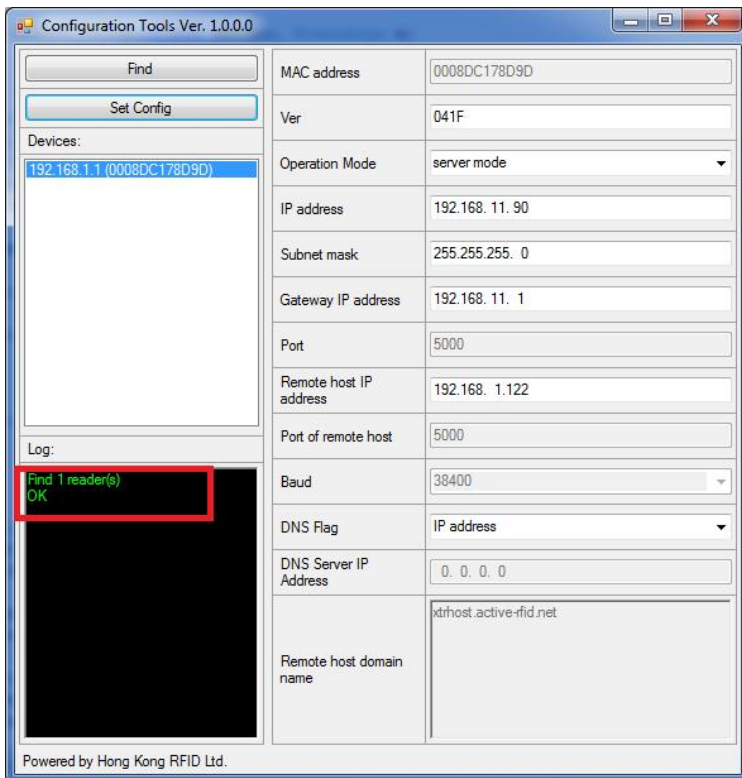

7) Using the Demo Program

Please refer to 'Basic Demo Program User Guide.pdf'.

Connecting & Configuring Digital Inputs/Outputs

What Digital I/O is available on reader

Three configurable I/O (Input/ Output) pins are available with EM02. Each pin can be individually set to input (controlling the reader to perform certain functions) or output (controlling external devices like LED lights and alarms).



Digital I/O port located at the rear panel of reader. It is USB 2.0 Mini Type B Jack (5 positions).

1 2 3 4 5

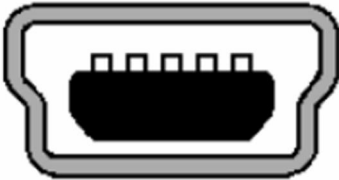

Mini-B

Pin	Function
1	GPIO0
2	GPIO1
3	GPIO2
4	NC
5	GND

How to control digital I/O

Please refer to 'Communication protocol' for more information about the configuration of I/O pins.

For the details of control method of digital input and output, please refer to 'Communication Protocol.pdf'.

Example application to Digital I/O

- Door Access Controls System
- Alarm System

Safety Instructions

Power Disconnect Device

The plug on the power supply cord is intended to be a power disconnection device. As a result, the power source (socket or outlet) shall be located near the equipment and shall be easily accessible.

Electrostatic Discharge

ATTENTION:

The EMPRESS™ 2.4GHz Active RFID Reader may be damaged from static discharge or other high voltage. Use proper Electrostatic Discharge precautions to avoid static discharge. Equipment failure could occur if the antenna or ports are subjected to ESD.

Regulatory Compliance

CAUTION:

The EMPRESS™ 2.4GHz Active RFID Reader is designed to meet the regulatory requirements in those jurisdictions in which it is offered. Changes or modifications not expressly approved by Hong Kong RFID Ltd. for compliance could void the user's authority to operate the equipment.

Appendix

System Requirement for Reader

Computer System

Minimum PC Requirements:

- | | |
|--------------------|---------------------------------|
| Processor: | Pentium 4 or above |
| Memory: | 512MB or above |
| Operating System: | Windows XP sp3 or above |
| Required Software: | .Net Framework 3.5 sp1 or above |
| Hard disk: | Space 100MB or above |
- LAN 10/100 BASE Connection Interface