

User Manual

RT-800

Wideband Precision Direction Finder RHOTHETA Elektronik GmbH



Edited by:

RHOTHETA Elektronik GmbH
Kemmelpark
Dr.-Ingeborg-Haeckel-Str. 2
82418 Murnau
Germany

Tel.: +49 8841 4879 - 0
Fax: +49 8841 4879 - 15

Internet: www.rhotheta.de
E-Mail: email@rhotheta.de

*Copyright © RHOTHETA Elektronik GmbH
All rights reserved
- Issue: 2020/01/09 [Rev 2.02]
- Document-ID: 12-9-1-0003-3-1-61*

NOTE:

The manufacturer reserve the right to make modifications at any time and without previous information of the here described product.

Content

1	Safety Instructions	8
1.1	Legend of Symbols	8
1.2	Basic Safety Instructions	9
2	Legal Information.....	9
2.1	EU Declaration of Conformity	9
2.2	Legal Limitations of Use within the EU	9
2.3	FCC Information (USA).....	10
2.4	ISED Information (Canada)	10
3	Use and Characteristics.....	11
4	Short Description.....	12
4.1	Front View (DCU)	12
4.2	Front View (Buttons and Display)	13
4.3	Bearing Display (Main Page).....	15
4.4	Rear View	18
5	Operation.....	19
5.1	Bearing Operation.....	19
5.1.1	Instruction Fields (flags, errors and warnings).....	21
5.1.2	Alarm Function.....	22
5.1.3	Function Repeat	22
5.1.4	Function Clear.....	22
5.1.5	Function Channel 16.....	23
5.1.6	Function SAR.....	23
5.1.7	Function Scan	23
5.2	Monitoring Operation	24
5.2.1	Timing of normal Monitoring Operation	25
5.2.2	Timing Monitoring with selected Cospas-Sarsat Main Frequency	25
5.2.3	Monitoring operation with filtering of Emergency Transmitters: ID-Only	25
5.3	Standby-Operation.....	26
5.3.1	Standby Mode SAR	26
5.3.2	Standby Mode PLB.....	26
5.4	Scan-Dialogue	27
5.4.1	Fast Channel Scan	27
5.4.2	Fast Marine Scan.....	28
5.5	SAR-Dialogue	30
5.6	Cospas-Sarsat Decoding Data Content	31
6	Operating and Adjusting.....	33
6.1	Reset of the DCU.....	34
6.2	Setting Main Bearing Frequency/Channel.....	35
6.2.1	Adjusting Main Bearing Frequency.....	35
6.2.2	Setting a Main Operating Channel.....	36

6.3	Adjusting the Squelch	37
6.3.1	Hints for Squelch Level Adjustment.....	37
6.3.2	Manual Adjusting of Squelch Levels.....	38
6.3.3	Automatic Adjustment of Squelch Levels	39
6.3.4	Automatic Squelch.....	40
6.4	Adjusting Monitoring Operation and ID-only Filtering.....	41
6.5	Activating Standby Operation	42
6.6	Setting Brightness (Dimming).....	43
6.6.1	Automatic Adjustment of Brightness of Display and LEDs.....	44
6.6.2	Manual Adjustment of Display and LED Brightness	44
6.6.3	Adjustment of Key Illumination (legends)	44
6.7	Setting the Volume (Volume).....	45
6.7.1	Muting the Speaker (Mute)	45
6.7.2	Setting Speaker Volume	46
6.7.3	Functional Test of Speaker.....	46
6.8	Activating Memory / Band function	47
6.8.1	Recall Frequency/Channel from Storage List.....	47
6.8.2	Edit Text (of Frequency/Channel) in Storage List.....	48
6.8.3	Move a Frequency/Channel within a Storage List.....	49
6.8.4	Delete a Frequency/Channel in the Storage List.....	49
6.8.5	Store a new Frequency/Channel in a Storage List.....	50
7	Menu (Setup).....	51
7.1	Menu General	52
7.1.1	Audio.....	52
7.2	Menu Interface.....	53
7.2.1	NMEA Std Sentence	53
7.2.2	NMEA Mode.....	53
7.2.3	NMEA baud rate	54
7.2.4	Compass Source	54
7.3	Menu System.....	55
7.3.1	Address-ID.....	55
7.3.2	Antenna Unit	55
7.3.3	Audio Line Output.....	55
7.3.4	Antenna Offset.....	55
7.3.5	PS Ram.....	56
7.3.6	Monitoring	56
7.3.7	S/N-Ratio AutoSQL.....	56
7.3.8	AU-Calibration.....	56
7.3.9	BeepTone Decoding	56
7.3.10	CPSS Dialog Time.....	56
7.4	Menu Service.....	57
7.4.1	Monitor	57
7.4.2	Password	57
7.5	Unlocking Setup Settings	58
8	Interfaces.....	59
8.1	Overview.....	59
8.2	Device Ports	60
8.2.1	Antenna Unit Port (Connecting Cable DCU ⇔ AU).....	60
8.2.2	GPS / RS422 Port.....	61
8.2.3	Fuse F3.....	61

8.3	Remote Control and IP-Audio Encoder Ports.....	62
8.4	Power Supply.....	63
8.5	Service & Maintenance Ports	64
8.5.1	Power Supply and Optional Connections	64
8.5.2	NMEA Bus (RS 232).....	65
8.5.3	Test / Program	66
9	Guideline for optimal DF antenna position.....	67
10	Technical Data Sheet.....	68
10.1	Electrical Characteristics	68
10.2	Mechanical Characteristics.....	70
10.2.1	DCU Dimensions (built-in version)	70
10.2.2	DCU Dimensions (tabletop version)	71
10.2.3	DCU Data	71
10.2.4	Antenna Unit Dimensions	72
10.2.5	Antenna Unit Mast Flange	73
10.2.6	Technical Data Antenna Unit.....	73
11	Maintenance and Cleaning.....	74
12	Product Disposal	75
12.1	Disposal within the European Union.....	75
12.2	Disposal outside the European Union	75
13	Appendix	76
13.1	Error Messages	76
13.2	Warnings.....	76
13.3	Frequencies of channels on maritime band	77
13.4	List of abbreviation.....	78

List of figures

Fig. 1 Front View – DCU.....	12
Fig. 2 Front View – Buttons and Display.....	13
Fig. 3 Bearing Display	15
Fig. 4 Rear view.....	18
Fig. 5 Bearing operation	19
Fig. 6 Digital display of bearing value	20
Fig. 7 Last bearing (time, frequency)	20
Fig. 8 Instruction fields.....	21
Fig. 9 Monitoring operation	22
Fig. 10 Example active monitoring frequency	24
Fig. 11 Monitoring operation	24
Fig. 12 Example: Timing normal monitoring	25
Fig. 13 Example: Timing Cospas-Sarsat	25
Fig. 14 Example: Timing Standby Mode: SAR.....	26
Fig. 15 Example: Timing Standby Mode: PLB	26
Fig. 16 Scan-Dialogue	27
Fig. 17 SAR-Dialogue	30
Fig. 18 Display of Cospas-Sarsat Scanning-Mode	30
Fig. 19 Cospas-Sarsat data decoding	32
Fig. 20 Operating and adjusting.....	33
Fig. 21 Switch-on system information.....	34
Fig. 22 Input of main bearing frequency	35
Fig. 23 Input of a main bearing channel	36
Fig. 24 Adjustment squelch level.....	37
Fig. 25 Dialogue window: Squelch level adjustment.....	38
Fig. 26 Auto-Squelch Marker	
Fig. 27 Dialogue window Monitoring settings.....	41
Fig. 28 Activation of Standby operation	42
Fig. 29 Dialogue window Dimming	43
Fig. 30 Automatic dimming	44
Fig. 31 Manual dimming	44
Fig. 32 Dialogue window Volume	45
Fig. 33 Muting the speaker	45
Fig. 34 Speaker volume.....	46
Fig. 35 Speaker functional test	46
Fig. 36 Dialogue window Memory / Band	47
Fig. 37 Text input window.....	48
Fig. 38 Operating Menu Setup (example: Interface / NMEA Standard Sentence).....	51
Fig. 39 Menu General, table default settings	52
Fig. 40 Menu Interface, table default settings.....	53
Fig. 41 Menu System, table default settings.....	55
Fig. 42 Menu Service table	57
Fig. 43 Overview of Interfaces	59
Fig. 44 Connecting cable DCU↔AU	60
Fig. 45 Example for optimal DF antenna position	67
Fig. 46 RT-800, mechanical dimensions (built-in version)	70
Fig. 47 RT-800, mechanical dimensions (tabletop version).....	71
Fig. 48 Antenna Unit, mechanical dimensions.....	72
Fig. 49 Antenna Unit, mast flange (mechanical dimensions).....	73

1 Safety Instructions

RHOTHETA Elektronik GmbH is constantly trying to keep the safety standard of the products up to date and to offer the customers the highest possible level of security.

RHOTHETA products are designed and tested in accordance with the valid safety regulations. The compliance with these standards is continuously monitored by our quality assurance system. This product is manufactured in accordance with the EC Certificate of Conformity, tested and left the factory in perfect technical and safety-relevant condition.

To maintain this condition and to ensure safe operation, the user must pay attention to all instructions and warnings given. For any questions regarding these safety instructions, RHOTHETA Elektronik GmbH can be contacted at any time.

The observance of the safety instructions will help to prevent personal injury or damage caused by all kinds of dangers. This requires that the following safety instructions must be read carefully and understood before using the product, as well as observed when using the product. The additional safety instructions such as for protecting persons appear in relevant parts of the product documentation and must also be paid attention to.

In addition, it is the responsibility of the user to use the product appropriately. The product RT-800, a professional direction finder system may not be used in any way that a person / thing is injured or damaged.

The use of this product other than its designated purpose or in disregard of the instructions of the manufacturer is the responsibility of the user. The manufacturer takes no responsibility for the misuse of the product.

The manufacturer is not liable beyond the scope of legal rules!

This guide is part of the product RT-800 and is retained throughout the lifetime and to pass with the product.

1.1 Legend of Symbols

NOTE:

This symbol designates tips or additional notes that must be paid attention to and make work easier.

ATTENTION:

means that ignoring the instructions may lead to property damage or loss of data.

WARNING:

means that ignoring the instructions, there may a danger to health or life.

1.2 Basic Safety Instructions

ATTENTION:

Read and observe the following instructions, warnings and safety instructions of the manufacturer!

- At all work, the local or national safety and accident prevention regulations must be observed.
- Use only the manufacturer prescribed components and / or use only recommended material by the manufacturer and do not change this.
- Connect only approved accessories kits or additional equipment.
- The product may only be opened by authorized service personnel.
- The unit voids its type approval on operating with unauthorized modifications on the device or not the intended use.

2 Legal Information

2.1 EU Declaration of Conformity

Hereby RHOTHETA Elektronik GmbH declares that the product RT-800 is in compliance with the essential requirements and other relevant provisions of:

- Directive 2014/53/EU relating to radio equipment (relevant for RT-800 AU)
- Directive 2014/30/EU relating to electromagnetic compatibility (relevant for RT-800 DCU)
- Directive 2014/35/EU relating to the making available on the market of electrical equipment designed for use within certain voltage limits (relevant for RT-800 DCU)
- Directive 2011/65/EU on the restriction of the use of certain hazardous substances in electrical and electronic equipment (relevant for RT-800 and RT-800 DCU)

The full text of the Declaration of Conformity can be found at:

http://www.rhotheta.com/products/rt_800

2.2 Legal Limitations of Use within the EU

Due to its conformance to “Directive 2014/53/EU on the harmonisation of the laws of the Member States relating to the making available on the market of radio equipment and repealing Directive 1999/5/EC”, declared in the EU declaration of conformity, the equipment may be used within the European Union without limitations regarding the use of frequencies in those countries.

Please also consider national limitations or requirements for special operational permissions in your country.

2.3 FCC Information (USA)

Changes or modifications not expressly approved by the party responsible for compliance (RHOTHETA) could void the user's authority to operate the equipment.

Note

RT-800 AU has been tested and found to comply with the limits for a Class B digital device, pursuant to part 15 of the FCC Rules. These limits are designed to provide reasonable protection against harmful interference in a residential installation. This equipment generates, uses, and can radiate radio frequency energy and, if not installed and used in accordance with the instructions, may cause harmful interference to radio communications. However, there is no guarantee that interference will not occur in a particular installation. If this equipment does cause harmful interference to radio or television reception, which can be determined by turning the equipment off and on, the user is encouraged to try to correct the interference by one or more of the following measures:

- Reorient or relocate the receiving antenna.
- Increase the separation between the equipment and receiver.
- Connect the equipment into an outlet on a circuit different from that to which the receiver is connected.
- Consult the dealer or an experienced radio/TV technician for help.

2.4 ISED Information (Canada)

This device contains license-exempt transmitter(s) / receiver(s) that comply with Innovation, Science and Economic Development Canada's license-exempt RSS(s). Operation is subject to the following two conditions:

- (1) This device may not cause interference.
- (2) This device must accept any interference, including interference that may cause undesired operation of the device.

Le présent appareil est conforme aux CNR d'Industrie Canada applicables aux appareils radio exempts de licence. L'exploitation est autorisée aux deux conditions suivantes : (1) l'appareil ne doit pas produire de brouillage, et (2) l'utilisateur de l'appareil doit accepter tout brouillage radioélectrique subi, même si le brouillage est susceptible d'en compromettre le fonctionnement.

A radio license must be obtained prior to possession and use of this scanner receiver. Une licence radio doit être obtenue avant la possession et l'utilisation de ce récepteur de scanner.

3 Use and Characteristics

The DF-system RT-800 combines a communication direction finder and a SAR (Search and Rescue) direction finder, thus allowing to bear all coastal and maritime radio stations. EPIRB (Emergency Position Indicating Radio Beacon) equipped persons or vessels may be found quickly and safely.

The DF-system RT-800 allows the bearing of radio signals on 5 different frequency bands as well as traditional emergency frequencies in the VHF and UHF range, the common calling up channel 16 in the maritime radio band and the widely used Cospas-Sarsat emergency signals. Optionally the whole frequency range 118,000 MHz – 470,000MHz could be unlocked!

Frequency Ranges:	Standard-Version		Optional extended Frequency Range	
VHF air band	118,000 MHz	- 124,000 MHz	118,000 MHz	- 136,992 MHz
VHF marine band	154,000 MHz	- 163,000 MHz	137,000 MHz	- 224,995 MHz
Maritime channels	Channel 00 (Ship / Coast)	- Channel 88 (Ship / Coast)		
UHF air band	240,000 MHz	- 246,000 MHz	225,000 MHz	- 399,975 MHz
Cospas-Sarsat	400,000 MHz	- 406,092 MHz		
UHF FM band	406,100 MHz	- 410,000 MHz	406,100 MHz	- 470,000 MHz

Full automatic bearing of emergency signals in the monitoring and standby mode guarantees additionally a permanent emergency surveillance and the auto alert function.

The DF-system consists of two units, the bearing AU (Antenna Unit) and the operating device DCU (Display Control Unit).

The bearing antenna is a dipole antenna, its housing contains all bearing electronics. Thus short bearing signal paths with low loss, but also high insensitiveness to external disturbing fields are achieved. The DF-system is working with the Doppler principle, and by the high rotation frequency of 3 kHz and clockwise / counterclockwise rotation of the antenna to compensate running time errors, highest precision of the system is achieved.

The indicating and operating system (DCU) represents bearing signals and allows operating and controlling of the bearing antenna. Additionally external devices can be connected (speaker, audio / line out, PTT push to talk). Also data in- and export is possible by various interfaces including remote control over IP and IP-based audio transmission.

The DF-system is suitable for stationary surveillance of coastal ship traffic as well as for mobile use on big vessels. AU is watertight (protection IP 67) and may be used under extreme and rough conditions. Optionally a lightning protection rod is available for costal VTS installations.

WARNING: The DF-system RT-800 is not licensed for primary navigation. It may support navigation if necessary, but navigation of a vessel may not be based under any circumstances on data obtained by the DF-system.

4 Short Description

4.1 Front View (DCU)









Fig. 1 Front View – DCU









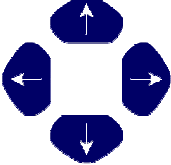

Pos.	Designation	Function	See page
1.	Control Panel	Display of bearing data; local control of the direction finder	13
2.	Speaker	Audio Speaker for received signal (volume is adjustable with button Volume)	45
3.	Power Switch	Switches system power On and Off	---

4.2 Front View (Buttons and Display)

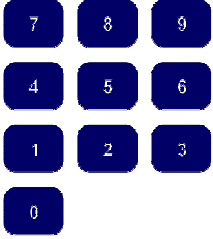

Fig. 2 Front View – Buttons and Display

Pos.	Designation	Function	See page
1.		Reset of the control panel	34
2.		Opens dialogue window for adjustment of brightness of the TFT-display, of the LEDs and illumination of keys	43
3.		Opens dialogue window for adjustment of volume and mute-function	45
4.		Opens dialogue window for adjustment of the squelch level	37
5.		Opens dialogue window for recalling and storing of own frequencies and channels	47
6.		Opens dialogue window for setting main bearing frequency / channel.	35
7.	TFT-Display (Thin-Film-Transistor)	Shows present bearing values during bearing, data content of Cospas-Sarsat or corresponding settings dialogues	19 31 33

Pos.	Designation	Function	See page
8.	 ... 	Software controlled function keys	33
9.		Closing dialogue or adjusting field without storing changed parameters	33
10.		Arrow keys enable selection of selection fields Increasing or decreasing of a value for one step	33
11.		Confirms and stores input or selection Closes dialogue window	33
12.		(n/a)	
13.		Opens setup menu	51
14.		Numeric keys for direct numeric input of frequency/ channels	33
15.	Sensor of brightness	Measures environmental brightness for best automatic adjustment of brightness of the TFT-display and key illumination	43
16.		Opens settings dialogue monitoring / scanning-mode with selective filtering of emergency transmitters and standby operation	24, 41
17.			
18.	extern. Heading 	Indicates correct reception of GPS-sentences xxRMC/xxGGA if option "UTC Time Base" is installed (additionally indicates input of compass data)	19, 54

4.3 Bearing Display (Main Page)

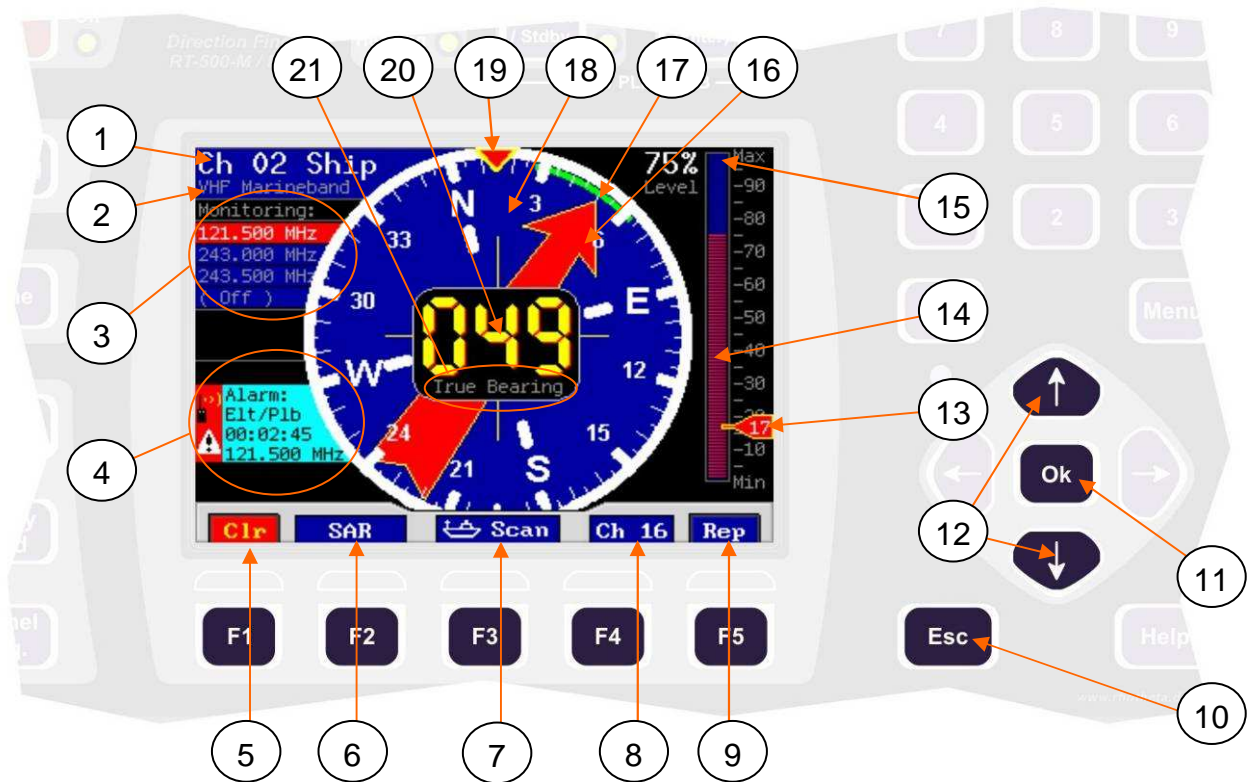











Fig. 3 Bearing Display

Pos.	Designation	Meaning	See page
1	Frequency or channel display	Display of present main bearing frequency or display of present main bearing channel	19
2	Display of frequency band	Display of frequency band related to present main bearing frequency/channel	19
3	Monitoring field	Display of selected frequencies/channels in monitoring mode	24
4	Instruction fields (Flags)	Display, additional to present adjustments (PTT, mute, alarm display) Warnings Error messages	21
5	Clr (Clear)	Clears the bearing value storage	22
6	SAR	Shows SAR-Dialogue It is used for direct selection of SAR-Frequencies, to start Cospas-Sarsat-Scanning and to start the Cospas-Sarsat – Decoding	30
7	Scan	Activation of Marine Scan Mode or Fast Channel Scan Mode	27
8	CH 16	Switch to common maritime emergency channel 16	23

Pos.	Designation	Meaning	See page
9	Rep (Repeat)	Recall last bearing value	22
10		Monitoring/scanning operation will be continued on next frequency/channel, if currently no signal is received on current frequency.	24
11		Taking over active scanning frequency as main bearing frequency (at signal reception only)	24
12	 	The squelch level of the main bearing frequency/channel may be adjusted directly by   keys (only possible if main frequency active; deactivated during Cospas-Sarsat-Scan)	37
13	Squelch threshold of current frequency / channel   	No signal received (signal level < squelch level) Signal is received and beared (signal level > squelch level) No signal received (Auto-Squelch active)	37
14	Bar indicator of signal level	Display of signal level of current frequency/channel <ul style="list-style-type: none"> • colour: cyan → no reception • colour: red → signal reception 	19
15	Digital signal level indicator	Digital indication of signal level of active bearing frequency/channel	19
16	Bearing indicator	Graphic display of bearing value relative to longitudinal axis of antenna	19
17	Spread of bearing	Maximum deviation of unaveraged single bearing values	19
18	360°-display Or Compass card	Without compass data: Display of relative bearing value in 360°-display. (If antenna mounted correctly, the 0°-value corresponds to North direction) If compass information available: graphic display of relative bearing value within compass card with display of the four cardinal points.	19
19	Heading Pointer	Is always in 12 o'clock position and displays present course if compass information available (only used for mobile applications)	19
20	Digital bearing indicator	Display of bearing value as a three-digit number	20

Pos.	Designation	Meaning	See page
21	Direction of reference	Indication of selected reference direction Relative Brg → bearing relative to longitudinal axis of antenna Magnetic Brg → Magnetic North (bearing relative to magnetic North) True Bearing → Geographic North (bearing relative to geographic North)	20

4.4 Rear View

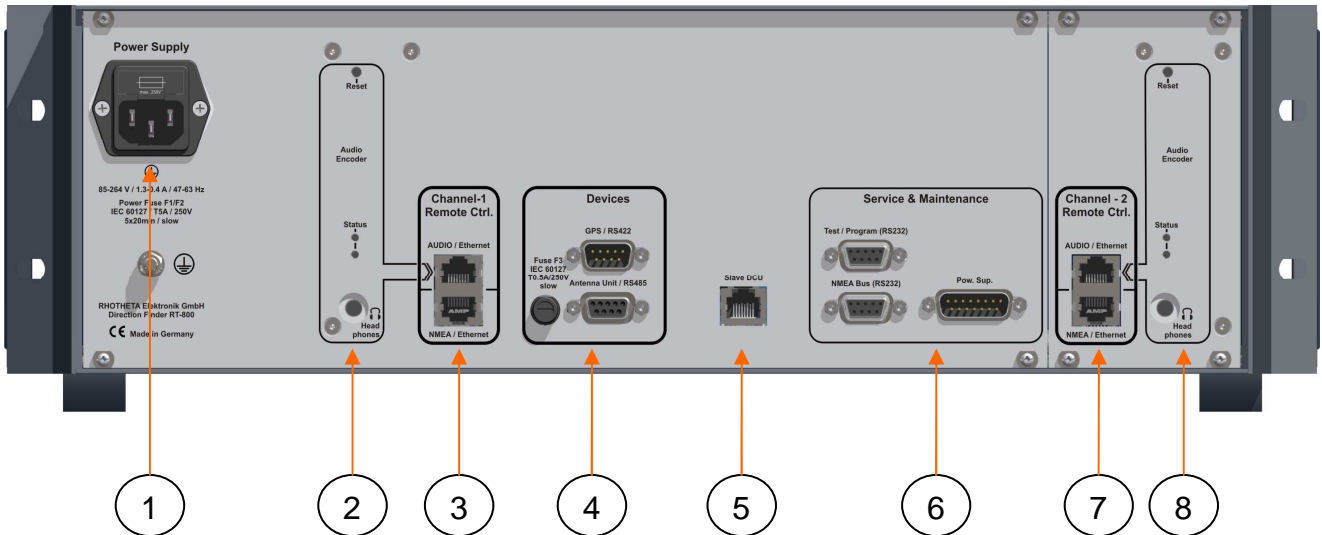

Fig. 4 Rear view

Pos.	Designation	Meaning	See page
1	Power Supply	Power supply connector with replaceable fuse	63
2	IP-Audio Encoder (Channel-1)	Audio Output for DF and encoder configuration	62
3	Remote Control Channel-1	Ethernet ports for remote control (NMEA / Ethernet) and IP-Audio (AUDIO / Ethernet)	62
4	Devices	Connector ports for AU (antenna unit) and optional GPS-connector for the option "UTC Time Base"; fuse for AU / GPS power supply	60
5	Slave DCU	Ethernet connector for factory use only	---
6	Service & Maintenance	Ports for optional connections, SW-Update and local NMEA-Output	64
7	Remote Control Channel-2	Option: "2 nd Channel Remote Control" Ethernet ports for remote control (NMEA / Ethernet) and IP-Audio (AUDIO / Ethernet)	---
8	IP-Audio Encoder (Channel 2)	Option: "2 nd Channel Remote Control" Audio Output for DF and encoder configuration	---

5 Operation

5.1 Bearing Operation

The display unit of the DF-system RT-800 during the bearing operation is the concentrically arranged TFT-display. All current bearing data, settings and status reports are displayed here.

Top left in the display the current **main bearing frequency** or, if operating in the sea band, the current **main bearing channel** will be displayed. If a duplex channel is selected, the reference position "Ship" for a maritime radio station is indicated additionally, or "Coast" for a coastal radio station. The frequency band related to the current main bearing frequency/channel is indicated too.



Fig. 5 Bearing operation

The level of a received signal on the selected operating frequency/channel is indicated digitally in the range of 0% to 99% and additionally as bar graph. The scale is not calibrated and serves as a measure of signal strength in quality.

The bearing electronics will process data only, if their signal level is above the selected **squelch level (= noise suppression)**. Even without a received signal the DF-system may display a certain signal level (= noise). In order not to bear these environmental noise signals, the squelch level shall be set above the noise level. For correct setting of the squelch level, please pay attention to chapter 6.3.

The DF-system captures about 280 bearing values per second. These bearing values may vary significantly, depending on signal quality (signal strength and modulation). This **range of spread** is the narrower, the better the signals quality is, respectively wider if the signals quality is decreasing.

The processing electronics will average the bearing values over a certain time, thus achieving a rather smoothed display of the bearing value, additionally, this averaging procedure still produces good bearing results if there's a wide spread of, e.g. $\pm 45\%$. The **relative** as well as the **digital bearing values** will be put out by the DF-system as averaged values.

The **relative bearing value** is depicted as an arrow and refers to the longitudinal axis of the antenna. This corresponds, if mounted correctly, to north.

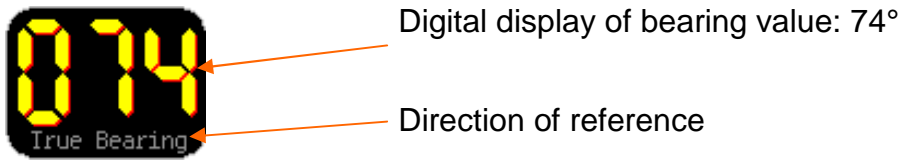

Fig. 6 Digital display of bearing value

The digital bearing display is a 3-digit number with a resolution of 1 degree.

Depending on compass data (only used in mobile applications), the bearing data displayed digitally with following directions of reference:

Display	Direction of reference	Meaning
Relative Brg.	Relative	Bearing relative to longitudinal axis of antenna
Magnetic Brg.	Magnetic North	Bearing relative to magnetic North
True Bearing	True North	Bearing relative to geographic North

After end of reception the last bearing value will be displayed flashing for ca. 5 sec. Then the bearing display will vanish and the field of the digital bearing display will show the passed time and the frequency of the last received bearing signal "Last Bearing":

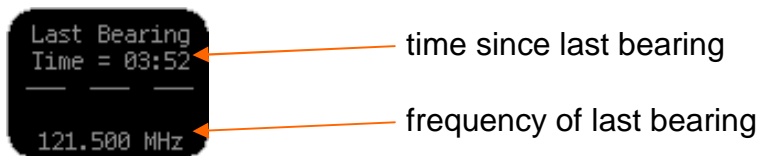

Fig. 7 Last bearing (time, frequency)

After pressing key "Repeat" (see 5.1.3) the last bearing value will be displayed again for three seconds.

5.1.1 Instruction Fields (flags, errors and warnings)

When bearing an emergency signal and additional functions are activated or operating parameters are out of their specified limits, the system will inform you by the means of instruction fields (flags):





Display	Meaning	See page
	Speaker audio output is currently muted	45
	Self bearing suppression (SBS) active	64
	An emergency signal has been detected. Source, signal frequency and time since detection will be displayed. The key Clr will deactivate the warning signal and the alarm relay output. After that, if receiving no more emergency signal for more than a minute, the alarm flag will be turned off automatically.	22
	The system will indicate a warning , if the operating parameters are close to the tolerable limits or if external signals are not available anymore. The system's basic functions are not affected yet, but preventive measures are recommended.	76
	An error message will be displayed, if one or more operating parameters are out of admitted limits or if a malfunction was recognized. In this case the system is not working. Key Clr deactivates the acoustic warning signal.	76

Fig. 8 Instruction fields

5.1.2 Alarm Function

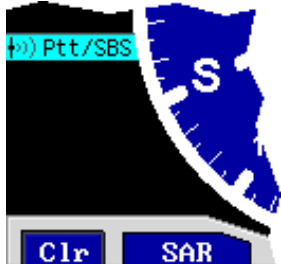
During signal reception (signal level above squelch level), the signal is analysed in the background if it's a modulated emergency signal. These emergency signals (ELT = Emergency Locator Transmitter, PLB, EPIRB) are modulated with a typical, repeating and distinct sweeping tone.

Once recognized as an emergency signal, alert will be activated. A flashing alarm flag indicates the signals frequency, it's type and duration since first reception.

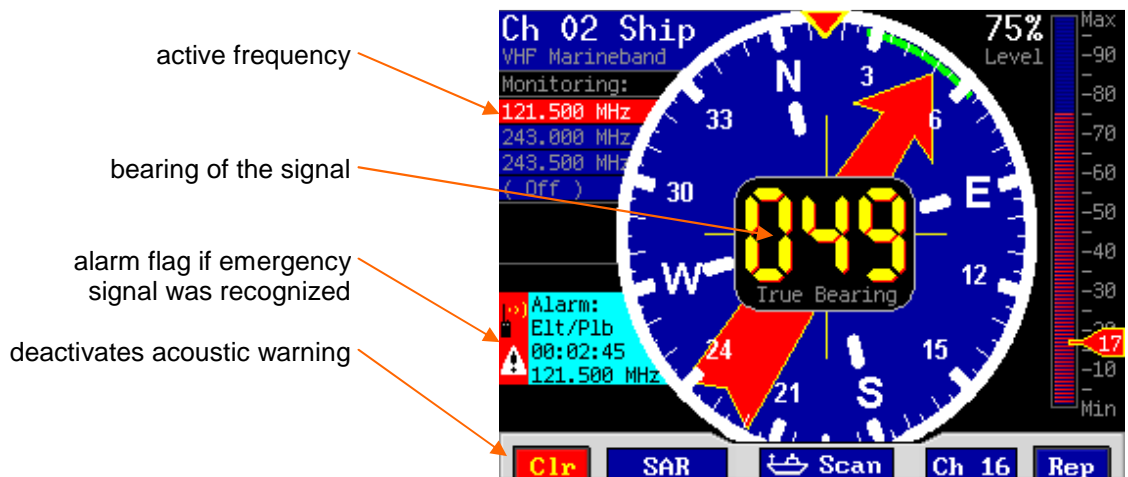

Fig. 9 Monitoring operation

At the same time a special internal warning tone informs you about the reception of the emergency signal. The alert will last (even after end of signal) until confirmation/deactivation by the flashing function key **Clr** (warning signal mute).

After that, if no emergency signal is received for more than one minute on the recognized scanning frequency, the alarm flag will be turned off automatically.

ATTENTION: The alarm relay output will be activated simultaneously when recognizing an emergency signal. Like the internal warning tone the relay output can be deactivated by pressing key **Clr**. The alarm relay output may be used for a warning bell or similar.

5.1.3 Function Repeat

The function **Repeat** will show once again the last valid bearing value. Pressing the function key F5 **Rep** will show the last bearing value with its corresponding digital signal level, flashing for 3 seconds.

(For mobile applications: With an external compass activated (true / magnetic bearing), a vessels change of heading will be considered automatically for the relative bearing.)

5.1.4 Function Clear

The function **Clr** clears the internal bearing value averaging buffer. The averaging buffer enhances bearing accuracy and delivers a useful bearing display even with bad received signals (e.g. distant transmitter, receiving gaps). The averaging procedure causes a contouring error, which might influence the bearing value, if changing heading too quickly (in

case of a vessel installation). In this case the indicated bearing value will be lagging a bit to the actual bearing value.

Pressing function key F1 **Clr** after a distinct change of heading, the corrected bearing value will be displayed immediately.

In connection with an alarm flag or an error message the key **Clr** deactivates warning tone and alarm relay output.

5.1.5 Function Channel 16

Pressing function key F4 **Ch 16** enables direct switching to maritime emergency channel 16.





NOTE: Please verify correct squelch adjustment of channel 16. For squelch adjustment see 6.3.

Pressing key F4 **Back** recalls the previous bearing frequency.

5.1.6 Function SAR

Pressing function key F2 **SAR** will show the SAR-Dialogue. This dialogue grants access to following frequencies and functions:

- All Cospas-Sarsat frequencies (separated in channels)
- Start of Cospas-Sarsat-Scanning-Mode (all Cospas-Sarsat-Frequencies are monitored)
- Cospas-Sarsat-Frequency found by last scan
- Decoding of Cospas-Sarsat messages
- 121.500 MHz (Emergency-Frequency)
- 121.650 MHz (typical Training-Frequency of PLB's)
- 243.000 MHz (Emergency Frequency)

In the dialogue you could navigate with the arrow keys    . By pressing **Ok** the selected frequency is selected as new main frequency.

In chapter 5.5 the SAR-Dialogue is described in detail.

5.1.7 Function Scan

By pressing the function key F3  **Scan** the scan dialogue is shown where the scan modes can be activated. The dialogue provides one scan mode to scan eight channels freely selectable of all bands and a second scan mode to scan all ship frequencies of the lower marine band in 5 kHz steps.

A detailed description of the scan dialogue can be found in chapter 5.4 on page 27.

5.2 Monitoring Operation

Activation and adjusting monitoring operation see 6.4.

The DF-system RT-800 is equipped with only one receiver, that means, only one frequency can be received at a time. Signals on other specified frequencies/channels cannot be beared at the same time. For simultaneous surveillance of the traditional emergency frequencies and any other frequencies/channels there is the function monitoring. Thus, the surveillance of up to four different frequencies (monitoring frequencies) within the specified frequency bands is possible.

When the monitoring function is activated the DF-system switches alternating from the main bearing frequency to the selected surveilling scanning frequencies. The actual frequency is displayed highlighted in white colour.

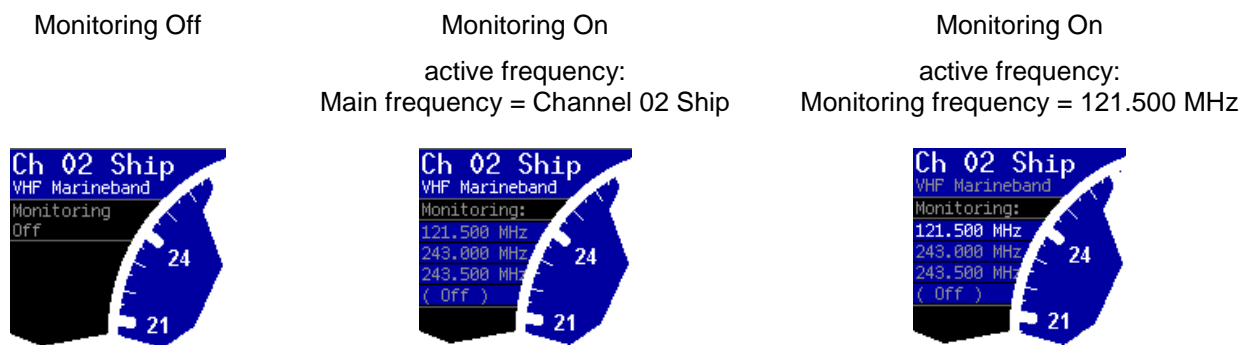

Fig. 10 Example active monitoring frequency

If a signal is received during monitoring, the reading of the corresponding frequency is red colored and the bearing value is indicated. Even after the end of the signal this frequency/channel will be held for 10 sec (Hold-Time).

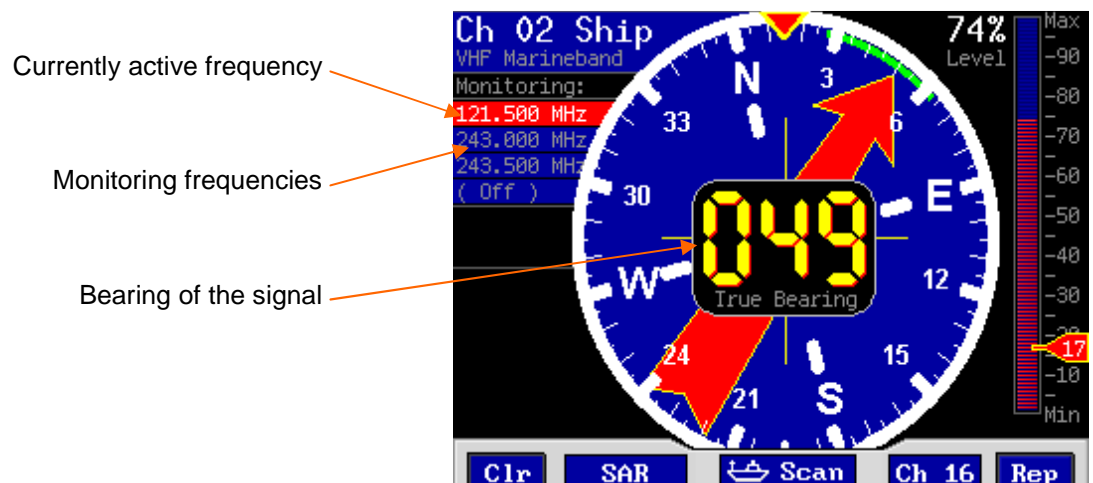

Fig. 11 Monitoring operation

In order to interrupt the actual reception press key **Esc** (the system is continuing with next monitoring frequency).

Active reception will be interrupted after 30 sec for a short moment in order to examine the other monitoring frequencies (safety function). If this feature is not desired, press key **Ok**. The active receiving frequency will be overtaken as the main frequency. Thus, interruptions are shortened considerably, for the main frequency is monitored now with highest priority (see also 5.2.1).

5.2.1 Timing of normal Monitoring Operation

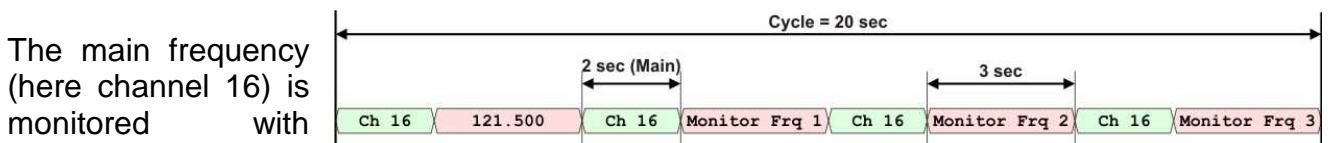

Fig. 12 Example: Timing normal monitoring

5.2.2 Timing Monitoring with selected Cospas-Sarsat Main Frequency

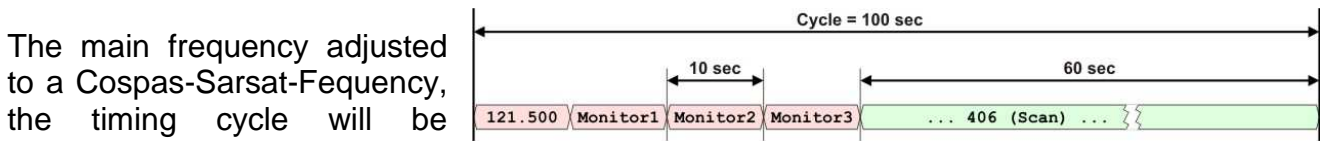

Fig. 13 Example: Timing Cospas-Sarsat

5.2.3 Monitoring operation with filtering of Emergency Transmitters: ID-Only

In order to activate the emergency transmitter filtering function see 6.4.

Signals transmitted by emergency transmitters (PLB/ELT/EPIRB) are modulated with a typical sweeping tone. When surveilling, in order to exclude false alarms caused by disturbing signals or by nonauthorized radio communication, the function "emergency transmitter filtering ID-Only" may be called up. Once activated, all radio signals without the prescribed sweeping tone for emergency transmitters will be suppressed. Alert will be triggered, if a modulated emergency signal is recognized.

WARNING: For very weak signals recognition of modulation may take a certain time. Releasing an alarm can be delayed in this case.

5.3 Standby-Operation

Activating standby operation see 6.5.

During standby operation the DF-system monitors the corresponding emergency frequency, the display is dimmed and the audio output is switched off.

Once an emergency signal is detected on these frequencies, the system will release alarm and the display is illuminated. In order to avoid false alarms caused by other signals, the surveillance is coupled automatically with the emergency transmitter filtering function ID-Only.

In order to end standby operation, press any key.

If an internal system error is recognized, the standby operation will be finished as well.

NOTE: The standby operation is not available, if there's an error flag or an active alert (emergency transmitter).

5.3.1 Standby Mode SAR

During this standby operation the DF-system is surveilling the traditional emergency frequency 121.500 MHz and all Cospas-Sarsat frequencies.

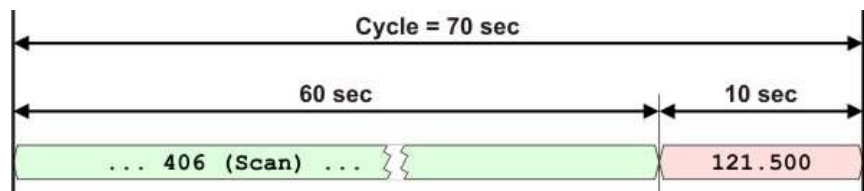

Fig. 14 Example: Timing Standby Mode: SAR

These frequencies are preset in the system.

5.3.2 Standby Mode PLB

During this standby operation the DF-system is surveilling exclusively the emergency frequency 121.500 MHz. This frequency is preset in the system.

Because there is no scanning necessary, this mode reacts very fast if a distress signal (from ELT/PLB/EPIRB) on 121.500 MHz is activated.

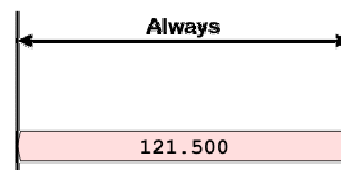

Fig. 15 Example: Timing Standby Mode: PLB

5.4 Scan-Dialogue

The Scan-Dialogue provides the activation of two different scan modes. In the first mode it is possible to scan eight freely selectable channels of all bands which are scanned in less than two seconds (Fast Channel Scan). In this mode a “BeepTone” filter could be activated which issues an alarm if a distinct tone frequency is recognized and ignores all other signals. The second mode provides a quick scanning of the lower marine band in approximately three seconds (Fast Marine Scan).

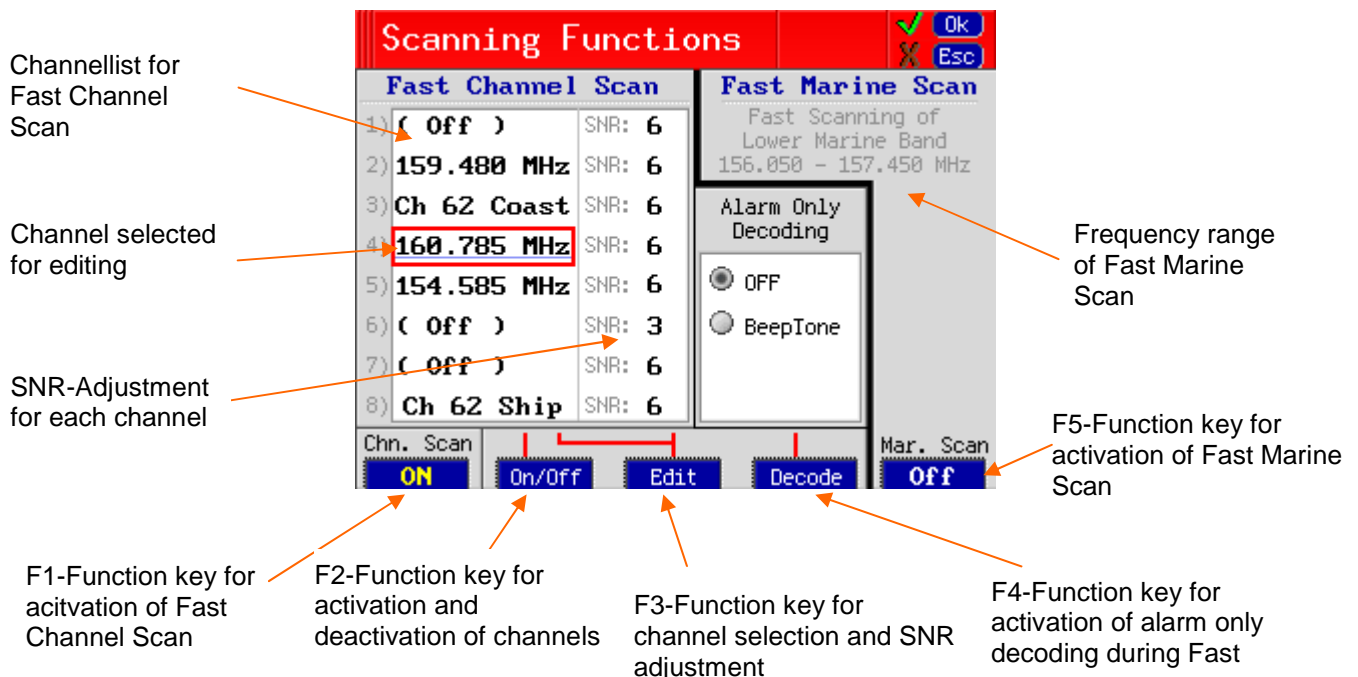





Fig. 16 Scan-Dialogue

5.4.1 Fast Channel Scan

The Fast Channel Scan enables the scanning of eight freely selectable frequencies across all supported bands in a very fast manner. The scan process lasts less than two seconds. All channels are scanned continuously.

If not all channels are enabled, the duration of one scanning cycle is reduced accordingly (e.g. if only four channels are enabled, the duration of one scanning cycle is approximately one second).

Navigation in the dialogue is possible using the arrow keys    .

The currently selected item (channel or SNR-value) is surrounded by a red rectangle. To choose a channel, select the respective channel and press the key „F3“ **Edit**. The frequency dialogue is shown to enter the new frequency or channel.

In Fast Channel Scan mode the Autosquelch is enabled automatically. The value of the Autosquelch can be adjusted slightly by the user. The SNR value indicates the count of level points above the noise level to which the Autosquelch is set to. For example, if the noise level is at 27% on a specific channel and the SNR-Value is adjusted to 7, then the Autosquelch level is set to 34%.

Because the channels may be set to frequencies of different bands with different noise levels, the SNR-Value can be adjusted for every channel separately.

To activate the Fast Channel Scan press the key „F1“ **Off**. The label of the soft key changes to **ON** and shows that the Fast Channel Scan was activated. If the Fast *Marine* Scan was already activated, it is deactivated because only one scan mode could be active at a time.

By pressing **Ok** all changes in the channel list are stored and the respective scan mode is activated or stopped.

„Alarm Only Decoding“ / „BeepTone“

If the scan mode Fast Channel Scan was invoked, an additional filter for the decoding of audio signals could be activated by pressing the key „F4“ **Decode**. The Fast Channel Scan then reacts only to signals with a distinct (preconfigured) audio frequency and issues an alarm immediately if such a signal was recognized.

This can be used to search e.g. NOVATECH Radio Beacons which transmit a two second signal with 800Hz audio tone every six seconds.

The parameters of the audio signal (upper and lower audio frequency as well as minimum required duration of the signal) can be configured in the System Menu (see chapter 7.3.9).

If a signal was found during Fast Channel Scan with activated BeepTone-Decoding, the scan process is stopped and the signal analysed. Only if a valid audio signal (BeepTone) is decoded, an alarm signal is started. If the signal stops or no valid audio signal was decoded the scanning procedure starts over again after five seconds.

NOTE: Alarm is always started if a signal with an ELT-Modulation was recognised!

5.4.2 Fast Marine Scan

By pressing the function key „F5“ **Off** a fast scan mode for the lower marine band is activated. The label of the key changes to **ON** and indicates that the Fast Marine Scan is to be started.

If the Fast Channel Scan was already activated, it is deactivated because only one scan mode could be active at a time.

The frequency range of Fast Marine Scan is fixed from 156.050 MHz (Channel 01) to 157.425 MHz (Channel 88) and is scanned with 5 kHz frequency step without gap. The duration of one scanning cycle is approx. 3 seconds. The small frequency spacing of 5 kHz is used to detect stations which use frequencies between two maritime channels!

General Information on Fast-Channel-Scan and Fast-Marine-Scan:



If a signal is found during the scan (signal-level above squelch-level) the scan is interrupted and the bearing of the signal is started as long as the signal is present. At Fast Channel Scan one second after the signal was lost, the scanning process starts again at the next frequency / channel. At Fast Marine Scan the scanning process starts after ten seconds. If the key **Ok** is pressed during this time, the scanning mode is deactivated and the current frequency is the new main frequency.

In case that an unwanted signal is found, the scanning process can be proceeded immediately by pressing the **Esc** button!

If an interesting signal is found and the direction finder should bear this frequency permanently, the scanning process can be cancelled in the Scan-Dialogue by deactivating the scan mode.

ATTENTION:

- In case that Monitoring is active before starting the scan, Monitoring is interrupted while the scan is active!
- If a scan mode is not supported by the connected AU, the respective scan mode can not be selected in the dialog.
- If a signal was found during scanning process which lasts longer than 30 seconds, the scan process is continued after 30 seconds with the next channel/frequency. This is done to ensure that other signals are found as well.

NOTE: If there are interferences on the frequency band which are above the squelch level, scanning stops as well at these interferences (they are interpreted as signals). This may be avoided by adjusting the squelch level manually using the  and  buttons in Fast Marine Scan mode or adjusting the SNR value in Fast Channel Scan mode. Because of this, it may be possible that weak signals are not received any more (for correct squelch adjustment read also chapter 6.3 on page 37)!

5.5 SAR-Dialogue

The SAR-Dialogue allows direct access to several emergency frequencies as well as the possibility to scan all Cospas-Sarsat frequencies. Furthermore you can start the decoding of Cospas-Sarsat signals.

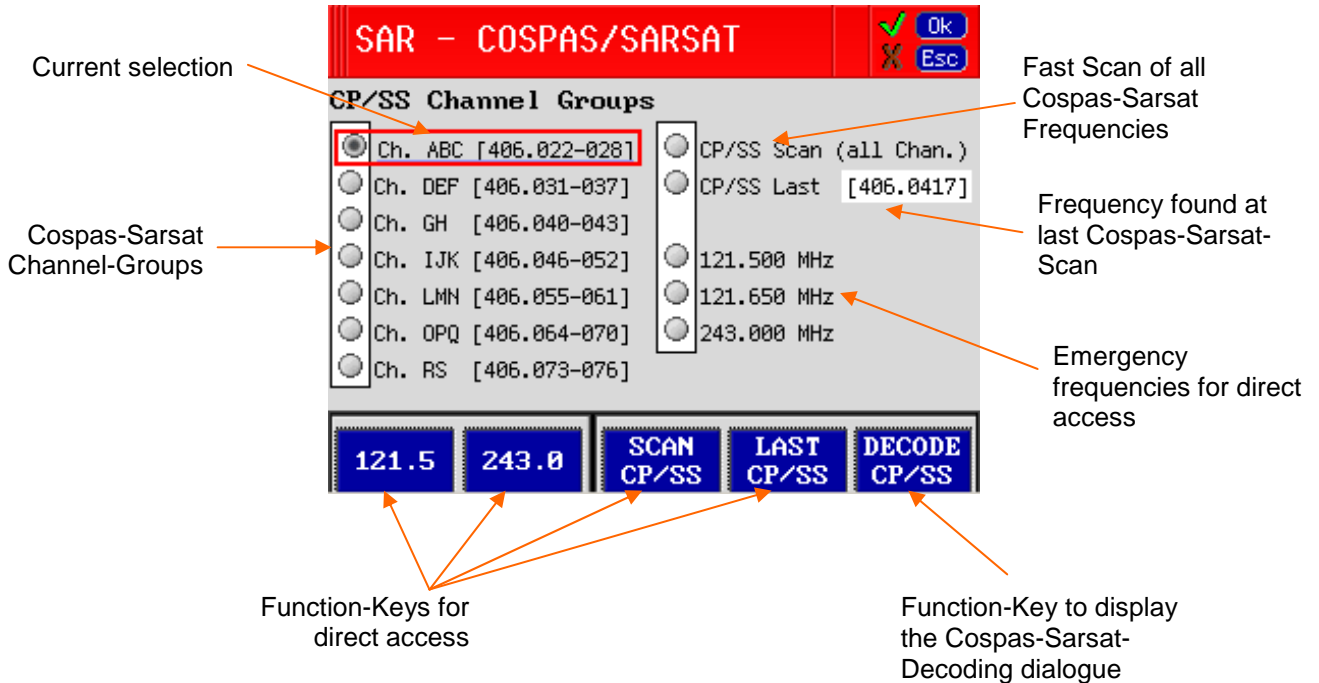

Fig. 17 SAR-Dialogue

If one of the dialogue's frequencies is already selected as main frequency, it is marked at dialogue startup.

While the dialogue is active, the selection can be made with the arrow keys .

If the **Ok** key is pressed, the selected frequency becomes the new main frequency and the dialogue is closed.

Function **Scan CP/SS**:

By selecting this function a fast Scan-Mode is started. It scans all Cospas-Sarsat channels for signals. The Scan-Mode is displayed in the main window:



Fig. 18 Display of Cospas-Sarsat Scanning-Mode

Function **DECODE CP/SS**:

By pressing the function key F5 **DECODE CP/SS** the decoding dialogue for Cospas-Sarsat signals is shown. The selected Cospas-Sarsat frequency is transferred to the Decoding-Dialogue.

A detailed description of the Decoding-Dialogue is in chapter 5.6.

5.6 Cospas-Sarsat Decoding Data Content

In order to receive a Cospas-Sarsat data pulse and to decode its content, the main frequency has to be adjusted to a Cospas-Sarsat frequency first. This can be achieved manually or, faster, by selecting the frequency directly in the SAR-Dialogue.

For decoding, you have to press function key F2 **SAR** in the main screen, choose the frequency and then press F5 **DECODE CP/SS** to start the decoding of Cospas-Sarsat signals.

In this mode the bearing operation and also the monitoring function will be interrupted. In order not to suppress other emergency signals, the selected decoding mode is limited to 75 sec (visible on progress bar). After that, the system is returning to the previous operating mode. (For special purposes this time could be changed by the menu item Menu/System/CPSSDIgTim)

A Cospas-Sarsat pulse will be broadcasted every 50 sec (± 5 sec). While the waiting period a pulse will be received if the transmitter is not out of range.

Once received a valid pulse, the function key F1 **Confirm** starts flashing and an acoustic warning tone is put out. By pressing key F1 the acoustic signal is muted.

The last received Cospas-Sarsat message can be displayed again by pressing function key F4 **Recall**.

The data content of a received Cospas-Sarsat message can be stored to an internal memory with the function key **Save**, and displayed again with function key **Restore**.

During the decoding of Cospas-Sarsat signal the squelch level could not be adjusted because the Auto-Squelch is activated automatically!

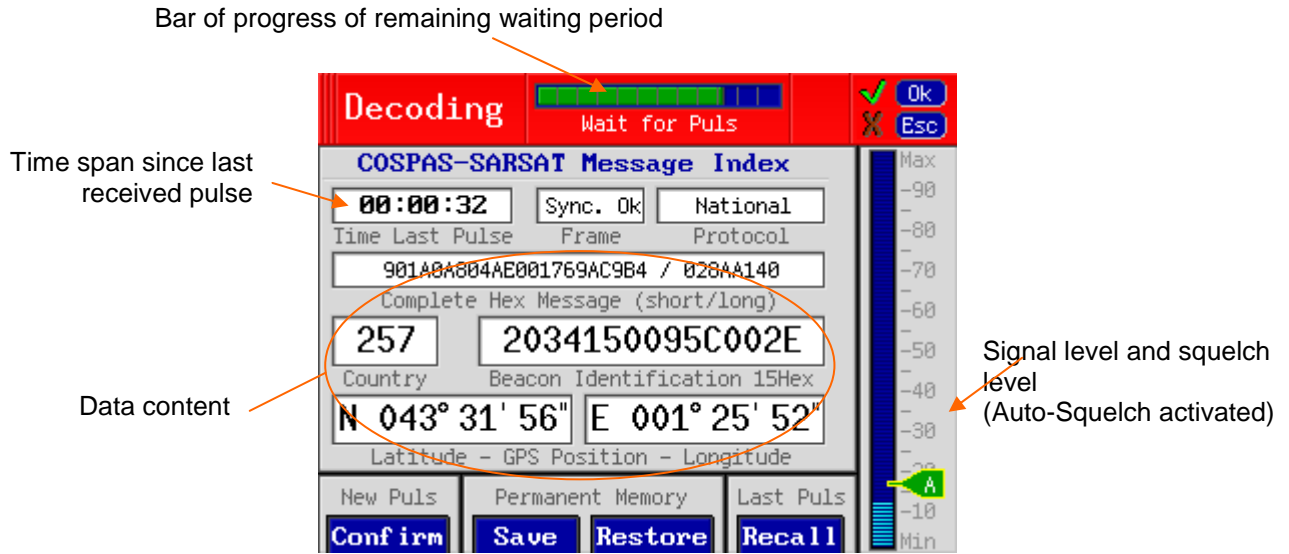

Fig. 19 Cospas-Sarsat data decoding

Data Content:

- **Frame**
Sync. Ok (normal Cospas-Sarsat Signal) or SelfTest (Cospas-Sarsat Signal in self test mode). The 24 synchronizing bits have been received correctly.
- **Protocol**
Used protocol: User (Test), Standard (Test) or National (Test)
- **Complete Hex Message**
Complete data signal, coded in hexadecimal notation (Bit 25 to 112) and, if available (Bit 113 to 144)
- **Country**
country identification (numeric code)
- **Beacon Identification 15 Hex / MMSI Identification**
Transmitter identification of a registered transmitter (Fifteen Hexadecimal Character Beacon Identification), if signal contains a MMSI-ID, it is displayed here.
- **GPS Position**
GPS-Position (latitude and longitude) if contained in data signal of transmitter. Precision depending on protocol, between 15 min of arc and 4 sec of arc.

6 Operating and Adjusting

Common operating functions of the RT-800 are done with help of the keys placed around the display.

In normal bearing mode the functions will be called up directly by the keys, opening the corresponding dialogue window.



Fig. 20 Operating and adjusting

Rarely used adjustments or adjustments which are only done once during installation, will be done in the menu-setup (see chapter 7).

Parameter setting is done generally by using the arrow keys, the number keys or the software controlled function keys F1 to F5.

New, changed parameters will be accepted with key **Ok** and be stored permanently in the system for further operation (even after switching off and on of the device).

Key **Esc** will close the dialogue window without storing the changed parameters.

If no adjustments are made in an opened dialogue window for more than 10 minutes, the system will close the window automatically and return into the bearing display mode.

While adjusting the bearing operation is still running in the background. If receiving an alarm signal, a warning tone will sound and the last bearing value can be called up with function **Repeat**.

6.1 Reset of the DCU

Press key  in order to restart the DCU (The system stores the last settings.).

Key illumination and the green operating light are activated. The display is still dark and the system is booting the operating software. The starting page shows up, serial numbers and software version of the DF-system are displayed.

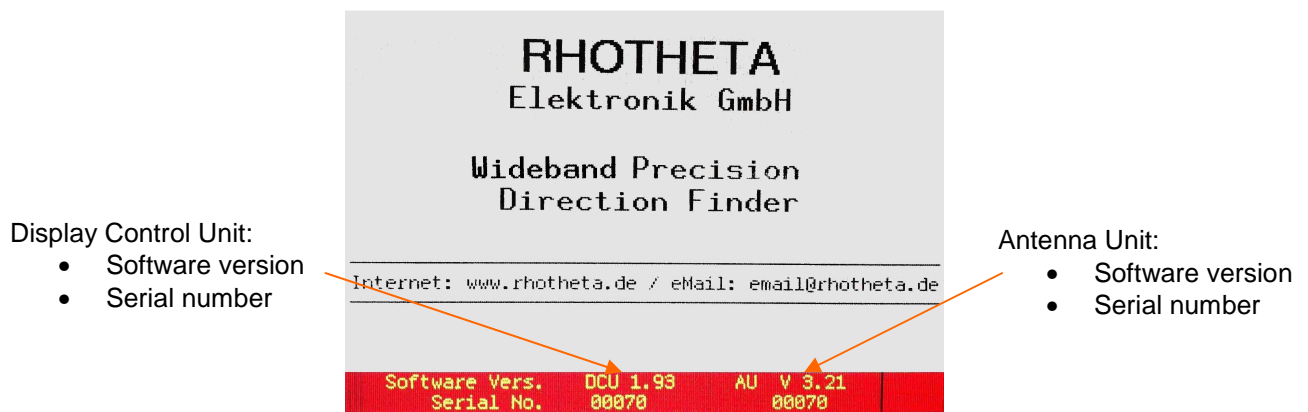

Fig. 21 Switch-on system information

After a period of 10 sec the bearing display will appear. The system is working with the previously selected adjustments.

6.2 Setting Main Bearing Frequency/Channel

Selection of the main bearing frequency in the VHF and UHF air band and the Cospas-Sarsat band is usually done by direct input of the desired frequency. In the maritime radio band the input of the channel number (with related frequency) is usual. Both types of input are to your disposal. The system will accept only inputs within the permitted frequency ranges.

6.2.1 Adjusting Main Bearing Frequency

Frequency step width depends on the selected frequency band. The last digits will be rounded by the system.

- Open dialogue window, using key **Channel / Freq.**
- Select with F1 or F2 **Frequency**.
The frequency input field is activated. Additionally the display shows a list of the permissible frequency ranges.

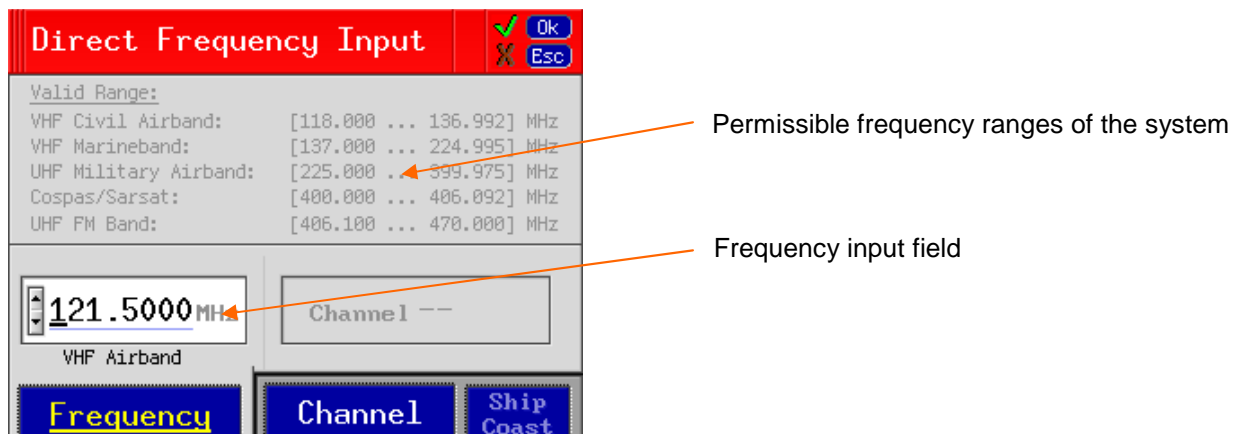

Fig. 22 Input of main bearing frequency

- Put in desired frequency by the means of the keyboard or directly using the arrow keys:
 - ↑ increases frequency by 5 kHz / 8,33 kHz / 25 kHz
 - ↓ decreases frequency by 5 kHz / 8,33 kHz / 25 kHz
 - ← moves cursor to the left for one digit in order to overwrite previous input
- Store adjustment using key **Ok**.
Device returns into bearing mode, working with adjusted frequency.

6.2.2 Setting a Main Operating Channel

56 Channels are available in the VHF marine band. (Channel 0 to 28 and channel 60 to 88).

- Open dialogue window using key **Channel / Freq.**
- Select with F3 or F4 **Channel**.
The channel input field is activated. Additionally the display shows a list of all permissible channels.

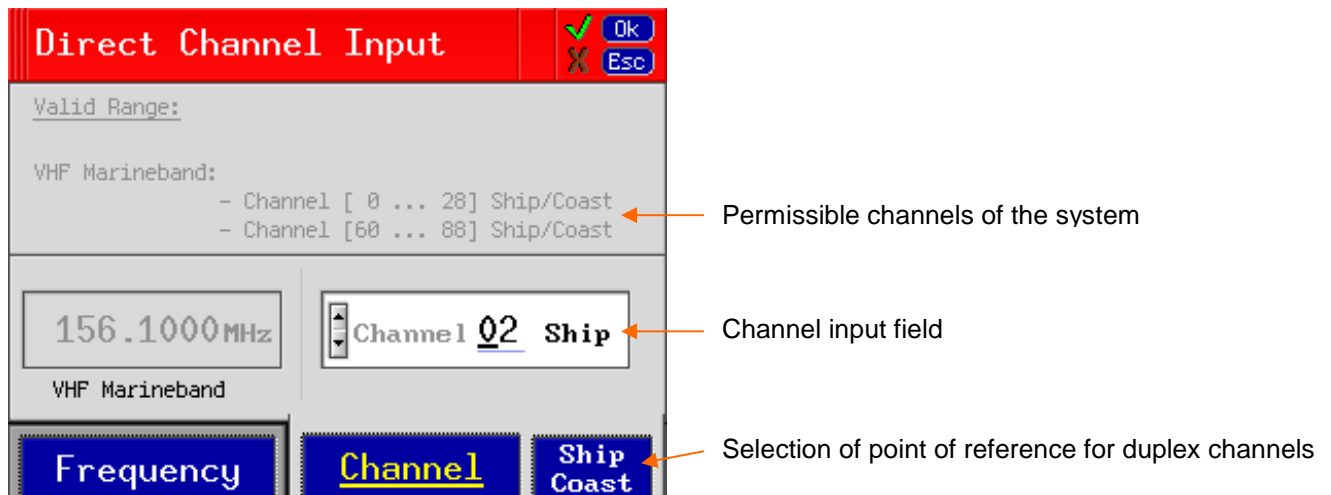

Fig. 23 Input of a main bearing channel

- Put in desired channel directly by the means of the keyboard or by using the arrow keys:
 - ↑ Increases channel for one step
 - ↓ Decreases channel for one step
 - ← Moves cursor to the left for one digit in order to overwrite previous input
- If a duplex channel is to be adjusted, the point of reference **Ship** for the maritime radio station (lower band) or **Coast** for the coastal radio station (upper band) can be selected by pressing key F5.
- Store the input using key **Ok**.
The device returns into bearing mode and is operating on the selected channel.

6.3 Adjusting the Squelch

Our surrounding atmosphere contains always a certain electric field strength, designated as "noise". The received noise voltage is varying with frequency and location of the receiver. Signals can only be interpreted reasonably, if their level is above the surrounding noise level.

The squelch electronics make it possible to adjust a threshold, below which incoming signals will not be processed. The DF-system will work only, if there is an incoming signal with a level above the squelch level. If the signal level is below the squelch level, reception will be switched off.

6.3.1 Hints for Squelch Level Adjustment

- The squelch level of the corresponding frequency/channel is to be adjusted only when receiving no bearing signal.
- The squelch level is to be adjusted as close as possible above the noise level. If the squelch level is adjusted too low, it is within the noise level and the DF-system is affected in its whole performance. If the squelch level is adjusted too high, very weak bearing signals will be suppressed by the squelch function:

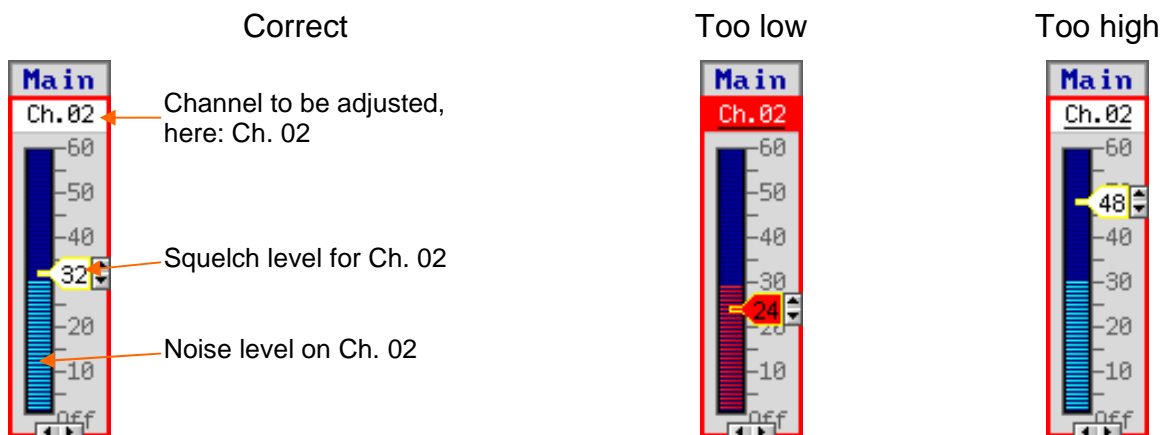

Fig. 24 Adjustment squelch level

- Industrial areas (e.g. near harbours) may be featuring higher noise levels than offshore areas. Therefore it is important, to verify regularly the adjustment of the squelch level of all active frequencies (main frequency, emergency frequencies and monitoring frequencies) and, if necessary, to readjust in order to achieve full sensitivity of the DF-system.
- When bearing emergency transmitters with very weak signals, it may be useful to deactivate the squelch function on the corresponding frequency (see **Off** in the squelch dialogue) in order to take full advantage of the DF-systems sensitivity. In this case check permanently if bearing the transmitter and not bearing disturbing signals. When verifying, a change of heading should cause a change of the bearing value.

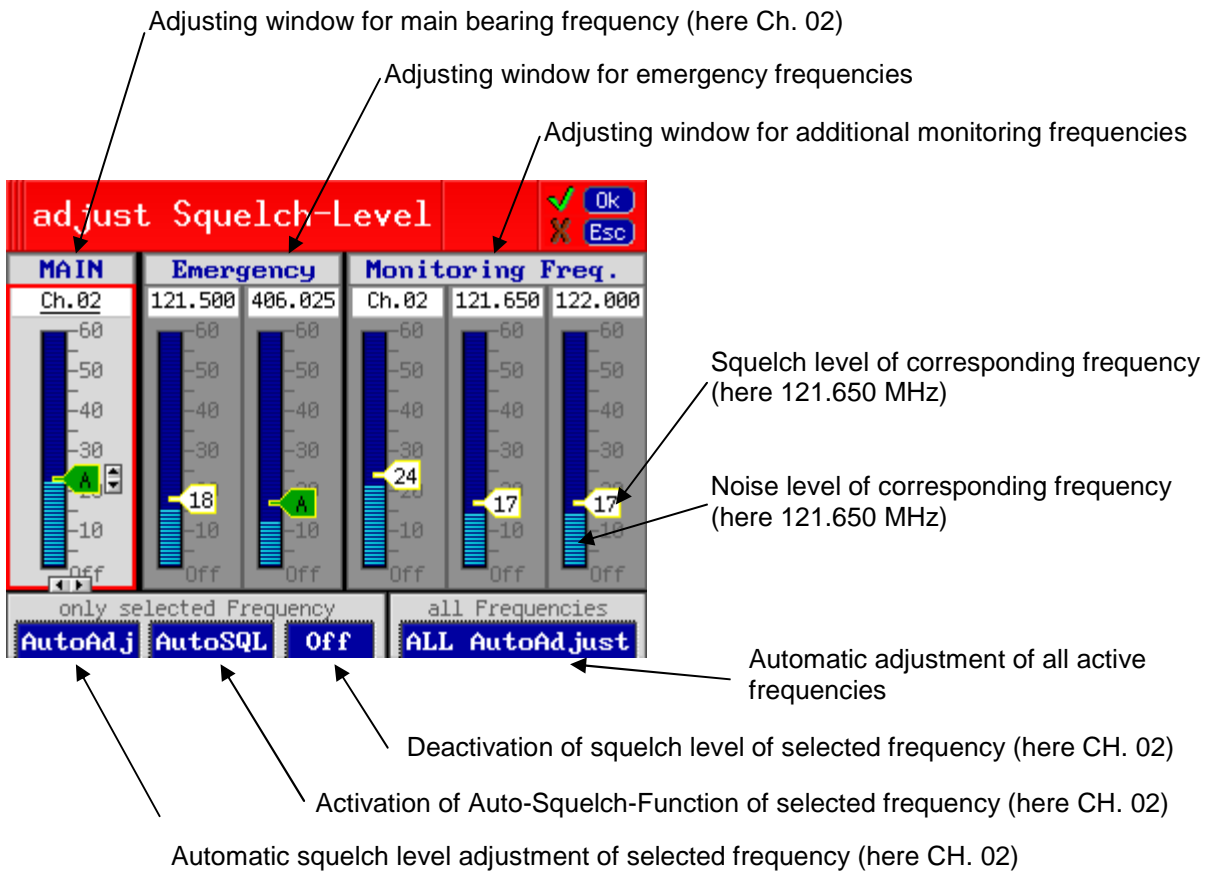

Fig. 25 Dialogue window: Squelch level adjustment





6.3.2 Manual Adjusting of Squelch Levels

Please notice hints described in chapter 6.3.1 when adjusting the squelch level.

The squelch levels of the adjusted surveilling frequencies (main frequency, emergency frequencies, monitoring frequencies) are to be adjusted individually:

The system is scanning the displayed frequencies in the background and is showing on the display their noise levels as well as their squelch levels. Scanning and displaying of the corresponding frequencies takes a certain time. As soon as signal level and frequency are appearing on the screen, the squelch level for this frequency can be adjusted.

- Open dialogue window using key **Squelch**
When opening the dialogue window the system is scanning the signal levels of the surveilling frequencies/channels and is showing the presently received signal levels and the previously selected squelch levels on the screen of the display.

As soon as the noise level of a frequency is getting visible on the display, the squelch level of this frequency may be adjusted.
- Select frequency/channel to be adjusted using arrow keys  
The selected frequency/channel is displayed now brighter and framed red.
- Change squelch level of selected frequency:
 -  Increases squelch level
 -  Decreases squelch level
 - F1 **Auto Adjust** Adapts automatically squelch level to noise level once
 - F2 **AutoSQL** Activates the Auto-Squelch-Function (not available at monitoring frequencies 121.500 and 243.000 MHz)
 - F3 **Off** Switches off squelch level of selected frequency
- Store adjustment using key **Ok** and return to bearing display.

6.3.3 Automatic Adjustment of Squelch Levels

Please notice hints described in previous chapter when adjusting squelch level (see 6.3.1).

- Open dialogue window using key **Squelch**
When opening dialogue window the system is scanning the signal levels of the selected surveilling frequencies / channels and is showing the presently received signal levels and the previously selected squelch levels on the display screen.
- Function keys F4 or F5 **All AutoAdjust** are now activating the automatic squelch level adjustment of all active frequencies.
The squelch levels are now being optimized automatically for all active frequencies (main bearing frequency, emergency frequencies, monitoring frequencies). A manual readjustment might be necessary (see 6.3.2).
- Store adjustment using key **Ok** and return to bearing display.



6.3.4 Automatic Squelch

For bearing very short signals the correct adjustment of the squelch level is very important. Because noise level varies by time and location, the squelch level must be adjusted continuously.

The Auto-Squelch function ensures that the squelch level is always adjusted to a value a little bit above the noise level. If noise level is rising, the squelch level is rising also. As soon as the noise level drops the squelch level is adjusted accordingly.

WARNING: Because the DF-system can not determine between noise and continuous signals, the Auto-Squelch will rise the squelch level slowly until the squelch level is above the signal level. The result is that the signal is lost.

So, if you are bearing continuous signals, you have to deactivate the Auto-Squelch!

This is done by changing the squelch level using the Up/Down Keys   at the main window or at the squelch dialogue. The squelch marker then changes its appearance and displays the current squelch value.

Activation:

To activate the Auto-Squelch press the function key F2 **AutoSQL** in the squelch dialogue having selected the desired frequency.

In frequency bands with short signals (eg. Cospas-Sarsat-Band) the Auto-Squelch is activated automatically.

If the Auto-Squelch is activated the squelch marker turns into green and instead of the squelch level an **A** is displayed.

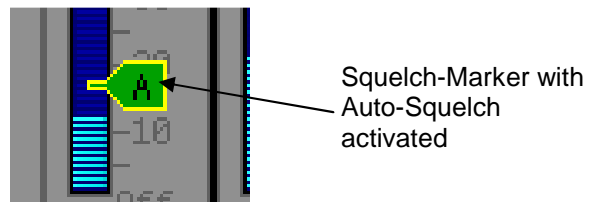

Fig. 26 Auto-Squelch Marker

NOTE:

- During Cospas-Sarsat-Scanning the Auto-Squelch function can not be deactivated!
- The Auto-Squelch function can not be activated for the emergency frequencies of the monitoring mode because these signals are mostly continuous signals!

6.4 Adjusting Monitoring Operation and ID-only Filtering

For monitoring operation the emergency frequency 121.500 MHz is stored permanently in the system. For additional surveillance three more frequencies/channels can be stored in the specified frequency ranges. Each monitoring frequency can be combined with the selective emergency transmitter filtering function ID-only (selective squelch).

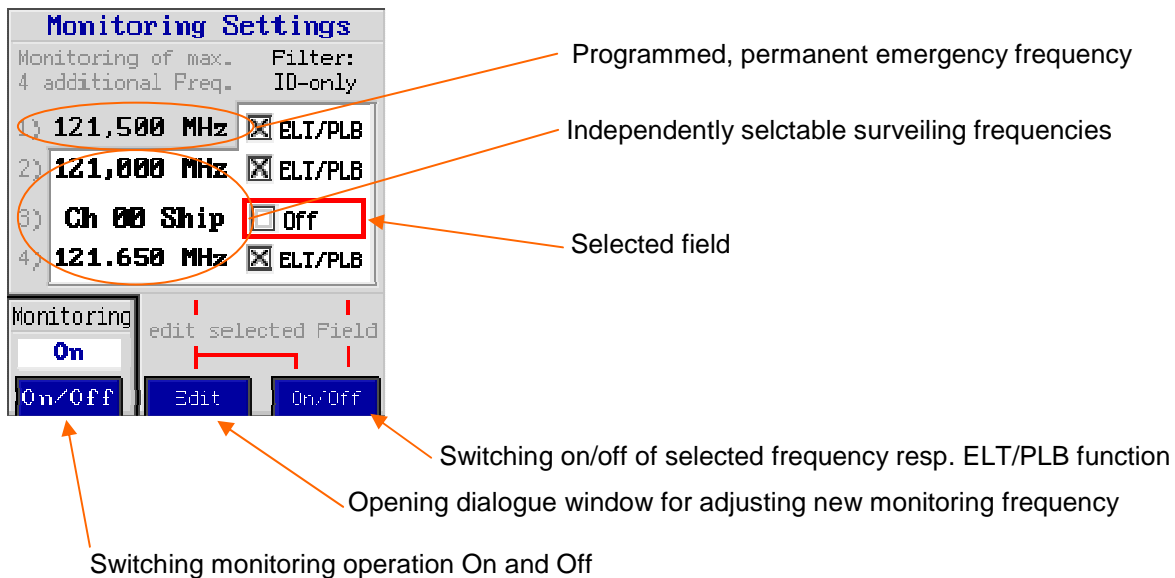
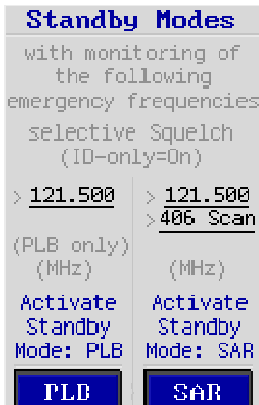

Fig. 27 Dialogue window Monitoring settings

- Open dialogue window, using key **Monitor / Stdb.**
- Select frequency field or selecting field for emergency transmitter filtering (ID-only / selective squelch) by using keys **↑ ↓ ← →** .
The selected field is displayed with a red frame.
- Change monitoring parameter with following functions:
 - F1 **On/Off** Switching ON monitoring operation
Monitoring operation is indicated by illumination of the monitoring LED. At the same time the selected monitoring frequencies are displayed on the left side of the bearing display.
Switching OFF monitoring operation
Top left the monitoring display is displaying "Monitoring Off".
If the monitoring operation shall stay active permanently, switching off by mistake can be avoided (see 7.3.6).
 - F2 **Edit** Opening dialogue window for setting new monitoring frequency/channel (Setting new Frequency/Channel see 6.2).
 - F3 **On/Off** Switching on/off selected monitoring frequency and emergency transmitter filtering ELT/PLB.
- Confirm selection using key **Ok** and return to bearing mode.

ATTENTION: Please verify correctly adjusted squelch level for set monitoring (see 6.3), for possible noise signals might release alert, thus delaying further monitoring operation.

6.5 Activating Standby Operation



- Open dialogue window using key **Monitor / Stdby.**
- Key F4 **PLB** will activate PLB standby operation
The display gets dark and the emergency frequency 121.500 MHz is further on controlled in the background.
The standby operation is indicated by the fast flashing monitoring LED. Additionally, the ID-only ON/OFF LED is blinking.
Because there is no scanning necessary, this mode is useful for a fast reaction for PLB/ELT alarms transmitting on 121.500 MHz.
- Key F5 **SAR** will activate SAR standby operation.
The display gets dark and the emergency frequency 121.500 MHz and Cospas-Sarsat frequencies are further on controlled in the background.
The standby operation is indicated by the monitoring LED. This LED slowly flashes 3 times with a short break afterwards. Additionally, the ID-only ON/OFF LED is blinking.

Fig. 28 Activation of Standby operation

Deactivating Standby operation

- Press any key for re-activating the display.
- If an alarm is recognized during standby operation, the system will activate the display automatically. The alarm flag will indicate frequency and duration since release of alarm.
- If an operating error is recognized during standby operation, the display will be activated. An error message will be put out.

6.6 Setting Brightness (Dimming)

The brightness of the display elements and key illumination may be adapted to surrounding lighting conditions (TFT-displays, LEDs).

An integrated photometer is monitoring surrounding brightness and adapts automatically illumination of display and operating elements to lighting conditions (= Automatic-Mode).

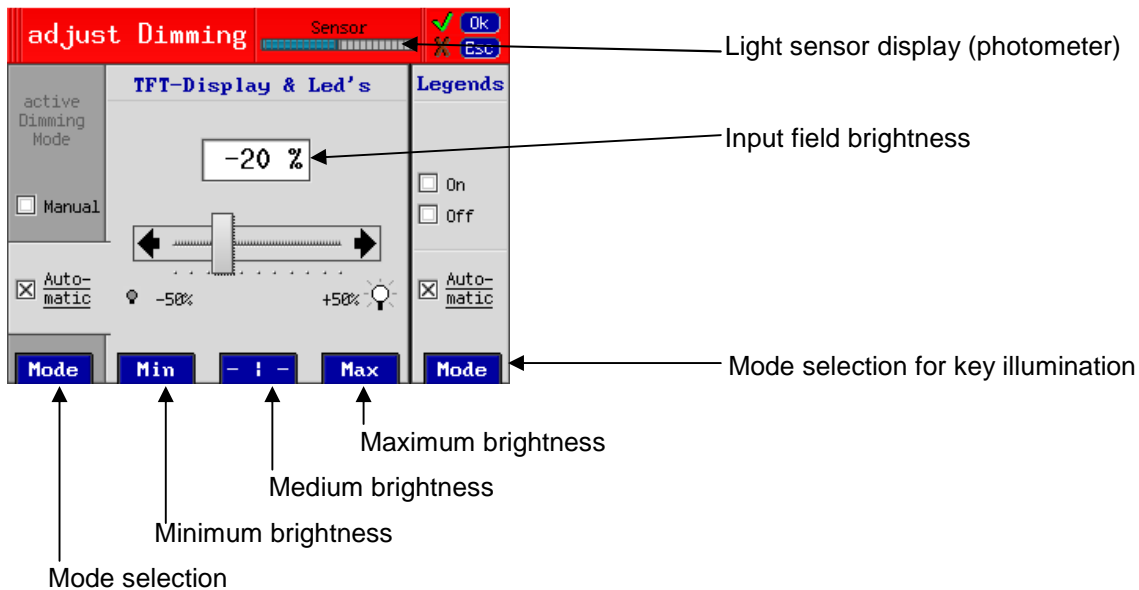

Fig. 29 Dialogue window Dimming

In order to enhance lifetime of the luminous foils and the TFT display we recommend to run the DF-system in its basic setting Automatic Mode (see chapter. 6.6.1).

In case of insufficient automatically set illumination of the display elements (e.g. more dimming desired during night operation), the illumination setting may be adjusted manually (see chapter 6.6.2). The photometer is deactivated.

NOTE: In order to avoid complete darkening of the display, the brightness setting is limited to a minimum value of 10%.

6.6.1 Automatic Adjustment of Brightness of Display and LEDs

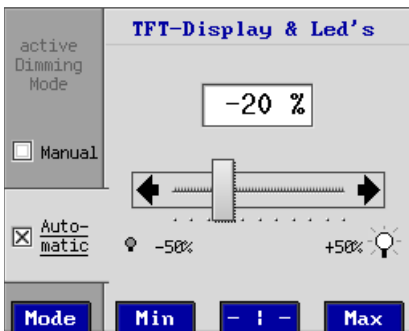

Fig. 30 Automatic dimming

- Open dialogue window using key **Dimming**.
- Press left key **Mode** and select option Automatic.
- If necessary, readjust automatically set brightness using keys **←** **→** and function keys F2, F3 and F4.
- Store setting using key **Ok**.

6.6.2 Manual Adjustment of Display and LED Brightness

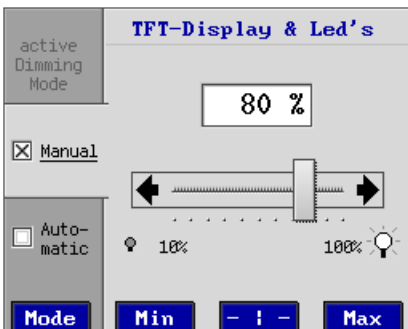
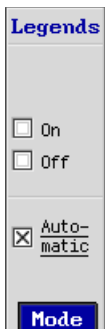

Fig. 31 Manual dimming

- Open dialogue window using key **Dimming**.
- Press left key **Mode** and select option Manual.
- Set brightness using arrow keys **←** **→**.
- Store setting using key **Ok**.

6.6.3 Adjustment of Key Illumination (legends)

Note: In order to enhance lifetime of the luminous foils and the TFT display we recommend to operate the key illumination in mode Automatic.



- Open dialogue window using key **Dimming**.
- Select mode of key illumination by multiple pressing of the key **Mode** :
 - On Permanent key illumination
 - Off Key illumination off
 - Automatic Key illumination corresponding to surrounding lighting
- Store setting using key **Ok**.

6.7 Setting the Volume (Volume)

With this dialogue the volume of the speaker is controlled. The muting function (Mute) will switch off the speaker. An additional testing routine can test the speaker's function.

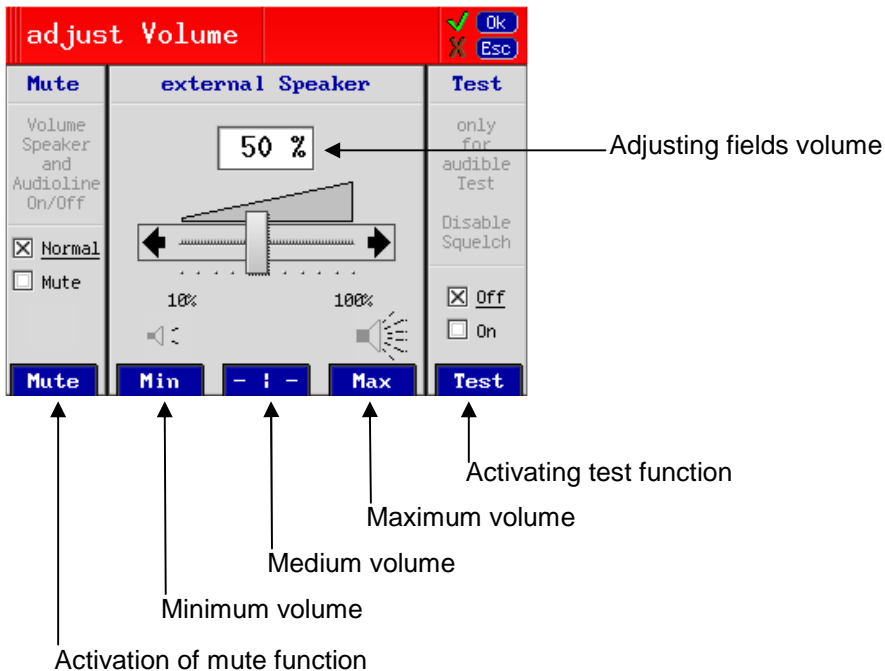
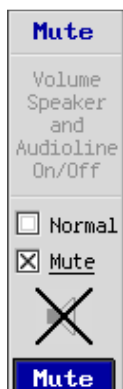

Fig. 32 Dialogue window Volume

6.7.1 Muting the Speaker (Mute)

An emergency signal received, the speaker will give a permanent alarm signal. This signal or the received radiotelephony can be muted, if disturbing.

NOTE: The period of the muting function is limited to a certain time if the setting "Monitoring / Off Blocked" is active in the system menu (see chapter 7.3.6). After that span the acoustic signal is switched on again automatically.



- Open dialog window using key **Volume**.
- Press F1 **Mute** and activate muting function of the speaker.
- Store setting using key **Ok** and return to bearing display.

The speaker switched mute, the bearing display will show the flag "Mute" as a reminder. The basic setting of the DF-system is the option Normal.

Fig. 33 Muting the speaker

6.7.2 Setting Speaker Volume

The volume of the speaker can be set infinitely variable. In order to avoid switching off the speaker by mistake, the minimum volume is limited to a value of 10%.

NOTE: In order to observe acoustically the setting of the speakers volume when receiving no signal, we recommend to activate the functional test of the speaker at first (see chapter 6.7.3) and to use the received noise signal as a setting reference.

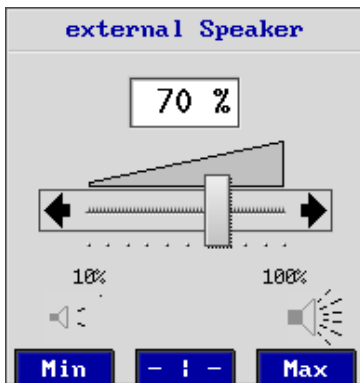

- Open dialogue window using key **Volume**.
- Set volume using arrow keys **←** **→**.

Quick change of volume can be achieved by function keys F2 (Min), F3 (-|-) and F4 (Max).

The volume is set to 10% (low), 50% (medium) and 100% (maximum volume).

- Key **Ok** will store the setting.

Fig. 34 Speaker volume

6.7.3 Functional Test of Speaker

In order test volume setting and function of the speaker, the test function can be activated. When activating the test function the squelch is deactivated and the received noise signal becomes audible.

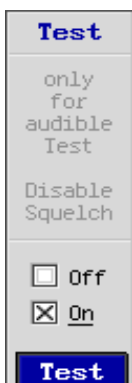

- Open dialogue window by using key **Volume**.
- Activate test function using key **Test**
→ **On**
The noise signal can now be heard if the speaker is working.
- In order to switch off the test function again, use key **Test** and select option → **Off**
- Close dialogue window using key **Ok** and return to the bearing display.

Fig. 35 Speaker functional test

6.8 Activating Memory / Band function

In order to call up quickly frequently used frequencies/channels, training frequencies etc., the DF-system can store and document these frequencies.

For each of the four frequency bands an individual list may be provided. Stored frequencies/channels may be provided with own designations and comments, their sequence and position may be changed within the list, and they can be deleted, if necessary.

International valid emergency frequencies are already stored in the corresponding frequency band. They are on first position within the frequency band lists and cannot be moved or cancelled.

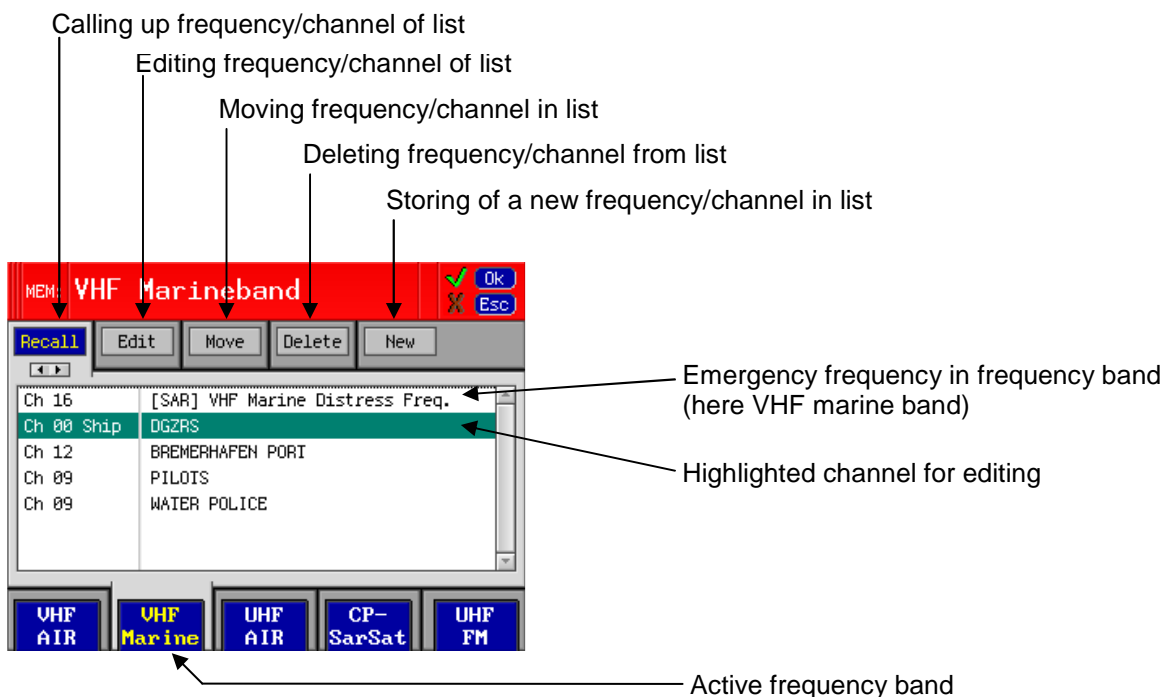

Fig. 36 Dialogue window Memory / Band

6.8.1 Recall Frequency/Channel from Storage List

- Open dialogue window using key **Memory / Band** .
- Select option **Recall** using arrow key .
This option is already preselected when opening the dialogue window.
- Select corresponding frequency band using function keys F1 to F4.
The display will show your list.
- Select desired frequency/channel using arrow keys .
The selected frequency/channel is marked with a green bar.
- Key **Ok** will confirm your selection.
The device returns to bearing mode and work on the set frequencies / channels.

6.8.2 Edit Text (of Frequency/Channel) in Storage List

- Open dialogue window using key **Memory / Band**.
- Select option **Edit** using arrow keys **←** **→**.
- Select desired frequency band using function keys F1 to F4.
The selected list is shown on the display.
- Select desired frequency/channel using arrow keys **↑** **↓**.
The selected frequency/channel is marked with a green bar.
- Key **Ok** will confirm the selection.
The text input window is opening (see Fig. 37). The frequency/channel can now be provided with a name or comment. The text is limited to 35 digits.

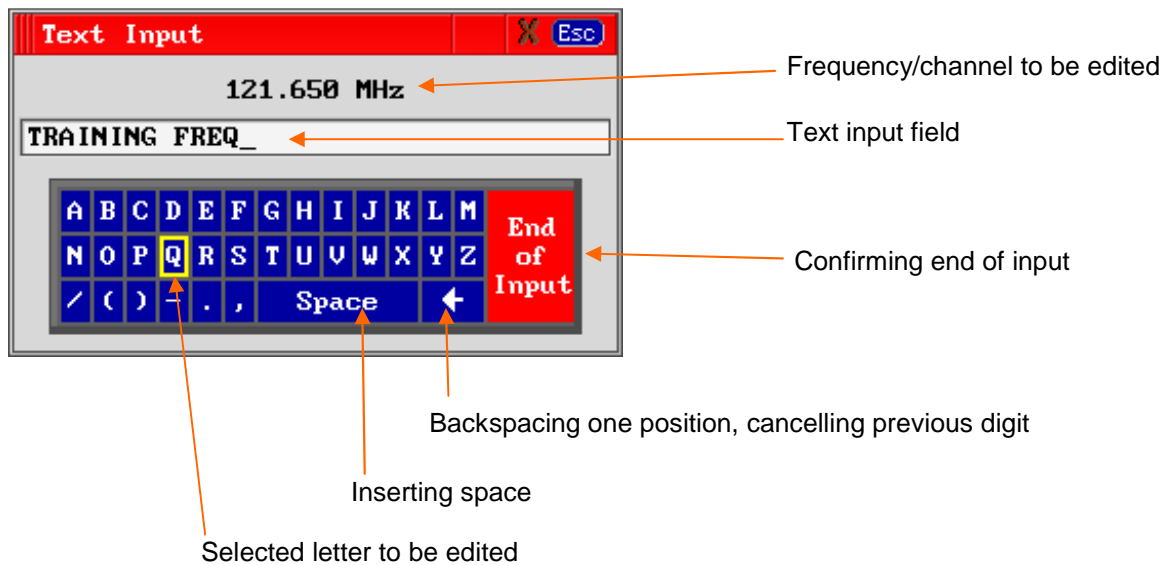

Fig. 37 Text input window

- Put in desired text by the means of the text input window:
 - Select desired letter using the four arrow keys. The selected letter/digit is marked with a yellow frame
 - Pressing key **Ok** overtakes the marked letter/digit.
 - Numbers can be put in directly using the numeric keys.
 - In order to insert a space mark, select field **Space**.
 - In order to cancel a letter/digit, select field **←**.
 - In order to close the text input, select field **End of Input** and confirm using key **Ok**.
The text input window will be closed and the text is stored in the list.

6.8.3 Move a Frequency/Channel within a Storage List

By the means of the function "Move", frequencies/channels can be sorted within a list.

NOTE: International valid emergency frequencies on position 1 cannot be moved.

- Open dialogue window using key **Memory / Band**.
- Use arrow keys **←** **→** for option **Move**.
- Use function keys F1 to F4 to select corresponding frequency band.
your list will be shown on the display.
- Use arrow keys **↑** **↓** to mark frequency/channel to be moved and confirm selection using key **Ok**.
The selected frequency/channel is marked with a green flashing bar.
- Shove marked frequency channel using arrow keys **↑** **↓** to the desired position and confirm using key **Ok**.

6.8.4 Delete a Frequency/Channel in the Storage List

NOTE: International valid emergency frequencies, stored on first position in each frequency band, cannot be deleted.

- Open dialogue window using key **Memory / Band**.
- Select option **Delete** using the arrow keys **←** **→**.
- Select desired frequency band using function keys F1 to F4.
The list will be shown in the display.
- Mark frequency/channel to be deleted using arrow keys **↑** **↓** and confirm with key **Ok**.
The selected frequency/channel is marked with a green flashing bar.
- The DF-system now requires a confirmation of the deleting process. Confirm using key **Ok**.

6.8.5 Store a new Frequency/Channel in a Storage List

- Open dialogue window using key **Memory / Band**.
- Select option **New** using arrow keys **←** **→**.
- Function keys F1 to F4 select desired frequency band.
The up to now provided list will be shown in the display.
- Open dialogue window using key **Ok** in order to put in the frequency/channel. Proceed as described in 6.2.1 (frequency) or in 6.2.2 (channel).
- The new frequency/channel will be taken over in the corresponding list and will be displayed.
Option "Edit" allows adding of text to the new frequency/channel. Select option "Recall", if the frequency/channel is to be used as present operating frequency/channel.

7 Menu (Setup)

All system settings, exceeding common operation of the DF-system (interface settings, offset setting...) will be made in the "Menu Setup".

ATTENTION: Incorrect settings in the Menu setup may lead to considerable malfunctions of the DF-system RT-800. Therefore, sensitive parameters concerning the bearing operation are password protected against non authorized alterations. Alterations of settings which require password release are to be made only by instructed persons.

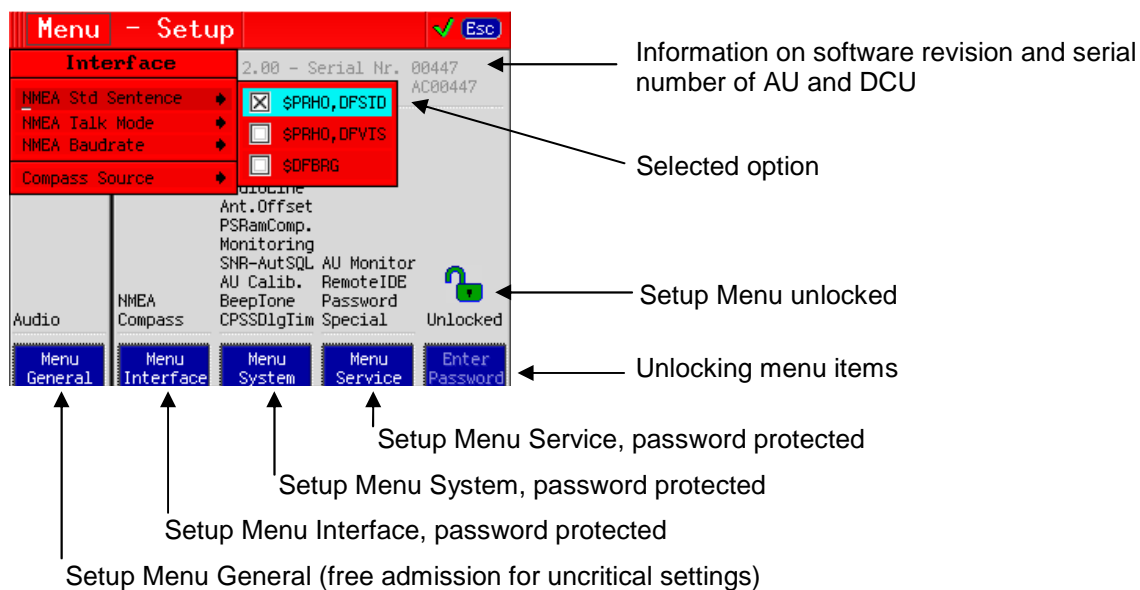

Fig. 38 Operating Menu Setup (example: Interface / NMEA Standard Sentence)

- Open dialogue window Menu Setup using key **Menu**.
- Select corresponding Setup Menu using function keys F1 to F5. Function keys will open a list of further submenu items.
- Select submenu to be adjusted by using arrow keys **↑** **↓**. Selected field is highlighted in bright green.
- Select option from listing of possible settings using the arrow keys **↑** **↓** **←** **→**, confirm the selection using key **Ok**.
 = option not active / = option active
- Or: put in desired value by using the numeric keys and confirm **Ok**.

7.1 Menu General

Editable freely, uncritical settings:

Menu - Setup		
General	Audio	<input checked="" type="checkbox"/> Beeper Key Pressing

Fig. 39 Menu General, table default settings

7.1.1 Audio

As a standard, there is a short beep when pressing a key. If the beep is to be suppressed, deactivate setting "Beeper Key Pressing".

7.2 Menu Interface

Settings, concerning data interfaces and functions, can be made in menu "Interface" (password protected)

Menu - Setup		
Interface	NMEA Std Sentence	<input checked="" type="checkbox"/> \$PRHO,DFSTD <input type="checkbox"/> \$PRHO,DFVTS <input type="checkbox"/> \$DFBRG
	NMEA mode	<input type="checkbox"/> Only On Request <input type="checkbox"/> Autotalk 2 sec <input type="checkbox"/> Autotalk 1 sec <input type="checkbox"/> Autotalk 500 ms <input checked="" type="checkbox"/> Autotalk 250 ms
	NMEA baud rate	<input type="checkbox"/> 1200 Baud <input checked="" type="checkbox"/> 4800 Baud <input type="checkbox"/> 9600 Baud <input type="checkbox"/> 19200 Baud <input type="checkbox"/> 38400 Baud <input type="checkbox"/> 57600 Baud <input type="checkbox"/> 115200 Baud
	Compass source	<input checked="" type="checkbox"/> No ext. Compass (Off) <input type="checkbox"/> NMEA: \$HCHDT ... <input type="checkbox"/> NMEA: \$HEHDT ... <input type="checkbox"/> NMEA: \$xxHDT ... <input type="checkbox"/> NMEA: \$HCHDG ... <input type="checkbox"/> NMEA: \$HEHDG ... <input type="checkbox"/> NMEA: \$xxHDG ...

Fig. 40 Menu Interface, table default settings

7.2.1 NMEA Std Sentence

NMEA Std Sentence controls which standard sentence is sent when Autotalk is activated.

- \$PRHO,DFSTD The RHOTHETA standard bearing sentence \$PRHO,DFSTD is sent
- \$PRHO,DFVTS The VTS-Standard sentence \$PRHO,DFVTS of RHOTHETA is sent
- \$DFBRG \$DFBRG standard sentence is sent

7.2.2 NMEA Mode

In NMEA mode, the NMEA data output of the DF-system is selected.

- Only on Request Data output on request only
- Autotalk ... sec/ms Continuous data output of standard DF data in fixed intervals

For further information refer to "RT-500-M & RT-800 NMEA-Protocol Description".

7.2.3 NMEA baud rate

NMEA baud rate will set velocity of data transmission of serial NMEA interface (input and output).

For further information refer to “RT-500-M & RT-800 NMEA-Protocol Description”.

7.2.4 Compass Source

An external compass may be connected to the systems NMEA interface. Set here data format of connected compass.

No external compass connected, select menu item „ No ext. Compass (Off)“.

Select corresponding data format of external compass here.

For further information refer to “RT-500-M & RT-800 NMEA-Protocol Description”.

7.3 Menu System

Internal system settings (password protected)

ATTENTION: Faulty settings may lead to misfunctions of the system.

Menu - Setup		
System	Address ID	[00]
	Antenna Unit	<input type="checkbox"/> Mounted Upside Down
	Audio Line Output	[50]%
	Antenna Offset	[000]Deg
	PS RAM	<input type="checkbox"/> Compass Compens. Off
	Monitoring	<input type="checkbox"/> Off Blocked
	S/N-Ration AutoSQL	[Default] (Default-Value = 6)
	AU Calibration	<input type="checkbox"/> Calibration Off
	BeepTone Decoding	
	Frequency High	875 Hz
	Frequency Low	725 Hz
	Decoding Time	500 ms
	CPSS Dialog Time	<input checked="" type="checkbox"/> 75 Seconds <input type="checkbox"/> 5 Minutes <input type="checkbox"/> 1 Hour <input type="checkbox"/> 10 Hours

Fig. 41 Menu System, table default settings

7.3.1 Address-ID

In menu item "Address ID" the internal device addressing can be set. Addresses from 0 to 99 are possible.

7.3.2 Antenna Unit

The systems dipole antenna can only be mounted in vertical alignment. The mounting flange is pointing to the ground for standard mounting. For hanging mounting (flange on the top) select menu item „ Mounted Upside Down“ for correct signal processing.

ATTENTION: This is strictly not recommended for VTS/fixed installations!

7.3.3 Audio Line Output

Adjust level of Audio Line Output signal. The level is adjustable from 10% to 99%. The Audio Line output has a determined output level and is independent of the volume adjustment. This is the input signal of the IP-Audio encoder.

7.3.4 Antenna Offset

The bearing antenna has to be mounted "North orientated", the "North" resp. 0° marker has to point exactly to north. If the antenna cannot be mounted (for different reasons) pointing

exactly to north, the deviation correction can be put in here. The offset is adjustable from 0° to 359° (e.g. -15° = 345°).

7.3.5 PS Ram

An external compass connected, the bearing value determination is done by a special, improved compensating procedure. For a compass of minor quality (e.g. heavy and quick variations) it may be necessary, to switch off the compass compensation. Select „ Compass Compens. Off“.

7.3.6 Monitoring

In the default setting " Off Blocked" it is not possible to deactivate the monitoring operation (see 6.4). Thus, surveillance of the emergency frequencies cannot be switched off by mistake. If the monitoring operation is to be switched off manually, the setting " Off Blocked" has to be deactivated.

The DF-systems monitoring/scanning function can now be switched on/off in the corresponding dialogue window (see 6.4).

7.3.7 S/N-Ratio AutoSQL

This value controls the Auto-Squelch. It determines how many level-points the squelch marker is set above the noise level. If the value is 6 for example, the squelch marker is adjusted always 6 level-points above the noise level. Default value is "6".

7.3.8 AU-Calibration

This setting can disable the internal calibration values of the AU. Change this setting only in special cases or if you are told by RHOTHETA Elektronik GmbH.

7.3.9 BeepTone Decoding

This parameters control the behaviour of the "Alarm Only Decoding / BeepTone" option of Fast Channel Scan.

7.3.9.1 Frequency High / Frequency Low

With Frequency High / Frequency Low you specify the range of the audio-frequency which triggers an alarm. That means if a signal should trigger an alarm, the audio frequency of the signal must be greater than Frequency Low and less than Frequency High.

7.3.9.2 Decoding Time

Decoding Time determines the minimum duration of an audio signal (within the specified frequency range) that should trigger an alarm.

For example given the parameters Decoding Time = 800ms, Frequ. High = 875 Hz, Frequ. Low = 725 Hz, the signal must remain at least 800 milliseconds continuously with its frequency between 725 Hz and 875 Hz to start an alarm.

7.3.10 CPSS Dialog Time

This setting could be used to select the duration until the dialogue Cospas/Sarsat-Decoding closes automatically.

7.4 Menu Service

Internal settings and service dialogues (password protected):

Menu - Setup		
	Monitor	Antenna Unit
	Password Change	

Fig. 42 Menu Service table

7.4.1 Monitor

The Setup Menu item "Service-Monitor" is to be opened only for service and maintenance operation. Changes of settings are reserved to the firm RHOTHETA or instructed persons.

7.4.2 Password

If the system has been unlocked by the default password during first installation (see 7.5) create and change your personal password now. Only one password can be stored.

- Press function key F4 and select option „Passwort Change“.
A data input field will open
- Put in now your password by the means of the numeric keys or the editing fields.
The input is limited to 8 digits. The password may consist of any numbers and signs, as well as special marks and space marks. A space mark at the beginning of the password is not possible.
- Confirm your input using key **Ok**.
The password is stored for further operation.

7.5 Unlocking Setup Settings

ATTENTION: Wrong or faulty settings in setup menus as "Interface", "System" and "Service" may lead to dysfunctions. These settings are password protected.

Before starting to change these settings, password protection has to be released. If the setting procedure is interrupted by pressing key **Esc** , password protection is automatically enabled again.



The blocked menu setting is indicated by a closed grey padlock.



The menu setting deblocked and opened, green padlock is visible. In this constellation all parameters may be changed.

In order to unlock the setup menu press function key F5 **Enter Password**

An input field for entering the password is opened.

Enter password by the means of the numeric keys or the editing fields.
(operating editing fields see 6.8.2)

Prior to first putting into operation the DF-system is protected by a preset password.

→ The preset password is: **123**

Confirm input by using key **Ok**.

Menu items as Interface, System, Service can be edited now and changed if desired.

After unlocking the system as described in 7.4.2 you may create and change your personal password.

8 Interfaces

8.1 Overview

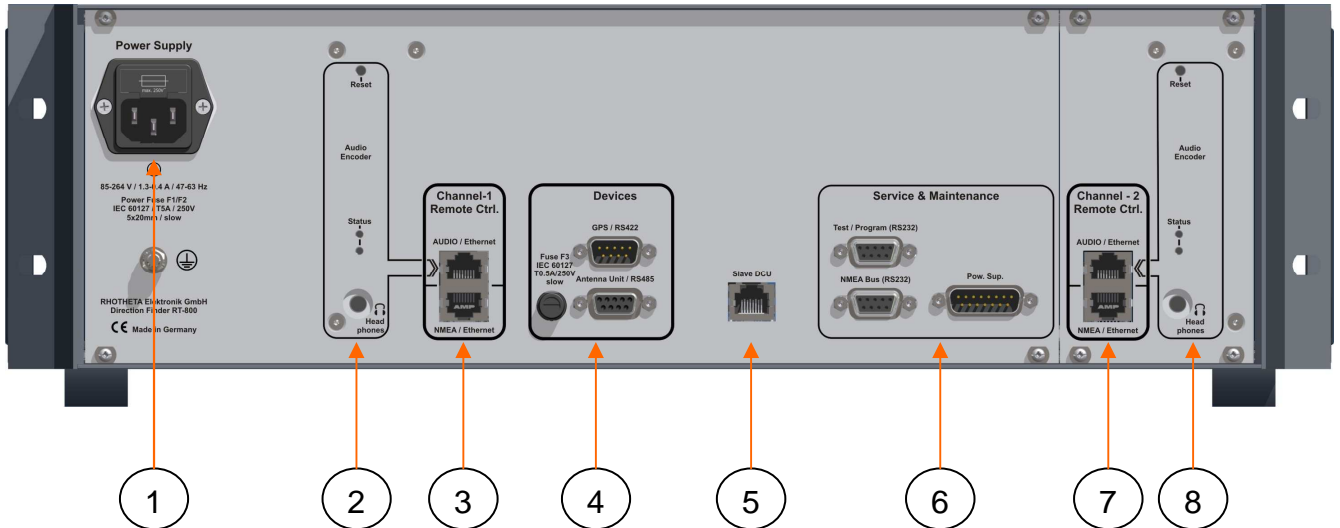
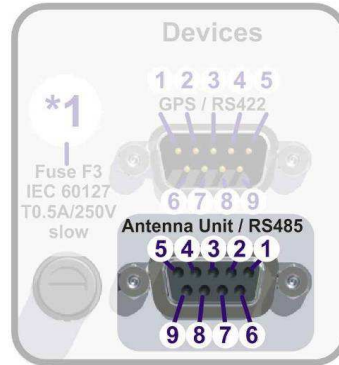

Fig. 43 Overview of Interfaces

Pos.	Designation	Meaning	See page
1	Power Supply	Power supply connector with replaceable fuse	63
2	IP-Audio Encoder (Channel-1)	Audio Output for DF and encoder configuration	62
3	Remote Control Channel-1	Ethernet ports for remote control (NMEA / Ethernet) and IP-Audio (AUDIO / Ethernet)	62
4	Devices	Connector ports for AU (antenna unit) and optional GPS-connector for the option "UTC Time Base"; fuse for AU / GPS power supply	60
5	Slave DCU	Ethernet connector for factory use only	---
6	Service & Maintenance	Ports for optional connections, SW-Update and local NMEA-Output	64
7	Remote Control Channel-2	Option: "2 nd Channel Remote Control" Ethernet ports for remote control (NMEA / Ethernet) and IP-Audio (AUDIO / Ethernet)	
8	IP-Audio Encoder (Channel 2)	Option: "2 nd Channel Remote Control" Audio Output for DF and encoder configuration	

8.2 Device Ports

8.2.1 Antenna Unit Port (Connecting Cable DCU ↔ AU)



Contact / Pin Signal

3	+24 V_{DC}	Output power supply to Antenna Unit	
8			
5	GND		
9			
1	RS485 A		Serial data connection DCU ↔ AU (9600 Baud / semi-duplex / receive and transmit)
6	RS485 B		
2	NF	Input audio signal resp. analog Test/Service	

Connecting cable DCU ↔ AU

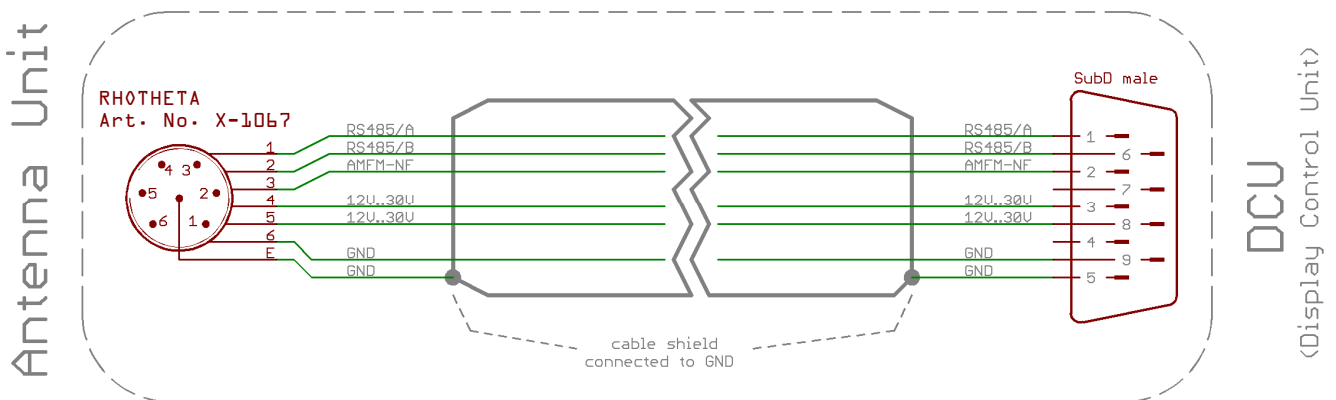

Connection
Antenna Unit

connecting cable 6-poled with shield

Connection
Display Control Unit

Connector type:
RHOTHETA

length 1 to 100 m: cross section of conductor min.
6 x 0.50 mm²

Connector type:
SubD 9-poled male

Article Number X-1067

Fig. 44 Connecting cable DCU ↔ AU

8.2.2 GPS / RS422 Port

This optional (Build-To-Order Option) input is used to connect an external GPS-device to set the internal system clock. This is required for synchronisation of the bearing values if several direction finders are connected together by a command and control center.

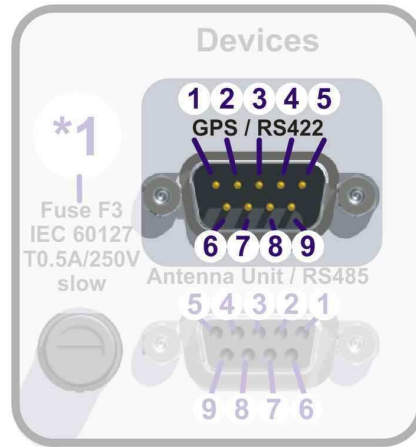

Contact / Pin **Signal**

6	RS422 Rx / A	Input of serial GPS data with RS422 level
1	RS422 Rx / B	
5	GND	Output power supply for external GPS
9	+24V_{DC}	

8.2.3 Fuse F3



This protection fuse covers the power supply of antenna unit as well as external GPS.

8.3 Remote Control and IP-Audio Encoder Ports

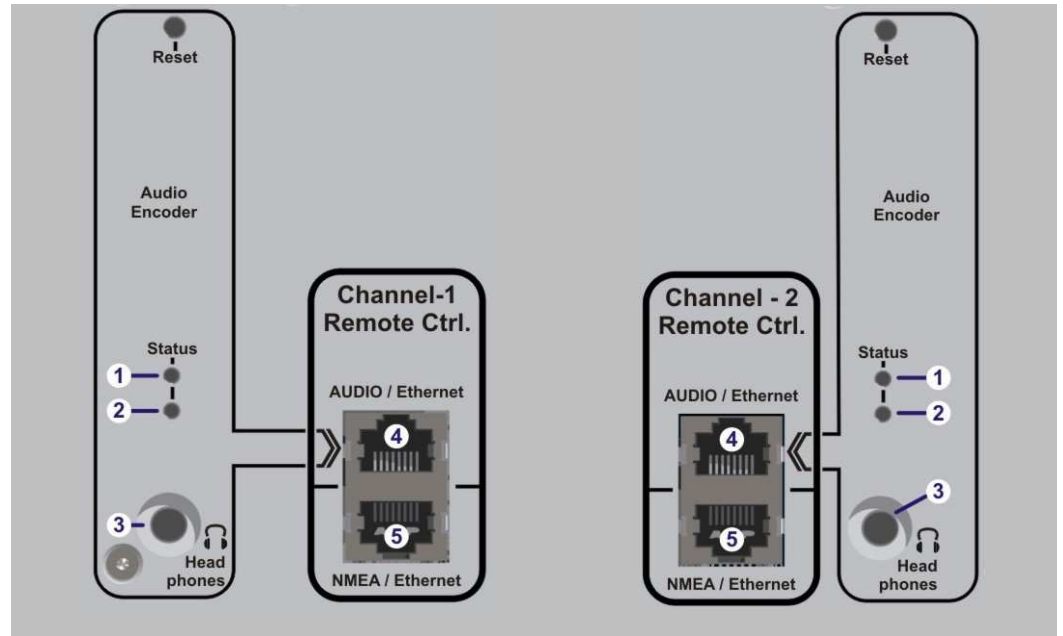

Item **Marking**

1	Status LED (red)	Blinks during boot process of IP Audio Encoder
2	Status LED (green)	Blinking: IP Audio Encoder is sending On: IP Audio Encoder is not sending
3	Head phones	After switching on the DCU, the current IP-address of the IP Audio Encoder is output to connected headphones. (This is only used during configuration process!)
4	Audio / Ethernet	Ethernet connection of IP Audio Encoder must be connected to LAN!
5	NMEA / Ethernet	Ethernet connection of NMEA remote control must be connected to LAN!

If the option “2nd Remote Control Channel” is used, so it has the same connectors as the Channel-1.

8.4 Power Supply

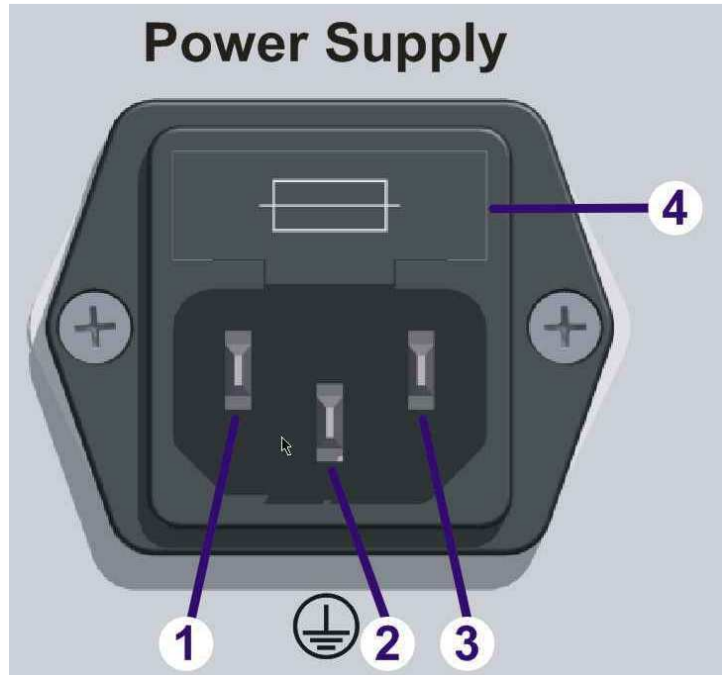

Item / Pin	Marking	
1	N (Neutral)	IEC 60320 / C14 inlet for use of power cords with IEC 60320 / C13 plugs. 115 – 230 Volts / 1.0 – 0.5 Ampere / 50 – 60 Hz
2	PE (protective earth)	
3	L (Line)	
4	Built-In Fuse (replaceable)	Embedded replaceable Fuse of type IEC 60127 / T5A / 250V / 5x20mm / slow

8.5 Service & Maintenance Ports

8.5.1 Power Supply and Optional Connections

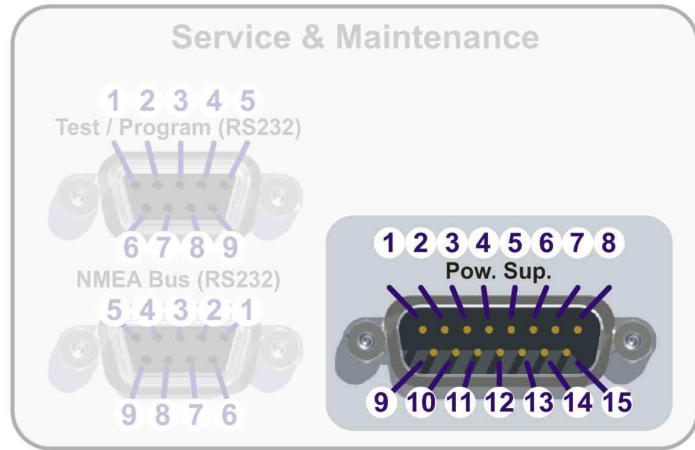

Contact
/ Pin

Signal

15	+12 V to +30 VDC	ATTENTION: No connections required (internally connected)!
8	GND (Ground)	
7	Permanent Operation	ATTENTION: No connections required (internally connected)!
14	PTT / SBS	Optional input in order to suppress self bearing. When connecting input PTT/SBS (Self Bearing Suppression) to Ground, self bearing is suppressed
6	GND	
12	Squelch Out	Optional output for audio connection. When receiving a signal this pin is connected to ground by the means of an Open Collector output.
4	GND	
1	Alarm Relay	Optional alarm contact (mechanical relay as NOC, Normal Open Contact) max. 1 A at 30 V _{DC} resp. max. 0.3 A at 125 V _{AC}
9		
3	Speaker +	ATTENTION: No Connection required, because this ports are connected to the internal speaker!
11	Speaker -	
13	Audio Line Out	ATTENTION: Connection not recommended, because this port is connected to the IP Audio Encoder! Audio output (connected to ground with fixed level) Adjustable in menu, from 200 mV _{SS} at 10% to max. 2 V _{SS} at 99%
5	GND	

8.5.2 NMEA Bus (RS 232)

This is an additional NMEA interface of the DCU. It is recommended to use it only for local tests, because commands sent to the DCU may be interfere with commands sent through NMEA - Ethernet interface!

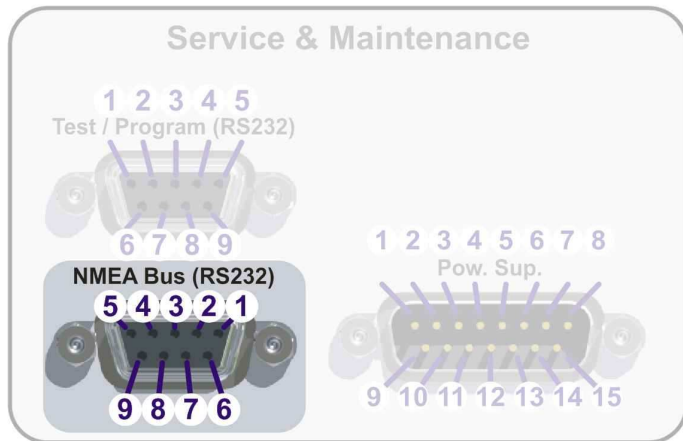

Contact / Pin **Signal**

2	RS232 Tx	Output of serial data with RS232 level
3	RS232 Rx	Input of serial data with RS232 level
5	GND	GND level for RS232 connection

8.5.3 Test / Program

Port for service or test operation (Software and new firmware upload).

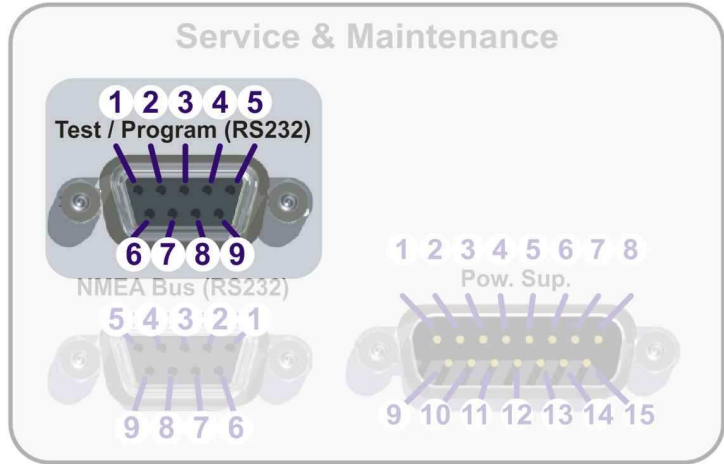

Contact / Pin

Signal

2	RS232 Tx	Output serial data with RS232 level
3	RS232 Rx	Input serial data with RS232 level
5	GND	GND level for RS232 connection

9 Guideline for optimal DF antenna position

The quality of the bearing results depends largely on the position of the antenna. So, an antenna position has to be found, where the transmitter's wavefield can reach the bearing antenna as undisturbed as possible.

If high bearing accuracy is demanded, no metallic resp. RF-conducting obstacles shall be around the antenna unit (in an angle of $\pm 45^\circ$ towards the horizontal).

Objects being in the "restricted area" will disturb the arriving wave field. Reflections will arise which might disturb bearing accuracy and so on decrease the bearing accuracy. This physical effect generally is valid for all bearing systems. In practice, often a compromise has to be found between bearing and other interests.

NOTE: For more information on this topic please refer to *RT-800 Installation and Configuration Manual!*

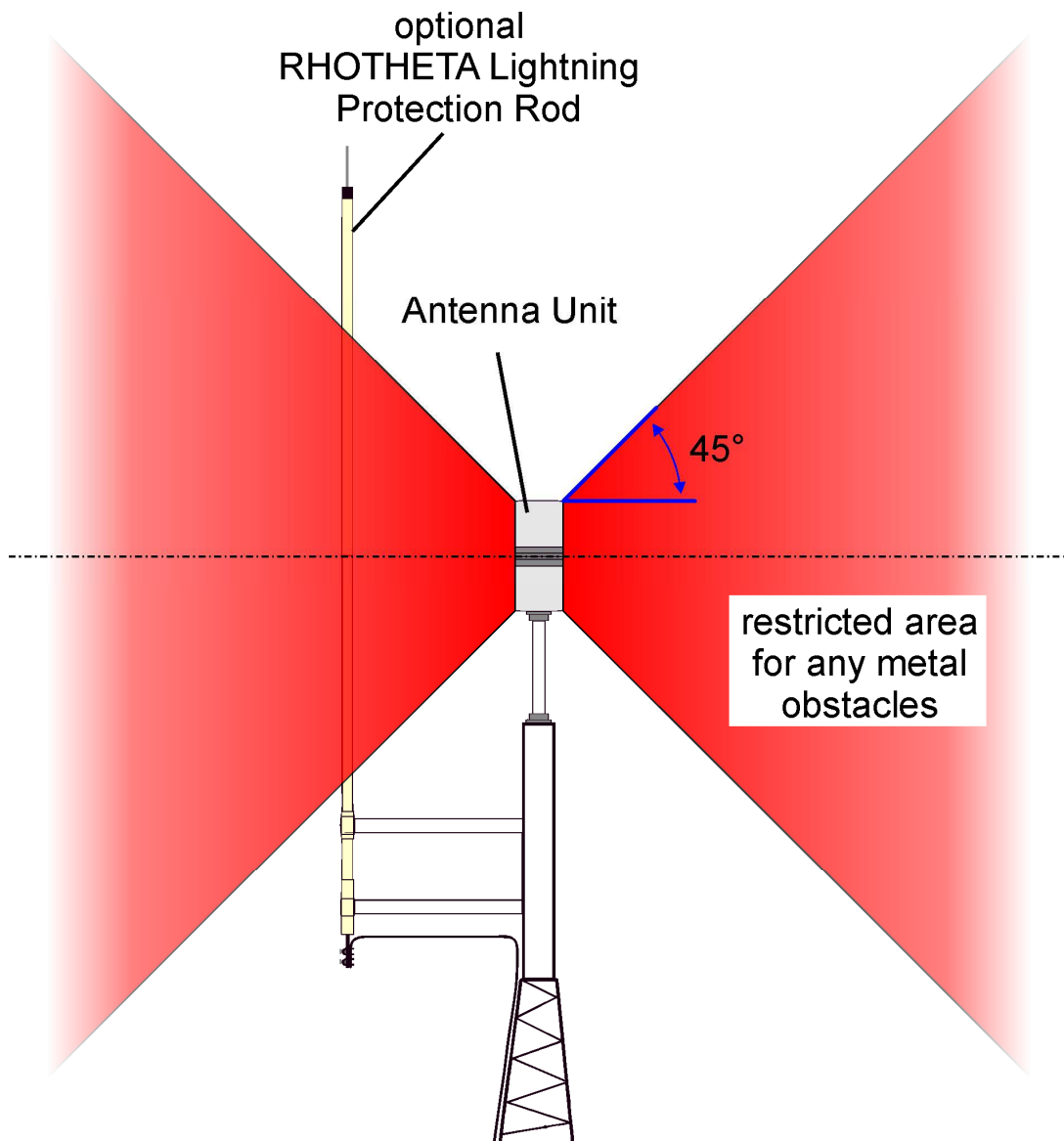

Fig. 45 Example for optimal DF antenna position

10 Technical Data Sheet

10.1 Electrical Characteristics

Method of bearing:	Doppler-principle (3 kHz rotational frequency, right / left rotation, CW/CCW)	
Bearing indication:	Relative bearing and true bearing related to North (if external heading data available)	
Bearing accuracy ¹ :	±2° RMS	
Internal resolution:	1°	
Sensitivity:	HF-voltage at receiver input (50 Ω): VHF, UHF <100 nV; Cospas-Sarsat 406.000 MHz <150 nV	
Stability of frequency:	±2.0 ppm ($\Delta f/f = \pm 2 \times 10^{-6}$) [in temperature range -30 °C to +80 °C]	
Receiving bands:	5 (VHF-air band, VHF-marine band, UHF-air band, Cospas-Sarsat, UHF-FM Band)	
Receiving frequencies (frequency ranges)	Standard Version	Optional Frequency Range
	VHF-Airband: 118.000 – 124,000 MHz	118.000 – 136.992 MHz
	VHF-Marineband: 154.000 – 163,000 MHz	137.000 – 224.995 MHz
	UHF-Airband: 240.000 – 246,000 MHz	225.000 – 399.975 MHz
	Cospas-Sarsat: 400.000 – 406.092 MHz	
	UHF-FM Band: 406.100 – 410.000 MHz	406.100 – 470.000 MHz
Marine channels	Channel 0 .. 28 / 60 .. 88 (ship station + coast station in each case)	
Channel pattern	25 kHz / 8,33 kHz / 5 kHz (depending on frequency band)	
Monitoring / Scanning modes:	<p>Monitoring: Four additional frequencies (emergency frequency 121.500 MHz and three free selectable frequencies) are monitored during normal operation.</p> <p>Standby: The Cospas-Sarsat and 121.500 MHz emergency frequency is monitored at all time in standby mode.</p> <p>Fast Marine Ship Band Scan (within approx. 3 sec): Fast scan (without gap) within the range of ship channels[01..88] = [156,050...157,425 MHz]. Detection of each signal (also between the channel grid).</p> <p>Fast Channel Scan (within max. 2 sec): Fast scan of up to eight freely selectable frequencies/channels. (Only with unlocked option "Fast Channel Scan Mode"!)</p>	

¹Undisturbed wave field and sufficient field strength supposed. Measuring by changing the angle of incidence, the bearing antenna rotates on a revolving table in order to eliminate influences of environment to the bearing result.

Signal filtering:	Optional: all emergency frequencies can be filtered for ELT-modulation (false alarms disabled).
Cospas-Sarsat analysis:	Reception and analysis of Cospas-Sarsat data signal (112 or 144 bit, 400 baud, biphasic L-phase modulated, with Bose-Chaudhuri-Hocquenghem error correction code, specified according Cospas-Sarsat C/S T.001 October 1999) Indication of data content (mode, country, GPS-coordinates)
Bearable modulation:	A3E, F3E, A3X (PLB-modulation); bearing largely independent of modulation.
Polarisation:	Vertical
Polarisation error	$\leq 5^\circ$ at 60° field vector rotation
Garbling cone:	approx. 30° to vertical
Response time:	≤ 50 ms (with sufficient reception field strength)
Keyboard	Foil on the front with integrated keyboard matrix and EL background illumination
TFT Graphic Display	320 x 240 pixel with max. brightness of approx. 450 cd/m^2 , continuously adjustable or automatic control.
Operating voltage:	115 – 230 Volts / 50 – 60 Hz
Current consumption:	1.0 – 0.5 Ampere
Power consumption	Nominal 30W @ 230V
Audio out:	Internal speaker 4 W Line out (adjustable from 100 mV pp to 2000 mV pp)
Interfaces	Ethernet Interface for NMEA remote control (TCP) Ethernet Interface for IP Audio output (e.g. Internet Radio, RTP, RawUDP, RawTCP, SIP, Icecast, Shoutcast) External GPS (RS422, optional) Headphone (only used for setup of IP Audio) NMEA In/Output (RS232, only for local test purposes) Testport (RS232) optional customer specific Alarm relay output (1.0 A, 30 V DC / 0.3 A, 125 V AC) PTT input for self-bearing suppression Squelch output for external audio control

10.2 Mechanical Characteristics

10.2.1 DCU Dimensions (built-in version)

Measuring units: [mm] millimeters

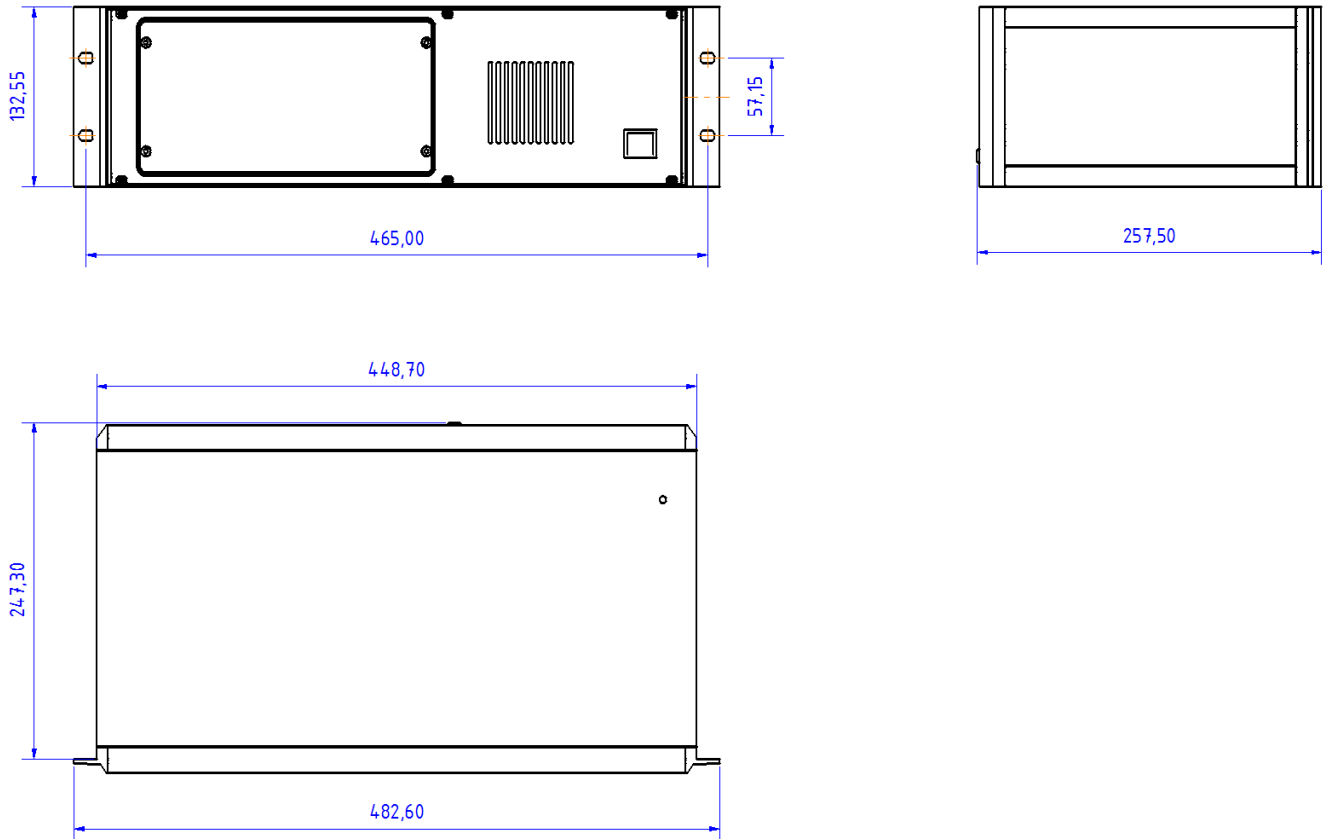

Fig. 46 RT-800, mechanical dimensions (built-in version)

10.2.2 DCU Dimensions (tabletop version)

Measuring units: [mm] millimeters

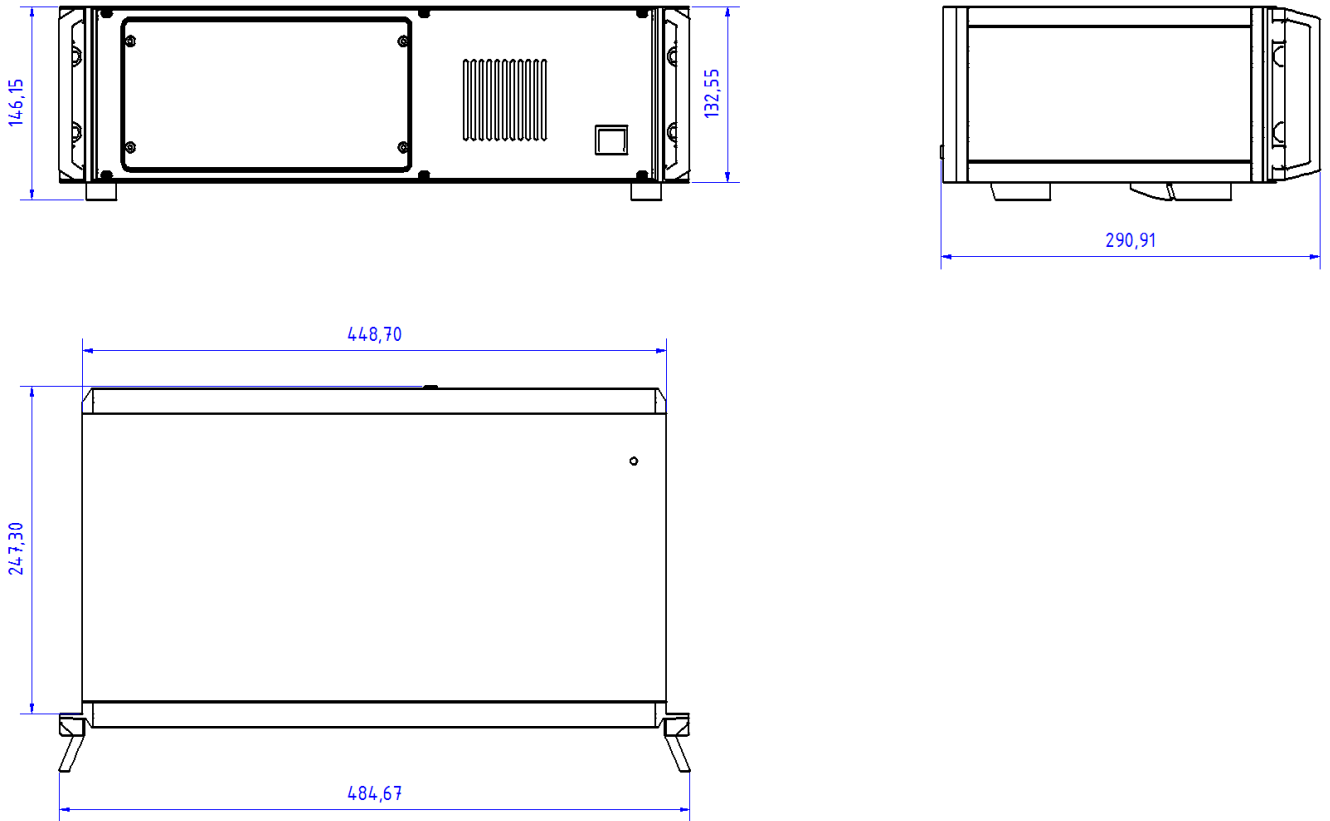

Fig. 47 RT-800, mechanical dimensions (tabletop version)

10.2.3 DCU Data

Weight	Approx. 5900 g
Permitted operating temperature	-20 °C to +60 °C
Permitted storage temperature	-30 °C to +80 °C

10.2.4 Antenna Unit Dimensions

Measuring units: [mm] millimeters

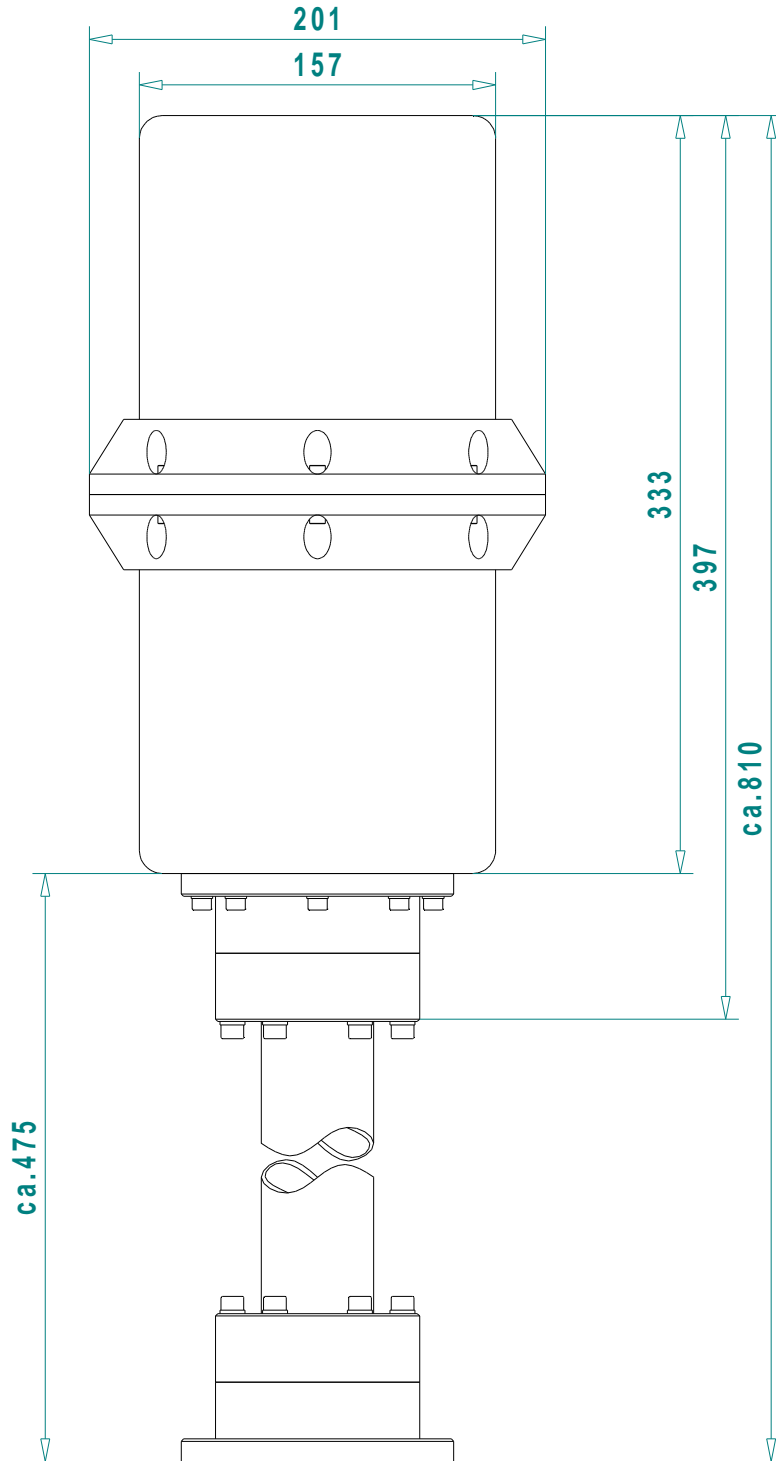

Fig. 48 Antenna Unit, mechanical dimensions

10.2.5 Antenna Unit Mast Flange

Measuring units: [mm] millimeters

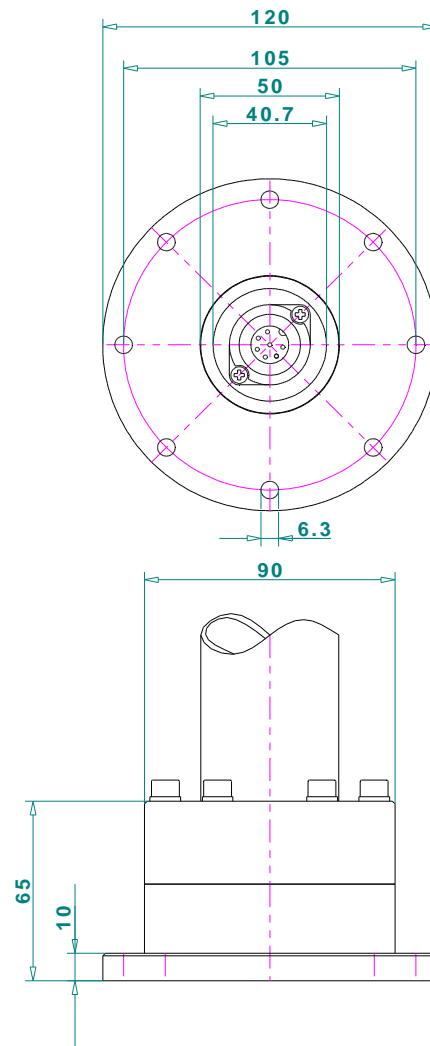

Fig. 49 Antenna Unit, mast flange (mechanical dimensions)

10.2.6 Technical Data Antenna Unit

Weight	Approx. 5200 g
Permitted operating temperature	-40 °C ² to +60 °C
Permitted storing temperature	-55 °C to +80 °C
Ingress protection	IP 67

² Temperatures below -10°C resp. 14°F may require a warming up time of up to 15 minutes!

11 Maintenance and Cleaning

Cleaning

RHOTHETA Elektronik recommends cleaning the RT-800 with warm water and a microfiber cloth. Persistent stains can be washed with a dishwashing detergent. Do not use any abrasives or cleaning agents containing alcohol.

12 Product Disposal

12.1 Disposal within the European Union

Product Disposal



■ Product labelling according to EN 50419

At the end of product life, this product may not to be disposed together with normal household waste. Even disposal via the municipal waste disposal collection for electrical and electronic equipment is not permitted.

The correct disposal of this product helps to protect the environment and prevent any potential damage to the environment and human health, which can occur due to improper handling of the product.

- Therefore, supply the device to an electronics recycling after the final taken out of service.

Or

- The RHOTHETA Elektronik GmbH takes back all products that are subject to the requirements of the WEEE Directive (2012/19/EU) of the European Union to supply these products to professional disposal.

12.2 Disposal outside the European Union

For disposal the equipment in accordance with national regulations in countries outside the European Union, ask your dealer or local authorities.

13 Appendix

13.1 Error Messages

Error message	Error location	Cause
Error 01 AU No Receiver	Antenna Unit: Receiver	defective receiver circuit board in AU
Error 04 AU Rec. No PLL	Antenna	Error in receiver synthesizer oscillator in AU
Error 05 DCU>AU No Data	Connection Display → Antenna	No serial data from DCU to AU
Error 06 DCU>AU BadData	Connection Display → Antenna	Incompatible resp. bad data connection between DCU and AU
Error 07 AU Low Voltage	Main voltage supply	Voltage supply below 10 V
Error 08 AU>DCU BadData	Connection Antenna → Display	Incompatible resp. bad data connection between AU and DCU
Error 09 No AntennaUnit	Connection Antenna → Display	No serial data (RS485) from AU. Missing or damaged cable connection between AU and DCU resp. defective AU

13.2 Warnings

Warning message	Error location	Cause
Warning 01 AU low Voltage	Main voltage supply	Low voltage supply of AU
Warning 02 NoCompassFound	External device	Compass data not available (see page 54)
Warning 10 NMEA DataRange	External device	Incorrect NMEA data: Value out of allowed range
Warning 11 NMEA Bad Data	External device	Defective data recognized on NMEA interface
Warning 12 NMEA CheckSumm	External device	Defective data recognized on NMEA interface: Check Sum
Warning 13 NMEA Bad Frame	External device	Defective data recognized on NMEA interface: Bad Frame
Warning 20 AU DataRange	Connection Display → Antenna	Bad data of DCU, mismatch of telegram length
Warning 21 AU Decode Err	Radio distance transmitter ↔ direction finder	Data error in Cospas-Sarsat data block, data could not be decoded
Warning 22 Send Freq.Ofs-	Received transmitter	Frequency of transmitter too low
Warning 23 Send Freq.Ofs+	Received transmitter	Frequency of transmitter too high
Warning 30 FLASH Config	DCU Flash memory	The stored settings cannot be read. (Device is operating with default settings)
Warning 39 Simulation	Simulation Mode	The AU simulation mode is active
Warning 40 No Master DCU	DCU	A Slave DCU don't find it's corresponding master

13.3 Frequencies of channels on maritime band

Channel No.	frequency (ship - station)	Frequency (coast - station)
0	156,000 MHz	160,600 MHz
1	156,050 MHz	160,650 MHz
2	156,100 MHz	160,700 MHz
3	156,150 MHz	160,750 MHz
4	156,200 MHz	160,800 MHz
5	156,250 MHz	160,850 MHz
6	156,300 MHz	160,900 MHz
7	156,350 MHz	160,950 MHz
8		156,400 MHz
9		156,450 MHz
10		156,500 MHz
11		156,550 MHz
12		156,600 MHz
13		156,650 MHz
14		156,700 MHz
15		156,750 MHz
16		156,800 MHz
17		156,850 MHz
18	156,900 MHz	161,500 MHz
19	156,950 MHz	161,550 MHz
20	157,000 MHz	161,600 MHz
21	157,050 MHz	161,650 MHz
22	157,100 MHz	161,700 MHz
23	157,150 MHz	161,750 MHz
24	157,200 MHz	161,800 MHz
25	157,250 MHz	161,850 MHz
26	157,300 MHz	161,900 MHz
27	157,350 MHz	161,950 MHz
28	157,400 MHz	162,000 MHz
60	156,025 MHz	160,625 MHz
61	156,075 MHz	160,675 MHz
62	156,125 MHz	160,725 MHz
63	156,175 MHz	160,775 MHz
64	156,225 MHz	160,825 MHz
65	156,275 MHz	160,875 MHz
66	156,325 MHz	160,925 MHz
67		156,375 MHz
68		156,425 MHz
69		156,475 MHz
70		156,525 MHz
71		156,575 MHz
72		156,625 MHz
73		156,675 MHz
74		156,725 MHz
75		156,775 MHz
76		156,825 MHz
77		156,875 MHz
78	156,925 MHz	161,525 MHz
79	156,975 MHz	161,575 MHz
80	157,025 MHz	161,625 MHz
81	157,075 MHz	161,675 MHz
82	157,125 MHz	161,725 MHz
83	157,175 MHz	161,775 MHz
84	157,225 MHz	161,825 MHz
85	157,275 MHz	161,875 MHz
86	157,325 MHz	161,925 MHz
87	157,375 MHz	161,975 MHz
88	157,425 MHz	162,025 MHz

13.4 List of abbreviation

Abbreviation	Meaning	Remarks
AU	Antenna Unit	
CP/SS	Cospas-Sarsat	
DCU	Display & Control Unit	
DF	Direction finder	
Deg	Degree (° = 60')	
ELT	Emergency Locator Transmitter	
GND	Ground	
GPS	Global Positioning System	
ID	Identification	
IP	Ingress Protection rating	IP67
LAN	Local Area Network	
LCD	Liquid Crystal Display	
LED	Light-Emitting Diode	
MOB	Man-Over-Board	
MSSI	Maritime Mobile Service Identity	Ship's Ident. No.
NF	Audio Frequency	
NMEA (0183)	National Marine Electronics Association	Interface- and data telegram standard
PLB	Personal Locator Beacon	
PS RAM	Averaging Random Access Memory	
PTT/SBS	Push-To-Talk/ Self Bearing Suppression	
RAM	Random Access Memory	
Rx	Receiver	
S/N	Signal to Noise	
SAR	Search And Rescue	
SNR	Signal to Noise-Ratio	
SQL	Squelch	
TFT	Thin Film Transistor (see also LCD)	
Tx	Transmitter	
VDC	Volts of Direct Current	
VTS	Vessel Traffic Service	