







# Table of Contents

<b>Device Overview</b>	2		
<b>Getting Started</b>	3		
Registration	3		
Log On	4		
Warning Screen	5		
On-screen Keyboard	6		
Status Bar	7		
Screen Calibration	8		
 <b>Home Menu</b>	9		
Home Menu Safe-driving Screen	10		
 <b>Mail</b>	11		
Inbox	12		
Attachments and Destinations	13		
Open Message	14		
Outbox	15		
Send Messages	16		
Options	17		
Mail Safe-driving Screen	17		
 <b>IntelliRoute®</b>	18		
Main Menu	18		
Truck Info	19		
Warnings	19		
General and Route Preferences	20		
Map Preferences	21		
Timers	22		
Trails	23-24		
		Route to Destination	25-26
		POIs	27
 <b>Hours of Service</b>	28		
Summary	29-31		
Duty Status	32		
HOS Safe-driving Screen	33		
Logs	34		
Options	35		
Company	36		
Graph Sub-tab	37		
List Sub-tab	38		
Summary Sub-tab	39		
Trip Info Sub-tab	40		
Anomalies Sub-tab	41		
HOS: A Day in the Life of a Driver	42-51		
 <b>SysInfo</b>	52		
Settings	53		
Programs and Diagnostics	54		
SysInfo Safe-driving Screen	55		
 <b>Stats</b>	56		
Driver Performance	57		
Fault Codes	58		
<b>Troubleshooting</b>	59		
<b>Connect Web Portal</b>	60		

# Device Overview

## Front Display

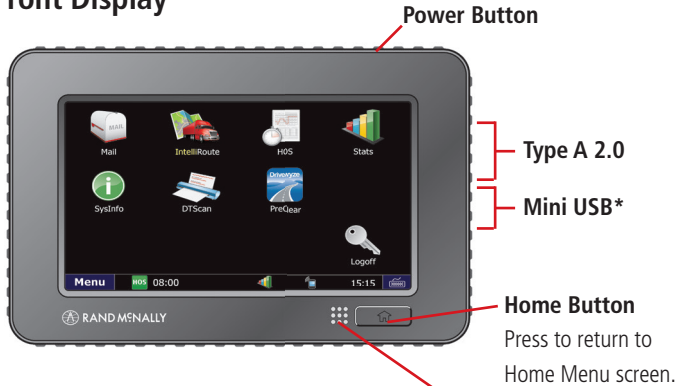

## Back of Device

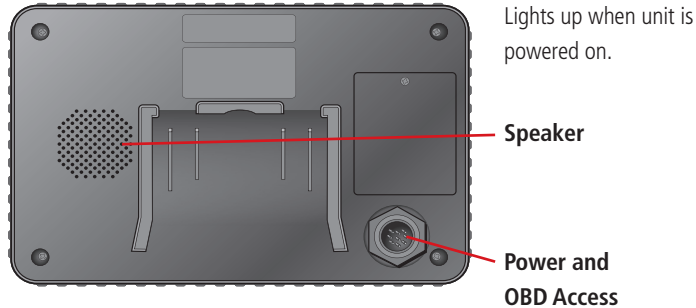

## Locking Collar Kit



## Cable Ties

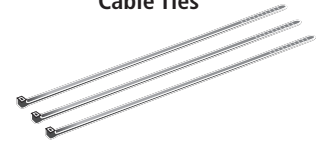

## Suction Cup Mount

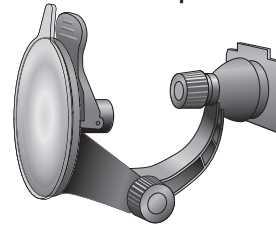

## 9-Pin Power Cable

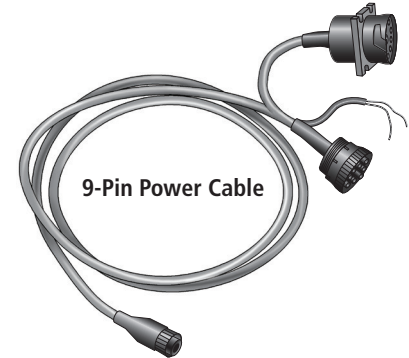

## Optional Screw Mount with Backing Plate

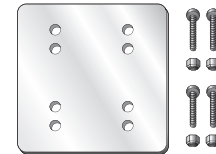
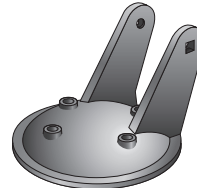

\*The USB port is used for data transmission only.

# Getting Started



## Device Registration Instructions

Once the unit has been activated and installed, please power the unit on. The Registration screen will display (this process may take a few minutes). Your *Data #* and *Serial #* will be pre-populated on the screen. At this time, you will be asked to enter a *Truck #*. This is the unique identification number for the vehicle in which your TND™ 765 is installed, and it can be whatever number you want to assign. Once you've entered the *Truck #*, press .

If your *Data #* shows up as "0" and you are unable to submit your *Truck #*, either the device has not been activated properly or it has not yet connected to the cellular network. If this occurs, please call **1-800-641-RAND (7263)** for assistance.

**NOTE:** Please write down your *Data #* and *Truck #* in the spaces provided below for future reference.

**Data # (pre-populated on your device):**

---

**Truck # (number of your choosing using only letters and numbers, no dashes or spaces, and up to 12 characters):**

---

# Getting Started

TND™ 765 Power Button

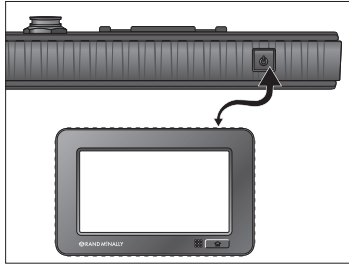

TND™ 765 Log On Screen

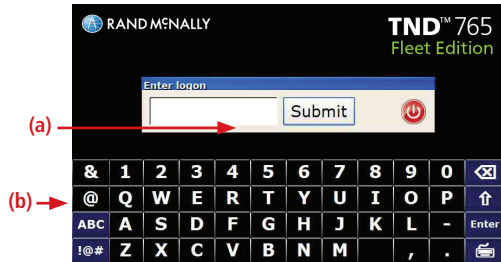

## Power On

Press the **Power** button on the top right of the device.

## Log On



The start-up screen displays a log on pop-up (a) and the on-screen keyboard (b).

- Enter your *Driver ID*.

**NOTE:** To log off, select the Logoff icon  on the Home Menu.

## Warning Screen



Icon	Definition
	Wi-Fi
	Cell

## Warning Screen

The Warning Screen reminds you that using the device while driving can be distracting. Be cautious.

- Tap **Continue** to complete the logon.

## Communication Status

**You must have a cellular or Wi-Fi connection to log on for the first time.**

- Locate the communication icon on the status bar. Icons and their definitions are shown in the table to the left.
- Tap the **keyboard** button in the bottom right corner of the keyboard if you cannot view the status bar.

**NOTE:** If you have a signal but still see errors (such as Invalid Logon), contact Rand McNally Customer Support.

# Getting Started

## On-screen Keyboard









## On-screen Keyboard

To use the keyboard:

- Tap the **keyboard** button (e) on the TND™ 765 status bar to display the keyboard.
- Tap the **ABC** or **!@#** buttons (a) to view alphanumeric characters and symbols respectively. The arrow button (c) on the right and the ABC screen on the left allow you to change between upper and lower-case letters.
- Tap the **Delete** button (b) to erase a character.
- Tap the **space bar** button to insert a space (f).
- Tap **Enter** (d) to type on the next line.
- Tap the **keyboard** button (e) again to hide the keyboard.

## Status Bar



Icon	Definition
	<b>Driver Performance.</b> Balloon messages appear over the icon to help you manage your performance. Messages are related to metrics such as over idling and speeding.
	<b>HOS.</b> The icon changes color according to your HOS status. The icon is green when you are within acceptable limits for each HOS status. The icon changes to yellow when you are nearing violation status and to red when you are in violation.
	<b>Mail.</b> The icon appears on the status bar when you have unopened mail.
	<b>Communications.</b> The icon shows your communication status (Wi-Fi, Cellular, No communication).
	<b>System message.</b> System alerts appear in balloon messages over the icon.
	<b>Cell.</b> The icon indicates the connection status of the cellular modem on the device.

## Status Bar

The status bar remains visible at the bottom of every screen and gives you access to current information about the TND™ 765.

Any status or alert icons are found on the status bar (a). Icons and their definitions are shown in the table to the left.

## The status bar also allows you to:

- Check your terminal time (b).
- Pull up the on-screen keyboard (c).
- Return to the **Home Menu** (d).

**NOTE:** You can also tap the **Home** button  on the unit to return to the Home Menu.

# Getting Started

---

## Calibrate Screen

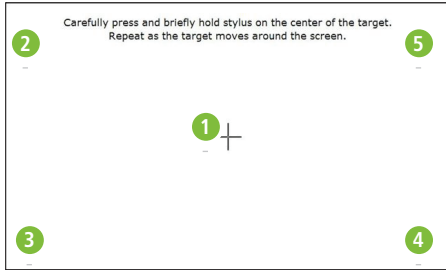

## Screen Calibration

To calibrate your screen:

- Press and hold the **Home** button  for 5 seconds. Calibration starts once button is released.
- Tap the center of the crosshairs as they appear on the calibration screen. There are five total.
  - Tap as close to the center of the crosshairs symbol (+) as possible.
  - Use the same pressure you normally use when tapping the screen.
  - If you receive an error, try again.

**NOTE:** Do NOT press and hold finger on the center of the crosshairs. Just tap.





Home Menu Screen

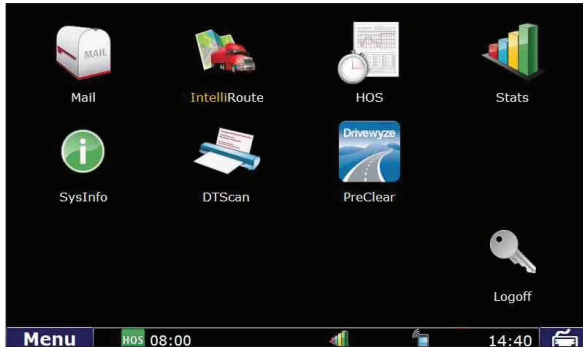







## Home Menu

The Home Menu is the home screen of the TND™ 765. The applications available to you on the TND™ 765 are identified by icons.

The icons on the Home Menu are explained in the table to the left.

- Press the Home button  to return to the Home Menu screen.

Icon	Function	Icon	Function
	View, listen and respond to messages.		Pinpoint location and find routes.
	Review, create and send logs.		View driver performance stats.
	Manage settings, tasks and communication.		Log off the TND™ 760.



# Home Menu

## Home Menu Safe-driving Screen

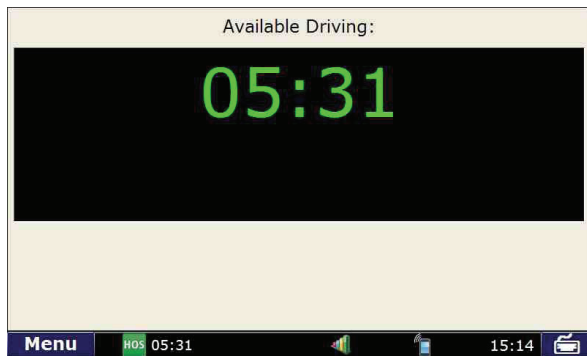

## Home Menu Safe-driving Screen

Menu options are limited while you are driving. When your truck is moving, the home menu safe-driving screen displays.

**NOTE:** Functionality within the Mail, HOS and SysInfo applications is simplified while you are driving.



## Mail Icon on Home Menu

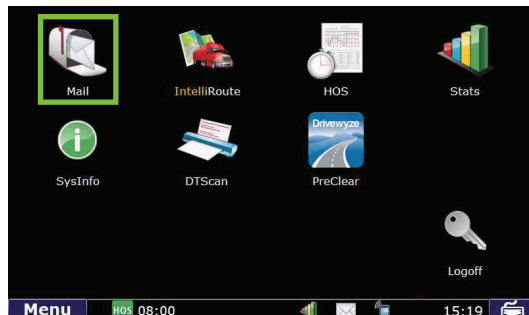

## Mail

Select the **Mail** icon on the Home Menu to access messages and send emails.

Mail opens to the *Inbox* tab.

Tab	Function
<b>Inbox</b>	Holds incoming messages.
<b>Outbox</b>	Holds outgoing messages.
<b>Send</b>	Allows you to send messages.
<b>Work</b>	Helps you process assignments.
<b>Options</b>	Displays your e-mail address and allows you to manage your e-mail contacts.



# Mail

## Inbox Tab

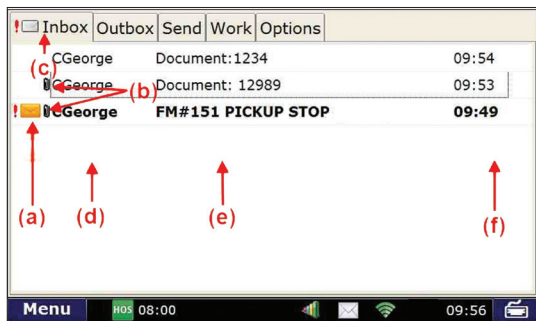

## Inbox

All incoming messages appear in your Inbox. Special features of the Inbox tell you details about your messages.

Status information is clustered together (a), (b) and (c).

- **(a)**. A blank space in this column means the message has been opened. An envelope means it has not been opened.
- **(b)**. A red exclamation point ( ! ) icon means the message is important. A paperclip (📎) icon means the message has an attachment.
- **(c)**. When you are working in another Mail tab, an envelope icon appears on the tab indicating that you have an unopened message.

Other columns in the Inbox tell you more about your messages (d), (e) and (f).

- **(d)**. This column tells you who sent the message.
- **(e)**. This column tells you the subject of the message.
- **(f)**. This column tells you when the message arrived.
  - The **time** displays for messages that arrived on the current day (based on your terminal time).
  - The **date** displays for messages that arrived on previous days.



## Attachments and Destinations

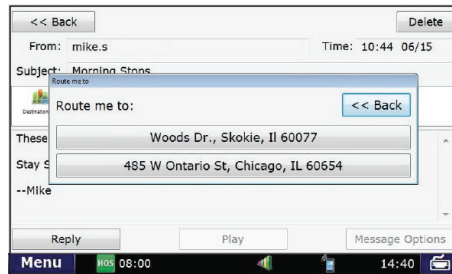

## Attachments and Destinations

Click on the paper clip icon () to view an attached document.

Click on the destination icon () to open a destination. A pop-up window will appear. If there is more than one destination, click the first one you want to route to. The IntelliRoute® navigation application will then automatically open, enabling you to begin your route.

Your Inbox holds 100 messages. When more messages arrive, the oldest messages in your Inbox are automatically deleted.



# Mail

## Open Message Screen

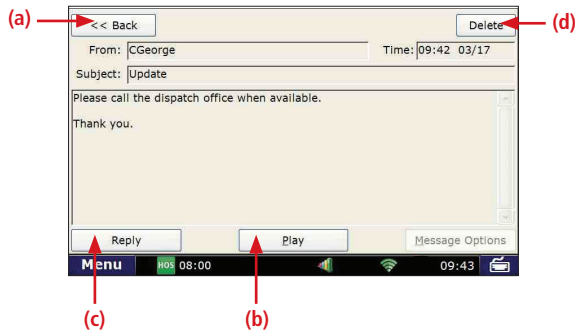

## Open Message

Select a message to open it.

Four action buttons are available once a message is open.

- **(a). Back** returns you to the Inbox.
- **(b). Play** lets you listen to the message.
- **(c). Reply** lets you send a response to the message.
- **(d). Delete** lets you delete the open message.

Your Inbox holds 100 messages. When more messages arrive, the oldest messages in your Inbox are automatically deleted.

## Personal Email Access

- If your driver settings are configured to enable personal email access, you can save up to 25 personal email addresses to communicate with while on the road.
- Personal emails are color-coded blue in your Inbox so you can identify them quickly. The color coding remains after the email is read.
- You can view your assigned email address by selecting the **Options** tab on the Mail screen and tapping the **View Email Address** button.



## Outbox Tab

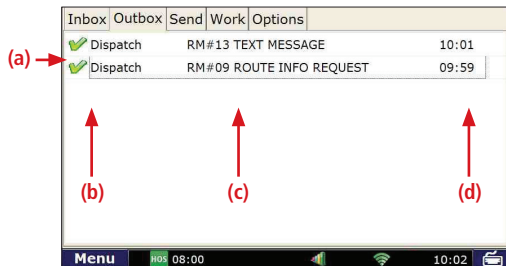

## Outbox

All outgoing messages appear in your Outbox. Special features of the Outbox tell you details about your messages.

Your Outbox holds 50 messages. When you have sent more than that, the oldest messages in your Outbox are automatically deleted.

- **(a)**. A green check mark ( ✓ ) icon means the message has been sent. An orange arrow ( ↶ ) icon means the message is waiting to be sent. A red X ( ✗ ) icon means the message has not yet been sent.

Other columns in the Outbox tell you more about your messages (b), (c) and (d).

- **(b)**. This column tells you who received the message.
- **(c)**. This column tells you the subject of the message.
- **(d)**. This column tells you when the message arrived.

-The **time** displays messages that were sent on the current day (based on your terminal time).

-The **date** displays for messages that arrived on previous days.



# Mail

## Send Tab

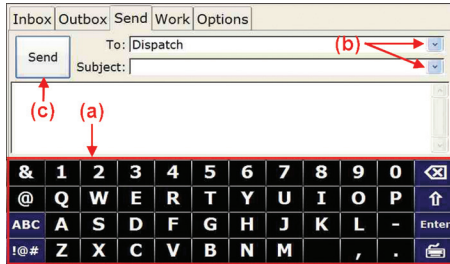

## Send Messages

You can send messages from the Send tab.

The on-screen keyboard (a) appears automatically when you select the Send tab.

Drop-down boxes (b) make it easy for you to complete the **To** and **Subject** fields.

- The **To** field automatically selects **Dispatch**. The drop-down box lists other saved contacts.
- You can fill in the **Subject** field by using either the drop-down list (if you want to send a form) or the on-screen keyboard (if you want to send a message). If you choose a form from the drop-down list, the screen displays the form in the message field (the body of the screen).

When you are done, tap **Send** (c).





## Options Tab

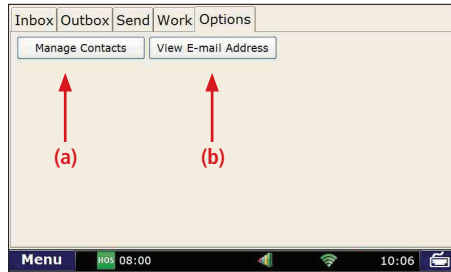

## Mail Safe-driving Screen

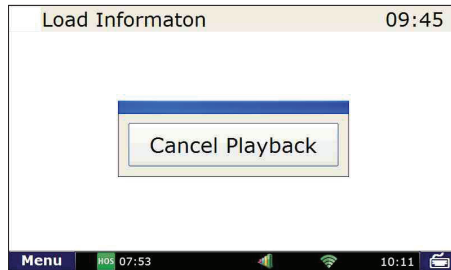

## Options

The *Options* tab has two buttons.

- **Manage Contacts** (a). This button lets you add contacts (for the list that displays in the **To** drop-down box on your Send message screen), request your contact list when you enter a new truck, and make changes to your contact list.
- **View Email Address** (b). This button lets you review your TND™ 765 email address.

## Mail Safe-driving Screen

When you select the Mail icon while vehicle is in motion, the mail safe-driving screen will appear. With the mail safe-driving screen, you can hear a message rather than read it.

- To hear a message, simply tap it to highlight it.
- To stop the message from playing, tap Cancel Playback on the screen.



IntelliRoute® Icon on Home Menu

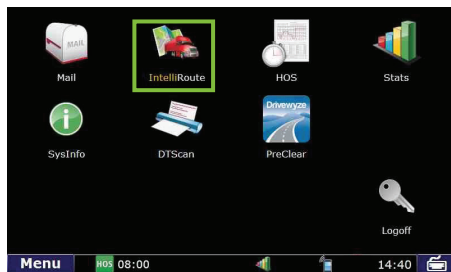

## IntelliRoute®

Select the **IntelliRoute®** icon on the Home Menu to access the truck-specific routing application. IntelliRoute® will route you around low bridges and truck-restricted roads, and help you find driver-specific Points of Interest (POIs).

IntelliRoute® Screen

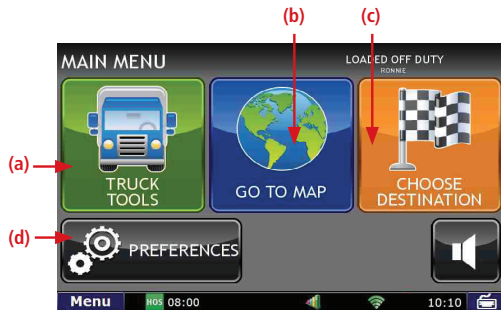

## Main Menu

- (a.) Enter truck information and access truck-specific use tools.
- (b.) Show location on the map and view navigation instructions.
- (c.) Choose a destination.
- (d.) Select general, route and map preferences.



Truck Info Screen

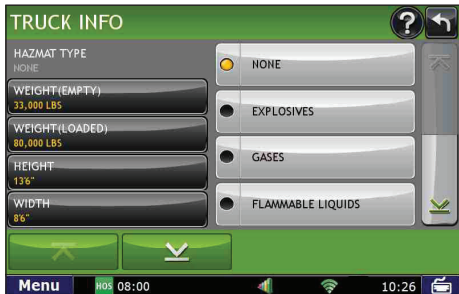



Warnings Screen





**Note:** Fleets can choose to configure Truck Info so that the information can only be entered and edited by fleet managers. If the icons on your Truck Info screen appear grayed out, this means your fleet has configured the setting this way.

Enter Truck Information

1. Tap **Truck Tools** > **Truck Info**.
2. Tap  and  to view all options.
3. Tap to select the options to be changed.
4. Enter new truck information settings.
5. Tap **Back** to save changes.

Set Warnings

1. Tap **Truck Tools** > **Warnings**.
2. Tap  and  to view all warning options.
3. Tap the option button to be changed.
4. Enter the new settings for the option.
5. Tap **Back** to save changes.





## General Preferences Tab



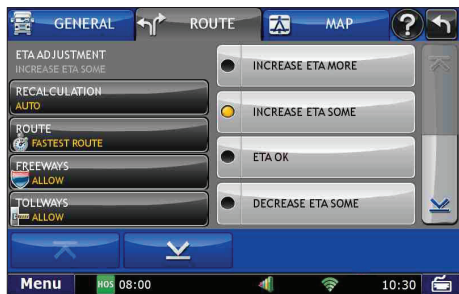

## Route Preferences Tab



## Set General Preferences

1. Tap **Preferences**.
2. Tap the **General** tab.
3. Tap  and  to view general device options.
4. Tap the option button to be changed.
5. Enter the new settings for the option.
6. Tap **Back** to save changes.

## Set Route Preferences



1. Tap **Preferences**.
2. Tap the **Route** tab.
3. Tap  and  to view route options.
4. Tap the option button to be changed.
5. Enter the new settings for the option.
6. Tap **Back** to save changes.



## Map Preferences Tab



## Set Map Preferences

1. Tap **Preferences**.
2. Tap the **Map** tab.
3. Tap  and  to view mapping options.
4. Tap the option button to be changed.
5. Enter the new settings for the option.
6. Tap **Back** to save changes.



## Timers Tab



**Note:** Odometers count up and record the current mileage. Maintenance counters count down. When a maintenance timer counts down to 2,000 miles, a reminder displays each time IntelliRoute® starts.

**Note:** To avoid timer warnings, set the timer limits to a very high number.

## Timers

1. Tap **Truck Tools**.
2. Tap **Timers, Trails**.
3. Tap the **Timers** tab.

On the left, use the **Change To** field to make adjustments to mileage or hours. The mileage/hours continue to count down from the changed value.

1. Tap **-** to decrease the setting.
2. Tap **+** to increase the setting.
3. Tap the calculator to display a keyboard. Enter a number and tap **Enter**.
4. Tap **Change**.

On the right, use the **Reset To** field to set the most common reset value, normally zero. At the beginning of each day or run, tap **Reset** to set the value back to zero for odometers and 15,000 or 35,000 for maintenance odometers.

1. Tap **-** to decrease the setting.
2. Tap **+** to increase the setting.
3. Tap the calculator to display a keyboard. Enter a number and tap **Enter**.
4. Tap **Reset**.



## Trails Screen



## Route Map Screen



## Trails

The Trails feature allows you to record and later view or follow route information on the map. This capability is particularly useful when driving off-road or through private facilities such as a terminal or distribution center where road data is not available.

### Record a New Trail

1. Tap **Truck Tools > Timers Trails**.
2. Tap **Trails Tab**.
3. Tap **New Trail**.
4. Tap **OK**. The Trail Icon  displays on the map screen.
5. When you wish to stop recording, tap on the Trail icon.
6. Tap **OK**.



## Trail Route Screen



## View Saved Trails

1. Tap **Truck Tools** > **Timers Trails**.
2. Tap **Trails Tab**.
3. Tap on the trail you want to run.
4. Tap on **Show on Map**.
5. Tap on the Trail icon. 
6. Tap:
  - **Trail Only** to show only the trail.
  - **Trail and Vehicle** to show the trail and your current location.
  - **Hide Trail** to not display the trail.
7. Visually follow the trail. The trail is denoted by green diamond icons.

### NOTE:

- Because Trails mode may not contain roads, no voice direction is available.
- You can also rename and delete recorded trails.





Enter City Name

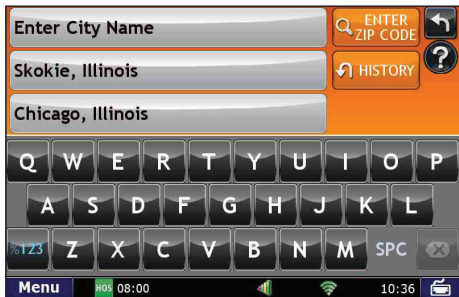

Destination Screen

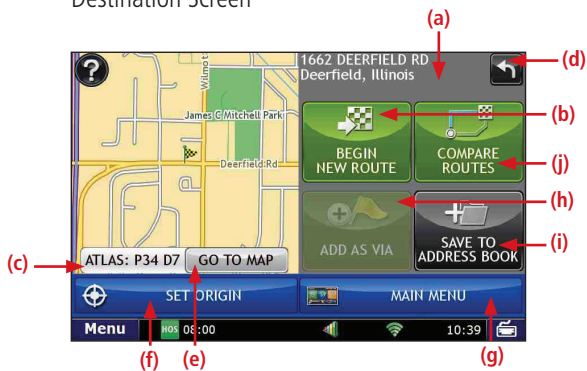

## Route to New Destination

### Find an Address

1. Tap **Choose Destination > New Location**.
2. Select a search type (**Address, City Center, Intersection, or Lat/Long**).
3. Use the keyboard to type location information.
4. Tap on the location in the displayed list.
5. Tap **Begin New Route**.

### Confirm Destination

- a. Destination address.
- b. Begin route to destination.
- c. Cross reference to printed Rand McNally *Motor Carriers' Road Atlas*.
- d. Return to previous window.
- e. View the map.
- f. Change the starting address for a route to the location displayed on the map screen.
- g. Return to Main Menu.
- h. Add the location as an interim stop between the origin and destination.
- i. Save location to the Address Book.
- j. View a primary route and a reasonable alternative, allowing you to choose. Both routes are presented on the map for a quick review.



## Address Book Tab



## Route Map Screen

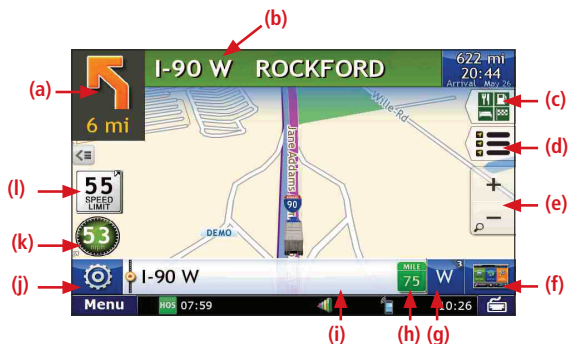

## Route to Saved Destination

1. Tap **Choose Destination** > **History** or **Address Book**.
2. Tap on the desired destination in the displayed list.
3. Tap **Begin New Route**.

## Route Map Screen

- a. Repeat spoken next-maneuver instructions.
- b. Name of street you will turn onto next.
- c. Information on upcoming exits.
- d. Directions slide-out list.
- e. Zoom in/zoom out.
- f. Return to IntelliRoute® Main Menu.
- g. Compass Direction. Tap to change map display: North (N), Heading Up (arrow) or 3D View (3).
- h. Current mile marker.
- i. Tap to view current information by city, street, or upcoming intersection.
- j. Tap to see current location information, change route settings, detour, or cancel a route.
- k. Current vehicle speed. Tap to view Virtual Dashboard.
- l. Posted speed limit: orange for truck limit; white for general limit.



## Point of Interest Screen



## Find a Point of Interest (POI)

1. Tap **Choose Destination** > **Points of Interest**.
2. Select a search type (**My Truck**, **City**, **My Route**, **End of Day**, **Destination**, **Custom POI**, or **Quick Stops**).
3. Select a category and if necessary, a subcategory.
4. Tap on the Point of Interest in the displayed list.



# Hours of Service

## Hours of Service Feature Overview

This section provides an overview of features on each screen of the HOS application.

### Service Cycle

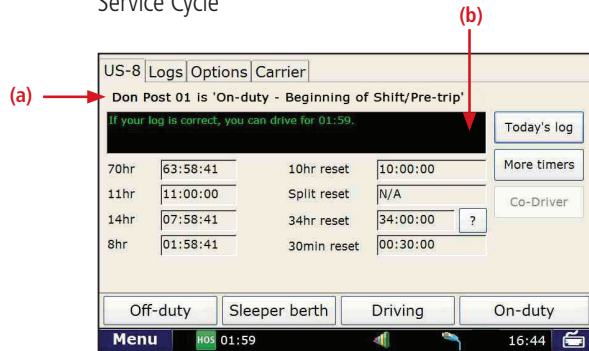

## Summary: Current Duty Status & Timers

The Service Cycle tab displays your timers, duty status and the time before you are in violation of each HOS rule.

- Title** displays your Driver ID and current duty status.
- Status Box** displays your effective remaining drive time. The effective remaining drive time displayed is the lesser of the times remaining in the current 8-hour On-Duty, 11-hour Driving, 14-hour On-Duty, and 70-hour On-Duty periods:
  - **Green** text means more than 1 hour drive time available.
  - **Yellow** text means 1 hour or less of drive time available.
  - **Red** text means you are out of drive time and will be in violation if you continue to drive.