



**FIXED BAND OFF-AIR REPEATERS
OR2-SBLP1 SERIES**

Doc. code 91 080 0730F - Rel. 04a

TECHNICAL HANDBOOK

*Radio Frequency Systems
Kabelkamp 20
30179 Hannover, Germany
Tel.: +49 511 676 2731
Fax: +49 511 676 2515
E-mail: sales.europe@rfsworld.com*

INDEX

1. FIXED BAND OFF-AIR REPEATERS - OR2-SBLP1 SERIES	2
2. OPERATING MODE	3
3. TECHNICAL SPECIFICATIONS	4
4. PROCEDURES FOR INSTALLATION AND POWER-UP	5
4.1. PLANNING INSTALLATION	5
• Selecting the position for the outdoor antenna	5
• Isolation between the antennas	6
• Repeater gain setting	6
4.2. MECHANICAL AND ELECTRICAL INSTALLATION OF THE REPEATER.....	7
• Initial check.....	7
• Positioning.....	7
• Connections	8
• How to set the repeater gain.....	8
4.3. POWER-UP.....	8
5. EXTRAORDINARY MAINTENANCE – TROUBLESHOOTING	9

ATTACHED DOCUMENTS:

- ILLUSTRATIVE DIAGRAM (ILL OR2-SBLP1 SERIES)
- SAFETY RULES
- STANDARDS
- ABBREVIATIONS AND ACRONYMS

1. FIXED BAND OFF-AIR REPEATERS - OR2-SBLP1 SERIES

Over the past decade, the growing diffusion of portable terminals has created the need for capillary coverage of the territory. Telecommunications networks must permit coverage services throughout the territory in the most extensive manner possible and, at the same time, guarantee the reliability and quality of the connection. From this point of view, the availability and quality of the services must be also guaranteed indoors, i.e. inside buildings.

OR2-SBLP1 SERIES has been designed specifically to improve cell coverage to indoor environments (indoor applications): offices, stores, parking lots, malls, airports and train stations.

Each equipment in OR2-SBLP1 series is dedicated to a mobile standard (please refer to TABLE 1).

OR2-SBLP1 SERIES REPEATER MODEL	STANDARD
OR2-SBLP1-S800	SMR (800MHz) iDEN
OR2-SBLP1-800	AMPS (800MHz) CDMA/TDMA
RFS OR2-SBLP1-900R	GSM-R (900MHz)
RFS OR2-SBLP1-900	EGSM (900MHz)
RFS OR2-SBLP1-1800	DCS (1800MHz)
OR2-SBLP1-1900	PCS (1900MHz)
OR2-SBLP1-S800-I	SMR (800MHz) iDEN
OR2-SBLP1-800-CELL	CDMA (800MHz)
OR2-SBLP1-900-I	SMR (900MHz) iDEN
OR2-SBLP1-1900-A/B/C	PCS (1900MHz)
OR2-SBLP1-1900-D/E/F	PCS (1900MHz)

TABLE 1

NB:

OR2-SBLP1 Off-Air Repeaters are fixed band. It means that each equipment is only able to improve the coverage of predefined and non-modifiable band of frequencies configured during manufacturing process. Center frequency and bandwidth (up to 4MHz for GSM-R standard, up to 25MHz for AMPS/PCS standards and up to 15MHz for GSM/DCS standard) are factory pre-set upon customer request.

2. OPERATING MODE

Off-Air Repeaters for indoor applications are connected, by means of coaxial cables, to two antennas. The 'donor antenna', an outdoor one, interfaces the equipment with the Mobile Operator's Base Transceiver Station (BTS). The 'service antenna', an indoor one, empowers the coverage of the indoor dead spot, and so it interfaces mobile terminals.

The signal to be enhanced follows two distinct paths (FIGURE 1). The up-link path, from mobile terminals to the BTS, and the down-link path, from the BTS to mobile terminals.

Along the down-link path, the outdoor antenna receives the signal from the BTS and then, by means of the connecting cable, delivers it to the repeater BTS connector (ILL OR2-SBLP1 SERIES, ref. 4). The cable coming from the outdoor antenna has to be earthed acc. to local/national regulations.

The repeater filters, amplifies and transmits the signal by feeder cable to the indoor antenna "filling" the indoor dead spot. Indoor antenna is connected to the repeater MS connector (ref. 7, ILL OR2-SBLP1 SERIES).

Along the up-link path, the indoor antenna receives the signal from the mobile terminals (MS) and delivers it to the repeater. The repeater filters, amplifies and transmits the signal by the outdoor antenna to Operator's BTS.

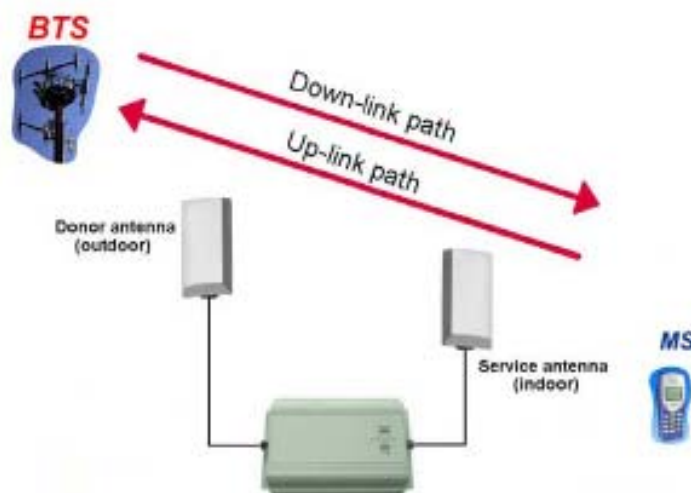

FIGURE 1 – DOWN-LINK and UP-LINK PATHS

OR2-SBLP1 series repeaters have got built-in attenuators to allow adjustable gain. DIP-switches (ref. 5 and ref. 6, ILL OR2-SBLP1 SERIES) are available to adjust the gain separately for up-link and down-link paths. During installation, equipment gain can be adjusted to reduce interference towards the BTS and to avoid problems related with the isolation between the antennas.

During operation, the equipment Automatic Level Control (ALC) protects against the emission of high intermodulation products, both in case that the user is in the nearby vicinity of the indoor antenna (ALC up-link) and in case of a temporary level increase of the signal coming from the donor antenna (ALC down-link).

3. TECHNICAL SPECIFICATIONS

FEATURE		OR2-SBLP1 SERIES REPEATER MODEL					
		OR2-SBLP1- S800	OR2-SBLP1- 800	OR2-SBLP1- 900R	OR2-SBLP1- 900	OR2-SBLP1- 1800	OR2-SBLP1- 1900
Frequency bands	Up-link	808-824 MHz	824-845 MHz	878-880 MHz	880-915 MHz	1710-1785 MHz	1850-1910 MHz
	Down- link	851-869 MHz	869-894 MHz	921-925 MHz	925-960 MHz	1805-1880 MHz	1930-1990 MHz
Amplified bandwidth		Up to 18MHz (customized upon Customer request)	Up to 25MHz (customized upon Customer request)	Up to 4MHz	Up to 15MHz (customized upon Customer request)		Up to 25MHz (customized upon Customer request)
Gain Attenuation Range / Step		30dB Up to 60dB / 1dB step					
Pass-band ripple		± 2dB					
Maximum output power (Up-link & Down-link)		12dBm (2 carriers)					
Noise figure at maximum gain		6dB					
Out of band gain Spurious / Total delay		Compliant to local regulations					
ALC (Automatic Level Control) range		20dB					
Power supply Power consumption		100-230Vac @ 50-60Hz / 24VA (AC/DC converter supplied with the equipment)					
RF connectors		N type female					
Temperature		+5 up to +50°C					
Dimensions (h-w-d)		220x150x40mm					
Weight		1.3kg					

All values are typical at 25°C unless otherwise specified.

Specifications subject to change without notice

3. TECHNICAL SPECIFICATIONS

FEATURE		OR2-SBLP1 SERIES REPEATER MODEL				
		OR2-SBLP1- S800-I	OR2-SBLP1- 800-CELL	OR2-SBLP1- 900-I	OR2-SBLP1- 1900-A/B/C	OR2-SBLP1- 1900-D/E/F
Frequency bands	Up-link	806-821 MHz	824-849 MHz	896-902 MHz	A 1850-1885 B 1870-1885 C 1895-1910 MHz	D 1885-1870 E 1885-1890 F 1890-1895 MHz
	Down-link	851-866 MHz	869-894 MHz	935-941 MHz	A 1930-1945 B 1950-1965 C 1975-1990 MHz	D 1945-1950 E 1965-1970 F 1970-1975 MHz
Amplified bandwidth		Up to 15MHz (customized upon Customer request)	Up to 25MHz (customized upon Customer request)	Up to 6MHz (customized upon Customer request)	Up to 15MHz (customized upon Customer request)	Up to 5MHz (customized upon Customer request)
Gain Attenuation Range / Step		30dB Up to 60dB / 1dB step				
Pass-band ripple		± 2dB				
Maximum output power (Up-link & Down-link)		12dBm (2 carriers)				
Noise figure at maximum gain		6dB				
Out of band gain Spurious / Total delay		Compliant to local regulations				
ALC (Automatic Level Control) range		20dB				
Power supply Power consumption		100-230Vac @ 50-60Hz / 24VA (AC/DC converter supplied with the equipment)				
RF connectors		N type female				
Temperature		+5 up to +50°C				
Dimensions (h-w-d)		220x150x40mm				
Weight		1.3kg				

All values are typical at 25°C unless otherwise specified.

Specifications subject to change without notice

4. PROCEDURES FOR INSTALLATION AND POWER-UP



- Before installing, carefully read the safety norms herewith attached.
- The equipment must be connected to ancillaries specifically designed for the standard in use and the band to be enhanced.
- The OR2-SBLP1 SERIES has been designed for indoor use only. Changes in temperature and humidity can influence the reliability of the equipment. The best place to install the equipment is a tempered and well-ventilated environment.
- A correct equipment installation and setting procedure requires a good knowledge and experience in installing telecommunication equipment. These activities should be performed by skilled personnel only. Remember that if the equipment is not installed correctly, it may:
 - cause a temporary failure in the BTS,
 - be damaged by excessively high input or output signal levels.

To install the equipment we strongly suggest to follow the steps described in the paragraph below.

4.1. PLANNING INSTALLATION

- **Selecting the position for the outdoor antenna**

The power of the signal coming from the outdoor antenna (donor antenna) has a direct influence on the efficiency of the indoor coverage. Therefore, it is extremely important to take care in choosing the position for this antenna and in installing it correctly.

Before installing the outdoor antenna, it is necessary to point the donor BTS to guarantee the best reception of signal to be enhanced. The best way to perform this activity is by connecting the donor antenna to a spectrum analyzer (or to a field intensity level measurement instrument) to evaluate the orientation and position of the antenna which can provide the best signal level.

It is strongly recommended to keep both antennas away from obstacles such as mountains, tall buildings or billboards.

It is furthermore recommended to use a directional outdoor antenna with, at least, 10dBi gain and to make sure, insofar as possible, that the antenna is pointing directly towards the BTS.

Please Note:

To obtain the best equipment performances, the outdoor signal must be stronger than -70dBm and must not go above -20dBm. If the outdoor signal is weaker than -70dBm, it is strongly recommended to use a high-gain directional outdoor antenna.

The ideal outdoor signal level is in the -60 to -70dBm range.

- **Isolation between the antennas**

Since the equipment is a bi-directional amplifier, the isolation between the outdoor antenna (donor) and the indoor antenna (service) must be at least 15dB greater than the repeater gain. For example, if the repeater gain is 60dB, the minimum isolation between both antennas must be greater than 75dB.

To guarantee the correct isolation between the antennas, it is necessary to plan for an adequate distance between them, both horizontally and vertically. Also walls and floors can be useful to increase the isolation between the antennas.

- **Repeater gain setting**

During installation, it is necessary to adjust the equipment gain. The right calculation of the gain to be set cannot be made without an evaluation of all the variables which characterize each installation.

The minimum gain value to be set on the up-link / down-link path is determined by considering the maximum output power and the maximum allowed input level of the equipment (-20dBm).

The balance between losses and gains for the equipment (link budget) permits adjusting the attenuation of the two paths (down-link / up-link), in order to reduce interferences towards the BTS and to avoid problems connected with the isolation between the antennas. Link budget also permits checking whether or not the output signals from the equipment (towards the BTS and towards the mobile terminals) are adequate.



PLEASE NOTE:

The repeater has been developed to operate at maximum gain. If attenuated, maximum output power will be reduced proportionally. ALC is always enabled.

It is strongly recommended to set the repeater gain at maximum level. Attenuation should be set only if antenna isolation is not enough (less than 75dB).

4.2. MECHANICAL AND ELECTRICAL INSTALLATION OF THE REPEATER

Upon completion of the planning stage, you can proceed with the installation of the antennas (indoor and outdoor) and then with the installation and power-up of the repeater.

Please remember: the OR2-SBLP1 SERIES is designed for indoor use ONLY.

- **Initial check**

Check the contents of the supply in terms on its completeness and/or eventual damage undergone by the material during transport.

The materials included in the supply are:

- OR2-SBLP1 SERIES equipment,
- External AC/DC adapter,
- Technical manual.

If there should be anything missing or damaged in the supply, you should notify the Sales Dept. of RFS, to facilitate the reinstatement and/or repair of the equipment involved.



Before beginning installation of the equipment, make sure that ON/OFF switch, ref. 3 (ILL OR2-SBLP1 SERIES), is in the OFF position. The green LED, ref. 2 (ILL OR2-SBLP1 SERIES), must be turned off.

- **Positioning**

To avoid damages to people, it is highly recommended to install the equipment at 2.5metres high positioning, in order to prevent electric shock caused by contact.

Position the OR2-SBLP1 SERIES equipment and fix its position with the four M4 bolts, which are to be inserted in the pre-cut slots, ref. A (FIGURE 2).

Check the correct positioning of the equipment before completely tightening the bolts.

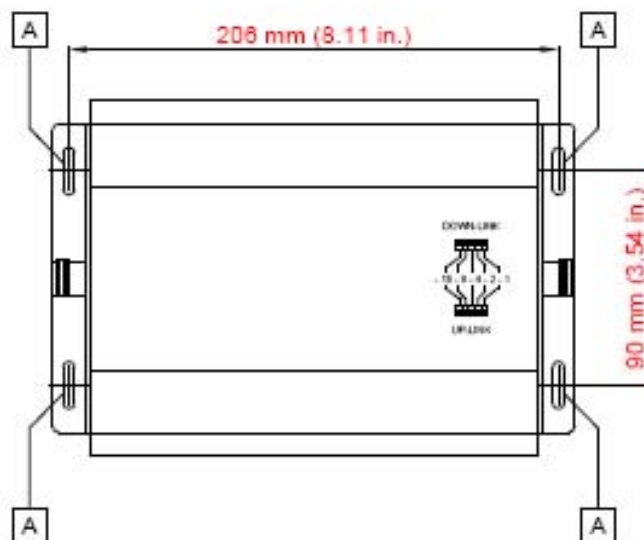

FIGURE 2 – POSITION OF THE PRE-CUT SLOTS

- **Connections**

- Connect the cable from the outdoor antenna to connector N (f) BTS side, ref. 4 (ILL OR2-SBLP1 SERIES).
- Connect the cable from the indoor antenna to connector N (f) MS side, ref. 7 (ILL OR2-SBLP1 SERIES).
- Connect the power supply connector for the external AC/DC adapter (standard supply) to the power supply socket connector of the equipment, ref. 1 (ILL OR2-SBLP1 SERIES).
- Connect the power supply plug of the external AC/DC adapter (standard supply) to the line power source corresponding to the specs of the equipment (i.e. 100-230V A.C.).

For the connections, it is recommended that an RF cable having characteristics similar to the RFS cable type LCF14-50, be used.

- **How to set the repeater gain**



PLEASE REMEMBER:

It is strongly recommended to set the repeater gain at maximum level. Attenuation should be set only if antenna isolation is not enough (less than 75dB).

The OR2-SBLP1 SERIES equipment comes with selectors which permit separately adjusting the gain for both up-link and down-link paths. The maximum gain for the equipment is 60dB (typical). The attenuation of the gain can be adjusted in the 0÷30dB range with steps of 1dB.

The variations to be made to the gain on the up-link and down-link paths are determined during link budget calculation stage (ref. paragraph 4.1).

Please set the gain as shown in FIGURE 3 (Example of gain adjustment).



Path	Attenuation (see Figure)	Gain
Down-link	0dB	60dB
Up-link	0dB	60dB

Path	Attenuation (see Figure)	Gain
Down-link	20dB	40dB
Up-link	25dB	35dB

FIGURE 3 – EXAMPLE OF GAIN ADJUSTMENT ON THE UP-LINK AND DOWN-LINK PATHS

4.3. POWER-UP

Once all connections have been performed and the gain has been set, turn on the equipment by moving the switch indicated with ref. 3 (ILL OR2-SBLP1 SERIES) to the "ON" position.

Green LED, ref. 2 (ILL OR2-SBLP1 SERIES), will light up to indicate the presence of the power supply voltage.

Also by using the mobile phone, make sure that the RF signal is available and adequate in the area of equipment coverage.

If there should be problems, please refer to the following paragraph (troubleshooting).

5. EXTRAORDINARY MAINTENANCE – TROUBLESHOOTING

The diagrams below describe the steps to be taken in troubleshooting, i.e. the series of operations which, in case of equipment malfunction, permit the end-user to identify, and if possible, eliminate the causes of the fault.

PROBLEM ENCOUNTERED		STEP
GREEN LED (ref. 2, ILL OR2-SBLP1 SERIES) IS OFF		1
NO INDOOR SIGNAL	GREEN LED (ref. 2, ILL OR2-SBLP1 SERIES) IS OFF	2
	GREEN LED (ref. 2, ILL OR2-SBLP1 SERIES) IS ON	3
INDOOR SIGNAL IS TOO WEAK		4
INDOOR SIGNAL IS PRESENT, BUT YOU CANNOT MAKE A PHONE CALL		5
INDOOR SIGNAL IS NOT STABLE		6

TABLE 2 – PROBLEM SOLVING – REFERENCE TO THE STEPS FOR TROUBLESHOOTING

The following symbols are used in the diagrams:



Interrogation box



*Action box
(controls or checks)*

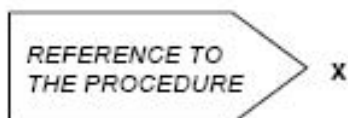

*Re-direction box to other procedures
"x" identifies the procedure*

PROCEDURE 1

PROBLEM	GREEN LED (ref. 2, ILL OR2-SBLP1 SERIES) IS OFF
---------	---

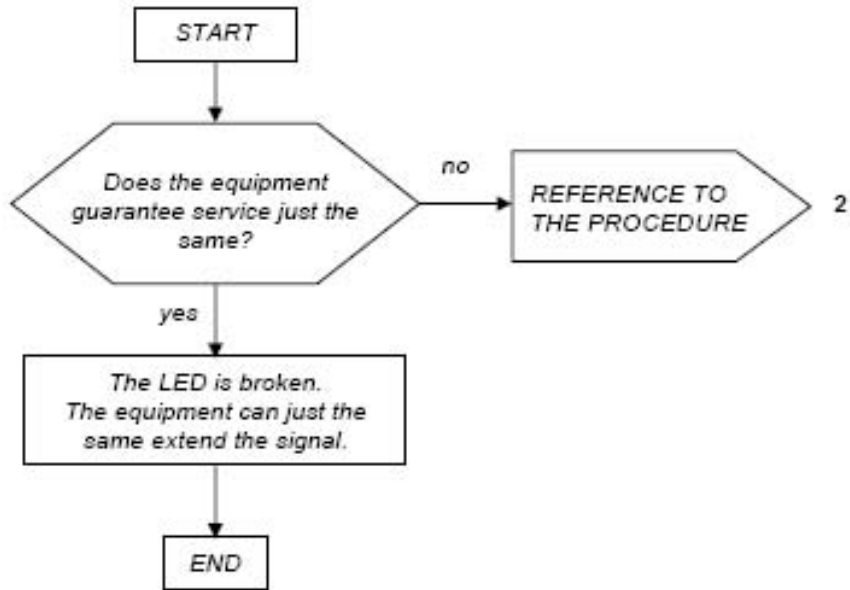

PROCEDURE 2

PROBLEM	NO 'INDOOR' SIGNAL
	The GREEN LED (ref. 2, ILL OR2-SBLP1 SERIES) IS OFF

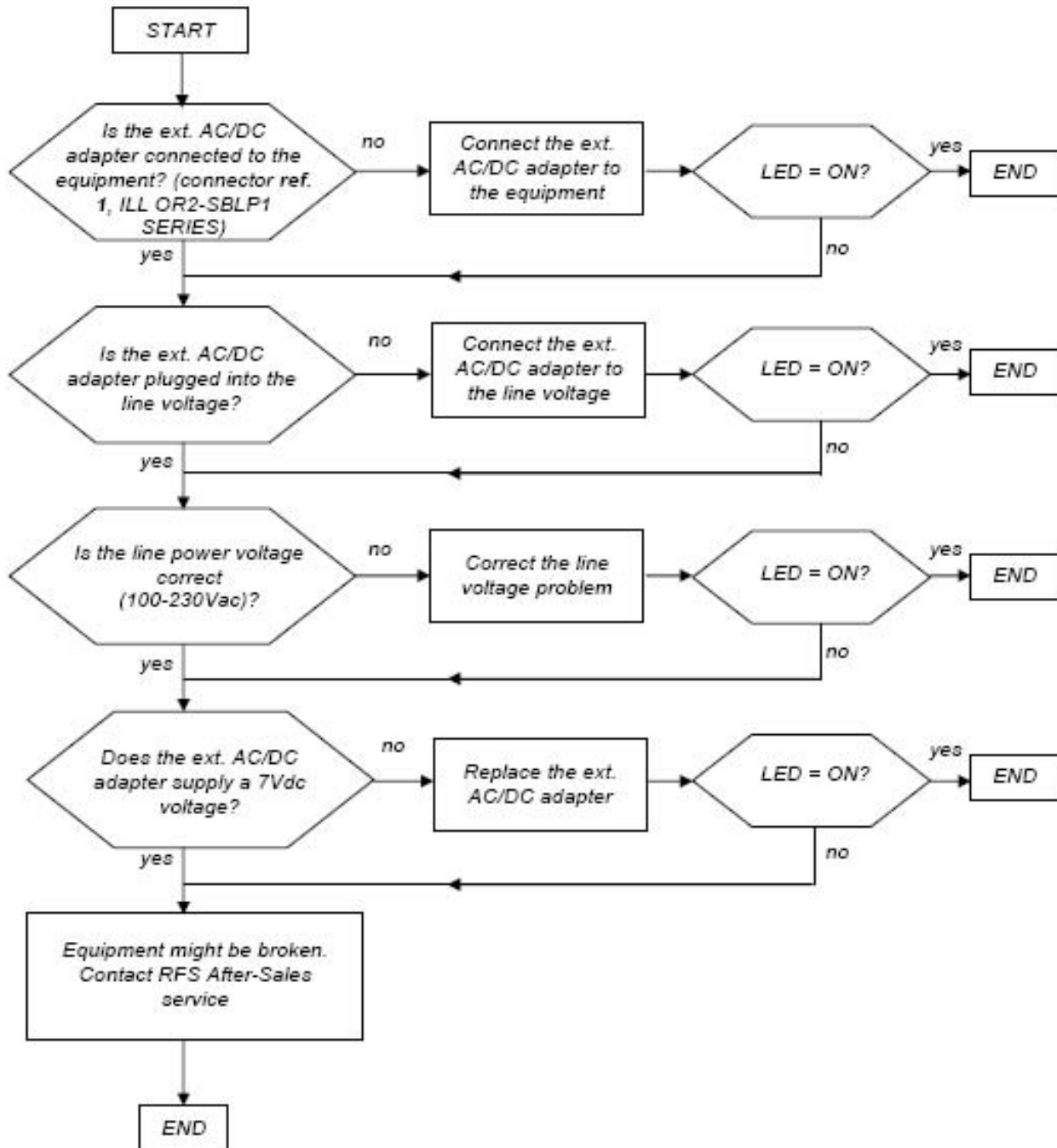

PROCEDURE 3

PROBLEM	NO INDOOR SIGNAL
	The GREEN LED (ref. 2, ILL OR2-SBLP1 SERIES) = ON

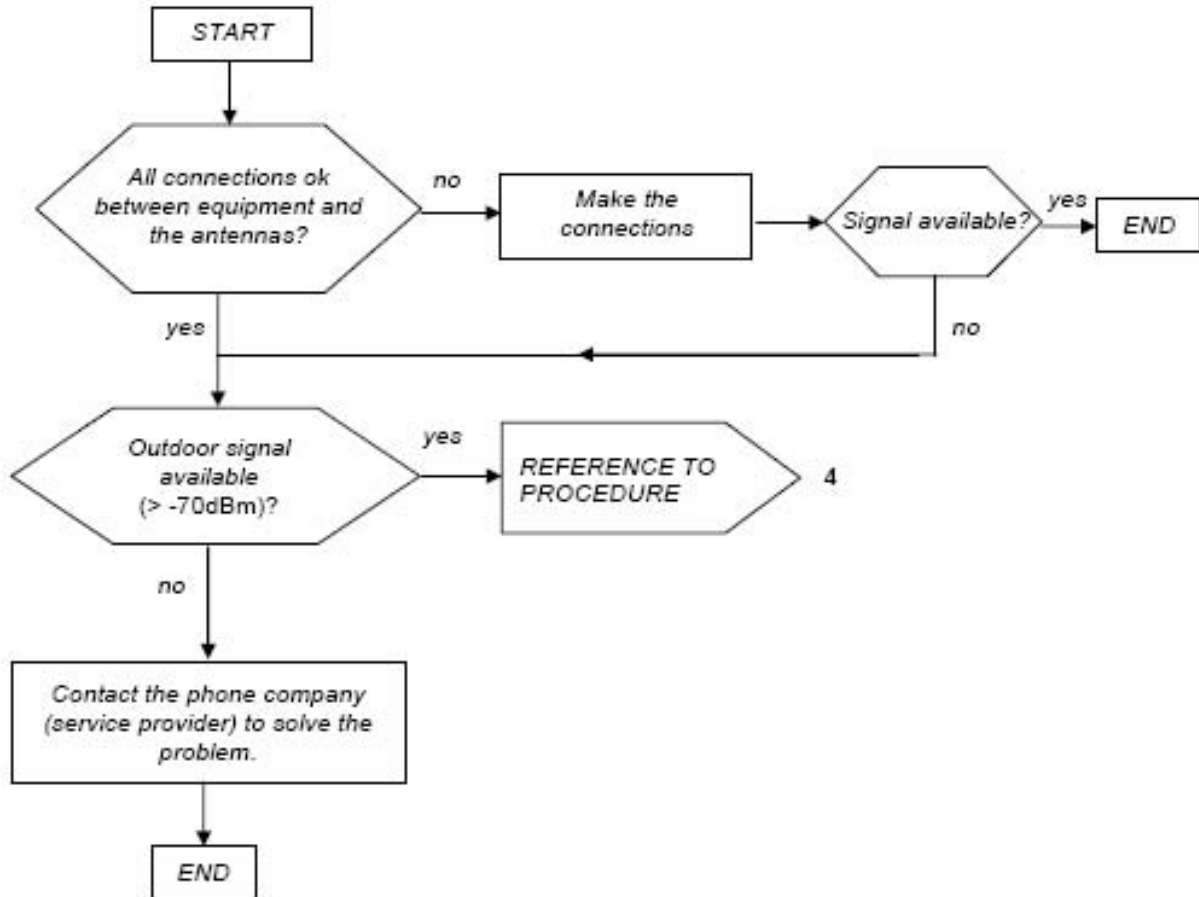



PROCEDURE 4

PROBLEM	INDOOR SIGNAL is too WEAK
----------------	----------------------------------

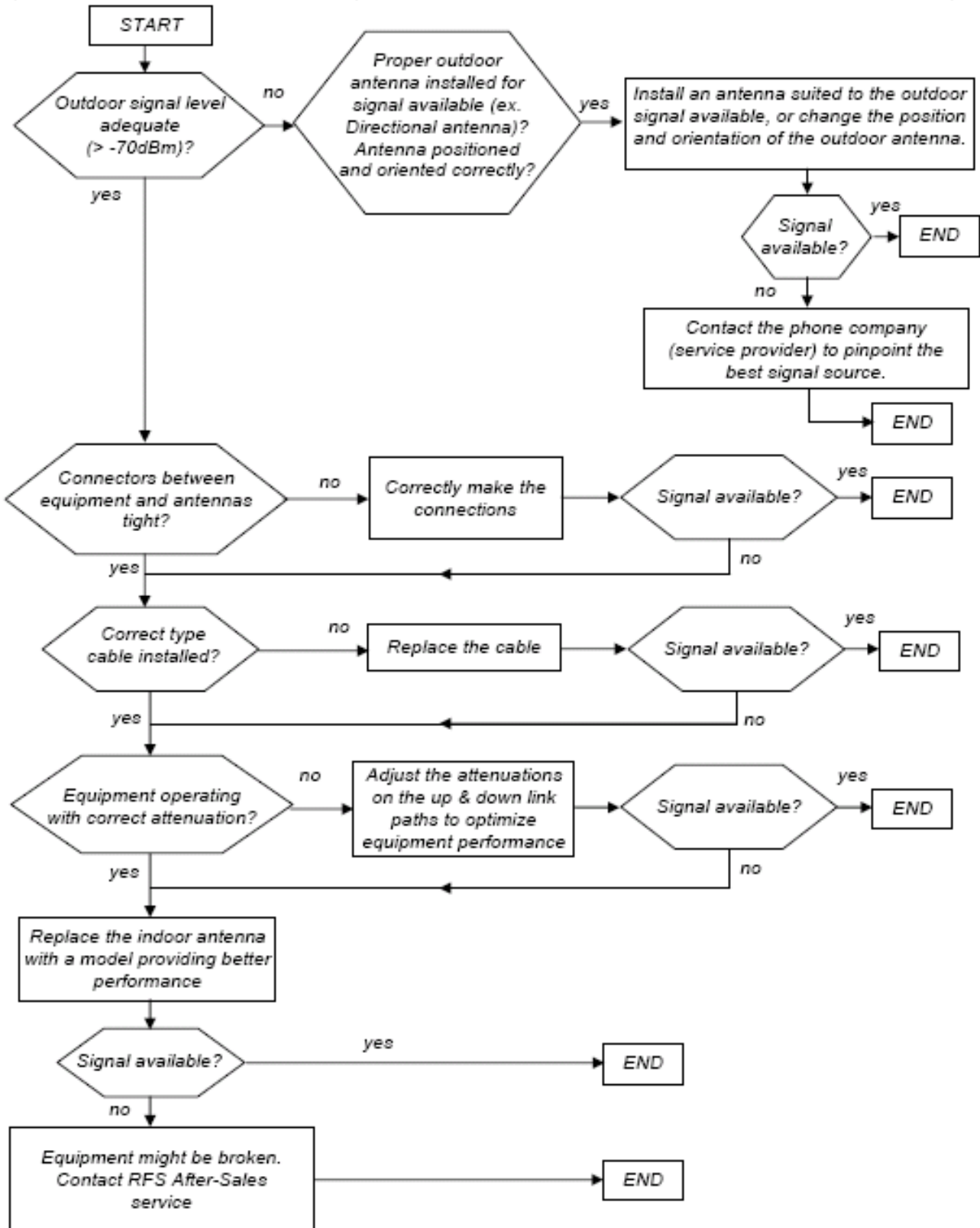

PROCEDURE 5

PROBLEM	INDOOR SIGNAL IS PRESENT, BUT YOU CANNOT MAKE A PHONE CALL
---------	--

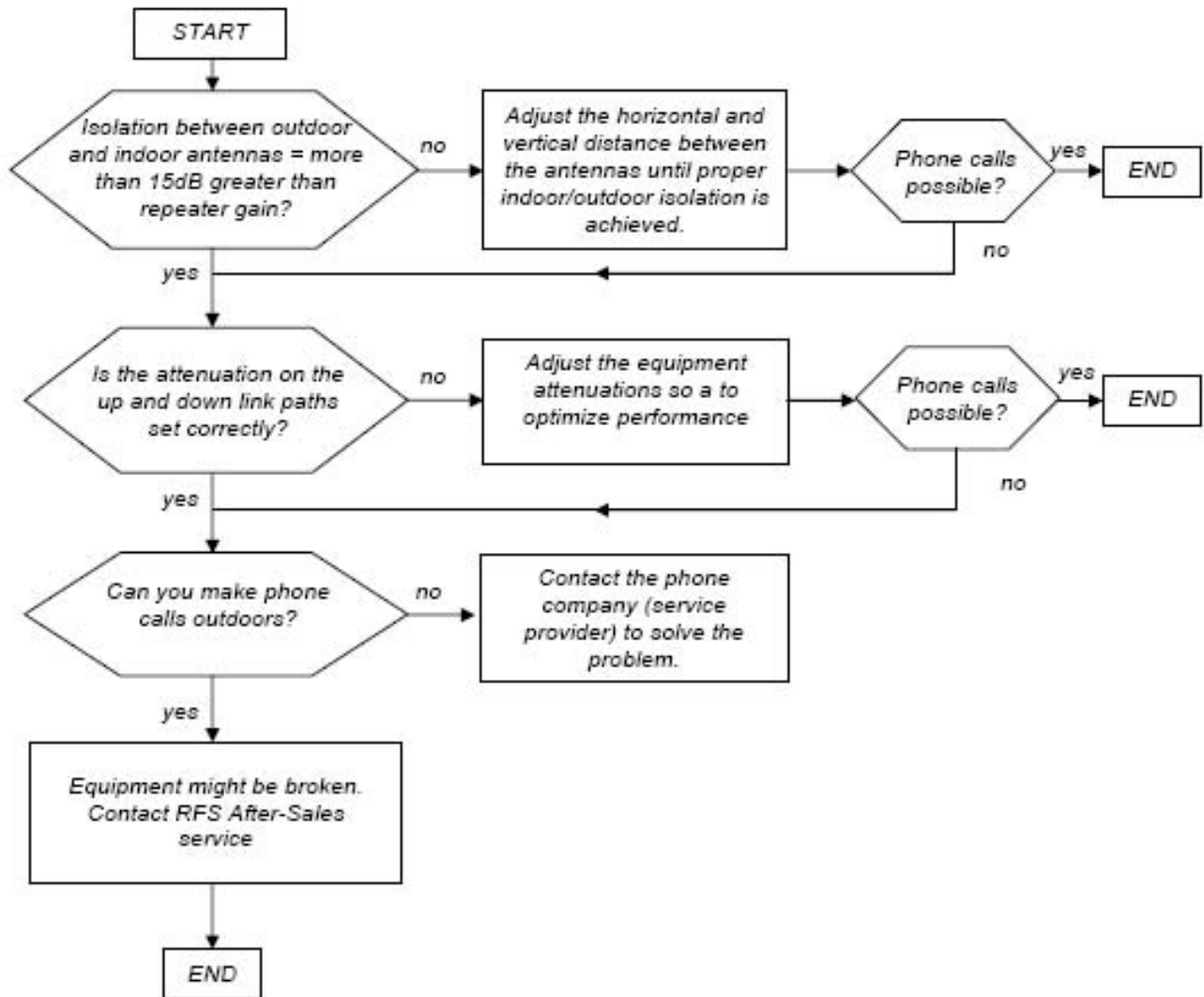

PROCEDURE 6

PROBLEM	INDOOR SIGNAL IS NOT STABLE
---------	-----------------------------

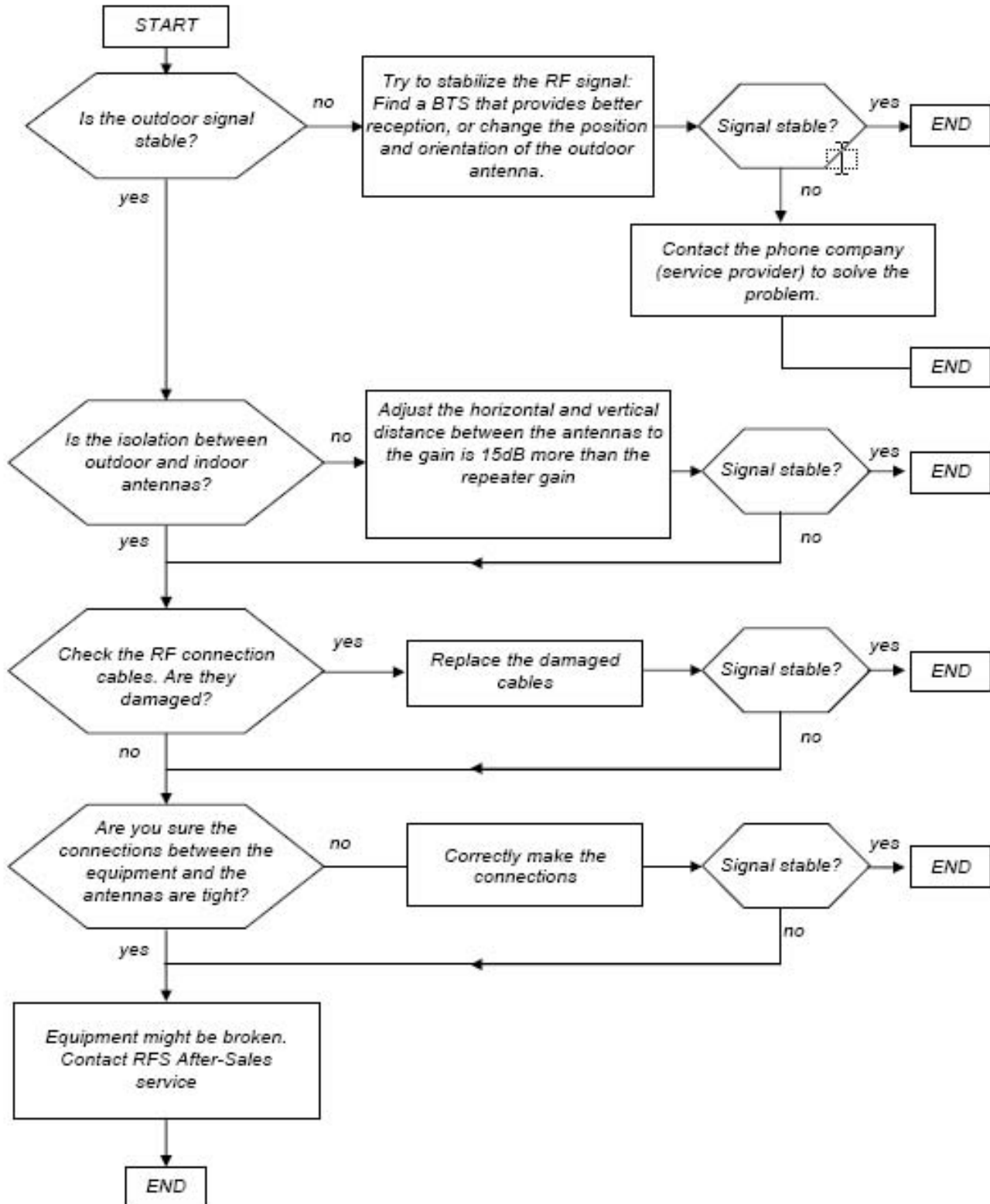



***ATTACHED
DOCUMENTS***

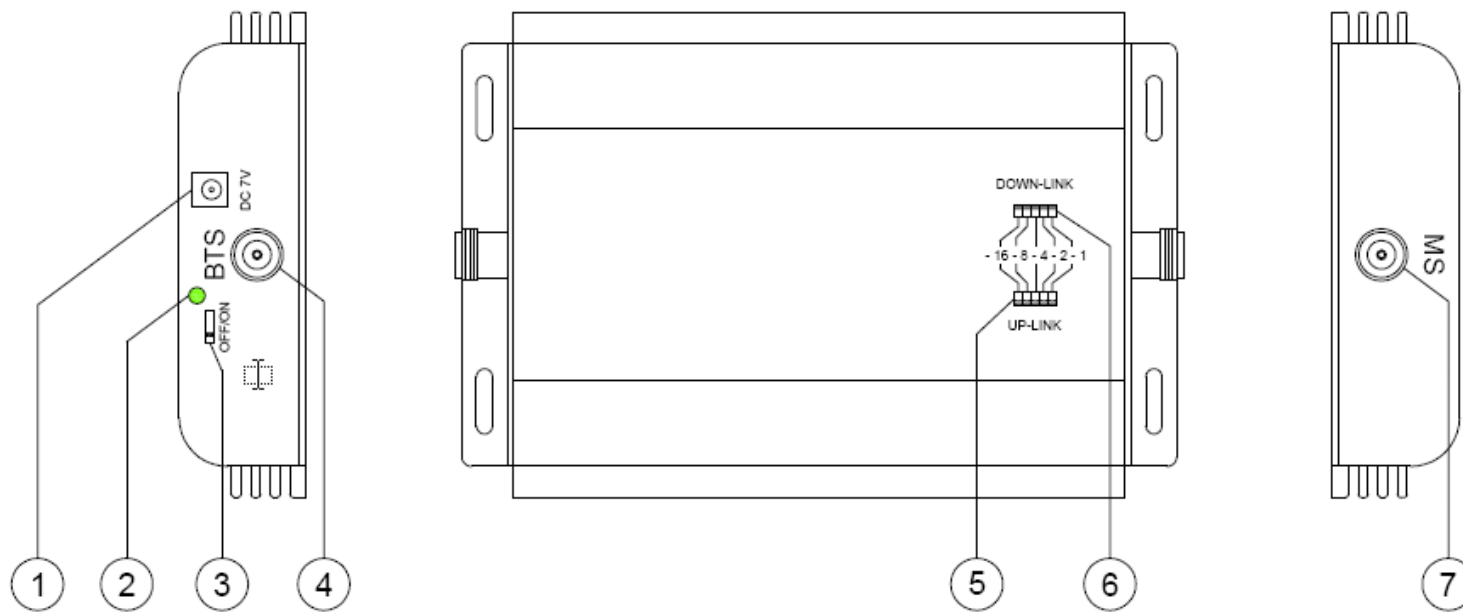

ACCESS POINTS MAP	
Rif./ Ref.	DESCRIPTION
1	Vdc input
2	GREEN LED ON: Vdc available
3	ON/OFF switch
4	BTS side N (f) connector
5	UP LINK path gain adjustment DIP Switches
6	DOWN LINK path gain adjustment DIP Switches
7	MS side N (f) connector

Part Number ILL OR2-SBLP1 SERIES	Title OR2-SBLP1 SERIES ACCESS POINTS MAP	Date ED. 01-1 13/11/2008
		Drawn by CG
		Checked by MN
Scale 1:1	Revisions	Approved by AV
Copyright protection according to law		Sheet 1/1

1) SAFETY RULES

1.1 Introduction

The equipment described in this technical handbook has been designed and tested in conformity of international safety standards IEC215 / EN60215 and IEC950 / EN60950; the equipment has to be used under the responsibility of specialised personnel only. In accordance with IEC215 / EN60215, adjustment, maintenance and repair of the exposed equipment shall be carried out only by qualified personnel, who are aware of the hazards involved. The minimum qualifications are established in the standard.

Final installation of the systems must fulfil the EMF emission levels, as requested by regulations in force (recommendation n. 1999/519/EC).



WARNING: Installation Notes

Modular equipment, intended to be housed inside a rack cabinet, must be installed within a protected access area only.

This area must be opportunely protected by security system that will exclude the entry, even if accidental, to not authorized and trained personnel. Alternatively, the cabinet, in which the equipment is housed, must be closed on all sides, to allow the access to internal parts to authorized personnel only.

1.2 AC Power supply

When working on the equipment always make sure that the equipment is not connected to the mains supply.

Before power up always make sure that the equipment is connected to earth by using the equipment grounding bolt.

If it is necessary to fit an AC power supply plug to power cable, the User must observe the following colour codes: LIVE terminal to BROWN lead NEUTRAL terminal to BLUE lead EARTH terminal to GREEN/YELLOW lead. The User must also ensure that the protective earth wire would be the last to break, should the cable be subject to excessive strain.

1.3 Safety precautions

For the correct and safe use of the equipment it is essential that both operation personnel and services personnel follow generally accepted safety procedures (see IEC Publications 215: "Safety measures for radio transmitting equipment" and 61010-1: "Safety requirements for electrical equipment for measurement, control, and laboratory use") in addition to the safety precautions specified in this technical handbook. Specific warnings and caution statements, where applicable, can be found throughout this technical handbook. Warning and caution statements and/or symbols are marked on the equipment where is necessary. (see also ANNEX n°1).

As far as the equipment safety devices are concerned please remind that: -periodic functional check shall be carried out on protective devices; -functional check shall be carried out on protective devices, when they have operated under fault conditions; -safety devices shall not be altered or disconnected except for replacement; -safety circuit shall not be modified.



1.4 Caution and warning statements

Caution It's used to indicate the correct operation and maintenance, in order to prevent damage or destruction of equipment or other property. Warning of danger Used to indicate the potential hazard that requires correct procedures or practices in order to avoid personal injury.

1.5 Impaired safety protection

Whenever it is likely that safe operation is impaired, the apparatus must be in-operative and secured against unintended operation. The appropriate servicing staff authority must be informed.

For instance, the safety is likely to be impaired if the equipment fails to perform the prescribed measurements, or shows visible damages.

1.6 Electrostatic sensitive devices

In case of electrostatic sensitive devices (for instance all ICs and many other semiconductor devices belong to this class) it is essential to use a right protection to reduce the risk of personal injury. Careless handling, during repair, may imply life danger. When repairing, make sure that you are connected with the same potential as the ground of the equipment by means of the right devices, i.e. a GIRDLE (a wrist wrap with resistance) and a WINDING CORD to be connected to the girdle and to the relevant socket placed on the equipment.

You must also keep components and tools at this potential.

1.7 Electrolytic Capacitors

Non-solid electrolytic capacitors must not contain chemicals, which may be regarded as hazardous, if incorrectly handled. Caution is necessary, should the outer case be fractured.

1.8 Electric shock

In case of electric shock it is recommended not to touch the person before breaking the circuit by means of the power supply switch; should it be not possible to break the circuit power supply it would be advisable to try to rescue the person by means of some insulating materials: e.g. a wood stick, a nylon cord or a suitable service made of plastics, etc.

NEVER TOUCH ELECTROCUTED PEOPLE WITH YOUR HAND AS LONG AS THEIR BODIES ARE SUBJECTED TO VOLTAGE, OTHERWISE YOU TOO WOULD GET ELECTOCUTED.

Call the doctor and then immediately perform the artificial respiration as described here below:

Lay the patient on his back with his arms parallel to his body; if the patient lies on an inclined plane, please make sure that his stomach be slightly lower than his breast. Open the patient's mouth and check if there are foreign bodies. Kneel down near the patient at the same level as his head's, put one of your hands under his head and the other one under his neck. Lift the patient's neck and let his head fall backwards the most possible.



Shift your hand from the patient's neck to his chin; put your thumb between his chin and his mouth, your forefinger along his jawbone, keep your other fingers tight. By doing these operations start the self-oxygenation by means of deep breathings in standing open-mouthed. With your thumb between the patient's chin and his mouth, keep the patient's lips closed and blow into his nasal cavities.



During these operations see if the patient's breast rises. If it is not so, his nose may be obstructed; in this case, by levering on his chin with your hand, open the patient's mouth, put your lips on and blow into his oral cavity. Look at the patient's breast and see if it rises. One can use this second method instead of the first one also if the patient's nose is not obstructed, provided that his nose be occluded by squeezing his nostrils with your hand after shifting it from his head. The patient's head must be kept bent backwards the most possible.



Start with ten fast and deep expirations, then go on at the rhythm of twelve/fifteen expirations per minute. Continue as long as the patient has recovered consciousness, or a doctor has ascertained his death.

1.9 Burns

As far as burns are concerned:

- Don't try to take off clothes from the burnt parts;
- Pour some cold water on body burnt areas and ask immediately for a doctor;
- Don't apply ointments or oily tinctures.

ANNEX 1

When the equipment or the modules are equipped with the labels as shown here below, it is essential to observe the warnings contained

-LIVE VOLTAGE POINT



-PROTECTIVE EARTHING TERMINAL

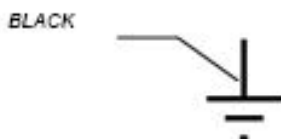

-CLASS 1 LASER PRODUCT

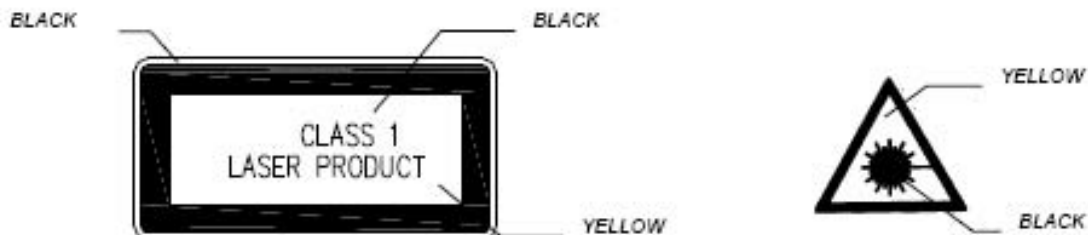

*EXPLANATORY LABEL
(affixed to the CLASS 1 product side)*

*WARNING LABEL
(affixed to the CLASS 1 product front)*

Products which are of CLASS 1 as defined in the IEC EN 60825-1, fourth edition "Safety of laser products -Part 1: Equipment classification, requirements and user's guide". Even if the product is of CLASS 1, please observe the following safety procedures, prescribed in the cited norm:

- do not observe directly the laser beam,
- do not use observation optics (lens, microscopes, telescopes, etc.),
- do not expose eyes directly.

-DEVICES SENSITIVE TO THE ELECTROSTATICS

WARNING: Please observe the due precautions in handling devices which are sensitive to the electrostatics.



-NON-SOLID ELECTROLYPTIC CAPACITORS MAY CONTAIN CHEMICALS TO BE REGARDED AS HAZARDOUS, IF INCORRECTLY HANDLED.

WARNING

THE MAXIMUM CAUTION IS REQUIRED IF THE OUTER CASE IS FRACTURED



2) STANDARDS - BAR CODE LABELS



Fig. 1

Label fields (ref. Fig.1):

- a) **Serial number:** this field contains the serial number (made up of a 7-digit sequential group) of the module or equipment.
- b) **F (final test tracing out):** this field contains an F letter that has been barred to certify that the item has been successfully tested in the factory Final Test Dept.
- c) **Customer order reference.**
- d) **Equipment acronym or production part number.**
- e) **ICS (Item Change Status):** this field contains the item ICS, made up of 2 digits, starting from 01, of the production part number or equipment.







































Fig.2 shows an example of bar code label applied:































Fig. 2

2.1) SYMBOLS

EQUIPEMENT FRONT SYMBOLS

SYMBOLS	DESCRIPTION	SYMBOLS	DESCRIPTION	ISYMBOLS	DESCRIPTION
	Earth connection		Impulsive command		Band-stop filter
	Ground		Fuse		Low-pass filter
	Chassis ground		Thermal breaker		High-pass filter
	AC		Failure		Modulator, demodulator
	DC		Overtemperat.		Stereo
	Pulse current		Output monitoring signal		Balance
	Battery / accumulator		Input monitoring signal		Amplifier
	Positive connector		Direct power monitoring socket		Adjustable gain amplifier
	Negative connector		Reflected power monitoring socket		Loudspeaker connection
	OFF		Local oscillator monitoring socket		Audio connection
	ON		Gating as opening criterion		Headphone connection
	STAND-BY		Gating as closing criterion		Stereo headphone
	ON push-button		Channel / band filter		Star connection

EQUIPEMENT FRONT SYMBOLS





























SYMBOLS	DESCRIPTION	SYMBOLS	DESCRIPTION	SYMBOLS	DESCRIPTION
	Delta connection		Receiving antenna		Dual sound
	High voltage		Linearization		
	Start push-button		Limiter upper threshold		
	Local, manual command		Limiter lower threshold		
	Automatic		Adjusting		
	OFF / inhibited (function)		Max adjusting		
	ON / active (function)		Min adjusting		
	Stand-by (function)		Adjusting		
	Output connector		Frequency adjusting		
	Input connector		Xtal adjusting		
	Clock display (operation time counter)		Freq. tuning		
	Fan, blower		Amplitude tuning		
	Antenna		Band tuning		
	Transmission antenna		Mono		



BLOCK DIAGRAM SYMBOLS

SYMBOLS	DESCRIPTION	SYMBOLS	DESCRIPTION	SYMBOLS	DESCRIPTION
	Linear variability		2-way switch		NAND general symbol
	Automatic adjustment		Voltage control electromagnetic relay		NOT general symbol
	Combiner general sign		Trasfomatore Transformer		Preemphasis
	2-way power divider		Rectifier general symbol		Deemphasis
	2-way power combiner		DC/DC converter		Delay line general symbol
	3-way power divider		Bridge rectifier		Coaxial type time delay limiter
	4-way power divider		Voltage regulator		Resistive attenuator
	3dB Hybrid		Zener regulator		Pad
	White limiter		Constant current bias device		Fixed phase shifter
	Positive peak clipper		Sinusoidal oscillator		Thermal switch
	Negative peak clipper		Ex-OR		Band-pass filter
	Circulator		OR general symbol		Band-stop filter
	Isolator		NOR general symbol		Low-pass filter
	Switch		AND general symbol		High-pass filter

BLOCK DIAGRAM SYMBOLS

SYMBOLS	DESCRIPTION	SYMBOLS	DESCRIPTION	SYMBOLS	DESCRIPTION
	Divider by n		DC-amplifier		Optical amplifier
	Multiplier by n		Differential comparator		
	Mixer general symbol		Phase comparator		
	Up-converter from IF to RF		Detector amplifier		
	Down-converter from RF to IF		Lamped to the synchronizing signal peak		
	Voltage / frequency converter		Schmitt's trigger		
	Directional coupler		Amplitude linearity precorrector		
	Double directional coupler		Amplitude limiter without distortion		
	Directional coupler with double detector		Equalizer general sign		
	Detector		Amplitude equalizer		
	Peak detector		Phase equalizer		
	To rise to cubical power		Propagation time equalizer		
	Amplifier general symbol		Laser diode electrical-optical transmitter		
	Multistage amplifier		Optical-electrical receiver		

ABBREVIAZIONI E ACRONIMI
ABBREVIATIONS AND ACRONYMS

AC	Alternating Current
ALC	Automatic Level Control
BCCH	Broadcast Control Channel
BDA	Bi-Directional Amplifier
BTS	Base Transceiver Station
DC	Direct Current
DCS	Digital Cellular System
EGSM	Enhanced Global System for Mobile Communications
EMC	Electro-Magnetic Compatibility
FET	Field-Effect Transistor
GSM	Global System for Mobile Communications
GSM-R	GSM - Railway
HPA	High Power Amplifier
IF	Intermediate Frequency
IP3	Third order Intercept Point
LNA	Low Noise Amplifier
MMIC	Monolithic Microwave Integrated Circuit
MS	Mobile Station
MTBF	Mean Time Between Failures
MU	Master Unit
NF	Noise Figure
OMC	Operation and Maintenance Center
OMT	Operation and Maintenance Terminal
PC	Personal Computer
PEP	Peak Envelope Power
PLL	Phase-Locked Loop
PSTN	Public Switched Telephone Network
RAM	Random Access Memory
RF	Radio Frequency
RL	Return Loss
RU	Remote Unit
SAW	Surface Acoustic Wave
SIM	Subscriber Identity Module
SPV	Supervision
TTL	Transistor, Transistor, Logic
UMTS	Universal Mobile Telecommunications System
UPS	Uninterruptible Power Supply
VCO	Voltage Controlled Oscillator
VSWR	Voltage Standing Wave Ratio