

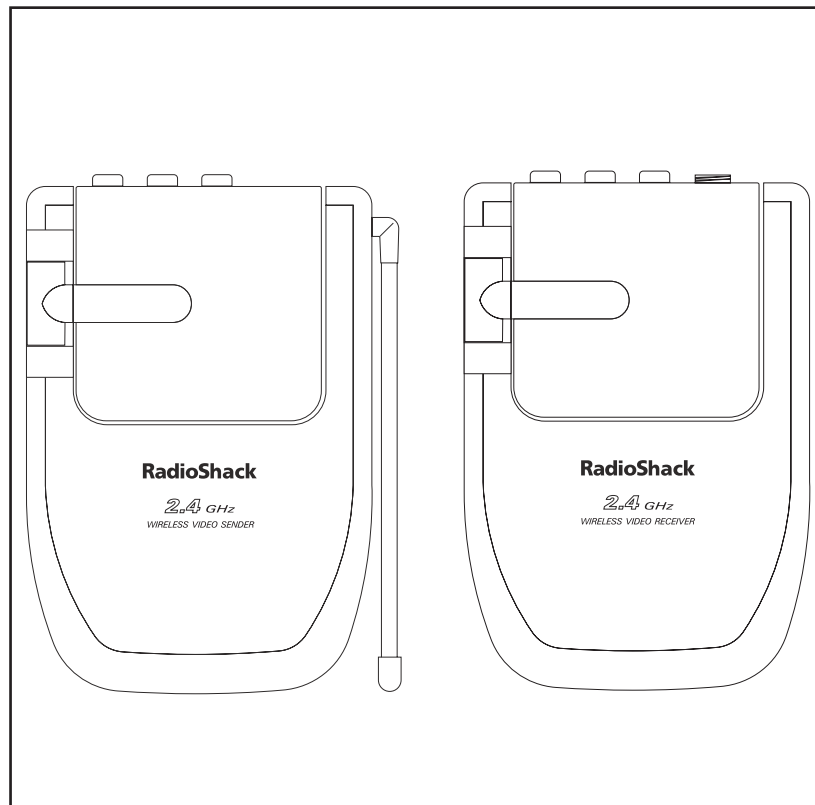

# Video Sender

**AUDIO/VIDEO EXTENDER SYSTEM**



## **OWNER'S MANUAL**

### **MODEL 15-1971**

**(INCLUDES 15-1971T, TRANSMITTER  
AND 15-1971R, RECEIVER, PLUS TWO  
PLUG-IN POWER SUPPLIES, AND ALL  
REQUIRED CONNECTING CABLES)**



## INTRODUCTION

Your Wireless Video Sender kit consists of a transmitter base unit which connects to your DSS receiver, and a receiver unit which connects to the TV in another room. The Video Sender Transmitter converts the A/V signal from your DSS into a radio signal and transmits it (even through walls) to the Video Sender Receiver unit. The Video Sender Receiver converts the signals back to A/V signals which are fed through a cable to your TV's A/V input jacks.

When used with plug 'n power universal remotes your Video Sender also allows you to operate your DSS while watching it in another room. By purchasing an optional Remote Control Extender (Cat. No. 15-1959) can control other A/V products such as VCRs, Cable Boxes, etc. while watching a TV in another room.

There are just a few simple steps to follow to hook up your Video Sender kit to a DSS, VCR or Cable Box.

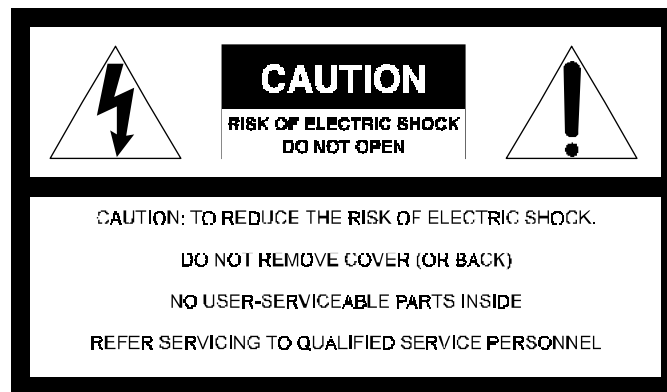

### WARNING:

To reduce the risk of fire or electric shock, do not expose this product to rain or moisture.



## -IMPORTANT SAFETY INSTRUCTIONS-

1. Read Instructions - All the safety and operating instructions should be read before the product is operated.
2. Retain Instructions - The safety and operating instructions should be retained for future reference.
3. Heed Warnings - All warnings on the product and in the operating instructions should be adhered to.
4. Follow Instructions - All operating and use instructions should be followed.
5. Cleaning - Unplug this product from the wall outlet before cleaning. Do not use liquid cleaners or aerosol cleaners. Use a damp cloth for cleaning.
6. Attachments - Do not use attachments not recommended by the product manufacturer as they may cause hazards.
7. Water and Moisture - Do not use this product near water - for Example, near a bath tub, wash bowl, kitchen sink, or laundry tub, in a wet basement, or near a swimming pool; and the like.
8. Accessories - Do not place this product on an unstable cart, stand, tripod, bracket, or table. The product may fall, causing serious injury to a child or adult, and serious damage to the product. Use only with a cart, stand, tripod, bracket, or table recommended by the manufacturer, or sold with the product. Any mounting of the product should follow the manufacturer's instructions, and should use a mounting accessory recommended by the manufacturer.
9. A product and cart combination should be moved with care. Quick stops, excessive force and uneven surfaces may cause the product and cart combination to overturn. 
10. Ventilation - Slots and openings in the cabinet are provided for ventilation and to ensure reliable operation of the product and to protect it from overheating, and these openings must not be blocked or covered. The openings should never be blocked by placing the product on a bed, sofa, rug, or other similar surface. This product should not be placed in a built-in installation such as a bookcase or rack unless proper ventilation is provided or the manufacturer's instructions have been adhered to.
11. Power Sources - This product should be operated only from the type of power



---

source indicated on the marking label. If you are not sure of the type or power supply to your home, consult your product dealer or local power company. For products intended to operate from battery power, or other sources, refer to the operating instructions.

12. Grounding or Polarization - This product is equipped with a polarized alternating current line plug (a plug having one blade wider than the other). This plug will fit into the power outlet only one way. This is a safety feature. If you are unable to insert the plug fully into the cutlet, try reversing the plug. If the plug should still fail to fit, contact your electrician to replace your obsolete outlet. Do not defeat the safety purpose of the polarized plug.
13. Power-Cord Protection - Power supply cords should be routed so that they are not likely to be walked on or pinched by items placed upon or against them, paying particular attention to cords at plugs, convenience receptacles, and the point where they exit from the product.
14. Lightning - For added protection for this product during a lightning storm, or when it is left unattended and unused for long periods of time, unplug it from the wall outlet and disconnect the antenna or cable system. This will prevent damage to the product due to lightning and power-line surges.
15. Overloading - Do not overload wall outlets, extension cords, or integral convenience receptacles as this can result in a risk of fire or electric shock.
16. Object and Liquid Entry - Never push objects of any kind into this product through openings as they may touch dangerous voltage points or short-out parts that could result in a fire or electric shock. Never spill liquid of any kind on the product.
17. Servicing - Do not attempt to service this product yourself as opening or removing covers may expose you to dangerous voltage or other hazards. Refer all servicing to qualified service personnel.
18. Damage Requiring Service - Unplug this product from the wall outlet and refer servicing to qualified service personnel under the following conditions:
  - a) When the power-supply cord or plug is damaged,
  - b) If liquid has been spilled, or objects have fallen into the product,
  - c) If the product has been exposed to rain or water,





- d) If the product does not operate normally by following the operating instructions. Adjust only those controls that are covered by the operating instructions as an improper adjustment of other controls may result in damage and will often require extensive work by a qualified technician to restore the product to its normal operation,
  - e) If the product has been dropped or damaged in any way, and
  - f) When the product exhibits a distinct change in performance - this indicates a need for service.
19. Heat - The product should be situated away from heat sources such as radiators, heat registers, stoves, or other products (including amplifiers) that produce heat.

## FCC CAUTION

THIS DEVICE COMPLIES WITH PART 15 OF THE FCC RULES.

OPERATION IS SUBJECT TO THE FOLLOWING TWO CONDITIONS:

(1) THIS DEVICE MAY NOT CAUSE HARMFUL INTERFERENCE, AND

(2) THIS DEVICE MUST ACCEPT ANY INTERFERENCE RECEIVED, INCLUDING INTERFERENCE THAT MAY CAUSE UNDESIRE OPERATION.

This equipment generates and uses radio frequency energy, and if not installed and used properly, that is, in strict accordance with the manufacturers instructions, it may cause interference to radio and television reception. It has been type tested and found to comply with the limits for remote control devices in accordance with the specifications in Sub-Parts B and C of Part 15 of FCC Rules, which are designed to provide reasonable protection against such interference in a residential installation. However, there is no guarantee that interference will not occur in a particular installation. If this equipment does cause interference to radio or television reception, which can be determined by unplugging the equipment, try to correct the interference by one or more of the following measures.

- Reorient the antenna of the radio/TV experiencing the interference.
- Relocate the equipment with respect to the radio/TV.
- Move the equipment away from the radio/TV.
- Plug the equipment into an outlet on a different electrical circuit from the radio/TV experiencing the interference.
- If necessary, consult your local Dealer for additional suggestions.

**NOTE:** Modifications to this product will void the user's authority to operate this equipment.



# CONTENTS

**CONTROLS AND CONNECTIONS** ..... 7

**VIDEO TRANSMITTER**..... 7

**VIDEO RECEIVER**..... 8

**CONNECTING UP**..... 9

**HOOING UP THE VIDEO TRANSMITTER**..... 9

**HOOING UP THE VIDEO RECEIVER**..... 11

**IF YOU WANT TO USE YOUR VIDEO TRANSMITTER TO TRANSMIT FROM YOUR STEREO SYSTEM ONLY**..... 12

**FINE TUNING YOUR VIDEO SENDER**..... 13

**THE REMOTE EXTENDER FEATURE**..... 14

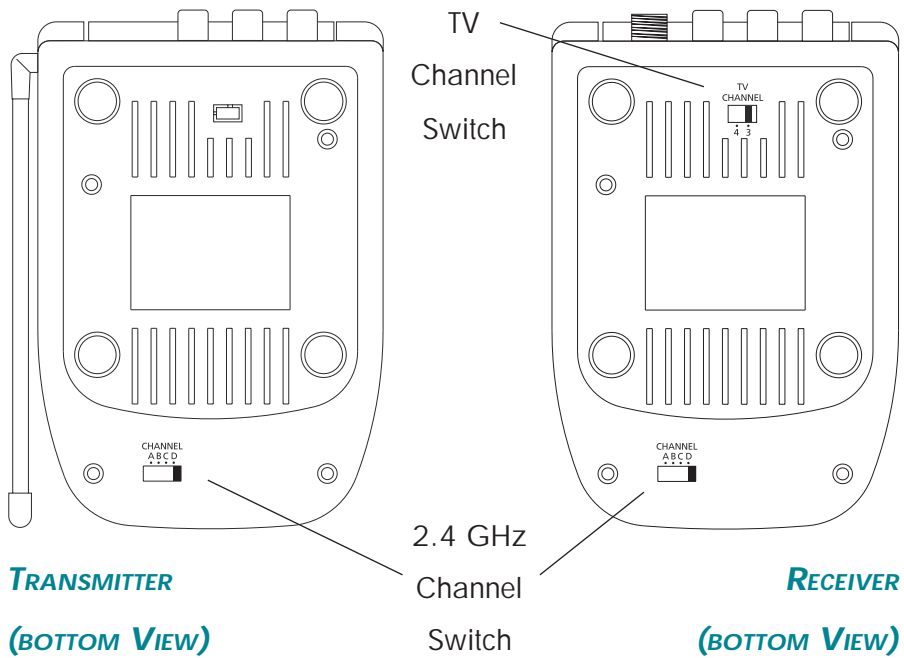



## CONTROLS AND CONNECTIONS

### VIDEO TRANSMITTER

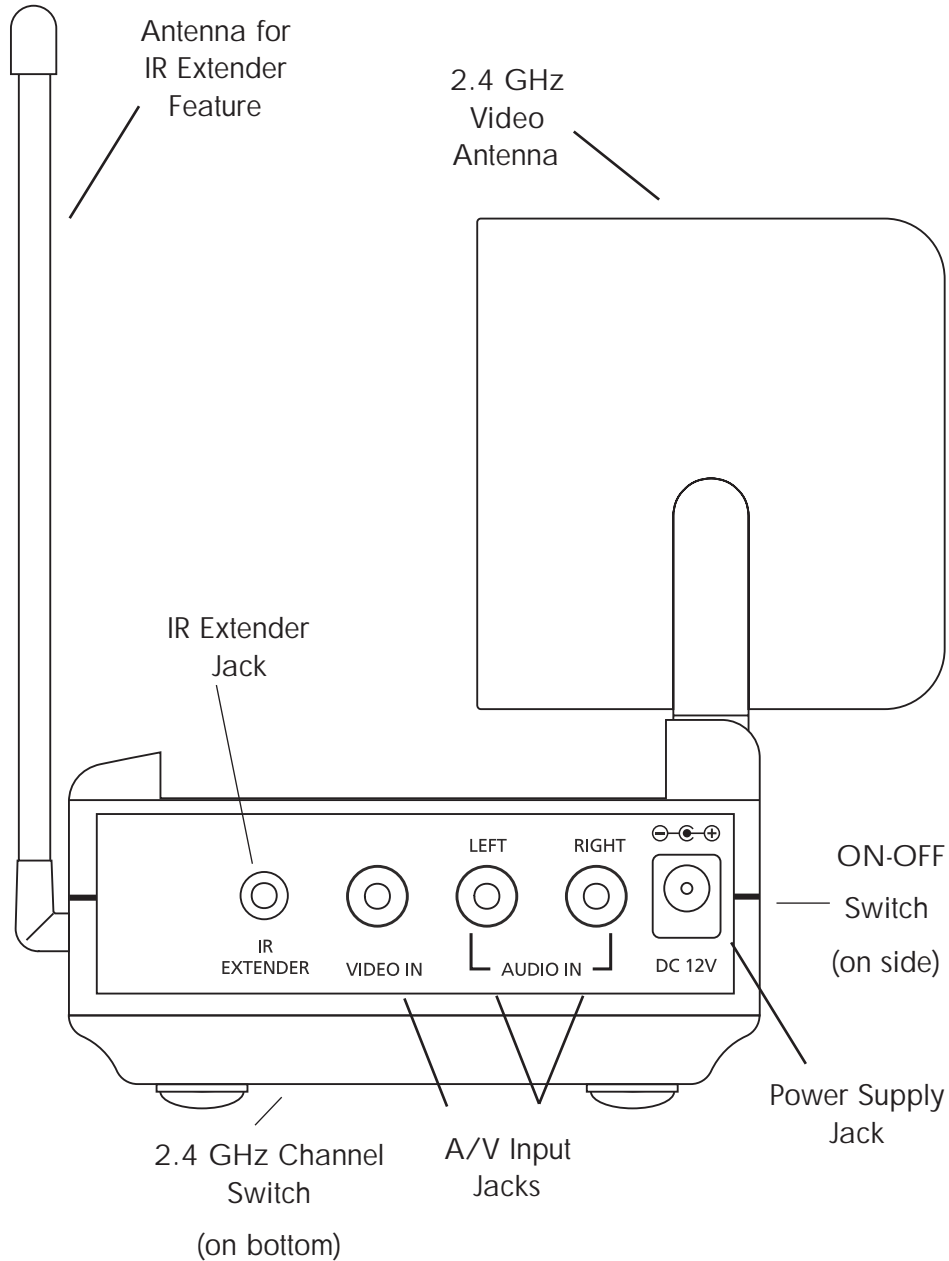



## VIDEO RECEIVER

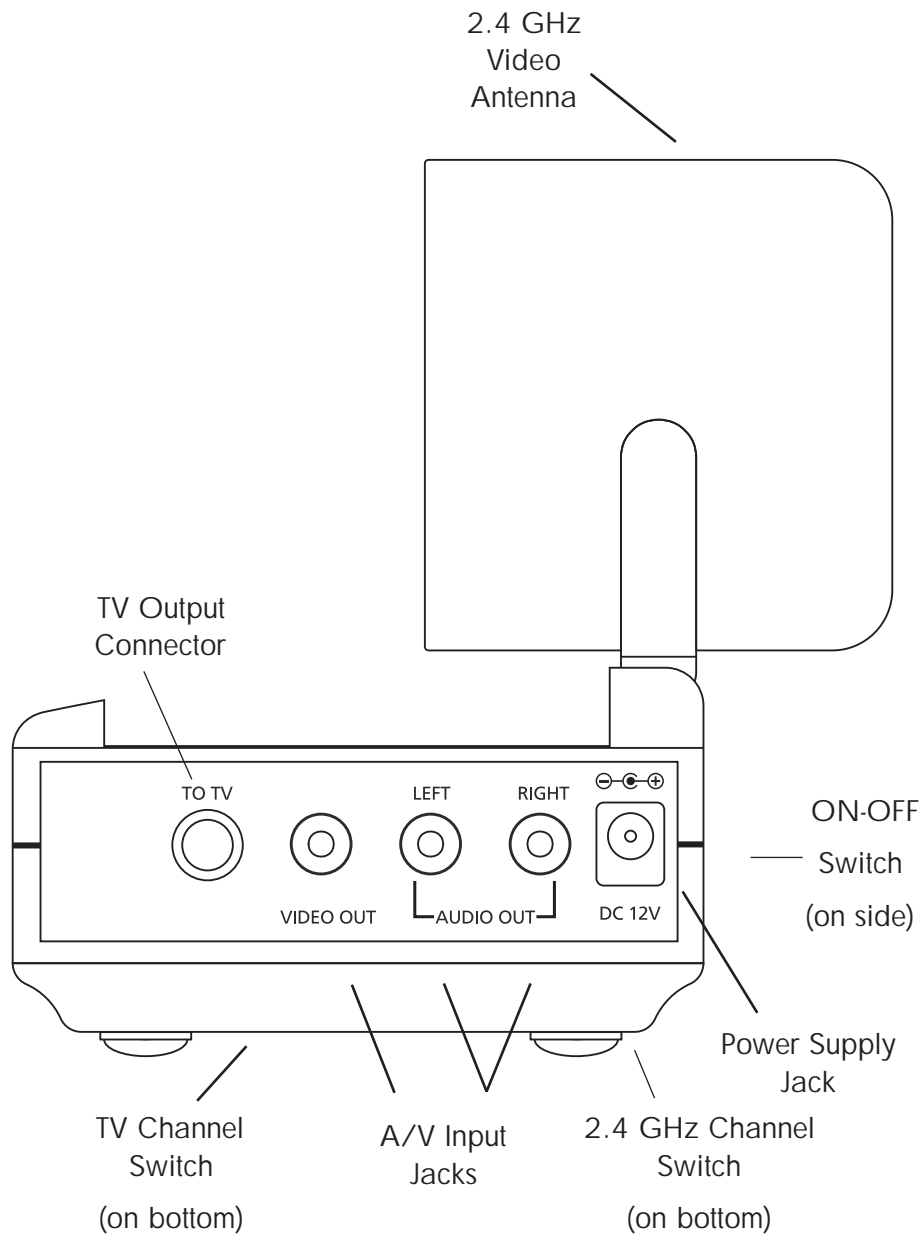





## CONNECTING UP

### HOOKING UP THE VIDEO TRANSMITTER

1. Connect one set of Audio/Video cables to the VIDEO and AUDIO jacks of your Video Transmitter. Take care to match the colors of the plugs on the cable with the jacks on the Video Transmitter.
2. Connect the other end of the cable to the Audio/Video OUT jacks on your TV. Take care to match the colors of the plugs on the cable with the jacks on the TV. If the jacks on the TV are colored differently, connect the yellow plug to the jack labelled VIDEO, the red plug to the jack labelled AUDIO RIGHT and the white plug to the jack labeled AUDIO LEFT.

**Note:** If your TV does not include Audio/Video OUT jacks, you will need to remake the connections as shown in diagram b) using the TV antenna (coaxial) connections to link up the DSS Receiver/Cable Box/VCR to your TV.

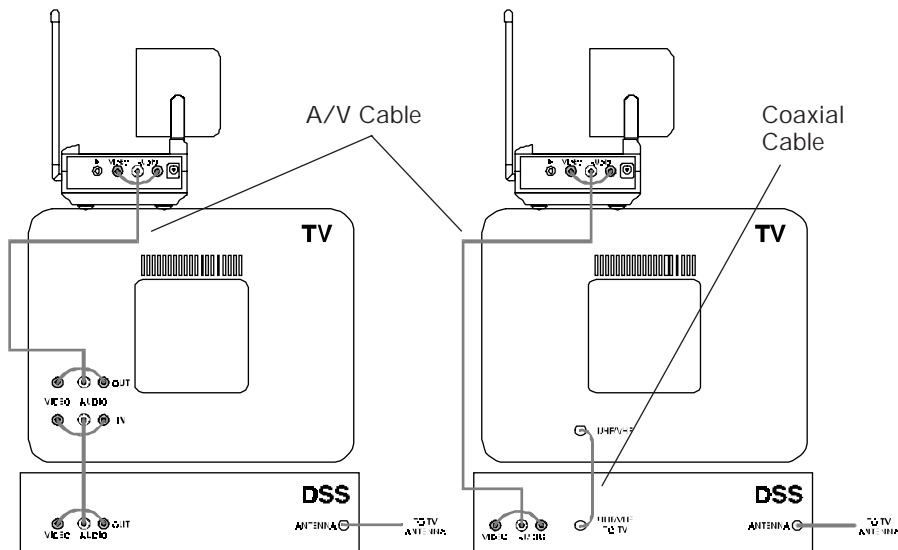

a) Connections for a TV with A/V OUT jacks.

b) Connections for a TV without A/V OUT jacks.



3. Plug the Video Transmitter's Power Supply into a convenient 120 volt wall outlet and plug its jack into the Video Transmitter.
4. Position the Video Transmitter in a convenient location such as on top of the TV and orient the antenna so that the flat side points in the direction of the room where you will be installing the Video Receiver.

### ***IF YOU HAVE SEVERAL A/V COMPONENTS***

If you have two or more A/V components (e.g. DSS, VCR, Cable Box, Video Disk etc.) that you want to watch in another room, they will probably already be hooked up to the local TV in series (see the diagram to the right). To connect the Video Transmitter you just need to identify the last component in the chain and connect its LINE OUT jacks to the Video Transmitter's LINE IN jacks.

If the last component in the chain does not have spare LINE OUT jacks, reconnect the local TV to the last component in the chain using coaxial cables to connect the VHF/UHF ports, then use the A/V connections for the Video Transmitter.

Fully extend the telescopic antenna if you intend to use the IR Extender feature (See page 14).

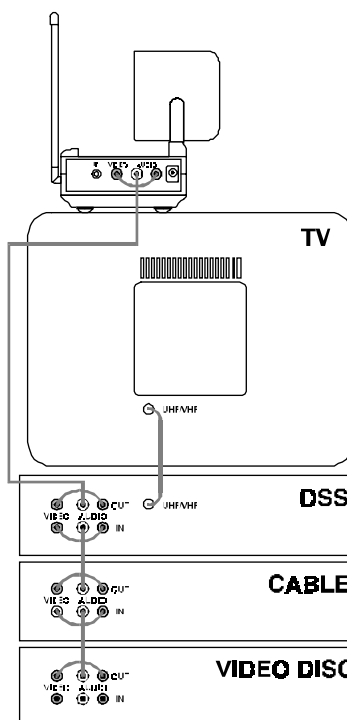



## HOOKING UP THE VIDEO RECEIVER

1. Connect a set of Audio/Video cables the A/V OUT jacks of your Video Receiver. Connect the other end to your TV.

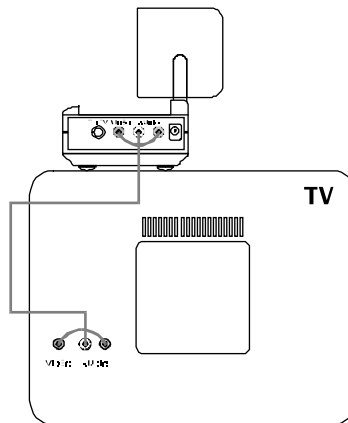

2. Plug the Video Receiver's Power Supply into a 120 volt wall outlet and plug its jack into the Video Receiver.
3. Position the Video Receiver in a convenient location such as on top of the TV and orient the antenna so that the flat side points in the direction of the room where you set up the Video Transmitter.

### ***IF YOUR TV DOES NOT HAVE A/V CONNECTORS***

You can use the supplied coaxial cable to connect the TV OUT socket on the Video Receiver to the Antenna input on your TV. If you already have an antenna connected to your TV, you will need to use a TV antenna splitter.

Set your TV and the TV Channel switch on the Video Receiver (on bottom) to the same channel (3 or 4).

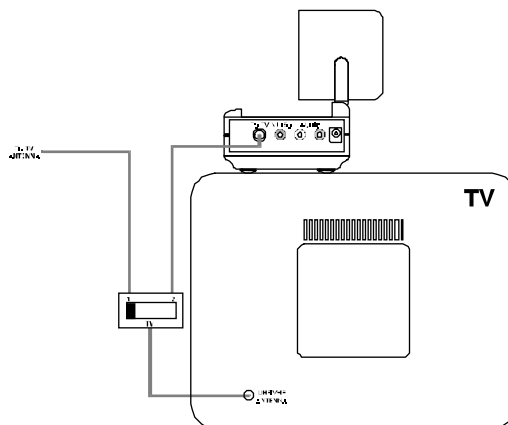



**IF YOUR SECOND TV RECEIVER IS ALREADY HOOKED UP TO A DSS RECEIVER OR OTHER A/V DEVICE**

If your DSS Receiver or other A/V component is connected to the TV using A/V cables, you can connect the Video Receiver to the free LINE IN jacks on the component. If there are no LINE IN jacks, you will need to use a TV antenna splitter as described earlier.

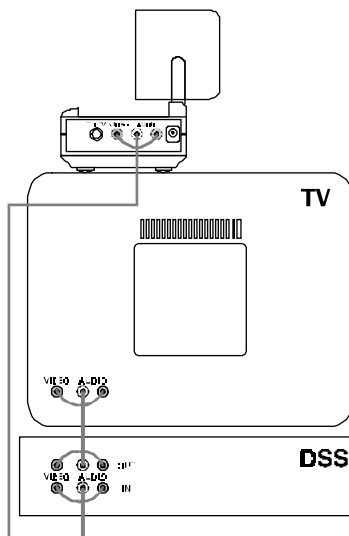

**IF YOU WANT TO USE YOUR VIDEO TRANSMITTER TO TRANSMIT FROM YOUR STEREO SYSTEM ONLY**

Just hook up the Video Transmitter using only the red and white jacks for the right and left channels of the audio signal. Leave the yellow (video) jacks unconnected.

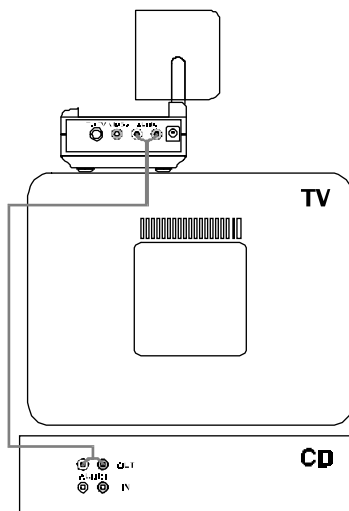



## — FINE TUNING YOUR VIDEO SENDER —

The Wireless Video Sender usually works best with the flat faces of the antennas on the Transmitter and Receiver unit facing each other (i.e. in "Line of sight" - see diagram below). Sometimes, however, reflections and other effects in the home may affect the signal so that some adjustment of either the Transmitter or Receiver antenna may be necessary to get the best the signal.

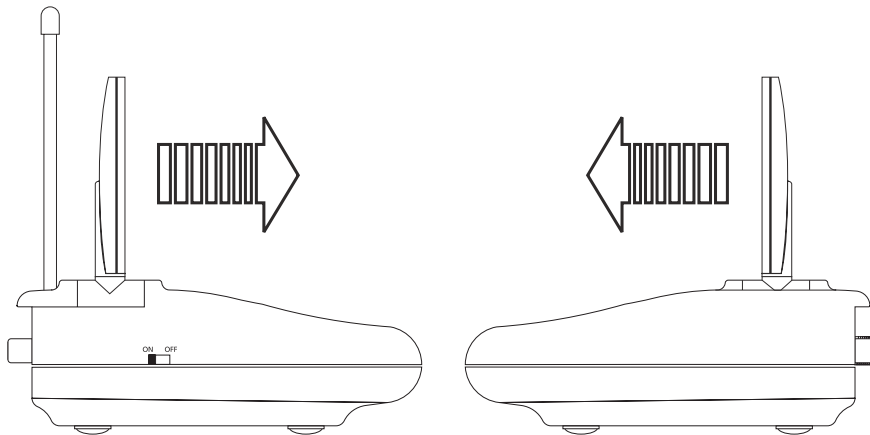

### ***IF YOU ARE NOT GETTING ANY SIGNAL AT ALL***

Check that the CHANNEL slide switch (labeled 1 to 4) on both Video Sender units (on bottom) is set to the same number.

If you are using coaxial TV connections from the Video Receiver, check that the TV is tuned to the same channel as the TV Channel switch on the bottom of the Video Receiver (3 or 4).

### ***IF THE SIGNAL IS POOR, OR THERE IS INTERFERENCE***

Try changing the channel on both Video Sender units. Do this by adjusting the CHANNEL slide switch on the bottom of each Video Sender unit to any position from 1-4. Make sure both units are set to the same channel.



## THE REMOTE EXTENDER FEATURE

The Remote Extender feature allows certain brands of universal remotes to control some models of RCA DSS Receivers from another room. For example, you can change channels on your Satellite Receiver while viewing in another room.

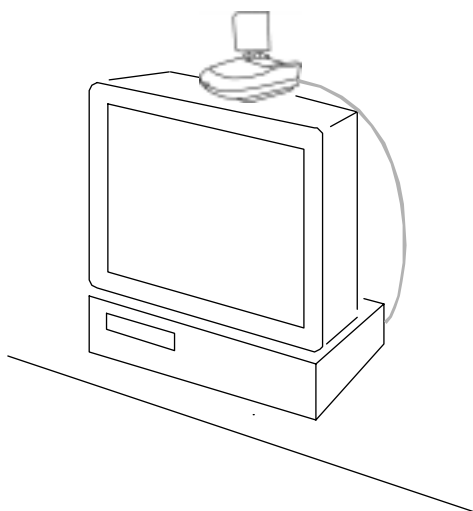

To use the Remote Extender Function you need to use the included Remote Extender Cable. Connect this cable to the IR jack on the Video Transmitter. Connect the other end of the cable to the IR Control input on the RCA DSS Receiver.

Fully extend the antenna on the Video Transmitter.

To operate the controls on the RCA DSS Satellite Receiver from another room, just press the appropriate buttons on the remote. The remote sends RF signals direct to the Video Transmitter, even through walls. The Video Transmitter passes these signals through the Remote Extender cable to the RCA DSS Satellite Receiver.



---

# WARRANTY

---

## 90 DAY LIMITED WARRANTY

RadioShack WARRANTS ITS PRODUCTS TO BE FREE FROM DEFECTIVE MATERIAL AND WORKMANSHIP FOR A PERIOD OF ONE (1) YEAR FROM THE ORIGINAL DATE OF PURCHASE AT RETAIL. RadioShack AGREES TO REPAIR OR REPLACE, AT ITS SOLE DISCRETION, A DEFECTIVE RadioShack PRODUCT IF RETURNED TO RadioShack WITHIN THE WARRANTY PERIOD AND WITH PROOF OF PURCHASE.

IF SERVICE IS REQUIRED UNDER THIS WARRANTY: RETURN THE DEFECTIVE UNIT TO THE STORE WHERE YOU PURCHASED IT.

THIS WARRANTY DOES NOT EXTEND TO ANY RadioShack PRODUCTS WHICH HAVE BEEN SUBJECT TO MISUSE, NEGLIGENCE, ACCIDENT, INCORRECT WIRING OR TO USE IN VIOLATION OF OPERATING INSTRUCTIONS FURNISHED BY US, NOR EXTEND TO UNITS ALTERED OR REPAIRED FOR WARRANTY DEFECT BY ANYONE OTHER THAN RadioShack. THIS WARRANTY DOES NOT COVER ANY INCIDENTAL OR CONSEQUENTIAL DAMAGES AND IS IN LIEU OF ALL OTHER WARRANTIES EXPRESSED OR IMPLIED AND NO REPRESENTATIVE OR PERSON IS AUTHORIZED TO ASSUME FOR US ANY OTHER LIABILITY ON CONNECTION WITH THE SALE OF OUR PRODUCTS.

SOME STATES DO NOT ALLOW LIMITATIONS ON HOW LONG AN IMPLIED WARRANTY LASTS, AND/OR THE EXCLUSION OR LIMITATION OF INCIDENTAL OR CONSEQUENTIAL DAMAGES SO THE ABOVE LIMITATIONS AND EXCLUSIONS MAY NOT APPLY TO THE ORIGINAL CUSTOMER. THIS WARRANTY GIVES YOU SPECIFIC RIGHTS AND YOU MAY HAVE OTHER RIGHTS WHICH VARY FROM STATE TO STATE.



---

**RadioShack, a Division of Tandy Corp.**  
**Ft. Worth, TX 76102**

---

VK30A -6/98