



360 Herndon Parkway
Suite 1400
Herndon, VA 20170
<http://www.rheintech.com>

19 MANUAL

FEATURES

You RadioShack TRC-520 40-Channel Mobile CB Radio provides two-way communications on the citizen's radio band and also lets you tune to local and national weather service broadcasts. This CB is perfect for recreational, business, or emergency use. You can call other people who have CBs at home, in their vehicles, or at campsites, (for example) You can also connect optional equipment to your CB such as external speakers, or a DC power supply and base station antenna to set up a base station in your home. The built-in 40-channel PLL (phase-locked loop) frequency synthesizer uses a precise frequency reference crystal for reliable and exact tuning.

Your CB has these features:

ACE(Audio Clarity Enhancer)— suppresses noise levels while leaving the signal intact during reception. It enhances the transmission and provides a significant reduction in transmission and reception noise.

WX/CB/Compass Switch — lets you quickly select among normal CB operation, Weather mode, E.compass mode.

NOAA 7 Channel WX band Receiver —lets you tune to seven national weather service frequencies which provide local weather conditions and forecasts.

WX / Signal Indicator— shows the CB is ready to receive and indicates the reception of a weather alert

Digital Weather Alert — uses Specific Ares Message Encoding (SAME) Digital information to determine and display the level of weather events (does not limit alerts to a specific area).

Convenient On-Microphone Channel Up/Down Controls—let you quickly scan the band for communications.

Universal Mounting Bracket - lets you mount your CB securely in your vehicle.

Specialized Squelch Circuit — compensates for fading signals and eliminates signal shopping during reception

RF Gain Control -prevent overload-Ing due to strong RF signals

Maximum Allowable Legal Power Output —gives you the greatest available range.

TX Indicator- light to show when the radio is transmitting.

Digital Channel Display-makes the channel number easy to see.

FEATURES

Dual/MEM —lets you activate Dual Watch Mode

External Speaker Jack — Lets you connect your CB to an external speaker.

Screw-On Mic Connector-ensures a secure microphone connection.

To use this CB, you need a mobile or Base station antenna. Your local RadioShack store has a wide variety of antennas. For more information, see "Connecting an Antenna" on page 6.

The Federal Communications Commission (FCC) does not require you to have a license to operate this CB. However, you must know part 95 of FCC Rules. It explains the proper operation of a Class D citizen's band CB. We enclosed a copy of part 98 with your CB radio.

We recommend you record your CB's Serial number here. The number is on the back of the CB.

Serial Number:

©2001 RadioShack corporation.
All Rights Reserved.

RadioShack, RadioShack.com, and Adaptaplug are trademarks used by RadioShack Corporation.

RF EXPOSURE INFORMATION:

CAUTION: To comply with the FCC RF Exposure compliance requirements, a separation distance of at least 20.0 cm must be maintained between the antenna of this device and all persons. This device must transmit with a source-based time-averaging duty factor not exceeding 50%.

NOTE: Installation and Operation instructions are for satisfying FCC RF Exposure compliance.

CONTENTS

Installation	4
Before You Begin.....	4
Attaching the Microphone Holder.....	4
Mounting the CB.....	4
Connecting the Microphone.....	5
Connecting an Antenna.....	6
Connecting Vehicle Battery Power.....	7
Connecting an External Speaker.....	7
Using the CB as a Base Station.....	7
Operation	9
Receiving Transmissions and Setting Squelch.....	9
Transmitting.....	11
Listening to the Weather Band.....	11
Using Weather Alert/SAME.....	11
Common Uses for a CB.....	12
Business Uses.....	12
Personal Uses.....	13
Transmission Courtesy.....	13
Maximum Range.....	13
Reducing Noise.....	13
Using Common 10-Codes	15
Weather Channel Frequencies.....	16
Troubleshooting	17
Care and Maintenance	18
Replacing the Fuse.....	19
The FCC Wants You to Know.....	19
Specifications	20

INSTALLATION

BEFORE YOU BEGIN

Your CB's display is protected during shipment by a piece of clear film. Carefully peel off this film before using your radio for the first time.

ATTACHING THE MICROPHONE HOLDER

You can connect the microphone holder to either side of the CB or to another location in your vehicle. To attach the holder to either side of the CB, horizontally or vertically, secure it using the supplied machine screws and lock washers.

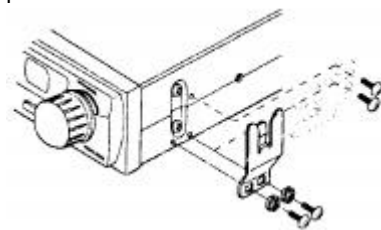

To attach the holder to another location in the vehicle, such as the dashboard, follow these steps.

1. Using the holder as a template, Mark the positions for the mounting
2. At each marked position, drill a hole slightly smaller than the supplied mounting screws.

Caution: Be careful not to drill into anything behind the mounting surface.

3. Attach the holder at the mounting location using the supplied machine screws and lock washers.

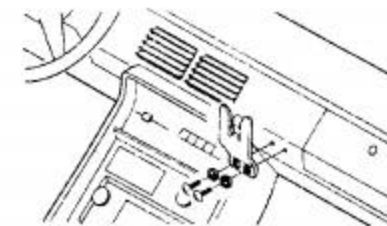

MOUNTING THE CB

The most common mounting location for this CB is under a vehicle's dashboard. However, if you use the TRC-520 as a base station, you can place it on a desk, shelf, or table (see "Using the CB as a Base Station" on Page 7).

If you are mounting the CB in a vehicle, choose a location where:

- You can easily reach the CB.
- Wires and cables are clear of the vehicle's pedals or other moving parts.
- The CB is not directly in front of heat ing vents.
- All wires and cables can reach their connection points.

Warning: If you use the CB in a vehicle, mount it securely to avoid damage to the CB or vehicle or injury to anyone in the Vehicle during sudden starts or stops.

Follow these steps to mount the CB using the supplied hardware.

1. Using the mounting bracket as a template, mark the positions for the screw holes on the mounting surface.

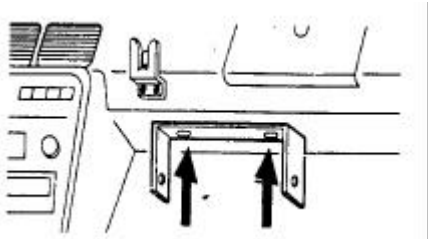

2. In each marked position, drill a hole slightly smaller than the supplied mounting screws.

Caution: Be careful not to drill into objects behind the mounting surface.

3. Using a Phillips screwdriver, attach the mounting bracket to the mounting surface with the supplied screws and lock washers.

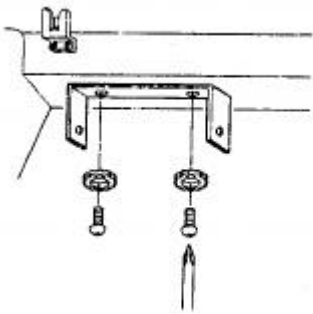

4. Attach the CB to the mounting bracket using the supplied rubber washers and mounting knobs.

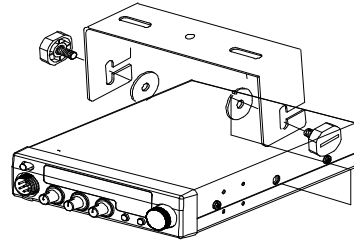

Note: The radio has a Compass mode and in order to use the mode correctly, you have to install this set HORIZONTALLY.

CONNECTING THE MICROPHONE

1. Align the slot on the bottom of the microphone's plug with the ridge inside the microphone jack. Then fully insert the plug into the jack.

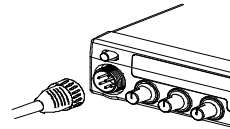

2. Turn the plug's locking nut clockwise to tighten it.
3. Slide the microphone onto the microphone holder.

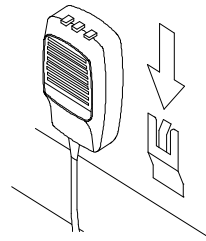

To disconnect the microphone from the CB, unscrew the locking nut then pull out the plug.

Caution: Never pull on the microphone's cable.

CONNECTING AN ANTENNA

There are many different types of CB Antenna for mobile CBs. Each antenna Type has its own benefits, so choose the One that best meets your needs. Your Local RadioShack store sells a wide Variety of antennas.

Note: if you are using this CB as a Base station, see "Using the CB as a Base Station" on Page 7.

When you choose an antenna, keep in Mind that for the best performance you Should mount the antenna:

- as high as possible on the vehicle
- as far as possible from source of electrical noise
- vertically

Once you choose an antenna, follow its mounting instructions. Then route

The Cable to the CB and connect the Cable to The **ANT** .jack on the back of the CB.

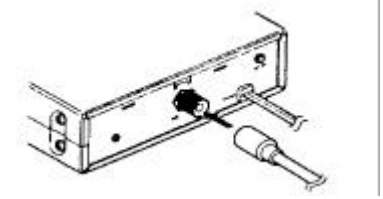

Cautions:

- Avoid routing the cable next to sharp edges or moving parts, which might damage the cable.
- Do not run the cable next to power cables or other radio antenna cables
- Do not run the cable through the engine compartment or other areas that produce extreme heat.

For maximum range, adjust the antenna's Standing Wave Ratio (SWR) using an SWR meter (not Supplied).

Follow the instruction supplied with the SWR meter and antenna to adjust your antenna's SWR to the lowest possible value. SWR values of 2.0:1 are generally acceptable, with readings of 1.5:1 or lower being more desirable.

CONNECTING VEHICLE BATTERY POWER

Follow these steps to connect the cb
To vehicle battery power

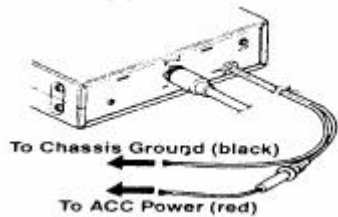

1. Connect the red wire (with the in-line fuse holder) on the back of the CB to a terminal in your vehicle's fuse box that has power only when the ignition is in the ACC (accessory) or ON position.
2. Connect the black ground wire to a metal part of the vehicle's frame (chassis ground).

Caution: Do not connect the black wire to a non-metallic (plastic) part, or to any part insulated from the vehicle's chassis by a non-metallic part.

CONNECTING AN EXTERNAL SPEAKER

You can connect an optional external speaker to the cb. use an 8-ohm speaker with a 1/8-inch (3.5-mm) plug. Insert the speaker's plug into the CB's EXT. SP. jack. Your local RadioShack store carries a wide selection of suitable speakers.

USING THE CB AS A BASE STATION

Although this CB is designed mainly for mobile use, you can also use it as a base station with an AC power source. For base station installation, you need these items,

- a 12-volt DC power supply that can supply at least 1.5 amps
- Caution:** Most 12-volt DC power supplies plug into a standard AC outlet produce DC power. Before connecting your CB to a 12-volt DC power supply, read and follow the instruction included with the power supply.

- base station antenna
- coaxial antenna cable and connectors

Note: Your local RadioShack store carries a wide selection of base station antennas, coaxial antenna cable, and connectors. In addition, you can choose from a selection of suitable base station power supplies

Follow these steps to install the CB as a Base station.

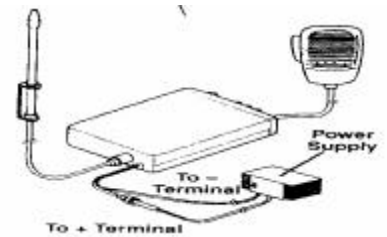

1. Mount the base station antenna as described in its owner's manual

Warning: Use extreme caution when you install or remove a base station CB antenna if the antenna starts to fall, let it go. It could contact overhead power lines. If the antenna touches a power line, contact with the antenna, main cable, or guy wires can cause electrocution and death. Call the power company to remove the antenna. Do NOT attempt to do so yourself

2. Connect the antenna to the **ANT.** Jack on the back of the CB.

3. Connect the CB's black power wire to the negative (-) terminal on the DC power supply.

4. Connect the CB's red wire (with the in-line fuse) to the positive (+) terminal on the DC power supply.

5. Connect the DC power supply to a standard AC outlet

OPERATION

Before you use your CB, you should know how to use it effectively and correctly. "Common Uses for a CB" on Page 12 contains information that will help you get more enjoyment from your CB.

Caution: Do not attempt to use your CB without first connecting it to an antenna.

RECEIVING TRANSMISSIONS AND SETTING SQUELCH

1. Rotate **VOLUME** fully counterclockwise

2. Set WX/CB/Compass to CB

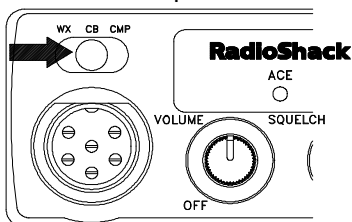

3. Turn **SQUELCH** fully counterclockwise.

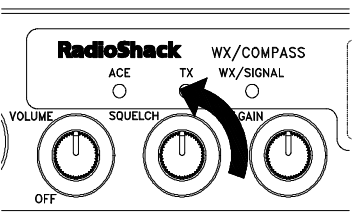

4. Turn **RF GAIN** fully clockwise.

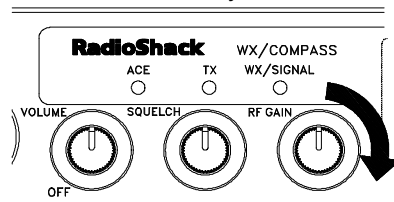

5. Turn on the CB by turning **OFF/VOLUME** clockwise. The display lights and the channel appear.

Note: The CB sounds an alert if it detects a weather alert signal (see "Using Weather Alert/SAME" on Page 11).

6. Rotate **VOLUME** clockwise until you hear a hissing sound.

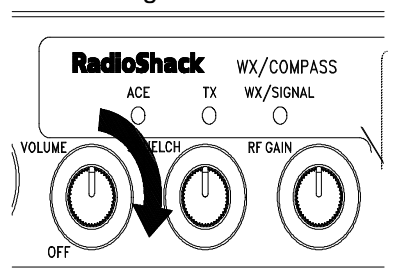

7. Slowly turn **SQUELCH** clockwise until the hissing sound stops.

Note: To receive very weak signals, turn **SQUELCH** counterclockwise. You hear noise between transmissions, but you can also hear weak transmissions (those not strong enough to break through a higher squelch setting). If the CB picks up unwanted, weak transmissions, turn **SQUELCH** clockwise to reduce the CB's sensitivity to these signals.

8. Turn **RF GAIN** counterclockwise to decrease the incoming signal strength and prevent overloading. Or, turn it clockwise to receive the maximum possible signal.

9. Rotate **CHANNEL** to select a channel.

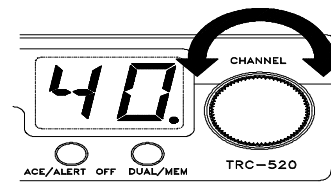

10. Adjust **VOLUME** to a comfortable listening level.

11. To improve communication quality, press **ACE**. The **ACE** indicator lights. See "Reducing Noise" on Page 13

Notes:

- The **ACE** circuit does not operate when you select **WX**
- You cannot turn on the **ACE** circuit while holding down the talk button.

12. To turn off the CB, turn **OFF/VOLUME** counterclockwise until it clicks.

13. Changing Channels Using the Controls on the Microphone

To tune to the next higher or lower channel, press **UP** or **DOWN** on the microphone.

To quickly change channels in either direction, hold down **UP** or **DOWN** until you reach the desired channel.

To prevent accidentally changing the channel with **UP** or **DOWN**, press **LOCK**. Press **LOCK** again to restore the **UP** or **DOWN** operation.

Dual watch & Memory setting

1. In order to activate dual watch mode, press **DUAL/MEM** button shortly. (Dual watch: current ch. & Default Ch. 9)

2. To memorize watch ch. Instead of default ch. 9 press **DUAL/MEM** button over one second, in the desired channel. Then press the **DUAL/MEM** button again shortly in another channel you want to dual watch, it will dual watch between the ch. & memorized Ch.

3. Press the **Dual/MEM** button shortly to stop the mode.

Notes:

• Once you transmit signal in one of both watch channels, Dual mode stops and returns to Rx standby mode in the Ch.

• Dual mode stops also when you press **UP/DOWN** key.

Turning Digital Weather Alert On/Off

1. When your local weather station broadcasts a severe weather alert signal, the

radio sounds an alert tone and the radio's SAME ALT indicator lights according to the emergency level encoded in the signal

TRANSMITTING

Note: We recommend you try receiving Transmissions before you transmit.

1. To transmit, press the talk button on the microphone. Hold the microphone about 2-3 inches from your mouth and speak in a normal tone of voice. The TX indicator turns on.

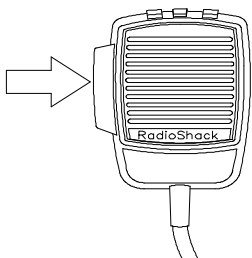

2. When you finish transmitting, release the talk button. The TX indicator turns off.
3. To turn off the CB, turn OFF/VOLUME counterclockwise until it clicks

LISTENING TO THE WEATHER BAND

The National Oceanic and Atmospheric Administration (NOAA) broadcasts local forecast and regional weather information on one or more of seven channels in the US. We have pre-programmed your CB with all seven of these frequencies. (See "weather Channel Frequencies." on page 16.)

To select a weather broadcast, WX/CB/Compass to WX, and turn CHANNEL to select one of the frequencies.

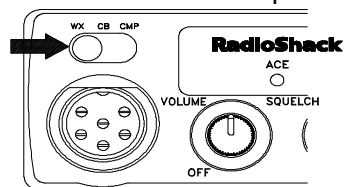

set WX/CB/Compass to CB to return to normal CB operation.

Note: The microphone's talk button does not work when set to WX.

Using Weather Alert/SAME

1. To hear your local forecast and regional weather information, set Wxmode and select the desired band using UP/DOWN key.
2. When your local weather station broadcasts a severe weather alert signal, the radio sounds an alert tone and the radio's SAME ALT indicator lights according to the emergency level encoded in the signal as follows.

Alert Type	Display	Sound
Warning	WR	Siren
Watch	WT	Siren
Statement	ST	Beep
Test and Other	TE	Beep

Note: to turn off the tone, please Alert off

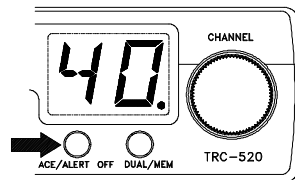

Notes:

- Because of atmospheric conditions, you might encounter times when the signal your radio receives does not contain information relevant to the emergency level of the alert. This is normal.
- The radio will sound an alert regardless of the channel setting.
- The CB will not sound an alert while you are transmitting.

Caution: if you are in a rural or fringe area, your radio might be triggered by an alert broadcast in one area, but not be triggered if you travel to another area (even close by).

To verify actual reception, your radio must receive a test or emergency alert broadcast. In the US, the National Weather Service (NWS) broadcasts a Test alert every week on Wednesday between 11 AM and 1 PM. To find out the specific test schedule in your area, contact your local NOAA or National Weather Service office. These offices are usually listed in the telephone directory under "US Government, Department of Commerce."

Using Compass

This Mode displays current direction and CB channel. Plus you can use CB function (R/Tx) without friction in this mode as well. (Display direction & Ch. by turns)

1. Set WX/CB/Compass to Compass

2. In order to calibrate current direction, practice following procedure.

- a) Press ACE/Alert & DUAL/MEM buttons simultaneously and then display 'CA'.
- b) Press DUAL/MEM button
- c) Rotate your Car 180 degree
- d) Press DUAL/MEM button
- e) Press ACE/Alert & DUAL/MEM buttons simultaneously and then display current direction.

Directions	Display
East	E
West	W
South	S
North	N
Northeast	NE
Northwest	NW
Southeast	SE
Southwest	SW

COMMON USES FOR A CB

Like most activities, CB radio has its customs and courtesies. The following tips will help you get the most enjoyment from your CB.

Business Uses

• Truck drivers and delivery personnel can learn road and traffic conditions and get assistance in locating destinations. A CB is also good company on those "long hauls".

• On construction crews, a CB quickly pays for itself when you are calling for additional materials or coordinating the activities of different work crews.

• For security officers, a CB is more than a convenience – it is a must for both safety and efficiency.

Personal Uses

- Keep in touch with home while driving to work, to the store, or to a social activity. Let your family know you are tied up in traffic or that you will stop by the store on the way home.
- If you are a two-car (or more) family, CBs are great for communicating with family members while they are in their cars.
- Contact friends or neighbors—find out “what’s happening” or plan a get-together
- Ever have car trouble or run out of gas on the highway? What an assurance it is to be able to call for assistance!
- Camping, fishing, and other sports are more fun with a CB. Locate a buddy or find out “what’s cooking” back at camp.

TRANSMISSION COURTESY

Please follow these guidelines of radio courtesy when using your CB.

- Wait for a pause in someone else’s transmission before you ask for a break.
- If you do not receive an answer to your call after a second attempt, sign off and wait several minutes before trying again.
- Do not hold down the talk button when you are not talking (This is called dead keying).
- Assist callers with directions, information about road conditions, and any other reasonable requests.

MAXIMUM RANGE

The maximum range and quality of CB Transmissions vary depending on the following conditions:

- The type and quality of antenna used
- The height of the antenna’s mounting location the higher the antenna, the better the signal’s range
- The surrounding terrain mountains and tall buildings limit the range
- Weather conditions
- The number of nearby CBs operating on the same channel
- Standing wave ratio (SWR) between the antenna and the CB.

Note: Your CB radio’s transmission range is generally line-of-sight.

REDUCING NOISE

The Audio Clarity Enhance (ACE) circuit uses compander (compressor and expander) technology to improve communication quality. The circuit maintains the dynamic range while increasing the signal-to-noise ratio as the gain is automatically level. This results in a reduction in wide band noise.

Because your CB is exceptionally quiet, any noise you hear is probably from

an external source in your vehicle, such as the alternator, another radio, or spark plugs.

You can determine the noise’s Source by turning off the engine and Operating the CB with your vehicle’s Ignition set to ACC. If the noise is

reduced, the problem is in your vehicle’s ignition or electrical system.

Here are a few hints to help you reduce or eliminate such noise:

- Make all CB power and antenna wires as short as possible.
- Keep the power wires away from the antenna wires.
- Be sure the chassis ground connection is secure.
- Replace old ignition wires with new, high-voltage, noise-suppression wires.
- Install noise suppressors on your spark plugs, or install new spark plugs that have built-in noise suppressors.
- If problems persist, check your alternator/generator and regulator gauges. You can reduce the noise from these sources by using bypass capacitors at the various output voltage points.

Your local RadioShack store has a Wide selection of noise-suppression accessories.

USING COMMON 10 –CODES

Citizen's Bend operator have Largely adopted the 10-codes For standard questions and answer. These codes permit faster communication and better intelligibility in noisy areas. While not all codes are listed, most of the more popular ones follow :

Code	Meaning
10-1	Receiving poorly.
10-2	Receiving well.
10-3	Stop transmitting
10-4	OK, message received
10-5	Relay message
10-6	Busy , please stand By
10-7	Out of service
10-8	In service
10-9	Repeat message.
10-10	Transmission completed, standing by
10-11	Talking to rapidly .
10-12	Visitors present.
10-13	Advise Weather/Road Conditions.
10-17	Urgent business.
10-18	Anything for us?
10-19	Nothing for you. Return to base.
10-20	My location is _____.
10-21	Call by telephone.
10-22	Report in person To _____.
10-23	Please stand by.
10-25	Can you contact _____.

Code	Meaning
10-26	Disregard last information.
10-27	I am moving to channel _____.
10-28	Identify your station
10-32	I will give you a radio Check .
10-33	Emergency traffic.
10-36	Correct time is
10-37	Wrecker needed at
10-38	Ambulance needed at _____.
10-41	Please turn to channel _____.
10-42	Traffic accident at _____.
10-43	Traffic tie-up at _____.
10-50	Break channel.
10-62	Unable to copy; use telephone.
10-70	Fire at _____.

Note: Although this table lists the 10-Codes' meaning in the form of a statement, they can also be phrased as questions (10-6: Are you busy?, 10-20: What is your location?).

WEATHER CHANNEL FREQUENCIES

You CB is programmed with the following United States weather service channel FM frequencies:

Channel	Frequency (MHz)
WX1	162.400
WX2	162.425
WX3	162.450
WX4	162.475
WX5	162.500
WX6	162.525
WX7	162.550

TROUBLE SHOOTING

We do not expect you to have any problem with your CB, but if you do, the following suggestions might help.

Symptom	Suggestion
Trouble receiving.	Make sure POWER is on.
	Make sure SQUELCH is adjusted properly.
	Be sure RF GAIN is fully clockwise.
	Make sure the CB is set to an operating channel.
	Make sure the microphone is securely connected.
	Press ACE to improve communication quality.
	Check for a good antenna connection
Trouble receiving	Make sure the antenna cable is securely connected to the antenna connector.
	Make sure the antenna is fully extended.
	Make sure all connections are secure and free of corrosion.
	Make sure CB/WX/COMPASS is set to CB .
The CB is completely Inoperable	Check the DC power cord and in-line fuse.
	Replace the fuse . See " Replacing the Fuse" on Page 19.

If these tips do not solve the problem ,do not attempt repairs or adjustments yourself. The CB should be serviced only by a qualified radio technician .If you still have problems ,take your CB to your local RadioShack store for assistance .

CARE AND MAINTENANCE

Your RadioShack TRC-520 40-Channel Mobile CB Radio is an example of superior design and craftsmanship.The following suggestions will help you care for your CB so you can enjoy it for years.



Keep the CB dry. If it gets wet, wipe it dry immediately. Liquids might contain minerals that can corrode the electronic circuits.



Use and store the CB only in normal temperature environments. Temperature extremes can shorten the life of electronic devices and distort or melt plastic parts



Keep the CB away from dust and dirt, which can cause premature wear of part.



Handle the CB gently and carefully. Dropping it can damage circuit boards and cases and can cause the CB to work improperly.



Wipe the CB with a damp cloth occasionally to keep it looking new. Do not use harsh chemicals ,cleaning solvents ,or strong detergents to clean the CB.

Modifying or tampering with the CB's internal components can cause a malfunction and might invalidate its warranty and void your FCC authorization to operate it .If your CB is not performing as it should , take it to your local RadioShack store for assistance.

REPLACING THE FUSE

The TRC-520's 2-amp in line fuse helps protect your CB from power surges and short circuits. When replacement is required, use a 2 amp, fast-acting glass fuse, available at your local RadioShack store.

Follow these steps to replace the fuse.

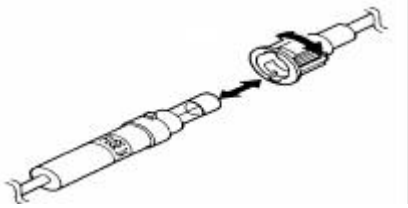

1. Make sure the vehicle and CB are both off.

2. Hold the fuse holder at both ends, push the ends together, twist one end counterclockwise, and pull them apart.

3. Remove the old fuse and inspect its condition. If it is blown, insert a new one of the same type and rating. If it is not blown, reinsert it.

Caution : Do not use a fuse with ratings other than those specified here. Doing so might damage your TRC-520

4. Push the fuse holder ends together and twist one end clockwise.

THE FCC WANTS YOU TO KNOW

Your CB might cause TV or radio interference even when it is operating properly. To determine whether your CB is causing the interference, turn off your CB. If the interference goes away, your CB is causing it. Try to eliminate the interference by:

- moving your CB away from the receiver
- contacting your local RadioShack store for help

If you cannot eliminate the interference, the FCC requires that you stop using your CB radio.

Any adjustment to a CB must be made by a qualified technician using the proper test equipment.

To be safe and sure:

- Never open your CB radio's case.
- Never change or replace anything in your CB radio.

SPECIFICATIONS

GENERAL

Channels.....	40 Channels
Frequency Range.....	29.965MHz to 27.405 MHz
Power Requirement.....	13.8V DC(12-16 Volts DC , Negative Ground)
Dimensions(HWD).....	180(L)x35(H)x140(D)mm
Weight.....	0.850kg

RECEIVER

Sensitivity.....	0.5 μ V or better for 10 dB(S+N)/N
Adjacent Channel Rejection.....	50dB (at 10 KHz)
Audio Output.....	4.5 Watts(Maximum)
Frequency Response.....	450-2500 Hz
Intermediate Frequency.....	1 st IF: 10.695 MHz 2 nd IF:455 KHz
Cross Modulation.....	50 dB
Squelch.....	Adjustable from 0.5 μ V to 1 mV

TRANSMITTER

Output Power.....	4 Watts (FCC Maximum)
Type of Modulation.....	AM Double- Sideband , Full Carrier Modulation
Modulation Capability.....	\pm 90%
Spurious Emission.....	Less than - 70 dB
Frequency Tolerance.....	\pm 200 Hz
Antenna Impedance.....	50 Ohm
Current Drain.....	(13.8-volt supply)1 Amp with No Modulation 1.6 Amps with 80 % Modulation

Limited Ninety-Day Warranty

This product is Warranted by RadioShack against manufacturing defects in material and workmanship under normal use for ninety(90)day from the date of purchase from RadioShack company Owned stores and authorized RadioShack franchisees and dealers. EXCEPT AS PROVIDED HEREIN, RadioShack MAKERS NO EXPRESS WARRANTIES AND ANY IMPLIED WARRANTIES, CONTAINED HEREIN. EXCEPT AS PROVIDE HEREIN, RadioShack SHALL HAVE NO LIABILITY OR RESPONSIBILITY TO CUSTOMER OR ANY OTHER PERSON OR ENTITY WITH RESPECT TO ANY LIABILITY, LOSS OR DAMAGE CAUSED DIRECTLY OR INDIRECTLY BY USE OR PERFORMANCE OF THE PRODUCT OR ARISING OUT OF ANY BREACH OF THIS WARRANTY, INCLUDING ,BUT NOT LIMITED TO ANY DAMAGES RESULTING FROM INCONVENIENCE' LOSS OF TIME DATA PROPERTY REVENUE, OR PROFIT OR ANY INDIRECT, SPECIAL, INCIDENTAL, OR CONSEQUENTIAL DAMAGES, EVEN IF RadioShack HAS BEEN ADVISED OF THE POSSIBILITY OF SUCH DAMAGES.

Some states do not allow the limitations on how long an implied warranty lasts or the exclusion of incidental or consequential damages, so the above limitations or exclusions may not apply to you. In the event of a product defect during the warranty period, take the product and the RadioShack Sales receipt as proof of purchase date to any RadioShack store. RadioShack will, at its option, unless otherwise provided by law; (a) correct the defect by product repair without charge for part and Labor; (b) replace the product with one of the same or similar design; or (c) refund the purchase Price. All replaced part and products, and products on which a refund is made, become the property of RadioShack. New or reconditioned part and products may be used in the performance of warranty service. Repaired or replaced parts and products are warranted for the remainder of the original warranty period. You will be charged for repair or replacement of the product made after the expiration of the warranty period.

This warranty does not cover; (a) damage or failure caused by or attributable to acts of God, abuse, Accident, misuse, improper or abnormal usage, failure to follow instructions, improper installation or Maintenance, alteration, lightning or other incidence of excess voltage or current; (b) any repairs Other than those provide by a RadioShack Authorized Service facility; (c) consumables such as Fuses or batteries; (d) cosmetic damage; (e) transportation, shipping or insurance costs; or (f) costs Of product removal, installation, set-up service adjustment or reinstallation

This warranty gives you specific legal rights, and you may also have other rights which vary from state to state

Radio Shack Customer Relations, 200 Taylor Street, 6th Floor, Fort Worth, TX 76102

We Service What we sell

03/01

Please read before using this equipment.

TRC-520

**40-Channel Mobile CB Radio
with WX Alert and SAME / E-Compass**