

User Manual

DRAFT COPY OF THE INSTRUCTION MANUAL

Precautions!

Before you read anything else, please observe the following:

Warning!

Uniden America Corporation **DOES NOT** represent this unit to be waterproof. To reduce the risk of fire, electrical shock, or damage to the unit, **DO NOT** expose this unit to rain or moisture.

Rechargeable Nickel-Cadmium Battery Warning

- This equipment contains a rechargeable nickel-cadmium battery.
- Cadmium is a chemical known to the State of California to cause cancer.
- The rechargeable nickel-cadmium battery contained in this equipment may explode if disposed of in a fire.
- **Do not** short-circuit the battery.
- Do not charge the rechargeable nickel-cadmium battery used in this equipment in any charger other than the one designed to charge this battery as specified in the owner's manual. Using another charger may damage the battery or cause the battery to explode.

Rechargeable Nickel-Cadmium Batteries Must Be Recycled or Disposed of Properly



- Uniden voluntarily participates in an RBRC* industry program to collect and recycle nickel-cadmium batteries at the end of their useful life, when taken out of service within the United States. The RBRC* program provides a convenient alternative to placing used nickel-cadmium batteries into the trash or municipal waste stream, which is illegal in some areas.
- Through the RBRC* program, Uniden makes it easy for you to drop off the used battery at local retailers of replacement nickel-cadmium batteries. You may also contact your local recycling center for information on where to return the used battery. Please call 1-800-8-BATTERY for information on Ni-Cd battery recycling in your area. Uniden's involvement in this program is part of its commitment to protecting our environment and conserving natural resources.
- RBRC* is a registered trademark of the Rechargeable Battery Recycling Corporation.



The exclamation point within an equilateral triangle is intended to alert the user to the presence of important operating and maintenance (servicing) instructions in the literature accompanying the appliance.

UDZZ66843BA

Important Safety Instructions

When using your telephone equipment, these basic safety precautions should always be followed to reduce the risk of fire, electrical shock, and injury to persons:

1. Read and understand all instructions.
2. Follow all warnings and instructions marked on the product.
3. Unplug this product from the wall outlet before cleaning. Use a dry cloth for cleaning without liquid or aerosol cleaners.
4. Do not use this product near water; for example, near a bath tub, wash bowl, kitchen sink or laundry tub, in a wet basement, or near a swimming pool.
5. Do not place this product on an unstable cart, stand, or table. The telephone may fall, causing serious damage to the unit.
6. Slots and openings in the cabinet and the back or bottom are provided for ventilation. To protect the product from overheating, these openings must not be blocked or covered. This product should never be placed near or over a radiator or heat register. This product should not be placed in a built-in installation unless proper ventilation is provided.
7. This product should be operated only from the type of power source indicated on the marking label. If you are not sure of the type of power supply to your home, consult your dealer or local power company.
8. Do not allow anything to rest on the power cord. Do not locate this product where the cord will be damaged by persons walking on it.
9. Do not overload wall outlets and extension cords, as this can result in the risk of fire or electrical shock.
10. Never push objects of any kind into this product through cabinet slots, as they may touch dangerous voltage points or short out parts that could result in a risk of fire or electric shock. Never spill liquid of any kind on the product.
11. To reduce the risk of electric shock, do not disassemble this product. Take it to qualified service personnel when service or repair work is required. Opening or removing covers may expose you to dangerous voltages or other risks. Incorrect reassembly can cause electric shock when the appliance is subsequently used.

1/4

12. Unplug this product from the wall outlet and refer servicing to qualified service personnel under the following conditions:
- A. When the power supply cord is damaged or frayed.
 - B. If liquid has been spilled into the product.
 - C. If the product has been exposed to rain or water.
 - D. If the product does not operate normally when following the operating instructions. (Adjust only those controls that are covered by the operating instructions. Improper adjustment of other controls may result in damage and will often require extensive repair work by a qualified technician.)
 - E. If the product has been dropped or the cabinet has been damaged.
 - F. If the product exhibits a distinct change in performance.
13. Do not use the telephone to report a gas leak in the vicinity of the leak.

Additional Battery Safety Precautions

Caution! *To reduce the risk of fire or injury to persons by the battery, read and follow these instructions:*

1. Use only the appropriate type and size battery pack specified in the owner's manual.
2. Do not dispose of the battery pack in a fire. The cell may explode. Check the nickel-cadmium battery disposal package insert for disposal instructions.
3. Do not open or mutilate the battery pack. Released electrolyte is corrosive and may cause damage to the eyes or skin. It may be toxic if swallowed.
4. Exercise care in handling the battery in order not to short the battery with conducting materials such as rings, bracelets, and keys. The battery or conductor may overheat and cause burns.
5. Charge the battery pack provided with or identified for use with this product only in accordance with the instructions and limitations specified in the owner's manual provided for this product.
6. Observe proper polarity orientation between the battery pack and battery charger.

SAVE THESE INSTRUCTIONS!

Important Electrical Considerations

Unplug all electrical appliances when you know an electrical storm is approaching. Lightning can pass through your household wiring and damage any device connected to it. This phone is no exception.

Warning!

Please do not attempt to unplug any appliance during an electrical storm.

The FCC Wants You To Know

Changes or modifications to this product not expressly approved by Uniden, or operation of this product in any way other than as detailed by the owner's manual, could void your authority to operate this product. The equipment cannot be used on public coin phone service provided by the telephone company. Connection to party line service is subject to state tariffs. (Contact the state public utility commission, public service commission or corporation commission for information.)

Range

Your new phone is designed to achieve the maximum possible range by transmitting and receiving according to the highest specifications set forth by the FCC. We have rated this phone to operate at a maximum distance with the qualification that the range depends upon the environment in which the telephone is used. Many factors limit range, and it would be impossible to include all the variables in our rating. The Maximum Range rating of this phone is meant to be used as a means of comparison against other range claims.

Telephone Line Problems

The FCC has granted the telephone company the right to disconnect service in the event that your phone causes problems on the telephone line. Also, the telephone company may make changes in facilities and services which may affect the operation of your unit. However, your telephone company must give adequate notice in writing prior to such actions to allow you time for making necessary arrangements to continue uninterrupted service.

If you are having trouble with your telephone service, you must first disconnect your phone to determine if it is the cause of your problem. If you determine that it is the cause, you must leave it disconnected until the trouble has been corrected.

Radio Interference

Radio interference may occasionally cause buzzing and humming in your cordless handset, or clicking noises in the base. This interference is caused by external sources such as TV, refrigerator, vacuum cleaner, fluorescent lighting, or electrical storm. Your unit is NOT DEFECTIVE. If these noises continue and are too distracting, please check around your home to see what appliances may be causing the problem. In addition, we recommend that the base not be plugged into a circuit that also powers a major appliance because of the potential for interference. Be certain that the antenna on the unit is fully extended when needed.

In the unlikely event that you consistently hear other voices or distracting transmissions on your phone, you may be receiving radio signals from another cordless telephone or other source of interference. If you cannot eliminate this type of interference, you need to change to a different channel.

Finally, it should be noted that some cordless telephones operate at frequencies that may cause interference to nearby TVs and VCRs. To minimize or prevent such interference, the base of the cordless telephone should not be placed near or on top of a TV or VCR. If interference is experienced, moving the cordless telephone farther away from the TV or VCR will often reduce or eliminate the interference.

More Than One Cordless Telephone

If you want to use more than one cordless telephone in your home, they must operate on different channels. Press the channel key to select a channel that provides the clearest communication.

Cordless Telephone Privacy

Cordless telephones are radio devices. Communications between the handset and base of your cordless telephone are accomplished by means of radio waves which are broadcast over the open airways. Because of the inherent physical properties of radio waves, your communications can be received by radio receiving devices other than your own cordless telephone unit. Consequently, any communications using your cordless telephone may not be private.

Installation Considerations

Selecting a Location

Before choosing a location for your new phone, there are some important guidelines you should consider:

- The location should be close to both a phone jack and continuous power outlet. (*A continuous power outlet is an AC outlet which does not have a switch to interrupt its power.*)
- Keep the base and handset away from sources of electrical noise such as motors or fluorescent lighting.
- Be sure there is sufficient space to fully extend the base antenna.
- The base can be placed on a desk or tabletop or mounted on a standard AT&T or GTE wall plate.
- You should charge your new phone for 15-20 hours before completing the installation or using the handset.

Telephone Line Outlets

There are two types of phone outlets:

Modular Jack

Most phone equipment available now uses modular jacks. Phone cords are fitted with a molded plastic connector which plugs into this type of jack. If you do not have modular phone jacks, contact your local telephone company for information about their installation.

Hardwired Jack

Some equipment is wired directly to a phone jack, and these types of installations require a modular jack converter. This type of installation is not difficult; however, you should contact your Uniden telephone dealer or a telephone supply store for advice about the proper adapter or converter for your particular situation.

Connecting the Telephone Cords

Consider these safety guidelines before connecting the telephone cords:

Caution!

- Never install telephone wiring during a lightning storm.
- Never touch uninsulated telephone wires or terminals unless the telephone line has been disconnected.
- Use caution when installing or modifying telephone lines.

Applying Power to the Base

This phone requires an AC outlet, without a switch to interrupt power, and the included AC adapter. To relieve strain on the DC plug when the phone is placed on a desk or table, wrap the power cord around the strain relief notch on the bottom of the base.

NOTE: Place the power cord so that it does not create a trip hazard, or where it could become chafed and create a fire or other electrical hazards.

Adapter Safety Features

If the AC adapter furnished with this phone has a polarized line plug (a plug having one blade wider than the other), this plug will fit into the power outlet only one way. If you are unable to insert the plug fully into the outlet, try reversing the plug.

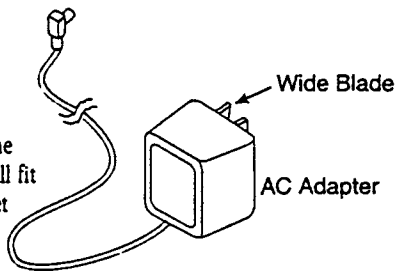

Do not alter the shape of the blades of the polarized plug!

NOTE: If you cannot plug the AC adapter into the outlet, contact someone about replacing the outlet.

Plug the AC Adapter into a standard 120 VAC wall outlet. Do not use an outlet controlled by a wall switch.



Use only the Uniden AC Adapter supplied with this phone.

One Year Limited Warranty

Important: Evidence of original purchase is required for warranty service.

WARRANTOR: UNIDEN AMERICA CORPORATION ("Uniden")

ELEMENTS OF WARRANTY: Uniden warrants, for one year, to the original retail owner, this Uniden Product to be free from defects in materials and craftsmanship with only the limitations or exclusions set out below.

WARRANTY DURATION: This warranty to the original user shall terminate and be of no further effect 12 months after the date of original retail sale. The warranty is invalid if the Product is (A) damaged or not maintained as reasonable or necessary, (B) modified, altered, or used as part of any conversion kits, subassemblies, or any configurations not sold by Uniden, (C) improperly installed, (D) serviced or repaired by someone other than an authorized Uniden service center for a defect or malfunction covered by this warranty, (E) used in any conjunction with equipment or parts or as part of any system not manufactured by Uniden, or (F) installed or programmed by anyone other than as detailed by the owner's manual for this product.

STATEMENT OF REMEDY: In the event that the product does not conform to this warranty at any time while this warranty is in effect, warrantor will either, at its option, repair or replace the defective unit and return it to you without charge for parts, service, or any other cost (except shipping and handling) incurred by warrantor or its representatives in connection with the performance of this warranty. Warrantor, at its option, may replace the unit with a new or refurbished unit. THE LIMITED WARRANTY SET FORTH ABOVE IS THE SOLE AND ENTIRE WARRANTY PERTAINING TO THE PRODUCT AND IS IN LIEU OF AND EXCLUDES ALL OTHER WARRANTIES OF ANY NATURE WHATSOEVER, WHETHER EXPRESS, IMPLIED OR ARISING BY OPERATION OF LAW, INCLUDING, BUT NOT LIMITED TO ANY IMPLIED WARRANTIES OF MERCHANTABILITY OR FITNESS FOR A PARTICULAR PURPOSE. THIS WARRANTY DOES NOT COVER OR PROVIDE FOR THE REIMBURSEMENT OR PAYMENT OF INCIDENTAL OR CONSEQUENTIAL DAMAGES. Some states do not allow this exclusion or limitation of incidental or consequential damages so the above limitation or exclusion may not apply to you.

LEGAL REMEDIES: This warranty gives you specific legal rights, and you may also have other rights which vary from state to state. This warranty is void outside the United States of America.

PROCEDURE FOR OBTAINING PERFORMANCE OF WARRANTY: If, after following the instructions in the owner's manual you are certain that the Product is defective, pack the Product carefully (preferably in its original packaging). The Product should include all parts and accessories originally packaged with the Product. Include evidence of original purchase and a note describing the defect that has caused you to return it. The Product should be shipped freight prepaid, by traceable means, to warrantor at:

Uniden America Corporation
4700 Amon Carter Blvd
Fort Worth, TX 76155
(800)297-1023, 8 a.m. to 5 p.m. Central,
Monday through Friday

© January 1999 Uniden America Corporation. All rights reserved.
Printed in China.

4/4

INTRODUCTION

TO YOUR NEW PHONE

Introduction

Thank you for choosing the Uniden EXR 2480 cordless telephone. This phone is designed to exacting standards that provide reliability, long life and outstanding performance.

Note: Some illustrations in this manual may differ from the actual unit for explanation purposes.

Features

- 2.4 GHz ~~Extended Range~~ Spread Spectrum Technology
 - Secure Digital Transmission
 - ~~Answering Device~~ Integrated Telephone Answering Device (ITAD)
 - 50 Number Caller ID Memory
 - 10 ~~Number Memory~~ Enhanced Memory Dial Locations
 - 32 Digit Redial
 - 3-Line, 16 Character Backlit LCD Handset Display
 - Redial, Flash and Pause
 - Pulse / Tone Dialing
 - 4 Hour Talk Time
 - 7 Day Standby Battery Life
 - Handset Earpiece and Ringer Volume Control
 - Speakerphone
 - 3-Way Conference Operation
 - 20 channel AutoScan
 - Back-up Power Supply with Optional Battery Pack
 - Caller ID and Call Waiting Caller ID (CIDCW)
- 2-way Page / Intercom

Digital Spread Spectrum Technology utilizes a "wider frequency band" vs. a "single narrow band" used in standard digital transmissions. The result is a more secure conversation with the clarity of digital sound, extended range, and minimal interference from other cordless phones.

Random Code™ digital security automatically selects one of over 65,000 codes for the handset and base. This feature prevents unauthorized calls as a result of your phone being activated by other equipment.

Controls and functions

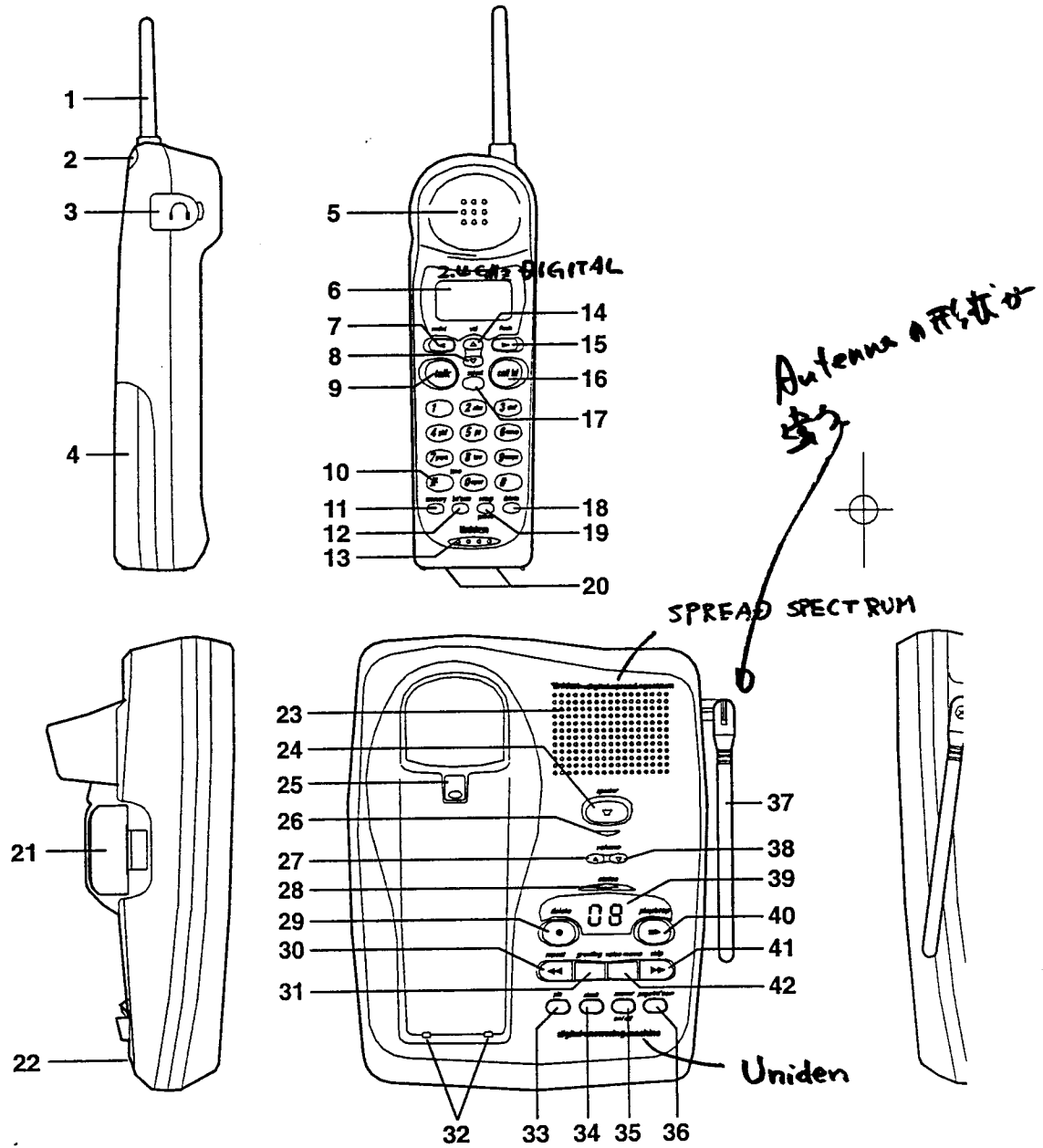

- | | |
|--------------------------------|--------------------------------|
| 1. Handset antenna | 21. Spare battery compzrtment |
| 2. Slot cover | 22. Base microphone |
| 3. Handset jack | 23. Base speaker |
| 4. Handset battery compartment | 24. Speaker key |
| 5. Handset earpiece | 25. Handset clip storage |
| 6. LCD display | 26. Speaker LED |
| 7. Ridial/Backspace key | 27. Volume up key |
| 8. Volume/Cursor down key | 28. Status LED |
| 9. Talk key | 29. Delete key |
| 10. Tone key | 30. Repeat key |
| 11. Memory key | 31. Greeting key |
| 12. Intercom key | 32. Base contact |
| 13. Handset microphone | 33. Pin code key |
| 14. Volume/Cursor up key | 34. Clock key |
| 15. Flash/Cursor forward key | 35. Answer on/off key |
| 16. Call ID key | 36. Page/Intercom key |
| 17. Selest key | 37. Base antenna |
| 18. Delete key | 38. Volume down key |
| 19. Setup/Pause key | 39. Message counter display |
| 20. Handset contact | 40. Play/Stop key |
| | 41. Skip key |
| | 42. Voice memo key |
| | 43. Desktop/Wall mount adapter |
| | 44. Record time switch |
| | 45. Ring time switch |
| | 46. Reset switch |
| | 47. Ringer off-on switch |
| | 48. Pulse-Tone switch |
| | 49. DC power input |
| | 50. Phone jack |



-37
-38
-39
-40
-41
-42

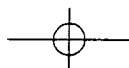
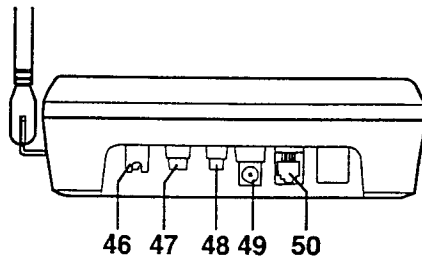
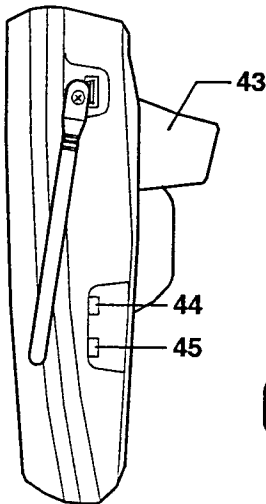

CONTENTS

OF YOUR OWNER'S MANUAL

Contents

Introduction / Features.....inside front cover
 Controls and Functionsinside front cover

Getting Started
 Read this first.....3
 Step 1: Checking the package contents4
 Step 2: Setting up the base unit5
 Mounting the base unit on a wall8
 Step 3: Preparing the battery pack10
 Step 4: Setting the Caller ID options.....12
 Entering your area code13

Basics
 Making a call14
 Receiving a call15
 Adjusting ringer and earpiece volume.....16
 Redialing a call17
 Using the speaker phone18
 Using your EXR 2480 intercom19
 Transferring a call.....20

Memory Dialing
 Storing phone numbers and names21
 Making calls with memory dialing.....23
 Editing a stored name and/or phone number ...25
 Erasing a stored name and phone number.....27

3-way Conference Feature
 3-way conferencing.....29

Caller ID features
 Caller ID service30
 When the telephone rings31
 Viewing the Caller ID Message list32
 Deleting information from Caller ID list.....33
 Using the Caller ID list35
 Using "Caller ID with call waiting" service37

The Integrated Answering Device
 Features38
 Setting up your answering system39
 Using your answering system43

Additional Information
 Changing the digital security code.....48
 Headset installation48
 Installing the beltclip.....49
 Note on power sources50
 Maintenance50
Troubleshooting51
Specifications53
Index54

Getting Started

Basics

Memory Dialing

3-way Conference Features

Caller ID Features

The Integrated Answering Device

Additional Information

Read this first

This cordless telephone must be set up before use. Follow these steps;

Step 1 (page 4)

Unpack the telephone and accessories.

Step 2 (page 5 to 9)

Next, choose the best location to set up the base unit.

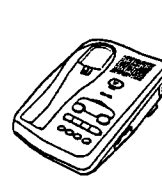

Base unit

Step 3 (page 10 to 11)

Then, insert the battery pack into the handset. You have to charge the battery pack for more than 12 hours before using the phone.



Handset

Step 4 (page 12 to 13)

Finally, set Caller ID options and store your area code in the memory to use the Caller ID service.



Handset

Note: Skip the setting of area code if your calling area requires 10 digit dialing.

About the digital security code

This cordless telephone uses a digital security code to prevent unauthorized access to your base unit. This security code prevents other cordless handsets from making calls through your base unit. A random security code will be assigned automatically between your base unit and handset when you charge the battery pack for the first time.

If you want to reset the security code, see page 48.

Checking the package contents

Make sure you have received the following items in the package. If any of these items are missing or damaged, contact the **Uniden Parts Department** (see below).

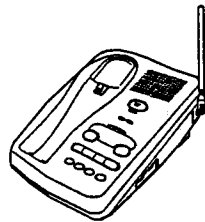

• Base unit



• Handset

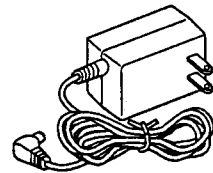

• AC adapter (AD-420)

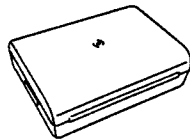

• Rechargeable battery pack (BT-905) (2)

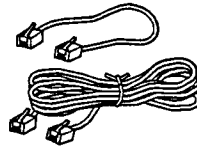

• Telephone line cord (2)

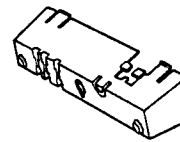

• Wall mount adapter

↓
確認願います。



• Beltclip

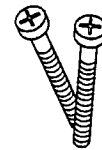

• Wall mounting screws (2)

- This Owner's Manual
- Precautions and Important Safety Instructions
- Registration Card

TO: 電気
確認願います。

Uniden Parts Department
 (800) 554-3988
 Hours: M-F 8:30 AM to 5:00 PM CST.
 We can also be reached on the web at www.uniden.com.

Setting up the base unit

Do the following steps.

- Choose the best location
- Connect the base unit
- Choose the dialing mode

Choose the best location

Before choosing a location for your new phone, read the **INSTALLATION CONSIDERATIONS** included in the **PRECAUTIONS AND IMPORTANT SAFETY INSTRUCTIONS** brochure. Here are some important guidelines you should consider:

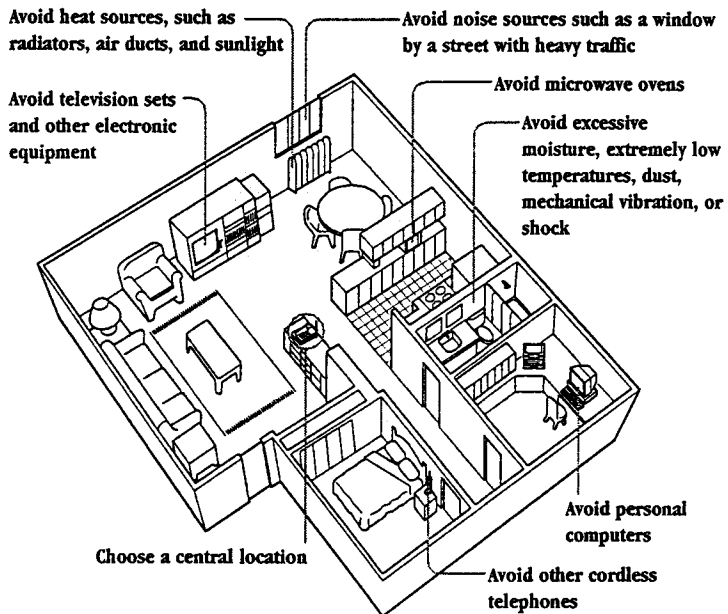

- You should charge your handset for 12-15 hours before using the phone.
- The location should be close to both a phone jack and a continuous power outlet which is not switchable.
- Keep the base and handset away from sources of electrical noise such as motors and fluorescent lighting.
- Be sure there is sufficient space to raise the base antenna fully vertical.
- The base can be placed on a desk, tabletop or mounted on a standard wall plate.



Place the power cord so it does not create a trip hazard, or where it could become chafed and create a fire or electrical hazard.

Connect the base unit

If you want to install the base unit on the wall, see page 8.

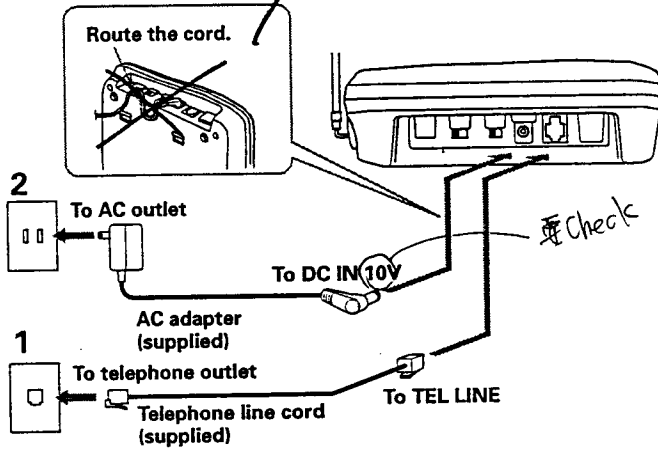

實際は
Wall Mount
1=2-1=2 3(1+1)
5=1=10??...3.

1 Connect the telephone line cord to the **TEL LINE** jack and to a telephone outlet.

2 Connect the AC adapter to the **DC IN 10V** jack and to a standard 120V AC wall outlet.

3 Snap the desktop/wall mount adapter into the top of the base as shown.

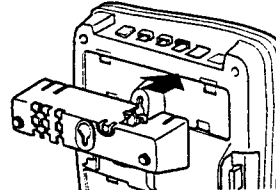

4 Set the base unit on a desk or tabletop and place the handset on the base unit. Then raise the antenna to a vertical position.

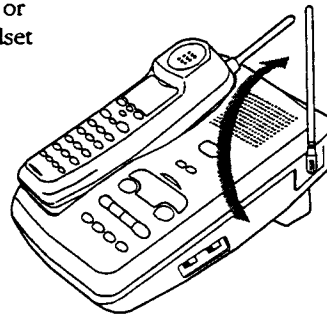



Use only the supplied AD-420 AC adapter. Do not use any other AC adapter.

Check

Polarity of the plug



Connect the AC adapter to a continuous power supply.

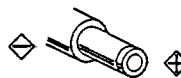

Place the base unit close to the AC outlet so that you can unplug the AC adapter easily.



If your telephone outlet isn't modular, contact your telephone company for assistance.

Modular



Choose the dialing mode

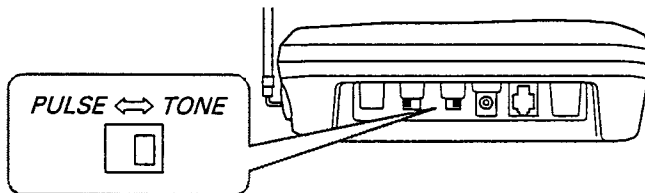

Depending on your dialing system, set the **TONE/PULSE** switch as follows:

If your dialing system is	Set the switch to
Tone	<i>TONE</i>
Pulse	<i>PULSE</i>

If you aren't sure of your dialing system

Make a trial call with the **TONE/PULSE** switch set to *TONE*. If the call connects, leave the switch as is; otherwise, set to *PULSE*.

Mounting the base unit on a wall

Standard wall plate mounting

This phone can be mounted on any standard telephone wall plate.

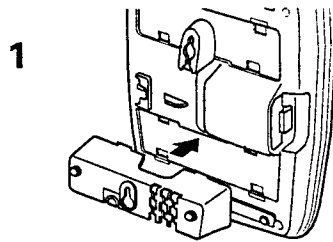

1 Snap the desktop/wall mount adapter into the top of base as shown.

2 Plug the telephone line cord to the **TEL LINE** jack and the AC adapter to the **DC IN (10V)** jack.

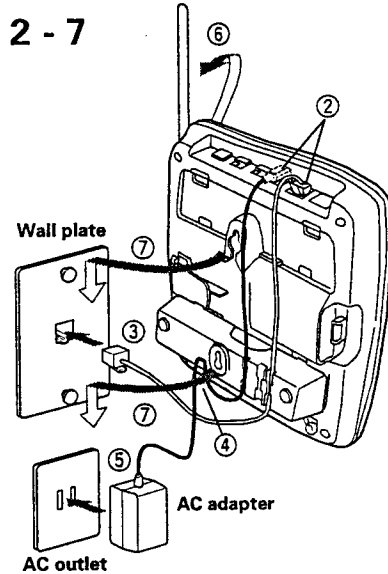

3 Plug the telephone line cord into the telephone outlet.

4 Wrap the AC adapter cord inside the molded wiring channel. Then wrap the cord around the strain relief notch.

5 Plug the AC adapter into a standard 120V AC wall outlet.

6 Raise the antenna to a vertical position.

7 Align the mounting slots on the base with the mounting posts on the wall. Push in and down until the phone is firmly seated.

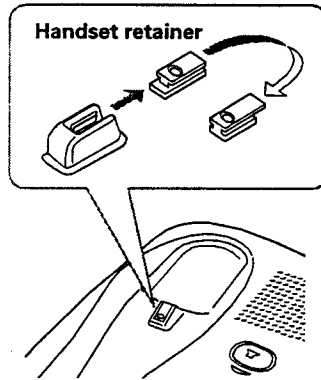

- 8** On the base unit, pull the handset retainer out of the slot. Rotate it clockwise 180 degrees.
- 9** Flip the retainer from front to back. Slide it back into the slot so that the lip of the retainer is up and the oval is down. The retainer holds the handset in place.

Direct wall plate mounting

If you don't have a standard wall plate, you can mount your phone directly to the wall. Before doing this, consider the following:

- Avoid electrical cables, pipes, or other items behind the mounting location, that could cause a hazard when inserting screws into the wall.
- Try to mount your phone within 10 - 15 feet of a working phone jack to avoid excessive cord lengths.
- Make sure the wall material is capable of supporting the weight of the base and handset.
- Use #10 screws with anchoring devices suitable for the wall material where the base unit will be placed.

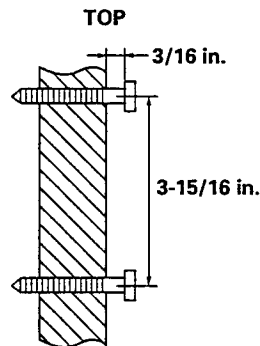

- 1** Insert two mounting screws into the wall, (with their appropriate anchoring device), 3-15/16 inches apart. Allow about 3/16 of an inch between the wall and screwheads for mounting the phone.
- 2** Refer to steps 1 through 9 on page 8 and 9 to mount the telephone.

Preparing the battery pack

Charge the battery pack for more than 12-15 hours before you start using your phone.

NOTE

Use only Uniden Battery
BT-990.

要確認

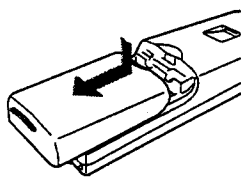

1 Remove the battery cover.

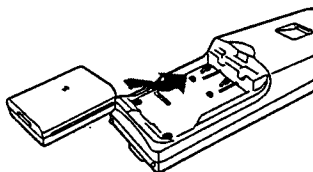

2 Install the battery pack with the label down.

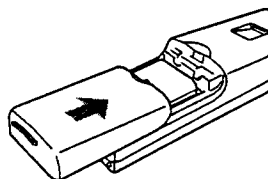

3 Slide the battery cover forward until it snaps into place.

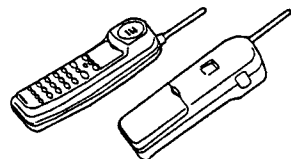

4 Place the handset on the base.

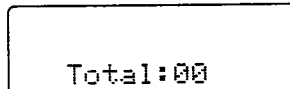

Make sure that the "status" LED of the base unit lights, and charging begins. Charge the battery for at least 12-15 hours.

You can place the handset either side up for charging the battery.



Even when the battery pack is not being used, it will gradually discharge over a long period. For optimum performance, be sure to return the handset to the base unit after a telephone call for charging the battery.



Rechargeable batteries have a memory effect that reduces standby and talk time. To avoid this memory effect, on a monthly basis, use the phone until the Battery lamp blinks. Then charge the battery for 15 hours.

Battery use time (per charge)

From fully charged

- Four hours continuous use.
- Seven days when the handset is in the standby mode.

When the battery charge becomes low

When the voltage of battery pack in the handset is very low and needs to be charged, the phone is programmed to eliminate functions in order to save power. If the battery charge becomes low Battery lamp blinks. If the phone is in use, the handset beeps. Complete your conversation as quickly as possible and return the handset to the base unit for charging.

Cleaning the battery contacts

To maintain a good charge, it is important to clean the battery contacts on the handset and base unit about once a month. Use a pencil eraser or other contact cleaner.

Do not use any liquids or solvents.

Charging optional battery packs

The base of your phone is equipped with a compartment for charging an extra battery pack for use in your handset.

You can obtain an extra battery pack from your authorized Uniden dealer.

1. Position the battery pack so the contacts are face up.
2. Slide the battery pack into the charging compartment until it locks into place.

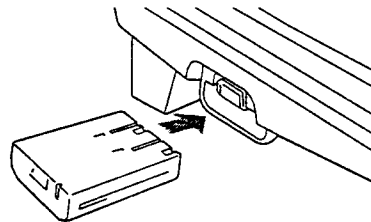

3. Charge the battery for 24 hours.

When charging is complete, lift the latch to remove the battery pack. To install the charged battery into the handset, see Preparing the battery pack, page 10.



In the event of a power failure, your spare battery pack temporarily provides power for the base so you can still use your phone.

Setting the Caller ID options

There are three Caller ID options, Auto Talk, CIDCW (Caller ID with Call Waiting), and Area Code.

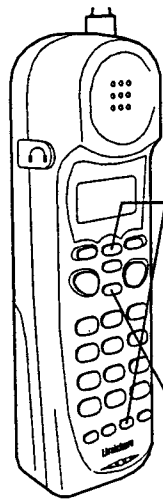

- 1** In the standby mode, press **setup/pause**.

```
1▶Auto Talk:Off
2▶CIDCW      :On
3 Area Code:
```

- 2** Press **▲** or **▼** to move the cursor to the item that is to be set.

Example: To select CIDCW

```
1 Auto Talk:Off
2▶CIDCW      :On
3 Area Code:
```

- 3** For Auto Talk and CIDCW press **select** to toggle between on and off. For the Area Code setting please see page 13.

- 4** To complete the settings, press **setup/pause**, then the handset returns to standby mode.

Entering your area code



If your calling area requires 10-digit dialing, skip this step.

You may wish to enter your local area code before you use this phone for the first time, or if you move to a new area. The phone can then distinguish local or long distance calls to properly dial directly from the Caller ID record. (See page 35.)

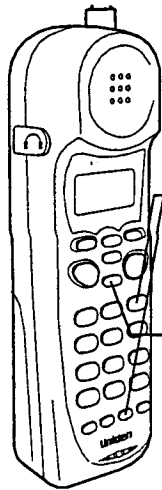

- 1** When the phone is in the standby mode, press **(setup/pause)**.

```
1▶Auto Talk:Off
2 CIDCW :On
3 Area Code:
```

- 2** Press **(3)** to select "Area Code".

```
1 Auto Talk:Off
2 CIDCW :On
3▶Area Code:
```

- 3** Press **(select)**.

```
1 Auto Talk:Off
2 CIDCW :On
3 Area Code:
```

- 4** Use the dial buttons (**(0)** to **(9)**) to enter the 3-digit area code.

- 5** Press **(select)**.

A beep sounds and the displayed area code is entered.

- 6** Press **(setup/pause)** to complete the setting. Or return the handset to the base unit to complete the setting mode and set the handset to the standby mode.



When the area code has already been stored in memory, the stored area code will be displayed. To change it, use the **(delete)** and dial buttons to enter the new area code.

```
1 Auto Talk:Off
2 CIDCW :On
3 Area Code:818
```

To complete the setting, press **(setup/pause)** or return the handset to the base unit.

Making a call



The phone number can be up to 32 digits.

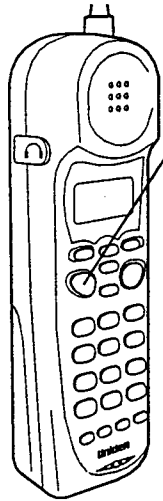

Handset on the base

- 1 Dial the phone number.
- 2 Press **talk**.
- 3 To hang up, press **talk** or return the handset to the base.

Handset off the base

- 1 Press **talk**.
- 2 Dial the phone number.
- 3 To hang up, press **talk** or return the handset to the base.

Other Operations

To	Do this
To adjust the earpiece volume	Press ▲ or ▼ during the call.
To temporarily switch to tone dial (When the base is set to pulse mode)	Press *tone . The following numbers dialed will be sent as tone dialing.
To enter a pause within dialing sequence dialed	Press setup/pause .

Receiving a call

From the handset

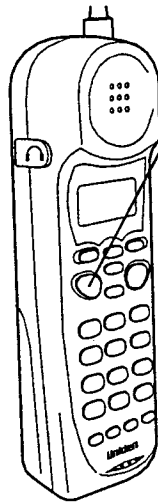

- 1 Phone rings. Calling appears on the display.
- 2 Press **talk** if not in Auto Talk mode. Press any key other than mute key if in Auto Talk mode. "Talk" appears flashing on the display. Then the earpiece ~~ear~~ volume is displayed for 2 seconds.
- 3 The call-time display starts when you begin to talk.
- 4 Press **talk** or place the handset on the base to hang up. The call time will be displayed for about 5 seconds.

From the base

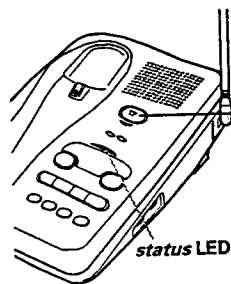

- 1 The phone rings. The **status** LED on the base flashes.
- 2 Press **speaker**.
- 3 Press **speaker** to finish the call.

Adjusting the ringer and earpiece volume

Handset ringer volume

In the standby mode, press **▲** or **▼** on the handset to set the handset ringer volume, High or Low.
~~There are two ringer volume settings, high and low.~~

Ringer High
▼ **↓** **↑** **▲**
Ringer Low



Handset earpiece volume

Pressing **▲** or **▼** during a telephone call will change the earpiece volume of the handset. This setting will remain in effect after the telephone call has ended.

<Loud> **▼** **→** <High> **▼** **→** <Medium> **▼** **→** <Normal>
← **▲** **←** **▲** **←** **▲** **←** **▲** **←**

When you press **▲** in Loud mode or press **▼** in Low mode, error sound beeps.

Base ringer switch

This switch turns the base ringer on or off.

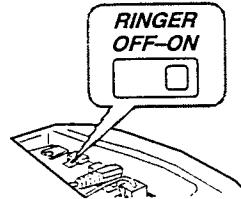

Base speaker volume

To control the speaker volume of the base, adjust the **volume ▲** and **volume ▼** button as desired. The volume setting from 1 (lowest) to 10 (highest) appears in the message counter LED.

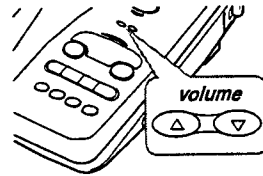



If the recently dialed number exceeds 32 digits, only the first 32 digits are retained for redialing.

Redialing a call

The last phone numbers entered can be quickly redialed.

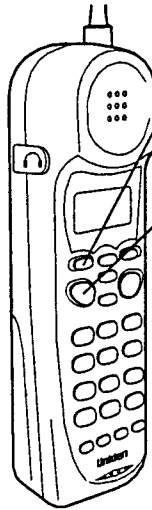

Handset on the base

- 1 Press **redial**.
The phone number that was last dialed appears on the display.
- 2 Press **talk**. "Talk" appears flashing on the display, then the volume setting is displayed.
- 3 Then the selected number is dialed. After about 5 seconds, the call-time display appears.
- 4 Press **talk** or place the handset on the base to complete the telephone call. The call-time will be displayed for about 5 seconds.

Off-hook redialing

- 1 Press **talk**.
- 2 Press **redial**.
The last number dialed will be displayed. dialed.
- 3 Press **talk** or place the handset on the base to complete the telephone call. The call-time will be displayed for about 5 seconds.

Using the speakerphone

You may use the phone as speaker phone to answer calls pressing the **(speaker)** button on the base. To hang up, press **(speaker)** again.

The base microphone is located under the phone. Position yourself approximately 12 inches away from the base and speaker clearly.

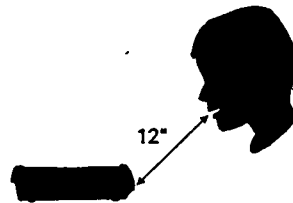

USING THE PAGE FEATURE

- 1 To locate the handset when it is off the base, press **(page/int'com)** on the base. The handset beeps for 60 seconds.
- 2 Place the handset on the base or press **(Int'com)** on the handset to end paging.

Using your EXR 2480 intercom

Intercom from the base to handset

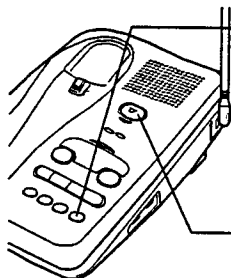

- 1 Press **page/int'com** on the base.
The handset beeps.
- 2 Press **int'com** or **talk** on the handset.
Speak into the mouthpiece to answer
the base.
- 3 To turn off the intercom, press **talk** on
the handset or **speaker** on the base.

Intercom from the handset to base

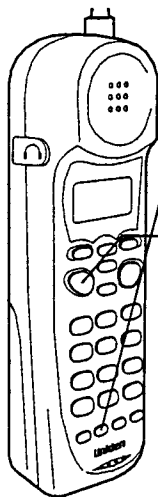

- 1 Press **int'com** on the handset.
The base beeps.
- 2 At the base, press **page/int'com** or
speaker . Speak into the base
microphone to answer the page.
- 3 To turn off the intercom, press **talk** on
the handset or **speaker** on the base.

Transferring a call

To transfer from the handset to the base

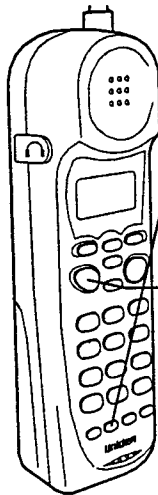

- 1 Press **int'com** on the handset while speaking on the handset. The line will be held, and the inter'com tone will be sounded on the base.
- 2 Press **page/int'com** or **speaker** on the base. The intercom mode is activated and the line is held.
- 3 To transfer to the base, press **talk** on the handset.
To cancel the transfer, press **speaker** on the base.

To transfer from the base to the handset

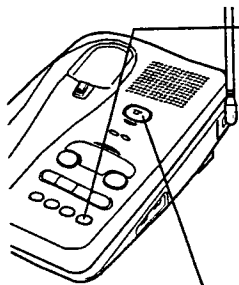

- 1 Press **page/int'com** on the base while speaking on the speaker phone. The line will be held, and the intercom tone will be sounded on the handset.
- 2 Press **int'com** or **talk** on the handset. The intercom mode is activated and the line is held.
- 3 To transfer the handset, press **speaker** on the base.
To cancel the transfer, press **talk** on the handset.

Storing phone numbers and names

Your EXR 2480 stores up to 10 name/numbers in handset.

NOTE

You must press a key within 20 seconds or the phone will return to standby. If you return the handset in the cradle the phone will return to standby too. Press **memory** and you can go to memory menu at any time.

You may also press **memory** to quit a storing operation at any time.

DIALING

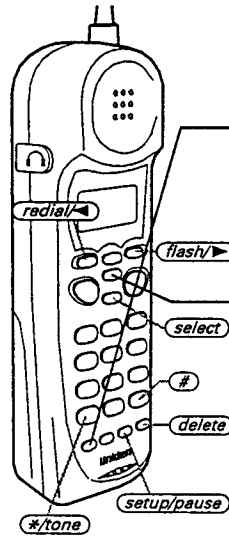

Example: To store a name (MOM AND DAD) and number (8175553300) in memory location 3.

1 Press and hold **memory** until "Memory Store" is displayed.

```
Memory Store
1▶UNIDEN CORP
2 JOHN DOE
```

2 Press **▲** or **▼** to scroll to the memory number where you would like to store the number.

```
Memory Store
2▶JOHN DOE
3
```

Or press the keypad (0 to 9) to select the memory location (0 - 9) where you would like to store the number.

3 Press **select**.
When an empty memory location is selected, "Store Name" is displayed. The cursor flashes indicating that the display is ready for the name to be entered.

```
Store Name
```

```
▶Edit Memory 3
Delete Memory 3
Go Back
```

If this screen appears, the selected memory location is already stored. Then you must either change the entry in this location.

- 4** Use the **▲**, **▼**, **flash/▶**, **redial/◀**, or **delete** keys to enter the name. The name cannot exceed 14 characters.
- Use the **▲** and **▼** key to scroll through the character menu. It contains upper and lower case letters, numbers, punctuation marks and various characters.
 - Use **flash/▶** and **redial/◀** to move the cursor to the desired location.
 - Use **delete** key to delete characters as needed.

- 5** Press **select**.
 "Store Number" is displayed. The cursor flashes indicating that the display is ready for the number to be entered.

Store Number

- 6** Use the number keypad or ***/tone**, **#**, or **setup/pause** keys to enter the phone number.

Store Number
817555330

- The phone number cannot exceed 20 digits.
- Use the **setup/pause** key to enter pause in the dialing sequence. The display shows a "P".



The pause feature is useful for long distance calling, credit card dialing, or sequences that require a pause between digits.

- Use the **delete** key to delete digits as needed.

- 7** Press **select**.
 The handset beeps and displays the confirmation screen. Memory storage is complete.

For example, if you store a name and number into memory location number 3, the display shows "Memory 3 Stored".

Memory 3 Stored

After about 2 seconds, "Memory Store" is displayed.

Memory Store
2▶ JOHN DOE
3 MOM AND DAD

Making calls with memory dialing

Handset on the base

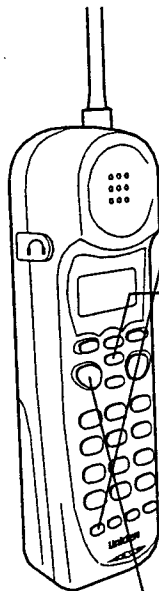

1 Press **memory**.
The handset displays your programmed memory locations.

```
1 UNIDEN CORP
2 JOHN DOE
3 MOM AND DAD
```

2 Press the **▲** and **▼** keys to select the memory location you would like to dial.

For example, if the **▼** key is pressed once, the cursor moves down to the next memory location number.

```
2 JOHN DOE
3 MOM AND DAD
4▶
```

Or enter the two-digit number with the number keypad to select the memory location you would like to dial.

*For example, if you pressed 5 on the keypad, the display shows memory location number 15 with the cursor in that line.

```
5▶ JOHN SMITH
6 <Memory 6>
7
```

3 Press **talk**. "Talk" flashes and the volume setting appears on the display. Then the displayed number is dialed.

```
Talk
0123456789012
```

NOTE

You must press key within 20 seconds or the phone will return to standby, you may also press memory to access a memory menu at any time.

NOTE

If you press **select** before **talk**, you can confirm the name and number stored in the selected memory location.

NOTE

To exit the memory function without dialing, press **memory**. The handset returns to standby.

Display a Programmed Number

Use the **flash/▶** and **redial/◀** keys to toggle between the names display and the numbers display.

Program name		Program number
1 UNIDEN CORP	=▶⇒	1 8178583300
2 JOHN DOE		2 5452930
3▶MOM AND DAD	◀◁=	3▶8175551212



When the stored phone number has 15 or more digits, "→" is displayed next to the 13th digit. Press **flash/▶** to see the extra digits and **redial/◀** to return.

```

5 01234567890123
6▶0118135543293→
7
    
```

Handset off the base

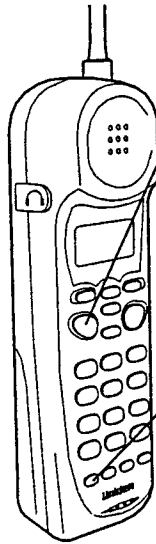

- 1 Press **talk**.
"Talk" flashes and the volume setting appears.

Talk



Talk
<High>

- 2 Press **memory**.

Talk 0:00

- 3 Press the number keypad to select the memory location (0 - 9) of the desired phone number.
The selected phone number is displayed. Then the number is dialed.

Talk 0:35
0123456789012

Editing a stored name and/or phone number

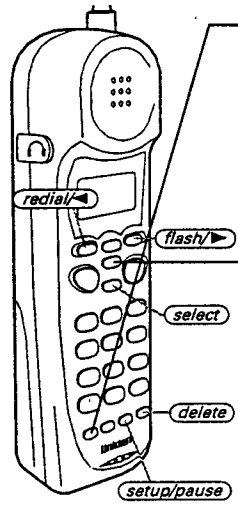

1 Press and hold **memory** for 2 seconds. The display shows the memory screen and any saved name/number.

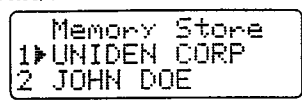

2 Press the **▲** or **▼** keys or number keypad to select the memory location (0 - 9) you would like to edit.



(See page 21.)

3 Press **select**. The following screen appears with the memory location number that you have selected in the display. For example, if you selected memory location number the display shows memory 1 as the location in the selected.

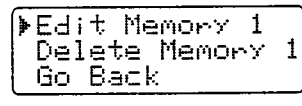

4 Press the **▲** or **▼** key to select "Edit Memory", then press **select**. The following screen appears.



The cursor flashes indicating that the display is ready for the name to be edited. When a name has not been stored, the cursor appears at the beginning of the second line.

5 Press **▲**, **▼**, **flash**, **redial**, or **delete** to edit the name. (See page 22.) To edit only the phone number, skip this step.

- 6** Press **(select)**.
The following screen appears.
The cursor flashes indicating that the display is ready for the number to be edited.

```

Store Number
817858330
    
```

- 7** Use the dial keypad, **(setup/pause)**, or **(delete)** key to edit the phone number.
The phone number cannot exceed 20 digits. (See page 24.)
When the phone number will not be edited, skip this step.

- 8** Press **(select)**.
The handset beeps and displays the confirmation screen. The memory storage is complete.

```

Memory 1 Stored
    
```

For example, if you store a name and number into memory location number 1, the display shows "Memory 1 stored".

After about 2 seconds, "Memory Store" is displayed.

```

Memory Store
1▶UNIDEN CORP
2▶JOHN DOE
    
```

- 9** Press **(memory)** to return to standby mode.

Display a Programmed Number

Use the **(flash/▶)** and **(redial/◀)** key to toggle between the names display and the numbers display.

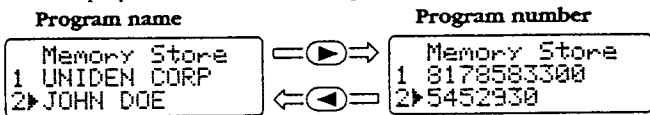

- When the stored phone number has 15 or more digits, "▶" is displayed next to the 13 th digit.

Press **(flash/▶)** to see the extra digits and **(redial/◀)** to return.

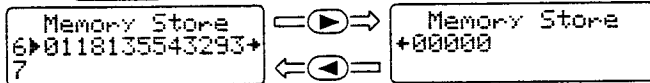

Erasing a stored name and phone number

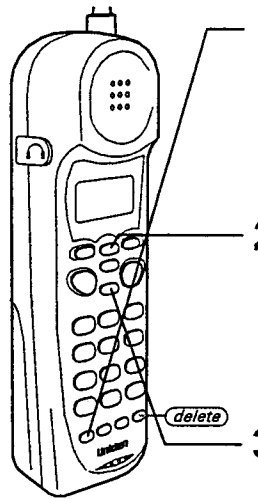

1 Press and hold **memory** for 2 seconds. The display shows the memory screen and any saved name/number.

```
Memory Store
1 UNIDEN CORP
2 JOHN DOE
```

2 Press the **▲** or **▼** keys or number keypad to select the memory location (0 - 9) you would like to edit.

```
Memory Store
1 UNIDEN CORP
2 JOHN DOE
```

3 Press **select**. The following screen appears with the memory location number that you have selected in the display.

For example, if you selected memory location number, the display shows memory 2 as the location in the selected.

```
Edit Memory 2
Delete Memory 2
Go Back
```

4 Press **▼** to move the cursor down to "Delete Memory" command line.

```
Edit Memory 2
Delete Memory 2
Go Back
```

5 Press **select**. The following confirmation screen appears.

```
Delete Memory 2?
Yes
No
```

6 Press **▲** to move the cursor to "Yes".

7 Press **select** or **delete**.

There is a confirmation tone and the entry is deleted. The following screen appears.

For example, if memory location number 2 is selected for deletion, the following display appears as the confirmation screen.

```
Memory 2 Deleted
```

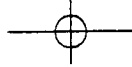

- 8** After 2 seconds the display returns to the "Memory Stone" screen. You may select another number to delete (return to step 4).

A rectangular box representing a screen display. It contains the text "Memory Stone" on the top line, "2" with a right-pointing arrow on the second line, and "3 MOM AND DAD" on the third line.

Memory Stone
2
3 MOM AND DAD

- 9** Press *memory* to return to standby.

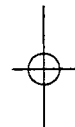
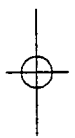



Dialing from the 3-way conversation mode is possible only from the handset.

3-way conferencing

The Uniden EXR 2480 permits 3-way conversations between the handset, base, and outside line.

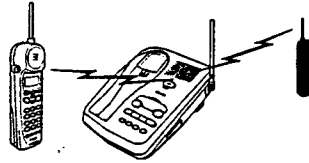

When speaking on the handset

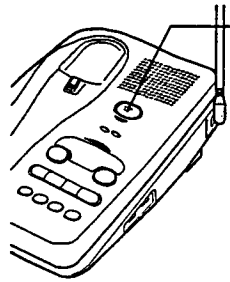

- 1 Press **speaker** on the base to join the 3-way conversation. This will set the 3-way conversation mode.
- 2 Press **speaker** on the base to hang up. The handset remains connected to the outline call.

When speaking on the base

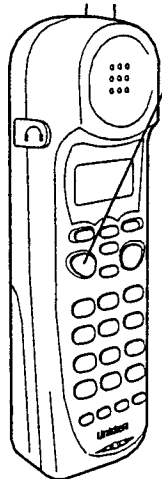

- 1 Press **talk** on the handset to join the 3-way conversation.
- 2 Press **talk** on the handset to hang up.

CONFERENCE FEATURES

Caller ID service

You must subscribe to the Caller ID service from your telephone company to use this feature.

When the telephone rings, the Caller ID feature allows you to view the caller's name and phone number on the display before you answer the phone.

The handset displays the phone number of the incoming call, the name, time, and the number of calls. Additionally, you can dial the displayed number, and store the information for memory dialing.

FEATURES



If you answer a call before the Caller ID message is received (Example: before the second ring), the Caller ID message will not appear.



When the call is received via a telephone company that does not offer Caller ID service, the caller's phone number and name do not appear. (This includes international calls.)



When the call is via a private branch exchange (PBX), the caller's phone number and name may not appear.

When the telephone rings

1 When the Caller ID message is received, the *status* LED blinks.

The display shows the caller's phone number, along with the date and time. The incoming call information is stored in Caller ID record.

If the Caller ID service includes the caller's name, the caller's name appears on the display (up to 15 letters).

The date and time received	5/11 12:30PM 01
Caller's name	UNIDEN CORP
Caller's phone number	813-858-3300

Here are some typical displays;

When the phone number and name data are received

```
5/11 12:30PM 01
UNIDEN CORP
817-858-3300
```

When invalid data is received

Incomplete Data

When a private name is received

```
5/11 12:30PM 01
Private Name
817-858-3300
```

When a private number is received

```
5/11 12:30PM 01
UNIDEN CORP
Private Number
```

When an unknown name is received

```
5/11 12:30PM 01
Unknown Name
817-858-3300
```

When an unknown number is received

```
5/11 12:30PM 01
UNIDEN CORP
Unknown Number
```

2 When the telephone is answered, the display changes to "Talk".



Data errors appear as "###".

```
5/11 12:30PM 01
UNI#EN CORP
813-8###-3300
```

Viewing the Caller ID Message list

The Caller ID list stores information for up to 50 incoming calls - even unanswered calls.

NOTE

If a call comes in via a telephone system that does not offer Caller ID service, no information is stored.

NOTE

"End" appears when you have received all messages in the Caller ID list.

NOTE

Press **(▲)** to return to the summary screen.

NOTE

Each message can be up to 15 characters for the phone number and the name.

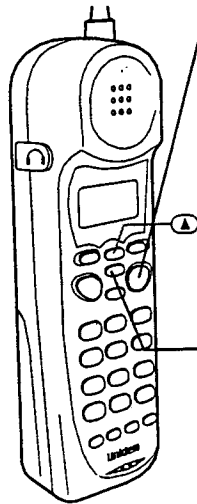

- 1 Press **(call id)**.
When there are new messages you have not reviewed, "New" and the number of calls are displayed. The summary screen shows how many new calls are stored, along with the total of new calls and old calls stored in the list.

```

New :01
Total:02

```

- 2 Press **(▼)** to display the latest caller ID message.

```

5/17 12:30PM 03
UNIDEN CORP
817-858-3300

```

- 3 Press **(▼)** to see the next message.
Or press **(▲)** to see previous message.

- 4 Press **(call id)** to return to standby.

Long Distance call settings and cancellation

Press **(1)** while the incoming call information is displayed (in step 2) to return a long distance call. The prefix "1-" will be displayed at the beginning of the phone number when a long distance call is set. (When the phone number is 15 digits long, only "1" is displayed.) Pressing **(1)** again will cancel the long distance call setting.

```

5/17 12:30PM 03
UNIDEN CORP
1-817-858-3300

```

Deleting information from the Caller ID list

The EXR 2480 stores up to 50 messages. If more new calls are received, messages stored in the list are deleted beginning with the oldest message in the list. Caller ID data can also be deleted manually.

Deleting a Caller ID message



While using the "Delete Message ?" screen, if no key is pressed for more than 20 seconds, an error tone sounds and the telephone returns to standby.

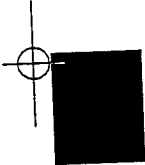

If you get an incoming call, the deleting operation is cancelled and the telephone returns to standby so you can answer the call.

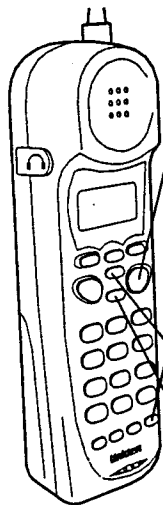

- 1** Press **call id**.
Display the message to be deleted from the Caller ID list by pressing **▲** or **▼**.

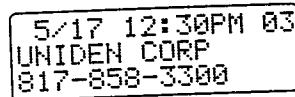

- 2** Press **delete**.

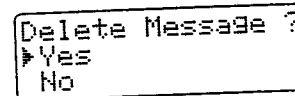

- 3** Press **▲** or **▼** to select "Yes" or "No".

- 4** Press **select** or **delete**.

When the pointer is at "Yes":
A beep tone sounds and the next Caller ID message displayed.

When the pointer is at "No":
The display returns to the Caller ID display.

Deleting all Caller ID name/numbers

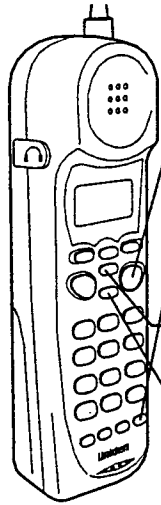

1 Press **call id**.

```
New :01
Total:02
```

2 Press **delete**.

```
Delete All ?
Yes
▶No
```

3 Press **▲** or **▼** to select "Yes" or "No".

4 Press **select** or **delete**.

When the pointer is at "Yes":
A beep tone sounds and all stored Caller ID messages are deleted.

```
Total:00
```

When the pointer is at "No":
The display returns to the summary screen.

```
New :01
Total:02
```

Using the Caller ID list

Calling a party from the Caller ID list

You can place a call from the Caller ID list.
The EXR 2480 stores up to 50 messages.

NOTE

When a long distance call has been set, "1" appears in the display.

NOTE

You cannot make a call from the Caller ID list if your EXR 2480 is connected to private branch exchange (PBX).

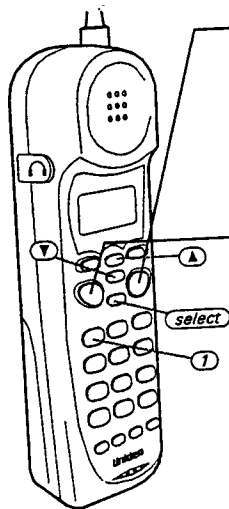

1 Press **call id**.
Select the phone number that you want to dial by pressing **▲** or **▼**.

5/17 12:30PM 03
UNIDEN CORP
817-858-3300

2 Press **talk**.

UNIDEN CORP
8178583300

The displayed phone number dials automatically.

Long Distance calls

Pressing **1** while the incoming call information is displayed (in step 1) will set or cancel a long distance call.

Dial edit

You can edit the phone number of Caller ID data when you press **select** after the step 1.

Talk
8178583300

Storing Caller ID messages in Memory dialing

Messages shown in the Caller ID list can be stored in memory dialing.

Using the incoming call information (i.e., Caller ID list), the phone number of the party on the Caller ID list can be stored in memory dialing.



You can not store a Caller ID message if no phone number appears in the message.



If no key is pressed for more than 20 seconds, an error tone sounds and the telephone returns to the standby mode.



If there is an incoming call or page, memory storage is cancelled and the telephone is set to receive the incoming call or page.

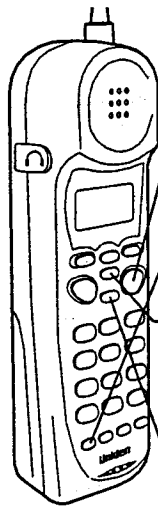

- 1** Press **call id**.
Select the phone number to be stored from the Caller ID list by pressing **▼** or **▲**.

```

5/17 12:30PM 03
UNIDEN CORP
817-858-3300

```

- 2** Press **memory**.

- 3** Press **▼** or **▲** to select the memory location.

```

Select Location
1▶UNIDEN CORP
2 JONE DOE

```

- 4** Press **select**.
A beep tone will sound. The number is stored in memory, and the display returns to the Caller ID list.

```

5/17 12:30PM 03
UNIDEN CORP
817-858-3300

```



If a message has already been stored in the selected memory numbers location, a confirmation screen is displayed. Press **▲** to select "Yes". Press **select** to overwrite. The display returns to the Caller ID list.

```

Replace Memory ?
Yes
▶No

```

Using "Caller ID with call waiting" service

"Caller ID" and "Call waiting" are separate services. CIDCW (Caller ID on Call Waiting) performs the same as regular Caller ID on a call waiting number. You must subscribe to the "Caller ID with call waiting (CIDCW)" service from your telephone company before you can use the following features. The "Call waiting" service can also be used independently. Please contact your telephone company for details.

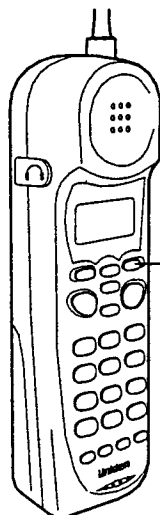

- 1 When a new incoming call arrives during your current telephone call, the phone number and the name of the caller is displayed.

Talk 10:30
UNIDEN CORP
817-858-3300

- 2 Press **flash/▶**.
You will be able to talk with the person that has just called. The first caller will be put on hold.
- 3 To return to the first caller, press **flash/▶** again.

The integrated answering device

The EXR 2480 has a built-in answering system that answers and records incoming calls.

You can also use your answering system to record a conversation, leave a voice memo message for others who use the phone, or to announce a special message to callers when you're away from your phone.

Features

- Digital Tapeless Recording
- 13 minutes of Recording Time
- Selective Outgoing Message (Greeting)
- Time and Day Stamp
- Remote Message Retrieval and Room Monitor
- Toll Saver
- Conversation Recording

Digital Tapeless Recording allows you to quickly review, save or delete the messages. You'll never have to worry about a tape wearing out, jamming, or resetting improperly.

The Integrated Answering System is easy and convenient to use, but please read through all of the instructions carefully.

Setting up your answering system

Turning the answering system on/off

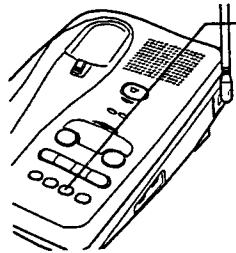

- 1 To turn the answering system on, press **answer on/off**. A beep tone will sound and the current greeting message is played.
- 2 To turn the answering system off, press **answer on/off** again.

Setting the clock

The clock on EXR 2480 Answer System starts when power is applied to the base. Follow these steps to set the clock to the correct time.

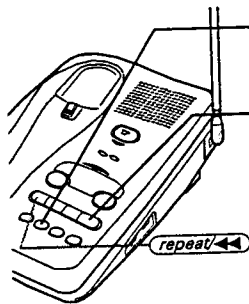

- 1 Press and hold **clock** until a beep tone sounds.
- 2 First, press **skip/next** or **repeat/prev** until the correct day of the week is announced. (Number zero through six displays on the base as each day is announced.) Press **clock** again to select the day.
- 3 Next, press **skip/next** or **repeat/prev** you hear the correct hour setting. Numbers 1 through 12 display on the base as each hour is announced. Press **clock** again to select the correct time.

- 4 Press **skip/next** or **repeat/prev** until you hear the correct time setting. Numbers 0 through 59 display on the base as each minute is announced. Press **clock** again to select the correct time.

- 5 The LED displays ^{AM} A or P. Press **skip/next** or **repeat/prev** until you hear the correct AM/PM setting.

- 6 Press **clock** again to end the time/day setting. The EXR 2480 announces the time that you have set.

NOTE

Press **skip/next** or **repeat/prev** multiple times to scroll through days, hours, minutes, etc.

NOTE

If you don't set the clock within two minutes, the system returns to standby.

Setting your greeting

When you receive a call, the answering system automatically plays either a preset message or your own greeting.

▼ Preset Message

The following message is prerecorded:

"Hello, no one is available to take your call. Please leave a message after the tone."

▼ Recording your personal greeting

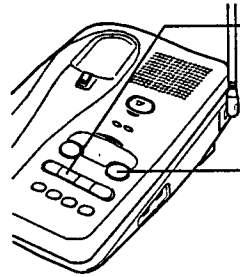

1 Press and hold **greeting** until you hear a long tone. Start recording your message immediately after you hear the long tone end.

2 When you finish recording your message, press **greeting** or **play/stop**. A long tone sounds and your message plays back on the phone.

NOTE

You can record a greeting up to 30 second.

▼ Choosing between two greetings

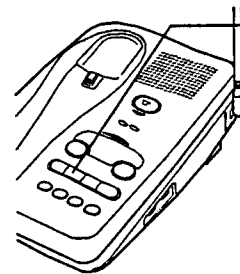

1 Press **greeting** to play the greeting.

2 While the message is playing, press **greeting** again to select between your personal greeting and the prerecorded message.

NOTE

Stand within 12 inches in front of the microphone and speak clearly when recording your greeting.

Selecting the message record time

You can set your answering system to record messages up to one or four minutes long.

One minute option:
move the **REC TIME**
switch to **1**.

Four minutes option:
move the **REC TIME**
switch to **4**.

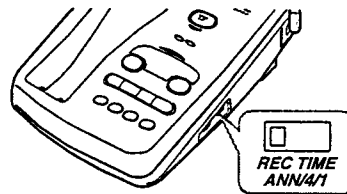

▼ Announce only feature:

The announce only feature plays an outgoing message, but it will not allow the caller to leave a message. Move the **REC TIME** switch to the **ANN** position.

The message counter LED displays "A" when system is on standby.

Prerecorded outgoing message for Announce only feature is:

"Hello, no one is available to take your call."

Selecting a PIN code

To play your messages from a remote location, you will need to enter a two-digit Personal Identification Number (PIN) code (00-99). To select a PIN, perform the following steps.

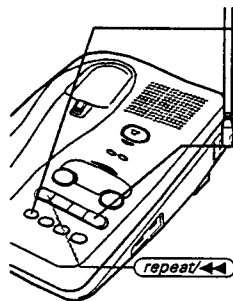

- 1** On the base, press and hold **(pin)** button until beep sounds, and the LED displays 00.
- 2** To set the first number, press **(skip/next)** or **(repeat/previous)** to scroll from 00 to 90. When the desired number appears in the display, press **(pin)**. This selects the first number.
- 3** To set the second number, press **(skip/next)** or **(repeat/previous)** to scroll from 0 to 9. When the desired number appears in the display, press **(pin)**. This selects the second number and then the entered number is announced.

NOTE

Press **(skip/next)** or **(repeat/previous)** multiple times to scroll through numbers on the display.

Setting ring time switch

The ring time /toll saver switch allows you to set the number of rings the caller hears before the answering system plays your outgoing message. You can set the switch to answer after two rings or after four rings. In the **TS** (Toll Saver) position, the answering system picks up after two rings if you have new messages, and after four rings if there are none. This way, if you call long distance to check your messages, you can hang up after third ring to avoid billing charges.

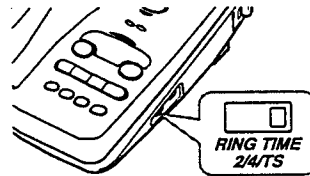

NOTE

To stop playing your messages, press **play/stop** again.

NOTE

Pressing **repeat** before 2.5 seconds (4.5 seconds from remote) of the message has played causes the system to scan back one message.

NOTE

If you have several messages, press **repeat** until you return to the message you want to replay.

Using your answering system

Playing your message

The base LED shows the number of total messages on the display. If the display is blinking, then there are new messages waiting for you. The EXR 2480 is designed to play your new messages first. After you play your new messages you can then play your old messages.

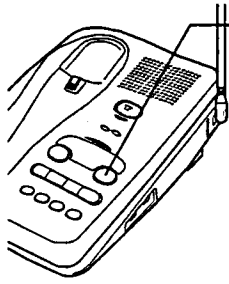

- 1** Press **play/stop**. The system announces the number of new and old messages, then the incoming messages are played. The time and day each message was received is announced after the message is played, and the message counter LED displays the number of the current message.
- 2** When all new messages have played, a long tone is heard. The message counter LED stops flashing to indicate that all of the new messages have been reviewed.
- 3** After you have reviewed all your messages, you can play your old messages again. Press **play/stop** and follow the instructions above.

Repeating a message

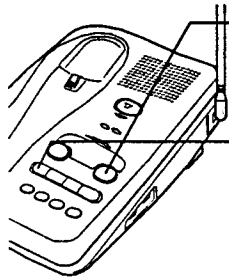

- 1** Press **play/stop** to review your message. The number of stored messages is announced.
- 2** After a message has played for a few seconds, press **repeat** to repeat the message.
- 3** Press **play/stop** at any time to stop reviewing messages and return to standby. The message counter LED shows the total number of messages still on the system.

NOTE

Each time **skip/▶▶** is pressed, the system scans forward one message.

NOTE

If you have several messages, press and hold **skip/▶▶** to find the message you want to play.

NOTE

When you press delete, you are permanently deleting the message. Once deleted, the message cannot be replayed.

Skipping a message

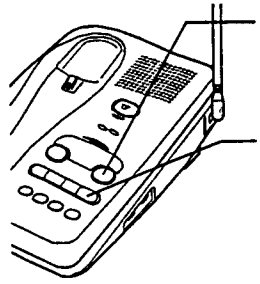

- 1 Press **play/stop** to review your messages. The number of messages is announced.
- 2 Press **skip/▶▶** at anytime to skip to the next message.
- 3 Press **play/stop** at any time to stop reviewing your messages and return to standby. The message counter LED shows the total number of messages on the system.

Deleting a message

▼ Deleting individual message

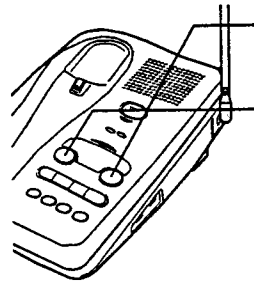

- 1 Press **play/stop** to review your message.
- 2 If you decide to delete a message, press **delete** anytime during the message. The system beeps and immediately goes to the next message.
- 3 After you have played all of your messages, a long tone sounds on the base speaker.

▼ Deleting all messages

Press and hold **delete** after reviewing your messages. A tone sounds when all messages are cleared.

NOTE

The voice memo function is completely independent of the outgoing message. It's handy for leaving others a quick message.

NOTE

A memo message is treated as a typical recorded message and will be added to the stored messages.

NOTE

A recorded conversation is treated as a typical message and will be added to the stored messages.

NOTE

You cannot record a conversation while speaking on the base.

Voice memo

The voice memo function allows the user to record a message on the base.

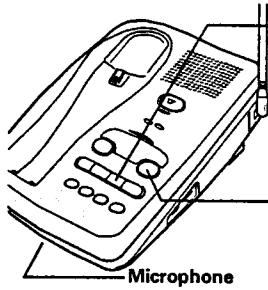

- 1 Press and hold **voice memo**, until you hear a long beep. The message counter LED blinks.
- 2 Speak into the microphone.
- 3 When you have finished, press **voice memo** or **play/stop** to stop recording. The system returns to standby.

Recording a conversation

You can record of conversation while you are making your call from the handset.

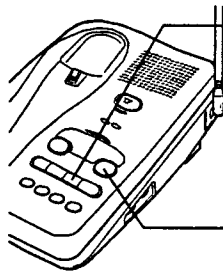

- 1 During the conversation from the handset. Press and hold **voice memo** on the base. The unit begins recording and the LED blinks. A beep that can be heard by both parties sounds every 15 seconds.
- 2 To stop the recording, press **voice memo** or **play/stop**.

NOTE

You must enter a command within 15 seconds of entering command waiting mode or the answering system automatically hangs up and returns to standby.

NOTE

The system will only playback messages for four minutes and then it returns to command waiting mode. To continue playing your message, press #then 2 again within 15 seconds

Remote access away from home

You can operate your answering system from a remote location using any touch-tone telephone. Use this function to check for recorded messages, to play or delete messages, even to record a new greeting, and to monitor sounds in the room.

- 1** Call your telephone number.
- 2** While the answering machine is activated, press # and your PIN code.
- 3** The answering system announces the time and day stamp and the number of messages stored in memory. Then the message playback automatically begins.
- 4** You may continue to listen to your message, or you may select a command from the following chart.

Command	Function
#then 1	Repeat
#then 2	Playing your messages
#then 3	Skipping a message
#then 4	Deleting a message
#then 5	Stop message playback
#then 6	Answering system on
#then 7	Voice memo record/stop
#then 8	Greeting record/stop
#then 9	Answer system off
#then *	Room monitor

- 5** After all of your messages have played, or the playback time exceeds 4 minutes, you will hear that the intermittent beeps indicating that the system is in the command waiting mode. You may enter another command at this time from the chart above.
- 6** When you are finished, hang up to exit the system. The answering system automatically returns to standby.

Remote room monitor

You can call your answering system from any touch-tone phone and monitor sounds in the room where your base is installed.

- 1** Call your telephone number.
- 2** While the answering machine is activated, press # and your PIN code.
- 3** The answering system begins announcing the time and day.
- 4** Press # then 5 to stop the message.
- 5** Press # then * while the system announces the time and day stamp. You hear sounds in the room where your phone is installed. After 15 seconds, the answering system returns to the command waiting mode.
- 6** Press # then * to monitor the room for another 15 seconds. Or select another remote function. Or hang up to exit the system. The answering system automatically returns to standby.

NOTE

If the handset battery pack is completely discharged, or the battery pack is removed, the digital security code will be lost. If this happens, a new security code is set automatically the next time the battery pack is charged.

INFORMATION

Changing the digital security code

The digital security code is an identification code used to connect the handset and the base unit. Normally, setting the code is not necessary.

The first time you charge your handset, the security code is automatically set. (See page 3.)

In the rare situation that you suspect another cordless telephone is using the same security code, you can change the code.

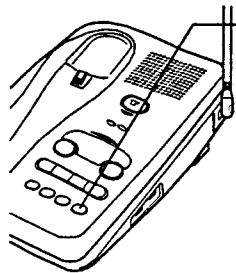

- 1 Remove the handset from the base unit. Press **page/int'com**.
- 2 While the handset is producing the paging sound, hold **page/int'com** while placing the handset in the base unit. The paging tone stops. Leave the handset on the base longer than 5 seconds. A random, new security code is set.

Headset installation

Your phone may be used with an optional headset. To use this feature, simply plug any standard 2.5mm headset plug into the headset jack. Your phone is ready for hands-free conversation.

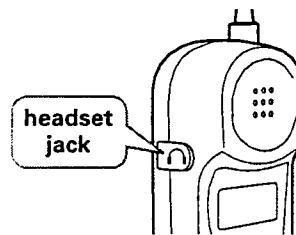

Installing the beltclip

To attach the beltclip

- 1 Remove the slot cover.

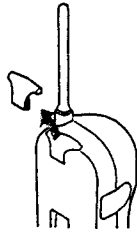

- 2 Insert the beltclip into the empty slot. Press down until it clicks.

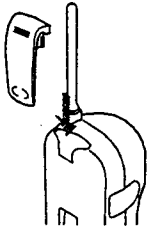

To remove the beltclip

- 1 Pull back on the release tab. Lift the beltclip.

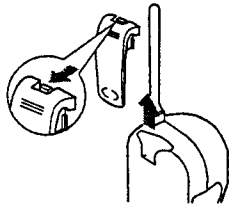

- 2 Replace the slot cover. You can store either the beltclip, or the slot cover, on the bottom of the base.

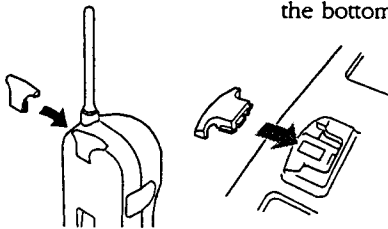

Note on power sources

Battery replacement and handling

When the operating time becomes short, even after a battery is recharged, please replace the battery.

With normal usage, your battery should last about one year.

Please contact your place of purchase for a replacement battery.

Power Failure

During the period that the power is off, you will not be able to make or receive calls with the telephone.

RECYCLING NICKEL-CADMIUM BATTERIES

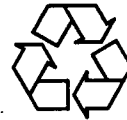

Ni-Cd

NICKEL-CADMIUM BATTERIES MUST BE DISPOSED OF PROPERLY.

Nickel-cadmium cells are used in the battery pack. Please take your used nickel-cadmium battery packs to a store that recycles nickel-cadmium batteries.

Caution

- Use the specified battery pack.
- Do not remove the battery from the handset to charge it.
- Never throw the battery into a fire, disassemble it, or heat it.
- Do not remove or damage the battery casing.

Maintenance

When slightly dirty

Wipe with a soft, dry cloth.

When very dirty

Wipe with a soft cloth that has been dampened with diluted, neutral detergent. Dry with a dry cloth.

When the charging terminals become dirty

Wipe with a pencil eraser or other contact cleaner.

Caution

Do not use paint thinner, benzene, alcohol, or other chemical products. Doing so may discolor the surface of the telephone and damage the finish.

Troubleshooting

If your phone is not performing to your expectations, please try these simple steps first.

Symptom	Suggestion
The status light won't come on when the handset is placed in the base unit.	<ul style="list-style-type: none"> • Make sure the AC adapter is plugged into the base unit and wall outlet. • Make sure the handset is properly seated in the base unit. • Make sure the charging contacts on the handset and base unit are clean.
The audio sounds weak and/or scratchy.	<ul style="list-style-type: none"> • Make sure that the base unit antenna is in a vertical position. • Move the handset and or base unit to a different location away from metal objects or appliances and try again. • Make sure that you are not too far from the base.
Can't make or receive calls.	<ul style="list-style-type: none"> • Check both ends of the base unit telephone line cord. • Make sure the AC adapter is plugged into the base unit and wall outlet. • Disconnect the AC adapter for a few minutes, then reconnect it. • Reset the digital security code (See page 49). • Make sure (talk) is pressed.
The handset doesn't ring or receive a page.	<ul style="list-style-type: none"> • The battery pack may be weak. Charge the battery on the base unit for 12-15 hours. • The handset may be too far away from the base unit. • Place the base unit away from appliances or metal objects. • Reset the digital security code (See page 49).

Symptom	Suggestion
The caller ID disappears.	<ul style="list-style-type: none"> • The handset was picked up before the second ring. • The call was placed through a switch board.
The caller ID does not display	<ul style="list-style-type: none"> • Call your local telephone company to verify your Caller ID service is current.
The answering system does not work.	<ul style="list-style-type: none"> • Make sure the base unit is plugged in. • Make sure that the answering system is turned on.
Messages are incomplete.	<ul style="list-style-type: none"> • The incoming messages may be too long. Remind callers to leave a brief message. • The memory may be full. Delete some or all of the saved messages.
After a power failure, the outgoing message is deleted.	<ul style="list-style-type: none"> • Record your greeting again. The default messages should remain.
No sounds on the base unit speaker during call monitoring or message playback.	<ul style="list-style-type: none"> • Adjust the speaker volume on the base unit.
Cannot access remote call-in features from another touch-tone phone.	<ul style="list-style-type: none"> • Make sure you are using the correct PIN number. • Make sure that the touch-tone phone you're using can transmit the tone for at least two seconds. If it cannot, you may have to use another phone to access your message.

YOUR NEW PHONE

Specifications

General

The EXR 2480 complies with FCC Parts 15 and 68.

Frequency control: PLL
 Modulation: Frequency shift keying
 Operating temperature: 0°C to +50°C (+32°F to +122°F)

Base unit

RX frequency: 902.119 MHz to 905.016 MHz (30 channel)
 TX frequency: 924.997 MHz to 927.894 MHz (30 channel)
 Power requirements: 10V 350mA (from AC adapter)
 Size: 8-49/64 in. (W) x 6-57/64 in. (D) x 2-37/64 in. (H)
 (222.5 mm (W) x 175 mm (D) x 65.3 mm (H))
 Weight: Approx. 21 oz. (Approx. 594 g)

Handset

RX frequency: 924.997 MHz to 927.894 MHz (30 channel)
 TX frequency: 902.119 MHz to 905.016 MHz (30 channel)
 Power requirements: Rechargeable Nickel-Cadmium battery pack
 Size (without antenna): 7 in. (W) x 2-17/64 in. (D) x 2 in. (H)
 (178 mm (W) x 57.6 mm (D) x 51 mm (H))
 Weight: Approx. 9 oz. (254 g) (including battery)
 Battery: BT905
 Capacity 600 mA, 3.6V
 Talk mode 4 hours TYP
 Standby mode 7 days TYP

Specifications, features, and availability of optional accessories are all subject to change without prior notice.

At Uniden, we'll take care of you!

If you need any assistance with this product, please call our Customer Hotline at

1-800-297-1023

PLEASE DO NOT RETURN THIS PRODUCT TO THE PLACE OF PURCHASE.

Our Uniden representatives will be happy to help you with any matters regarding the operation of this unit, available accessories, or any other related matters.

Thank you for purchasing a Uniden product.
Hours: M-F 7:00 AM to 7:00 PM CST.

Index

0 - 9

3-way conferencing.....29

A

Answering device

Features.....38

Setting up.....39

Using.....43

B

Base ringer switch.....16

Battery pack

Preparing and charging..10

Replacement and
handling.....50

C

Caller ID

Caller ID service.....30

Call Waiting.....37

Deleting.....33

Using.....35

Viewing.....32

Connection.....6

D

Dialing mode.....7

Digital security code.....3, 48

E, F, G

Earpiece volume.....16

H

Headset installation.....48

I, J, K, L

Intercom.....19

Installing the beltclip.....49

M, N, O

Maintenance.....50

Making a call.....14

Memory dialing

Making calls
with memory dialing.....23

Erasing a stored name
and phone number.....27

Storing phone
numbers and names.....21

Mounting the base unit

to a wall.....8

P, Q

Package contents.....4

R

Receiving a call.....15

Redialing a call.....17

Handset ringer volume.....16

S

Setting up your answering
system

Selecting a PIN code.....41

Selecting the

message record time.....41

Setting the clock.....39

Setting ring time switch.42

Setting your greeting.....40

Turning the answering

system on/off.....39

Setting up the Base unit.....5

Setting up the Handset.....10

Specifications.....53

T

Transferring a call.....20

Troubleshooting.....51

U, V, W, X, Y, Z

Using your answering system

Deleting a message.....44

Playing your message....43

Recording a

conversation.....45

Remote access

away from home.....46

Remote room monitor....47

Repeating a message.....43

Skipping a message.....44

Voice memo.....45

THANK YOU

FOR PURCHASING A UNIDEN PHONE!

Uniden

Covered under one or more of the following U.S. patents:

4,511,761 4,523,058 4,595,795 4,797,916 5,381,460
5,426,690 5,434,905 5,491,745 5,533,010 5,574,727
5,650,790 5,660,269 5,661,780 5,663,981 5,671,248
5,717,312 5,754,407 5,768,345 5,787,355 5,838,721

© June 1999 Uniden America Corporation

All rights reserved • Printed in China UCZZ000008Z

UCZZ016518Z