

Preliminary owner's manual

Note:

All of model name should be corrected to read as 43-3818.

Company and Trade name should be corrected to read as RadioShack.

Contents

Welcome/Features		RocketDial	
Quick Reference Guide	4	RocketDial	31
Controls and Functions	5	Storing and Editing the RocketDial	31
Getting Started		Making Calls with the RocketDial	31
Read this First	7	Deleting the RocketDial	32
Checking the Package Contents	8	Caller ID Features	
Setting up the Phone	9	Caller ID	33
Mounting the Base Unit on a Wall	13	When the Telephone Rings	33
Terminology	14	Viewing the Caller ID Message List	34
Setting Menu Options	15	Deleting Information from the Caller ID List	35
Basics		Using the Caller ID List	36
Making and Receiving Calls	18	The Integrated Answering Device	
Adjusting the Handset Ringer and Earpiece Volume	19	The Integrated Answering Device	38
Redial	20	Features	38
Tone Dialing Switch-over	20	Turning the Answering System On/Off	39
Traveling Out-of-Range	20	Setting Up Your Answering System	39
Selecting a Different Channel	21	Using Your Answering System	47
Page	21	Additional Information	
Flash and Call Waiting	21	Changing the Digital Security Code	53
Memory Dialing		Installing the Beltclip	53
Storing Phone Numbers and Names	22	Headset Installation	53
Steps for Entering Names and Special Characters	24	Note on Power Sources	54
Making Calls with Memory Dialing	26	Maintenance	54
Chain Dialing	27	Troubleshooting	55
Editing a Stored Name and/or Phone Number	28	General Information	58
Erasing a Stored Name and Phone Number	30	Precautions & Warranty	59
		I.C. Notice	61
		Index	62
		Remote Operation Card	

Welcome

Congratulations on your purchase of the Uniden EXAI2248 series cordless telephone and answering system. This phone is designed and engineered to exacting standards for reliability, long life, and outstanding performance.

Note: Some illustrations in this manual may differ from the actual unit for explanation purpose.



As ENERGY STAR® Partner, Uniden has determined that this product or product models meets the ENERGY STAR® guide lines for energy efficiency. ENERGY STAR® is a U.S. registered mark.

Features

- 2.4 GHz Extended Range Technology
- 16 Digit, 3-line Backlit Display
- Integrated Telephone Answering Device (ITAD)
- Voice Prompted Guidance through ITAD Setup Menu
- 10 Number Memory Dialing
- RocketDial
- Caller ID and Call Waiting Caller ID
- 30 Number Caller ID Memory
- 32 Digit Redial
- Flash and Pause
- Pulse/Tone Dialing
- Page/Find Handset
- 7 Hour Talk Time/14 Day Standby Time
- Handset Earpiece and Ringer Volume Control
- Hearing Aid Compatible
- 20 Channel Autoscan
- English or French Display Option

The EXAI2248 series features include **AutoTalk™** and **AutoStandby™**. AutoTalk allows you to answer a call by just removing the handset from the base so you don't have to waste time pushing buttons or flipping switches. AutoStandby allows you to hang up by simply returning the handset to the base.

The **UltraClear Plus™** true compander circuitry virtually eliminates background noise. This innovative technology, together with 20 different channels, provides you with the best possible reception during all your conversations.

To protect you against misbilled calls which might result from your phone being activated by other equipment, the EXAI2248 series has **Random Code™** digital security which automatically selects one of over 262,000 digital security codes for the handset and base. Also, the **AutoSecure™** feature electronically locks your phone when the handset is in the base.

RocketDial™ is a one touch speed dial key that automatically dials your most important or frequently called number. The number dialed, is a preset number stored by the user.

Be sure to visit our web site: www.uniden.com

Uniden® is a registered trademark of Uniden America Corporation.

AutoTalk, AutoStandby, UltraClear Plus, Random Code, AutoSecure, and RocketDial are trademarks of Uniden America Corporation.

Step 1 Charging the Battery

TO INSTALL THE HANDSET BATTERY

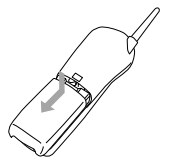
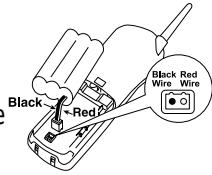
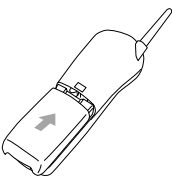
- 1 Remove the cover. 
- 2 Connect the battery pack connector with the correct polarity. 
- 3 Replace the cover. 

TO PLUG INTO AC POWER

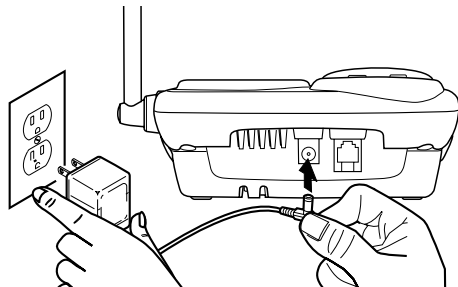
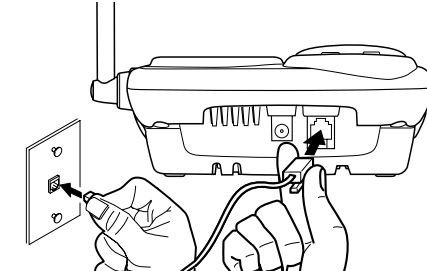
- 1 Plug AC adapter cord into the base unit and then into a 120V AC outlet. 
- 2 Place the handset on the base. 

Note: You must charge the battery continuously for 15 - 20 hours before using the phone.

Step 2 Connecting

CONNECT TO A PHONE LINE

When the handset battery pack is fully charged, after 15-20 hours of charging, plug the telephone cord into the base unit and then into a telephone wall jack.

Your phone is set for tone dialing. If your local network requires pulse dialing, please see "Choose the dial mode" on page 17.

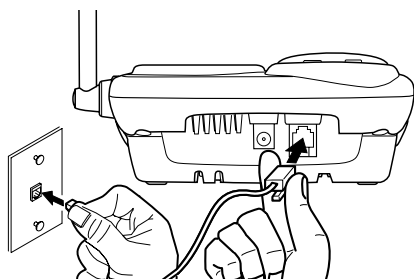

Step 3 Setting Up the Caller ID/Language

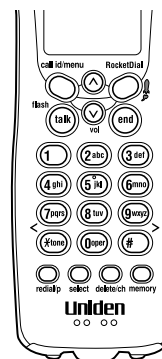

Note: Three Caller ID options are available: AutoTalk, Caller ID on Call Waiting (CICW), and Area Code.

TO CHANGE CALLER ID OPTIONS

- 1 Press *call id/menu*.
- 2 Press \wedge or \vee to move the pointer to an option.
- 3 Press *select* to change the option setting.
- 4 Press *end* and return the handset to the base.

TO CHOOSE THE LANGUAGE

- 1 Press *call id/menu*.
- 2 Press \wedge or \vee to move the pointer to Language.
- 3 Press *select* to select Eng (English) or Fr. (French).
- 4 Press *end* and return the handset to the base.

Step 4 Setting Up the Answering System

TURN THE ANSWERING SYSTEM ON

Press *ans on/off*.

A pre-recorded greeting will play and your system is ready to accept calls.

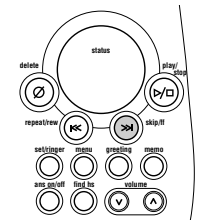

TO RECORD A PERSONAL GREETING

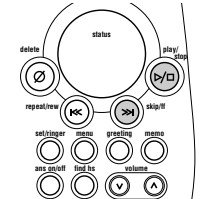
- 1 Press and hold *greeting* until you hear "Record greeting" and a confirmation tone. 
- 2 Record your personal greeting. (Position yourself as near to the base as possible and speak clearly.)
- 3 When finished press *greeting* again or *play/stop*.

Controls and Functions

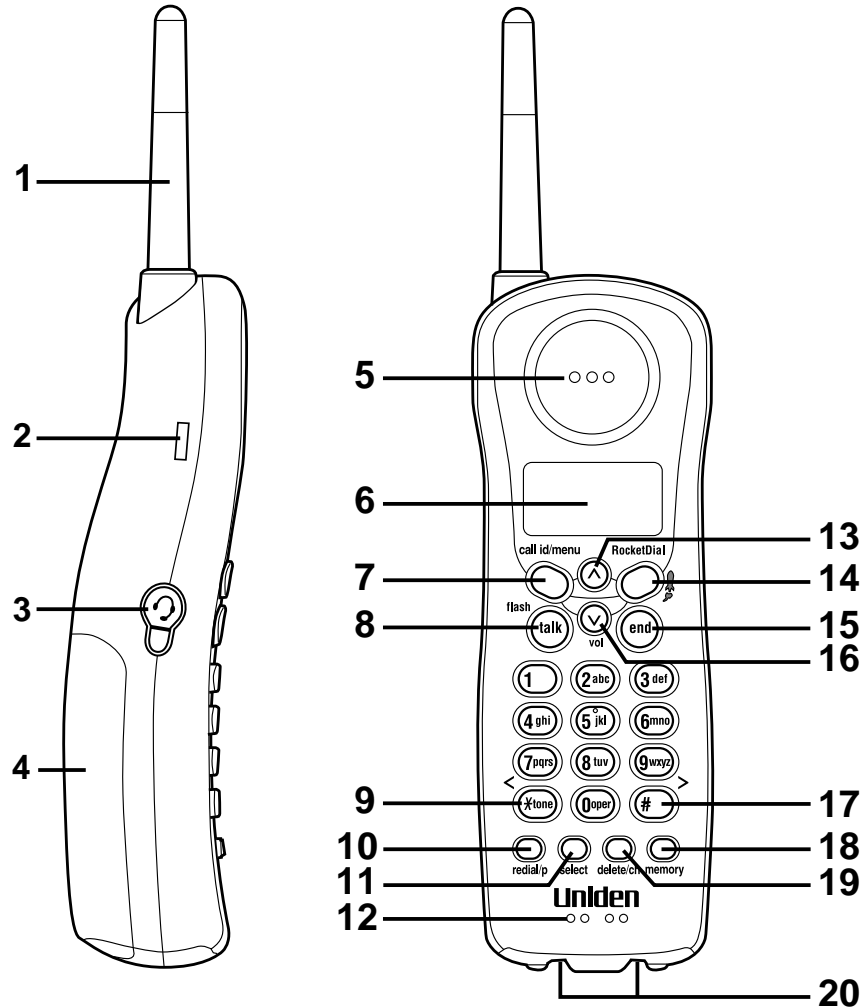

1. Handset antenna
2. Beltclip holes
3. Optional headset jack
4. Handset battery compartment
5. Handset earpiece
6. LCD display
7. Caller ID (call id)/menu key
8. Talk/flash key
9. * /tone/left cursor (<) key
10. Redial/pause (p) key
11. Select key
12. Handset microphone and ringer speaker
13. Volume up (^) key
14. RocketDial key
15. End key
16. Volume down (v) key
17. #/right cursor (>) key
18. Memory key
19. Delete/channel (ch) key
20. Handset charging contacts

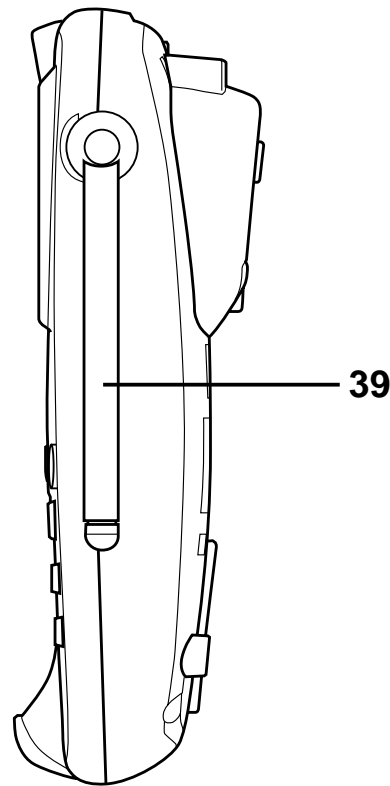
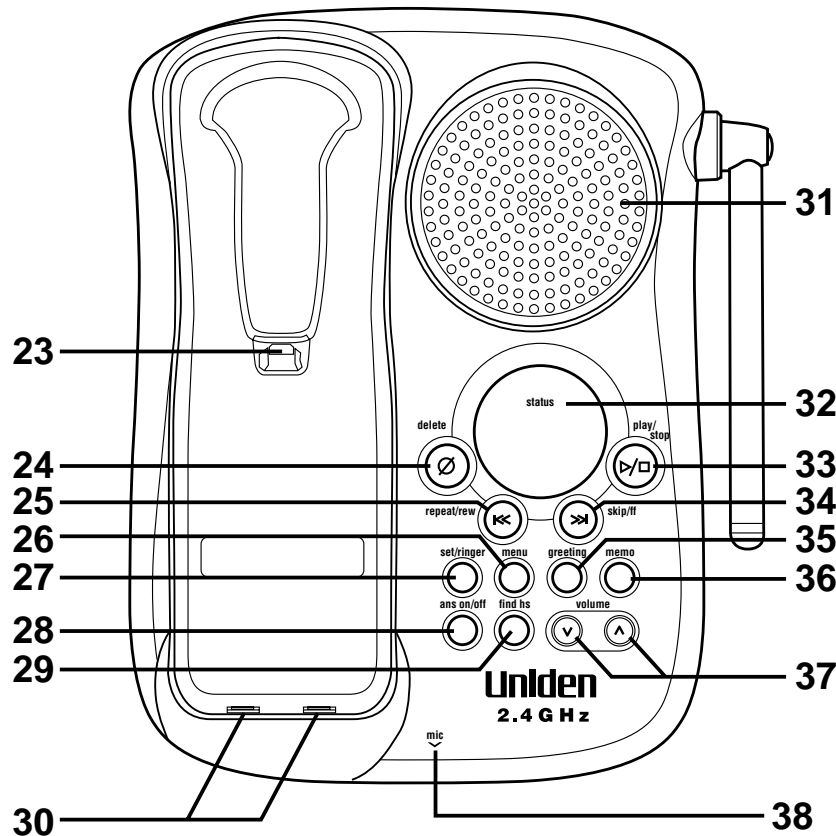
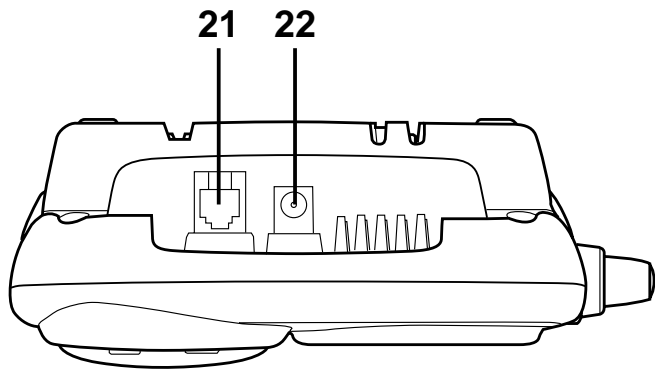

- 21. Telephone line jack
- 22. DC IN 9V jack
- 23. Handset retainer clip
- 24. Delete key
- 25. Repeat/rewind (rew) key
- 26. Menu key
- 27. Set/ringer key
- 28. Answer on/off key
- 29. Find hs key
- 30. Base charging contacts
- 31. Base speaker
- 32. Status LED
- 33. Play/stop key
- 34. Skip/fast forward (ff) key
- 35. Greeting key
- 36. Memo key
- 37. Speaker volume keys
- 38. Microphone
- 39. Base antenna

Read this First

This cordless telephone must be set up before use. Follow these steps:

Step 1 (page 8)

Unpack the telephone and accessories.

Step 2 (page 9)

Next, choose the best location to set up the base unit.

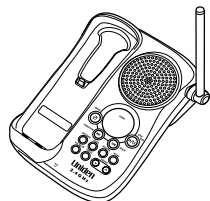

Step 3 (page 10 to 13)

Then, insert the battery pack into the handset. Connect the base unit. You must charge the battery pack for **15-20 hours before plugging into telephone line and using the phone.**



Step 4 (page 38 to 46)

Finally, set the answering system.

About the digital security code

This cordless telephone uses a digital security code to prevent unauthorized access to your base unit. This security code prevents other cordless handsets from making calls through your base unit. A random security code will be assigned automatically between your base unit and handset when you charge the battery pack for the first time. If you want to change the security code, see page 53.

Checking the Package Contents

Make sure you have received the following items in the package. If any of these items are missing or damaged, contact the Uniden Parts Department.

- **Base unit**
- **Handset**
- **AC adapter**
- **Rechargeable battery**
- **Telephone cord**
- **Beltclip**
- **This Owner's Manual**

Uniden Parts Department at (800) 554-3988
Hours: M-F 7:00 a.m. to 5:00 p.m. CST. We can also be
reached on the web at **www.uniden.com**

Setting up the Phone

Do the following steps:

- A. Choose the best location
- B. Install the battery pack
- C. Connect the base unit

A. Choose the best location

Before choosing a location for your new phone, read the INSTALLATION CONSIDERATIONS included in the PRECAUTIONS AND IMPORTANT SAFETY INSTRUCTIONS. Here are some important guidelines you should consider:

Avoid heat sources, such as radiators, air ducts, and sunlight

Avoid television sets and other electronic equipment

Choose a central location

Avoid noise sources such as a window by a street with heavy traffic

Avoid microwave ovens

Avoid excessive moisture, extremely low temperatures, dust, mechanical vibration, or shock

Avoid personal computers

Avoid other cordless telephones

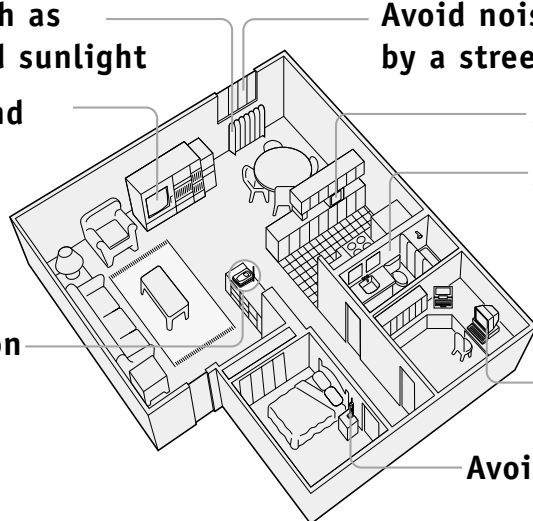

- The location should be close to both a phone jack and a continuous power outlet which is not switchable.
- Keep the base and handset away from sources of electrical noise such as motors, microwave ovens, and fluorescent lighting.
- Be sure there is sufficient space to raise the base antenna to a vertical position.
- The base can be placed on a desk, tabletop, or mounted on a standard wall plate.



Use only the Uniden battery (BT-905) supplied with your phone. Replacement batteries are also available through the Uniden Parts Department (see page 8).

B. Install the battery pack

Charge the battery pack for at least 15-20 hours before plugging the telephone jack and start using your phone.

- 1) Press in on the battery cover release and slide the cover down until it comes off.
- 2) Connect the battery pack connector observing correct polarity (black and red wires) to the jack inside the battery compartment.

Do not exert any force on this connection. It could cause damage to the battery or handset. Once you are certain that you have made a good connection, then insert the battery pack into the battery compartment. Do not pinch the wires.

- 3) Securely close the battery compartment cover by sliding it up until it snaps into place.
- 4) Place the handset on the base.

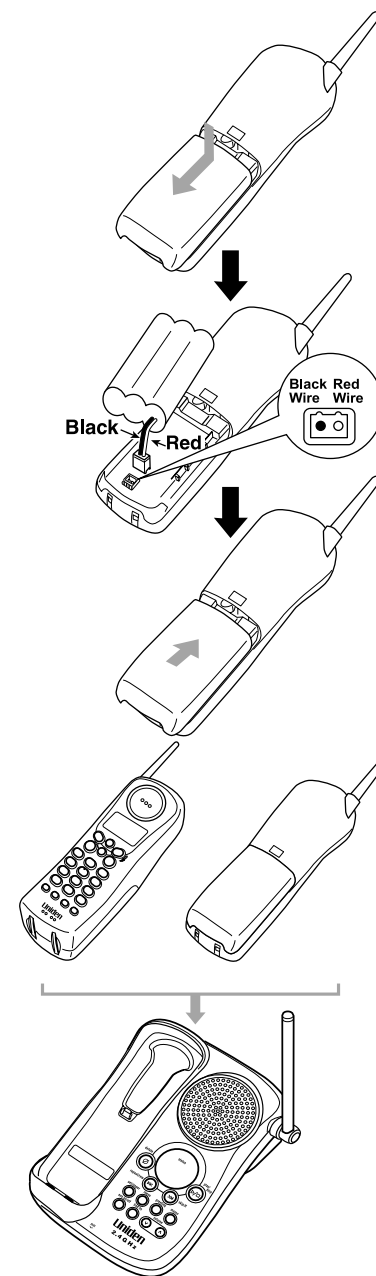

Battery use time (per charge)

From fully charged (15-20 hours charge time)

- Seven hours continuous use.
- Fourteen days when the handset is in the standby mode.

Low battery alert

When the battery pack is very low and needs to be charged, the phone is programmed to eliminate functions in order to save power. If the phone is not in use, "Low Battery" appears on the LCD and none of the keys will operate.

If the phone is in use, "Low Battery" flashes and the handset beeps. Complete your conversation as quickly as possible and return the handset to the base unit for charging.

Low Battery

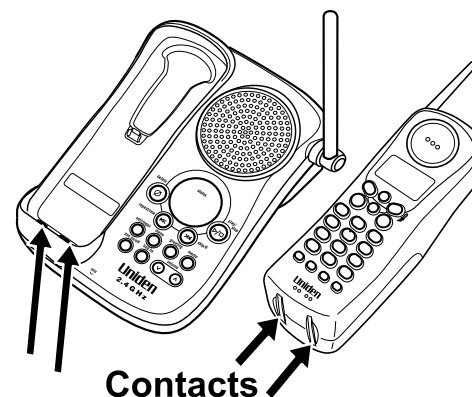

The last number dialed in the redial memory and the numbers stored in the memory locations are retained for up to 30 minutes while you replace the battery pack.

Cleaning the battery charging contacts

To maintain a good charge, it is important to clean the battery contacts on the handset and base unit with a dry cloth or a pencil eraser about once a month.

Do not use any liquids or solvents.



Even when the battery pack is not being used, it will gradually discharge over a long period of time. For optimum performance, be sure to return the handset to the base unit after each telephone call for charging the battery.



Place the power cord so that it does not create a trip hazard or where it could become chafed and create a fire or electrical hazard.



The handset can be placed face up or face down in the base for charging.

C. Connect the base unit

- 1) Connect the AC adapter to the **DC IN 9V** jack and a standard 120V AC wall outlet.
- 2) Set the base on a desk or tabletop, and place the handset on the base unit as shown. (For wall mounting, see "Mounting the Base Unit on a Wall", on page 16.)
- 3) Raise the antenna to a vertical position.
- 4) Make sure the **status** LED illuminates. If the LED does not illuminate, check to see that the AC adapter is plugged in and the handset makes good contact with the base charging contacts.



- Use only the supplied **AD-420 AC adapter**. Do not use any other AC adapter.
 - Connect the AC adapter to a continuous power supply.
 - Place the base unit close to the AC outlet so that you can unplug the AC adapter easily.
-
- After installing the battery pack in the handset, charge your handset at least **15-20 hours before plugging into the phone line**. Once the handset battery pack is fully charged, connect the telephone line cord to the base and telephone wall outlet.

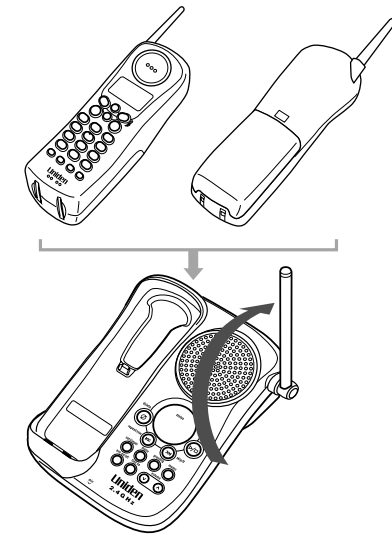
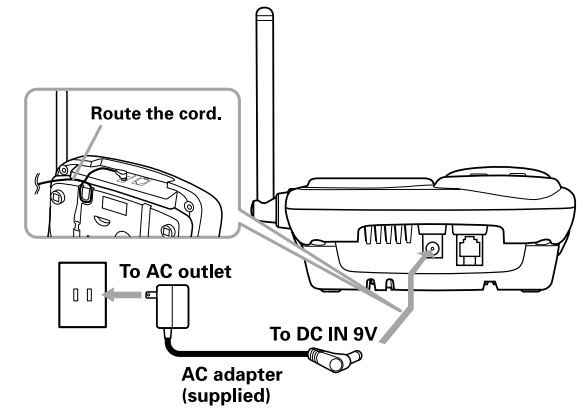

- 5) Connect the telephone line cord to the **TEL LINE** jack and a telephone outlet once the handset is fully charged.



If your telephone outlet isn't modular, contact your telephone company for assistance.

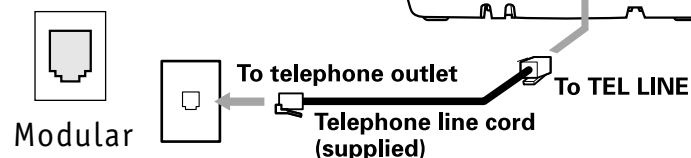

Mounting the Base Unit on a Wall

Standard wall plate mounting

This phone can be mounted on any standard wall plate.

- 1) Plug the the AC adapter to the **DC IN 9V** jack.
- 2) Wrap the AC adapter cord inside the molded wiring channel as shown.
- 3) Plug the AC adapter into a standard 120V AC wall outlet.
- 4) Plug the telephone line cord into the **TEL LINE** jack. Wrap the cord inside the molded wiring channel as shown.
- 5) Plug the telephone line cord into the telephone outlet.
- 6) Raise the antenna to a vertical position.
- 7) Align the mounting slots on the base with the mounting posts on the wall. Then push in and down until the phone is firmly seated.

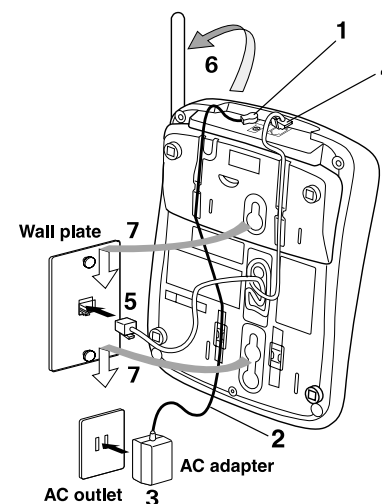

DO NOT use an AC outlet controlled by a wall switch.

Direct wall mounting

If you don't have a standard wall plate, you can mount your phone directly to the wall. Before doing this, consider the following:

- Avoid electrical cables, pipes, or other items behind the mounting location that could cause a hazard when inserting screws into the wall.
- Try to mount your phone within 5 feet of a working phone jack to avoid excessive cord lengths.
- Make sure the wall material is capable of supporting the weight of the base and handset.
- Use #10 screws (minimum length of 1-3/8 inches) with anchoring devices suitable for the wall material where the base unit will be placed.

1) Insert two mounting screws into the wall, (with their appropriate anchoring device), 3-15/16 inches apart. Allow about 1/8 of an inch between the wall and screw heads for mounting the phone.

2) Refer to steps 1 through 7 on page 13 to mount the telephone.

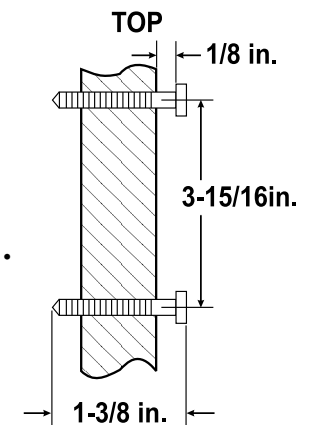

Terminology

Throughout this manual, terms such as Standby and Talk Mode are used. Below is the terminology explanation.

- **Standby Mode** - The handset is not in use, off the base, and *talk/flash* has not been pressed. A dial tone is not present.
- **Talk Mode** - The handset is off the base and *talk/flash* has been pressed enabling a dial tone.

Setting menu options

There are five setup options available. They are Caller ID options [AutoTalk, CIDCW (Caller ID on Call Waiting), and Area Code], dial mode and language.

AutoTalk allows you to answer the phone without pressing the **talk/flash** button. If the phone rings when AutoTalk is on, simply remove the handset from the base and the phone automatically answers the call. Or if the handset is not on the base, press any key to answer the call. If the phone rings when AutoTalk is off, you must press **talk/flash** to answer the call.

Caller ID options

To change your AutoTalk and CIDCW:

- 1) Press and hold **call id/menu**. The following screen appears.
- 2) Use **^** and **v** or a number key (1 and 2) to move the pointer to the selection that you would like to change. Press **select** to toggle between "On" and "Off".
- 3) Press **end** or return the handset to the base unit to complete the setting. The handset returns to the standby mode

```
1▶Auto Talk:Off
2 CIDCW      :On
3 Area Code:
```



If your calling area requires 10-digit dialing, do not program this option.

To enter your Area Code

If you enter a 3-digit area code number in the `Area Code` option, your local area code does not appear in Caller ID messages. Do not program this option, if your calling area requires 10-digit dialing.

When reviewing Caller ID messages, you will see only the local seven digit number. For calls received from outside your local area code, you will see a full 10-digit number.

1) When the phone is in the standby mode, press and hold **call id/menu**. The following screen appears.

```
1▶ Auto Talk:Off
2 CIDCW      :On
3 Area Code:
```

2) Press **3** or press **▼** twice to select "Area Code".

```
1 Auto Talk:Off
2 CIDCW      :On
3▶ Area Code:
```

3) Press **select**.

4) Use the number keys (**0** to **9**), **#/>**, ***/tone/<**, or **delete/ch** to enter the 3-digit area code.

```
1 Auto Talk:Off
2 CIDCW      :On
3 Area Code:█
```

5) Press **select**. A confirmation tone sounds and the displayed area code is entered.

6) Press **end** or return the handset to the base unit to complete the setting. The handset returns to the standby mode.



When the area code has already been stored in memory, the stored area code will be displayed. To change it, use the **delete/ch** and number keys to enter the new area code. Then press **select**. A confirmation tone sounds. To complete the setting, press **end** or return the handset to the base unit.

```
1 Auto Talk:Off
2 CIDCW      :On
3 Area Code:817
```

Choosing the dial mode

- 1) When the phone is in the standby mode, press and hold **call id/menu**.

The following screen appears.

```
1▶ Auto Talk: Off
2 CIDCW      : On
3 Area Code:
```

- 2) Press 4 or press **▼** three times to select "Dial".

```
2 CIDCW      : On
3 Area Code:
4▶ Dial      : Tone
```

- 3) Press **select** to toggle between "Tone" and "Pulse".

- 4) Press **end** or return the handset to the base unit to complete the setting. The handset returns to the standby mode.

Setting the language

- 1) When the phone is in the standby mode, Press and hold **call id/menu**.

The following screen appears.

```
1▶ Auto Talk: Off
2 CIDCW      : On
3 Area Code:
```

- 2) Press 5 or press **▼** four times to select "Language".

```
3 Area Code:
4 Dial      : Tone
5▶ Language : Eng
```

- 3) Press **select** to toggle between "Eng" and "Fr.".

- 4) Press **end** or return the handset to the base unit to complete the setting. The handset returns to the standby mode.

Making and Receiving Calls



Refer to page 13
"Setting menu options"
to turn on the AutoTalk
feature if desired.

	Handset On Base	Handset Off Base
To answer a call	Pick up the handset (AutoTalk), or pick up the handset and press <i>talk/flash</i> .	Press any key (When the AutoTalk is set to on) or press <i>talk/flash</i> .
To make a call	1) Pick up the handset. 2) Press <i>talk/flash</i> . 3) Listen for the dial tone. 4) Dial the number. OR 1) Pick up the handset. 2) Dial the number, then press <i>talk/flash</i> .	1) Press <i>talk/flash</i> . 2) Listen for the dial tone. 3) Dial the number. OR Dial the number, then press <i>talk/flash</i> .
To hang up	Return the handset to the base (AutoStandby).	Press <i>end</i> .
To redial	1) Pick up the handset. 2) Press <i>talk/flash</i> . 3) Listen for the dial tone. 4) Press <i>redial/p</i> . OR 1) Pick up the handset. 2) Press <i>redial/p</i> , then press <i>talk/flash</i> .	1) Press <i>talk/flash</i> . 2) Listen for the dial tone. 3) Press <i>redial/p</i> . OR Press <i>redial/p</i> , then press <i>talk/flash</i> .

Adjusting the Handset Ringer and Earpiece Volume

Handset ringer tone and volume

Press **▲** or **▼** in standby mode to select one of five ringer tones and volume combinations.

Earpiece volume

Pressing **▲** or **▼** during a call will change the earpiece volume of the handset. This setting will remain in effect after the telephone call has ended.

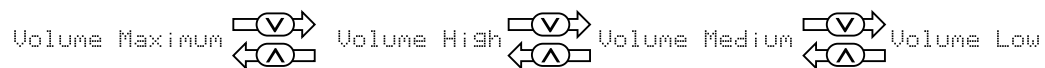

When you press **▲** in Maximum mode or **▼** in Low mode, an error tone sounds.

Ringer Mute

You can temporarily mute the ringer tone. When the handset is off the base and the phone is ringing, press **end**. The ringer tone will return to normal starting with the next incoming call.

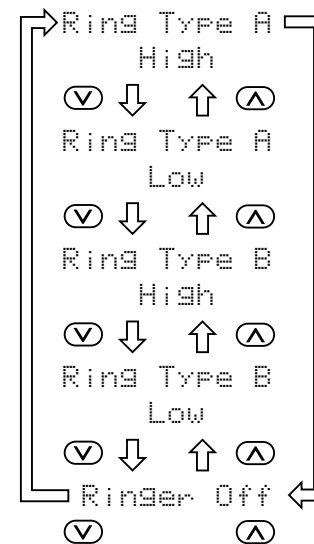



- The tone feature only applies when the dial mode is set to pulse.
- This special number can be stored in a memory location. This is referred to as Chain Dialing (See page 27.)

Redial

The **redial/p** key redials the last number dialed. The redialed number can be up to 32 digits long.

Tone Dialing Switch-over

Some telephone companies use equipment that requires pulse dialing (sometimes referred to as rotary dialing). If you need to enter tone dialing digits, you can switch-over to tone dialing during the call. For example, entering your bank account number after you have called your bank.

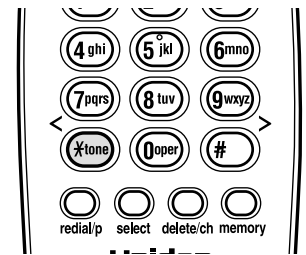

Initially make your call with the pulse dialing mode. Once your call connects, press ***/tone/⟨**. Enter the desired number. These digits will be sent as tone dialing. Once the call ends, the tone mode is canceled and pulse dialing mode resumes.

Traveling Out-of-Range

During a call, as you begin to move your handset too far from your base unit, noise increases. If you pass the range limits of the base unit, your call will terminate within 1 minutes.

Selecting a Different Channel

If you encounter interference while using your phone, you can manually change the phone's channel for clear operation. This function works only when the phone is in use.

Press **delete/ch**. "Scanning" appears on the display, indicating the phone is changing to another channel. For more information on interference, refer to "Precautions" on page 59.

Page

To locate the handset (while it's off the base), press **find hs** on the base. The handset beeps for 60 seconds.

Paging is canceled when pressing any handset key, **find hs** on the base or the handset is returned to the base.

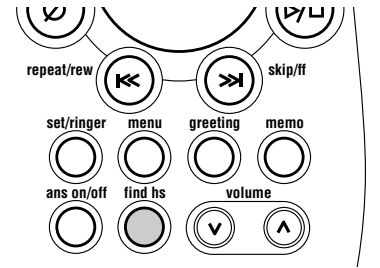

Paging is also canceled when the phone receive a incoming call.

Flash and Call Waiting

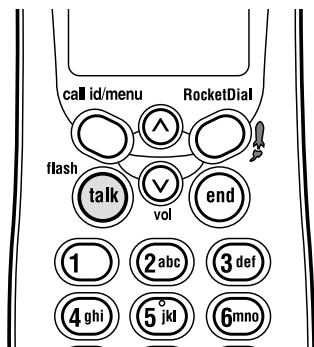

If you have "Call Waiting" service and a call waiting tone sounds while you are on a call, press **talk/flash** to accept the waiting call. There is a short pause, then you will hear the new caller. To return to the original caller, press **talk/flash** again.



You must subscribe through your local telephone company to receive Call Waiting Service.



In memory dialing operation, you must press a key within 30 seconds. Otherwise, an error tone will sound and the phone will return to standby. If you return the handset to the base, the phone will return to standby also.

Storing Phone Numbers and Names

Memory Dialing allows you to dial a number using just a few key presses. Your EXAI2248 series stores up to 10 names/numbers in the handset.

1) Press and hold **memory** until "Memory Store" is displayed.

2) Press **^** or **v**, or enter a number (0 - 9) to select the memory location where you would like to store the number.

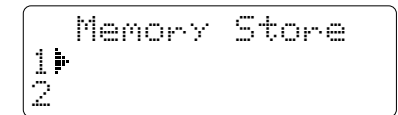

3) Press **select**. The following screen appears and a cursor flashes indicating that the display is ready for the name to be entered.

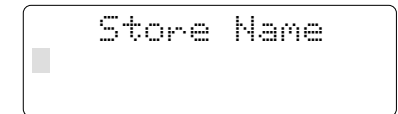

If this screen appears, the selected memory location is already stored. Then you must either edit the entry in this location, delete the entry in this location, or select "Go Back" to choose another location.

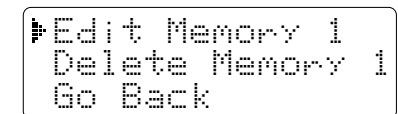

4) To enter a name (up to 14 characters), use number keys.

- See the "Steps for Entering Names and Special Characters". (See pages 24-25)
- Use **#/>** and ***/tone/<** to move the cursor to the desired location.
- Use **delete/ch** to delete characters as needed.
- Press and hold **delete/ch** to delete all the characters.
- If a name is not required, go to step 5.

- 5) Press **select**. "Store Number" is displayed.
The cursor flashes indicating that the display is ready for the number to be entered.
- 6) Use the number keys to enter the phone number.
The phone number cannot exceed 20 digits.
 - Use **redial/p** to enter a pause in the dialing sequence.
The display shows a "P". Each pause counts as one digit and represents a two second delay of time between the digits as they are sent.
 - Use **delete/ch** to delete digits as needed.
- 7) Press **select**. You will hear a confirmation tone and the following display appears. Memory storage is complete. For example, if you store a name and number into memory location number 7, the display shows "Memory 7 Stored".
After about 2 seconds, "Memory Store" is displayed.
Repeat steps 2 - 7 to store more numbers.
- 8) Press **end** to return to standby mode.

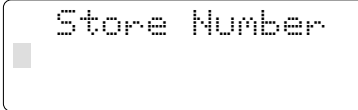

Store Number



Store Number
8002971023

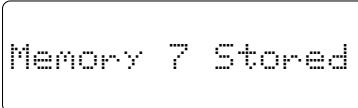

Memory 7 Stored

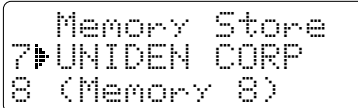

Memory Store
7 UNIDEN CORP
8 (Memory 8)

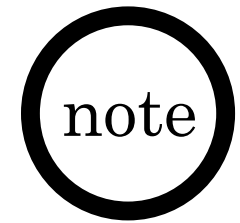

- The pause feature is useful for long distance calling, credit card dialing, or sequences that require a pause between digits.
- The pause key counts as one digit. Pressing **redial/p** more than once increases the length of a pause between numbers.
- The 10 memory locations are represented by the numbers 0-9 on the keys. If you store a number in one of the locations, then attempt to store a different number in the same location later, the new number will overwrite the previous one.

Steps for Entering Names and Special Characters

Refer to the letters on the number keys to select the desired characters. With each press of a numeric key, the displayed character appears in the following order: Upper case letters first, lower case letters next, and finally the number corresponding to the key.

Keys	Number of times key is pressed								
	1	2	3	4	5	6	7	8	9
1	1								
2abc	A	B	C	a	b	c	2		
3def	D	E	F	d	e	f	3		
4ghi	G	H	I	g	h	i	4		
5jkl	J	K	L	j	k	l	5		
6mno	M	N	O	m	n	o	6		
7pqrs	P	Q	R	S	P	q	r	s	7
8tuv	T	U	V	t	u	v	8		
9wxyz	W	X	Y	Z	w	x	y	z	9
0	*	#	-	&	()	(blank)	0	

If you make a mistake while entering a name

Use ***/tone/**< or **#/**> to move the cursor to the incorrect character, press **delete/ch** to erase up to the wrong entry, then enter the correct character. To delete all characters, press and hold **delete/ch**.

For example, to enter **Uniden**;

- 1) Pick up the handset. Press and hold *memory*.
- 2) Enter a number or press **▲**, **▼** to select a memory location number.
- 3) Press *select*.
- 4) Press **8** twice.
- 5) Press **6** five times.
- 6) Press **4** six times.
- 7) Press **3** four times, then press **#/➤** to move the cursor to the right.



If the next character uses the same number key, you must press **#/➤** to move the cursor over. Otherwise the next time you press the number key, it changes the character that was previously set.

- 8) Press **3** five times.
- 9) Press **6** five times.
- 10) When finished, press *select*.

To continue to store the telephone number, proceed to step 6 on page 23.



- If you press *select* before *talk/flash*, you can confirm the name and the number stored in the selected memory location.
- To exit the memory function without dialing, press *end*. The handset returns to standby.
- Whenever you are using a memory menu screen, you must press a key within 30 seconds or the phone will return to standby.

Making Calls with Memory Dialing

Memory dialing from Standby Mode

1) Press *memory*.

The handset displays your programmed memory locations.

```

1▶UNIDEN CORP
2 JOHN DOE
3▶MOM AND DAD
  
```

2) Press \wedge or \vee , or enter a number (0 - 9) to select the memory location you would like to dial.

3) Press *talk/flash*. "Talk" and the volume setting appear on the display. Then the displayed number is dialed.

```

>Talk<
0123456789012
  
```

Display a programmed number

Use $\#/\>$ and $*/tone/ <$ to toggle between the names display and the numbers display.

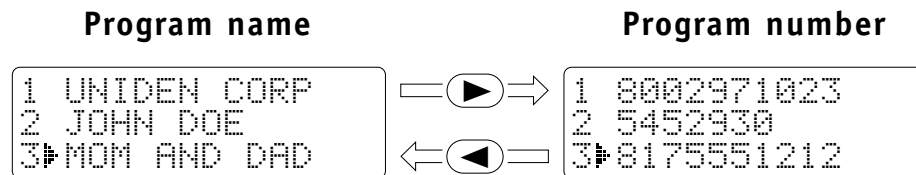

When the stored phone number has 15 or more digits, " \blacktriangleright " is displayed next to the 13th digit. Press $\#/\>$ to see the extra digits and $*/tone/ <$ to return.

```

5 012345678901
6▶011813554329▶
7
  
```

Memory dialing from Talk Mode

1) Press **talk/flash**. "Talk" and the volume setting appears.

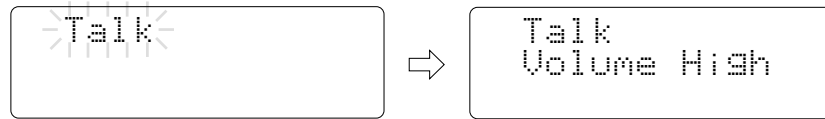

2) Press **memory**.

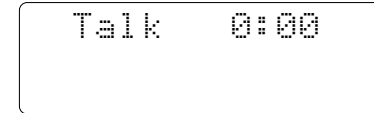

3) Enter a number (0 - 9) to select the memory location of the desired phone number. The selected phone number is displayed. Then the number is dialed.

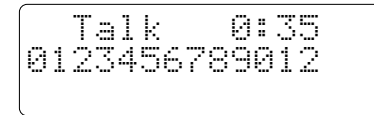

4) To hang up, press **end**.

Chain Dialing

The memory locations on the handset are not limited to phone numbers. You can also store a group of numbers (up to 20 digits) that you need to enter once your call connects. This is referred to as Chain Dialing.

An example of this is a bank account number. Once you have called your bank, and are prompted to enter the account number, simply press **memory** and the location number where the special number has been stored.

Store your special number with an identifying name. (Refer to "Storing Phone Numbers and Names" on page 22.)

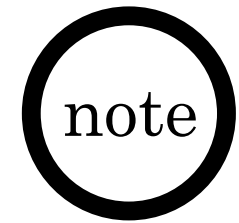

If you select a memory location that does not have a stored number, the handset will beep rapidly and the phone will not dial.

Editing a Stored Name and/or Phone Number

1) Press and hold **memory** until "Memory Store" is displayed.

```
Memory Store
1 UNIDEN CORP
2 JOHN DOE
```

2) Press **^** or **v**, or enter a number (0 - 9) to select the memory location you would like to edit.

3) Press **select**.

The following screen appears with the memory location number that you have selected in the display.

```
Edit Memory 1
Delete Memory 1
Go Back
```

4) Press **^** or **v** to select "Edit Memory", then press **select**.

The following screen appears.

The cursor flashes indicating that the display is ready for the name to be edited. When a name has not been stored, the cursor appears at the beginning of the second line.

```
Store Name
UNIDEN CORP
```

5) Use the number keys, ***/tone/<**, **#/>**, or **delete/ch** to edit the name.
(See page 22.)

To edit only the phone number, skip this step.

6) Press **select**. The following screen appears.

The cursor flashes indicating that the display is ready for the number to be edited.

```
Store Number
8002971023
```

7) Use the number keys, **redial/p** or **delete/ch** to edit the phone number.

The phone number cannot exceed 20 digits. (See page 23.)

If you don't want to change the phone number, skip this step.

8) Press ***select***. You hear a confirmation tone and the following display appears. The memory storage is complete. For example, if you store a name and number into memory location number 1, the display shows "Memory 1 Stored". After about 2 seconds, "Memory Store" is displayed.

A rectangular box containing the text "Memory 1 Stored" in a monospaced font.

```
Memory 1 Stored
```

A rectangular box containing the text "Memory Store" followed by two lines of memory entries: "1 UNIDEN CORP" and "2 JOHN DOE".

```
Memory Store
1 UNIDEN CORP
2 JOHN DOE
```

9) Press ***end*** to return to standby mode.

Erasing a Stored Name and Phone Number

1) Press and hold **memory** until "Memory Store" is displayed.

```
Memory Store
1 UNIDEN CORP
2 JOHN DOE
```

2) Press **▲** or **▼**, or enter a number (0 - 9) to select the memory location you would like to erase.

3) Press **select**.

The following screen appears with the memory location number that you have selected in the display.

```
Edit Memory 2
Delete Memory 2
Go Back
```

4) Press **▼** to move the pointer down to "Delete Memory".

```
Edit Memory 2
Delete Memory 2
Go Back
```

5) Press **select**. The following confirmation screen appears.

```
Delete Memory 2?
Yes
Delete Memory 2?
No
```

7) Press **select** or **delete/ch**.

You hear a confirmation tone and the following screen appears.

```
Memory 2 Deleted
```

8) After about 2 seconds the display returns to the "Memory Store" screen.

You may delete the information in another memory location (return to step 2) or press **end** to return to standby mode.

```
Memory Store
2 UNIDEN CORP
3 MOM AND DAD
```

RocketDial

You can store your most frequently dialed number in the RocketDial. The RocketDial allows you to dial a number with one key press. (There is no need to press *talk/flash*. The phone will automatically dial the number stored.)

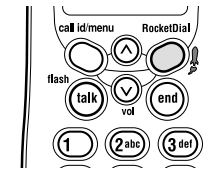

Storing and Editing the RocketDial

- 1) When the phone is in the standby mode, press and hold **RocketDial**.
Following display appears.

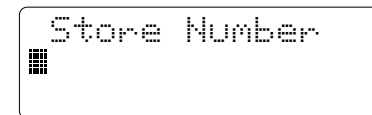

If this screen appears, there is a number already stored. Press **^** or **v** to select "Edit Number", then press **select**.

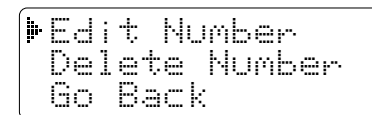

- 2) Store the number by following step 6 under "Storing Phone Numbers and Names" on page 23.

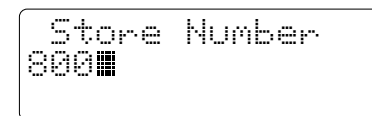

- 3) Press **select**.
You hear a confirmation tone and displays the following screen. Memory storage is complete.

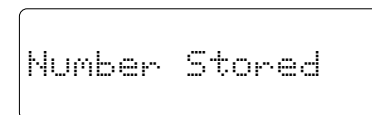

- Memory location for the RocketDial is independent from the memory location for Memory dial.
- If the RocketDial does not have a stored number, the handset will beep rapidly and the phone will not dial.

Making calls with the RocketDial

When the phone is in the standby mode, simply press **RocketDial**. The number stored in the RocketDial is instantly dialed.

Deleting the RocketDial

1) When the phone is in the standby mode, press and hold **RocketDial**. Following display appears.

```
▸ Edit Number  
Delete Number  
Go Back
```

2) Press **▲** or **▼** to select "Delete Number".

3) Press **select**. Following display appears.

```
Delete Number?  
Yes  
▸ No
```

4) Press **▲** to move the pointer to "Yes".

5) Press **select** or **delete/ch**.

You hear a confirmation tone and the following display appears. The handset returns to standby.

```
Number Deleted
```

Caller ID

You must subscribe to Caller ID service to use this feature.

When the telephone rings, the Caller ID feature allows you to view the caller's name and phone number on the display before you answer the phone.

The handset displays the phone number of the incoming call, the name, and time. Additionally, you can dial the displayed number and store the information for memory dialing.

Make sure you have turned on the Caller ID/Call Waiting feature. (See page 15.)

When the Telephone Rings

1) When the Caller ID message is received, the display shows the caller's phone number along with the date and time. The incoming call information is stored in the Caller ID record. If the Caller ID service includes the caller's name, the caller's name appears on the display (up to 15 letters).

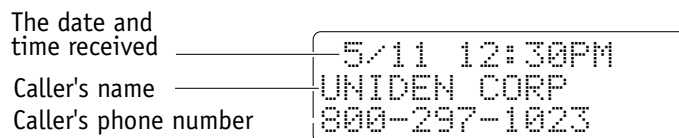

Here are some typical displays;

When the phone number and name data are received

```
5/11 12:30PM  
UNIDEN CORP  
800-297-1023
```

When invalid data is received

```
Incomplete Data
```

When a private name is received

```
5/11 12:30PM  
Private Name  
800-297-1023
```

When a private number is received

```
5/11 12:30PM  
UNIDEN CORP  
Private Number
```



- If you answer a call before the Caller ID message is received (Example: before the second ring), the Caller ID message will not appear.
- When the call is received via a telephone company that does not offer Caller ID service, the caller's phone number and name do not appear. (This includes international calls.)
- When the call is via a private branch exchange (PBX), the caller's phone number and name may not appear.



- In Caller ID operation, if no key is pressed for more than 30 seconds, an error tone sounds and the telephone returns to the standby mode.
- If a call comes in via a telephone system that does not offer Caller ID service, no information is stored.
- Each message can be up to 15 characters for the phone number and the name.
- The number of calls from the same Caller ID appears next to the received time. Once you read the new message, the number will be cleared and disappear.

When an unknown name is received

```
5/11 12:30PM  
Unknown Name  
800-297-1023
```

When an unknown number is received

```
5/11 12:30PM  
UNIDEN CORP  
Unknown Number
```

2) When you pick up the phone, the display changes to "Talk". (AutoTalk feature is set to on.)



Data errors appear as "■".

Viewing the Caller ID Message List

The Caller ID list stores information for up to 30 incoming calls - even unanswered calls.

1) Press **call id/menu**.

The summary screen appears.

The screen shows the number of new messages and total messages.

```
New :01  
Total:02
```

2) Press **▼** or **▲** to display the latest or oldest Caller ID message.

```
5/17 12:30PM 03  
UNIDEN CORP  
800-297-1023
```

3) Press **▼** to see the next message. Or press **▲** to see previous message.

4) Press **end** to return to standby mode.

Deleting Information from the Caller ID List

The EXAI2248 series stores up to 30 messages. If the phone receives the 31st message, the oldest one in the list is automatically deleted. Caller ID data can also be deleted manually.

Deleting a Caller ID message

- 1) Press *call id/menu*. Display the message to be deleted from the Caller ID list by pressing **▲** or **▼**.
- 2) Press *delete/ch*.
- 3) Press **▲** or **▼** to select "Yes" or "No".
- 4) Press *select* or *delete/ch*.

```
5/17 12:30PM 03  
UNIDEN CORP  
800-297-1023
```

```
Delete Message?  
▶ Yes  
No
```

When the pointer is at "Yes":

A tone sounds and the Caller ID message is deleted. The next Caller ID message is then displayed.

When the pointer is at "No":

The display returns to the Caller ID message.

Deleting all Caller ID names/numbers

- 1) Press *call id/menu*.
- 2) Press *delete/ch*.

```
New :01  
Total:02
```

```
Delete All?  
Yes  
▶ No
```

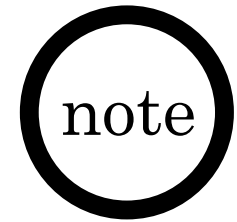

- While using the "Delete All?" or "Delete Message?" screen if no key is pressed for more than 30 seconds, an error tone sounds and the telephone returns to standby.
- If you get an incoming call or page, the deleting operation is canceled and the telephone returns to standby so you can answer the call or page.

3) Press **^** or **v** to select "Yes" or "No".

4) Press **select** or **delete/ch**.

When the pointer is at "Yes":

A confirmation tone sounds and all stored Caller ID messages are deleted.

When the pointer is at "No":

The display returns to the summary screen.



Total:00



New :01
Total:02

Using the Caller ID List

Calling a party from the Caller ID list

You can place a call from the Caller ID list. The EXAI2248 series stores up to 30 messages.

1) Press **call id/menu**. Select the phone number that you want to dial by pressing **^** or **v**.

2) Press **talk/flash**. The displayed phone number dials automatically.



5/17 12:30PM 03
UNIDEN CORP
800-297-1023

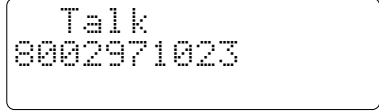

Talk
8002971023

Long Distance calls and Area Code Setting/Cancellation

While the incoming Caller ID information is displayed (in step 1), pressing **1** will place or remove the prefix "1" in the display to set up for a long distance call or cancel. Pressing **3** will set or cancel an area code setting.

Dial edit

You can temporarily edit the Caller ID number that is displayed by pressing **select**. A cursor appears in the display. Press **delete/ch** to move the cursor left, make your changes, and then press **talk/flash**. This will not change the number in the Caller ID list memory.



- You cannot make a call from the Caller ID list if your EXAI2248 series is connected to private branch exchange (PBX).
- When a long distance call has been set, "1" appears in the display.

Storing Caller ID messages in Memory dialing

Messages shown in the Caller ID list can be stored in memory dialing. Using the incoming call information (i.e., Caller ID list), the phone number of the party on the Caller ID list can be stored in memory.

1) Press **call id/menu**.
Select the phone number to be stored from the Caller ID list by pressing **^** or **v**.

```
5/17 12:30PM 03  
UNIDEN CORP  
800-297-1023
```

2) Press **memory**.

```
Select Location  
1  
2 JONE DOE
```

3) Press **^** and **v** or enter a number (0 - 9) to select the memory location to be stored.

4) Press **select**.
The handset beeps and the number is stored in memory.
The display returns to the Caller ID list.

```
5/17 12:30PM 03  
UNIDEN CORP  
800-297-1023
```



If a message has already been stored in the selected memory number location, a confirmation screen is displayed. Press **^** to select "Yes". Press **select** to overwrite. The display returns to the Caller ID list.

```
Replace Memory?  
Yes  
No
```



You can not store a Caller ID message if no phone number appears in the message.

The Integrated Answering Device

The EXAI2248 series has a built-in answering system that answers and records incoming calls. You can also use your answering system to record a conversation, leave a voice memo message for others who use the phone, or to announce a special message to callers when you're away from your phone.

Features

- Digital Tapeless Recording
- 15 minutes of Recording Time
- Call Screening
- Selectable Outgoing Messages
- Voice Prompt for Guidance
- Time and Day Announcement
- Remote Message Retrieval
- Toll Saver
- Conversation Recording
- Voice Memo

Digital Tapeless Recording allows you to quickly review, save, or delete the messages you choose. You will never have to worry about a tape wearing out, jamming, or resetting improperly.

The Integrated Answering System is easy and convenient to use, but please read through all of the instructions carefully.

Turning the Answering System On/Off

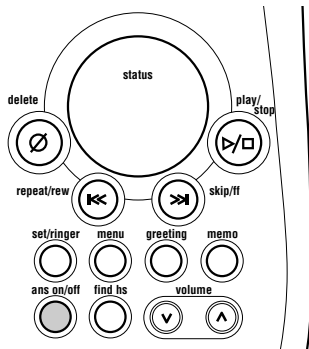

- 1) To turn the answering system on, press **ans on/off**.
The current greeting message will be played and you will hear a confirmation tone. The message counter displays the number of messages stored in memory. If the display flashes, then there are new messages waiting for you.
- 2) To turn the answering system off, press **ans on/off** again.
After the announcement "Answer off" the message counter display goes out.

Setting up Your Answering System

Using the Menu Mode

The Menu mode allows you to set the following Answering System functions.

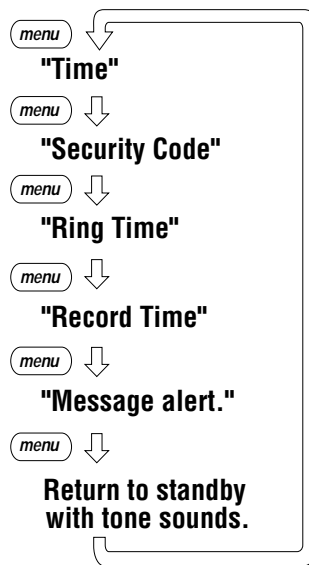

- To scroll through the menu option, repeatedly press **menu**.
The system returns to standby after the last menu option. A confirmation tone sounds to indicate Standby Mode.
- If any of the following occurs during menu setup, the handset returns to standby. Start over with menu function prior to the interruption.
 - Press **talk/flash**
 - Press **play/stop**
 - 30 seconds lapse of time
 - Receive a call
- The idle time default setting is 30 seconds. If the base remains idle for 30 seconds, an error tone sounds and the system returns to standby.
- You can use volume **^**/**v** to adjust the announcement volume level during a voice prompt/guidance.



- For your convenience, voice prompts will guide you through the menu mode.
- After the setting, press **play/stop** to exit the menu mode, or **menu** to move to the next menu. Or the system automatically returns to standby in 30 seconds after the setting.



- Normally the idle time for the menu mode is 30 seconds before the system returns to standby. However for setting the time, the idle time is extended to two minutes.
- Press and hold **skip/ff** or **repeat/rew** to quickly scroll through numbers on the display.

Setting the Time

The clock on the EXAI2248 series answering system starts when power is applied to the base. Follow these steps to set the clock to the correct time.

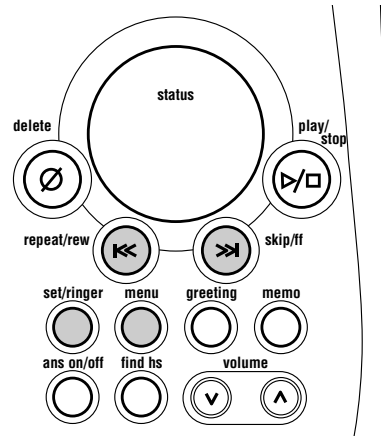

- 1) Press **menu**.
The system announces "Time" and the current time. The message counter displays the current numbers ([0] through [5]) indicating the day.
- 2) Press **skip/ff** or **repeat/rew** until the correct day is announced.
The numbers [0] through [5] are displayed on the base.
- 3) Press **set/ringer** to select the day.
- 4) Press **skip/ff** or **repeat/rew** until you hear the correct hour setting. The numbers [1] through [12] are displayed on the base as each hour is announced.
- 5) Press **set/ringer** to select the hour.
- 6) Press **skip/ff** or **repeat/rew** until you hear the correct minute setting. The numbers [00] through [59] are displayed on the base as each minute is announced.

- 7) Press **set/ringer** to select the minute.
- 8) Press **skip/ff** or **repeat/rew** until you hear the correct AM or PM setting.
The message counter displays [*A*] or [*P*].
- 9) Press **set/ringer** to select the AM/PM.

You hear a confirmation tone, then the announcement “Time” and the time that you have set. The base LED displays the number of the day.

Setting a Personal Security Code (PIN)

To play your messages from a remote location, you will need to enter a two-digit Personal Identification Number (PIN) code (00-99). To select a PIN, perform the following steps:

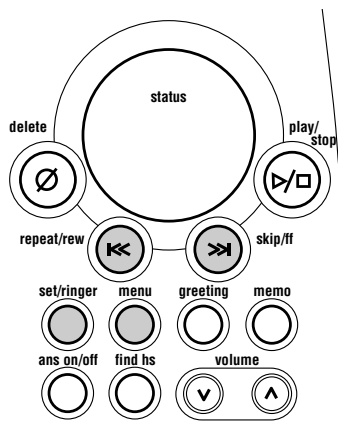

- 1) Press **menu** twice.
“Security code” and the current PIN code is announced as it is displayed on the base.
- 2) Press **skip/ff** or **repeat/rew** until the desired number appears.
- 3) Press **set/ringer** to select the PIN code. You hear a confirmation tone, then the announcement “Security cord” and the new PIN code.



The PIN code is set to "80" when you purchase the EXAI2248 series.

Setting the ring time

The ring time setting allows you to set the number of rings the caller hears before your answering system plays the outgoing message. You can set the ring time to answer after two, four, or six rings. Setting t5 (Toll Saver), the answering system picks up after two rings if you have new messages, and after four rings if there are none. This way, if you make a long distance call to check your messages, you can hang up after the second ring to avoid billing charges.

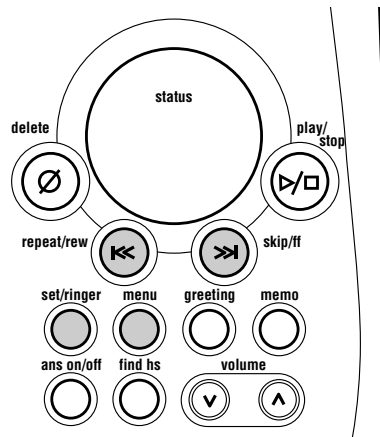

- 1) Press **menu** three times.
You hear "Ring time" and the current ring time ([2] 2, [4] 4, [6] 6, [t5] Toll saver), and it is displayed on the base.
- 2) Press **repeat/rew** or **skip/ff** until the desired ring time appears.
- 3) Press **set/ringer** to select the new ring time. You hear a confirmation tone, then the announcement "Ring time" and the new ring time.

Selecting the message record time

You have three record time options. The options "1 minute" , or "4 minutes" set the duration for recording the incoming messages. "**Announce only**" answers the call with the preset greeting or your personal greeting but prevents the caller from leaving a message.

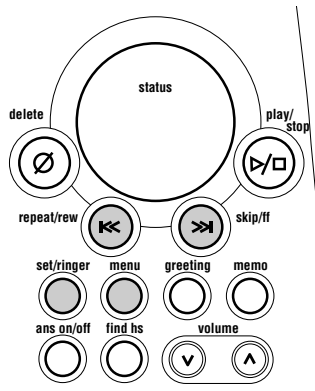

- 1) Press **menu** four times.
You hear "Record time" and the current recording time ([/] 1 minute, [4] 4 minutes, [A] Announce only), and it is displayed on the base.
- 2) Press **repeat/rew** or **skip/ff** until the desired time appears.
- 3) Press **set/ringer** to select the new recording time. You hear a confirmation tone, then the announcement "Record time" and new recording time.

▼ Announce only feature

The announce only feature plays a prerecorded outgoing message or the previously set personal outgoing message, but it will not allow the caller to leave a message. To set "Announce only", follow the steps above.

To choose between the prerecorded message or your own personal greeting, press **greeting** when the outgoing message is played. If you want to use your own greeting, you may want to change your greeting to omit the prompt to leave a message. Refer to "Recording a personal outgoing message" (Greeting) on page 45.

The following message is prerecorded:

"Hello, no one is available to take your call. Please call again."

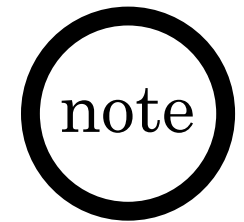

When using the Announce only feature, you may want to change your outgoing message, if the message prompts the caller to leave a message. The prerecorded message changes automatically.

Setting the message alert

Message Alert feature let you know you have new messages. If you turn the message alert on and any new message is received, the beep sounds every 15 seconds. The beeps stops when you press any key on the base, or you have checked all of new messages by using the remote feature.

1) Press **menu** five times.

You hear the announce "Message alert" and the current setting ([**OFF**] Off or [**ON**] On), and it is displayed on the base.

2) Press **repeat/rew** or **skip/ff** to select.

3) Press **set/ringer** to select the new setting. You hear a confirmation tone, then the announcement "Message alert" and the current setting you have selected.

Setting Your Outgoing Message (Greeting)

When you receive a call, the answering system automatically plays either a preset message or your own greeting.

▼Preset message

The following message is prerecorded:

"Hello, no one is available to take your call. Please leave a message after the tone."



See "Selecting the message record time", page 43 how to set the announce only feature.

▼Recording a personal outgoing message (Greeting)

1) Press and hold ***greeting***.

You hear the announcement "Record greeting" and a confirmation tone. [--] flashes on the message counter.

2) Start recording your message. You have 30 seconds and the message counter start to count down [30] to [01] every 1 seconds.

3) When you are finished recording your greeting, press ***greeting*** or ***play/stop***. You hear a confirmation tone, and then your greeting plays back on the base speaker.

▼Choosing between the two outgoing messages

Press ***greeting***. Then press ***greeting*** again when the outgoing message is played. This switches between the two options. After finishing playing back the message, a confirmation tone is heard.



To delete the personal Greeting, press ***delete*** during the announcement and the system announces "Greeting has been deleted".



- You can record a greeting up to 30 seconds long.
- Position yourself as near to the base as possible and speak clearly when recording your outgoing message.



When you have set the base ringer to off and the handset is on the base, you will still hear the ringer from the handset.

Setting the base ringer volume

You have three ringer options. One allows you to turn the ringer off. The other two are volume levels.

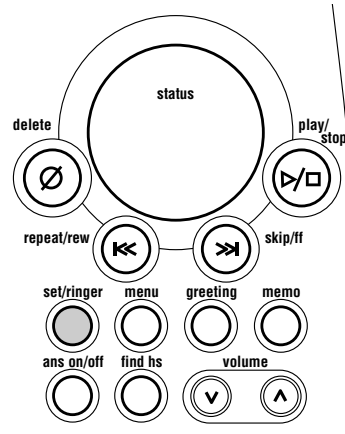

1) Press **set/ringer**.

You hear the ringer at the current level ([*H* ,] High, [*Lo*] Low, [*OFF*] off) (if you set the base ringer volume to off “off” is announced) and it is displayed on the base.

2) Press **set/ringer** until the desired ringer option appears.

3) The system displayed new ringer volume.

Adjusting the speaker volume level

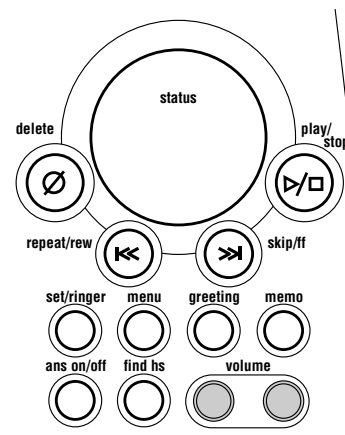

You can adjust the volume of the base speaker by pressing the **volume** keys on the base. Press **^** for louder or **v** for softer during the base speaker is being used.

The numbers 0-9 are displayed on the base indicating the volume levels. 0 being the softest and 9 being the loudest.



When you press **^** at 9 or **v** at 0, an error tone sounds.

Using Your Answering System

The message counter displays the number of messages stored in memory. If the display flashes, then there are new messages waiting for you. The flashing number represents the number of new messages, not total messages. The EXAI2248 series is designed to play your new messages first. After you play all your new messages, you can then play your old messages.



When the answering system is full, *FL* is displayed on the base, and the system announces "No remaining time". You should delete some messages so that the system can record new messages. (Refer to "Deleting a message" on page 49.)

Playing your messages

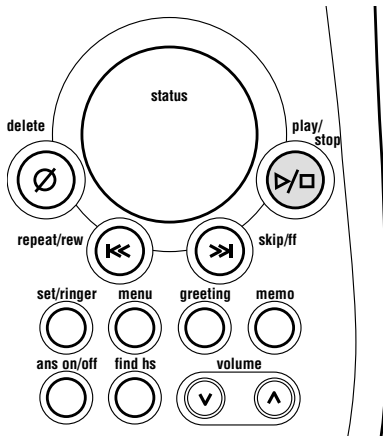

1) Press *play/stop*.

The system announces the number of new and old messages. The LED displays the number of new messages, and the number flashes. The day and time that each message was received is announced after the message is played, and the message counter displays the number of the current messages.

When all new messages have been played, you hear a confirmation tone and an announcement "End of messages". The system returns to standby.

2) After you have reviewed your new messages, you can play your old messages by again pressing *play/stop*. Once you have listened to a new message, it becomes an old message. The old messages will then be played in the order in which they were received.



To stop playing your messages, press *play/stop* again at any time.

Repeating a Message

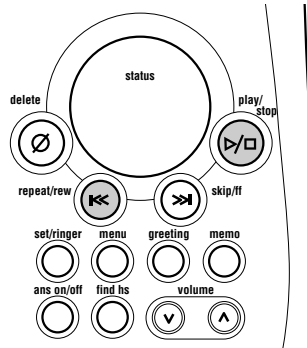

- 1) Press **play/stop** to review your messages. The number of stored messages are announced.
- 2) After a message has played for a few seconds, press **repeat/rew** to replay the message. If you have several messages, press **repeat/rew** repeatedly until you return to the message you want to replay.
- 3) Press **play/stop** at any time to stop reviewing messages and return to standby. The message counter shows the number of messages stored in memory.

*To scroll backward a message quickly, press and hold **repeat/rew**.*

Skipping a message

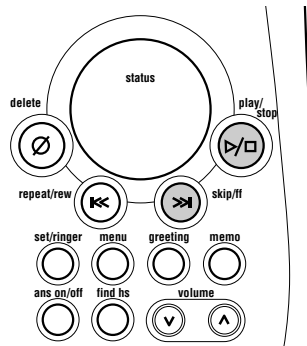

- 1) Press **play/stop** to review your messages. The number of messages is announced.
- 2) Press **skip/ff** at anytime to skip to the next message. Each time **skip/ff** is pressed, the system scans forward one message. If you have several messages, press **skip/ff** to find the message you want to play.
- 3) Press **play/stop** at any time to stop reviewing your messages and return to standby. The message counter shows the number of messages stored in memory.

*To scroll forward a message quickly, press and hold **skip/ff**.*

Deleting a message

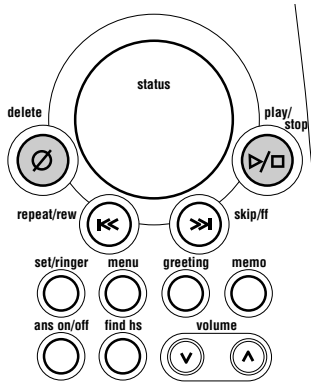

To maintain maximum record time, it is a good idea to delete the old messages.

- 1) Press **play/stop** to review your messages.
- 2) Press **delete** anytime during the message to delete.
- 3) You hear a confirmation tone and the message is deleted.

You can also delete all the messages.

- 1) Press **delete**.
You hear an announcement "To delete all messages, press delete again".
- 2) Press **delete** again.
You hear a confirmation tone and all the messages are deleted.

When you try to delete all messages without first listening to your new messages, you hear several short beeps followed by an announcement "Please playback all messages". This protects you from accidentally erasing messages you have not heard yet.

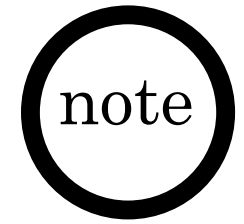

When you press **delete**, you are permanently deleting the message. Once deleted, the message cannot be replayed.



- The voice memo function is completely independent of the greeting message. It's easy to leave others quick messages.
- The voice memo messages are recorded as incoming messages.
- A recorded conversation is treated as a typical message and will be added to the stored messages.
- When recording a conversation, all handset keys, except **talk/flash**, **delete/ch**, volume **^/v** and **end** are disabled. Stop recording if you need to enable any other handset keys.

Voice memo

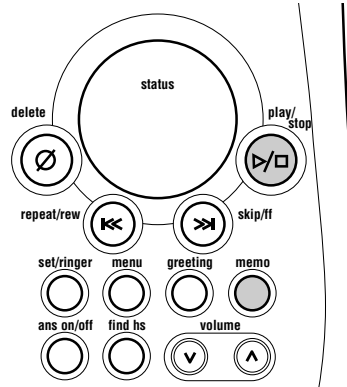

The voice memo function allows the user to record messages (up to 10 minutes).

- 1) Press and hold **memo**.
You hear an announcement "Record message" and a confirmation tone. [--] flashes on the message counter.
- 2) Start your recording.
- 3) When you have finished, press **play/stop** or **memo** to stop recording. You hear a confirmation tone and the system returns to standby.

Recording a conversation

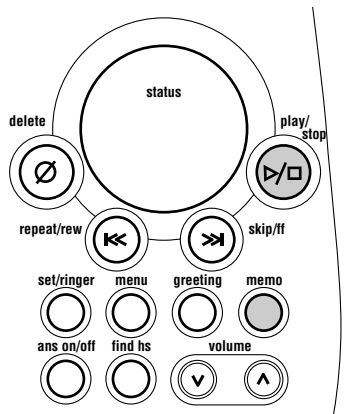

You can record up to 10 minutes of conversation while you are using your phone.

- 1) During a conversation from the handset, press and hold **memo**.
The unit begins recording and [--] flashes on the message counter.
A beep that can be heard by both parties, sounds during recording.



If you receive a call waiting tone while recording a conversation, press **flash** to accept the waiting call. The recording feature continues recording the new call. The original call is put on hold.

- 2) To stop recording, press **play/stop** or **memo**.

Remote access away from home

You can operate your answering system from a remote location using any touch-tone telephone. Use this function to check for recorded messages, to play or delete messages, even to record a new greeting message.

- 1) Call your telephone number.
- 2) During the greeting message playbacks, press **#** and enter your PIN code. (See "Setting a Personal Security Code", page 41).
- 3) The answering system announces the current time and the number of messages stored in memory. Then you hear "To play incoming messages, press pound two. For help, press pound zero".
- 4) You may continue to listen to the Help Guidance, or you may select a command from the following chart:

Command	Function
# then 1	Repeat a Message
# then 2	Playing Incoming Messages
# then 3	Skipping a Message
# then 4	Deleting a Message
# then 5	Stop Operation
# then 6	Answering System On
# then 7	Memo Record/Stop
# then 8	Greeting Message Record/Stop
# then 9	Answer System Off
# then 0	Help Guidance

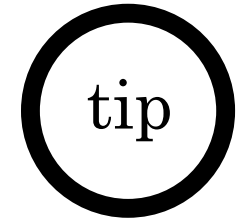

For your convenience a remote operation cards are provided for you to use while away from home (located towards the back of this manual).

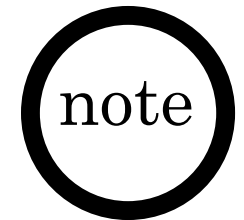

You must enter a command within 15 seconds of entering command waiting mode or the answering system automatically hangs up and returns to standby.

* For Memo Record and Greeting Message Record function, the first time you enter the corresponding command, it starts the Recording function. If you want to stop the recording, enter the command again.

5) After all of the Help Guidance menu has played, you hear intermittent beeps indicating that the system is in the command waiting mode. You may enter another command at this time from the chart above.

6) When you are finished, hang up to exit the system. The answering system automatically returns to standby.

Turn on the answering system remotely

If you have forgotten to turn on your answering system, you can turn it on remotely from any touch-tone telephone.

1) Call your telephone number.

2) Wait ten rings until the system answers. You hear a beep.

3) Press **#** and then enter your PIN code. The answering system announces the number of messages stored in memory. You hear "To play incoming messages, press pound two. For help, press pound zero".

4) Press **#** then **6** to turn the answering system on. You hear the outgoing message and a confirmation tone.

5) Hang up the phone and subsequent calls will be answered by the system.

Changing the Digital Security Code

The digital security code is an identification code used to connect the handset and the base unit. Normally, setting the code is not necessary.

The first time you charge your handset, the security code is automatically set. (See "About the digital security code", page 7.) In the rare situation that you suspect another cordless telephone is using the same security code, you can change the code.

- 1) Remove the handset from the base unit. Press and hold ***find hs*** on the base.
- 2) While the handset is emitting the paging sound, place the handset on the base unit holding ***find hs***. The paging sound stops.
Leave the handset on the base for more than 3 seconds.
A new random security code is set.

Installing the Beltclip

To attach the beltclip

Insert the beltclip into the holes on each side of the handset. Press down until it clicks.

To remove the beltclip

Pull both sides of the beltclip to release the tabs from the holes.

Headset Installation

Your phone may be used with an optional headset, the Uniden HS910. To use this feature, insert headset plug into the headset jack. Your phone is ready for hands-free conversations.

(Headset may be purchased by calling the Uniden Parts Department or visiting the web site. See Page 8.)

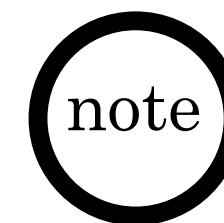
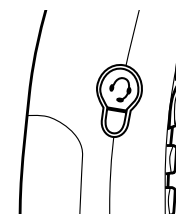

If the handset battery pack is completely discharged or the battery pack is removed, the digital security code will be lost. If this happens, a new security code is set automatically next time the battery pack is charged.

Note on Power Sources

Battery replacement and handling

When the operating time becomes short, even after a battery is recharged, please replace the battery. With normal usage, your battery should last about one year. Please contact your place of purchase or the Uniden Parts Department for a replacement battery.

Warning: To avoid the risk of personal injury or property damage from fire or electrical shock, only use the Uniden battery model and Uniden adapter model specifically designated for this product.

RECYCLING NICKEL-CADMIUM BATTERIES



NICKEL-CADMIUM BATTERIES MUST BE DISPOSED OF PROPERLY.

Nickel-cadmium cells are used in the battery pack. Please take your used nickel-cadmium battery packs to a store that recycles nickel-cadmium batteries.

Power Failure

During the period that the power is off, you will not be able to make or receive calls with the telephone.

Caution

- Use only the specified Uniden battery pack (BT-905).
- Do not remove the battery from the handset to charge it.
- Never throw the battery into a fire, disassemble it, or heat it.
- Do not remove or damage the battery casing.

Maintenance

When slightly dirty

Wipe with a soft, dry cloth.

When very dirty

Wipe with a soft cloth that has been dampened with diluted, neutral detergent. Dry with a dry cloth.

When the charging terminals become dirty

Wipe with a dry cloth or a pencil eraser, if necessary. (See page 11 for the location of charging terminals.)

Caution

Do not use paint thinner, benzene, alcohol, or other chemical products. Doing so may discolor the surface of the telephone and damage the finish.

Troubleshooting

If your phone is not performing to your expectations, please try these simple steps first.

Symptom	Suggestion
The <i>status</i> LED won't illuminate when the handset is placed in the base.	<ul style="list-style-type: none"> • Make sure the AC adapter is plugged into the base and wall outlet. • Make sure the handset is properly seated in the base. • Make sure the charging contacts on the handset and base are clean.
The audio sounds weak and/or scratchy.	<ul style="list-style-type: none"> • Make sure that the base antenna is in a vertical position. • Move the handset and/or base to a different location away from metal objects or appliances and try again. • Press <i>delete/ch</i> in the Talk mode to help eliminate background noise. • Make sure that the handset is not too far from the base.
Can't make or receive calls.	<ul style="list-style-type: none"> • Check both ends of the telephone line cord. • Make sure the AC adapter is plugged into the base and wall outlet. • Disconnect the AC adapter for a few minutes, then reconnect it. • Change the digital security code (See page 53). • Make sure that the handset is not too far from the base.
The Caller ID does not display.	<ul style="list-style-type: none"> • The handset was picked up before the second ring. • The call was placed through a switch board. • Call your local telephone company to verify your Caller ID service is current.

Symptom	Suggestion
The handset doesn't ring or receive a page.	<ul style="list-style-type: none"> • The battery pack may be weak. Charge the battery for 15-20 hours. • The handset may be too far from the base unit. • Place the base unit away from appliances or metal objects. • Change the digital security code (See page 53).
Severe noise interference.	<ul style="list-style-type: none"> • Keep the handset away from microwave ovens, computers, remote control toys, wireless microphones, alarm systems, intercoms, room monitors, fluorescent lights, and electrical appliances. • Move to another location or turn off the source of interference.
The answering system does not work.	<ul style="list-style-type: none"> • Make sure the base unit is plugged in. • Make sure the answering system is turned on.
The answering system does not answer calls.	<ul style="list-style-type: none"> • Set the record time to either the one minute or four minute option. • The memory may be full. Delete some or all of the saved messages.
Messages are incomplete.	<ul style="list-style-type: none"> • The incoming messages may be too long. Remind callers to leave a brief message. • The memory may be full. Delete some or all of the saved messages.
After a power failure, the outgoing message is deleted.	<ul style="list-style-type: none"> • Record your personal outgoing message again. The default message should remain.

Symptom	Suggestion
No sound on the base unit speaker during call monitoring or message playback.	<ul style="list-style-type: none"> • Adjust the speaker volume on the base unit.
Cannot access remote call-in features from another touch-tone phone.	<ul style="list-style-type: none"> • Make sure you're using the correct PIN code. • Make sure that the touch-tone phone you're using can transmit the tone for at least two seconds. If it cannot, you may have to use another phone to access your messages.
If you still have a problem.	<ul style="list-style-type: none"> • Call our customer hotline at 1-800-297-1023.

General Information

The phone complies with FCC Parts 15 and 68.

Operating temperature: 0° to 50°C (+32°F to +122°F)

AC Adapter Information

AC Adapter part number: AD-420
Input Voltage: 120V AC 60Hz
Output Voltage: 9V AC 350 mA

Battery Information

Battery part number: BT-905
Capacity: 600 mAh, 3.6V
Battery use time (per charge)
From fully charged
Talk mode duration: 7 hours
Standby mode duration: 14 days



If the handset is left off of the base, the actual Talk mode duration will be reduced respective to the amount of time the handset is off the base.

Recharge your phone on a regular basis by returning the handset to the base after each phone call. When the operating time becomes short, even after the battery is recharged, please replace the battery. With normal usage, the battery should last about one year.

A replacement Uniden adapter and battery may be purchased at your local Uniden dealer or by contacting the Uniden Parts Department (800) 554-3988. Hours are from 7:00 a.m. to 5:00 p.m. Central Time, Monday through Friday. We can also be reached on the web at www.uniden.com

Specifications, features, and availability of optional accessories are all subject to change without prior notice.

Precautions!

Before you read anything else, please observe the following:

Warning!

Uniden America Corporation DOES NOT represent this unit to be waterproof. To reduce the risk of fire, electrical shock, or damage to the unit, DO NOT expose this unit to rain or moisture.

Rechargeable Nickel-Cadmium Battery Warning

- This equipment contains a rechargeable nickel-cadmium battery.
- Cadmium is a chemical known to the State of California to cause cancer.
- The rechargeable nickel-cadmium battery contained in this equipment may explode if disposed of in a fire.
- Do not short-circuit the battery.
- Do not charge the rechargeable nickel-cadmium battery used in this equipment in any charger other than the one designed to charge this battery as specified in the owner's manual. Using another charger may damage the battery or cause the battery to explode.

Rechargeable Nickel-Cadmium Batteries Must Be Recycled or Disposed of Properly



- Uniden voluntarily participates in an RBRC® industry program to collect and recycle nickel-cadmium batteries at the end of their useful life, when taken out of service within the United States. The RBRC® program provides a convenient alternative to placing used nickel-cadmium batteries into the trash or municipal waste stream, which is illegal in some areas.
- Through the RBRC® program, Uniden makes it easy for you to drop off the used battery at local retailers of replacement nickel-cadmium batteries. You may also contact your local recycling center for information on where to return the used battery. Please call 1-800-8-BATTERY for information on Ni-Cd battery recycling in your area. Uniden's involvement in this program is part of its commitment to protecting our environment and conserving natural resources.
- RBRC® is a registered trademark of the Rechargeable Battery Recycling Corporation.



The exclamation point within an equilateral triangle is intended to alert the user to the presence of important operating and maintenance (servicing) instructions in the literature accompanying the appliance.

Important Safety Instructions

When using your telephone equipment, these basic safety precautions should always be followed to reduce the risk of fire, electrical shock, and injury to persons:

1. Read and understand all instructions.
2. Follow all warnings and instructions marked on the product.
3. Unplug this product from the wall outlet before cleaning. Use a dry cloth for cleaning without liquid or aerosol cleaners.
4. Do not use this product near water; for example, near a bathtub, wash bowl, kitchen sink or laundry tub, in a wet basement, or near a swimming pool.
5. Do not place this product on an unstable cart, stand, or table. The telephone may fall, causing serious damage to the unit.
6. Slots and openings in the cabinet and the back or bottom are provided for ventilation. To protect the product from overheating, these openings must not be blocked or covered. This product should never be placed near or over a radiator or heat register. This product should not be placed in a built-in installation unless proper ventilation is provided.
7. This product should be operated only from the type of power source indicated on the marking label. If you are not sure of the type of power supply to your home, consult your dealer or local power company.
8. Do not allow anything to rest on the power cord. Do not locate this product where the cord will be damaged by persons walking on it.
9. Do not overload wall outlets and extension cords, as this can result in the risk of fire or electrical shock.
10. Never push objects of any kind into this product through cabinet slots, as they may touch dangerous voltage points or short out parts that could result in a risk of fire or electric shock. Never spill liquid of any kind on the product.
11. To reduce the risk of electric shock, do not disassemble this product. Take it to qualified service personnel when service or repair work is required. Opening or removing covers may expose you to dangerous voltages or other risks. Incorrect reassembly can cause electric shock when the appliance is subsequently used.
12. Unplug this product from the wall outlet and refer servicing to qualified service personnel under the following conditions:
 - A. When the power supply cord is damaged or frayed.
 - B. If liquid has been spilled into the product.
 - C. If the product has been exposed to rain or water.
 - D. If the product does not operate normally when following the operating instructions. (Adjust only those controls that are covered by the operating instructions. Improper adjustment of other controls may result in damage and will often require extensive repair work by a qualified technician.)
 - E. If the product has been dropped or the cabinet has been damaged.
 - F. If the product exhibits a distinct change in performance.
13. Do not use the telephone to report a gas leak in the vicinity of the leak.

Additional Battery Safety Precautions

Caution! To reduce the risk of fire or injury to persons by the battery, read and follow these instructions:

1. Use only the Uniden battery pack specified in the owner's manual.

2. Do not dispose of the battery pack in a fire. The cell may explode. Check the nickel-cadmium battery disposal package insert for disposal instructions.
3. Do not open or mutilate the battery pack. Released electrolyte is corrosive and may cause damage to the eyes or skin. It may be toxic if swallowed.
4. Exercise care in handling the battery in order not to short the battery with conducting materials such as rings, bracelets, and keys. The battery or conductor may overheat and cause burns.
5. Charge the battery pack provided with or identified for use with this product only in accordance with the instructions and limitations specified in the owner's manual provided for this product.
6. Observe proper polarity orientation between the battery pack and battery charger.

SAVE THESE INSTRUCTIONS!

Important Electrical Considerations

Unplug all electrical appliances when you know an electrical storm is approaching. Lightning can pass through your household wiring and damage any device connected to it. This phone is no exception.

Warning!

Please do not attempt to unplug any appliance during an electrical storm.

The FCC Wants You To Know

Changes or modifications to this product not expressly approved by Uniden, or operation of this product in any way other than as detailed by the owner's manual, could void your authority to operate this product. The equipment cannot be used on public coin phone service provided by the telephone company. Connection to party line service is subject to state tariffs. (Contact the state public utility commission, public service commission or corporation commission for information.)

Range

Your new phone is designed to achieve the maximum possible range by transmitting and receiving according to the highest specifications set forth by the FCC. We have rated this phone to operate at a maximum distance with the qualification that the range depends upon the environment in which the telephone is used. Many factors limit range, and it would be impossible to include all the variables in our rating. The Maximum Range rating of this phone is meant to be used as a means of comparison against other range claims.

Telephone Line Problems

The FCC has granted the telephone company the right to disconnect service in the event that your phone causes problems on the telephone line. Also, the telephone company may make changes in facilities and services which may affect the operation of your unit. However, your telephone company must give adequate notice in writing prior to such actions to allow you time for making necessary arrangements to continue uninterrupted service.

If you are having trouble with your telephone service, you must first disconnect your phone to determine if it is the cause of your problem. If you determine that it is the cause, you must leave it disconnected until the trouble has been corrected.

Radio Interference

Radio interference may occasionally cause buzzing and humming in your cordless handset, or clicking noises in the base. This interference is caused by external sources such as TV, refrigerator, vacuum cleaner, fluorescent lighting, or electrical storm. Your unit is NOT DEFECTIVE. If these noises continue and are too distracting, please check around your home to see what appliances may be causing the problem. In addition, we recommend that the base not be plugged into a circuit that also powers a major appliance because of the potential for interference. Be certain that the antenna on the unit is fully extended when needed.

In the unlikely event that you consistently hear other voices or distracting transmissions on your phone, you may be receiving radio signals from another cordless telephone or other source of interference. If you cannot eliminate this type of interference, you need to change to a different channel.

Finally, it should be noted that some cordless telephones operate at frequencies that may cause interference to nearby TVs and VCRs. To minimize or prevent such interference, the base of the cordless telephone should not be placed near or on top of a TV or VCR. If interference is experienced, moving the cordless telephone farther away from the TV or VCR will often reduce or eliminate the interference.

More Than One Cordless Telephone

If you want to use more than one cordless telephone in your home, they must operate on different channels. Press the channel key to select a channel that provides the clearest communication.

Cordless Telephone Privacy

Cordless telephones are radio devices. Communications between the handset and base of your cordless telephone are accomplished by means of radio waves which are broadcast over the open airways. Because of the inherent physical properties of radio waves, your communications can be received by radio receiving devices other than your own cordless telephone unit. Consequently, any communications using your cordless telephone may not be private.

Installation Considerations

Selecting a Location

Before choosing a location for your new phone, there are some important guidelines you should consider:

- The location should be close to both a phone jack and continuous power outlet. (A continuous power outlet is an AC outlet which does not have a switch to interrupt its power.)
- Keep the base and handset away from sources of electrical noise such as motors or fluorescent lighting.
- Be sure there is sufficient space to fully extend the base antenna.
- The base can be placed on a desk or tabletop or mounted on a standard telephone wall plate.
- You should charge your new phone for 15-20 hours before completing the installation or using the handset.

Telephone Line Outlets

There are two types of phone outlets:

Modular Jack

Most phone equipment available now uses modular jacks. Phone cords are fitted with a molded plastic connector which plugs into this type of jack. If you do not have modular phone jacks, contact your local telephone company for information about their installation.

Hardwired Jack

Some equipment is wired directly to a phone jack, and these types of installations require a modular jack converter. This type of installation is not difficult; however, you should contact your Uniden telephone dealer or a telephone supply store for advice about the proper adapter or converter for your particular situation.

Connecting the Telephone Cords

Consider these safety guidelines before connecting the telephone cords:

Caution!

- Never install telephone wiring during a lightning storm.
- Never touch uninsulated telephone wires or terminals unless the telephone line has been disconnected.
- Use caution when installing or modifying telephone lines.

Applying Power to the Base

This phone requires an AC outlet, without a switch to interrupt power, and the included AC adapter. To relieve strain on the DC plug when the phone is placed on a desk or table, wrap the power cord around the strain relief notch on the bottom of the base.

NOTE: Place the power cord so that it does not create a trip hazard, or where it could become chafed and create a fire or other electrical hazards.

Adapter Safety Features

Do not use an outlet controlled by a wall switch.



Use only the Uniden AC Adapter supplied with this phone.

One Year Limited Warranty

Important: Evidence of original purchase is required for warranty service.

WARRANTOR: UNIDEN AMERICA CORPORATION ("Uniden")

ELEMENTS OF WARRANTY: Uniden warrants, for one year, to the original retail owner, this Uniden Product to be free from defects in materials and craftsmanship with only the limitations or exclusions set out below.

WARRANTY DURATION: This warranty to the original user shall terminate and be of no further effect 12 months after the date of original retail sale. The warranty is invalid if the Product is (A) damaged or not maintained as reasonable or necessary, (B) modified, altered, or used as part of any conversion kits, subassemblies, or any configurations not sold by Uniden, (C) improperly installed, (D) serviced or repaired by someone other than an authorized Uniden service center for a defect or malfunction covered by this warranty, (E) used in any conjunction with equipment or parts or as part of any system not manufactured by Uniden, or (F) installed or programmed by anyone other than as detailed by the owner's manual for this product.

STATEMENT OF REMEDY: In the event that the product does not conform to this warranty at any time while this warranty is in effect, warrantor will either, at its option, repair or replace the defective unit and return it to you without charge for parts, service, or any other cost (except shipping and handling) incurred by warrantor or its representatives in connection with the performance of this warranty. Warrantor, at its option, may replace the unit with a new or refurbished unit. THE LIMITED WARRANTY SET FORTH ABOVE IS THE SOLE AND ENTIRE WARRANTY PERTAINING TO THE PRODUCT AND IS IN LIEU OF AND EXCLUDES ALL OTHER WARRANTIES OF ANY NATURE WHATSOEVER, WHETHER EXPRESS, IMPLIED OR ARISING BY OPERATION OF LAW, INCLUDING, BUT NOT LIMITED TO ANY IMPLIED WARRANTIES OF MERCHANTABILITY OR FITNESS FOR A PARTICULAR PURPOSE. THIS WARRANTY DOES NOT COVER OR PROVIDE FOR THE REIMBURSEMENT OR PAYMENT OF INCIDENTAL OR CONSEQUENTIAL DAMAGES. Some states do not allow this exclusion or limitation of incidental or consequential damages so the above limitation or exclusion may not apply to you.

LEGAL REMEDIES: This warranty gives you specific legal rights, and you may also have other rights which vary from state to state. This warranty is void outside the United States of America.

PROCEDURE FOR OBTAINING PERFORMANCE OF WARRANTY: If, after following the instructions in the owner's manual you are certain that the Product is defective, pack the Product carefully (preferably in its original packaging). The Product should include all parts and accessories originally packaged with the Product. Include evidence of original purchase and a note describing the defect that has caused you to return it. The Product should be shipped freight prepaid, by traceable means, to warrantor at:

Uniden America Corporation

Parts and Service Division
4700 Amon Carter Blvd.
Fort Worth, TX 76155

(800) 297-1023, 8 a.m. to 5 p.m. Central, Monday through Friday

I.C. Notice

Notice: The Industry Canada label identifies certified equipment. This certification means that the equipment meets certain telecommunications network protective, operational and safety requirements as prescribed in the appropriate Terminal Equipment Technical Requirements document(s). The Department does not guarantee the equipment will operate to the user's satisfaction.

Before installing this equipment, users should ensure that it is permissible to be connected to the facilities of the local telecommunications company. The equipment must also be installed using an acceptable method of connection. The customer should be aware that compliance with the above conditions may not prevent degradation of service in some situations.

Repairs to certified equipment should be coordinated by a representative designated by the supplier. Any repairs or alterations made by the users of this equipment, or equipment malfunctions, may give the telecommunications company cause to request the user to disconnect the equipment.

Users should ensure for their own protection that the electrical ground connections of the power utility, telephone lines and internal metallic water pipe system, if present, are connected together. This precaution may be particularly important in rural areas.

Caution: Users should not attempt to make such connections themselves, but should contact the appropriate electric inspection authority, or electrician, as appropriate."

Notice: The **Ringer Equivalence Number** (REN) assigned to each terminal device provides an indication of the maximum number of terminals allowed to be connected to a telephone interface. The termination on an interface may consist of any combination of devices subject only to the requirement that the sum of the Ringer Equivalence Numbers of all the devices does not exceed 5.