

Big Bite

60-4292

OWNER'S MANUAL — Please read before using this equipment.

CONTENTS

The FCC Wants You to Know	1
Installing Batteries	2
In the Transmitter	2
In the Big Bite	2
Driving the Big Bite	3
Care	4

Your RadioShack Big Bite uses its huge claw and winch to pick up objects or pull itself along. It can easily handle rough terrain and climb up to 25 degrees! Built to 1/16 scale, your Big Bite can reach speeds of up to 600 feet per minute. Your Big Bite comes in two frequencies (27 MHz and 49 MHz), so you can race with your friends. Check the box to see which frequency you have. ⚡

IMPORTANT!

If a warning icon appears at the end of a paragraph, go to the box on this page with the icon corresponding to the pertinent information.

⚠ — Warning	! — Important
⚡ — Caution	💡 — Hint
📌 — Note	

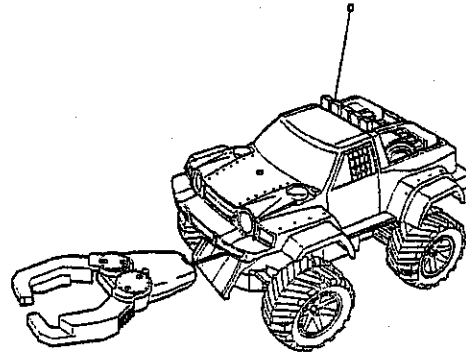

THE FCC WANTS YOU TO KNOW

Your Big Bite or transmitter might cause TV or radio interference even when they are operating properly. To determine whether your Big Bite and transmitter are causing the interference, turn them off. If the interference goes away, your Big Bite or transmitter are causing it. Try to eliminate the interference by:

- moving your Big Bite and transmitter away from the TV or radio
- contacting your local RadioShack store for help.

If you cannot eliminate the interference, the FCC requires that you stop using your Big Bite and transmitter.

Changes of modifications to this product not expressly approved by RadioShack, or operation of this product in any way other than as detailed by the Owner's Manual, could void your authority to operate the product.

💡 HINTS 💡

- Running your vehicle continuously for long period generates high heat levels. Heat causes wear and tear on the motor. To help keep heat levels down, let the vehicle cool at least 10 minutes before installing new batteries.
- If someone uses a CB nearby, it might interfere with control of the vehicle. If this happens, move the vehicle away from the CB.
- You cannot operate your vehicle near devices with transmitters that use the same frequency as your vehicle (27 MHz/49 MHz).
(continued)



RadioShack

www.radioshack.com™

© 2002 RadioShack Corporation.
All Rights Reserved.
RadioShack and RadioShack.com are trademarks
used by RadioShack Corporation.

HINT

(continued)

- Be sure the vehicle is not out of the transmitter's range. The range depends on the transmitter's surroundings and battery strength. Obstructions between the transmitter and the vehicle, such as buildings, fences, and so on, reduce the range.
- The Big Bite has a special circuit to prolong battery life. If you keep any control in one position continuously for 40 seconds, the transmitter automatically shuts off. Move any control lever to another position to continue driving.
- If the vehicle moves slowly and the batteries are new, check the wheel mechanisms for lint, thread, hair, or dust.

WARNING

- Dispose of batteries promptly and properly. Do not burn or bury them.
- If you use alkaline batteries, they will get very hot. To avoid being burned, wait a few minutes after you stop using the vehicle to remove the batteries.

CAUTION

Use only a fresh battery of the required size and recommended type. If you do not plan to use the Big Bite for a week or more, remove the battery from the transmitter and the batteries from the vehicle. Batteries can leak chemicals that can damage electronic parts. Never leave dead or weak batteries in the transmitter or the Big Bite.

INSTALLING BATTERIES

IN THE TRANSMITTER

You need one 9-volt battery to power the transmitter. For the best performance and longest life, we recommend a RadioShack alkaline battery.

1. Slide the transmitter's OFF/ON to OFF.
2. Slide the battery compartment cover in the direction of the arrow to lift it off.
3. Put the battery in the compartment as indicated by the polarity symbols (+ and -) marked inside.
4. Replace the cover and snap it shut.

When the transmitter's range decreases, replace its battery. 

IN THE BIG BITE

Your vehicle uses a 9.6V rechargeable battery pack or 6 AA alkaline batteries (neither supplied) for power. Charge the battery pack with a battery charger before using it. You can install and use alkaline batteries while the battery pack is charging.

1. Slide the vehicle's OFF/ON switch to OFF.
2. Rotate the latch on the battery compartment cover on the bottom of the vehicle clockwise to release it.
3. Press the tab on the cover and slide it in the direction of the arrow marked on it. Then open the cover.
4. If you are using alkaline batteries, insert 6 AA batteries into the battery box according to the polarity symbols (+ and -) marked inside. Place the

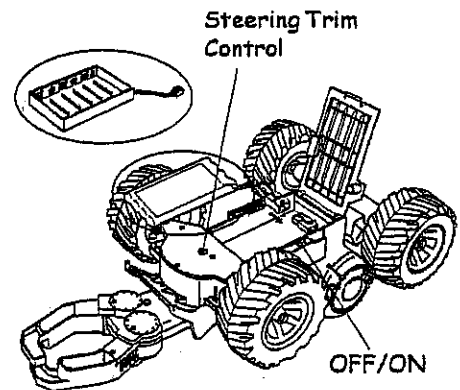

battery pack or battery box in the compartment with the wires on the connector side. Attach the battery pack or battery box's connector to the vehicle's matching connector. Do not force them together. They only fit one way.

5. Replace the cover and turn the latch counterclockwise to secure it. When the vehicle's turns get wider, change the batteries. ☒! ⚠.

DRIVING THE BIG BITE

1. Thread the antenna tightly into the transmitter's antenna connector.
2. Extend the transmitter's antenna. Hold the transmitter with the antenna up, as high as possible.
3. Slide the transmitter's and vehicle's OFF/ON switches to ON.

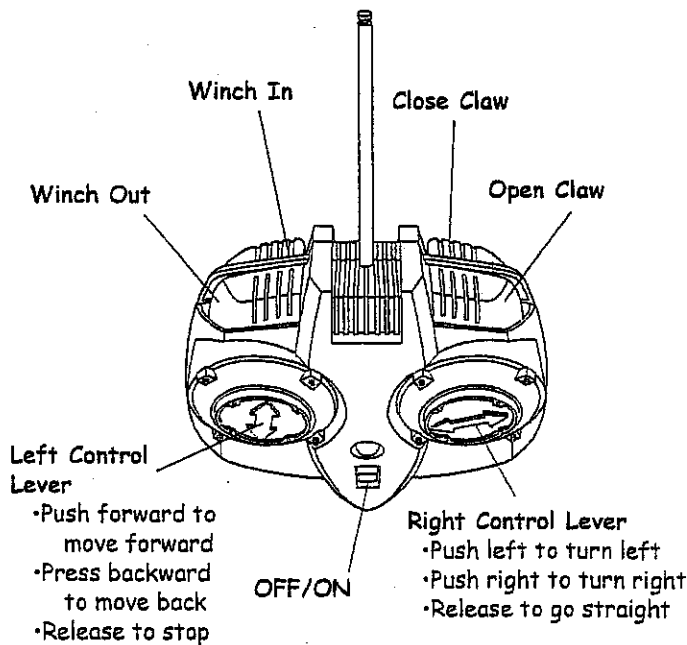

4. Slide H/L on the back of the vehicle to H to drive on a smooth surface, or to L for rough surfaces or climbing slopes.

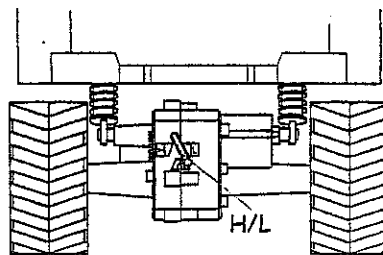

NOTE

Using alkaline batteries slightly decreases your vehicle's speed.

IMPORTANT

The EPA certified RBC® Battery Recycling Section (nickel-cadmium (Ni-Cd) battery) indicates RadioShack's voluntarily participating in an industry program to collect and recycle these batteries at the end of their useful life when taken out of service in the United States or Canada. The RBC program provides a convenient alternative to placing used Ni-Cd batteries into the trash or the municipal waste stream, which may be illegal in your area. Please call 1-800-THE-SHACK (1-800-843-7422) for information on Ni-Cd battery recycling and disposal bans/restrictions in your area. RadioShack's involvement in this program is part of the company's commitment to preserving our environment and conserving our natural resources.





WARNING

- Your Big Bite can reach higher speeds than most other radio controlled vehicles. Avoid collisions with people and objects. Always watch where the vehicle is going.
- Never play with your Big Bite in the street.
- Do not drive the vehicle in puddles, on a wet floor, on sand, or in mud, rain, or snow. These can damage it.

NOTE

- The wire requires some tension to extend or retract smoothly. If you try to extend or retract the wire with little or no tension, it might become tangled inside the housing. If this happens, gently grasp the claw and pull the wire taut (do not force it), then press the left rear button so the wire smoothly retracts.
- If your Big Bite does not drive in a straight line when you release the right control lever, adjust the wheel alignment control on the bottom of the vehicle. Rotate the control toward L if the Big Bite is pulling to the right, or toward R if the Big Bite is pulling to the left.

5. Use the transmitter's control levers to drive and steer the Big Bite.
6. Press the left front button to extend the winch wire.   
7. Press the right front button to open the claw. Grasp the desired object, then press the right rear button to close the claw.
8. Press the left rear button to retract the winch wire.

When you finish driving the Big Bite, slide OFF/ON on the vehicle and transmitter to OFF.

CARE

Keep the Big Bite dry; if it gets wet, wipe it dry immediately. Use and store the Big Bite only in normal temperature environments. Handle the Big Bite carefully; do not drop it. Keep the Big Bite away from dust and dirt, and wipe it with a damp cloth occasionally to keep it looking new.

WARNING

- Do not grab heavy, fragile, or slippery objects, open cans, or liquid-filled containers.
- Do not grab any person or animal. You might hurt them.
- Do not submerge the claw in water or use it to pick up an object that has fallen into water.

CAUTION

- Do not pull the wire out by hand or hang the Big Bite by its wire.
- Do not try to open or close the claw by hand.
- Do not run the Big Bite with the claw trailing. Run it only after the winch wire is fully retracted.

Limited Ninety-Day Warranty

This product is warranted by RadioShack against manufacturing defects in material and workmanship under normal use for ninety (90) days from the date of purchase from RadioShack company-owned stores and authorized RadioShack franchisees and dealers. EXCEPT AS PROVIDED HEREIN, RadioShack MAKES NO EXPRESS WARRANTIES AND ANY IMPLIED WARRANTIES, INCLUDING THOSE OF MERCHANTABILITY AND FITNESS FOR A PARTICULAR PURPOSE, ARE LIMITED IN DURATION TO THE DURATION OF THE WRITTEN LIMITED WARRANTIES CONTAINED HEREIN. EXCEPT AS PROVIDED HEREIN, RadioShack SHALL HAVE NO LIABILITY OR RESPONSIBILITY TO CUSTOMER OR ANY OTHER PERSON OR ENTITY WITH RESPECT TO ANY LIABILITY, LOSS OR DAMAGE CAUSED DIRECTLY OR INDIRECTLY BY USE OR PERFORMANCE OF THE PRODUCT OR ARISING OUT OF ANY BREACH OF THIS WARRANTY, INCLUDING, BUT NOT LIMITED TO, ANY DAMAGES RESULTING FROM INCONVENIENCE, LOSS OF TIME, DATA, PROPERTY, REVENUE, OR PROFIT OR ANY INDIRECT, SPECIAL, INCIDENTAL, OR CONSEQUENTIAL DAMAGES, EVEN IF RadioShack HAS BEEN ADVISED OF THE POSSIBILITY OF SUCH DAMAGES.

Some states do not allow limitations on how long an implied warranty lasts or the exclusion or limitation of incidental or consequential damages, so the above limitations or exclusions may not apply to you.

In the event of a product defect during the warranty period, take the product and the RadioShack sales receipt as proof of purchase date to any RadioShack store. RadioShack will, at its option, unless otherwise provided by law: (a) correct the defect by product repair without charge for parts and labor; (b) replace the product with one of the same or similar design; or (c) refund the purchase price. All replaced parts and products, and products on which a refund is made, become the property of RadioShack. New or reconditioned parts and products may be used in the performance of warranty service. Repaired or replaced parts and products are warranted for the remainder of the original warranty period. You will be charged for repair or replacement of the product made after the expiration of the warranty period.

This warranty does not cover: (a) damage or failure caused by or attributable to acts of God, abuse, accident, misuse, improper or abnormal usage, failure to follow instructions, improper installation or maintenance, alteration, lightning or other incidence of excess voltage or current; (b) any repairs other than those provided by a RadioShack Authorized Service Facility; (c) consumables such as fuses or batteries; (d) cosmetic damage; (e) transportation, shipping or insurance costs; or (f) costs of product removal, installation, set-up service adjustment or reinstallation.

This warranty gives you specific legal rights, and you may also have other rights which vary from state to state.

RadioShack Customer Relations, 200 Taylor Street, 6th Floor, Fort Worth, TX 76102

12/99

RadioShack Corporation
Fort Worth, Texas 76102

60-4292
INS-2304-BU
04A02
Printed in China