

SMART DOG™

A New Breed of Behavior Solutions™



Easy to Install
Easy to Use



INNOTEK™

PET CONTAINMENT SYSTEM with Bark Control



OWNER'S GUIDE
For Smart Dog Model CB-100W

Rev. 03/00 P/N: 2100151

This product is not a substitute for traditional obedience training in situations where attractive nuisance or canine personality would reasonably require such training.

Some states do not allow the exclusion or limitation of incidental or consequential damages, so the above limitation or exclusion may not apply to you.

If services are required, contact the Innotek Call Center to get your Return Materials Authorization Number (RMA) and return instructions. Send the defective part or the complete system by insured U.S. Mail or UPS to the address below: Include a check or money order for \$15 to cover processing and handling.

FCC NOTICE

This device has been tested and found to comply with the limits for a Class B digital device, pursuant to Part 15 of the FCC Rules. These limits are designed to provide reasonable protection against harmful interference in a residential installation. This device generates, uses, and can radiate radio frequency energy and, if installed and used in accordance with the instruction, may cause harmful interference to radio communications. However, there is no guarantee that interference will not occur in a particular installation. If this device does cause harmful interference to radio or television reception, the user is encouraged to try to correct the interference by one or more of the following measures:

- Reorient or relocate the receiving antenna.
- Increase the separation between the computer and receiver.
- Connect the computer into an outlet on a circuit different from that to which the receiver is connected.
- Consult the dealer or an experienced radio/TV technician for help.

Caution: Any changes or modifications not expressly approved by the grantee of this device could void the user's authority to operate the equipment.

INNOTEK™
PET PRODUCTS DIVISION
Innotek Inc. One Innoway, Garrett, IN 46738

To close off one section of a yard

To keep dog away from a specific area

Fenced yard with opening for driveway

TRAINING INFORMATION
Innotek is proud to be the exclusive electronic training products sponsor of Triple Crown All Breed Dog Academy of greater Austin, TX. For more information on Triple Crown, visit their web site at www.triplecrowndogs.com



LIMITED WARRANTY

Innotek warrants that this product will be free from defects in material and workmanship under normal use for one year from the date of original consumer purchase.

Within 30 days of the original consumer purchase, this product is covered by Innotek's 30-day money-back guarantee. If you are not satisfied with the performance of this product, you may return it with the original receipt to the place of purchase for a full refund.

After 30 days and during the one-year limited warranty period we will, at our option, repair or replace defective part(s) for a \$15 processing fee. Shipping costs to our facility are not covered by this limited warranty.

This limited warranty is offered only to the original consumer purchaser. This limited warranty is subject to the condition that any covered defect occurs under normal conditions of use and maintenance and that Innotek receives prompt written notice of the discovery of the defect within the limited warranty period. It does not apply to damage or failures that result from physical abuse or misuse of the product. The limited warranty is void if any attempts are made to alter or repair this product prior to returning it to our facility within the limited warranty period. This limited warranty does not cover lost parts or broken probe studs.

EXCEPT AS SPECIFICALLY SET FORTH HEREIN, THERE ARE NO WARRANTIES, REPRESENTATIONS, PROMISES OR ASSURANCES BY INNOTEK, EITHER EXPRESSED OR IMPLIED, WHETHER BY LAW, CUSTOM, PREVIOUS TRANSACTION OR OTHERWISE, INCLUDING WITHOUT LIMITATION, WARRANTIES OF MERCHANTABILITY OR FITNESS FOR A PARTICULAR PURPOSE WITH REGARD TO THE PRODUCT. INNOTEK'S LIABILITY IS SOLELY AS STATED HEREIN AND NO OTHER LIABILITY SHALL EXIST, WHETHER BY NEGLIGENCE, STRICT LIABILITY, TORT OR ANY OTHER CAUSE OR ACTION. ALL LIABILITIES FOR INNOTEK STATED HEREIN ARE THE SOLE AND EXCLUSIVE REMEDIES OF THE ORIGINAL CONSUMER PURCHASER. IN NO EVENT SHALL INNOTEK BE LIABLE FOR ANY CONSEQUENTIAL OR INCIDENTAL DAMAGES, OR ANY OTHER TYPE OF DAMAGE WHICH MAY BE CAUSED IN WHOLE OR IN PART BY ANY FAILURE, DEFECT OR PROBLEM OF THE PRODUCT.

have five seconds to change the sensitivity level.
2. To change, hold the magnet against the red paper dot. The light will flash green 1-4 times.
3. Remove the magnet after the number of flashes that matches the sensitivity you want.
4. After about five seconds, the unit will flash back 1-4 times to confirm the sensitivity level.
IMPORTANT: When using the No-Bark collar on a dog for the first time, start at Stimulation Level 1 and Sensitivity Level 2. Increase the stimulation by one level each day until you reach a satisfactory response from your dog. If your dog does not appear to be reacting to the stimulus, experiment with different combinations of stimulation levels and sensitivity levels.

PART IV. TROUBLESHOOTING AND MAINTENANCE

A. If the collar appears to not be working:
- Adjust the collar fit.
- Trim hair or use longer probes
- Recharge the battery
- Adjust stimulation and/or sensitivity level

B. Maintenance
The CB-100W system requires very little maintenance. The receiver is waterproof and can be immersed in water. To remove dirt, simply wipe with soap and water. Never place the collar in a dishwasher.

The transmitter is not waterproof and needs to be protected from the weather. (See Part I., Section 1A for more transmitter information.)

STOP
IF YOU HAVE QUESTIONS ABOUT THE OPERATION OR USE OF YOUR NEW INNOTEK SYSTEM, DO NOT RETURN IT TO YOUR RETAILER. WE CAN HELP. CONTACT THE INNOTEK CALL CENTER AT 1-800-826-5527. HOURS: 8 a.m. to 5 p.m., EST, Monday-Friday.

WEB SITE INFORMATION
Your complete satisfaction is our goal. If you have questions not answered here, please visit us at :
www.pet-products.com
You can also e-mail us at :
info@pet-products.com

OPERATING MODE NOTES
- If you are unable to produce a flashing light on the receiver, the receiver most likely needs charging. See Part I., Section 2A.
- You can expect 30-90 days on a charge. Charge life is affected by how much time the collar is on, how often the dog tests the containment boundary and how often the dog barks.

PART III. BARK-CONTROL OPERATION SECTION 1: SETTING THE STIMULATION LEVEL AND SENSITIVITY

A. Setting the Stimulation Level - The bark-control feature provides a programmable stimulation option that allows you to choose one of seven levels. Level 1 is lowest; Level 7 is highest. After charging, you will need to pick one of the seven levels. To set a level, first be sure the receiver is flashing green or yellow. Then:

1. Slowly pass the magnet by the red paper dot on the side of the receiver.
2. When the receiver light turns solid red, *pull the magnet far away from the receiver.*
3. The light will stay on for approximately 1 second and will then flash from 1 to 7 times, identifying the level at which the unit was last set (i.e. one flash for Level 1, two flashes for Level 2, etc.) *Do not attempt further steps until the light is done flashing.*
4. When the light is done flashing, you have five seconds to start changing the receiver to a new level.
5. To change the level, hold the magnet against the red paper dot. The light will start flashing up to 7 times.
6. Pull the magnet away after the number of flashes that matches the stimulation level you want.
7. After about five seconds, the unit will flash back 1 to 7 times to confirm the level you set.

B. Setting the Sensitivity - Immediately after setting the stimulation level, you will need to set one of four sensitivity levels. Level 1 is the most sensitive and Level 4 is the least sensitive. (We recommend first setting the sensitivity at Level 2.) To set the sensitivity:
1. After Step 7 above, the light will turn green, go out, then flash back the previous setting. You

IMPORTANT! DO NOT BURY THE WIRE UNTIL YOU HAVE TESTED THE SYSTEM AND ARE SURE IT IS WORKING PROPERLY!

Use gradual turns at the corners. This will produce a more consistent signal field and avoid confusing the dog in these areas.

IMPORTANT!
Do not run the loop within six feet parallel to electrical, telephone, cable TV or any other buried wire you may have in your yard.
Do not run one section of wire within 10 feet of an other section or the signal may cancel.
Do not run your wire within 10 feet of a neighboring containment system's boundary wire.

Driveways/Sidewalks - When crossing an asphalt driveway, make a 1/2" deep cut across the driveway using a circular saw and masonry blade. Place the wire in the crack and seal with asphalt sealant. **On driveways and sidewalks,** if an expansion joint is available, simply place the wire in the joint and seal with an outdoor caulk. **When crossing gravel,** bury the wire at least 3" deep. Use an old garden hose or plastic PVC piping to protect the wire. **In water,** anchor the wire with large rocks. Protect the wire with an old garden hose or plastic PVC piping.

Connecting the Loop to the Transmitter
1. Splice the two ends of the twisted wire to each of the two ends of the loop wire.
2. Drill a hole through the exterior wall or window/door sill, or run the wire through an existing utility line hole.
3. Connect the twisted wires to the transmitter, either wire to either terminal. (Wire ends must be stripped.)
4. A red indicator light should appear, indicating a continuous wire loop. If no light appears, refer to Section 1, Part C.

SECTION 6: THE SIGNAL FIELD
The width of the signal field is adjusted using the transmitter's Field Width Adjustment Knob. Increasing or decreasing the signal field width does not affect the correction intensity.

To test the signal field, hook up the test light and slowly walk the collar receiver toward the boundary wire, listening for the warning tone and watching for the test light to light up. The wider the signal

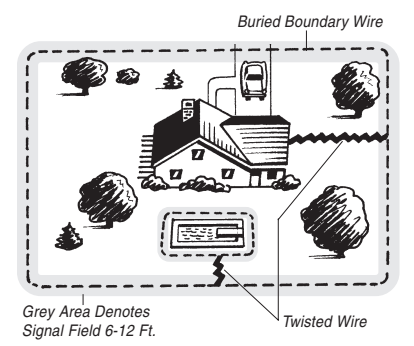

field, the less chance there is that a dog can run through the field.

The signal field should extend a minimum of 3 ft. on either side of the wire (creating a 6 ft. wide field). An 8-12 ft. wide field is preferred. This ensures that the dog is properly contained and makes the Run-Through Preventer more effective.

PART II. OPERATING MODES SECTION 1: SELECTING AND CHANGING MODES

By combining containment and bark-control features into one system, the CB-100W provides you with a choice of three operating modes: 1) Bark-Control Only 2) Containment Only and 3) Bark Control and Containment Dual Mode. Each mode is indicated by the light on the collar receiver as follows:
Bark-Control Only - Flashing GREEN light.
Containment Only - Flashing RED light.
Dual Mode - Flashing YELLOW light.
OFF - No light
Note: When the receiver is removed from the wall-mount transmitter/charging unit, its indicator light will be flashing yellow, indicating the unit is in combination containment and bark-control mode.

To change the mode, simply pass the keychain magnet past the blue paper dot on the receiver. This activates the receiver's internal magnetic switch. The first time you do this, the receiver will turn OFF, indicated by no receiver light. Each time you pass the magnet past the blue dot, the receiver's indicator light will change to indicate the current operating mode.

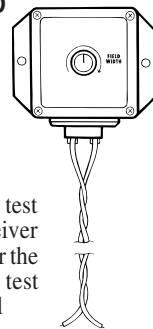



PET CONTAINMENT SYSTEM with Bark Control



Innotek's Pet Containment System provides security for your dog and peace of mind for you. Its humane stimulation is proven safe and effective for training dogs to stay within the boundaries you set. This system, Model CB-100W, features Innotek's micro-size collar receiver - our smallest ever - along with bark-control functions. This unique, dual-purpose system is ideal for dog owners who need a solution to two common problems at once. Although you are eager to get your system installed and begin training your dog, please take the time to review the Installation and Training Video, Training/Troubleshooting Guide and this manual so your installation and training can proceed efficiently and successfully.

COMPONENTS

A. Wall-Mount Transmitter - Used to turn the containment system on and off, control the field width and select the stimulation level. The transmitter is also used to recharge the collar receiver.

B. AC Adapter - Power source for the transmitter.

C. Collar/Receiver - Consists of a rechargeable receiver attached to a nylon collar strap.

D. Collar Receiver Probes (2 sets) - Use the long probes for dogs with long hair and the short probes for dogs with short hair. Special probes are available for dogs with extra-thick coats. (Contact the Innotek Call Center to order.)

E. Probe Wrench - (not shown) Used to tighten probes. When changing probes, finger tighten, then turn one additional revolution with the wrench. **Do not over-tighten.**

F. Training/Troubleshooting Guide - (not shown) A helpful guide to help you train your dog to respect the boundary area.

G. Installation and Training Video - A step-by-step guide to installing your system and training your dog.

H. Mounting Hardware - (not shown) Used to attach the transmitter to the wall.

I. Test Light - Lets you check to make sure the collar receiver is operating properly. When the leads are attached to the collar probes and the collar is held in the signal field, the test light should light up.

J. Boundary Wire - Used to create the containment system boundary. Wire is available in 500 foot spools. If more than 500 feet is needed, simply purchase an additional boundary kit(s). Boundary kits include wire, boundary flags and wire splices. Note: A chart at the end of this manual provides approximate linear footages to cover different areas and the boundary kit model needed for your system.

K. Boundary Flags - Helpful for teaching your dog the boundaries of the containment system.

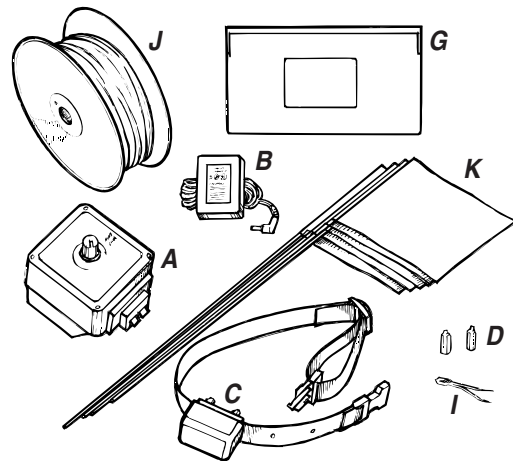

L. Wire Splices -(not shown) Used for joining wire ends.

M. Keychain Magnet - (not shown) Used to turn collar on and off and change operating modes. (Any magnet will perform this function.)

BEFORE YOUR BEGIN

Realize that because individual dogs have unique temperaments, there is no way of knowing how your dog will react to its introduction to the training collar. For the safety of your dog, initial training should take place using a long lead to keep you in complete control over the situation. Also realize that an aggressive animal could turn against the handler upon receiving the stimulus. Therefore, if you feel your dog has an aggressive behavior and/or it has a history of such behavior, we suggest you consult a certified animal behaviorist before using this product as a training aid.

PART I. CONTAINMENT SYSTEM OPERATION

SECTION 1: THE WALL-MOUNT TRANSMITTER

The transmitter can be mounted to any wall near a standard 110-volt household outlet with the included screws. The transmitter will withstand freezing temperatures, but it is not waterproof. Therefore you may locate it in a garage but not outdoors.

To power the transmitter, plug the AC adapter into a standard 110-volt household outlet and connect it to the transmitter's power port.

Transmitter features include:

A. Lightning/Surge Protection - This helps prevent the transmitter from damage if a power surge occurs or if lightning hits the ground in your area. A close lightning strike may damage the unit. Therefore we recommend that you unplug the transmitter and disconnect the wires during storms. Lightning strikes are not covered under the Limited Warranty. However, an Extended Warranty is available that covers such damage. Contact Innotek for more information.

B. Wire Connectors - Easy-to-use, push-release wire connectors let you instantly connect or disconnect the boundary wire leads. Wires should be stripped about an inch before connecting.

C. Indicator Light - Tells you the following information.

a. Containment Mode - A continuous red light tells you the transmitter is properly connected, both wires are connected and the wire forms an unbroken, continuous loop.

b. System Malfunction - No light tells you one or more of the following: One or both wires are not properly connected, both wires are connected but the wire is broken or nicked at some point, or the transmitter has malfunctioned.

Note: The transmitter light only indicates continuity. If you have a loose splice or nicked wire, the red light or a flickering light may still show, but you may notice reduced or no field width. If this situation or a wire break should occur, follow the instructions in the Training/Troubleshooting Guide.

D. Field Width Adjustment Knob - Controls the width of the signal field (the distance from the boundary wire to the place where the collar receiver is first activated). Turning the knob clockwise increases the field width; turning it counter-clockwise decreases it.

SECTION 2: THE COLLAR RECEIVER

A. CHARGING

1. To charge the collar receiver, place it on top of the transmitter, making sure the transmitter's raised alignment pin fits into the receiver's indicator light depression.

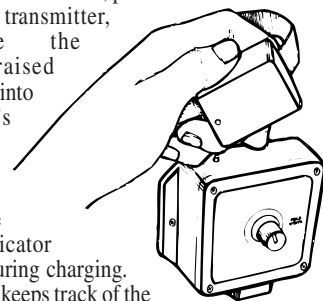

2. When properly aligned, the transmitter's indicator light will blink during charging.

3. The transmitter keeps track of the charging time. At the start of charging, the transmitter will emit a blinking red light for 12 hours.

4. When charging is done, the transmitter light will go out. Remove the collar receiver. The receiver's indicator light will be flashing yellow, indicating that it is in the combination containment and bark control mode. (For more information on operating modes, see Part II.)

NOTE TO MULTIPLE DOG OWNERS:

Because the system is not operational while a collar receiver is being charged using the wall-mount transmitter, you may want to purchase a separate charger from Innotek. You can then charge a collar without disabling the system.

IMPORTANT CHARGING NOTES

a. Charge the receiver 12 hours before first use.

b. Test the system once a week to make sure the receiver is still charged. To test, walk the receiver into the signal field with the test light attached to the probes. Listen for the warning tone and/or watch for the test light to flicker.

c. You can expect 30-90 days on a charge. Charge life is affected by how much time the collar is on, how often the dog tests the containment boundary and how often the dog barks.

d. Every six months the receiver should be allowed to fully discharge, then be fully recharged. To discharge, hook up the test light to the collar receiver probes and place the receiver in the signal field until it is fully drained (indicated by no tone or light).

Note: Always use the test light when draining the collar receiver. Not using the test light can permanently damage the receiver.

SECTION 3: THE CORRECTION

A. Setting the Stimulation (Correction) Level

The transmitter allows three levels of correction: Low, Medium or High. It comes from the factory set at Medium. If you want to change the level:

1. Remove the four cover screws, range control knob and the front cover.

2. The "jumper" near the top-center of the transmitter (directly under the indicator light) can be moved to the right for the Low setting or completely removed for the High setting.

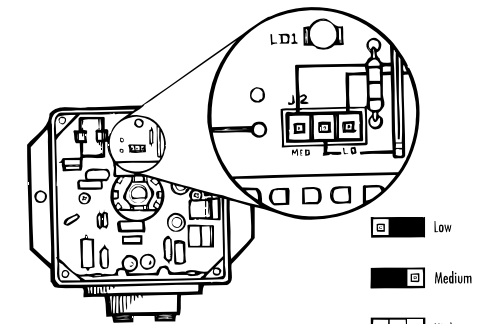

When the dog reaches the edge of the boundary (signal field) in the yard, it will hear a prestimulation warning tone that lasts about two seconds. If the dog does not move back from the boundary, it will receive a continuous correction stimulus (at the Low, Medium or High level) until it re-enters the "safe" part of the yard.

Note: If the transmitter is set on High, there will be no pre-stimulation warning tone prior to the correction.

B. Special features that increase effectiveness

The system is fully operational when the collar receiver has an adequate charge and the boundary wire is producing a signal field. These special features increase the system's effectiveness:

1. Run-Through Preventer - Correction always starts with a warning tone, followed by stimulation. If the dog continues more than one-third of the way through the signal field, the stimulation will automatically rise to the High level. For example, if the signal is emitted 12 feet from the wire and your dog enters the signal field, this feature is activated when the dog is eight feet from the wire. At this point, the dog automatically receives the High level of correction. The correction remains on High until the dog returns to the safe part of the yard.

2. Over-Correction Preventer - In the unlikely event your dog becomes "trapped" in the correction field, this feature limits the length of time it receives the correction to 20 seconds. The system will then shut off for 10 seconds before resuming correction for another 20 seconds. This pattern will alternate until your dog returns to the safe part of the yard or the system is turned off.

SECTION 4: FITTING THE COLLAR TO YOUR DOG

Probes

- Use short probes for short-haired dogs
- Use long probes for long-haired or thick-coated dogs
- Finger-tighten the probes, then turn one additional revolution with the probe wrench. Do not over-tighten.

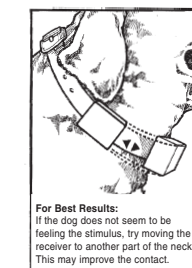
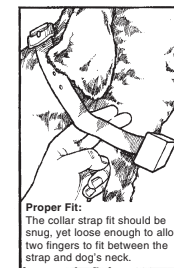

Collar Strap

- Place the collar around the dog's neck, receiver box on the bottom.
- Fit the strap as snugly as possible, without restricting breathing.
- Make sure both probes contact the dog's skin.
- Remove the collar and trim the excess, leaving 4-6 inches.

NOTE:

- **Special probes** are available for thick-haired dogs
- **Dummy collars**, which are non-operational but get the dog used to wearing a training collar, are also available. Contact Innotek to order.

IMPORTANT NOTES ABOUT THE COLLAR AND TRANSMITTER!

1. Always use the rubber insulators between the collar strap and probes to provide insulation in damp conditions.
2. If needed, a small amount of hair removal or thinning will improve probe contact with the skin.
3. Check your dog's neck periodically for skin irritation.

4. Never leave the collar on your dog for more than 12 hours a day or when you are away.

5. The collar is waterproof and will not be damaged if it gets wet. Never place the collar in the dishwasher.

6. Always remove the collar from your dog when it comes indoors. Keep the collar at least five feet away from any electronic equipment to avoid accidental discharging of the battery.

7. Do not attempt to dismantle or repair the transmitter or receiver. They contain computerized circuitry that should be serviced only by an authorized expert.

8. Do not clean the transmitter with any liquid, including water.

EXTRA COLLARS

Any number of collars may be added to your system. See your dealer for a selection of extra collars or contact the Innotek Call Center at 1-800-826-5527.

SECTION 5: INSTALLING THE BOUNDARY WIRE

Before installing the boundary wire, contact your utility companies to mark your utility lines before you start digging. Select the areas of your property within which you want to contain your dog. It may be helpful to make a diagram to help you avoid unforeseen obstacles. (Please note the example diagrams included at the end of this manual.)

Your system includes 500 feet of boundary wire. For yards requiring more wire, boundary kits are available from your dealer or Innotek. Each boundary kit includes 500 ft. of wire, 50 training flags and wire splices. Here are some examples of wire coverage.

Acres	Linear Feet Needed
1	850
2	1200
3	1500
4	1700
5	1900

Above figures assume a rectangular layout. Actual footage may vary. For estimates on yards larger than 5 acres, contact the Innotek Call Center.

Keep in mind that you will want at least a 6-8 ft. signal field (3 ft. on each side of the wire) and the dog will stay back another 2-4 ft. from the edge of the field. Avoid making

passageways too narrow or your dog may be hesitant to use them (i.e. along the sides of a house).

Tools Needed - You may need the following tools for efficient installation: Straight-edged spade, wire cutter/stripper and flathead screwdriver. If you plan to run the wire across concrete you will also need a caulk gun, silicone caulking and a circular saw with a masonry blade.

Placing the Wire

For the system to work properly, the wire must make one continuous loop. The signal is transmitted from one terminal of the transmitter, through the wire, and back to the other terminal.

Running and twisting the wire along itself

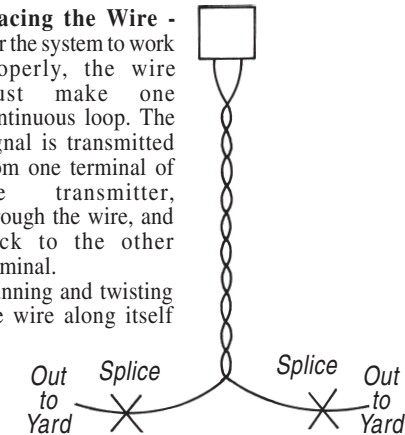

cancels the signal. Use the twisted wire from the transmitter out to the exterior loop wire. This allows the dog to cross that area without receiving a signal. To twist the wire, cut two equal lengths and hold them side by side. Put one end of both wires in a power drill and spin the wires until the twists are 1"-3" apart. The tighter the wire, the better the signal cancellation. You can also twist the wires manually.

You do not have to bury the wire, but for protection you probably want to bury it at least 1/2" underground. Start by digging about 3"-4" deep where the wire first enters the ground near the transmitter and continue around the path of the loop wire. A 30°-45° angle cut make with a flatblade spade will be the easiest to close up and heal.

IMPORTANT NOTE: When covering a large area, you may wish to use a trenching machine to cut into the ground. However, we recommend that the wire be placed in the trench by hand. A commercial wire-placing machine may break the wire.