

DTD :1/2/2018

USER MANUAL FOR
GAMING MOUSE (MODEL: RZ01-0248)
AND
GAMING MOUSE MAT (MODEL: RZ02-0248)

PACKAGE CONTENTS / SYSTEM REQUIREMENTS

PACKAGE CONTENTS

- Gaming Mouse (Model: RZ01-0248)
- Gaming Mouse Mat (Model: RZ02-0248)
- Detachable USB to Micro-USB cable
- Important Product Information Guide

SYSTEM REQUIREMENTS

PRODUCT REQUIREMENTS

- PC with a free USB port

RAZER SYNAPSE 3 REQUIREMENTS

- Windows® 7 (or higher)
- Internet connection
- 500 MB of free hard disk space

DEVICE LAYOUT

RAZER MAMBA HYPERFLUX

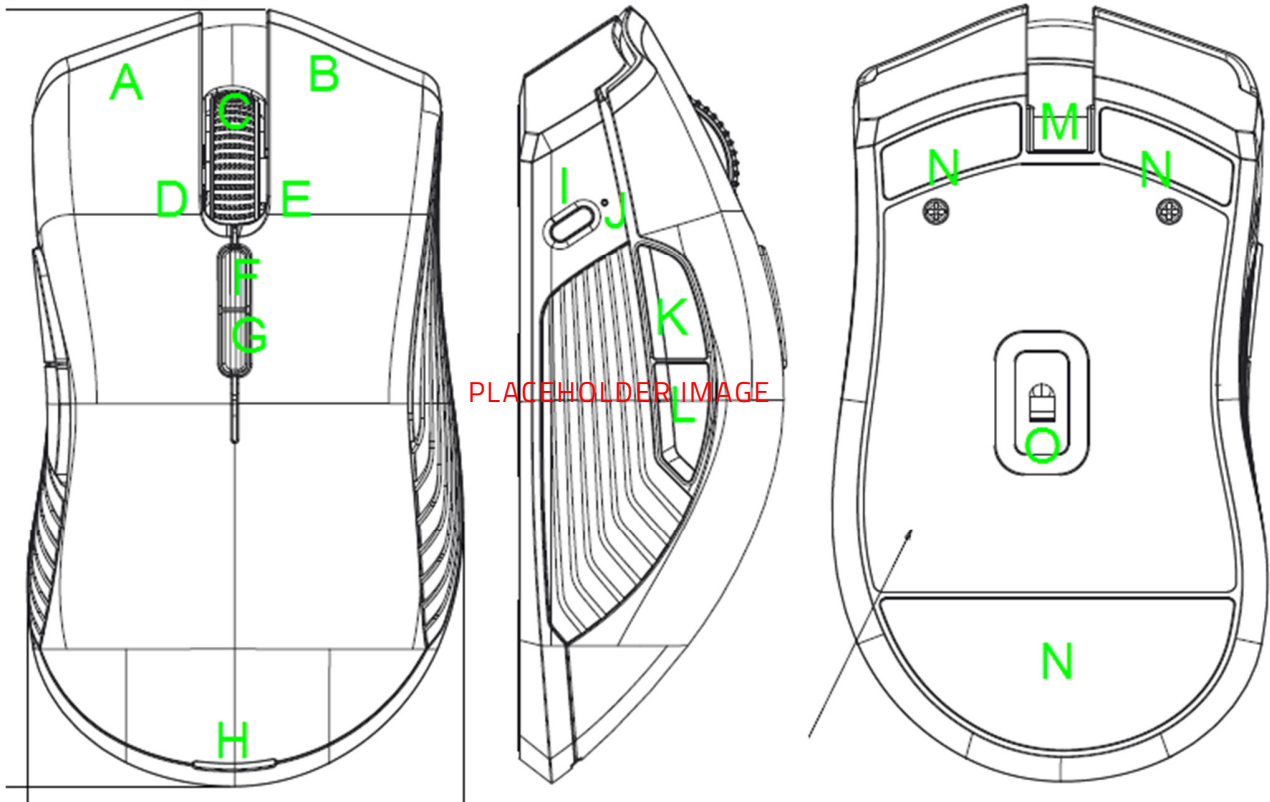

- A. Left mouse button
- B. Right mouse button
- C. Scroll wheel
- D. Left tilt-click —repeat scroll down
- E. Right tilt-click —repeat scroll up
- F. DPI stage up
- G. DPI stage down
- H. Power indicator (mouse)
- I. Profile button
- J. Profile indicator
- K. Mouse button 5
- L. Mouse button 4
- M. Micro-USB port
- N. Ultraslick mouse feet
- O. True 16,000 DPI 5G optical sensor



Default DPI stages are as follows: 800, 1800, 4500, 9000, and 16000. The DPI stages can be customized using Razer Synapse 3.

RAZER FIREFLY HYPERFLUX

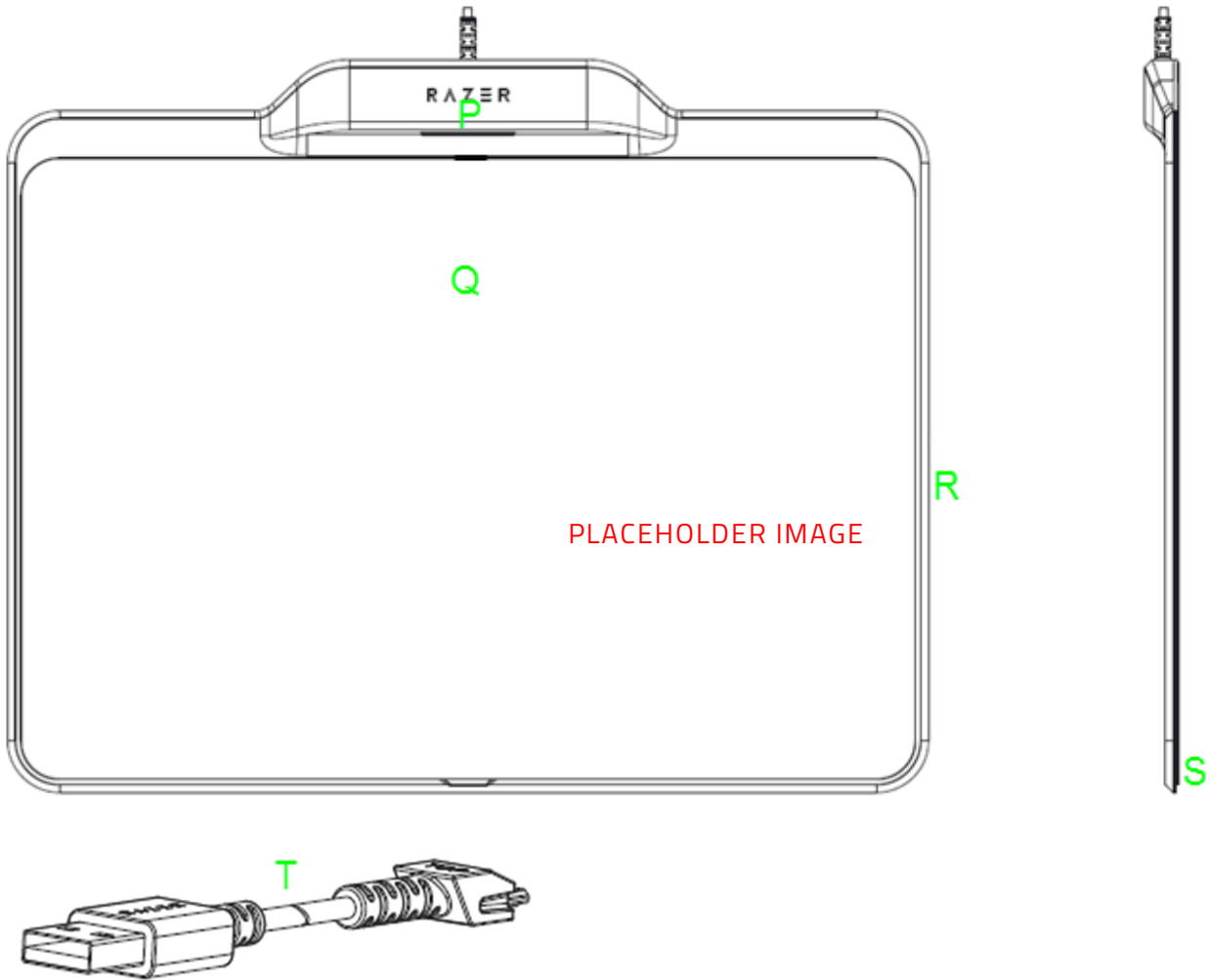

- P. Power indicator (mouse mat)
- Q. Dual-sided hard/cloth mouse mat surface
- R. Customizable Razer Chroma™ lighting
- S. Non-slip rubber base
- T. Detachable USB to Micro-USB cable

USING YOUR RAZER MAMBA HYPERFLUX AND RAZER FIREFLY HYPERFLUX

DUAL-SIDED HARD/CLOTH SURFACE

The Razer Firefly HyperFlux includes a dual-sided hard/cloth surface. To change surfaces:

1. Remove the surface from the base using the pull tab on the bottom-middle of the mat.

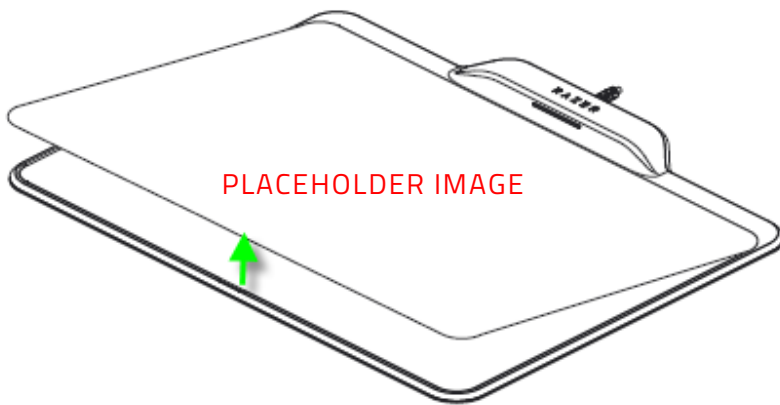

2. Remove the protective film covering the charging plate.

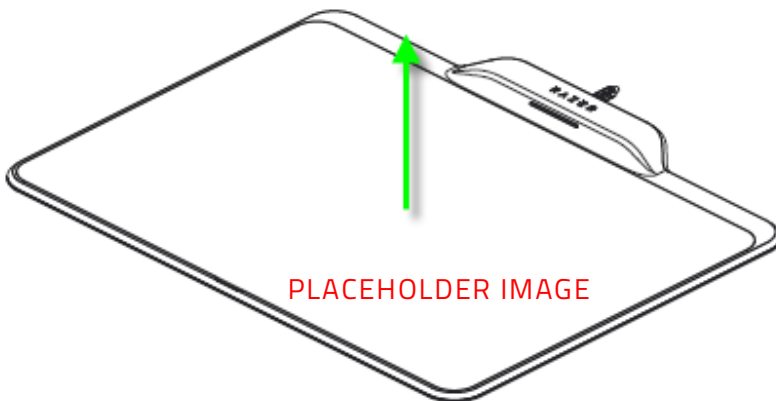

3. Place either the hard or the cloth surface to the base.

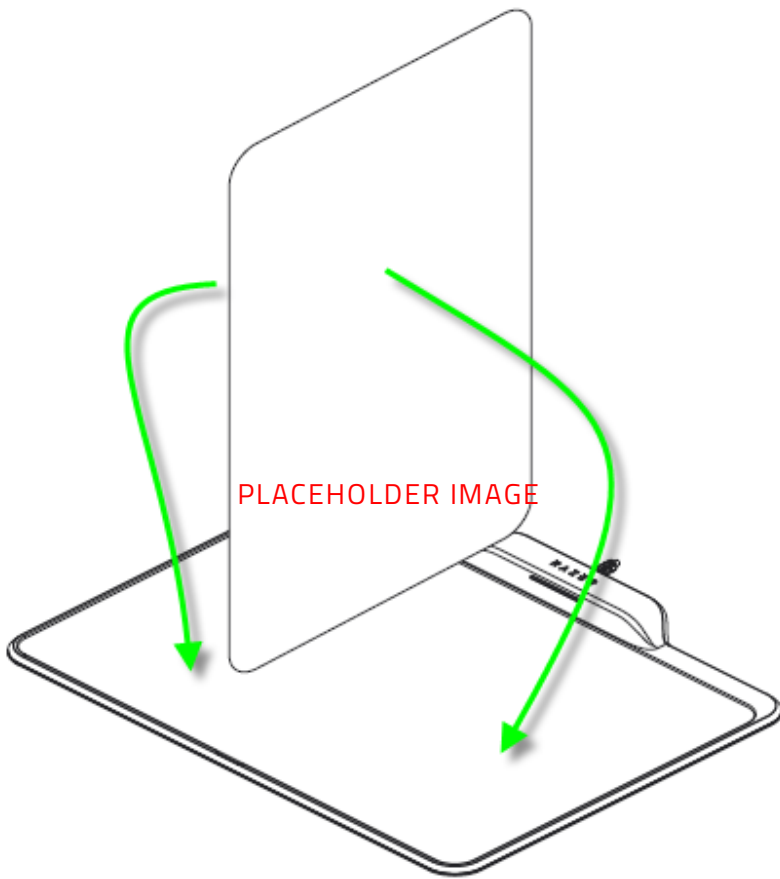

WIRELESS MODE

The Razer Mamba HyperFlux features a battery-free operation that is powered wirelessly via the Razer Firefly HyperFlux. To setup the Razer Mamba HyperFlux in wireless mode:

1. Place the Razer Firefly HyperFlux on a flat, non-metallic surface.

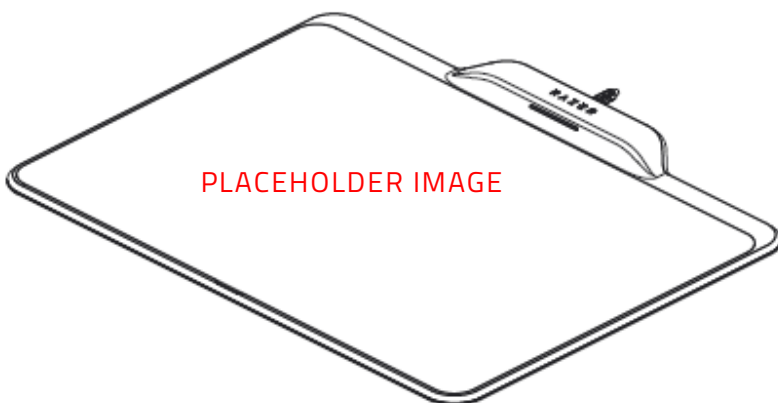

2. Plug the USB to Micro-USB cable from the Razer Firefly HyperFlux to your computer.

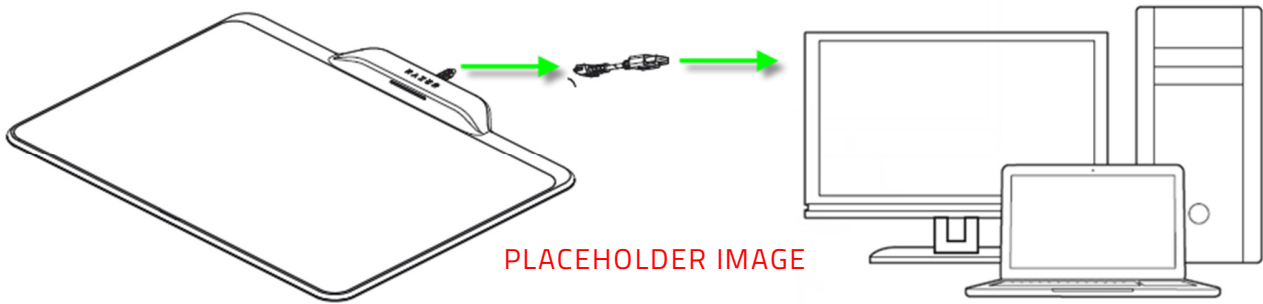

3. Place the Razer Mamba HyperFlux within the dual-sided hard/cloth surface area to ensure that the Razer Mamba HyperFlux will receive adequate power.

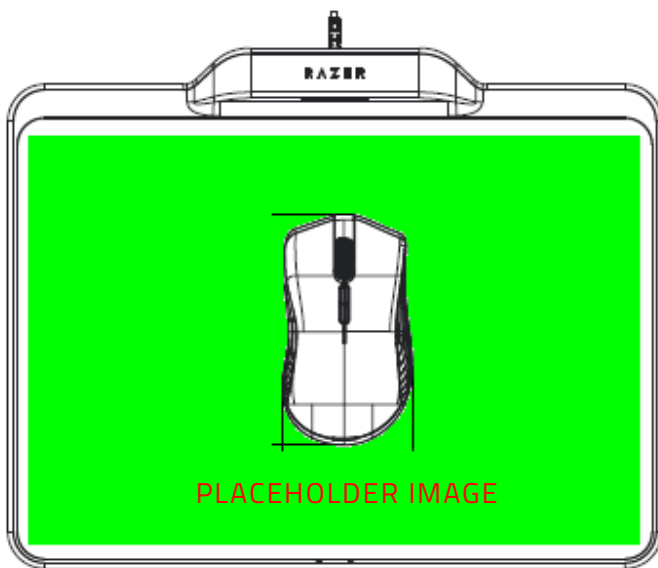

- i** Do not place the Razer Firefly HyperFlux on top of any metallic surface or place a cellphone or other metallic objects on top of the mat as it will affect the power transfer between devices. Do not place the Razer Firefly HyperFlux within 1 meter of a Wi-Fi router. The Razer Firefly HyperFlux requires a USB connection that can supply sufficient power. It is recommended to connect the Razer Firefly HyperFlux directly to the USB port of your computer as the power supply may be affected if connected to a non-powered USB hub or non-powered USB port found on certain peripherals.









WIRED MODE

The Razer Mamba HyperFlux also features a wired mode for use without the Razer Firefly HyperFlux. To setup the Razer Mamba HyperFlux in wired mode, simply plug the provided detachable USB to Micro-USB cable from the Razer Mamba HyperFlux to your computer.



POWER INDICATOR

The Razer Mamba HyperFlux and Razer Firefly HyperFlux includes a power indicator to show its status as listed below:

Status	Power indicator (mouse)	Power indicator (mouse mat)
Razer Mamba HyperFlux is on Wireless Mode	 100% brightness	 100% brightness
Razer Mamba HyperFlux is on Wired Mode	 0% brightness	 0% brightness
Only Razer Firefly HyperFlux is detected	 0% brightness	 50% brightness
Foreign object detected on Razer Firefly HyperFlux	 Blinking red	 Blinking red

INSTALLING RAZER SOFTWARE FOR YOUR RAZER MAMBA HYPERFLUX AND RAZER FIREFLY HYPERFLUX

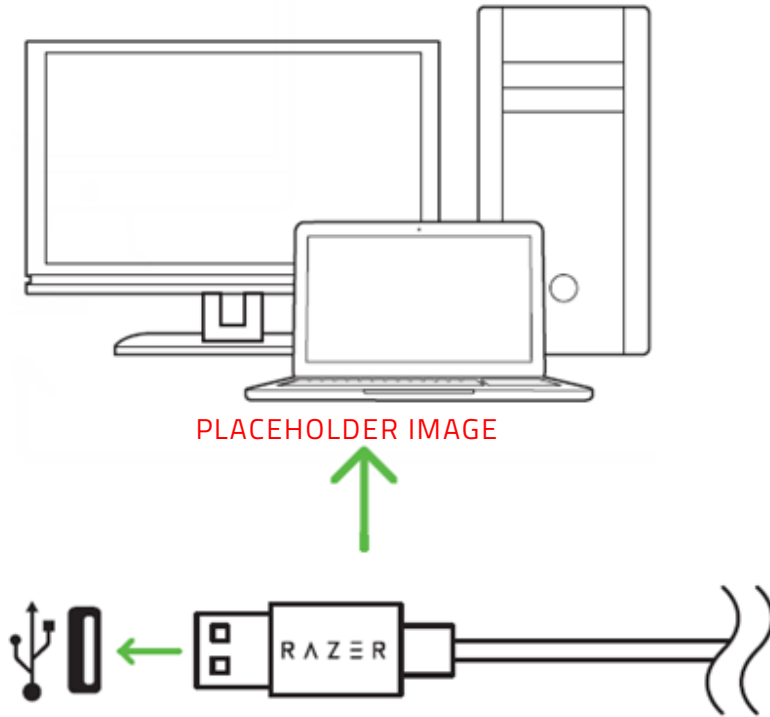

Step 1: Make sure your Razer device to the USB port of your computer.

Step 2: Install the Razer software when prompted* or download the installer from razerzone.com/software.

Step 3: Create your Razer ID or log in using an existing account.

**Applicable for Windows 8 or later.*

CONFIGURING YOUR RAZER MAMBA HYPERFLUX AND RAZER FIREFLY HYPERFLUX VIA RAZER SYNAPSE 3

STORED PROFILES



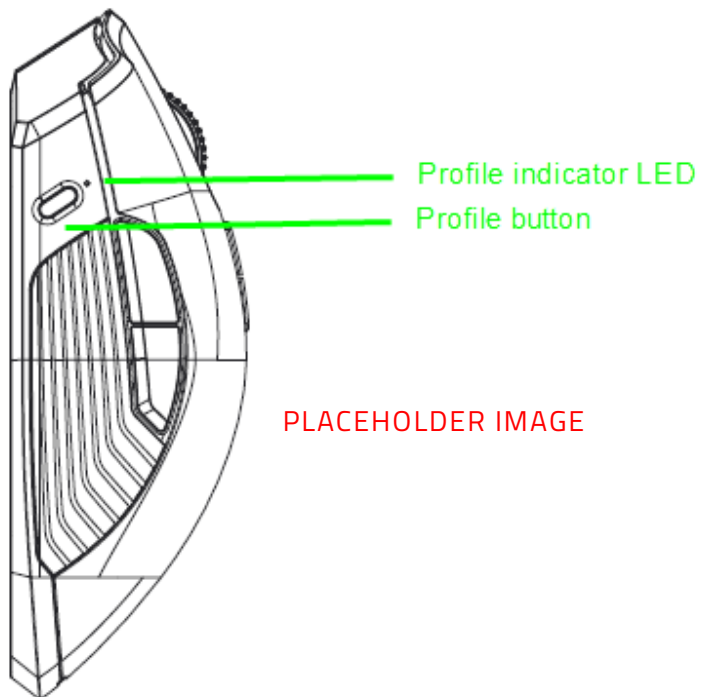

Your Razer Mamba HyperFlux can store up to 5 profiles from Razer Synapse 3, which you can use even on systems that do not have Razer Synapse 3 installed. Pressing the profile button will cycle through the different profiles, with the profile indicator's color showing which profile is currently selected.

	Designated color
Active profile	White
Profile 1	Red
Profile 2	Green
Profile 3	Blue
Profile 4	Cyan



LIGHTING EFFECTS

The Lighting Tab on Razer Synapse 3 gives you the flexibility to customize your Razer device through different quick effects or you can create your own using the Chroma Studio. If you have other supported Razer Chroma-enabled devices, you can synchronize their lighting effects with your Razer Mamba HyperFlux and Razer Firefly HyperFlux.

	Name	Description	How to set up
	Breathing	The lighting fades in and out of the selected color(s)	Select up to 2 colors or randomize
	Reactive	The LEDs will light up when you click any of the mouse buttons	Select the color and the length of time for the LED to remain lit
	Spectrum cycling	The LEDs will cycle between 16.8 million colors indefinitely	No further customization required
	Static	The LEDs will remain lit in the selected color	Select a color
	Wave	The lighting will scroll in the direction selected with a default spectrum of colors	Select either front-to-back or back-to-front wave direction

 *Note: By default, the Razer Mamba HyperFlux and Razer Mamba HyperFlux are set to spectrum cycling. To customize the lighting, please install Razer Synapse 3.*

Please refer to the Online Master Guide at support.razerzone.com for in-depth instructions on how to configure and use your Razer Mamba HyperFlux and Razer Firefly HyperFlux.

REGULATORY & COMPLIANCE INFORMATION

FCC DECLARATION OF CONFORMANCE

This equipment has been tested and found to comply with the limits for a Class B digital device, pursuant to part 15 of the FCC Rules. These limits are designed to provide reasonable protection against harmful interference in a residential installation. This equipment generates, uses and can radiate radio frequency energy and, if not installed and used in accordance with the instructions, may cause harmful interference to radio communications. However, there is no guarantee that interference will not occur in a particular installation. If this equipment does cause harmful interference to radio or television reception, which can be determined by turning the equipment off and on, the user is encouraged to try to correct the interference by one or more of the following measures:

- Reorient or relocate the receiving antenna.
- Increase the separation between the equipment and the receiver.
- Connect the equipment into an outlet on a circuit different from that to which the receiver is connected.
- Consult the dealer or an experienced radio TV technician for help.

For more information, refer to the online help system on razerzone.com.

FCC CAUTION STATEMENT

Any changes or modifications not expressly approved by the party responsible for compliance could void the user's authority to operate this equipment.

This device complies with Part 15 of the FCC Rules. Operation is subject to the following two conditions:

- (1) This device may not cause harmful interference, and
- (2) This device must accept any interference received, including interference that may cause undesired operation.

IMPORTANT NOTE:

FCC Radiation Exposure Statement:

This equipment complies with FCC radiation exposure limits set forth for an uncontrolled

environment. End users must follow the specific operating instructions for satisfying RF exposure compliance. This transmitter must not be co-located or operating in conjunction with any other antenna or transmitter.

INDUSTRY CANADA STATEMENT

This device complies with Industry Canada licence-exempt RSSs.

Operation is subject to the following two conditions:

- (1) this device may not cause interference, and
- (2) this device must accept any interference, including interference that may cause undesired operation of the device.

Le présent appareil est conforme aux CNR d'Industrie Canada applicables aux appareils radio exempts de licence. L'exploitation est autorisée aux deux conditions suivantes :

- (1) l'appareil ne doit pas produire de brouillage, et
- (2) l'utilisateur de l'appareil doit accepter tout brouillage radioélectrique subi, même si le brouillage est susceptible d'en compromettre le fonctionnement."

This Class B digital apparatus complies with Canadian ICES-003.

Cet appareil numérique de la classe B est conforme à la norme NMB-003 du Canada

RADIATION EXPOSURE STATEMENT:

The product comply with the Canada portable RF exposure limit set forth for an uncontrolled environment and are safe for intended operation as described in this manual. The further RF exposure reduction can be achieved if the product can be kept as far as possible from the user body or set the device to lower output power if such function is available.

DÉCLARATION D'EXPOSITION AUX RADIATIONS:

Le produit est conforme aux limites d'exposition pour les appareils portables RF pour les Etats-Unis et le Canada établies pour un environnement non contrôlé.

Le produit est sûr pour un fonctionnement tel que décrit dans ce manuel. La réduction aux expositions RF peut être augmentée si l'appareil peut être conservé aussi loin que possible du corps de l'utilisateur ou que le dispositif est réglé sur la puissance de sortie la plus faible si une telle fonction est disponible.

USAGE RESTRICTIONS

This Razer device was developed and designed to

comply with the various wireless and telecom agency requirements throughout the world. This ensures that the device do not cause any harm to Public Switching Telecommunication Networks (PSTN) and do not violate any power and frequency spectrum allocations on a country by country basis. This device was also designed to be compliant with regulatory agency limits for Electromagnetic Compatibility (EMC).

IMPORTANT NOTICE FOR USE IN HEALTHCARE ENVIRONMENTS

This Razer device is not a medical device and is not listed under UL or IEC 60601 (or equivalent). This device should be kept at a certain distance to avoid harmful effects to patients or medical equipment.

AVIATION USAGE RESTRICTIONS

Certain restrictions apply to this device while onboard an aircraft. Razer encourages you to understand these restrictions to ensure the flight's safety and security.



STATEMENT OF
COMPLIANCE WITH EU DIRECTIVE ENGLISH

ENGLISH

STATEMENT OF COMPLIANCE WITH EU DIRECTIVE

Hereby, Razer (Europe) GmbH, declares that this Razer Mamba Hyperflux (Gaming Mouse Model: RZ01-0248 and Gaming Mouse Mat Model: RZ02-0248) is in compliance with the essential requirements and other relevant provisions of Directive 2014/53/EU.

Gaming Mouse:

Operating Frequency: 140 – 148.5KHz
2402 - 2480MHz

Max Output power: 6.81dbm +/- 2dbm

Gaming Mouse Mat:

Operating Frequency: 140 – 148.5KHz
2402 - 2480MHz

Max Output power: 5.81dbm +/- 2dbm

SW version:V1.0

The full Declaration of Conformity can be requested via the following:

Company: Razer (Europe) GmbH

Address: Essener Bogen 23, D-22419 Hamburg, Germany

E-mail: compliance@razerzone.com

Internet address: <https://www.razerzone.com>

The interference potential of the device could cause the interference to the system whose fundamental is 140 to 148.5 KHz.

When using the product, maintain a distance of 10cm from the body to ensure compliance with RF exposure requirements. Using with other antenna may cause RF exposure concern higher than expected.