

PACKAGE CONTENTS / SYSTEM REQUIREMENTS

PACKAGE CONTENTS

- Razer Wireless Gaming Controller (Model No. : RZ06-0128)
- Battery casing
- 2 AA battery
- USB to micro USB cable
- Game clip
- Quick Start Guide

SYSTEM REQUIREMENTS

- Android mobile device / Android TV device with Bluetooth Low Energy (BT 4.0 or higher) capability
- Windows® 8 / Windows® 7 / Windows Vista® / Windows® XP

REGISTRATION / TECHNICAL SUPPORT

REGISTRATION

Sign up now for a Razer Synapse account to get real-time information on your product's warranty status. To learn more about Razer Synapse and all its features, visit www.razerzone.com/synapse.

If you are already a Razer Synapse user, register your product by clicking on your email address at the Razer Synapse application and select *Warranty Status* from the dropdown list.

To register your product online, visit www.razerzone.com/registration. Please note that you will not be able to view your warranty status if you register via the website.

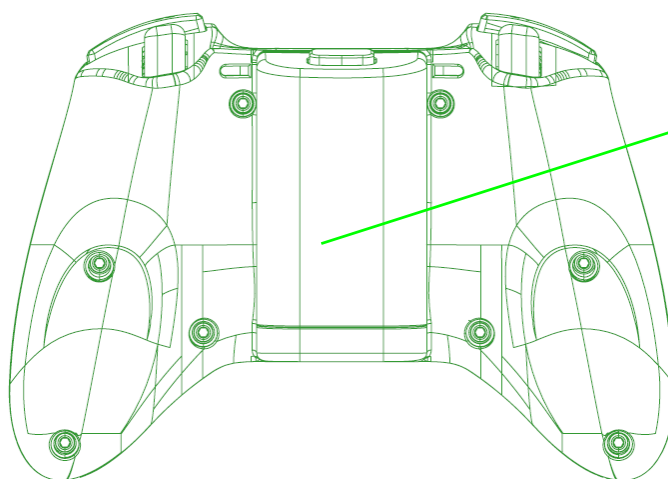

*Your product's serial number
can be found here.*

TECHNICAL SUPPORT

What you'll get:

- 1 year limited manufacturer's warranty.
- Free online technical support at www.razersupport.com.

DEVICE LAYOUT

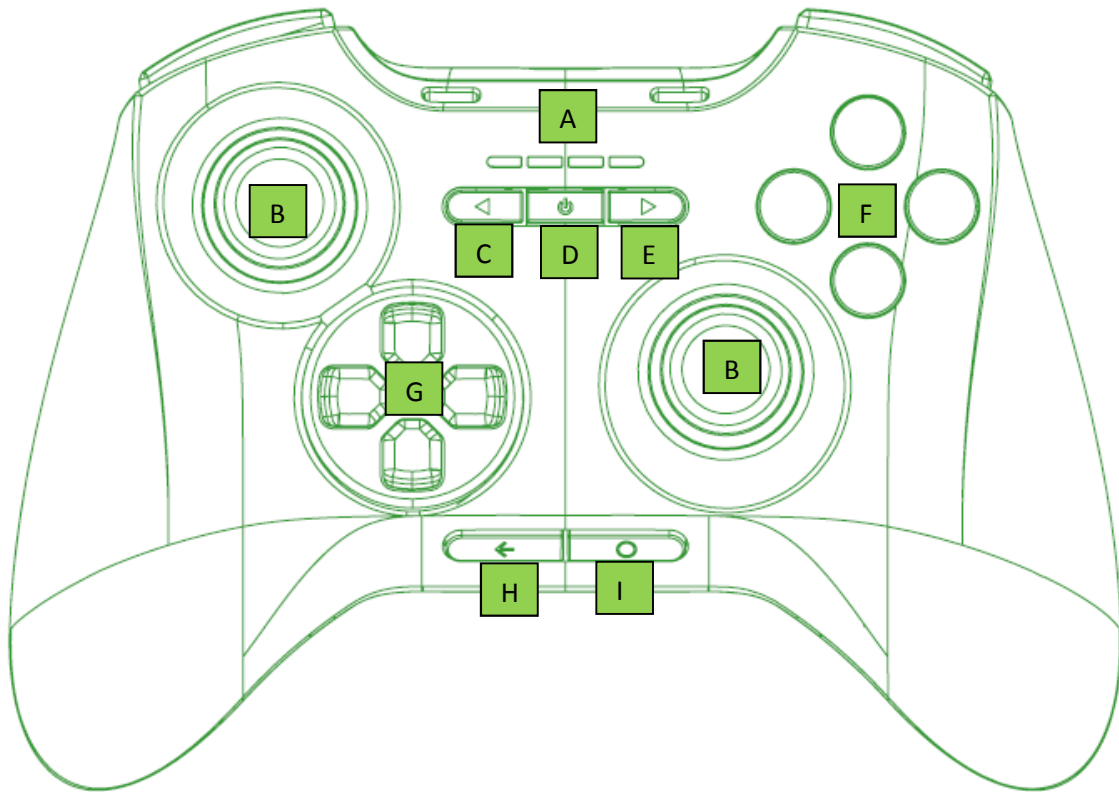

- A. Status indicator
- B. Analog sticks
- C. Select button
- D. Power / Mode button
- E. Start button
- F. Action buttons
- G. Directional pad
- H. Back button
- I. Home button

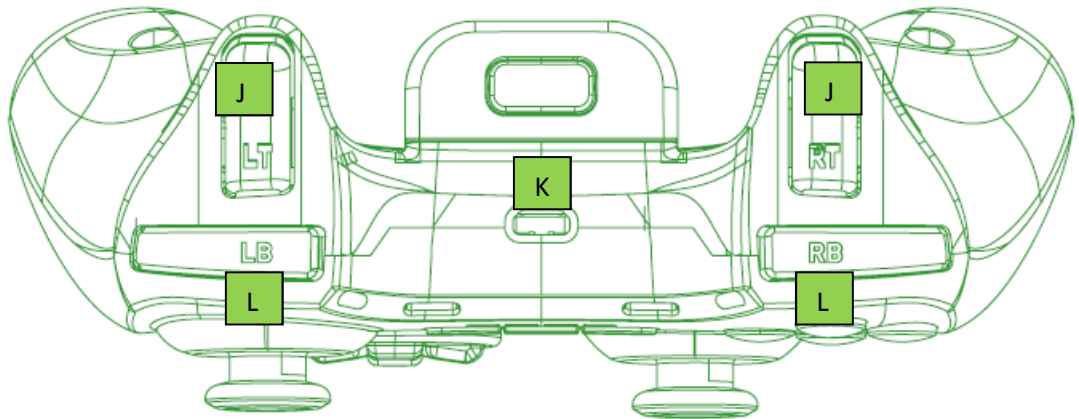



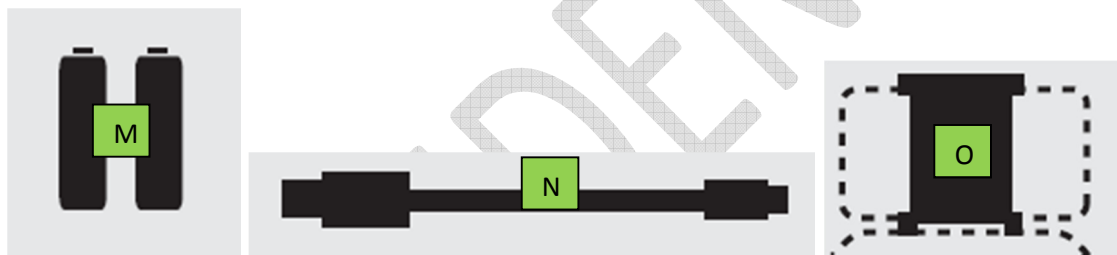



- J. Shoulder triggers
- K. Micro USB port
- L. Shoulder buttons







- M. Batteries
- N. USB cable
- O. Game clip

Controller Basics

Button	Function
Directional Pad 	Press the directional buttons to navigate the Home screen.
Select Button 	This button is mainly used for gaming to select an item or a function.
Power (Short Press) 	Press this button for less than 1 second to power up or put the controller to sleep.
Mode (Long Press) 	Press this button for more than 3 seconds to change the controller assignment.
Start Button 	This button is mainly used for gaming to start or pause the game.
Back Button 	Press this button to return to the previous screen or undo a previous action.
Home Button 	Press this button to exit from an app and return to the Home screen.

LED Status

State	Description
 (All off)	Powered down or in sleep mode
 (All flashing)	Pairing to an Android device
 (One button lit)	Connected and assigned as the corresponding player
 (One button flashing)	Low battery warning

SETTING UP THE RAZER SERVAL FOR YOUR ANDROID PHONE

1. Insert the batteries into the battery casing.
2. Attach the battery casing onto the controller.
3. Attach the game clip to the controller.
4. From the **Home** screen of your Android phone, select **Settings** and then select **Controllers**.
5. Select **Bluetooth Game Controllers**, and then select **Add Bluetooth Controllers**.
6. Press the **Power** button to power up the controller.
7. When the controller is discovered, select it from the list of discovered devices.

SETTING UP THE RAZER SERVAL FOR YOUR ANDROID TV

1. Insert the batteries into the battery casing.
2. Attach the battery casing onto the controller.
3. From the **Home** screen of your Android TV, select **Settings** and then select **Controllers**.
4. Select **Bluetooth Game Controllers**, and then select **Add Bluetooth Controllers**.
5. Press the **Power** button to power up the controller.
6. When the controller is discovered, select it from the list of discovered devices.

You can also use the controller in wired mode by connecting the USB cable from the Razer Serval to your Android TV device.

SETTING UP THE RAZER SERVAL FOR YOUR PC

1. Connect the USB cable from the Razer Serval to your PC.
2. Wait until Windows automatically detects and installs the necessary drivers.

Or download the drivers from this link:

www.microsoft.com/hardware/en-us/d/xbox-360-controller-for-windows

You are now ready to use the Razer Serval. Have Fun!

LEGALESE

COPYRIGHT AND INTELLECTUAL PROPERTY INFORMATION

©2014 Razer Inc. Patent Pending. All Rights Reserved. Razer, the Razer Triple-Headed Snake logo, the Razer distressed word logo and other trademarks contained herein are trademarks or registered trademarks of Razer Inc. and/or its affiliated or associated companies, registered in the United States and/or other countries.

Windows and the Windows logo are trademarks of the Microsoft group of companies. Android is a trademark of Google Inc.

Razer Inc. (“Razer”) may have copyright, trademarks, trade secrets, patents, patent applications, or other intellectual property rights (whether registered or unregistered) concerning the product in this guide. Furnishing of this guide does not give you a license to any such copyright, trademark, patent or other intellectual property right. The **Razer Serval** (the “Product”) may differ from pictures whether on packaging or otherwise. Razer assumes no responsibility for such differences or for any errors that may appear. Information contained herein is subject to change without notice.

LIMITED PRODUCT WARRANTY

For the latest and current terms of the Limited Product Warranty, please visit www.razerzone.com/warranty.

LIMITATION OF LIABILITY

Razer shall in no event be liable for any lost profits, loss of information or data, special, incidental, indirect, punitive or consequential or incidental damages, arising in any way out of distribution of, sale of, resale of, use of, or inability to use the Product. In no event shall Razer’s liability exceed the retail purchase price of the Product.

COSTS OF PROCUREMENT

For the avoidance of doubt, in no event will Razer be liable for any costs of procurement unless it has been advised of the possibility of such damages, and in no case shall Razer be liable for any costs of procurement liability exceeding the retail purchase price of the Product.

GENERAL

These terms shall be governed by and construed under the laws of the jurisdiction in which the Product was purchased. If any term herein is held to be invalid or unenforceable, then such term (in so far as it is invalid or unenforceable) shall be given no effect and deemed to be excluded without invalidating any of the remaining terms. Razer reserves the right to amend any term at any time without notice.

CONFIDENTIAL

FCC DECLARATION OF CONFORMANCE

This equipment has been tested and found to comply with the limits for a Class B digital device, pursuant to part 15 of the FCC Rules. These limits are designed to provide reasonable protection against harmful interference in a residential installation. This equipment generates, uses and can radiate radio frequency energy and, if not installed and used in accordance with the instructions, may cause harmful interference to radio communications. However, there is no guarantee that interference will not occur in a particular installation. If this equipment does cause harmful interference to radio or television reception, which can be determined by turning the equipment off and on, the user is encouraged to try to correct the interference by one or more of the following measures:

- Reorient or relocate the receiving antenna.
- Increase the separation between the equipment and the receiver.
- Connect the equipment into an outlet on a circuit different from that to which the receiver is connected.
- Consult the dealer or an experienced radio TV technician for help.

For more information, refer to the online help system on www.razerzone.com.

This device complies with Part 15 of the FCC Rules. Operation is subject to the following two conditions:

- (1) This device may not cause harmful interference, and
- (2) This device must accept any interference received, including interference that may cause undesired operation.

CAUTION: Any changes or modifications not expressly approved by the party responsible for compliance could void the user's authority to operate this device.

This equipment complies with FCC radiation exposure limits set forth for an uncontrolled environment. This transmitter must not be operated in conjunction with any other antenna.

Industry Canada Compliance Statement

This device complies with Industry Canada licence-exempt RSS standard(s). Operation is subject to the following two conditions: (1) this device may not cause interference, and (2) this device must accept any interference, including interference that may cause undesired operation of the device.

Le présent appareil est conforme aux CNR d'Industrie Canada applicables aux appareils radio exempts de licence. L'exploitation est autorisée aux deux conditions suivantes : (1) l'appareil ne doit pas produire de brouillage, et (2) l'utilisateur de l'appareil doit accepter tout brouillage radioélectrique subi, même si le brouillage est susceptible d'en compromettre le fonctionnement.

The device meets the exemption from the routine evaluation limits in section 2.5 of RSS 102 and compliance with RSS-102 RF exposure, users can obtain Canadian information on RF exposure and compliance.

Le dispositif rencontre l'exemption des limites courantes d'évaluation dans la section 2.5 de RSS 102 et la conformité à l'exposition de RSS-102 rf, utilisateurs peut obtenir l'information canadienne sur l'exposition et la conformité de rf.