



dirt rocket™



OWNER'S MANUAL

Read and understand this entire manual before riding!

Item Numbers:

Dirt Rocket MX350 15128050

Dirt Rocket MX500 15128190

Dirt Rocket MX650 15165070

CONTENTS

Safety Warnings	1	MX350 Parts.....	13-14
Before You Begin.....	2	MX500 / MX650 Parts	15-16
Assembly and Set-Up.....	3-5	Safety Reminders	17
Repair and Maintenance.....	5-9	Warranty Information.....	17
Troubleshooting Guide	11-12		

SAFETY WARNINGS

⚠ WARNING: Riding an electric motorbike can be a hazardous activity. Certain conditions may cause the equipment to fail without fault of the manufacturer. Like other electric vehicles, the Dirt Rocket can and is intended to move, and it is therefore possible to lose control, fall off and/or get into dangerous situations that no amount of care, instruction or expertise can eliminate. If such things occur you can be seriously injured or die, even when using safety equipment and other precautions. **RIDE AT YOUR OWN RISK AND USE COMMON SENSE.**

This manual contains many warnings and cautions concerning the consequences of failing to maintain, inspect or properly use your electric motorbike. Because any incident can result in serious injury or even death, we do not repeat the warning of possible serious injury or death each time such a possibility is mentioned.

APPROPRIATE RIDER USE AND PARENTAL SUPERVISION

This manual contains important safety information. It is your responsibility to review this information and make sure that all riders understand all warnings, cautions, instructions and safety topics and assure that young riders are able to safely and responsibly use this product. Razor USA recommends that you periodically review and reinforce the information in this manual with younger riders, and that you inspect and maintain your children's vehicle to insure their safety.

The recommended rider age (12 years for the MX350, 14 for the MX500, and 16 for the MX650) is only an estimate, and can be affected by the rider's size, weight or skills. Any rider unable to fit comfortably on the Dirt Rocket should not attempt to ride it.

A parent's decision to allow his or her child to ride this product should be based on the child's maturity, skill and ability to follow rules.

Keep this product away from small children and remember that this product is intended for use only by persons who are, at a minimum, completely comfortable and competent while operating the vehicle.

DO NOT EXCEED THE WEIGHT LIMIT OF 140 pounds for the MX350, 175 pounds for the MX500, and 220 pounds for the MX650. Rider weight does not necessarily mean a person's size is appropriate to fit or maintain control of the Dirt Rocket.

Do not touch the brakes or electric motor on your electric motorbike when in use as they can become very hot.

Refer to the section on safety for additional warnings.

ACCEPTABLE RIDING PRACTICES AND CONDITIONS

Always check and obey any local laws or regulations which may affect the locations where the Dirt Rocket may be used.

Ride defensively. Watch out for potential obstacles that could catch your wheel or force you to swerve suddenly or lose control. Be careful to avoid pedestrians, skaters, skateboards, scooters, bikes, children or animals who may enter your path, and respect the rights and property of others.

The Dirt Rocket is meant to be used only in controlled environments free of potential traffic hazards and not on public streets or sidewalks. Do not ride your electric motorbike in any areas where pedestrian or vehicle traffic is present.

Do not activate the speed control on the hand grip unless you are on the electric motorbike and in a safe, outdoor environment suitable for riding.

These bikes were manufactured for performance and durability but are not impervious to damage. Jumping or other aggressive riding can over-stress and damage any product, including the electric motorbike, and the rider assumes all risks associated with high-stress activity.

Be careful and know your limitations. Risk of injury increases as the degree of riding difficulty increases. The rider assumes all risk associated with aggressive riding activities.

Maintain a hold on the handlebars at all times.

Never carry passengers or allow more than one person at a time to ride the electric motorbike.

Never use near steps or swimming pools.

Keep your fingers and other body parts away from the drive chain, steering system, wheels and all other moving components.

Never use headphones or a cell phone when riding.

Never hitch a ride with another vehicle.

Do not ride the Dirt Rocket in wet or icy weather and never immerse the electric motorbike in water, as the electrical and drive components could be damaged by water or create other possibly unsafe conditions.

The Dirt Rocket is intended for use on flat, level ground without loose debris such as rocks or gravel. Wet, slick, bumpy, uneven or rough surfaces may impair traction and contribute to possible accidents. Do not drive the electric motorbike in mud, ice, puddles or water. Avoid excessive speeds that can be associated with downhill rides. Never risk damaging surfaces such as carpet or flooring by use of an electric motorbike indoors.

Do not ride at night or when visibility is limited.

PROPER RIDING ATTIRE

Always wear proper protective equipment such as an approved safety helmet (with chin strap securely buckled), elbow pads and kneepads. A helmet may be legally required by local law or regulation in your area. A long-sleeved shirt, long pants and gloves are recommended. Always wear athletic shoes (lace-up shoes with rubber soles), never drive barefooted or in sandals, and keep shoelaces tied and out of the way of the wheels, motor and drive system.

USING THE CHARGER

The charger supplied with the electric motorbike should be regularly examined for damage to the cord, plug, enclosure and other parts, and in the event of such damage, the bike must not be charged until the charger has been repaired or replaced.

Use only with the recommended charger.

The charger is not a toy.

Always disconnect from the charger prior to wiping down and cleaning your electric motorbike with liquid.

FAILURE TO USE COMMON SENSE AND HEED THE ABOVE WARNINGS INCREASES RISK OF SERIOUS INJURY. USE WITH APPROPRIATE CAUTION AND SERIOUS ATTENTION TO SAFE OPERATION.

BEFORE YOU BEGIN

Remove contents from box. Remove the foam separators that protect the components from damage during shipping. Inspect the contents of the box for scratches in the paint, dents or kinked cables that may have occurred during shipping. Because the Dirt Rocket was 95 percent assembled and packed at the factory, there should not be any problems, even if the box has a few scars or dents.

Estimated Assembly and Set-Up Time

Razor recommends assembly by an adult with experience in bicycle mechanics. Allow up to 30 minutes for assembly, not including initial charge time. Allow up to 12 hours for initial charge (see page 3 for charging information).

WARNING:
DO NOT USE NON-RAZOR PRODUCTS WITH YOUR RAZOR DIRT ROCKET. The Dirt Rocket has been built to certain Razor design specifications. The original equipment supplied at the time of sale was selected on the basis of its compatibility with the frame, fork and all other parts. Certain aftermarket products may or may not be compatible.

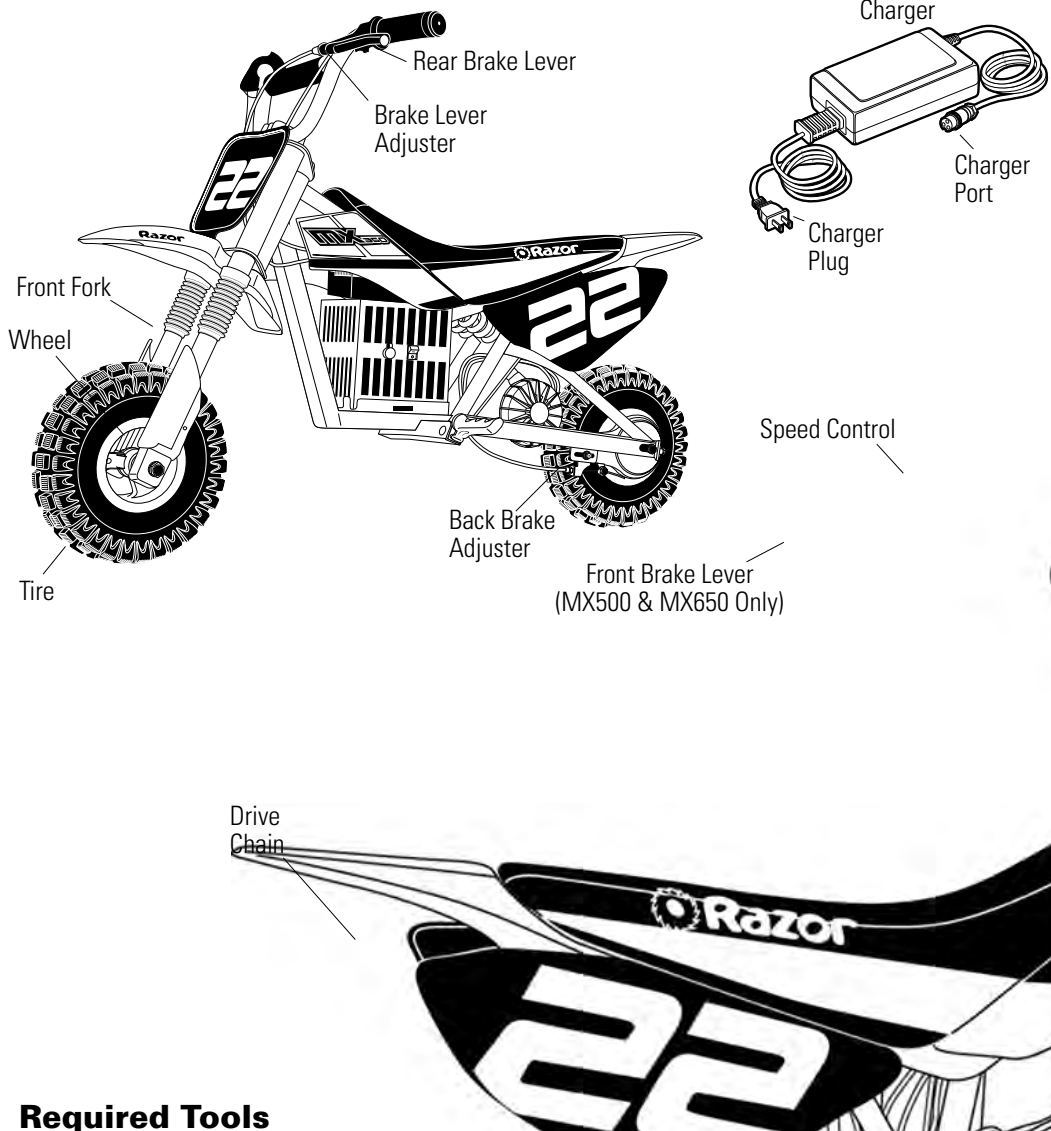

Required Tools

Some tools may be supplied; however, we recommend the use of mechanic's grade tools. Use the supplied tools only as a last resort.

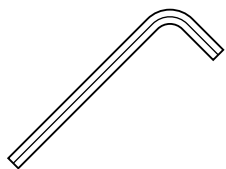

2.5mm, 4mm and 5mm hexagonal key wrenches (included)

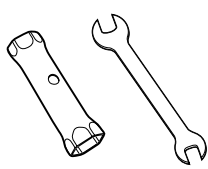

Wrenches (included)

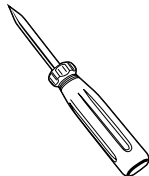

Screwdriver (included)

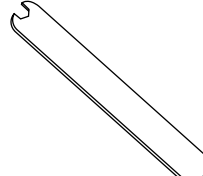

Spoke tightener (Included)

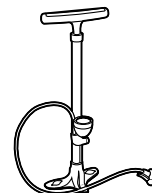

Bicycle-style tire pump for Schrader valve tires, with pressure gauge

Need Help? Visit our web site for updates and a list of authorized service centers at www.razor.com or call toll-free at **866-467-2967** Monday - Friday 8:00 AM - 5:00 PM Pacific Time.

ASSEMBLY AND SET-UP

Charging the Battery

Your electric motorbike may not have a fully charged battery; therefore it is a good idea to charge the battery prior to use.

- Initial charge time: 12 hours
- Recharge time: up to 8 hours, depending on the level of depletion
- Run time: up to 40 minutes
- Average battery life: 250 charge/discharge cycles

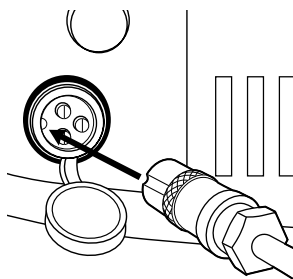
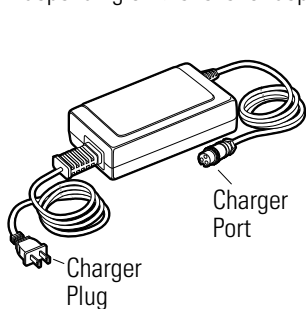

1 Plug the charger port into the port on the electric motorbike. The charger works with the power switch in either the on or off position.

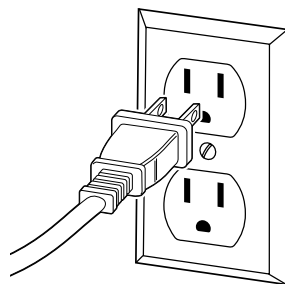

2 Plug the charger plug into a wall outlet.

Attaching the Front Forks - MX350

1 Remove steering bolt, spacer sleeves, washers and nut from front fork assembly. Loosen top fork crown bolts.

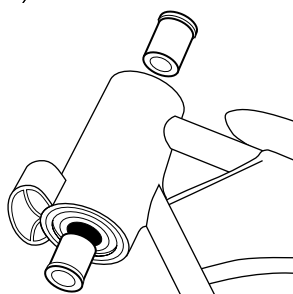
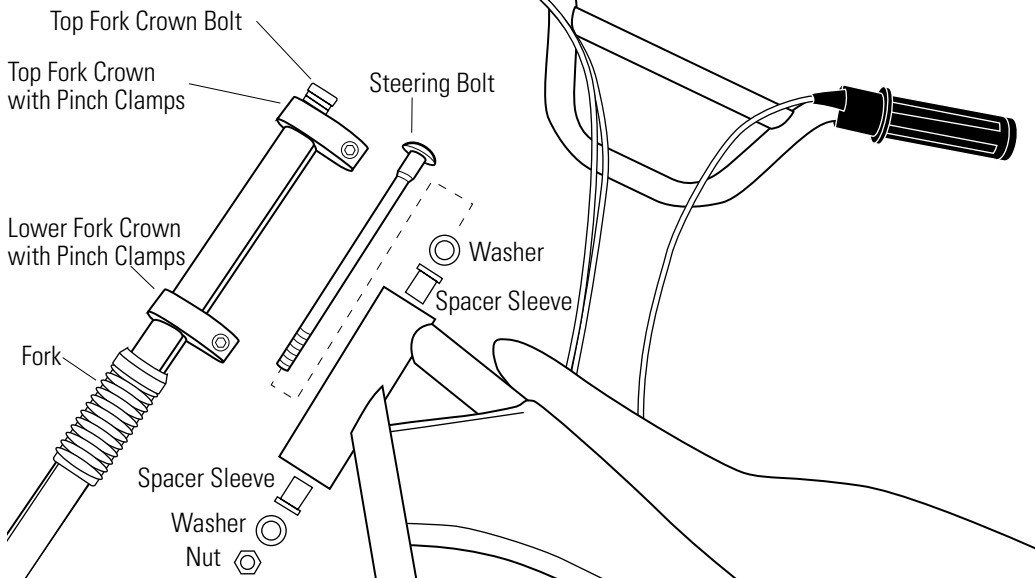

2 Insert the spacer sleeves on the top and bottom of the frame.



3 Slide the fork into position and insert the steering bolt. The bolt must go through the washer and spacer sleeve and between the steering bearings inside the frame.

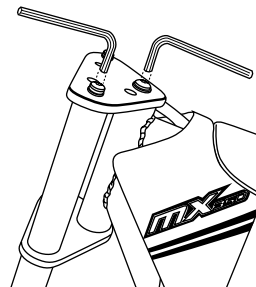

4 Install washer and nut onto steering bolt. Tighten until snug, then back off slightly to allow the steering to rotate freely with no binding or end-play. Tighten the top fork crown bolts.

⚠ WARNING:

Always disconnect your electric motorbike from the charger before cleaning with liquid.

Note: If your charger does not look like the one illustrated, your unit has been supplied with an alternative charger. The specifications and charging procedure would not change.

The charger has a small window with one LED or two LEDs to indicate the charge status. Refer to the illustration on the charger unit for the actual "charging" and "charged" status indications for your model charger.

Chargers have built-in over-charge protection to prevent battery from being over-charged.

Be sure to properly align the groove on the charger input plug with the corresponding socket on the case; otherwise, no charging action will occur.

⚠ WARNING:

Failing to properly adjust and tighten the nuts and bolts that affix the forks can cause you to lose control and fall.

ASSEMBLY AND SET-UP

Installing the Front Wheel - MX500 / MX650

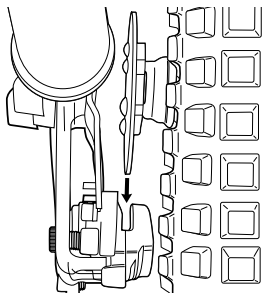

1 Position wheel in front fork and slide disk brake into caliper.

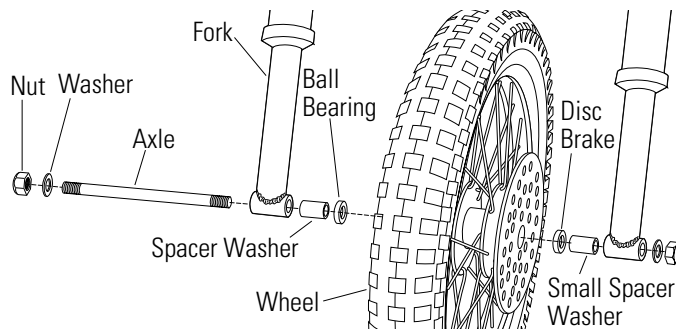

2 Make sure ball bearings are inserted in the wheel hub. Slide axle through fork, spacer washer and through wheel hub. When axle passes through the other side of the wheel hub, add the other spacer washer and slide through the fork. Secure with washer and nut.

Note: Front axle is installed with the spacer washers between the fork and wheel for all Dirt Rockets. If your model has one short spacer, it goes on the side of the hub with the disc brake.

WARNING:

Failing to properly adjust and tighten the bolts that affix the handlebars can cause you to lose control and crash.

Attaching the Handlebars

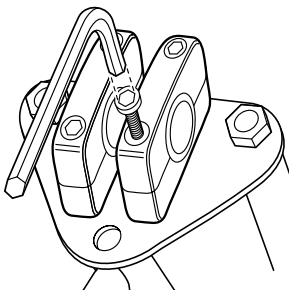

1 Using a 5mm hexagonal key wrench, remove bolts from handlebar clamp.

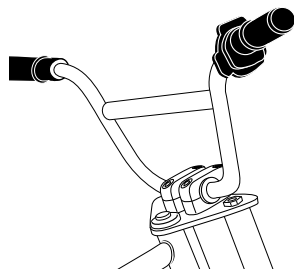

2 Place handlebars in handlebar clamp and adjust angle parallel to the fork.

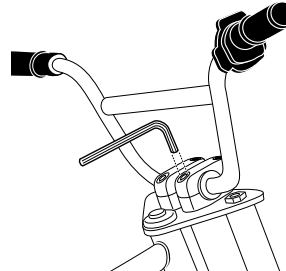

3 Insert bolts and tighten securely. When properly tightened, the handlebars should not move forward or back.

Attaching the Front Fender and Number Plate

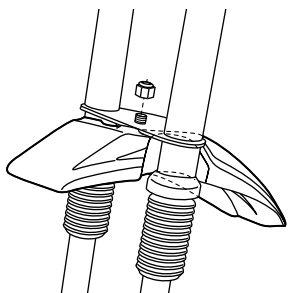

1 Align bolt in fender with hole in fork. Insert bolt through hole in fork and secure with nut.

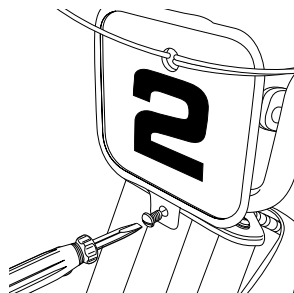

2 Remove screw from front fork assembly. Align hole in number plate with hole in fork assembly. Insert and tighten screw.

ASSEMBLY AND SET-UP

Inflating the Tires

Tires are inflated when shipped, but they invariably lose some pressure between the point of manufacturing and your purchase.

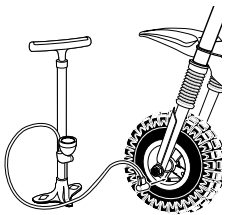

Using a bicycle-style tire pump equipped for a Schrader-type valve, inflate the front tire to the PSI indicated on the sidewall of the tire.

Testing the Brakes

To use the brake, squeeze the lever to increase the pressure on the brake. The brake lever is fitted with a cable adjuster to compensate for cable stretch and/or to fine-tune the lever movement to brake engagement. If brake is not engaging properly, follow instructions for adjusting the brakes outlined below.

REPAIR AND MAINTENANCE

Check the Razor web site for any updates on the latest repair and maintenance procedures.

Turn power switch off before conducting any maintenance procedures.

□ Adjusting the Brakes

MX350

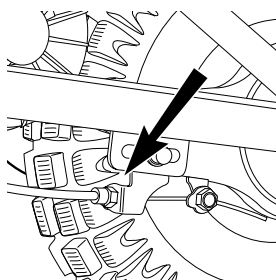
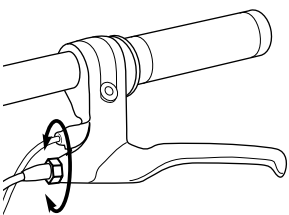

1 To adjust the play, thread the brake lever adjuster in or out 1/4 to 1/2 turn until the desired brake adjustment is attained. Most adjustments are complete at this step. If brake still needs further adjustment, proceed to step 2.

2 If the brake lever adjuster is threaded outward and the brake still has too much slack, use the back brake adjuster at the rear brake for additional adjustment.

MX500 / MX650

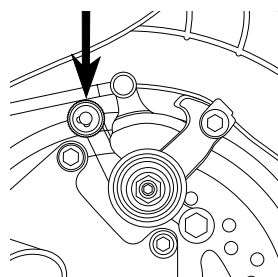
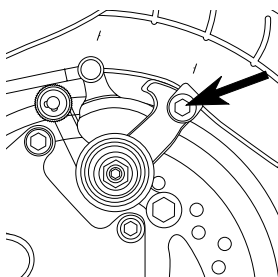
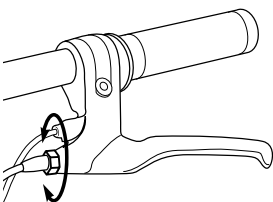

1 To adjust the play, thread the brake lever adjuster in or out 1/4 to 1/2 turn until the desired brake adjustment is attained. Most adjustments are complete at this step. If brake still needs further adjustment, proceed to step 2 for rear brake.

2 If the brake has too much slack, loosen the rear anchor bolt and pull the brake wire tighter. The distance of the brake wire between the end of the cable and the anchor bolt should be between 37mm and 44 mm.

3 If the brake rotor is dragging on the brake pads, use your fingers to twist the caliper adjuster in either direction until rotor is centered between pads.

Note: The pressurized air supplies found at gasoline stations are designed to inflate high-volume automobile tires. If you decide to use such an air supply to inflate your tires, first make sure the pressure gauge is working, then use very short bursts to inflate to the correct PSI. If you inadvertently over-inflate the tire, release the excess pressure immediately.

! WARNING:

The brake is capable of causing the electric motorbike to skid the tire throwing an unsuspecting rider. Practice in an open area free from obstacles until you are familiar with the brake function. Avoid skidding to a stop as this can cause you to lose control or damage the rear tire.

REPAIR AND MAINTENANCE

□ Chain and Rear Tire Replacement – MX350

Tools required: 10mm wrench, two (2) 8mm wrenches, and two (2) 17mm wrenches.

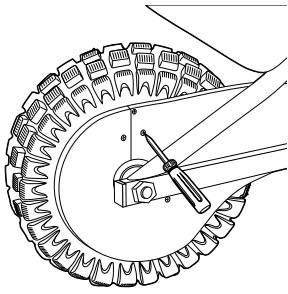

1 Loosen screws and remove chain guard.

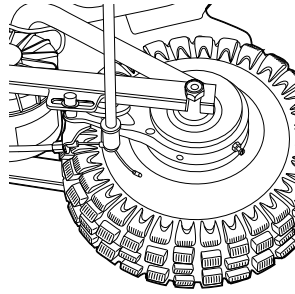

2 With a 10mm wrench, loosen the brake cable anchor and disconnect the cable.

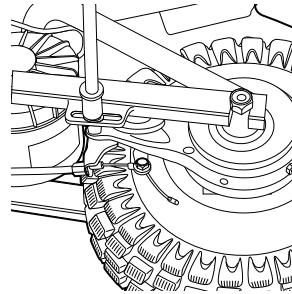

3 With two 8mm wrenches, loosen brake housing anchor and disconnect. Keep the spacer and washers together.

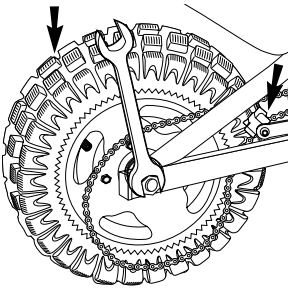

4 With two 17mm wrenches, loosen the axle. Push the chain tensioner down to loosen the chain and pull the wheel out.

Note: Your hands will get greasy doing this.

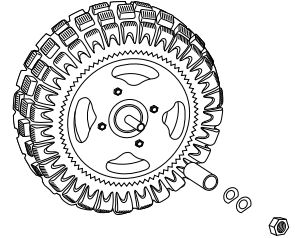

5 Pull the wheel out. Note the arrangement of the hardware sequence.

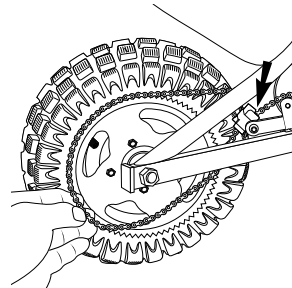

6 Install the new chain or wheel by slipping the chain around the axle. Slide the axle into the slots on the frame. Slide the chain tensioner down and maneuver the chain onto the rear sprocket and front sprocket.

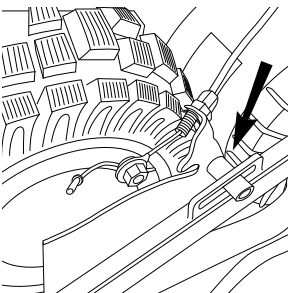

7 To hook up the brake housing anchor, align the cable guide adjuster and install the spacer and bolt. Do not tighten until final step.

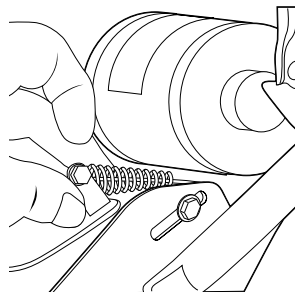

8 Install the brake spring and thread the cable wire into the cable anchor. Thread the cable to its original position and tighten securely.

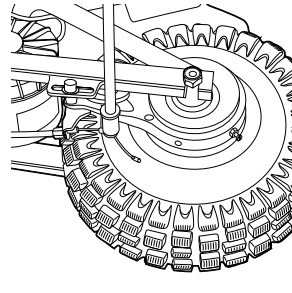

9 Tighten the brake housing anchor securely. Re-attach the chain guard. Test ride and check. Readjust as needed.

REPAIR AND MAINTENANCE

□ Chain and Tire Replacement – MX500 / MX650

Tools required: Phillips screwdriver and two (2) 17mm wrenches.

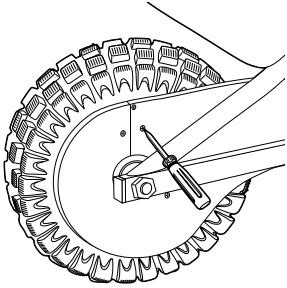

1 Loosen screw and remove chain guard.

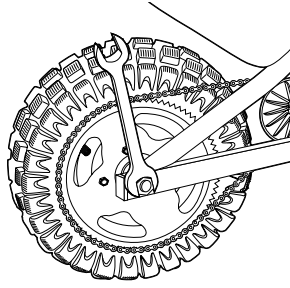

2 Loosen the rear axle by attaching wrenches to both axle nuts and loosening counter-clockwise.

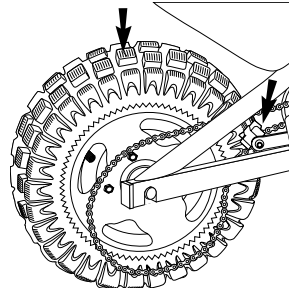

3 Push the chain tensioner down to slacken the chain and disengage the chain from the wheel sprocket and motor sprocket. Pull the wheel downward.

Note: Your hands will get greasy doing this.

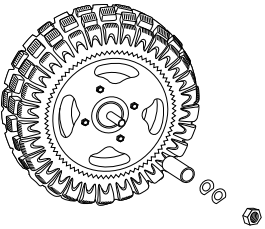

4 Pull the wheel out. Note the arrangement of the hardware sequence.

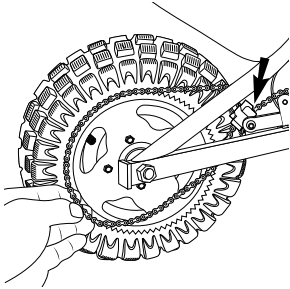

5 Install the new chain or wheel by slipping the chain around the axle. Slide the axle into the slots on the frame. Slide the chain tensioner down and maneuver the chain onto the rear sprocket and front sprocket.

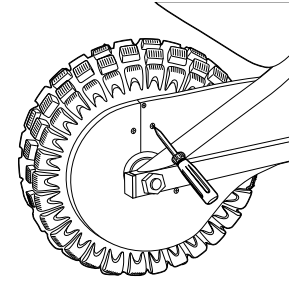

6 Re-attach the chain guard. Test ride and check. Readjust as needed.

REPAIR AND MAINTENANCE

□ Replacing the Fuse – MX350 / MX500 / MX650

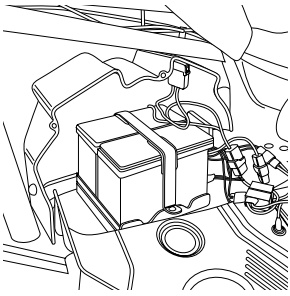

1 Remove the fairing/body cover.

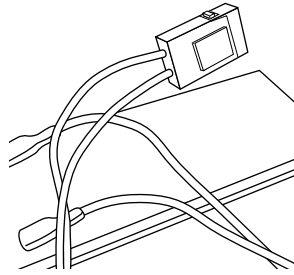

2 Locate the fuse cover attached to the batteries.

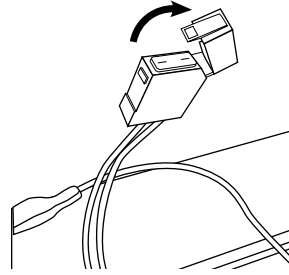

3 Open the fuse cover to expose the fuse.

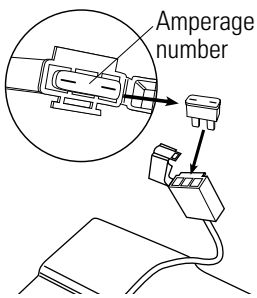

4 Remove the fuse and replace with a new one of equal amperage.

Note: Amperage is located on top of fuse and should be replaced with equal amperage.

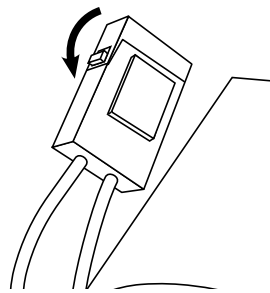

5 Close the fuse cover and reattach the fairing/body cover.

⚠ WARNING:

To prevent shock or short circuit, please follow the instructions accordingly and do not skip or combine any steps.

□ Checking Spoke Tension – MX500 / MX650

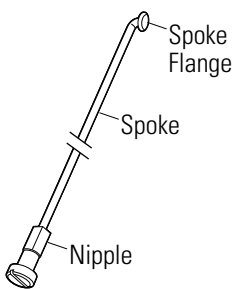

1 Verify spoke tension by grasping and shaking each spoke. Spoke should not be loose from hub. Look for any play between spoke flanges where it mates with hub. Try to turn nipple using your fingers. You should not be able to spin any nipple by hand. If one or more spokes are loose, or if you can turn any nipple using your fingers, all spokes must be checked and need to be tightened with a spoke wrench.

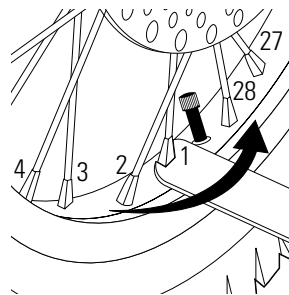
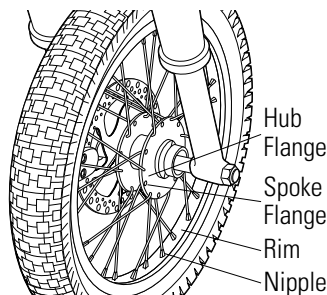

2 Start with spoke closest to tire valve stem and tighten each nipple, in sequence, exactly 1/4 to 1/2 turn. A single 1/4 to 1/2 turn may not be enough to bring the spokes into proper tension. Continue tightening all spokes no more than 1/2 turn in sequence until all spokes are tight.

Note: Tightening each nipple more than a 1/2 turn each can cause the wheel to become distorted and wobbly thus permanently damaging the wheel.

⚠ WARNING:

Regularly check the spoke tension and retighten the spokes whenever loose. If you have any doubt, ask an experienced motorcycle or bicycle mechanic to inspect your spokes to determine if the spokes need tightening or adjusting.

REPAIR AND MAINTENANCE

❑ Chain and Sprocket

The chain will typically have a "loose spot" and "tight spot" corresponding with a particular sprocket rotational position. This is normal and common to all chain-driven vehicles due to run-out tolerances of the freewheel and sprocket. The chain should be adjusted to the ideal tension with chain in the tightest spot.

Proper chain alignment must be maintained. The wheel must not be skewed. If the chain is noisy or rough running, check the lubrication, tension and alignment of the sprockets, in that order.

❑ Battery Care and Disposal

Do not store the battery in temperatures above 75° F or below -10° F.



CONTAINS SEALED LEAD BATTERY. BATTERY MUST BE RECYCLED.

Disposal: Your Razor product uses sealed lead-acid batteries which must be recycled or disposed of in an environmentally sound manner. Do not dispose of a lead-acid battery in a fire. The battery may explode or leak. Do not dispose of a lead-acid battery in your regular household trash. The incineration, land filling or mixing of sealed lead-acid batteries with household trash is prohibited by law in most areas. Return exhausted batteries to a federal or state approved lead-acid battery recycler or a local seller of automotive batteries. If you live in Florida or Minnesota, it is prohibited by law to throw away lead-acid batteries in the municipal waste stream.

❑ Charger

The transformer/charger supplied with the bike should be regularly examined for damage to the cord, plug, enclosure and other parts, and, in the event of such damage, the Dirt Rocket must not be charged until it has been repaired or replaced.

Use ONLY with the recommended charger.

❑ Replacement Parts

The most frequently requested replacement parts (wheels, tires, tubes, batteries and chargers) are available for purchase at some Razor retail partners or online at www.razorama.com. For other parts contact an authorized Razor repair center.

❑ Repair Centers

For a list of authorized Razor repair centers:

- Check online at www.razor.com.
- Send an e-mail to customerservice@razorusa.com or call 866-467-2967 for the center nearest you.

WARNING:

To avoid a pinch or injury, keep fingers away from moving sprockets and chain.

WARNING:

If a battery leak develops, avoid contact with the leaking acid and place the damaged battery in a plastic bag. Refer to the disposal instructions at left. If acid comes into contact with skin or eyes, flush with cool water for at least 15 minutes and contact a physician.

SB 1918 (CALIFORNIA) DECLARATION

YOUR INSURANCE POLICIES MAY NOT PROVIDE COVERAGE FOR ACCIDENTS INVOLVING THE USE OF THIS SCOOTER/ELECTRIC VEHICLE. TO DETERMINE IF COVERAGE IS PROVIDED, YOU SHOULD CONTACT YOUR INSURANCE COMPANY OR AGENT.

TROUBLESHOOTING GUIDE

Problem	Possible Cause	Solution
Vehicle does not run	Undercharged battery	Charge the battery. A new battery should have been charged for at least 12 hours before using the vehicle for the first time and up to 8 hours after each subsequent use. Check all connectors. Make sure the charger connector is tightly plugged into the charging port, and that the charger is plugged into the wall. Make sure power flow to the wall outlet is on.
	Charger is not working	You may check to see if your charger is working by using a volt meter or asking your local Razor authorized service center to test your charger for you.
	Loose wires or connectors	Check all wires and connectors to make sure they are tight.
Vehicle was running but suddenly stopped	Burned-out fuse	The fuse will burn out and automatically shut off the power if the motor is overloaded. An excessive overload, such as too heavy a rider or too steep a hill, could cause the motor to overheat. Replace the fuse with a new one of equal amperage. Correct the conditions that caused the fuse to burn out and avoid repeatedly burning out fuse.
	Motor or electrical switch damage	Contact your local Razor authorized service center for diagnosis and repair.
Short run time (less than 30 minutes per charge)	Undercharged battery	Charge the battery. A new battery should have been charged for at least 12 hours before using the vehicle for the first time and up to 8 hours after each subsequent use. Check all wires and connectors. Make sure the battery connector is tightly plugged into the charger connector, and that the charger is plugged into the wall. Make sure power flow to the wall outlet is on.
	Battery is old and will not accept full charge	Even with proper care, a rechargeable battery does not last forever. Average battery life is 1 to 2 years depending on vehicle use and conditions. Replace only with a Razor replacement battery.
	Brakes are not adjusted properly	Refer to brake adjustment instructions on page 5 of this manual.
Vehicle runs sluggishly	Driving conditions are too stressful	Use only on solid, flat clean and dry surfaces such as pavement or level ground.
	Tires are not properly inflated	The tires are inflated when shipped, but they invariably will lose some pressure between the point of manufacturing and your purchase. Refer to instructions on page 4 and 5 of this manual to properly inflate tires.
	Vehicle is overloaded	Make sure you do not overload the vehicle by allowing more than one rider at one time, exceeding the maximum weight limit, going up too steep a hill or towing objects behind the vehicle. If the vehicle is overheated, the temperature circuit protector will slow motor down and if the condition continues, will shut off power to the motor. Correct the driving conditions that caused the overheating, wait 5-10 minutes and then resume riding. Avoid repeatedly overheating the unit.

TROUBLESHOOTING GUIDE

Problem	Possible Cause	Solution
Sometimes the vehicle doesn't run, but other times it does	Loose wires or connectors	Check all wires around the motors and all connectors to make sure they are tight.
	Motor or electrical switch damage	Contact your local Razor authorized service center for diagnosis and repair.
Charger gets warm during use	Normal response to charger use	No action required. This is normal for some chargers and is no cause for concern. If your charger does not get warm during use, it does not mean that it is not working properly.
Vehicle does not stop when applying the brake	Brakes are not adjusted properly	Refer to instructions on page 5 of this manual to properly adjust brakes.
Vehicle makes loud noises or grinding sounds	Chain is too dry	Apply a lubricant such as 3 in 1™ or Tri-Flow™ to the chain.

Need Help? Visit our web site for updates and a list of authorized service centers at www.razor.com or call toll-free at **866-467-2967** Monday - Friday 8:00 AM - 5:00 PM Pacific Time.

MX350 PARTS

Keep your MX350 running for years with genuine Razor parts. Visit our web site or e-mail us for more information on spare part availability. (Specifications subject to change without notice.)

01	Handlebar grip (right/left)	12-2	On/ Off switch
02	Single speed twist grip throttle	12-3	Main switch protector
02-1	Sleeve	12-4	Charger port w/ wires
03	Handlebar	13	Control module
04	Brake lever assemble complete	14	Kickstand
05	Handlebar clamp complete	15	Motor (24V / 250W)
06	Front wheel complete	16	Rear wheel complete
07	Front fork	17	Chain
08	Front fender	18	Chain guard
09	Frame	19	Seat cushion
10	Fork leg cover (right/left)	19-1	Front cover of seat cushion
11	Battery (2- 12V/ 7Ah)	19-2	Rear cover of seat cushion
12	Battery cover left		
12-1	Battery cover right		

MX350 PARTS

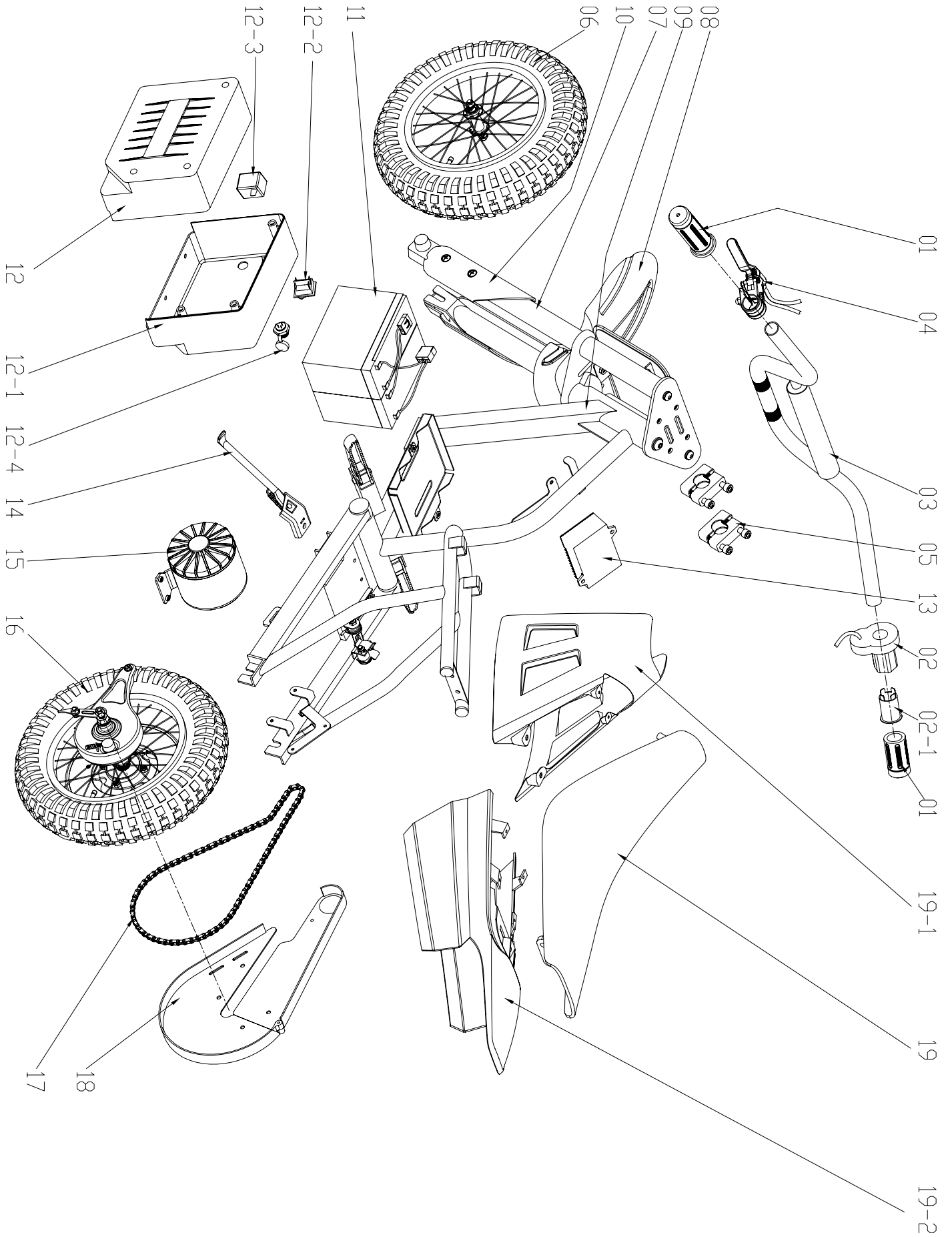

MX500 / MX650 PARTS

Keep your MX500/MX650 running for years with genuine Razor parts. Visit our web site or e-mail us for more information on spare part availability. (Specifications subject to change without notice.)

01	Handlebar grip (right/left)	17	Rear wheel complete
02	Speed controller w/ LEDs	18	Chain
02-1	Sleeve	19	Chain guard
03	Brake lever assemble complete (right)	20	Rear brake calipher
04	Handlebar	21	Battery cover complete
05	Brake lever assemble complete (left)	21-1	Battery cover left
06	Frame	21-2	Battery cover right
07	Front fork	21-3	On/ Off switch
08	Front fender	21-4	Main switch power
09	Handlebar clamp complete	21-5	Charger port w/ wires
10	Front wheel complete	22	Seat cushion complete
11	Front brake caliper	22-1	Seat cushion
12	Shock	22-2	Front cover left
13	Control module	22-3	Front cover right
14	Battery (3- 12V/ 12Ah)	22-4	Mock gas tank
15	Motor (36V/ 12h)	22-5	Rear fender
16	Kickstand		

MX500 / MX650 PARTS

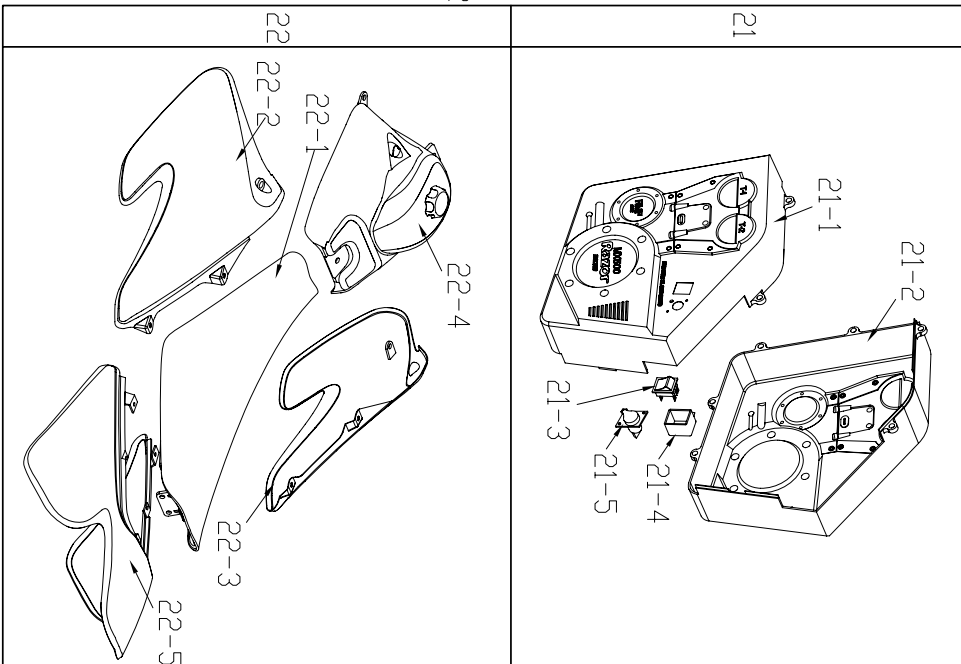
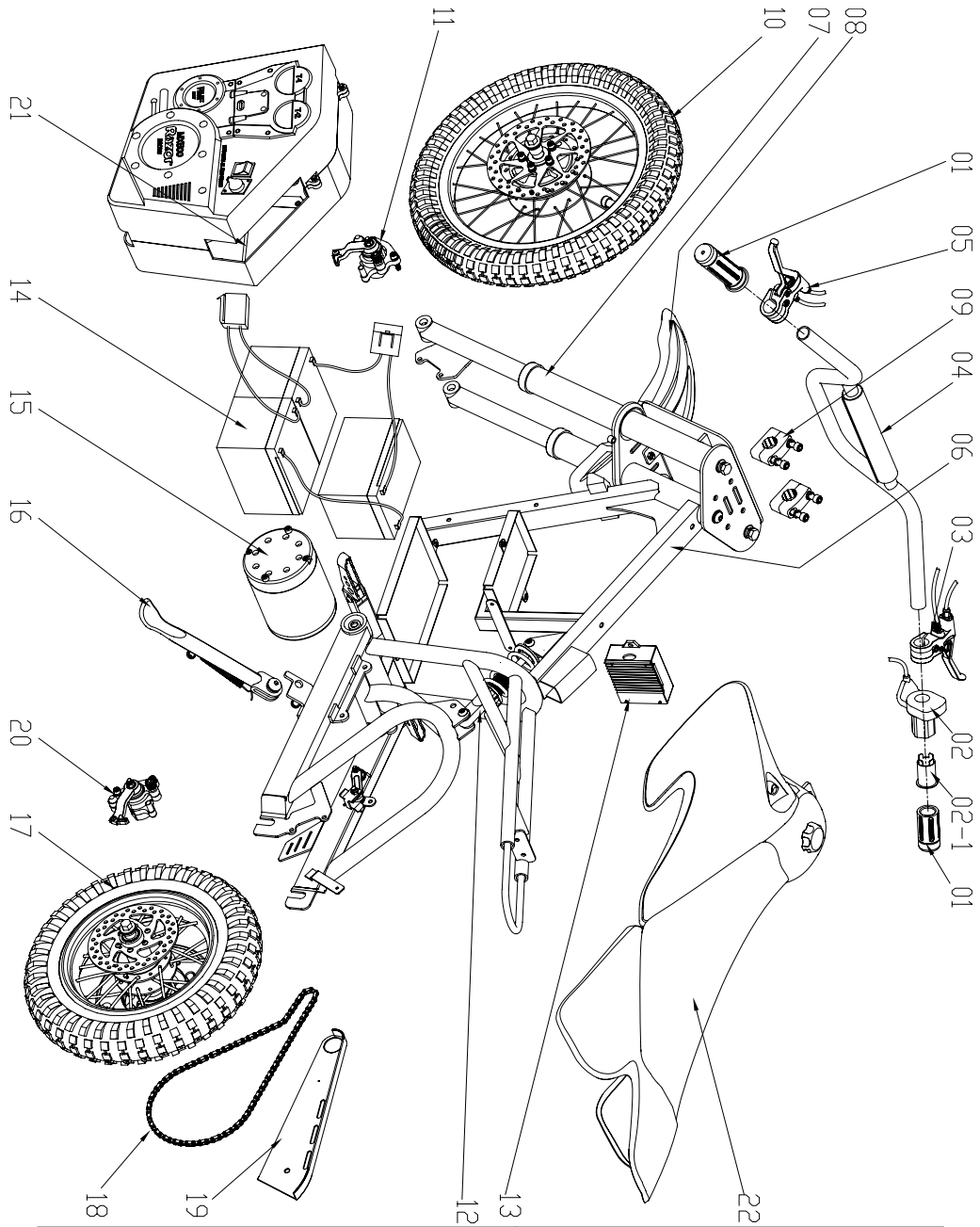

SAFETY REMINDERS

PRE-RIDE CHECKLIST



Loose Parts

There should not be any unusual rattles or sounds from loose parts or broken components. If you are not sure, ask an experienced mechanic to check.



Brake

Check the brake for proper function. When you squeeze the lever, the brake should provide positive braking action.



Frame, Fork and Handlebars

Check for cracks or broken connections. Although broken frames are rare, it is possible for an aggressive driver to bash into a curb or wall and wreck and bend or break a frame. Get in the habit of inspecting yours regularly.



Tire Inflation

Periodically inspect the tires for excess wear and replace as required, and regularly check the tire pressure and re-inflate as necessary. If you get a flat tire, the inner tube can be patched or a new tube can be purchased from Razor or an authorized repair center.



Safety Gear

Always wear proper protective equipment, such as an approved safety helmet, elbow pads and kneepads. Always wear shoes, never drive barefooted or in sandals, and keep shoelaces tied and out of the way of the wheels, motor and drive system.

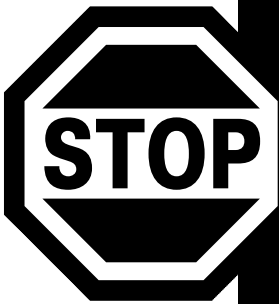

DO NOT RETURN TO STORE

Do not use this vehicle for the first time until you have inflated the tires to the correct PSI and charged the battery for at least 12 hours.

Failure to follow these instructions may damage your vehicle and void your warranty.

WARRANTY

Razor Limited Warranty

The manufacturer warrants this product to be free of manufacturing defects for a period of 90 days from date of purchase. This Limited Warranty does not cover normal wear and tear, tires, tubes or cables, or any damage, failure or loss caused by improper assembly, maintenance, or storage or use of the Razor Dirt Rocket.

This Limited Warranty will be void if the product is ever:

- used in a manner other than for recreation;
- modified in any way;
- rented.

The manufacturer is not liable for incidental or consequential loss or damage due directly or indirectly to the use of this product.

Razor does not offer an extended warranty. If you have purchased an extended warranty, it must be honored by the store at which it was purchased.

For your records, save your original sales receipt with this manual and write the serial number below.

Item Numbers:

MX350 15128050

MX500 15128190

MX650 15165070

Need Help? Visit our web site for updates and a list of authorized service centers at www.razor.com or call toll-free at **866-467-2967** Monday - Friday 8:00 AM - 5:00 PM Pacific Time.