



user manual

DRC260

IMPORTANT SAFETY INSTRUCTION

WARNING
RISK OF ELECTRIC SHOCK.
DO NOT OPEN



This symbol indicates "dangerous voltage" inside the product that presents a risk of electric shock or personal injury.



This symbol indicates important instructions accompanying the product.

To reduce risk of electrical shock, do not remove cover or back (no user serviceable parts inside). Refer servicing to qualified personnel.

FCC INFORMATION

This equipment has been tested and found to comply with the limits for a Class B digital device, pursuant to Part 15 of the FCC rules. These limits are designed to provide reasonable protection against harmful interference in a residential installation. This equipment generates, uses and can radiate radio frequency energy and, if not installed and used in accordance with the instructions, may cause harmful interference to radio communications. However, there is no guarantee that interference will not occur in a particular installation. If this equipment does cause harmful interference to radio or television reception, which can be determined by turning the equipment off and on, the user is encouraged to try to correct the interference by one or more of the following measures.

- Reorient or relocate the receiving antenna.
- Increase the separation between the equipment and receiver.
- Connect this equipment into an outlet on a circuit different from that to which the receiver is connected.
- Consult the dealer or an experienced radio/TV technician for help.

CAUTION: FCC Regulations state that unauthorized changes or modifications to this equipment may void the user's authority to operate it.

This class B digital apparatus meets all requirements of the Canadian Interference-Causing Equipment Regulations.

The Shock Hazard Marking and Associated Graphical Symbol is provided on the bottom panel of unit.

Refer to the identification/rating label located on the back panel of your product for its proper operating voltage.

CAUTION: This product utilizes a laser. Use of controls or adjustments or performance of procedures other than those specified herein may result in hazardous radiation exposure. Do not open covers and do not repair yourself. Refer servicing to qualified personnel.

CLASS 1 LASER PRODUCT

IMPORTANT: The power cord can be unplugged to turn off the main power to the unit. It should also be easily accessible in an emergency.

- Leave sufficient space around the appliance to allow adequate ventilation: 10cm on either side and at the back, as well as 7cm above it are ideal.



This DVD player has earned the ENERGY STAR.

IMPORTANT SAFETY INSTRUCTION

1. Read these Instructions.
2. Keep these Instructions.
3. Heed all Warnings.
4. Follow all instructions.
5. Do not use this apparatus near water.
6. Clean only with a dry cloth.
7. Do not block any of the ventilation openings. Install in accordance with the manufacturer's instructions.
8. Do not install near any heat sources such as radiators, heat registers, stoves, or other apparatus (including amplifiers) that produce heat.
9. Do not defeat the safety purpose of the polarized or grounding – type plug. A polarized plug has two blades with one wider than the other. A grounding type plug has two blades and a third grounding prong. The wide blade or the third prong are provided for your safety. If the provided plug does not fit into your outlet, consult an electrician for replacement of the obsolete outlet.
10. Protect the power cord from being walked on or pinched particularly at plugs, convenience receptacles, and the point where they exit from the apparatus.
11. Only use attachments/accessories specified by the manufacturer.
12. Use only with a cart, stand, tripod, bracket, or table specified by the manufacturer, or sold with the apparatus. When a cart is used, use caution when moving the cart/apparatus combination to avoid injury from tip-over.
13. Unplug this apparatus during lightning storms or when unused for long periods of time.
14. Refer all servicing to qualified service personnel. Servicing is required when the apparatus has been damaged in anyway, such as power-supply cord or plug is damaged, liquid has been spilled or objects have fallen into the apparatus, the apparatus has been exposed to rain or moisture, does not operate normally, or has been dropped.



Portable Cart Warning

Product Registration:

Please fill out the product registration card (packed separately) and return it immediately. For U.S. customers: Your RCA Consumer Electronics product may also be registered at www.rca.com/productregistration. Registering this product allows us to contact you if necessary.

Keep your sales receipt to obtain warranty parts and service and for proof of purchase. Attach it here and record the serial and model numbers in case you need them. The numbers are located on the back of the player.

Model number: _____ Serial Number: _____

Purchase date: _____

Dealer address and phone: _____

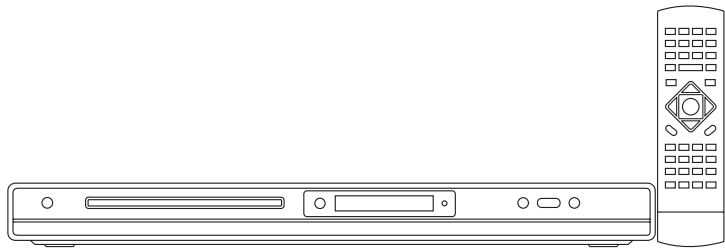

It is important to read this instruction prior to using your new product for the first time.

Remote Control

- ZOOM** Accesses the Zoom feature (if available).
- ANGLE** Selects the camera angle (if available).
- OPEN • CLOSE** Opens and closes the disc tray.
- ON • OFF** Turns the player on and off.
- PROGRAM** Accesses the Program playback mode.
- RANDOM** Starts the Random playback mode.
- REPEAT** Accesses the Repeat playback mode.
- A - B** Accesses the A-B repeat playback mode.
- REVERSE ◀** Searches back through the disc.
- FORWARD ▶** Searches forward through the disc.
- SKIP ◀▶** Advances to the next/preceding chapter or track.
- PAUSE** Freezes frame, frame advance, and slow motion.
- PLAY ▶** Starts playing a disc.
- STOP ■** Stops disc playback.
- CLEAR** Clears inputs or operations.
- DISC MENU** Accesses the disc's menu (if available).
- ◀, ▶, ▲, ▼** Navigates through the menus.
- OK** Selects the item highlighted in the menu.
- PREVIEW** Previews contents of disc.
- SET UP** Accesses and exits the General setup main menu.
- 0-9** Number entry.
- DISPLAY** Shows playback status.
- AUDIO** Selects the audio language.
- SUBTITLE** Selects the subtitle language.
- MUTE** Mutes and restores the audio output.
- BOOKMARK** Accesses the bookmark feature.
- TITLE MENU** Accesses the title of the disc and turns Playback Control (PBC) on and off (VCDs only).

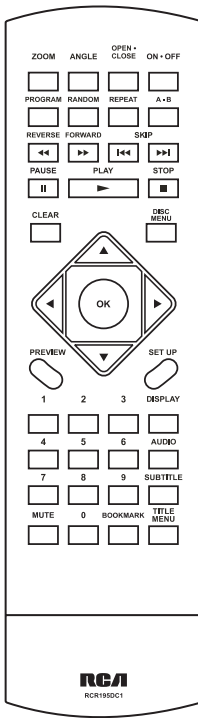

Install Batteries in the remote

- Insert two AA batteries, matching the polarity inside the battery compartment.

- Notes:**
- Do not mix different types of batteries or new and old batteries.
 - Do not use rechargeable batteries.
 - Dispose of batteries in the proper manner, according to federal, state, and local regulations.

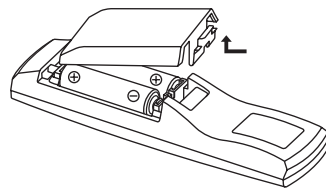

Basic Connection

DVD + TV

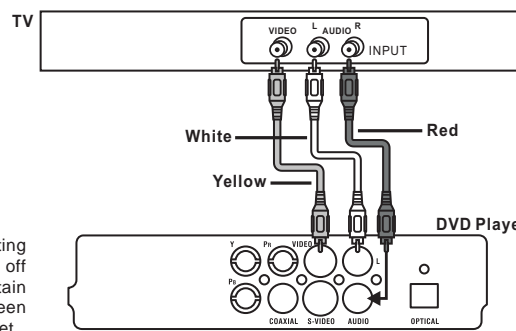

Note: Whenever you are connecting your system cables, turn off the power and make certain that the power cord has been removed from the wall outlet.

1. Connect the audio cables to the AUDIO OUT L and R jacks on the back of your DVD player and to the corresponding AUDIO INPUT jacks on your TV.
2. Connect the video Cable.
 - 2a. Basic connection – Connect the video cable to the VIDEO OUT jack on the back of the your DVD player, and to the VIDEO INPUT jack on your TV. **OR**
 - 2b. S-Video (not shown) – If your TV has an S-Video jack, connect the S-Video cable (not provided) to the S-VIDEO on the DVD to the S-VIDEO of your TV.

Note: If your TV doesn't have Audio and Video Input Jacks and only has an RF jack, you need to connect an RF modulator (not provided).

Other Options

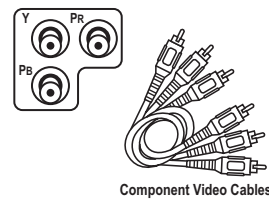

COMPONENT VIDEO OUT (Y, Pb, Pr) Jacks

The Y, Pb, Pr jacks provide excellent picture quality because the video signal is separated into three parts. To ensure maximum picture quality, use three video-grade cables (yellow) for the connection. You can also buy bundled component video cables that are color-coded to match the Y, Pb, Pr jacks (green, blue, red).

Note: Remember to connect the audio cables because the component cable carries only the picture signal, not the sound.

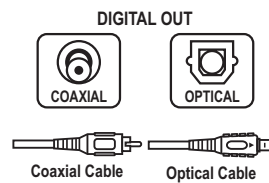

DIGITAL OUT COAXIAL/OPTICAL (Audio)

Use one of these jacks to connect your DVD player to a Dolby Digital receiver or decoder. Some receivers have either the Coaxial or Optical type of Digital Audio Input jack and some have both. Under most conditions, coaxial and optical connections work equally well—the only difference is the type of cable you connect to the jack.

Note: If the DVD player is connected to a DTS receiver through DIGITAL OUT and DTS track is selected, there will be no sound.

Basic Playback Operations

Turn on the DVD Player

1. Plug the power cord into the outlet once the DVD player is connected to your TV.
2. Turn on the TV and tune to its Video Input Channel, if necessary.
3. Press the ON/STANDBY on the DVD player or the ON•OFF button on the remote control to turn it on.
4. Press the OPEN/CLOSE button on the front of the player or remote control to open the disc tray.
5. Place a disc gently into the tray with the disc's label facing up (double-sided discs have content on both sides, so you can place the disc with either side up.)
6. Press OPEN/CLOSE again to close the disc tray. Play starts automatically. If a menu appears, one of its options can be selected to start playing the disc. Highlight it and press OK.
7. Press STOP to stop playback. The player remembers the point where disc was stopped. If you press PLAY again, playback resumes from this point. To stop playback completely or to start again from the beginning, press STOP twice. If the player is left in STOP mode for more than five minutes without any user interaction, the screen saver is activated.

Picture Scan

When you're playing a disc, each time you press FORWARD or REVERSE, your DVD player scans the disc faster until you reach the fastest scan speed. To resume normal playback, press PLAY or continue to press FORWARD or REVERSE.

Freeze Frame and Frame Advance

While a disc is playing, press PAUSE to freeze the picture. To advance one frame at a time, press PAUSE repeatedly. To resume normal playback, press PLAY.

Note: After approximately five minutes in PAUSE with no user interaction, the player goes into screen saver mode.

Slow Motion

While a disc is playing, press PAUSE. Press REVERSE or FORWARD (each time you press reverse or forward, the slow motion will get even slower until you reach the slowest speed). To resume normal playback, press PLAY.

Chapter/Track Advance

While a disc is playing, you can skip forward or backward a chapter or track at a time by pressing SKIP ◀ and SKIP ▶.

Note: Use the numeric buttons to directly access a specific track or chapter number. For single digit tracks or chapters, enter a 0 before single digit numbers; for example, enter 0, then 3 for chapter/track 3.

Zoom

While a disc is playing, press ZOOM (the player zooms in on the image). Each time you press ZOOM, the picture is magnified even more (until you get to the maximum zoom level). To see other parts of the picture when you've zoomed in on the image, try pressing the ◀, ▶, ▲ and ▼ buttons to go in corresponding directions. This feature is called pan and scan.

Note: Under Zoom function for JPEG file, press ZOOM button goes to Zoom 1x mode, then press REVERSE or FORWARD button repeatedly to select the zoom levels. Press ZOOM to quit the zoom mode.

Playing Discs

Compatible Discs



This DVD Player is capable of playing the following types of discs: DVDs, Audio CDs, Video CDs, and CDs with mp3 files, WMA files (Windows Media Audio), and JPEG files on them. Before you put a disc in the player, make sure it is compatible. You can't play the following types of discs: Laserdiscs, CD-I, CD-ROM (computer-only discs), DVD-ROM, or discs recorded using other broadcast standards (i.e., PAL or SECAM); CD-G discs.

Note: Some discs may not be compatible due to laser pickup, recording formats, and software used. Some technologies and methods used for mp3 file recording on CD-Rs can prevent optimal playback of these files on your DVD player by degrading the sound quality and/or the ability of the player to read the file.

Front panel Controls

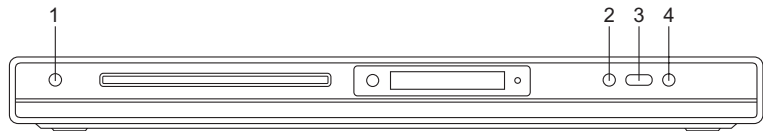

1. **ON/STANDBY** – Switches the appliance on and off.
2. **OPEN/CLOSE** – Opens and closes the disc tray.
3. **PLAY** – Starts playing a disc.
4. **STOP** – Stops disc playback.

This DVD player is designed and manufactured to respond to the Region Management Information. If the Region number of a DVD disc does not correspond to the Region number of this DVD player, this DVD player cannot play the disc. The Region number for this DVD player is Region No 1.

This product incorporates copyright protected by U.S. patents and other intellectual property rights. Use of this copyright protection technology must be authorized by Macrovision Corporation, and is intended for home and other limited consumer uses only unless otherwise authorized by Macrovision. Reverse engineering or disassembly is prohibited.

Manufactured under license from Dolby Laboratories. "Dolby" and the double-D symbol are trademarks of Dolby Laboratories.

Windows Media and the Windows logo are trademarks or registered trademarks of Microsoft Corporation in the United States and/or other countries.

Advanced Playback Features

Audio (Only for DVD, VCD)

Some discs have several audio tracks used for different languages or different audio formats. To change the language or audio format during play, press the AUDIO button one or more times to select one of the available audio formats or languages.

Note: This option is only available if the disc offers a number of languages or formats.

Bookmark

The Bookmark feature lets you mark a point on the disc so you can quickly start playing the disc from that location. The player stores bookmarks as long as the disc remains in the player and the unit remains on.

1. Press the BOOKMARK button during playback. (a menu is display)
2. To create a bookmark, select an empty bookmark using the ◀ and ▶ buttons and press the PLAY button.
3. Repeat step 2 as often as necessary.
4. To start playback from a bookmark, press the BOOKMARK button, select the bookmark using the ◀ and ▶ buttons and press the PLAY button.
5. To delete a bookmark, press the BOOKMARK button, select the bookmark using the ◀ and ▶ buttons and press the CLEAR button.
6. To exit the bookmark feature, press the BOOKMARK button.

Display

The Display appears across the top of the screen when you press the DISPLAY button on the remote while playing a disc. Press the DISPLAY button repeatedly to scroll through the playback information.

Preview

The Preview feature enables you to view contents of the disc on the screen. To preview the disc: 1. Press the PREVIEW button during playback.

2. Highlight the preview selection.
 - Digest: shows all the available contents. Input the number of the item you want to play using the numeric buttons and press OK to confirm.
 - Interval: shows all tracks in 10-minute intervals. Input the number corresponding to the interval where you want to start playback from and press OK to confirm.
3. Select NEXT to view the next page, MENU to return to the Select Digest Type menu, or START to begin playback.

Introscon (Audio CDs only)

This option plays the first five seconds of each track. Press PLAY to start playback, then the DISPLAY button to display the Single elapsed time and then the PREVIEW button to start the Introscon. Press PLAY to continue playing the current track.

Playback Control (PBC)

The Playback Control feature is available only on Video CDs. Press the TITLE MENU button to turn the PBC feature on and off. The Playback Control feature supports the menus of the VCD format similar to a DVD menu.

Playback Modes

Repeat Playback

While the disc is playing, press the REPEAT button repeatedly to select a play mode:

DVD play modes: Title repeat, Chapter repeat, off;

CD play modes: All tracks repeat, Track repeat, off;

A-B Repeat

To repeat a segment between two points (A and B), press the A-B button at the beginning of the segment you want to repeat. Allow the disc to play to the end of the segment or use FORWARD to advance to the end point (B). Press the A-B button again at the end of the segment. The segment plays repeatedly until you press A-B to resume normal playback.

Program Playback for all discs except WMA and mp3

With this option you can program the playback order.

- Insert a disc.
- In Stop mode, press the PROGRAM button. The Program menu appears.
- Use the number buttons to enter the title and/or chapter number (for DVD) or track number (for VCD and Audio CD). Repeat Step 3 as often as necessary.
- Use the ◀, ▶, ▲ and ▼ buttons to select Start.
- Press the PLAY button to start playback. Tracks are played in the order of the playback list. Playback stops once all tracks have been played.
- Press the STOP button to stop program playback. Press the STOP button twice or the OPEN/CLOSE button to cancel program playback.

Random Playback (VCD and Audio CD only)

All the tracks are played in random order (chosen by the DVD player).

- Insert a disc.
- In Stop mode, press the RANDOM button. (Random appears on the screen)
- Press the PLAY button to start random playback. Once all the tracks on the current disc have been randomly played, the player automatically stops playback.
- Press the RANDOM button again to stop playback. (Off appears on the screen)

mp3, WMA and JPEG Files

Playback of mp3, WMA and JPEG files

mp3 is an audio file format which compresses recorded music. It was developed in collaboration with **THOMSON**. The main advantage of the mp3 format is that it means CD-quality music can be stored on a personal computer in a user-friendly, compressed files.

WMA (Windows Media Audio) is another audio file format, developed by Microsoft.

JPEG files are image files (make sure they have a resolution of less than 5 megapixels.)

Note: The time taken for the contents of the disc to be displayed varies according to the size and number of JPEG files actually on the disc. If nothing is displayed after a few minutes, it is likely that certain files are too large. In this case, reduce the files' resolution to less than 5 megapixels and write another disc.

Before inserting a disc, check that is compatible with the player:

- Open the tray by pressing the OPEN/CLOSE button. Place a disc with the printed side facing up and close the tray. The disc's contents are displayed.
- Select a folder using the ▲ and ▼ buttons, then press OK to see the folder's contents.
- Select a file using the ▲ and ▼ buttons, then press OK to start playback.
- Press the STOP button to stop playback. To go back to the folder list, press the ◀ button in stop mode.

Note: During playback you can use the SKIP ⏮ or SKIP ⏭ button to go back to the previous file or go on to the next one.

Repeat Play Modes

- Press the REPEAT button repeatedly to select a play mode:
 - Repeat One: Repeats the current track until STOP button is pressed.
 - Repeat Folder: Repeats the current folder until STOP button is pressed.
- To cancel the repeat playback mode, press the REPEAT button until FOLDER appears on the TV screen.

Playing JPEG and mp3 music files at the same time

You can display JPEG files while listening to mp3 music files recorded on the same disc.

- Insert a disc containing the two types of file in the player.
- Select an mp3 music file using the ▲ and ▼ buttons, then press OK to confirm your selection.
- Select a JPEG image file using the ▲ and ▼ buttons, then press OK to confirm your selection.
- Press OK to start playback the two files at the same time. Press the STOP button to stop playback.

Programme playback (mp3 and WMA)

- Insert a disc. Use the ◀, ▶, ▲ and ▼ buttons to select the file you want to add to the playback list and press the BOOKMARK button. Repeat this step as often as necessary.
- Press the PROGRAM button to display the playback list and press PLAY to start playback. Files are played in the order of the playback list. Playback stops once all files have been played. To delete a file from the list, press the PROGRAM button, use the ▲ and ▼ buttons to select the file from the playback list and press BOOKMARK to delete it.
- Press the OPEN/CLOSE button to delete the playback list.

Troubleshooting

You can correct most problems you have with your product by consulting the Troubleshooting list that follows.

Player won't work or no power

- Try unplugging the AC power cord, wait two minutes, and plug it back in.

The remote control does not work

- Remember to point the remote control at the front of your player (towards the infrared remote sensor). Make sure there are no objects between the remote and the player.
- Maybe the batteries in the remote are weak, dead, or installed incorrectly. Replace the batteries and make sure the polarity of the terminals (+ and −) is correct.
- Operate the remote control at a distance of no more than 20 feet.

Disc won't play

- Insert a disc with the label side facing up.
- Check the type of disc you put into the disc tray. Refer to Compatible Disc section.
- Make sure the regional code of the disc is Region No. 1.

Forgot password

- Open the tray and press CLEAR, 0,0,0,0,1. Turn off DVD player and then turn it on by pressing the ON/OFF key, or you can unplug the unit, wait a few seconds and plug it in again.

Lock/Unlock DVD player

- To lock player, press SET UP, 0, 0, 0, 8, 3 (an on-screen message, "Key Lock On" is displayed).
- To unlock, press SET UP, 0, 0, 0, 8, 3.

Play starts, but then stops immediately

- The disc is dirty. Clean it.
- Condensation has formed. Allow player to dry out.

Picture format does not match the screen format

- The picture format is adjustable, refer to GENERAL SETUP menu section. Some discs dictate the format, in which case no adjustment is possible.

Picture is distorted

- The disc might be damaged. Try another disc.
- When using FORWARD or REVERSE buttons, it is normal for some distortion while scanning.
- Make sure you've selected the correct option for VIDEO OUT feature.

Sound problems

- If a TV is used, check whether the sound is muted or turned down low.
- You may need to read just the settings in the AUDIO menu.
- Sound is muted during still, frame advance, or slow-motion play.

Menu System

The DVD Player Menu System

The DVD Player Menu System is not the same as the disc menu. The DVD player menu appears when there is no disc playing.

To access the DVD player menus:

- Press the SET UP button to display the main menu.
- Select a menu icon using the ◀ and ▶ buttons.
- Use the ▲ and ▼ buttons to select one of the options in the menu.
- Press the ▶ button to access the submenu.
- Use the ▲ and ▼ buttons select one of the options in the submenu.
- Press OK to confirm your selection. Return to a previous menu using the ◀ button.
- To exit from the player menus, press the SET UP button repeatedly.

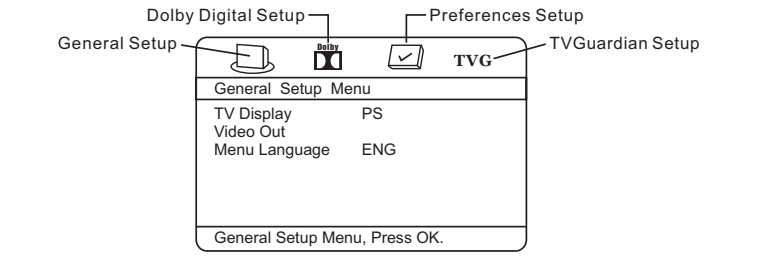

General Setup Menu (shown above)

TV Display

You can choose a display option that affects how a disc's content appears on your TV screen.

- Normal/PS (4:3 Standard): reproduces a 4:3 picture with some distortion.
- Normal/LB (4:3 Letterbox): gives best reproduction of pictures recorded in this format (i.e., with horizontal bands at the top and bottom of the screen).
- Wide Screen (16:9 Widescreen): reproduces 16:9 format films in full, on a 16:9 screen.

Video Out

Lets you choose between progressive scan and interlaced video output.

- YUV Interlace: Choose YUV Interlace if your TV uses the traditional technology known as interlace scan.
- YUV Progress: Choose this option if your TV has progressive scan and you have connected the DVD player COMPONENT OUT jacks to the COMPONENT IN jacks of the TV. Progressive scan gives you a sharper, cleaner picture.

Note: If the picture is lost while using progressive scan, you can toggle P-SCAN on and off by pressing the OPEN/CLOSE button simultaneously with PLAY button on the front panel of the player.

Menu Language

The Menu Lang feature enables you to set the preferred on-screen menu language: English, Spanish, or French.

Troubleshooting

Menu problems

- With a DVD: the disc menus are not displayed in your language. Read the disc jacket to see what languages are available on that disc. Choose one that suits you, if possible.
- With a DVD: there are no subtitles. Read the disc jacket to see if subtitles are available on that disc. Choose subtitles in a language that suits you if possible.
- If the player's setup menus are not displayed in the language you want, check that your language is among those listed in the MENU LANG menu. If necessary, choose another language.
- To clear a menu from the screen, press ◀ button or repeatedly press SET UP.

The invalid icon (Ⓢ) appears on screen

- The action cannot be completed at this time for one of the following reasons: the disc's software restricts it; the disc's software doesn't support that feature (e.g.,angles); the feature is not available at the moment; you've requested a title or chapter number that is out of range.

Ratings problems

- If you forget your password, go to "Forget Password" information in this section.
- The default language for dialogues and subtitles may be preset by the DVD.

Limited Warranty

What your warranty covers:

- Defects in materials or workmanship.

For how long after your purchase:

- 90 days from date of purchase – Unit exchange, which includes parts and labor.
- 91 days to 1 year from date of purchase – Unit exchange, which includes parts only; you pay the labor.
- The warranty for rental units begins with the first rental or 45 days from date of shipment to the rental firm, whichever comes first.

What we will do:

During the initial 90 days:

- Provide you with a new, or at our option, a refurbished unit. The exchange unit is under warranty for the remainder of the original product's warranty period.

After the 90 days and within one year:

- Provide you with a new, or at our option, a refurbished unit. The exchange unit is under warranty for the remainder of the original product's warranty period. We will bill you a flat exchange charge to replace a defective unit. This charge covers the labor cost for its repair.

How state law relates to warranty:

- Some states do not allow the exclusion nor limitation of incidental or consequential damages, or limitations on how long an implied warranty lasts, so the above limitations or exclusions may not apply to you.
- This warranty gives you specific legal rights; you also may have other rights that vary from state to state.

Menu System

Dolby Digital Setup Menu

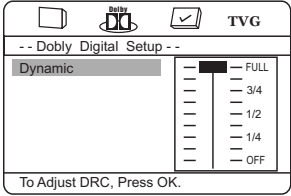

Preferences Setup Menu

The menu gives you options to change some aspects of your DVD player to fit your personal preferences.

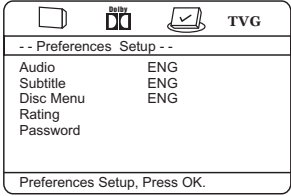

Dynamic

This feature monitors the audio track and controls the different sound levels via dynamic compression. It minimizes sudden volume increases such as when a commercial starts.

Select a range using the ▲ and ▼ buttons and press OK.

Audio:

Selects the dialogue language: English, French, Spanish, German, Italian, Swedish or Portuguese.

Subtitle:

Selects the subtitle language: English, French, Spanish, German, Italian, Swedish, Portuguese or Off.

Disc Menu:

Selects the disc's menu language: English, French, Spanish, German, Italian, Swedish or Portuguese.

Note: Discs are created differently. The DVD player cannot override some language preferences. If a disc's software was created to play the movie (title) in a perferred language, the preference you set might be ignored. Also, if the language is not available on the disc you are playing the disc's default language will be chosen. If the disc was not created with subtitles, you won't be able to use the Subtitle feature.

Ratings (Parental Control)

You determine the types of discs played and what types require a password to override the rating limit. Ratings are ranked from Level 1 to 8. Level 1 is least offensive material and Level 8 is most offensive. When adjusting Ratings for the first time:

- Press SET UP on the remote control to display the main menu.
- Select the Preferences menu and highlight Ratings. When asked to enter an old password, enter any number.
- Enter your new password; it is saved.
- Select Ratings and select a level.

Note: To enforce Rating Limits, the disc you're playing must contain a rated movie (or title).

Password

Password is not defined until you set it. Should you select a password and then forget it, go to the Troubleshooting section for instructions on resetting.

Note: There is a lock feature on your DVD player if you want to prevent your child from watching DVDs (don't forget to remove the remote control). Follow the directions for locking and unlocking in the Troubleshooting section.

Limited Warranty

How to make a warranty claim:

- Properly pack your unit. Include any cables, etc., which were originally provided with the product. We recommend using the original carton and packing materials.
- Proof of purchase in the form of a bill of sale or receipted invoice which is evidence that the product is within the warranty period must be presented to obtain warranty service. For rental firms, proof of first rental is also required.
- Also print your name and address and a description of the defect. Send via standard UPS or its equivalent to: **Thomson Inc., 11721 B Alameda Avenue, Socorro, Texas 79927.**
- Pay any charges billed to you by the Exchange Center for service not covered by the warranty.
- Insure your shipment for loss or damage. Thomson accepts no liability in case of damage or loss enroute to Thomson.
- A new or refurbished unit will be shipped to you freight prepaid.

What your warranty does not cover:

- Acts of nature, such as but not limited to lightning damage.
- Adjustment of customer controls.
- Damage from misuse or neglect.
- A unit that has been modified or incorporated into other products or is used for institutional or other commercial purposes.
- Batteries.
- Units purchased or serviced outside the U.S.A.
- Shipping damage if the unit was not packed and shipped in the manner prescribed by Thomson.

Product Registration:

- Please complete the online Product Registration on www.rca.com/productregistration or complete and mail the Product Registration Card packed with your unit. It will make it easier to contact you should it ever be necessary. The return of the card is not required for warranty coverage.

Limitation of Warranty:

- The warranty stated above is the only warranty applicable to this product. All other warranties, express or implied (including all implied warranties of merchantability or fitness for a particular purpose) are here by disclaimed. No verbal or written information given by THOMSON INC., its agents or employees shall create a guaranty or in any way increase the scope of this warranty.
- Repair or replacement as provided under this warranty is the exclusive remedy of the consumer. THOMSON INC. shall not be liable for incidental or consequential damages resulting from the use of this product or arising out of any breach of any express or implied warranty on this product. This disclaimer of warranties and limited warranty are governed by the laws of the state of Indiana. Except to the extent prohibited by applicable law, any implied warranty of merchantability or fitness for a particular purpose on this product is limited to the applicable warranty period set forth above.

If you purchased your product outside the United States:

- This warranty does not apply. Contact your dealer for warranty information.

Service calls which do not involve defective materials or workmanship are not covered by this warranty. Costs of such service calls are the sole responsibility of the purchaser.

Menu System

TVG Setup Menu

TVGuardian Setup	
TVG Mode	STR
Hell/Damn	OFF
Religious	OFF
Sexual	OFF
CC Mode	OFF
CC Channel	CC2
Setup Help	
Go To TVG Setup Page	

TVG Mode

You can select various levels of offensive language filtering.

Off.....No filtering.

Tolerant.....Filters only the most offensive foul language.

Moderate..... Increased standards for language filtering.

Strict.....filters out all common offensive language.

Word Subset Filtering

In addition to the main TV Guardian Modes listed above, you can turn certain word subsets on or off according to your preferences.

Hell/Damn.....Filters out variations of "Damn" and "Hell".

Religious.....Filters out reference to deity. (To watch religious programming, turn this word subset off.)

Sexual.....Filters sexually explicit language.

CC Mode

Off.....Captions are off.

On Mute (Default)..... Captions are displayed when offensive language is being filtered.

On Always.....Captions are displayed continuously.

CC Channel

To use the TVG captioning features while watching a DVD Movie, your television must be capable of displaying closed captions. Make sure that your TV CC is set to "CC1" or "CC2" (Close caption on channel 1 or 2), and that the CC channel on your DVD player is set to "CC1" or "CC2" respectively (CC2 is the default setting.)

About TVG iActivate function

1. Power on the unit, the following dialog shows, 'Start using your TVGuardian foul language filter today! Press the SET UP button and select TVGuardian to enable filter. This message will be displayed five times'.

2. Press SET UP, move the cursor to the tab "TVG" and press ENTER button. A dialog and display registration key appears. You can access the TVG Menu after entering the correct Activation Code.

Setup Help

Select this option and press OK to enter the Setup Help of TVG Menu to look for more information on TV Channel Selection and TVG Website address. Press OK to exit this option.