

PRO-2004 PROGRAMMABLE SCANNER GENERAL COVERAGE AM/FM MONITOR RECEIVER

PLEASE READ BEFORE USING THIS EQUIPMENT

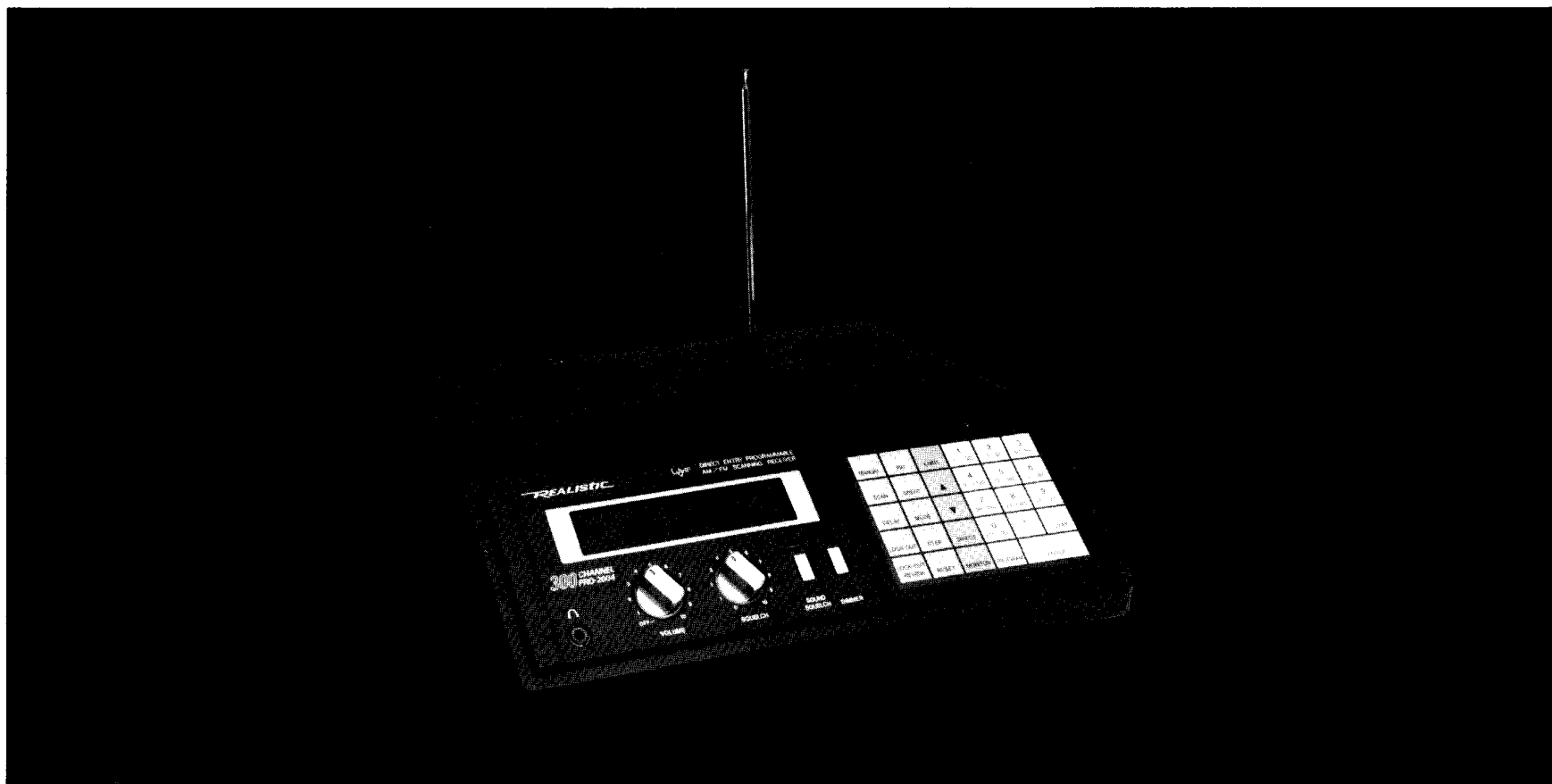



FEATURES

You'll hear all the action with your new **REALISTIC®** PRO-2004 Programmable Scanning Receiver! You'll have direct access to over 200,000 frequencies in nine action radio bands—police, fire, ambulances, aircraft, ham radio operators and transportation services in addition to normal FM broadcast, TV audio and CB operators! And you can program your PRO-2004 to scan up to 300 channels so you won't miss any of the excitement.

The secret to the PRO-2004 is a custom-designed microprocessor—a computer on a chip! The front panel keyboard lets you easily enter and change frequencies whenever you wish. The microprocessor also gives you special functions not found on other scanning receivers. Curious about what's on the air in your area? The PRO-2004 will automatically "search" frequency ranges of your choice for active stations—you can locate new stations and services easily! And if there's a frequency you're especially interested in, the PRIORITY key will make sure you never miss a call on it. While you listen or scan other channels, your PRO-2004 will automatically switch to the priority channel when a call is received on it!

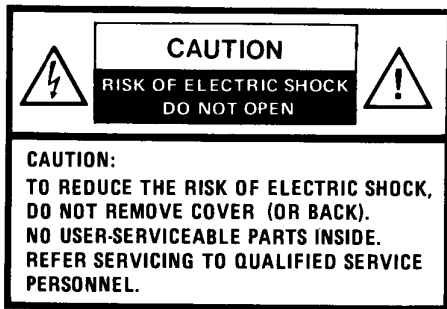
- Wide Frequency Coverage
 - 25 ~ 520 MHz
 - 760 ~ 1300 MHz
- Total of 300 channels for storing desired listening frequencies
- 10 frequencies located during search may be stored on channels in the Monitor Bank
- Up to 10 search ranges can be memorized
- Direct search function enables you to start a search from the displayed frequency on your scanner
- 10 scan banks—you may scan any or all banks as desired
- Lockout function lets the PRO-2004 skip over a specified channel(s). You can also check which channels are locked out
- Delay function holds the channel for 2 seconds after the transmission ends so you do not miss the reply
- Selectable scan, search speed
- Selectable mode (AM, NFM, WFM)
- Selectable search step (5kHz, 12.5kHz, 50kHz)
- Selectable priority—any channel can be made the priority channel
- Frequency delete function
- Direct permanent-memory store in search mode
- Memory backup
- Battery alarm beep
- Sound squelch function eliminates PRO-2004 to stop on a frequency without any signal
- Large multi-purpose LCD shows which channels and frequencies are being scanned, monitored or programmed as well as the status of the channels and the operation mode of the PRO-2004
- AC and DC (negative ground) operation
- Dimmer function
- Zeromatic function in search mode



 The lightning flash with arrowhead within the triangle is intended to alert the user to dangerous voltage inside this unit that can cause shock. Do not open enclosure.

 The exclamation point within the triangle is intended to alert the user to important operating and maintenance instructions in this owner's manual.

WARNING: TO PREVENT FIRE OR SHOCK HAZARD, DO NOT EXPOSE THIS RECEIVER TO RAIN OR MOISTURE.

For your own protection, we urge you to record the serial number of this unit in the space provided. You'll find the serial number on the back panel of this unit.

Serial Number

CONTENTS

A Quick Look at Your PRO-2004	4
Getting Started	6
Operating Your PRO-2004	7
Understanding the Display and Keyboard	7
Operating Modes	8
Programming Frequencies	8
Programming Hints and Tips	9
Scanning Frequencies	9
Locking Out Frequencies	10
Skipping Banks	10
Priority	10
Searching with Your PRO-2004	11
Limit Search	11
Direct Search	12
Band Mode and Frequency Steps	13
Using Delay	14
Storing Frequencies in Monitor Channels	14
Moving Frequencies from Monitor Channels to Permanent- Memory-Storage Banks	15
Delete Function	16
Birdies	16
Types of Signals You Will Be Able to Monitor	18
Maintenance	21
Specifications	22
Block Diagram	23

A QUICK LOOK AT YOUR PRO-2004

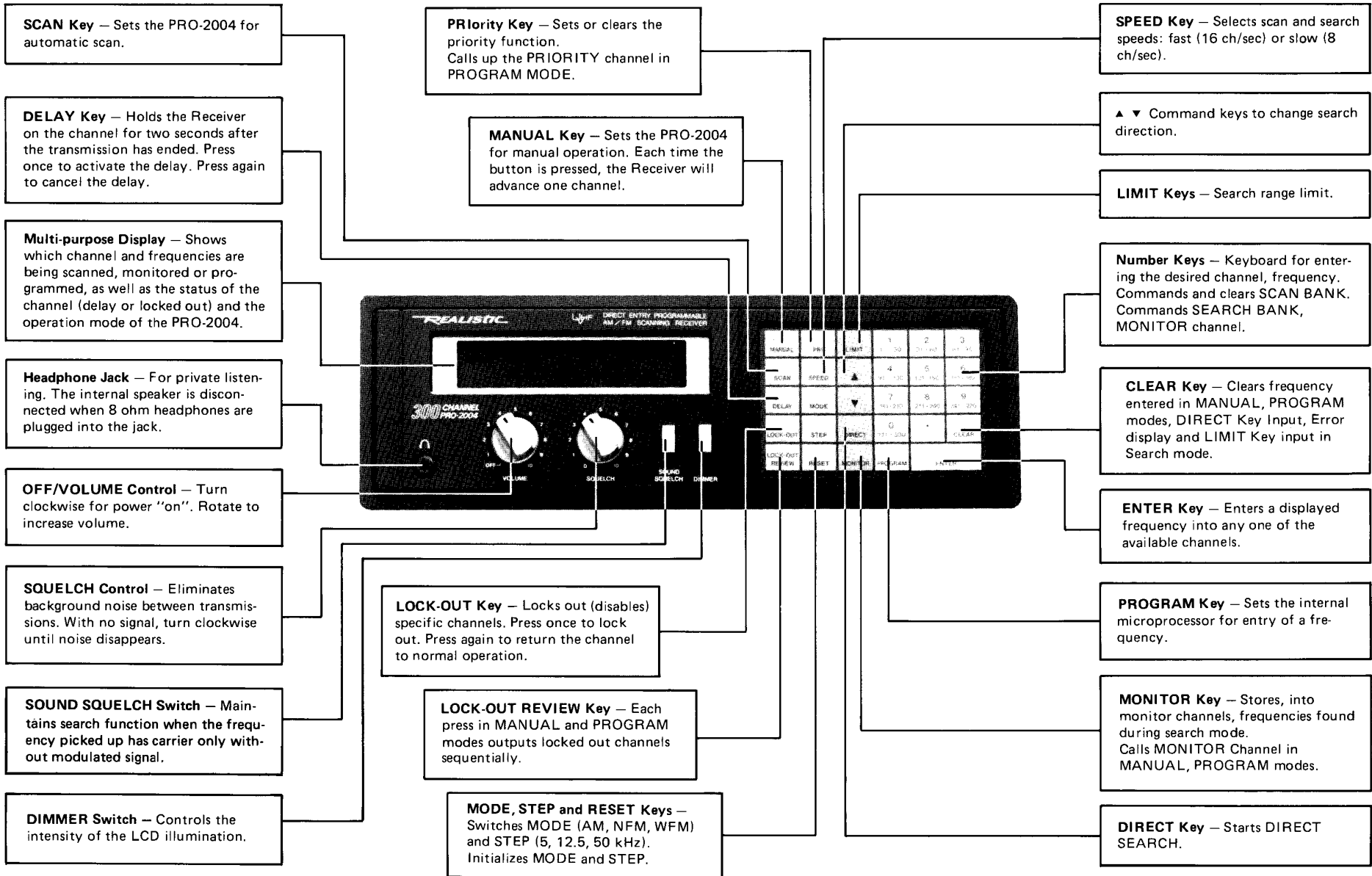

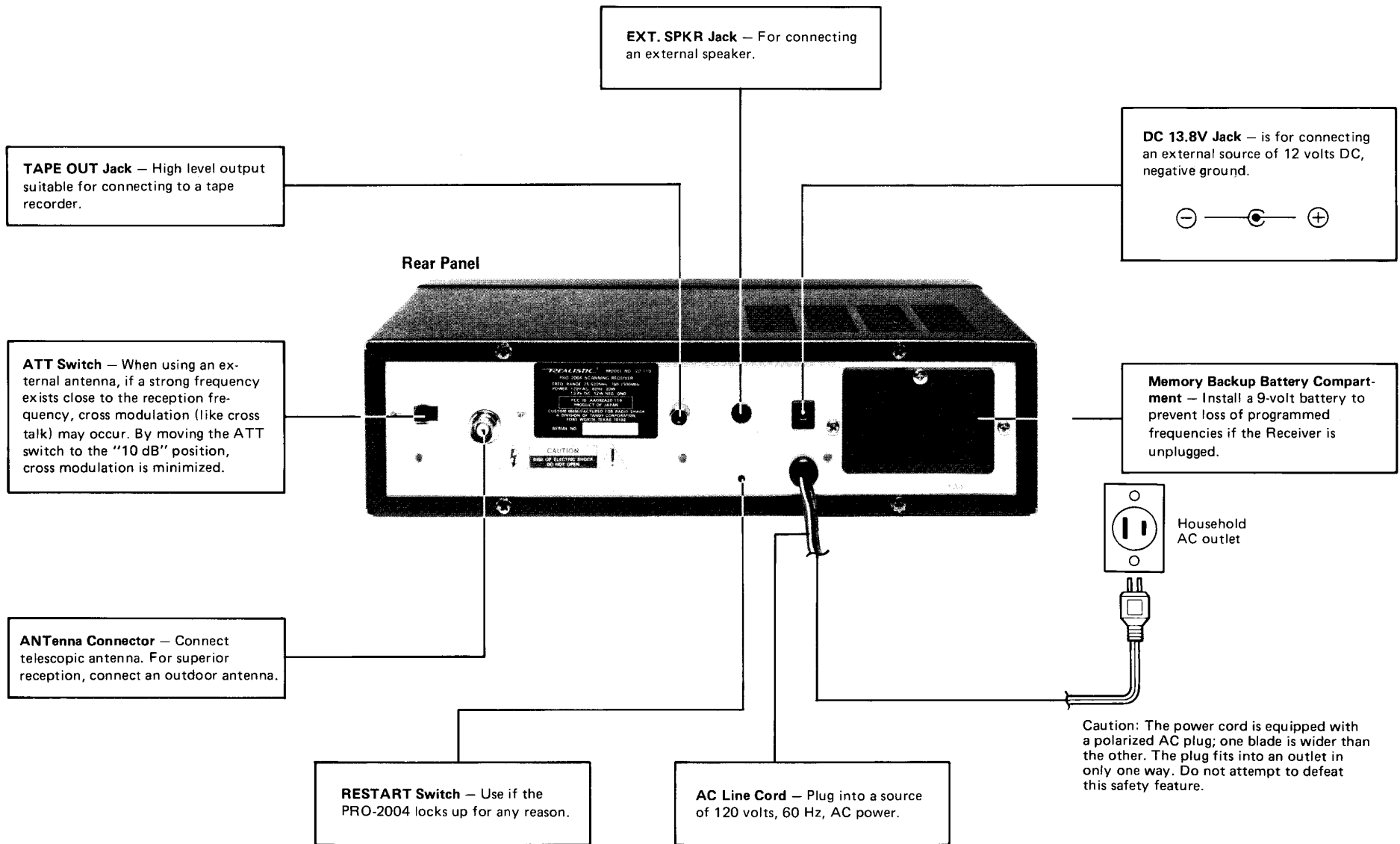

GETTING STARTED

Battery Installation

Loosen the screw on the panel and remove the battery compartment cover; then snap in a 9-volt battery. We recommend a Radio Shack long-life alkaline battery, 23-553 or equivalent. Your PRO-2004 contains an electronic memory to preserve the 300 programmed scanner channels. The battery protects this memory during a power failure, or when you need to temporarily unplug the set. For best results, replace the battery every six months.

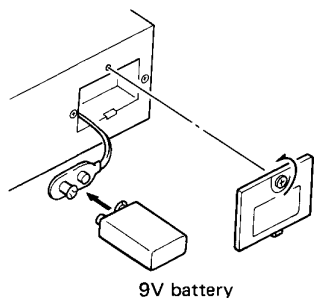

Your PRO-2004 can keep channels stored in its memory for a few minutes even with the AC cord unplugged and the 9-volt battery disconnected. When the 9V battery is weak or not even connected, the display shows **BATT** and an alarm beep will sound.

CAUTION: To avoid loss of program, do not unplug power cable when replacing battery.

In addition, never leave a weak or dead battery in your PRO-2004; even "leakproof" types can give off damaging chemicals. Battery life is about six months when either household AC or automotive DC power is off for a prolonged period.

AC Power Operation

Connect the AC power cord to a standard AC outlet.

Car Battery Operation

You can operate your PRO-2004 from a vehicle battery, provided it is a 12-volt, negative ground system.

To do so, use an optional DC power cable (Cat. No. 270-1534). Connect the plug of the power cable to the DC13.8V jack on the rear of the unit. Then plug the power cable into the cigarette lighter socket of your vehicle.

Caution: When the power cable is plugged into the cigarette lighter socket, be sure the other end does not touch any metal parts in your vehicle. To be safe, insert the plug into the DC13.8V jack on your unit before attaching the power cable to your cigarette lighter socket.

Antenna

Attach the telescopic antenna to the ANT connector. Align the protrusion on the connector with the notch on the antenna and rotate the metal portion until it is secure.

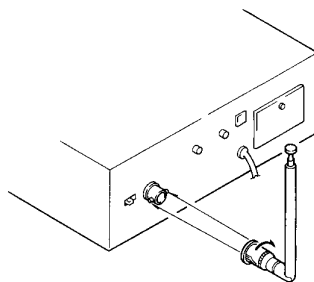

Antenna length has much to do with the sensitivity: adjust the length of telescopic antenna to optimum reception. Refer to table below.

25MHz – 300MHz:	extend fully
300MHz – 520MHz:	extend 3 segments
760MHz – 1300MHz:	collapse fully (one segment only)

For the very best reception, you'll need an external antenna. Your local Radio Shack has an excellent antenna for both VHF and UHF reception. You can also find mounting hardware, cables and connectors from Radio Shack, too. You'll find that reception improves the higher you mount the antenna.

WARNING WARNING WARNING

When installing or removing outdoor antennas, use extreme caution. If the antenna starts to fall, let it go! It could contact overhead power lines. **If the antenna touches the power line, contact with the antenna, mast, cable or guy wires can cause electrocution and death!** Call the power company to remove the antenna. Do not attempt to do so yourself.

RESTART Switch

If the LCD display or any key function becomes erratic when you are using your PRO-2004, press the RESTART switch with a ball-point pen.

The frequency etc. programmed when the key function is erratic will be cleared and unit reverts to initial mode. Some of the PRO-2004 functions revert to default setting.

Priority: Channel 1
Monitor: Channel 1
Search Bank: Bank 1
Scan Bank: All turned on

Headphone

Headphone jack is provided. When you connect the headphone, the internal speaker will be automatically disconnected.

EXT Speaker

An external speaker can be connected to EXT SPKR jack, which will disconnect the internal speaker.

TAPE Out

To record reception, connect your Tape Recorder to the TAPE OUT jack.

OPERATING YOUR PRO-2004

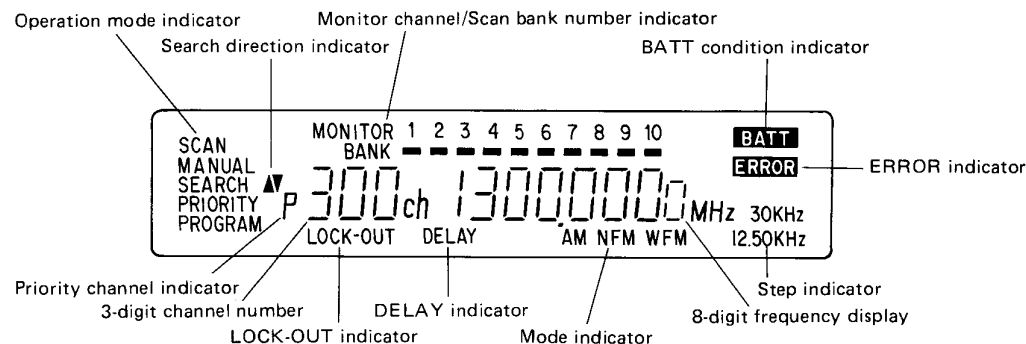

Turn on your PRO-2004 by rotating the OFF/VOLUME clockwise. When first turned on, your PRO-2004 might start scanning. Rotate the SQUELCH fully counterclockwise. You'll hear a rushing noise from the speaker – if not, rotate the VOLUME control a little further clockwise – and the scanning will stop. Slowly rotate the SQUELCH clockwise until the noise stops and scanning resumes. You are now ready to start entering frequencies.

Understanding the Display and Keyboard

The liquid crystal display (LCD) on your PRO-2004 displays the channel number, the frequency being received, status of different functions,

DELAY or **LOCK OUT**, and current operation mode. The illustration shows the location of the symbols. As they move on and off the display, you can note the current operation mode. **On the display**, the line under the bank number shows you which bank you are working with. The numerals below the bank number **on the keyboard** show you the channel numbers in each bank. Bank 1 holds channels numbered 1 through 30, bank 2 holds 31 through 60, and so on through bank 10, which holds the channels 271 through 300.

BATTERY Indicator

When the memory backup battery power becomes low, the **BATT** indicator appears on the display and the PRO-2004 gives off a beeping alarm sound. Replace the battery promptly.

ERROR Indicator

Sometimes when you try to enter a frequency for a channel or as a search range limit, you will find an **ERROR** on the display and hear three beeps. This means the frequency chosen is in error and you won't be able to enter it into your PRO-2004.

Such frequency errors usually mean you've attempted to enter a frequency outside the range of your PRO-2004, such as 550.000 MHz or you've put the decimal point in the wrong place, for example, 14.682 MHz instead of 146.82 MHz. Check your entry carefully and then press **CLEAR**. You can now enter the correct frequency.

The **ERROR** indicator also appears when you try to enter channel number outside the limits of the PRO-2004, such as channel 500.

About those Banks . . .

The PRO-2004 has ten banks for continuous storage, plus an eleventh bank for temporary storage. Think of it this way: it's like storing gold in a bank. You have so much gold that one safety deposit box cannot hold it all. So you rent additional safety deposit boxes. When you have filled all the boxes in one bank, you put the excess into another bank.

Now, suppose you are still searching for additional gold. If you are undecided about the disposition of a gold strike, whether to store it or to spend it, you can place it in a special services bank for temporary storage.

Permanent-Memory Storage Banks

Your PRO-2004 has a comparable storage system for radio frequencies. It has 10 banks and each bank has 30 storage compartments (like safety deposit boxes) which are called **channels**. Into each bank, you can safely deposit as many as 30 frequencies. Because there are 10 banks with 30 channels each, you can ultimately store a total of 300 frequencies. The smaller numbers on the keyboard indicate which channels are allocated to each bank. **When the frequencies have been stored, you can scan the banks to find a specific channel.**

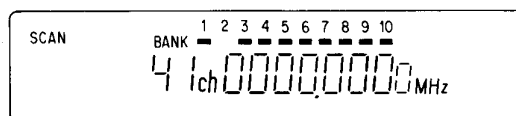

Temporary-Memory Storage Bank

In the search mode, when you discover a new frequency, you can place it in the temporary storage bank. Think of this eleventh bank, special services bank, as the **MONITOR Bank**. It not only helps you, in a rapid search, store new frequencies, it also performs rapid transfer to the any of the other ten banks. On the display, **MONITOR** indicates that you are using this bank. When in the monitor mode, the ten numbers at the top of the display represent ten channels in which newly-discovered frequencies may be stored temporarily.

Note: Monitoring can only be accomplished in conjunction with "search." See "Storing Frequencies in Monitor Channels."

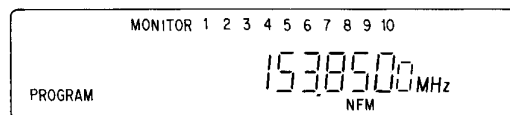

The blinking number is the MONITOR channel in use.

Search Bank

The PRO-2004 has 10 search banks for setting the lower limit or upper limit of the search range. The display shows the search bank numbers.

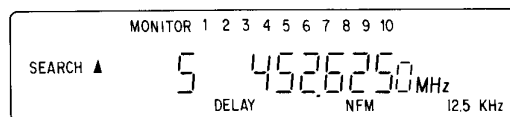

Operating Modes

The PRO-2004 has four separate operating modes:
programming · manual · scanning · searching operation.

Programming Frequencies

Programming the PRO-2004 is as simple as 1-2-3 as follows.

1. Select the desired channel.
2. Press **PROGRAM** to enter the programming mode.
3. Enter the desired frequency with the keypad and press **ENTER**.

Note: If you are uncertain about specific frequencies in your locale, Radio Shack's "Police Call Directory Including Fire & Emergency Services" is an excellent reference.

Example:

To program 162.55 MHz into channel 30
Select the channel in one of three ways:

Step 1.

- a. Press **MANUAL**. Continue pressing until the display shows channel 30. Release the button.
— or —
- b. Press **3 0 MANUAL**.
In either case, press **PROGRAM** to enter the programming mode:
— or —
- c. Press **PROGRAM**.

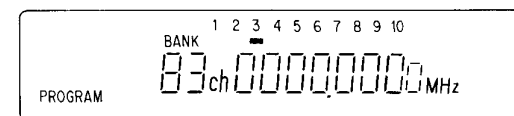

Press **3 0** .

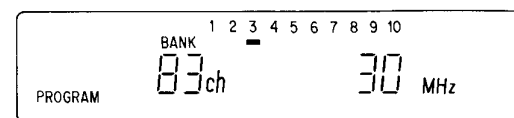

Press **PROGRAM**.

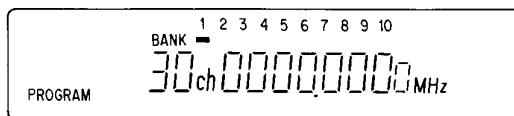

Step 2.

Press the keys 1 6 2 . 5 5

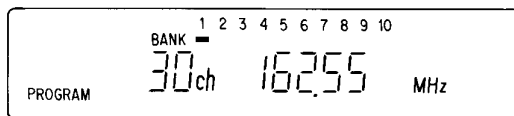

Step 3.

Press **ENTER**

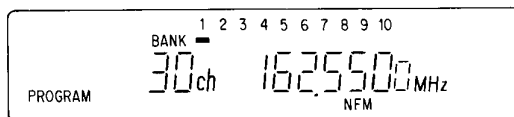

To program the next frequency, move to another channel in this way. Press **PROGRAM** to advance to the next channel.

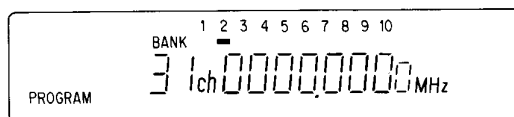

Repeat the same steps to add more frequencies.

Hints and Tips for Programming

If you make a mistake while entering a number, press **CLEAR** and re-enter the correct frequency. If you enter a frequency that is outside a PRO-2004 band range, the ERROR indicator lights along with a beeping sound. Press **CLEAR** and select another frequency. Any

frequency within a PRO-2004 band range will be accepted. However, the frequencies that can be stored into PRO-2004 memory are in either 5 kHz steps or 12.5 kHz steps. The scanner will automatically round off the entered frequency to the closest valid frequency. For example, if you enter 125.2345 MHz, the PRO-2004 will accept this entry as 125.2300 MHz. The entry 398.2640 MHz will be treated as 398.2625 MHz. The tuning range of your PRO-2004 is permanently stored in the microprocessor chip and external memory. It cannot be extended or altered. So if you try to enter a frequency not in the PRO-2004 tuning range, you'll always get an error message. If you want to change the frequency entered for a specific channel, enter the new frequency over the old one, following the steps under **Programming Frequencies**.

Manual Mode

When you want to stay on a frequency, either in scan mode or search mode, press **MANUAL**. In the manual mode, you can manually advance through the memory channels by pressing **MANUAL** repeatedly. Or enter the channel number and press **MANUAL** to reach the desired channel directly. Also note that in manual mode you can access locked out channel(s) or skipped bank(s).

Scanning Frequencies

Your PRO-2004 will automatically scan all the channels you have programmed and stop whenever it finds a signal.

Important! Your PRO-2004 won't scan unless SQUELCH is set to the point where no "hiss" sound is heard between transmissions.

To stop scanning, press **MANUAL**. You then can select a specific channel you want to listen to. Enter the channel number, then press **MANUAL**. Or press **MANUAL** and continue pressing until you reach the frequency you want.

Delay

In the scanning mode, your PRO-2004 will stop when it finds a channel with a signal. As soon as signal stops, it immediately begins scanning other channels. Since most transmissions are part of a two-way communication, you may wish to press **DELAY** when you wish to continue listening to a specific channel.

Press **DELAY** when you wish to hold a channel you are listening to.

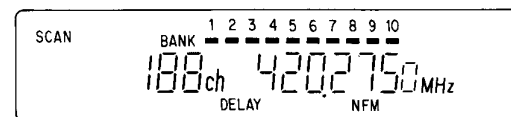

Your PRO-2004 will then hold the channel at least two seconds after each transmission, giving you time to listen to both sides.

DELAY appears on the LCD to show that the delay function is engaged for that channel. To cancel the delay function, press **DELAY** again. The display indicator disappears.

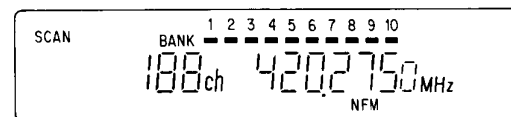

Forced Scan

Scan stops when a signal is picked up on a frequency. However, if you wish to re-initiate scanning, press **SCAN** to forcibly begin scanning.

Speed Selection

When the power switch is turned on, the scanning rate is set to 16 channels/second. Pressing **[SPEED]** alternates the scan speed between 8 channels/second and 16 channels/second.

Locking Out Frequencies (Skipping Frequencies)

You might want your PRO-2004 to skip certain frequencies while it's scanning (such as continuously transmitted weather broadcasts). To lock out such channels:

1. Press **[MANUAL]** to stop scanning.
2. Continue pressing **[MANUAL]** until you reach the channel you want to lock out. If you know the channel number(s), this can be done more quickly. Enter the channel number, then press **[MANUAL]**.
3. Press **[LOCK-OUT]**. The indicator appears on the display, indicating this channel will be skipped during scanning.

Note: In manual scanning, you can continue to access the locked out channel(s).

To cancel the lockout function:

1. Press **[MANUAL]** to stop scanning.
2. Advance to the channel that is locked out.
3. Press **[LOCK-OUT]** again. LOCK-OUT disappears from the display.
4. Or, press **[LOCK-OUT REVIEW]** in MANUAL or PROGRAM mode to call out locked out channels one by one. Then, press **[LOCK-OUT]** to cancel LOCK-OUT for that channel.

You can lock out as many channels as you like. But each bank must have at least one channel not locked out. The last channel in a bank cannot be locked out.

Skipping Banks

At initial "power on," all the banks are available to be scanned. You can skip one entire bank while scanning. This is convenient when there are no frequencies entered in the bank, so there is no need to scan through it. **Do not use the LOCKOUT key to skip banks.** Instead, follow this procedure:

Turn power on, and in the SCAN mode, press the number key that corresponds to the bank to be skipped.

Example: To skip banks 4, 5, 9, and 10

Press **[4] [5] [9] [0]**.

Note that you enter "0" for bank 10.

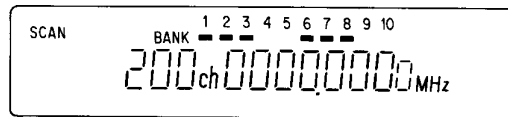

The corresponding bank number indicator disappears from the display and the entire bank is skipped.

Press the number key again to restore the bank.

Example: To restore scanning banks 4 and 5

Press **[4] [5]**.

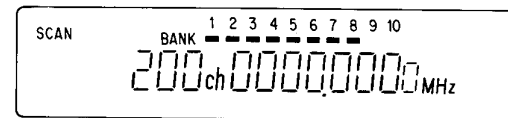

Each number on the keyboard has figures; these figures show the channel numbers that are allocated to that particular bank. As with the lockout function, you cannot skip all the banks. The "last" bank cannot be skipped.

Priority

You may scan other channels and still not miss a transmission of special interest to you (police, fire, ambulance, etc.). If a call is received on the priority channel while you are scanning other channels, your PRO-2004 will automatically switch to the priority channel.

Programming the Priority Channel

At initial "power on," channel 1 is automatically designated as the priority channel. So if you enter a frequency of particular interest in channel 1, you need not do anything further. But, if you want to use another channel as the priority channel, press **[PROGRAM]**, enter the channel number and press **[PRI]**. Only one channel can be set as the priority channel. If you enter a new priority channel, the previous channel chosen is automatically cleared.

Example: To set channel 20 as priority

Press **[PROGRAM]**.

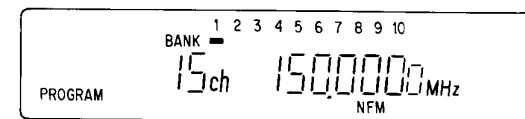

Press the channel number **[2] [0]**.

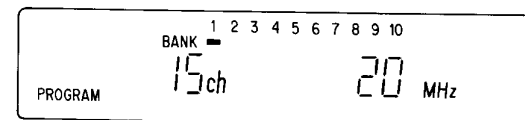

Press **PRI**.

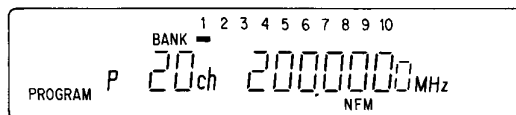

You can verify the priority channel by pressing **PROGRAM** then **PRI**. The P on the display will light when you scan the priority channel. Press **PRI** again to revert to previous channel.

Using Priority

The priority function is available only in scan or manual mode. press **PRI** to activate it. PRIORITY appears on the display.

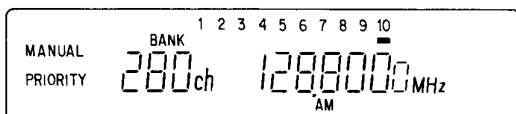

The Receiver will check the priority channel and switch to it if a signal is present.

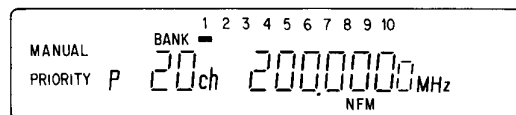

To cancel priority, press **PRI** again. PRIORITY disappears from the display.

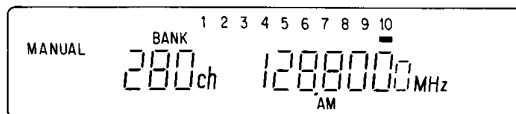

Note: All the settings of delay/lockout/speed/priority mode/step/skipping banks are retained even when you turn power off. The next time you turn the power on, the same settings, as when you turned the PRO-2004 off, are in effect.

Searching with Your PRO-2004

Limit Search

To search for a transmission within a specific range of frequencies, press **PROGRAM**, enter the limits of frequency range, and press **▲** or **▼** to activate "search." You can command up to 10 frequency ranges into a search bank. Lower limit 25 MHz and Upper limit 1300 MHz are initially set in Search bank 1 ~ 10.

Press **PROGRAM**.

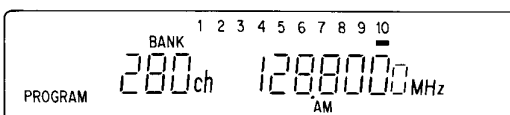

Select a search Bank with numeric key 1 ~ 10 and press **LIMIT**. Enter 0 for search bank 10.

Example: To search in Bank 5 between 452.625 and 452.915

Press **5** **LIMIT**.

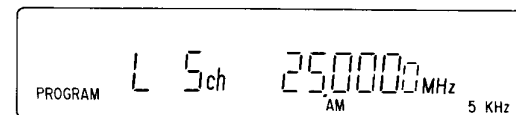

Enter the lower limit of frequency range to be searched.

Press **4** **5** **2** **•** **6** **2** **5** **ENTER**.

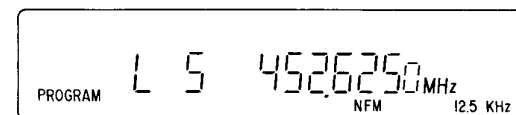

Press **LIMIT**.

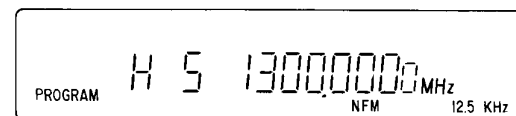

Enter the upper limit of frequency range to be searched.

Press **[4]** **[5]** **[2]** **[.]** **[9]** **[7]** **[5]** **[ENTER]**.

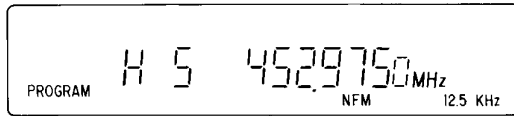

Activate "search" by pressing **[▲]** or **[▼]**. **[▼]** starts search from the highest frequency and goes down. **[▲]** moves in the opposite direction.

Note: If search does not start after pressing **[▲]** or **[▼]**, try adjusting SQUELCH.

Press **[▲]**.

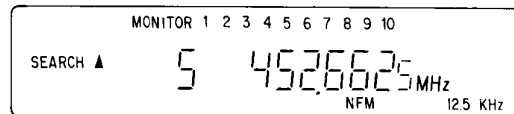
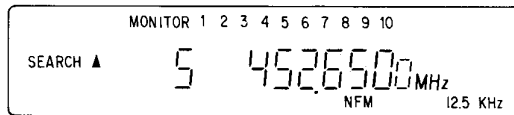
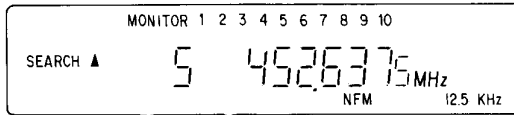
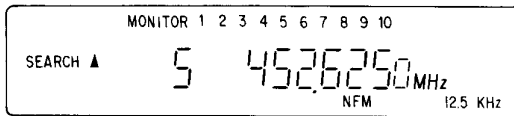

Press **[SPEED]** to accelerate or to slow down the search.

Note: You can program LIMIT frequencies and STEP as you like, but SEARCH may not necessarily work right under certain conditions.

Example: If you select a range of 100.005 and 100.045 using step equal to 50 kHz

Set 100.005 MHz lower limit

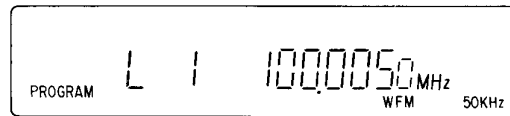

Set 100.0450 MHz upper limit



Note that when above frequency range and STEP of 50 kHz are set, frequencies which correspond with the STEP are not usable. This is due to the fact that the **difference** between the upper and lower limits selected is **LESS** than the step frequency of 50 kHz.

In this situation, if you press **[▲]**:

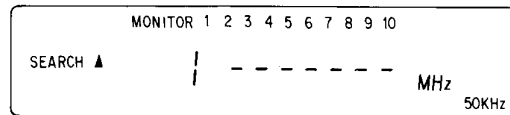

Press **[PROGRAM]** → **[LIMIT]** to extend the LIMIT frequency range.

DIRECT Search

In **MANUAL** or **PROGRAM** operation mode, press **[DIRECT]** and then **[▲]** or **[▼]** to search up or down from the displayed frequency.

Press **[PROGRAM]**.

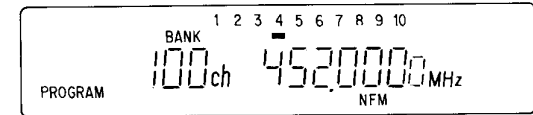

Press **[DIRECT]**. The step frequency is displayed.

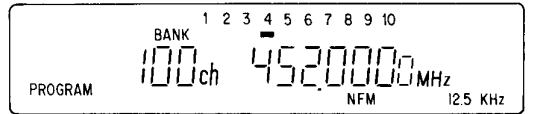

Press

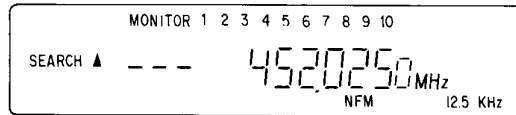
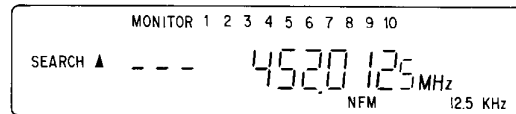
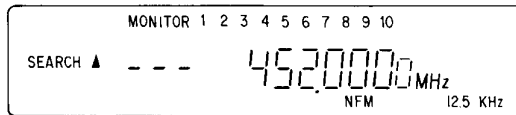

Note: When **DIRECT** is pressed during limit search, the PRO-2004 enters DIRECT search. When a numeric key (1, 2 . . . 0) is pressed during a DIRECT search, it goes to limit search through the search bank corresponding with the numeric key.

Forced Search

Search—whether limit or direct—stops when a signal is picked up on a frequency. When the frequency is not the one desired, press or to continue the search.

Band Mode and Frequency Steps

Your PRO-2004 is designed to adjust itself for the band modes and scanning/searching steps for each frequency range, as shown in the table below.

FREQUENCY VS. MODE & STEP			
FREQUENCY (MHz)	MODE	STEP (kHz)	
25.000 ~ 29.995	AM	5	
30.000 ~ 87.495	NFM	5	
87.500 ~ 107.995	WFM	50	
108.000 ~ 135.995	AM	12.5	
136.000 ~ 224.995	NFM	5	
225.000 ~ 520.000	NFM	12.5	
760.000 ~ 824.995	NFM	12.5	
825.000 ~ 844.995	NFM	30	
845.000 ~ 869.995	NFM	12.5	
870.000 ~ 889.995	NFM	30	
890.000 ~ 1300.000	NFM	12.5	

WFM: Wideband FM for normal FM broadcast or TV sound.

NFM: Narrowband FM for action radio bands, police, fire, ambulance, ham radio, etc.

AM: For aircraft band, CB, etc.

To see how it works, try searching the range of 85 – 110 MHz.

Press **PROGRAM** **1** **LIMIT** **8** **5** **ENTER**. The bottom line of the display shows NFM mode and 5 kHz step, which is the assigned band/step for 85 MHz.

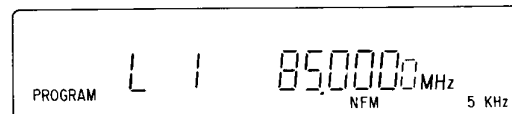

Press **LIMIT** **1** **1** **0** **ENTER**. The 110 MHz is AM aircraft band range, so the bottom line changes to AM 12.5 kHz.

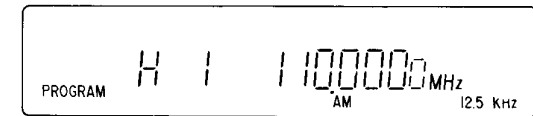

Press to start search and watch the bottom line — as you press it changes to NFM 5 kHz. When the search reaches 87.5 MHz, which is normal FM broadcast band, the bottom line changes to WFM and 50 kHz.

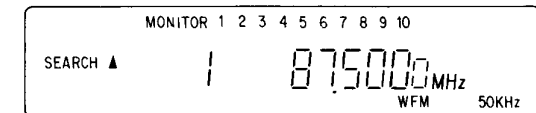

It further changes to AM 12.5 kHz when the search passes 108 MHz.

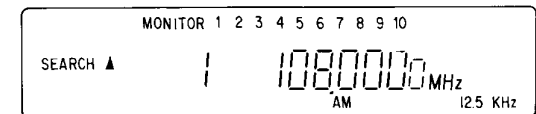

Normally, the preset mode/step works as indicated within each band. However, for a part of the ham radio band, the aircraft band outside the 108 – 136 MHz and the TV audio, you will have to change the mode and/or steps manually.

To do this, use the MODE and STEP switches. To change mode, press [MODE]. Each time you press it, the mode changes in the order of AM – NFM – WFM. To change steps, press [STEP]. The step changes in sequence 5 kHz – 12.5 kHz – 50 kHz. Note that when you change the preset mode/steps, the corresponding display flashes to show you that you changed the default setting.

When you want to return to the default setting, press [RESET]. The display stops flashing.

Keep in mind that the improper setting of the mode/steps can result in poor reception. When you listen to an FM broadcast or TV sound in the NFM mode, the sound will be much distorted. If you hear a police band in WFM mode, the sound will be masked by noise. Or if you use 5 kHz or 12.5 kHz step to search FM broadcast or TV sound, the search may stop on the sideband of a frequency: press [▲] or [▼] to get the center frequency. If you use 50 kHz step for NFM band, you may miss the in-between frequencies of 50 kHz step.

Limit search break frequency memory

When limit search breaks in manual, program, scan, direct search, etc., the break frequency is memorized, and resumes the limit search from that frequency.

Note: When lower or upper limit of a limit search is changed, and if the break frequency is within the limit frequency range, the search starts from the break frequency. If the break frequency is out of the new limit frequency range, the search starts from the lower or upper limit frequency.

Zeromatic function

Your PRO-2004 incorporates a Zeromatic circuit to receive correct frequencies during search. However, if during search in the VHF/UHF TV band, it accepts the side band frequency of TV sound; set the mode to WFM, step to 50 kHz or press [▲] or [▼] to receive correct frequencies.

The Zeromatic circuit may not work correctly when 5 kHz step search takes place in the 760 MHz to 1300 MHz band.

Using Delay

Search stops when a signal is picked up on a frequency. As soon as the signal ends, searching resumes. Most transmissions are part of a two-way communication. Delay allows for pause between transmissions.

Press [DELAY] when you wish to remain tuned to a frequency. Your PRO-2004 will hold the frequency at least 2 seconds after each transmission – giving you time to listen to both sides of the transmission.

Press [DELAY].

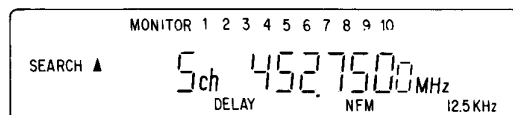

To cancel the delay function, press [DELAY] again.

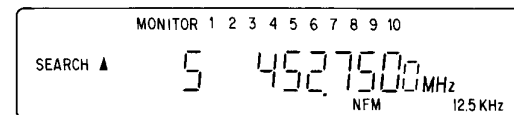

Storing Frequencies in Monitor Channels

Your PRO-2004's Temporary-Memory Storage Bank has 10 monitor channels. During search, you can store one frequency into each channel.

1. To search for transmissions, press [PROGRAM]. The 10 numbers at the top of the display now function as channels in which new frequencies may be placed for temporary storage. Enter limits of frequency range, and press [▲] or [▼] to activate "search."
2. When the search stops on a frequency you want, to store it press [MONITOR]. This freezes search, and records the frequency in one of the 10 monitor channels.
3. LCD displays (MONITOR "1" 2 3 4 5 6 7 8 9 10) Channel number to be stored flickers.
4. Press [▲] or [▼] to resume searching. If you find another frequency of interest, press [MONITOR] again to store it in the next monitor channel. Repeat the above to store the additional frequencies in the monitor channels, 1 through 10. If you try to store frequencies in more than 10 channels, the channel cycles back to 1, and you will write the new frequency over the old one, and the old frequency will be erased.

Moving Frequencies from Monitor Channels to Permanent-Memory-Storage Banks

You can move a frequency from a monitor channel to permanent storage by simply pressing **ENTER**. There is no need to record each frequency and re-enter it, one by one.

All that is necessary is to select the channel in which you wish to store the newly-found frequency now in temporary storage. Then, recall the monitored frequency to the display. Next, press **ENTER** to store the frequency in permanent memory.

Example: To transfer 95.100 from temporary bank to Bank 9 permanently

1. Press **PROGRAM**. Press the channel number you want to use. Then press **PROGRAM** again.

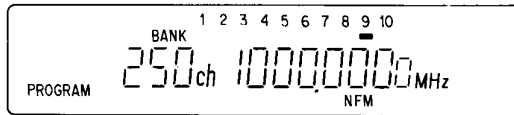

2. Press **MONITOR**. The display shows the monitor channels. The last monitor channel entered and its frequency is displayed.

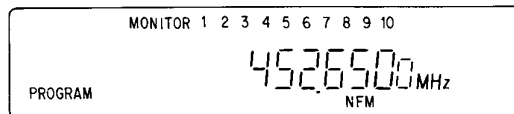

3. Press **MONITOR** as many times as required to arrive at the monitor channel that contains the frequency you want moved to permanent storage. Or, because you are now in the monitor mode, you may use the keyboard to select the number of the monitor channel. You will see the frequency that you want moved on the display.

Press **2**.

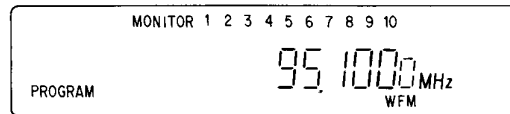

4. Press **ENTER**. This transfers and stores the frequency into the chosen permanent-memory channel.

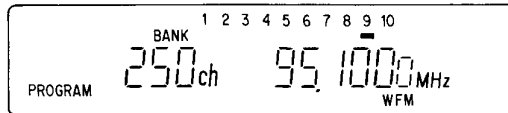

5. If you want to store more frequencies, select another memory channel by keying in the number and **PROGRAM**. Then follow step 2 through 4 above. The frequencies in the monitor channels will remain unchanged until you wish to search for, and enter, new frequencies. When you wish to verify the transfers, return to the permanent memory display by pressing **MANUAL**. The display shows you have returned to the normal mode. The word, **BANK**, appears at the top of the display. Press channel number and **MANUAL** for checking the memory content of a specific channel.

To store a frequency into the permanent-memory channel during Search mode

1. Use **MANUAL** or **PROGRAM** to select an open channel or a channel which has a frequency that you no longer want stored. For example, suppose you select channel 260.

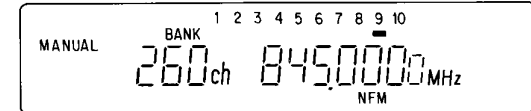

2. Press **▲** or **▼** to start search.

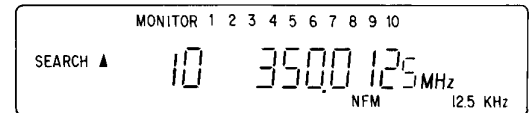
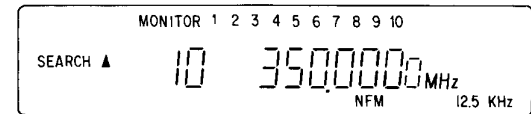

3. When you arrive at the frequency you want to store, press **MONITOR**. The permanent memory channel will be displayed (channel 260).

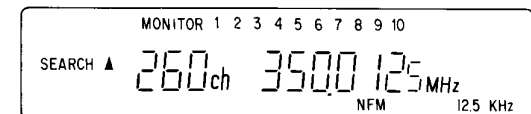

4. Press **ENTER** and channel 260 stores 350.0125 MHz, and automatically starts search. Then, the permanent-memory channel advances by one step.

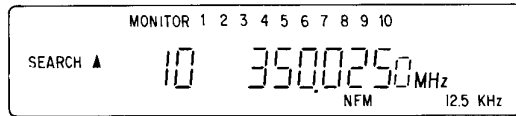

5. To store another frequency into the permanent-memory channel, repeat steps 3 and 4. e.g. Press **MONITOR** **ENTER** and store 350.1625 MHz into channel 261.

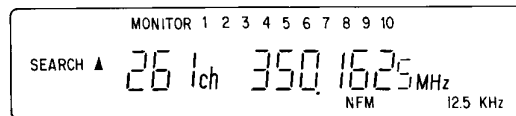

Note: By repeating MONITOR – ENTER you advance the permanent memory channel and at the same time, you store the new frequencies. Any previously stored frequencies are written over. So, to be sure before you proceed, you should check and review the frequencies already stored.

Sound Squelch

Even when the PRO-2004 stops at a frequency during either scan, search or priority modes, sound squelch enables the operation to start again if the frequency contains no sound, i.e. carrier only without modulated signal.

1. Press SOUND SQUELCH Switch, the LED lights.
2. When the PRO-2004 stops at a frequency which has no sound, it remains there for 0.5 seconds, and then goes to the next frequency if no sound is not detected within that time.
3. When a frequency which contains sound is received, it halts at the frequency. But,
 - a. If the sound ceases during the reception, it stays on the frequency for 5 seconds, and resumes scanning.
 - b. If the frequency stops sending a carrier, the unit reverts to scan immediately if DELAY is off, after 2 seconds, if the DELAY is active.
4. To cancel sound squelch, press SOUND SQUELCH switch again. The LED goes off.

Note: If a frequency contains a transmission with low modulation, the sound squelch circuit may not work properly.

Deleting frequency

To delete channel frequency display (zero display).

Press **PROGRAM** → **0** → **ENT**

Clearing Entire Memory

To clear all memories, press and hold **CLEAR**. Then press the RESTART switch on rear panel, with power switch on.

Birdies

“Birdies” are the products of internally generated signals that make some frequencies difficult or impossible to receive. If you program one of these, the Receiver locks up and you’ll hear only noise on that frequency. If the interference is not severe, you might be able to rotate SQUELCH clockwise to cut out the birdie. The most common “birdies” to watch out for are listed on next page.

Birdies Frequencies

29.6350MHz	350.0000MHz	1015.0000MHz
48.0450MHz	350.7500MHz	1017.5000MHz
87.2500MHz	366.0000MHz	1026.0000MHz
122.3750MHz	366.7500MHz	1098.2500MHz
122.8750MHz	464.2500MHz	1125.0000MHz
144.1350MHz	465.2500MHz	1224.2000MHz
155.1250MHz	488.3750MHz	1227.0000MHz
203.5000MHz	489.2500MHz	1229.8000MHz
208.0000MHz	489.3750MHz	1232.6000MHz
239.0000MHz	783.0000MHz	1288.4000MHz
244.2500MHz	785.2500MHz	1291.2000MHz
257.0000MHz	815.6000MHz	1294.0000MHz
264.9500MHz	818.0000MHz	1296.8000MHz
274.2125MHz	851.8750MHz	
277.5000MHz	854.3750MHz	
279.9775MHz	856.8750MHz	
310.6000MHz	916.1250MHz	
319.7500MHz	918.6250MHz	
320.5000MHz	921.1250MHz	
342.0000MHz		
342.8000MHz		

Cross Modulation

When using an external antenna, if a strong frequency exists close to the reception frequency, cross modulation (like cross talk) may occur. Then, set the ATT switch on rear panel to -10 dB. It minimizes cross modulation.

Even with the SQUELCH control set to maximum (fully clockwise), scanning may stop on or near some of these frequencies. If the signal is strong enough (above $10 \mu V$ in technical terms) you can listen for transmissions on the channel. But you will have to use MANUAL to move off the troublesome frequency.

Types of Signals You Will Be Able to Monitor

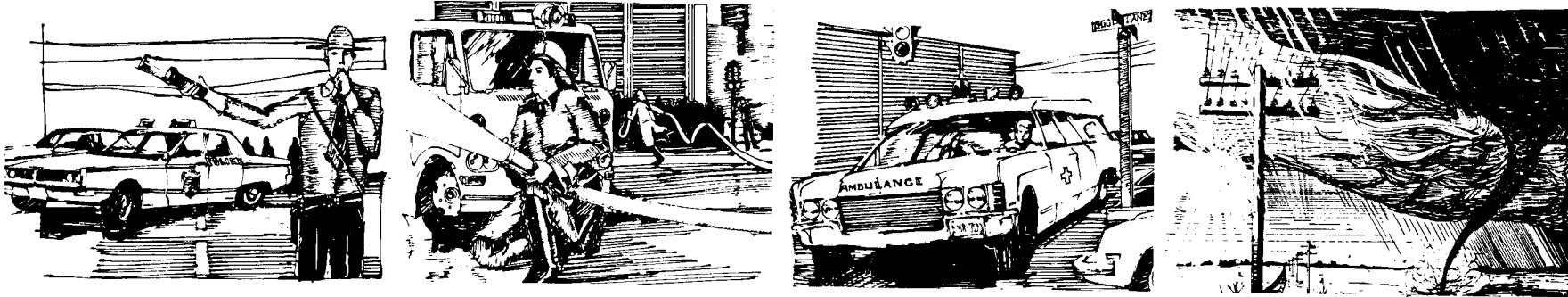

Using receivers capable of covering police, fire, emergency and ambulance frequencies in your car may be restricted by law in some areas. Before installing your PRO-2004 in your car, check to be sure of the regulations in your locality.

GUIDE TO THE ACTION BANDS

Lots of things are going on that most of us are never aware of. But, with the right frequencies programmed into your PRO-2004, you can monitor such exciting signals. You'll have to do a little investigating in your community to find out what services are active and on what frequencies.

What to listen for and where? It is difficult to be specific. Each area of the country can and will use different channels. All we can do is give you some general pointers and then let you take it from there.

Find out if there is a local club which monitors these frequencies. Often a local electronics repair shop that does work on the equipment can give you the channel frequencies used by local radio services. A volunteer police or fire employee can also be a good source of this information.

An interesting service is the Mobile Telephone. FCC has assigned this service channels in the range of 152.51 to 152.81 MHz at every 0.030 MHz (channels are 30 kHz apart). Also, 454.375 to 454.95 MHz with channels 25 kHz apart from 454.375 to 454.625 and then every 50 kHz up to 454.95.

You can hear air navigation between 108 – 118 MHz. Communications between aircraft and airport control towers can be found between 118 – 136 MHz.

As a general rule on VHF, most activity will be concentrated between 153.785 and 155.98 and then again from 158.73 to 159.46 MHz. Here you'll find local government, police, fire and most such emergency services. If you are near a railroad yard or major railroad tracks, look around 160.0 to 161.9 for signals.

In some of the larger cities, there has been a move to the UHF bands for these emergency services. Here, most of the activity is in a spread of 453.025 – 453.95 and again at 456.025 – 459.95 MHz.

In the UHF band, the overall spread of 456.025 – 459.95 and again at 465.025 – 469.975 MHz is used by mobile units and control stations associated with base and repeater units which operate 5 MHz lower (that is, 451.025 – 454.95 and 460.025 – 464.975 MHz). This means that if you find an active channel inside one of these spreads, you can look 5 MHz lower (or higher as the case may be) to find the major base station/repeater for that radio service.

A handy book to have is the *POLICE CALL RADIO DIRECTORY* for your region. Stop by your local Radio Shack store and ask about it. It has complete listings, by frequency, of the various radio services in the bands covered by your PRO-2004. These Directories are updated every year, so get a current one.

TYPICAL BAND USAGE

The following is an abbreviated listing of what's going on in the frequency ranges your PRO-2004 can receive—it'll help you decide which ranges you'd like to choose. Here's a list of abbreviations used:

Affiliate Radio System	MARS
Amateur	Ham
Automobile Emergency	Auto Emer.
Broadcast Remote	BC. R.
Bureau of Reclamation	Bur. Recl.
Civil Air Patrol	CAP
Department of Agriculture and Forestry	Agr. and For.
Fire Department	F.D.
Forest Products	For. Prod.
Forestry Conservation	Fors. Cons.
Government	Govt.
Highway Maintenance	Hwy.
Indian Affairs	
Land Transportation	Land Tr.
Local government	L. Govt.
Manufactures	Mfg.
Marine	
Military	MIL
26.956 ~ 27.405	Citizen's Band
30 ~ 50 MHz Band (0.020 MHz or 20 kHz spacing)	
30.01 ~ 30.56	Govt.
30.56 ~ 30.62	Sp. Ind.
30.66 ~ 31.24	Ind. (Pet., For. Cons., Bus., For. Prod.)
31.26 ~ 31.98	Sp. Ind., For. Cons.
32.00 ~ 33.00	Govt.
33.02 ~ 33.16	Hwy., Sp. Emer., Bus.
33.18 ~ 33.38	Pet.
33.42 ~ 33.98	F.D.
34.00 ~ 35.00	Govt.
35.02 ~ 35.18	Bus.
35.22 ~ 35.66	Mob. Tel. & Page
35.70 ~ 35.72	Bus.
35.74 ~ 35.98	Sp. Ind. & Bus.
36.00 ~ 37.00	Govt.
37.02 ~ 37.44	P.D. & L. Govt.
37.46 ~ 37.86	Power
37.90 ~ 37.98	Hwy. & Sp. Emer.
38.00 ~ 39.00	Govt.

Mobile Telephone	Mob. Tel.
Motion Picture	Mot. P.
Motor Carrier	Buses, Trucks
National Parks	Nat. Pk.
National Oceanographic Atmospheric Administration	N.O.A.A.
Petroleum	Pet.
Police	P.D.
Power Utilities	Power
Radio Paging	Page
Railroad	R.R.
Red Cross	
Relay Press	Press
State Police	St. P.D.
Special Emergency	Sp. Ind.
Taxicab Radio	Taxi
Telephone Maintenance	Tel. Maint.
U.S. Coastal and Geodetic Survey	U.S.C.G.S.
U.S. Navy	USN
39.02 ~ 39.98	P.D., L. Govt.
40.00 ~ 42.00	Govt.
42.02 ~ 42.94	St. P.D.
42.96 ~ 43.18	Sp. Ind. & Bus.
43.22 ~ 43.68	Mob. Tel. Page
43.70 ~ 44.60	Trucks, Bus.
44.62 ~ 45.06	St. P.D., For. Cons.
45.08 ~ 45.66	P.D.
45.68 ~ 46.04	P.D. Hwy., Sp. Emer.
46.06 ~ 46.50	F.D.
46.52 ~ 46.58	L. Govt.
46.60 ~ 47.00	Govt.
47.02 ~ 47.40	St. Hwy.
47.42	Red Cross
47.44 ~ 47.68	Sp. Ind., Sp. Emer.
47.70 ~ 48.54	Power
48.56 ~ 49.58	For. Prod., Pet.
49.60 ~ 50.00	Govt.
88.1 ~ 107.9 MHz Band Standard FM broadcast	
108 ~ 136 MHz Band	
108 ~ 118	Air Navigation
118 ~ 136	Aircraft

144 ~ 148 MHz 2 Meter Amateur (Ham) Band	
148 ~ 174 MHz Band Mixed Spacing (15, 20, 25 kHz)	
148.010	MARS
148.15	CAP
148.155 ~ 148.250	MIL
148.290 ~ 150.750	USN
150.815 ~ 150.995	Bus.
151.010 ~ 151.130	Hwy.
151.145 ~ 151.475	For. Cons.
151.505 ~ 151.595	Sp. Ind.
151.625 ~ 151.955	Bus.
151.985 ~ 152.240	Mob. Tel. (RCC)
152.270 ~ 152.450	Taxi
152.480 ~ 152.840	Mob. Tel. Page
152.870 ~ 153.020	Sp. Ind., Mot. P.
153.050 ~ 153.440	Pet., For. Prod.
153.470 ~ 153.710	Power
153.740 ~ 154.115	L. Govt.
154.130 ~ 154.445	F.D.
154.450 ~ 154.600	Sp. Ind., Pet., Bus.
154.655 ~ 155.145	P.D., L. Govt., St. P.D.
155.160 ~ 155.400	Sp. Emer., P.D.
155.415 ~ 156.030	P.D., L. Govt.
156.045 ~ 156.240	Hwy., P.D.
156.275 ~ 157.425	Marine
157.456 ~ 157.500	Auto Emer.
157.530 ~ 157.710	Taxi
157.740 ~ 158.100	Mob. Tel., Page
158.130 ~ 158.460	Power, For. Prod., Pet.
158.490 ~ 158.700	Mob. Tel. (RCC)
158.730 ~ 158.970	P.D., L. Govt.
158.985 ~ 159.210	P.D. Hwy.
159.225 ~ 159.465	For. Cons.
159.510 ~ 160.200	Trucks
160.215 ~ 161.565	R.R.
161.600 ~ 162.000	Marine
162.026 ~ 162.175	Bur. Recl.
162.400	N.O.A.A.
162.550 ~	N.O.A.A.
163.125 ~	Indian Affairs
163.175 ~	Bur. Recl.
163.275	N.O.A.A.
163.388 ~ 163.538	MIL
163.825 ~ 163.975	Govt.
164.025 ~ 164.075	U.S.C.G.S.
164.175 ~ 165.188	Bur. Recl., Nat. Pk., Govt., Agr. & For.
169.300	F.A.A.

169.450 ~ 169.725	Ind., Data
170.150	F.D., BC. R.
170.200 ~ 170.220	U.S.C.G.S.
170.225 ~ 170.325	Ind., Land Tr.
170.425 ~ 170.575	For. Cons.
170.975 ~ 171.250	Govt. Ind., Land Tr.
171.388 ~ 172.725	Bur. Recl., For. Cons., Ind., Dept. Ag. & For., Govt.
172.775	Bus. Nat. Pk.
173.025	N.O.A.A.
173.075	U.S.C.G.S.
173.204 ~	Mot. P., Pet., Bur. Recl. Press Relay.
430 ~ 450 MHz Amateur (Ham) Band	
450 ~ 512 MHz Band (25 kHz Spacing)	
450.050 ~ 450.950	BC. R.
451.000 ~ 451.150	Util.
451.175 ~ 451.750	For. Prod., Pet., Pwr., Tel. Maint
451.775 ~ 451.975	Spec. Ind.
452.000 ~ 452.500	Taxi, Mot. Carrier, R.R.
452.525 ~ 452.600	Auto Club
452.625 ~ 452.975	Motor Carr., R.R.
453.000 ~ 453.975	L. Govt., P.D., F.D.
454.000 ~ 454.975	Mob. Tel.
455.000 ~ 455.975	Remote Br.
456.000 ~ 458.975	P.D., F.D., Ind., Lan. Tr.
459.000 ~ 459.975	Domestic Public
460.000 ~ 460.625	P.D., F.D.
460.650 ~ 462.175	Bus.
462.200 ~ 462.450	Taxi
462.750 ~ 462.975	Bus.
463.000 ~ 463.175	Medical
463.200 ~ 464.975	Bus.
465.000 ~ 467.500	P.D., F.D., Ind., Land Tr.
467.750 ~ 467.925	Bus.
467.7375 ~ 469.975	Pub. Safety, Ind., Land Tr.
800 MHz Band	P.D., F.D.
900 ~ 960 MHz	Paging Service (Fixed and Mobile)
960 ~ 1215 MHz	Air and Naval Service
1215 ~ 1300 MHz	Amateur (Ham) Band

In some large metropolitan areas, 1 or 2 channels of the "TV Band" (470 MHz to 512 MHz) are used for special communications. Each station (channels 14 through 20) uses 6 MHz:

- 470 ~ 476 T.V. Channel 14
- 476 ~ 482 T.V. Channel 15
- 482 ~ 488 T.V. Channel 16
- 488 ~ 494 T.V. Channel 17
- 494 ~ 500 T.V. Channel 18
- 500 ~ 506 T.V. Channel 19
- 506 ~ 512 T.V. Channel 20

Where these frequencies are assigned for special communications, in lieu of a TV station, the 6 Mhz segment is allocated as shown here for channel 14 (470 ~ 476 MHz).

470.0125 ~ 470.2875 Domestic Public, (Base, Mob.)	473.0125 ~ 473.2875 Domestic Public
470.3125 ~ 471.1375 Public Safety	473.3125 ~ 474.1375 Public Safety
471.1625 ~ 471.2875 Reserve Pool A	474.1625 ~ 474.2875 Reserve Pool A
471.3125 ~ 471.4125 Pwr., Tel. Maint.	474.3125 ~ 474.4125 Pwr., Tel. Maint.
471.4375 ~ 471.6375 Spec. Ind.	474.4375 ~ 474.6375 Spec. Ind. (Mobile)
471.6625 ~ 471.7875 Reserve Pool B	474.6625 ~ 474.7875 Reserve Pool B.
471.8125 ~ 472.3375 Bus.	474.8125 ~ 475.3375 Bus.
472.3625 ~ 472.4375 Taxi	475.3625 ~ 475.4375 Taxi
472.4675 ~ 472.7875 . . . R.R., Motor Carrier, Auto Emer.	475.4625 ~ 475.7875 . . . R.R., Motor Carrier, Auto Emer.
472.8125 ~ 472.9875 . . . Pet., For. Prod., Mfg.	475.8125 ~ 475.9876 . . . Pet., For. Prod., Mfg.

The same allocation pattern is repeated for each of the TV channels 14 through 20. For example, if channel 17 is assigned for communications in your area, "Taxi" would be 490.3625 to 480.4375 and 493.3625 to 493.4375 (corresponding to 472.3625 to 472.4375 and 475.3625 to 475.4375 above). Note that in the example, we added three TV channels (18 MHz) to the channel 14 frequencies.

SOME RANDOM NOTES

You'll soon notice some differences between reception on the aircraft band (108–136 MHz) and the other ranges covered by your PRO-2004. Aircraft band stations use AM, while stations on the other ranges covered by your PRO-2004 use FM. Don't be too surprised if reception is a bit "noisier" on the aircraft band than others. Your PRO-2004 will automatically switch over to AM or FM depending on the frequency you wish to listen on.

Reception on the frequencies covered by your PRO-2004 is mainly "line of sight." That means you usually won't be able to hear stations located beyond the horizon at your listening location. You'll be able to hear aircraft at greater distances than ground stations. And during the summer months you may be able to hear stations in the 30–50 MHz range located several hundred or even thousands of miles away. This is due to summer atmospheric conditions; this type of reception is unpredictable (but often very interesting!).

One very useful service is the National Weather Service's continuous weather broadcasts. These broadcasts contain weather forecasts and data for the area around the station plus bulletins on any threatening weather conditions. These stations use three frequencies—162.40, 162.475 or 162.55 MHz. In most areas of the country you will be able to receive one of these frequencies.

MAINTENANCE

Your PRO-2004 is an example of superior design and craftsmanship, and should be treated with care. The suggestions below will help you enjoy this product for many years.



Keep it dry. If water should get on it, wipe it off. Water contains minerals that can corrode electronic circuits.



Do not store in hot areas. High temperatures can shorten the life of electronic devices, damage batteries, and warp or melt certain plastics.



Do not drop it. This might cause permanent damage. The circuit boards and case can be broken.



Do not use or store it in dusty, dirty areas. This will cause premature wear of moving parts.



Do not use harsh chemicals, cleaning solvents, or strong detergents to clean it. Wipe it with a soft cloth dampened in a mild soap-and-water solution.



Be sure batteries are the correct type — do not use general purpose batteries if alkaline batteries are recommended. Remove old, weak batteries — they can leak chemicals that damage electronic circuits.

If the unit is not working properly, take it to your local Tandy store. The personnel there will assist you and, if necessary, arrange service.

BEFORE YOU CALL FOR HELP . . .

The PRO-2004 is a ruggedly built electronic unit, with all parts conservatively rated. However, you should treat it with care; don't subject it to excessively rough handling. You will find it will give you long life if kept free from dirt and excessively humidity.

The 9-volt Battery (used to maintain the program memory) should be replaced every six months. Use only an Alkaline type, such as Radio Shack's Catalog Number 23-553.

If You Have Problems . . .

We hope you don't—but if you do, here are some suggestions.

Problem	Possible Cause	Remedy
Scanner is totally in-operative.	No power	Check to see that unit is plugged into a working AC outlet, or DC power source.
Scanner is on, but will not scan.	1) Channels are locked out. 2) Squelch control is not adjusted correctly.	1) Press MANUAL , then release each channel one-by-one. 2) Adjust SQUELCH clockwise.
Scan locks on frequencies having no clear transmission.	"Birdies"	Avoid programming frequencies listed on page 16, or only listen to them manually.
Keys are in-operative LCD display is random.	CPU does not work right.	Press RESTART switch on rear panel with a ball point pen, etc.

If none of these suggested remedies solves the problem, return your set to your nearby Radio Shack for assistance.

SPECIFICATIONS

FREQUENCY COVERAGE:

25 MHz – 520 MHz
760 MHz – 1300 MHz

RECEPTION FREQUENCY INTERVAL:

5 kHz, 12.5 kHz, 30 kHz, 50 kHz

RECEIVING WAVE MODE:

Wide FM (TV sound, FM broadcast)
Narrow FM (Business, communication, ham radio)
AM (Aircraft, CB radio)

CHANNELS OF OPERATION:

Any 300 channels in any band combinations. (30 channels x 10 banks), and 10 Monitor channels.

SENSITIVITY:

WFM: 30 dB S/N at 22.5 kHz deviation

25 MHz – 520 MHz	3 μ V
760 MHz – 1100 MHz	3 μ V
1100 MHz – 1300 MHz	10 μ V

NFM: 20 dB S/N at 3 kHz deviation

25 MHz – 520 MHz	0.5 μ V
760 MHz – 1100 MHz	0.5 μ V
1100 MHz – 1300 MHz	3 μ V

AM: 20 dB S/N at 60% modulation

25 MHz – 520 MHz	2 μ V
760 MHz – 1100 MHz	2 μ V
1100 MHz – 1300 MHz	3 μ V

IF REJECTION:

610 MHz at 70 MHz 60 dB

SELECTIVITY:

NFM and AM \pm 9 kHz, –6 dB
 \pm 15 kHz, –50 dB

WFM

\pm 150 kHz, –6 dB
 \pm 300 kHz, –50 dB

SCANNING RATE:

Fast 16 channels/sec
Slow 8 channels/sec

SEARCH RATE:

Fast 16 steps/sec
Slow 8 steps/sec

PRIORITY SAMPLING:

2 seconds

DELAY TIME:

2 seconds

SQUELCH SENSITIVITY:

NFM and AM
Threshold

25 MHz – 520 MHz	0.5 μ V
760 MHz – 1100 MHz	0.5 μ V
1100 MHz – 1300 MHz	3 μ V

Tight S/N 25 dB

WFM

Threshold

25 MHz – 520 MHz	3 μ V
760 MHz – 1100 MHz	3 μ V
1100 MHz – 1300 MHz	10 μ V

Tight S/N 40 dB

ANTENNA IMPEDANCE:

50 ohms

AUDIO POWER:

1.8 watts nominal

BUILT-IN SPEAKER:

3" (77 mm) 8 ohm, dynamic type

TAPE OUT (Z= 10 kohm) :

600 mV nominal

POWER REQUIREMENTS:

AC 120 Volts 20 watts
DC 13.8 Volts 12 watts

MEMORY BACK-UP BATTERY:

9 Volts

DIMENSIONS:

2-7/8" (75mm) x 10-1/4" (275mm) x 9" (230mm) HWD

WEIGHT:

7.0 lbs (3.2 kg)

BLOCK DIAGRAM

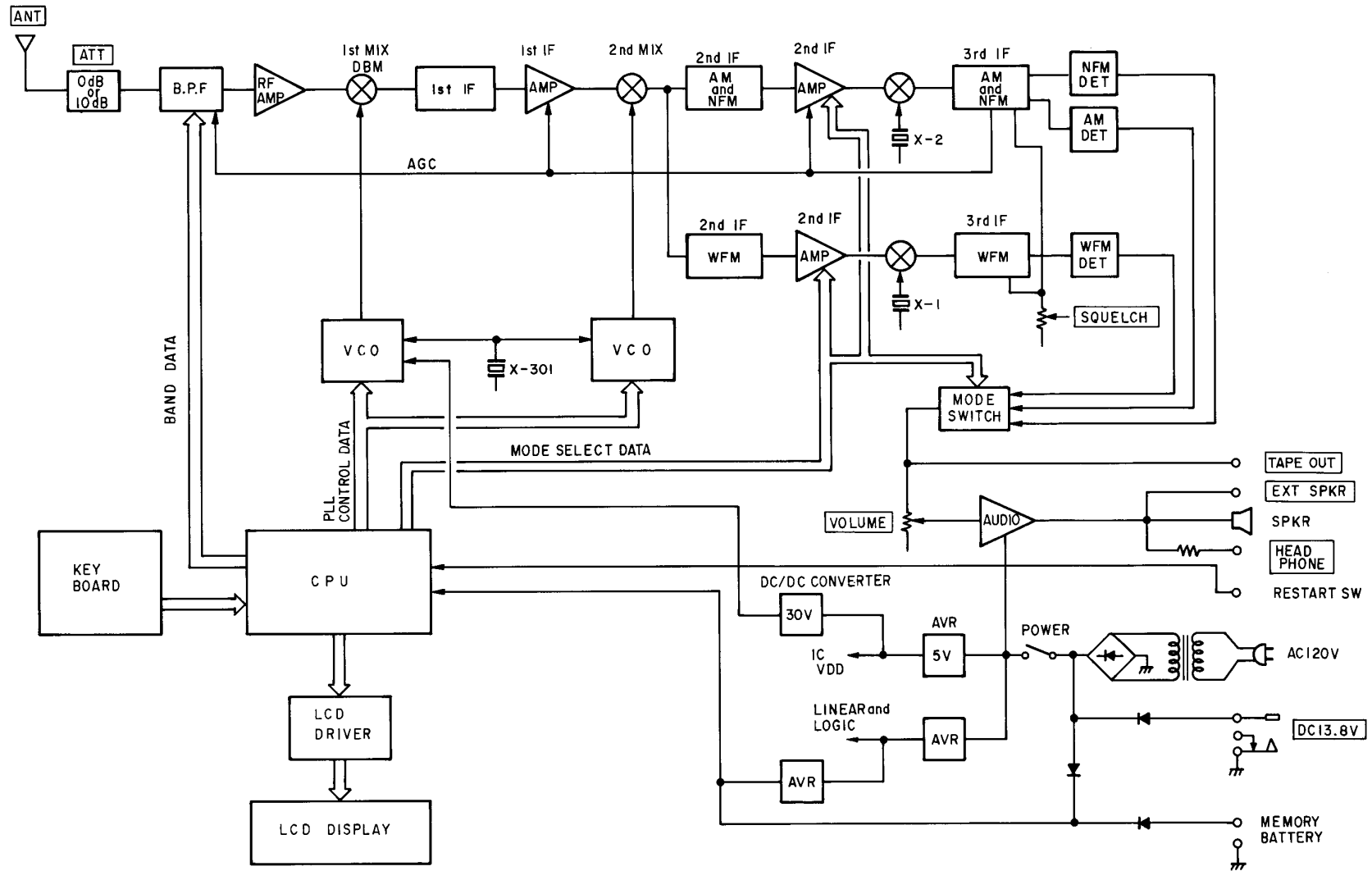



RADIO SHACK LIMITED WARRANTY

This product is warranted against defects for 1 year from date of purchase from Radio Shack company-owned stores and authorized Radio Shack franchisees and dealers. Within this period, we will repair it without charge for parts and labor. Simply **bring your Radio Shack sales slip** as proof of purchase date to any Radio Shack store. Warranty does not cover transportation costs. Nor does it cover a product subjected to misuse or accidental damage.

EXCEPT AS PROVIDED HEREIN, RADIO SHACK MAKES NO WARRANTIES, EXPRESS OR IMPLIED, INCLUDING WARRANTIES OF MERCHANTABILITY AND FITNESS FOR A PARTICULAR PURPOSE. Some states do not permit limitation or exclusion of implied warranties; therefore, the aforesaid limitation(s) or exclusion(s) may not apply to the purchaser.

This warranty gives you specific legal rights and you may also have other rights which vary from state to state.

We Service What We Sell

U.S. PATENT NOS.

3,794,925
3,801,914
3,961,261
3,962,644
4,027,251
4,092,594
4,123,715
4,245,348

RADIO SHACK
A Division of Tandy Corporation
Fort Worth, Texas 76102

Printed in Japan