

# HP Notebook

## Reference Guide

HP Mini 110

Compaq Mini CQ10

HP Mini 1103

© Copyright 2010 Hewlett-Packard  
Development Company, L.P.

ATI is a trademark of Advanced Micro  
Devices, Inc. Bluetooth is a trademark  
owned by its proprietor and used by Hewlett-  
Packard Company under license. Microsoft  
and Windows are U.S. registered trademarks  
of Microsoft Corporation. Java is a U.S.  
trademark of Sun Microsystems, Inc.

The information contained herein is subject  
to change without notice. The only  
warranties for HP products and services are  
set forth in the express warranty statements  
accompanying such products and services.  
Nothing herein should be construed as  
constituting an additional warranty. HP shall  
not be liable for technical or editorial errors  
or omissions contained herein.

Second Edition: May 2010

First Edition: April 2010

Document Part Number: 607194-002

#### **Product notice**

This reference guide describes features that  
are common to most models. Some features  
may not be available on your computer.

## Safety warning notice

- 
- △ **WARNING!** To reduce the possibility of heat-related injuries or of overheating the computer, do not place the computer directly on your lap or obstruct the computer air vents. Use the computer only on a hard, flat surface. Do not allow another hard surface, such as an adjoining optional printer, or a soft surface, such as pillows or rugs or clothing, to block airflow. Also, do not allow the AC adapter to come into contact with the skin or a soft surface, such as pillows or rugs or clothing, during operation. The computer and the AC adapter comply with the user-accessible surface temperature limits defined by the International Standard for Safety of Information Technology Equipment (IEC 60950).
-



---

# Table of contents

|   |           |
|---|-----------|
| <b>1 Introduction</b>   | <b>1</b>  |
| Finding more information about your new computer                                    | 1         |
| <b>2 Networking (select models only)</b>  | <b>2</b>  |
| Creating a wireless connection  | 2         |
| Identifying wireless and network status icons                                       | 2         |
| Turning wireless devices on or off  | 3         |
| Using the wireless button   | 3         |
| Using HP Wireless Assistant (select models only) to turn wireless devices on or off | 4         |
| Using HP Connection Manager (select models only)                                    | 4         |
| Using operating system controls   | 5         |
| Using a WLAN  | 5         |
| Connecting to an existing WLAN  | 5         |
| Setting up a new WLAN   | 6         |
| Protecting your WLAN  | 6         |
| Roaming to another network  | 7         |
| Using HP Mobile Broadband (select models only)                                      | 7         |
| Inserting a SIM   | 7         |
| Removing a SIM  | 8         |
| Using Bluetooth wireless devices  | 8         |
| Bluetooth and Internet Connection Sharing (ICS)                                     | 8         |
| Using GPS (select models only)  | 9         |
| Connecting to a wired network   | 9         |
| Using a modem (select models only)  | 9         |
| Connecting a modem cable  | 9         |
| Connecting a country- or region-specific modem cable adapter                        | 10        |
| Selecting a location setting  | 10        |
| Viewing the current location selection  | 10        |
| Adding new locations when traveling   | 10        |
| Connecting to a local area network (LAN) (select models only)                       | 12        |
| <b>3 Multimedia</b>   | <b>14</b> |
| Using the media activity controls   | 14        |
| Audio   | 14        |
| Adjusting the volume  | 14        |
| Checking audio functions on the computer  | 15        |
| Webcam (select models only)   | 16        |

|   |           |
|---|-----------|
| Using SkyRoom (select models only) .....                                      | 16        |
| Video .....   | 16        |
| VGA .....   | 16        |
| DisplayPort .....   | 17        |
| HDMI .....  | 17        |
| Configuring audio for HDMI .....  | 18        |
| Using HP MediaSmart (select models only) .....                                | 19        |
| <b>4 Power management .....</b>   | <b>20</b> |
| Shutting down the computer .....  | 20        |
| Setting power options .....   | 20        |
| Using power-saving states .....   | 20        |
| Initiating and exiting Sleep .....  | 21        |
| Initiating and exiting Hibernation .....                                      | 21        |
| Using the power meter .....   | 22        |
| Using power plans .....   | 22        |
| Viewing the current power plan .....  | 22        |
| Selecting a different power plan .....  | 22        |
| Customizing power plans .....   | 22        |
| Setting password protection on wakeup .....                                   | 23        |
| Using battery power .....   | 23        |
| Finding battery information in Help and Support in Windows 7 .....            | 24        |
| Using Battery Check in Windows 7 .....  | 24        |
| Displaying the remaining battery charge .....                                 | 24        |
| Maximizing battery discharge time .....                                       | 24        |
| Managing low battery levels .....   | 25        |
| Identifying low battery levels .....  | 25        |
| Resolving a low battery level .....   | 25        |
| Resolving a low battery level when external power is available .....          | 25        |
| Resolving a low battery level when a charged battery is available .....       | 25        |
| Resolving a low battery level when no power source is available .....         | 25        |
| Resolving a low battery level when the computer cannot exit Hibernation ..... | 26        |
| Conserving battery power .....  | 26        |
| Storing a battery .....   | 26        |
| Disposing of a used battery .....   | 26        |
| Replacing the battery .....   | 26        |
| Using external AC power .....   | 27        |
| Testing an AC adapter .....   | 28        |
| Switching between graphics modes (select models only) .....                   | 28        |

|   |           |
|---|-----------|
| <b>5 External cards and devices</b> .....   | <b>29</b> |
| Using Digital Media Slot cards (select models only) .....                           | 29        |
| Inserting a digital card .....  | 29        |
| Removing a digital card .....   | 29        |
| Using PC Cards (select models only) .....   | 30        |
| Configuring a PC Card .....   | 30        |
| Inserting a PC Card .....   | 30        |
| Removing a PC Card .....  | 32        |
| Using ExpressCards (select models only) .....                                       | 32        |
| Configuring an ExpressCard .....  | 32        |
| Inserting an ExpressCard .....  | 33        |
| Removing an ExpressCard .....   | 34        |
| Using smart cards (select models only) .....  | 34        |
| Inserting a smart card .....  | 35        |
| Removing a smart card .....   | 35        |
| Using a USB device .....  | 35        |
| Connecting a USB device .....   | 35        |
| Removing a USB device .....   | 36        |
| Using 1394 devices (select models only) .....                                       | 36        |
| Connecting a 1394 device .....  | 37        |
| Removing a 1394 device .....  | 37        |
| Using an eSATA device (select models only) .....                                    | 37        |
| Connecting an eSATA device .....  | 37        |
| Removing an eSATA device .....  | 38        |
| Using optional external devices .....   | 39        |
| Using optional external drives .....  | 39        |
| Using the expansion port (select models only) .....                                 | 39        |
| Using the docking connector (select models only) .....                              | 40        |
| <br>  |           |
| <b>6 Drives</b> .....   | <b>41</b> |
| Handling drives .....   | 41        |
| Using hard drives .....   | 41        |
| Improving hard drive performance .....  | 41        |
| Using Disk Defragmenter .....   | 41        |
| Using Disk Cleanup .....  | 42        |
| Using HP ProtectSmart Hard Drive Protection in Windows 7 (select models only) ..... | 42        |
| Identifying HP ProtectSmart Hard Drive Protection status .....                      | 43        |
| Managing power with a parked hard drive .....                                       | 43        |
| Using HP ProtectSmart Hard Drive Protection software .....                          | 43        |
| Using optical drives (select models only) .....                                     | 44        |
| Identifying the installed optical drive .....                                       | 44        |
| Inserting an optical disc .....   | 45        |
| Tray load .....   | 45        |

|   |           |
|---|-----------|
| Slot load .....   | 45        |
| Removing an optical disc .....                            | 46        |
| Tray load .....   | 46        |
| When the disc tray opens normally .....                   | 46        |
| When the disc tray fails to open .....                    | 46        |
| Slot load .....   | 47        |
| Sharing optical drives .....                              | 48        |
| Using RAID (select models only) .....                     | 48        |
| <b>7 Security .....</b>                                   | <b>49</b> |
| Protecting the computer .....                             | 49        |
| Using passwords .....                                     | 49        |
| Setting passwords in Windows .....                        | 50        |
| Setting passwords in Setup Utility .....                  | 50        |
| Managing an administrator password .....                  | 51        |
| Entering an administrator password .....                  | 51        |
| Managing a power-on password .....                        | 51        |
| Entering a power-on password .....                        | 51        |
| Using antivirus software .....                            | 52        |
| Using firewall software .....                             | 52        |
| Installing critical security updates .....                | 52        |
| Installing an optional security cable .....               | 53        |
| Using the fingerprint reader (select models only) .....   | 53        |
| Locating the fingerprint reader .....                     | 53        |
| <b>8 Setup Utility (BIOS) .....</b>                       | <b>55</b> |
| Starting Setup Utility .....                              | 55        |
| Using Setup Utility .....                                 | 55        |
| Changing the language of Setup Utility .....              | 55        |
| Navigating and selecting in Setup Utility .....           | 55        |
| Displaying system information .....                       | 56        |
| Restoring factory default settings in Setup Utility ..... | 56        |
| Exiting Setup Utility .....                               | 56        |
| Updating the BIOS .....                                   | 57        |
| Determining the BIOS version .....                        | 57        |
| Downloading a BIOS update .....                           | 57        |
| <b>Appendix A Traveling with the computer .....</b>       | <b>59</b> |
| <b>Appendix B Troubleshooting resources .....</b>         | <b>60</b> |
| <b>Appendix C Electrostatic Discharge .....</b>           | <b>61</b> |







---

# 1 Introduction

This guide contains general information about HP and Compaq notebook computers, including connecting to a wireless network, multimedia, power management, security, and so on.

 **NOTE:** Some of the features described in this guide may not be available on your computer.

---

## Finding more information about your new computer

The following user guides and reference material are provided with your computer, either in print, on the computer hard drive, or on an optical disc or SD Card:

- *Quick Setup* poster—Guides you through setting up your computer and turning it on. The poster is located in the computer box.

 **NOTE:** Refer to the poster for the location of your user guides and reference material.

---

- *Getting Started*—Contains information about your computer, including product-specific features, backup and recovery, maintenance, and specifications.
- Help and Support—Contains information about the operating system, drivers, troubleshooting tools, and technical support. To access Help and Support, select **Start > Help and Support**. For country- or region-specific support, go to <http://www.hp.com/support>, select your country or region, and follow the on-screen instructions.
- *Safety & Comfort Guide*—Describes proper workstation setup and proper posture, health, and work habits for computer users. It also provides important electrical and mechanical safety information. To access this guide, select **Start > Help and Support > User Guides**. This guide is also available on the Web at <http://www.hp.com/ergo>.
- *Regulatory, Safety, and Environmental Notices*—Contains safety and regulatory information, and battery disposal information. To access the notices, select **Start > Help and Support > User Guides**.

---

## 2 Networking (select models only)

Your computer supports 2 types of Internet access:

- **Wireless**—Refer to [Creating a wireless connection on page 2](#).
- **Wired**—Refer to [Connecting to a wired network on page 9](#).

 **NOTE:** You must set up Internet service before you can connect to the Internet.

---

### Creating a wireless connection







Your computer may be equipped with one or more of the following wireless devices:

- Wireless local area network (WLAN) device
- HP Mobile Broadband Module (wireless wide area network (WWAN))
- Bluetooth® device



For more information on wireless technology, refer to the information and Web site links provided in Help and Support.

### Identifying wireless and network status icons







#### Windows 7

| Icon  | Name                                | Description  |
|---|-------------------------------------|--|
|  | Wireless (connected)                | Indicates that one or more wireless devices are on.  |
|  | Wireless (disconnected)             | Indicates that all wireless devices are off.   |
|  | HP Connection Manager               | Opens HP Connection Manager, which enables you to create a connection with an HP Mobile Broadband Module (select models only). |
|  | Wired network (connected)           | Indicates that one or more network devices are connected to the network.   |
|  | Network (disabled/<br>disconnected) | Indicates that all network devices are disabled in Windows Control Panel.  |
|  | Network (connected)                 | Indicates that one or more network devices are connected to a network.   |

---

|   |                                     |  |
|---|-------------------------------------|--|
|  | Network (disconnected)              | Indicates that network devices are not connected to a network. |
|  | Network (disabled/<br>disconnected) | Indicates that no wireless connections are available.          |

## Windows XP

| Icon  | Name                                       | Description  |
|---|--|--|
|    | HP Connection Manager                      | Opens HP Connection Manager, which enables you to create a connection with an HP Mobile Broadband Module (select models only). |
|    | Wireless (connected)                       | Indicates that one or more wireless devices are on.  |
|    | Wireless (disconnected)                    | Indicates that all wireless devices are off.   |
|    | Wireless network connection (connected)    | Indicates that one or more WLAN devices are connected to a network.  |
|   | Wireless network connection (disconnected) | Indicates that one or more WLAN devices are not connected to a network.  |
|  | Network status (connected)                 | Connected to the wired network.  |
|  | Network status (disconnected)              | Not connected to the wired network.  |

## Turning wireless devices on or off

### Using the wireless button

 **NOTE:** A computer may have a wireless button, a wireless switch, or a wireless action key on the keyboard. The term *wireless button* is used throughout this guide to refer to all types of wireless controls. Refer to the *Getting Started* guide for information on identifying the location of the wireless button on your computer.

You can use the wireless button to simultaneously turn on or turn off the wireless network controller and Bluetooth device. These devices can be controlled through Wireless Assistant (select models only).

## Using HP Wireless Assistant (select models only) to turn wireless devices on or off

A wireless device can be turned on or off using Wireless Assistant. If a wireless device is disabled in Setup Utility, it must be reenabled in Setup Utility before it can be turned on or off using Wireless Assistant.

 **NOTE:** Enabling and turning on a wireless device does not automatically connect the computer to a network or a Bluetooth-enabled device.

To view the state of the wireless devices, click the **Show hidden icons** icon, the arrow at the left of the notification area, and position the mouse pointer over the wireless icon.

▲ To open Wireless Assistant, double-click the wireless icon in the notification area.

If the wireless icon is not displayed in the notification area, complete the following steps:

### Windows 7

1. Select **Start > Control Panel > Hardware and Sound > Windows Mobility Center**.
2. Click the wireless icon in the Wireless Assistant tile, which is located in the bottom row of Windows® Mobility Center.
3. Click **Properties**.
4. Select the check box next to **HP Wireless Assistant icon in notification area**.
5. Click **Apply**.
6. Click **Close**.

For more information, refer to the Wireless Assistant software Help:

1. Open Wireless Assistant by clicking the wireless icon in Windows Mobility Center.
2. Click the **Help** button.

### Windows XP

1. Select **Start > Control Panel > Network and Internet Connections > HP Wireless Assistant**.
2. Click **Properties**.
3. Select the check box next to **Wireless Assistant icon in notification area**.
4. Click **Apply**.

## Using HP Connection Manager (select models only)

You can use HP Connection Manager to connect to WWANs using the HP Mobile Broadband Module in your computer (select models only).

▲ To start Connection Manager, click the **HP Connection Manager** icon in the notification area, at the far right of the taskbar.

– or –

Select **Start > All Programs > HP Connection Manager > HP Connection Manager**.

For more details about using Connection Manager, refer to the Connection Manager software Help.

## Using operating system controls

The Network and Sharing Center allows you to set up a connection or network, connect to a network, manage wireless networks, and diagnose and repair network problems.

### Windows 7

- ▲ Select **Start > Control Panel > Network and Internet > Network and Sharing Center**.

### Windows XP

- ▲ Select **Start > Control Panel > Network and Internet Connections > Network Connections**.

For more information, select **Start > Help and Support**.

## Using a WLAN

A wireless connection connects the computer to Wi-Fi networks, or WLANs. A WLAN is composed of other computers and accessories that are linked by a wireless router or a wireless access point.

## Connecting to an existing WLAN

### Windows 7

1. Be sure that the WLAN device is on. (Refer to [Turning wireless devices on or off on page 3](#)).
2. Click the network icon in the notification area, at the far right of the taskbar.
3. Select your WLAN from the list.
4. Click **Connect**.

If the network is a security-enabled WLAN, you are prompted to enter a network security code. Type the code, and then click **OK** to complete the connection.

 **NOTE:** If no WLANs are listed, you are out of range of a wireless router or access point.

**NOTE:** If you do not see the network you want to connect to, click **Open Network and Sharing Center**, and then click **Set up a new connection or network**. A list of options is displayed. You can choose to manually search for and connect to a network or to create a new network connection.

### Windows XP

1. Be sure that the WLAN device is on. (Refer to [Turning wireless devices on or off on page 3](#).)
2. Select **Start > Connect to**.
3. Select your WLAN from the list.
  - If the network is unsecured, a warning is displayed. Click **Connect Anyway** to accept the warning and complete the connection.
  - If the network is a security-enabled WLAN, you are prompted to enter a network security code. Type the code, and then click **Connect** to complete the connection.

 **NOTE:** If no WLANs are listed, you are out of range of a wireless router or access point.

**NOTE:** If you do not see the network you want to connect to, click **Set up a connection or network**. A list of options is displayed. You can choose to manually search for and connect to a network or to create a new network connection.

After the connection is made, you can place the mouse pointer over the network icon in the notification area, at the far right of the taskbar, to verify the name and status of the connection.

 **NOTE:** The functional range (how far your wireless signals travel) depends on WLAN implementation, router manufacturer, and interference from other electronic devices or structural barriers such as walls and floors.

---

## Setting up a new WLAN

Required equipment:

- A broadband modem (either DSL or cable) **(1)** and high-speed Internet service purchased from an Internet service provider (ISP)
- A wireless router (purchased separately) **(2)**
- The wireless computer **(3)**

 **NOTE:** Some cable modems include a built-in router. Check with your ISP to see if you need a separate router.

---

The illustration below shows an example of a wireless network installation that is connected to the Internet.



 **NOTE:** When setting up a wireless connection, be sure that your computer and wireless router are synchronized. To synchronize your computer and wireless router, turn your computer and wireless router off and then back on.

---

As your network grows, additional wireless and wired computers can be connected to the network to access the Internet.

For help in setting up your WLAN, refer to the information provided by your router manufacturer or your ISP.

## Protecting your WLAN

When you set up a WLAN or access an existing WLAN, always enable security features to protect your network from unauthorized access. WLANs in public areas (hotspots) like coffee shops and airports may not provide any security. If you are concerned about the security of your computer in a hotspot, limit your network activities to e-mail that is not confidential and basic Internet surfing.

Wireless radio signals travel outside the network, so other WLAN devices can pick up unprotected signals. You can take the following precautions to protect your WLAN:

- **Firewall**—Checks both data and requests for data that are sent to your network, and discards any suspicious items. Firewalls are available in both software and hardware. Some networks use a combination of both types.
- **Wireless encryption**—Wi-Fi Protected Access (WPA) uses security settings to encrypt and decrypt data transmitted over the network. WPA uses Temporal Key Integrity Protocol (TKIP) to dynamically generate a new key for every packet. It also generates different sets of keys for each computer on the network.



## Roaming to another network

When you move your computer within range of another WLAN, Windows attempts to connect to that network. If the attempt is successful, your computer is automatically connected to the new network. If Windows does not recognize the new network, follow the same procedure you used initially to connect to your WLAN.

## Using HP Mobile Broadband (select models only)

HP Mobile Broadband enables your computer to use wireless wide area networks (WWANs) to access the Internet from more places and over larger areas than it can by using WLANs. Using HP Mobile Broadband requires a network service provider, which in most cases is a mobile phone network provider.

When used with mobile network provider service, HP Mobile Broadband gives you the freedom to stay connected to the Internet, send e-mail, or connect to your corporate network whether you are on the road or outside the range of Wi-Fi hotspots.

 **NOTE:** You may need the HP Mobile Broadband Module serial number to activate mobile broadband service. Refer to the *Getting Started* guide for the location of the serial number.

Some mobile network service providers require the use of a subscriber identity module (SIM). A SIM contains basic information about you, such as a personal identification number (PIN), as well as network information. Some computers include a preinstalled SIM. If the SIM is not preinstalled, it may be included with the HP Mobile Broadband information provided with your computer, or it may be provided separately by the mobile network service provider.

For information on inserting and removing the SIM, refer to [Inserting a SIM on page 7](#) and [Removing a SIM on page 8](#).

For information on HP Mobile Broadband and how to activate service with a preferred mobile network service provider, refer to the HP Mobile Broadband information included with your computer. For additional information, see the HP Web site at <http://www.hp.com/go/mobilebroadband> (U.S. only).

## Inserting a SIM

 **NOTE:** To identify the SIM slot location, refer to the *Getting Started* guide.

1. Shut down the computer. If you are not sure whether the computer is off or in Hibernation, turn the computer on by pressing the power button. Then shut down the computer through the operating system.
2. Close the display.
3. Disconnect all external devices connected to the computer.
4. Unplug the power cord from the AC outlet.
5. Remove the battery.
6. Insert the SIM into the SIM slot, and gently press the SIM into the slot until it is firmly seated.

 **CAUTION:** When inserting a SIM, position the card to match the icon next to the SIM slot on the computer. If a SIM is inserted incorrectly, it could damage the SIM and the SIM connector.

To reduce the risk of damage to the connector, use minimal force when inserting a SIM.

7. Replace the battery.

 **NOTE:** HP Mobile Broadband is disabled if the battery is not replaced.

8. Reconnect external power and external devices.
9. Turn on the computer.

## Removing a SIM

 **NOTE:** To identify the SIM slot location, refer to the *Getting Started* guide.

1. Shut down the computer. If you are not sure whether the computer is off or in Hibernation, turn the computer on by pressing the power button. Then shut down the computer through the operating system.
2. Close the display.
3. Disconnect all external devices connected to the computer.
4. Unplug the power cord from the AC outlet.
5. Remove the battery.
6. Press in on the SIM, and then remove it from the slot.
7. Replace the battery.
8. Reconnect external power and external devices.
9. Turn on the computer.

## Using Bluetooth wireless devices

A Bluetooth device provides short-range wireless communications that replace the physical cable connections that traditionally link electronic devices such as the following:

- Computers
- Phones
- Imaging devices (cameras and printers)
- Audio devices

Bluetooth devices provide peer-to-peer capability that allows you to set up a personal area network (PAN) of Bluetooth devices. For information on configuring and using Bluetooth devices, refer to the Bluetooth software Help.

## Bluetooth and Internet Connection Sharing (ICS)

HP does **not** recommend setting up one computer with Bluetooth as a host and using it as a gateway through which other computers may connect to the Internet. When two or more computers are connected using Bluetooth, and Internet Connection Sharing (ICS) is enabled on one of the computers, the other computers may not be able to connect to the Internet using the Bluetooth network.

The strength of Bluetooth is in synchronizing information transfers between your computer and wireless devices including cellular phones, printers, cameras, and PDAs. The inability to consistently connect two or more computers to share the Internet through Bluetooth is a limitation of Bluetooth and the Windows operating system.

## Using GPS (select models only)

Your computer may be equipped with a Global Positioning System (GPS). GPS satellites deliver location, speed, and direction information to GPS-equipped systems.

For more information, refer to the HP Connection Manager or HP Wireless Assistant software Help.

## Connecting to a wired network

### Using a modem (select models only)

A modem must be connected to an analog telephone line using a 6-pin, RJ-11 modem cable (purchased separately). In some countries or regions, a specific modem cable adapter is also required. Jacks for digital PBX systems may resemble analog telephone jacks, but they are not compatible with the modem.

**⚠ WARNING!** To reduce the risk of electric shock, fire, or damage to the equipment, do not plug a modem or telephone cable into the RJ-45 (network) jack.

If the modem cable contains noise suppression circuitry **(1)**, which prevents interference from TV and radio reception, orient the circuitry end of the cable **(2)** toward the computer.



### Connecting a modem cable

1. Plug the modem cable into the modem jack **(1)** on the computer.
2. Plug the modem cable into the RJ-11 telephone wall jack **(2)**.

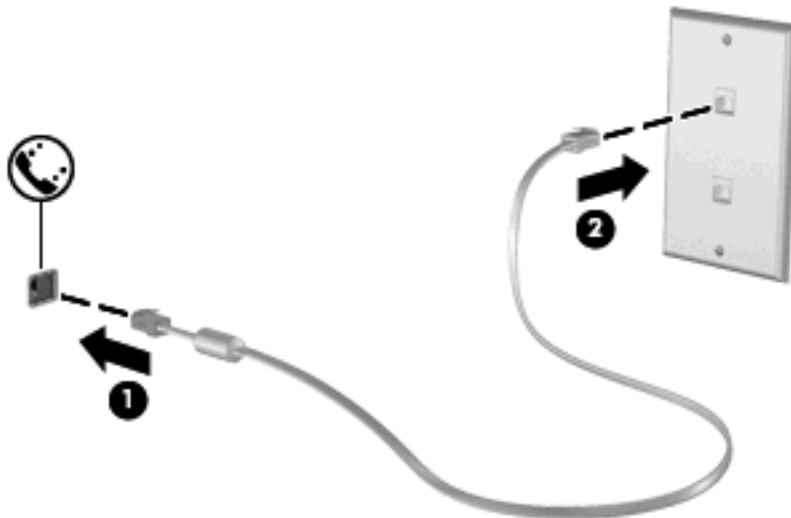

## Connecting a country- or region-specific modem cable adapter

Telephone jacks vary by country or region. To use the modem and the modem cable outside the country or region in which you purchased the computer, you must obtain a country- or region-specific modem cable adapter.

To connect the modem to an analog telephone line that does not have an RJ-11 telephone jack, follow these steps:

1. Plug the modem cable into the modem jack **(1)** on the computer.
2. Plug the modem cable into the modem cable adapter **(2)**.
3. Plug the modem cable adapter **(3)** into the telephone wall jack.

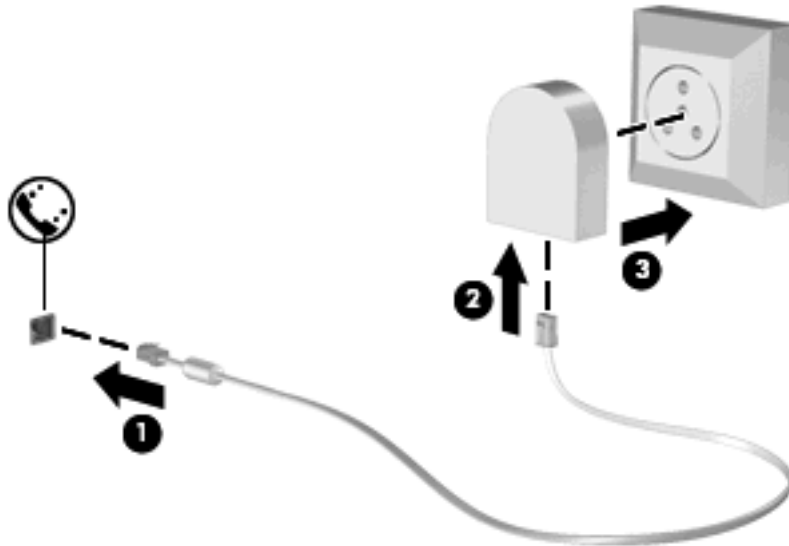

## Selecting a location setting

### Viewing the current location selection

#### Windows 7

1. Select **Start > Control Panel**.
2. Click **Clock, Language, and Region**.
3. Click **Region and Language**.
4. Click the **Location** tab to display your location.

#### Windows XP

1. Select **Start > Control Panel**.
2. Click **Date, Time, Language, and Regional Options**.
3. Click **Regional and Language Options**.

Your location is displayed under Location.

### Adding new locations when traveling

On a new computer, the only location setting available to the modem is a location setting for the country or region in which you purchased the computer. As you travel to different countries or regions, set the

internal modem to a location setting that meets the operating standards of the country or region in which you are using the modem.

As you add new location settings, they are saved by the computer so that you can switch among settings at any time. You can add multiple location settings for any country or region.

△ **CAUTION:** To reduce the risk of losing your home country or region settings, do not delete your current modem country or region settings. To enable modem use in other countries or regions while preserving your home country or region configuration, add a new configuration for each location in which you will use the modem.

**CAUTION:** To reduce the risk of configuring the modem in a way that violates the telecommunications regulations and laws of the country or region you are visiting, select the country or region in which the computer is located. The modem may not function properly if the correct country or region selection is not made.

---

## Windows 7

1. Select **Start > Devices and Printers**.
2. Right-click the device that represents your computer, and click **Modem settings**.

 **NOTE:** You must set up an initial (current) location area code before you can view the Dialing Rules tab. If you do not have a location already set up, you are prompted to enter the location when you click Modem settings.

3. Click the **Dialing Rules** tab.
4. Click **New**. The New Location window opens.
5. In the **Location name** box, type a name (such as **home** or **work**) for the new location setting.
6. Select a country or region from the **Country/region** list. (If you select a country or region that is not supported by the modem, the country/region selection for USA or UK is displayed.)
7. Enter the area code, a carrier code (if necessary), and the number for an outside line (if necessary).
8. Next to **Dial using**, click **Tone** or **Pulse**.
9. Click **OK** to save your new location setting. The Phone and Modem Options window opens.
10. Do one of the following:
  - To set your new location setting as the current location, click **OK**.
  - To select another location setting as the current location setting, select your preference from the settings in the **Location** list, and then click **OK**.

 **NOTE:** You can use the preceding procedure to add location settings for places within your own country or region as well as in other countries or regions. For example, you could add a setting named “Work” that includes dialing rules for accessing an outside line.

---

## Windows XP

1. Select **Start > Control Panel**.
2. Click **Printers and Other Hardware**.
3. Click **Phone and Modem Options**.
4. Click the **Dialing Rules** tab.
5. Click **New**. The New Location window opens.
6. In the **Location name** box, type a name (such as **home** or **work**) for the new location setting.

7. Select a country or region from the **Country/region** list. (If you select a country or region that is not supported by the modem, the country/region selection for USA or UK is displayed.)
8. Enter the area code, a carrier code (if necessary), and the number for an outside line (if necessary).
9. Next to **Dial using**, click **Tone** or **Pulse**.
10. Click **OK** to save your new location setting. The Phone and Modem Options window opens.
11. Do one of the following:
  - To set your new location setting as the current location, click **OK**.
  - To select another location setting as the current location setting, select your preference from the settings in the **Location** list, and then click **OK**.

 **NOTE:** You can use the preceding procedure to add location settings for places within your own country or region as well as in other countries or regions. For example, you could add a setting named “Work” that includes dialing rules for accessing an outside line.

## Connecting to a local area network (LAN) (select models only)

Connecting to a local area network (LAN) requires an 8-pin, RJ-45 network cable (purchased separately). If the network cable contains noise suppression circuitry (**1**), which prevents interference from TV and radio reception, orient the circuitry end of the cable (**2**) toward the computer.



To connect the network cable:

1. Plug the network cable into the network jack (**1**) on the computer.
2. Plug the other end of the network cable into a network wall jack (**2**).

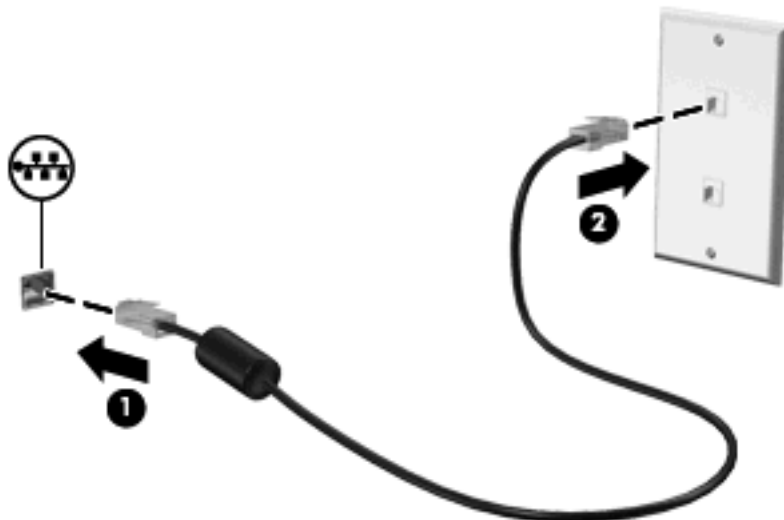

---

⚠ **WARNING!** To reduce the risk of electric shock, fire, or damage to the equipment, do not plug a modem cable or telephone cable into an RJ-45 (network) jack.

---

---

## 3 Multimedia

Your computer may include the following:

- One or two integrated speakers
- One or two integrated microphones
- Integrated webcam
- Preinstalled multimedia software
- Multimedia buttons or keys

### Using the media activity controls

Depending on your computer model, you may have the following media activity controls that allow you to play, pause, fast forward, or rewind a media file:

- Media buttons
- Media hotkeys (specific keys pressed in combination with the [fn](#) key)
- Media action keys

Refer to the *Getting Started* guide for information about your computer's media activity controls.

### Audio

Your computer provides a variety of audio-related opportunities:

- Play music.
- Record sound.
- Download music from the Internet.
- Create multimedia presentations.
- Transmit sound and images with instant messaging programs.
- Stream radio programs.
- Create (burn) audio CDs using the installed optical drive (select models only) or on an optional external optical drive (purchased separately).

### Adjusting the volume

Depending on your computer model, you can adjust the volume using the following:

- Volume buttons
- Volume hotkeys
- Volume keys



---

 **WARNING!** To reduce the risk of personal injury, adjust the volume before putting on headphones, earbuds, or a headset. For additional safety information, refer to the *Regulatory, Safety, and Environmental Notices*.

 **NOTE:** Volume can also be controlled through the operating system and some programs.

**NOTE:** Refer to the *Getting Started* guide for information on what type of volume controls your computer has.

---

## Checking audio functions on the computer

### Windows 7

To check the audio functions on your computer, follow these steps:

1. Select **Start > Control Panel > Hardware and Sound > Sound**.
2. When the Sound window opens, click the **Sounds** tab. Under **Program Events**, select any sound event, such as a beep or alarm, and click the **Test** button.

You should hear sound through the speakers or through connected headphones.

To check the recording functions on your computer, follow these steps:

1. Select **Start > All Programs > Accessories > Sound Recorder**.
2. Click **Start Recording** and speak into the microphone. Save the file to your desktop.
3. Open a multimedia program and play back the sound.

---

 **NOTE:** For best results when recording, speak directly into the microphone and record sound in a setting free of background noise.

---

To confirm or change the audio settings on your computer, select **Start > Control Panel > Hardware and Sound > Sound**.

### Windows XP

To check the audio functions on your computer, follow these steps:

1. Select **Start > Control Panel > Sounds, Speech, and Audio Devices > Sounds and Audio Devices**.
2. When the Sound and Audio Device Properties window opens, click the **Sounds** tab. Under **Program events**, select any sound event, such as a beep or alarm, and click the arrow button to check the sound.

You should hear sound through the speakers or through connected headphones.

To check the recording functions on your computer, follow these steps:

1. Select **Start > All Programs > Accessories > Entertainment > Sound Recorder**.
2. Click the recording button and speak into the microphone. Save the file to your desktop.
3. Open a multimedia program and play back the sound.

---

 **NOTE:** For best results when recording, speak directly into the microphone and record sound in a setting free of background noise.

---

To confirm or change the audio settings on your computer, right-click the **Volume** icon on the taskbar, or select **Start > Control Panel > Sounds, Speech, and Audio Devices > Sounds and Audio Devices**.

## Webcam (select models only)

Some computers include an integrated webcam, located at the top of the display. With the preinstalled software, you can use the webcam to take a photo or record a video. You can preview and save the photo or video recording.

The webcam software enables you to experiment with the following features:

- Capturing and sharing video
- Streaming video with instant message software
- Taking still photos

For information on how to access the webcam, refer to the *Getting Started* guide. For information on using the webcam, select **Start > Help and Support**.

## Using SkyRoom (select models only)

HP SkyRoom is a video tool that allows video conferencing and desktop sharing so that participants across the world can collaborate in real time.

You can utilize your existing Microsoft Office Communicator or Jabber contact lists or you can create your own list and add contacts manually. For more information, refer to the SkyRoom software Help.

## Video

Your computer may have one or more of the following external video ports:

- VGA
- DisplayPort
- HDMI

### VGA

The external monitor port, or VGA port, is an analog display interface that connects an external VGA display device such as an external VGA monitor or a VGA projector to the computer.

- ▲ To connect a VGA display device, connect the device cable to the external monitor port.

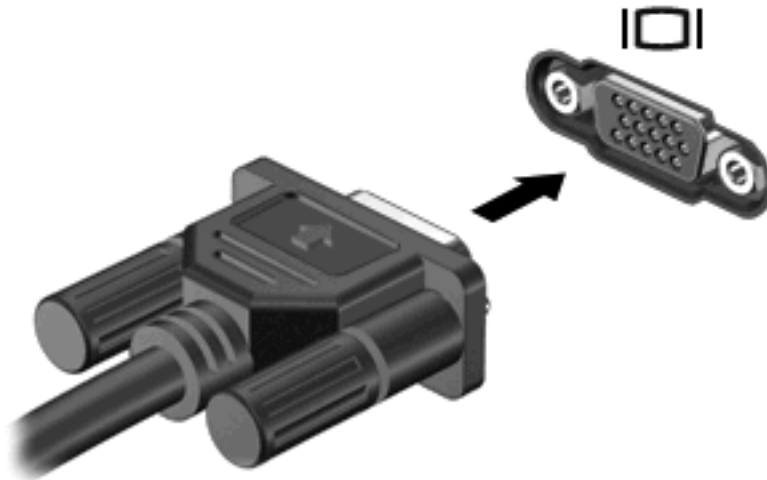

---

 **NOTE:** For product-specific instructions on switching the screen image, refer to your *Getting Started* guide.

---

## DisplayPort

The DisplayPort connects a digital display device such as a high-performance monitor or projector. The DisplayPort delivers higher performance than the VGA external monitor port and improves digital connectivity.

- ▲ To connect a digital display device, connect the device cable to the DisplayPort.



---

 **NOTE:** For product-specific instructions on switching the screen image, refer to your *Getting Started* guide.

---

## HDMI

The HDMI (High Definition Multimedia Interface) port connects the computer to an optional video or audio device, such as a high-definition television, or to any compatible digital or audio component.

---

 **NOTE:** To transmit video signals through the HDMI port, you need an HDMI cable (purchased separately).

---

One HDMI device can be connected to the HDMI port on the computer. The information displayed on the computer screen can be simultaneously displayed on the HDMI device.

To connect a video or audio device to the HDMI port:

1. Connect one end of the HDMI cable to the HDMI port on the computer.

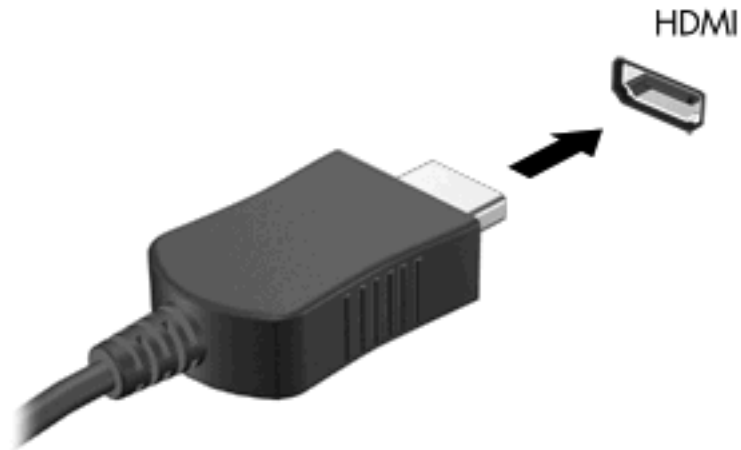

2. Connect the other end of the cable to the video device, and then refer to the device manufacturer's instructions for additional information.

---

 **NOTE:** For product-specific instructions on switching the screen image, refer to your *Getting Started* guide.

---

## Configuring audio for HDMI

To configure HDMI audio, first connect an audio or video device, such as a high-definition TV, to the HDMI port on your computer. Then configure the default audio playback device as follows:

1. Right-click the **Speakers** icon in the notification area, at the far right of the taskbar, and then click **Playback devices**.
2. On the **Playback** tab, click either **Digital Output** or **Digital Output Device (HDMI)**.
3. Click **Set Default**, and then click **OK**.

To return audio to the computer speakers, follow these steps:

1. Right-click the **Speakers** icon in the notification area, at the far right of the taskbar, and then click **Playback devices**.
2. On the **Playback** tab, click **Speakers**.
3. Click **Set Default**, and then click **OK**.

## Using HP MediaSmart (select models only)

HP MediaSmart turns your computer into a mobile entertainment center. With MediaSmart, you can enjoy music CDs and DVD and Blu-ray Disc (BD) movies. You can also manage and edit your photo collections. MediaSmart includes the following features:

- Playlist upload support:
  - Upload your MediaSmart photo playlists to Internet photo albums.
  - Upload your MediaSmart video playlists to YouTube.
  - Export your MediaSmart playlist to the CyberLink DVD Suite.
- Pandora Internet radio (North America only)—Listen to music selected just for you, streamed from the Internet.

▲ To start MediaSmart, select **Start > All Programs > HP > HP MediaSmart**.

For more information on using MediaSmart, select **Start > Help and Support**.

---

## 4 Power management

 **NOTE:** A computer may have a power button or a power switch. The term *power button* is used throughout this guide to refer to both types of power controls.

**NOTE:** Windows 7 uses *Sleep* and Windows XP uses *Standby*. The term *Sleep* is used throughout this guide to refer to both. Differences between the operating systems that affect any of the procedures are noted.

---

### Shutting down the computer

 **CAUTION:** Unsaved information is lost when the computer shuts down.

The Shut down command closes all open programs, including the operating system, and then turns off the display and computer.

Shut down the computer under any of the following conditions:

- When you need to replace the battery or access components inside the computer
- When you are connecting an external hardware device that does not connect to a USB port
- When the computer will be unused and disconnected from external power for an extended period

Although you can shut down the computer with the power button, the recommended procedure is to use the Windows Shut down command:

 **NOTE:** If the computer is in the Sleep state or in Hibernation, you must first exit Sleep or Hibernation before shutdown is possible.

---

1. Save your work and close all open programs.

2. **Windows 7**—Select **Start > Shut down**.

**Windows XP**—Select **Start > Turn Off Computer > Turn Off**.

 **NOTE:** If you have been registered to a network domain, the button you click is called Shut Down instead of Turn Off Computer.

---

If the computer is unresponsive and you are unable to use the preceding shutdown procedures, try the following emergency procedures in the sequence provided:

- **Windows 7**—Press **ctrl+alt+delete**, and then click the **Power** button.  
**Windows XP**—Press **ctrl+alt+delete**. Click **Shut Down**, and then click **Turn Off**.
- Press and hold the power button for at least 5 seconds.
- Disconnect the computer from external power and remove the battery.

### Setting power options

#### Using power-saving states

The computer has two power-saving states that are enabled at the factory: Sleep and Hibernation.

When Sleep is initiated, the power lights blink and the screen clears. Your work is saved to memory, letting you exit Sleep faster than exiting Hibernation. If the computer is in the Sleep state for an extended period or if the battery reaches a critical battery level while in the Sleep state, the computer initiates Hibernation.

When Hibernation is initiated, your work is saved to a hibernation file on the hard drive and the computer turns off.

 **CAUTION:** To reduce the risk of possible audio and video degradation, loss of audio or video playback functionality, or loss of information, do not initiate Sleep or Hibernation while reading from or writing to a disc or an external media card.

 **NOTE:** You cannot initiate any type of networking connection or perform any computer functions while the computer is in the Sleep state or in Hibernation.

## Initiating and exiting Sleep

The system is set at the factory to initiate Sleep after a period of inactivity when running on battery power or on external power.

Power settings and timeouts can be changed using Power Options in Windows® Control Panel.

With the computer on, you can initiate Sleep in any of the following ways:

- Briefly press the power button.
- Close the display.
- **Windows 7**—Select **Start**, click the arrow next to the Shut down button, and then click **Sleep**.
- **Windows XP**—Select **Start > Turn Off Computer > Stand By**.

To exit Sleep:

- Briefly press the power button.
- If the display is closed, open the display.
- Press a key on the keyboard.
- Tap or swipe the TouchPad.

When the computer exits Sleep, the power lights turn on and your work returns to the screen where you stopped working.

 **NOTE:** If you have set a password to be required on wakeup, you must enter your Windows password before your work will return to the screen.

## Initiating and exiting Hibernation

The system is set at the factory to initiate Hibernation after a period of inactivity when running on battery power or on external power, or when the battery reaches a critical battery level.

Power settings and timeouts can be changed in Windows Control Panel.

To initiate Hibernation:

 **Windows 7**—Select **Start**, click the arrow next to the Shut down button, and then click **Hibernate**.

**Windows XP**—Select **Start > Turn Off Computer**, and then hold down the **shift** key and select **Hibernate**.

To exit Hibernation:

- ▲ Briefly press the power button.

The power lights turn on and your work returns to the screen where you stopped working.

 **NOTE:** If you have set a password to be required on wakeup, you must enter your Windows password before your work will return to the screen.

---

## Using the power meter

The power meter is located in the notification area, at the far right of the taskbar. The power meter allows you to quickly access power settings and view the remaining battery charge.

- To display the percentage of remaining battery charge and the current power plan (or power scheme in Windows XP), move the pointer over the power meter icon.
- To access Power Options, or to change the power plan, click the power meter icon and select an item from the list.

Different power meter icons indicate whether the computer is running on battery or external power. The icon also displays a message if the battery has reached a low or critical battery level.

## Using power plans

A power plan (or power scheme in Windows XP) is a collection of system settings that manages how the computer uses power. Power plans can help you conserve power or maximize performance.

### Viewing the current power plan

Use any of the following methods:

- Click the power meter icon in the notification area, at the far right of the taskbar.
- **Windows 7**—Select **Start > Control Panel > System and Security > Power Options**.  
**Windows XP**—Select **Start > Control Panel > Performance and Maintenance > Power Options**.

### Selecting a different power plan

Use any of the following methods:

- Click the power meter icon in the notification area, and then select a power plan from the list.
- **Windows 7**—Select **Start > Control Panel > System and Security > Power Options**, and then select an item from the list.  
**Windows XP**—Select **Start > Control Panel > Performance and Maintenance > Power Options**, and then select an item from the list.

## Customizing power plans

### Windows 7

1. Click the power meter icon in the notification area, and then click **More power options**.  
– or –  
Select **Start > Control Panel > System and Security > Power Options**.
2. Select a power plan, and then click **Change plan settings**.



3. Change the settings as needed.
4. To change additional settings, click **Change advanced power settings** and make your changes.

#### Windows XP

1. Select **Start > Control Panel > Performance and Maintenance > Power Options**.
2. Select a power scheme from the **Power schemes** list.
3. Modify the **Plugged in** and **Running on batteries settings** as needed.
4. Click **OK**.

## Setting password protection on wakeup

#### Windows 7

To set the computer to prompt for a password when the computer exits Sleep or Hibernation, follow these steps:

1. Select **Start > Control Panel > System and Security > Power Options**.
2. In the left pane, click **Require a password on wakeup**.
3. Click **Change Settings that are currently unavailable**.
4. Click **Require a password (recommended)**.

---

 **NOTE:** If you need to create a user account password or change your current user account password, click **Create or change your user account password**, and then follow the on-screen instructions. If you do not need to create or change a user account password, go to step 5.

---

5. Click **Save changes**.

#### Windows XP

1. Right-click the **Power Meter** icon in the notification area, and then click **Adjust Power Properties**.
2. Click the **Advanced** tab.
3. Select the **Prompt for password when computer resumes from Standby** check box.
4. Click **Apply**.

## Using battery power

When a charged battery is in the computer and the computer is not plugged into external power, the computer runs on battery power. When the computer is plugged into external AC power, the computer runs on AC power.

If the computer contains a charged battery and is running on external AC power, the computer switches to battery power if the AC adapter is disconnected from the computer.

---

 **NOTE:** When you disconnect AC power, the display brightness is automatically decreased to save battery life. For information on increasing or decreasing display brightness, refer to the *Getting Started* guide.

---

Select computer models can switch between graphic modes to increase battery life. For more information, refer to [Switching between graphics modes \(select models only\) on page 28](#).

---

You can keep a battery in the computer or in storage, depending on how you work. Keeping the battery in the computer whenever the computer is plugged into AC power charges the battery and also protects your work in case of a power outage. However, a battery in the computer slowly discharges when the computer is off and unplugged from external power.

**⚠ WARNING!** To reduce potential safety issues, use only the battery provided with the computer, a replacement battery provided by HP, or a compatible battery purchased from HP.

Computer battery life varies, depending on power management settings, programs running on the computer, display brightness, external devices connected to the computer, and other factors.

## Finding battery information in Help and Support in Windows 7

Help and Support provides the following tools and information about the battery:

- Battery Check tool to test battery performance
- Information on calibration, power management, and proper care and storage to maximize battery life
- Information on battery types, specifications, life cycles, and capacity

To access battery information:

- ▲ Select **Start > Help and Support > Learn > Power Plans: Frequently Asked Questions.**

## Using Battery Check in Windows 7

Battery Check in Help and Support provides information on the status of the battery installed in the computer.

To run Battery Check:

1. Connect the AC adapter to the computer.

**📝 NOTE:** The computer must be connected to external power for Battery Check to work properly.

2. Select **Start > Help and Support > Troubleshoot > Power, Thermal and Mechanical.**
3. Click the **Power** tab, and then click **Battery Check.**

Battery Check examines the battery and its cells to see if they are functioning properly, and then reports the results of the examination.

## Displaying the remaining battery charge

- ▲ Move the pointer over the power meter icon in the notification area, at the far right of the taskbar.

## Maximizing battery discharge time

Battery discharge time varies depending on the features you use while on battery power. Maximum discharge time gradually decreases as the battery storage capacity naturally degrades.

Tips for maximizing battery discharge time:

- Lower the brightness on the display.
- Remove the battery from the computer when it is not being used or charged.
- Store the battery in a cool, dry location.
- **Windows 7**—Select the **Power saver** setting in Power Options.

## Managing low battery levels

The information in this section describes the alerts and system responses set at the factory. Some low-battery alerts and system responses can be changed using Power Options in Windows Control Panel. Preferences set using Power Options do not affect lights.

### Identifying low battery levels

When a battery that is the sole power source for the computer reaches a low or critical battery level, the following behavior occurs:

- The battery light (select models only) indicates a low or critical battery level.

 **NOTE:** For additional information about the battery light, refer to the [Getting Started](#) guide.

– or –

- The power meter icon in the notification area shows a low or critical battery notification.

 **NOTE:** For additional information about the power meter, refer to [Using the power meter on page 22](#).

The computer takes the following actions for a critical battery level:

- If Hibernation is enabled and the computer is on or in the Sleep state, the computer initiates Hibernation.
- If Hibernation is disabled and the computer is on or in the Sleep state, the computer remains briefly in the Sleep state, and then shuts down and loses any unsaved information.

### Resolving a low battery level

#### Resolving a low battery level when external power is available

 Connect one of the following devices:

- AC adapter
- Optional docking or expansion device
- Optional power adapter purchased as an accessory from HP

#### Resolving a low battery level when a charged battery is available

1. Turn off the computer or initiate Hibernation.
2. Replace the discharged battery with a charged battery.
3. Turn on the computer.

#### Resolving a low battery level when no power source is available

- Initiate Hibernation.
- Save your work and shut down the computer.

## Resolving a low battery level when the computer cannot exit Hibernation

When the computer lacks sufficient power to exit Hibernation, follow these steps:

1. Replace the discharged battery with a charged battery, or connect the AC adapter to the computer and to external power.
2. Exit Hibernation by pressing the power button.

## Conserving battery power

- Select low power-use settings through Power Options in Windows Control Panel.
- Turn off wireless and local area network (LAN) connections and exit modem applications when you are not using them.
- Disconnect unused external devices that are not plugged into an external power source.
- Stop, disable, or remove any external media cards that you are not using.
- Decrease screen brightness.
- Before you leave your work, initiate Sleep or Hibernation, or shut down the computer.

## Storing a battery

---

△ **CAUTION:** To reduce the risk of damage to a battery, do not expose it to high temperatures for extended periods of time.

---

If a computer will be unused and unplugged from external power for more than 2 weeks, remove the battery and store it separately.

To prolong the charge of a stored battery, place it in a cool, dry place.

---

📄 **NOTE:** A stored battery should be checked every 6 months. If the capacity is less than 50 percent, recharge the battery before returning it to storage.

---

Calibrate a battery before using it if it has been stored for one month or more.

## Disposing of a used battery

---

△ **WARNING!** To reduce the risk of fire or burns, do not disassemble, crush, or puncture; do not short external contacts; do not dispose of in fire or water.

---

Refer to the *Regulatory, Safety, and Environmental Notices* for proper battery disposal.

## Replacing the battery

In Windows 7, Battery Check in Help and Support notifies you to replace the battery when an internal cell is not charging properly or when the battery storage capacity has reached a weak condition. If the battery is possibly covered by an HP warranty, instructions include a warranty ID. A message refers you to the HP Web site for more information about ordering a replacement battery.

## Using external AC power

 **NOTE:** For information on connecting to AC power, refer to the *Quick Setup* poster provided in the computer box.

External AC power is supplied through an approved AC adapter or an optional docking or expansion device.

 **WARNING!** To reduce potential safety issues, use only the AC adapter provided with the computer, a replacement AC adapter provided by HP, or a compatible AC adapter purchased from HP.

Connect the computer to external AC power under any of the following conditions:

 **WARNING!** Do not charge the computer battery while you are onboard aircraft.

- When charging or calibrating a battery
- When installing or modifying system software
- When writing information to a CD, a DVD, or a BD (select models only)
- When running Disk Defragmenter
- When performing a backup or recovery

When you connect the computer to external AC power, the following events occur:

- The battery begins to charge.
- If the computer is turned on, the power meter icon in the notification area changes appearance.

When you disconnect external AC power, the following events occur:

- The computer switches to battery power.
- The display brightness is automatically decreased to save battery life.

## Testing an AC adapter

Test the AC adapter if the computer exhibits any of the following symptoms when it is connected to AC power:

- The computer does not turn on.
- The display does not turn on.
- The power lights are off.

To test the AC adapter:

1. Shut down the computer.
2. Remove the battery from the computer.
3. Connect the AC adapter to the computer, and then plug it into an AC outlet.
4. Turn on the computer.
  - If the power lights turn **on**, the AC adapter is working properly.
  - If the power lights remain **off**, the AC adapter is not functioning and should be replaced.

Contact technical support for information on obtaining a replacement AC power adapter.

## Switching between graphics modes (select models only)

Select computers are equipped with switchable graphics and have two modes for processing graphics. When you switch from AC power to battery power, the computer can switch from using the high-performance mode to using the power-saving mode to conserve battery life. Similarly, when you switch from battery power to AC power, the computer can switch back to the high-performance mode.

---

 **NOTE:** In some instances, in order to optimize performance of the computer, the system does not allow you to switch modes, or it may prompt you to switch. It may also be necessary to close all programs before switching.

**NOTE:** HDMI (select models only) only works in the high-performance mode. If you use the power-saving mode, you can not use HDMI.

---

When you switch between AC and battery power, you are notified that the computer is about to switch graphics modes. If you prefer, you can choose to continue using the same graphics mode. While the computer switches modes, the screen goes blank for a few seconds. When the switch is complete, a notification appears in the notification area, and the screen image reappears.

---

 **NOTE:** When select computer models are in slate mode, the screen orientation is reset when you switch between graphics modes.

---

To determine which graphics mode you are using:

- ▲ Right-click on a blank area of the computer desktop, and then click **Configure Switchable Graphics** or **Configure ATI PowerXpress™**.

---

## 5 External cards and devices

### Using Digital Media Slot cards (select models only)

Optional digital cards provide secure data storage and convenient data sharing. These cards are often used with digital media–equipped cameras and PDAs as well as with other computers.

To determine the digital card formats that are supported on your computer, refer to the *Getting Started* guide.

#### Inserting a digital card

△ **CAUTION:** To reduce the risk of damage to the digital card connectors, use minimal force to insert a digital card.

1. Hold the card label-side up, with the connectors facing the computer.
2. Insert the card into the Digital Media Slot, and then press in on the card until it is firmly seated.

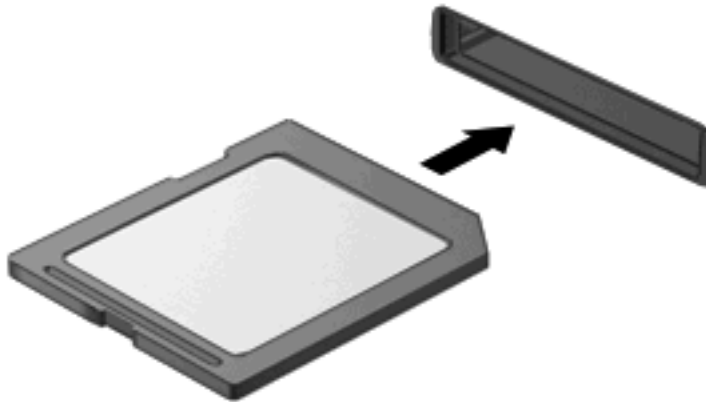

You will hear a sound when the device has been detected, and a menu of options may be displayed.

#### Removing a digital card

△ **CAUTION:** To reduce the risk of loss of data or an unresponsive system, use the following procedure to safely remove the digital card.

1. Save your information and close all programs associated with the digital card.
2. Click the remove hardware icon in the notification area, at the far right of the taskbar. Then follow the on-screen instructions.

3. Either press in on the card (1), and then remove it from the slot (2).

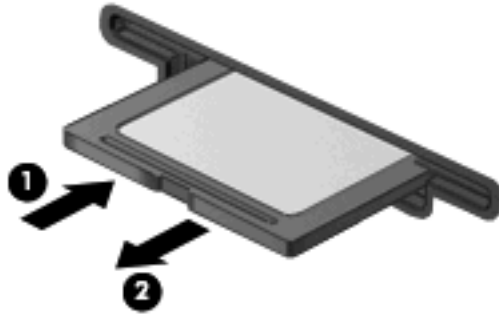

– or –

Pull the card out of the slot.

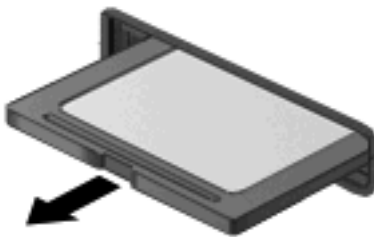

## Using PC Cards (select models only)

A PC Card is a credit card–sized accessory designed to conform to the standard specifications of the Personal Computer Memory Card International Association (PCMCIA). The PC Card slot supports the following types of PC Cards:

- 32-bit (CardBus) and 16-bit PC Cards
- Type I and Type II PC Cards

---

 **NOTE:** Zoomed video PC Cards and 12-V PC Cards are not supported.

---

## Configuring a PC Card

To reduce the risk of loss of support for other PC Cards during configuration, install only the software required for the device. If you are instructed by the PC Card manufacturer to install device drivers:

- Install only the device drivers for your operating system.
- Do not install other software, such as card services, socket services, or enablers, supplied by the PC Card manufacturer.

## Inserting a PC Card

---

 **CAUTION:** To prevent damage to the computer and external media cards, do not insert an ExpressCard into a PC Card slot.

---



**CAUTION:** To reduce the risk of damage to the connectors:

Use minimal force when inserting a PC Card.

Do not move or transport the computer when a PC Card is in use.

The PC Card slot may contain a protective insert. The insert must be removed before you can insert a PC Card:

1. Press the PC Card eject button (1).  
This action extends the button into position for releasing the insert.
2. Press the PC Card eject button again to release the insert.
3. Pull the insert out of the slot (2).

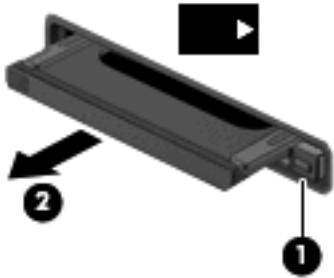

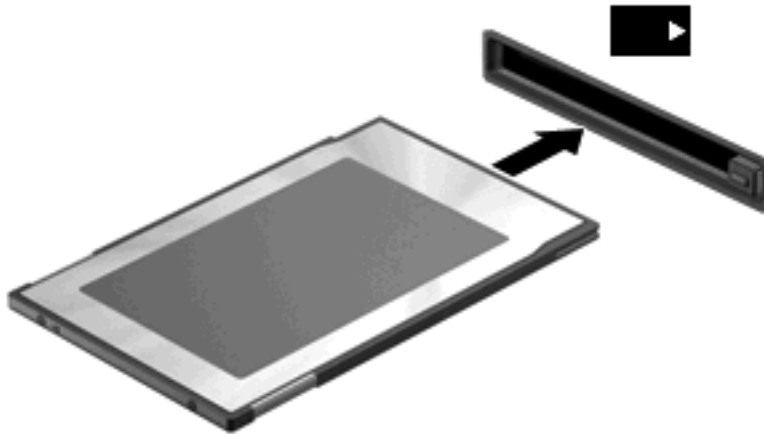

To insert a PC Card:

1. Hold the card label-side up, with the connectors facing the computer.
2. Insert the card into the PC Card slot, and then press in on the card until it is firmly seated.



You will hear a sound when the card has been detected, and a menu of available options may be displayed.

 **NOTE:** The first time you connect a PC Card, a message in the notification area lets you know that the device is recognized by the computer.

 **NOTE:** To conserve power, stop or remove a PC Card when it is not in use.

## Removing a PC Card

△ **CAUTION:** To reduce the risk of loss of data or an unresponsive system, stop a PC Card before removing it.

1. Save your information and close all programs associated with the PC Card.
2. Click the remove hardware icon in the notification area, at the far right of the taskbar, and then follow the on-screen instructions.
3. Release and remove the PC Card:
  - a. Press the PC Card eject button (1).  
This action extends the button into position for releasing the PC Card.
  - b. Press the PC Card eject button again to release the PC Card.
  - c. Pull the PC Card (2) out of the slot.

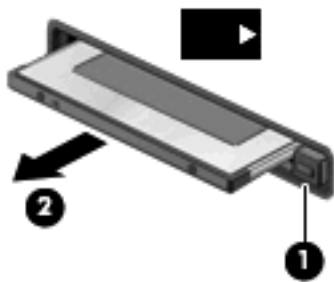

## Using ExpressCards (select models only)

An ExpressCard is a high-performance PC Card that is inserted into the ExpressCard slot.

Like standard PC Cards, ExpressCards are designed to conform to the standard specifications of the Personal Computer Memory Card International Association (PCMCIA).

## Configuring an ExpressCard

Install only the software required for the card. If you are instructed by the ExpressCard manufacturer to install device drivers:

- Install only the device drivers for your operating system.
- Do not install additional software, such as card services, socket services, or enablers, that are supplied by the ExpressCard manufacturer.

## Inserting an ExpressCard

△ **CAUTION:** To prevent damage to the computer and external media cards, do not insert a PC Card into an ExpressCard slot.

**CAUTION:** To reduce the risk of damage to the connectors:

Use minimal force when inserting an ExpressCard.

Do not move or transport the computer when an ExpressCard is in use.

The ExpressCard slot may contain a protective insert. To remove the insert:

1. Press in on the insert **(1)** to unlock it.
2. Pull the insert out of the slot **(2)**.

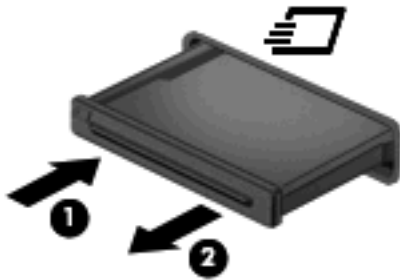

To insert an ExpressCard:

1. Hold the card label-side up, with the connectors facing the computer.
2. Insert the card into the ExpressCard slot, and then press in on the card until it is firmly seated.

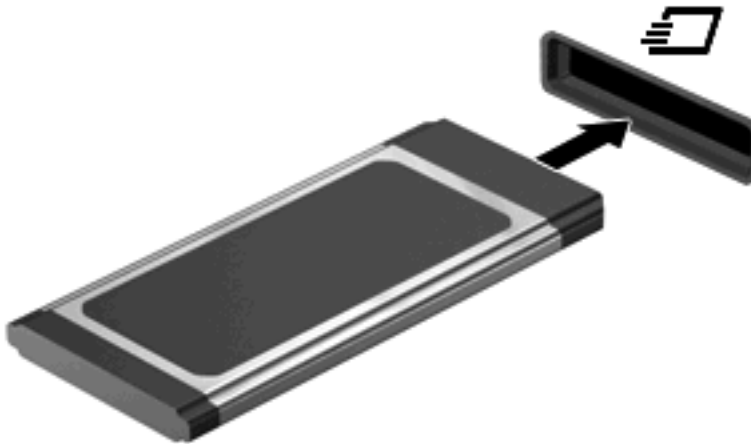

You will hear a sound when the card has been detected, and a menu of options may be displayed.

📄 **NOTE:** The first time you connect an ExpressCard, a message in the notification area lets you know that the card is recognized by the computer.

📄 **NOTE:** To conserve power, stop or remove an ExpressCard when it is not in use.

## Removing an ExpressCard

△ **CAUTION:** To reduce the risk of loss of data or an unresponsive system, use the following procedure to safely remove the ExpressCard.

1. Save your information and close all programs associated with the ExpressCard.
2. Click the remove hardware icon in the notification area, at the far right of the taskbar, and then follow the on-screen instructions.
3. Release and remove the ExpressCard:
  - a. Gently press in on the ExpressCard **(1)** to unlock it.
  - b. Pull the ExpressCard out of the slot **(2)**.

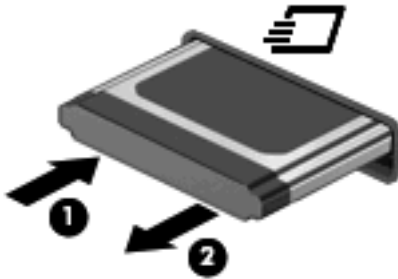

## Using smart cards (select models only)

📄 **NOTE:** The term *smart card* is used throughout this chapter to refer to both smart cards and Java™ Cards.

A smart card is a credit card–sized accessory that carries a microchip containing memory and a microprocessor. Like personal computers, smart cards have an operating system to manage input and output, and they include security features to protect against tampering. Industry-standard smart cards are used with the smart card reader (select models only).

A personal identification number (PIN) is needed to gain access to the contents of the microchip. For more information about smart card security features, refer to Help and Support.

## Inserting a smart card

1. Hold the card label-side up, and gently slide the card into the smart card reader until the card is seated.

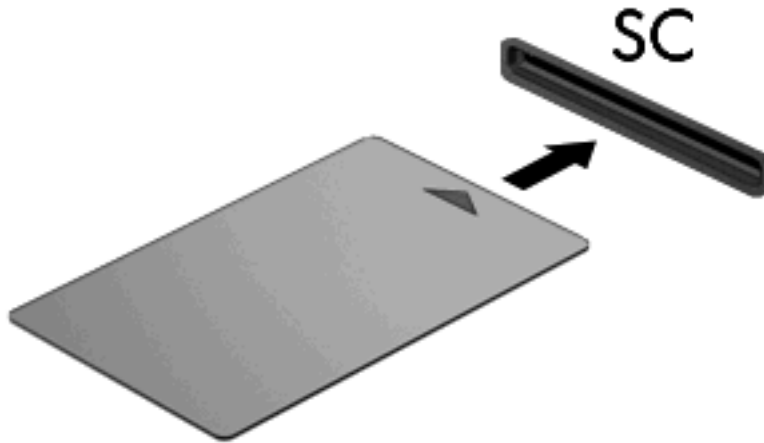

2. Follow the on-screen instructions for logging on to the computer using the smart card PIN.

## Removing a smart card

- ▲ Grasp the edge of the smart card, and then pull it out of the smart card reader.

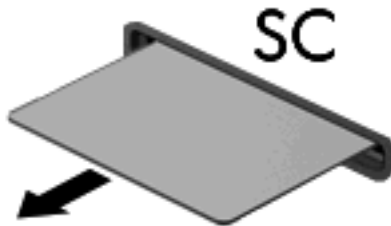

## Using a USB device

Universal Serial Bus (USB) is a hardware interface that can be used to connect an optional external device, such as a USB keyboard, mouse, drive, printer, scanner, or hub.

Some USB devices may require additional support software, which is usually included with the device. For more information about device-specific software, refer to the manufacturer's instructions. These instructions may be provided with the software, on disc, or on the manufacturer's Web site.

The computer has at least 1 USB port that supports USB 1.0, 1.1, 2.0, or 3.0 devices. Your computer may also have a powered USB port that provides power to an external device if it is used with a powered USB cable. An optional docking device or USB hub provides additional USB ports that can be used with the computer.

## Connecting a USB device

- △ **CAUTION:** To reduce the risk of damage to a USB connector, use minimal force to connect the device.

- ▲ Connect the USB cable for the device to the USB port.

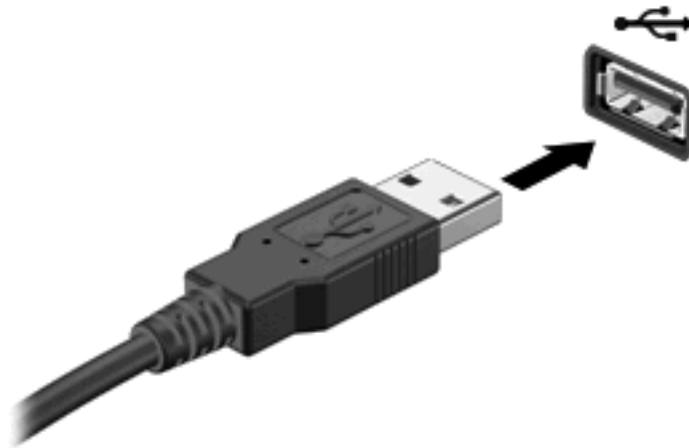

You will hear a sound when the device has been detected.

**NOTE:** The first time you connect a USB device, a message in the notification area lets you know that the device is recognized by the computer.

## Removing a USB device

△ **CAUTION:** To reduce the risk of damage to a USB connector, do not pull on the cable to remove the USB device.

**CAUTION:** To reduce the risk of loss of information or an unresponsive system, use the following procedure to safely remove the USB device.

1. To remove a USB device, save your information and close all programs associated with the device.
2. Click the remove hardware icon in the notification area, at the far right of the taskbar, and then follow the on-screen instructions.
3. Remove the device.

## Using 1394 devices (select models only)

IEEE 1394 is a hardware interface that connects a high-speed multimedia or data storage device to the computer. Scanners, digital cameras, and digital camcorders often require a 1394 connection.

Some 1394 devices may require additional support software, which is usually included with the device. For more information about device-specific software, refer to the manufacturer's instructions.

The 1394 port also supports IEEE 1394a devices.

## Connecting a 1394 device

△ **CAUTION:** To reduce the risk of damage to a 1394 port connector, use minimal force to connect the device.

- ▲ To connect a 1394 device to the computer, connect the 1394 cable for the device to the 1394 port.

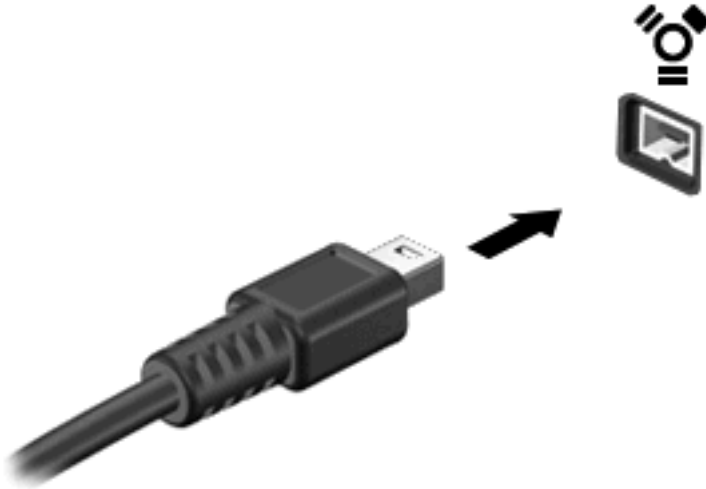

You will hear a sound when the device has been detected.

## Removing a 1394 device

△ **CAUTION:** To reduce the risk of loss of information or an unresponsive system, stop the 1394 device before removing it.

**CAUTION:** To reduce the risk of damage to a 1394 connector, do not pull on the cable to remove the 1394 device.

1. To remove a 1394 device, save your information and close all programs associated with the device.
2. Click the remove hardware icon in the notification area, at the far right of the taskbar, and then follow the on-screen instructions.
3. Remove the device.

## Using an eSATA device (select models only)

An eSATA port connects an optional high-performance eSATA component, such as an eSATA external hard drive.

Some eSATA devices may require additional support software, which is usually included with the device. For more information about device-specific software, refer to the manufacturer's instructions.

📄 **NOTE:** The eSATA port also supports an optional USB device.

## Connecting an eSATA device

△ **CAUTION:** To reduce the risk of damage to an eSATA port connector, use minimal force to connect the device.

- ▲ To connect an eSATA device to the computer, connect the eSATA cable for the device to the eSATA port.

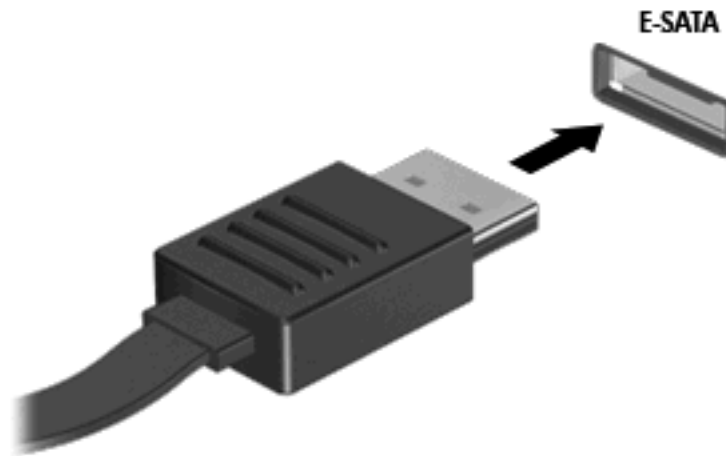

You will hear a sound when the device has been detected.

## Removing an eSATA device

- △ **CAUTION:** To reduce the risk of damage to an eSATA connector, do not pull on the cable to remove the eSATA device.

**CAUTION:** To reduce the risk of loss of information or an unresponsive system, use the following procedure to safely remove the device.

1. To remove an eSATA device, save your information and close all programs associated with the device.
2. Click the remove hardware icon in the notification area, at the far right of the taskbar, and then follow the on-screen instructions.
3. Remove the device.



## Using optional external devices

 **NOTE:** For more information about required software and drivers, or to learn which computer port to use, refer to the manufacturer's instructions.

---

To connect an external device to the computer:

 **CAUTION:** To reduce the risk of damage to the equipment when connecting a powered device, be sure that the device is turned off and the AC power cord is unplugged.

---

1. Connect the device to the computer.
2. If you are connecting a powered device, plug the device power cord into a grounded AC outlet.
3. Turn on the device.

To disconnect an unpowered external device, turn off the device, and then disconnect it from the computer. To disconnect a powered external device, turn off the device, disconnect it from the computer, and then unplug the AC power cord.

## Using optional external drives

Removable external drives expand your options for storing and accessing information. A USB drive can be added by connecting the drive to a USB port on the computer.

 **NOTE:** HP external USB optical drives should be connected to the powered USB port on the computer.

---

USB drives include the following types:

- 1.44-megabyte diskette drive
- Hard drive module (a hard drive with an adapter attached)
- External optical drive (CD, DVD, and Blu-ray)
- MultiBay device

## Using the expansion port (select models only)

The expansion port connects the computer to an optional docking or expansion device, so that additional ports and connectors can be used with the computer.

 **NOTE:** The computer has only one expansion port. The term *expansion port 3* describes the type of expansion port.

---



### Using the docking connector (select models only)

The docking connector connects the computer to an optional docking device. An optional docking device provides additional ports and connectors that can be used with the computer.

 **NOTE:** The following image may look slightly different than your computer or docking device.

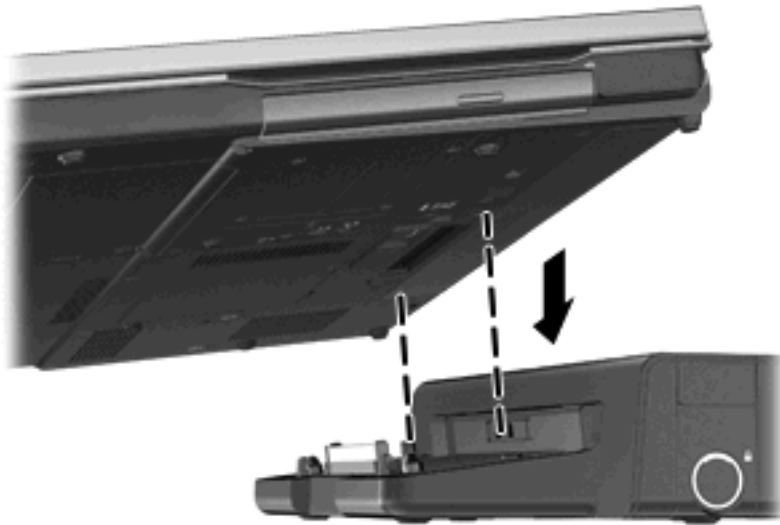

---

# 6 Drives

## Handling drives

Drives are fragile computer components that must be handled with care. Refer to the following cautions before handling drives. Additional cautions are included with the procedures to which they apply.

Observe these precautions:

- Before you move a computer that is connected to an external hard drive, initiate Sleep and allow the screen to clear, or properly disconnect the external hard drive.
- Before handling a drive, discharge static electricity by touching the unpainted metal surface of the drive.
- Do not touch the connector pins on a removable drive or on the computer.
- Handle a drive carefully; do not drop a drive or place items on it.
- Before removing or inserting a drive, shut down the computer. If you are unsure whether the computer is off, in the Sleep state, or in Hibernation, turn the computer on, and then shut it down through the operating system.
- Do not use excessive force when inserting a drive into a drive bay.
- Do not type on the keyboard or move the computer while an optical drive is writing to a disc. The write process is sensitive to vibration.
- When the battery is the only source of power, be sure that the battery is sufficiently charged before writing to media.
- Avoid exposing a drive to temperature or humidity extremes.
- Avoid exposing a drive to liquids. Do not spray the drive with cleaning products.
- Remove media from a drive before removing the drive from the drive bay, or traveling with, shipping, or storing a drive.
- If a drive must be mailed, place the drive in a bubble-pack mailer or other suitable protective packaging and label the package "FRAGILE."
- Avoid exposing a drive to magnetic fields. Security devices with magnetic fields include airport walk-through devices and security wands. Airport conveyer belts and similar security devices that check carry-on baggage use X-rays instead of magnetism and do not damage drives.

## Using hard drives

### Improving hard drive performance

#### Using Disk Defragmenter

As you use the computer, files on the hard drive become fragmented. Disk Defragmenter consolidates the fragmented files and folders on the hard drive so that the system can run more efficiently.

---

 **NOTE:** It is not necessary to run Disk Defragmenter on solid-state drives.

---

After you start Disk Defragmenter, it works without supervision. Depending on the size of your hard drive and the number of fragmented files, Disk Defragmenter may take more than an hour to complete. You may want to set it to run during the night or at another time when you do not need access to your computer.

HP recommends defragmenting your hard drive at least once a month. You may set Disk Defragmenter to run on a monthly schedule, but you can defragment your computer manually at any time.

To run Disk Defragmenter:

1. Connect the computer to AC power.
2. Select **Start > All Programs > Accessories > System Tools > Disk Defragmenter**.
3. **Windows 7**—Click **Defragment disk**.

---

 **NOTE:** Windows includes the User Account Control feature to improve the security of your computer. You may be prompted for your permission or password for tasks such as installing software, running utilities, or changing Windows settings. Refer to Help and Support for more information.

---

**Windows XP**— Under **Volume**, click the listing for the hard drive, usually listed as (C:), and then click **Defragment**.

For additional information, access the Disk Defragmenter software Help.

## Using Disk Cleanup

Disk Cleanup searches the hard drive for unnecessary files that you can safely delete to free up disk space and help the computer to run more efficiently.

To run Disk Cleanup:

1. Select **Start > All Programs > Accessories > System Tools > Disk Cleanup**.
2. Follow the on-screen instructions.

## Using HP ProtectSmart Hard Drive Protection in Windows 7 (select models only)

HP ProtectSmart Hard Drive Protection protects a hard drive by parking the drive and halting data requests under either of the following conditions:

- You drop the computer.
- You move the computer with the display closed while the computer is running on battery power.

A short time after the end of one of these events, HP ProtectSmart Hard Drive Protection returns the hard drive to normal operation.

---

 **NOTE:** Because solid-state drives (SSD) lack moving parts, HP ProtectSmart Hard Drive Protection is unnecessary.

---

**NOTE:** Hard drives in the primary hard drive bay or in the secondary hard drive bay are protected by HP ProtectSmart Hard Drive Protection. Hard drives connected to USB ports are not covered by HP ProtectSmart Hard Drive Protection.

---

For more information, refer to the HP ProtectSmart Hard Drive Protection software Help.

## Identifying HP ProtectSmart Hard Drive Protection status

The drive light on the computer changes color to show that a drive in the primary hard drive bay or a drive in the secondary hard drive bay (select models only) is parked. To determine whether drives are currently protected or whether a drive is parked, select **Start > Control Panel > Hardware and Sound > Windows Mobility Center**:

- If HP ProtectSmart Hard Drive Protection is enabled, a green check mark is superimposed over the hard drive icon.
- If HP ProtectSmart Hard Drive Protection is disabled, a red X is superimposed over the hard drive icon.
- If the drives are parked, a yellow moon is superimposed over the hard drive icon.

The icon in the Mobility Center may not show the most up-to-date status for the drive. For immediate updates after a change in status, you need to enable the notification area icon.

To enable the notification area icon:

1. Select **Start > Control Panel > Hardware and Sound > HP ProtectSmart Hard Drive Protection**.

---

 **NOTE:** If prompted by User Account Control, click **Yes**.

---

2. On the **Icon in System Tray** row, click **Show**.
3. Click **OK**.

## Managing power with a parked hard drive

If HP ProtectSmart Hard Drive Protection has parked the drive, the computer behaves in the following ways:

- The computer will not shut down.
- The computer will not initiate Sleep or Hibernation, except as described in the following Note.

---

 **NOTE:** If the computer is running on battery power and reaches a critical battery level, HP ProtectSmart Hard Drive Protection allows the computer to initiate Hibernation.

---

Before you move the computer, HP recommends that you either shut it down or initiate Sleep or Hibernation.

## Using HP ProtectSmart Hard Drive Protection software

The HP ProtectSmart Hard Drive Protection software can be enabled or disabled by an Administrator.

---

 **NOTE:** Depending on your user privileges, you may be unable to enable or disable HP ProtectSmart Hard Drive Protection. Privileges for non-Administrator users can be changed by members of an Administrator group.

---

To open the software and change settings, follow these steps:

1. In Mobility Center, click the hard drive icon to open the HP ProtectSmart Hard Drive Protection window.

– or –

Select **Start > Control Panel > Hardware and Sound > HP ProtectSmart Hard Drive Protection**.

---

 **NOTE:** If prompted by User Account Control, click **Yes**.

---

2. Click the appropriate button to change settings.
3. Click **OK**.

## Using optical drives (select models only)

Optical drives include the following:

- CD
- DVD
- Blu-ray (BD)

### Identifying the installed optical drive

▲ **Windows 7**—Select **Start > Computer**.

**Windows XP**—Select **Start > My Computer**.

A list of all the devices installed in your computer, including your optical drive, is displayed.

## Inserting an optical disc

### Tray load

1. Turn on the computer.
2. Press the release button (1) on the drive bezel to release the disc tray.
3. Pull out the tray (2).
4. Hold the disc by the edges to avoid touching the flat surfaces and position the disc label-side up over the tray spindle.

 **NOTE:** If the tray is not fully accessible, tilt the disc carefully to position it over the spindle.

5. Gently press the disc (3) down onto the tray spindle until the disc snaps into place.

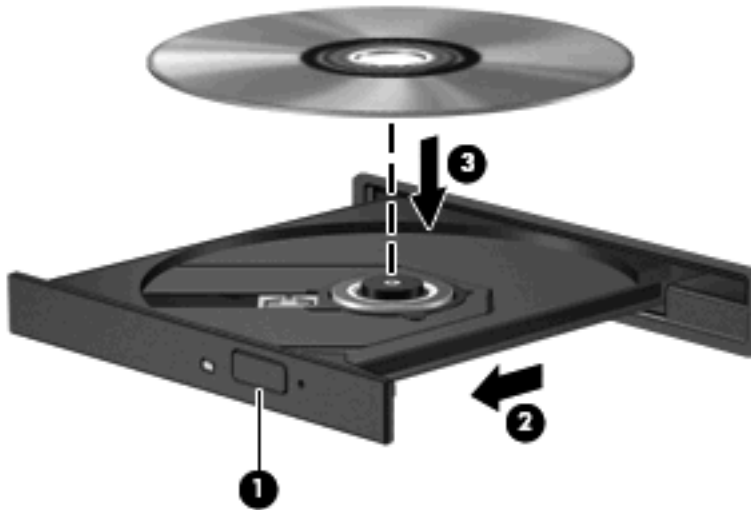

6. Close the disc tray.

 **NOTE:** After you insert a disc, a short pause is normal. If you have not selected a media player, an AutoPlay dialog box opens. It prompts you to select how you want to use the media content.

### Slot load

 **CAUTION:** Do not insert **8-cm** optical discs into a slot load optical drive. It may cause damage to the optical drive.

1. Turn on the computer.
2. Hold the disc by the edges to avoid touching the flat surfaces and position the disc label-side up.

3. Gently slide the disc into the slot load optical drive.



## Removing an optical disc

### Tray load

There are 2 ways to remove a disc, depending on whether the disc tray opens normally or not.

#### When the disc tray opens normally

1. Press the release button (1) on the drive bezel to release the disc tray, and then gently pull out the tray (2) until it stops.
2. Remove the disc (3) from the tray by gently pressing down on the spindle while lifting the outer edges of the disc. Hold the disc by the edges and avoid touching the flat surfaces.

 **NOTE:** If the tray is not fully accessible, tilt the disc carefully as you remove it.



3. Close the disc tray and place the disc in a protective case.

#### When the disc tray fails to open

1. Insert the end of a paper clip (1) into the release access in the front bezel of the drive.
2. Press in gently on the paper clip until the tray is released, and then pull out the tray (2) until it stops.



3. Remove the disc (3) from the tray by gently pressing down on the spindle while lifting the outer edges of the disc. Hold the disc by the edges and avoid touching the flat surfaces.

 **NOTE:** If the tray is not fully accessible, tilt the disc carefully as you remove it.

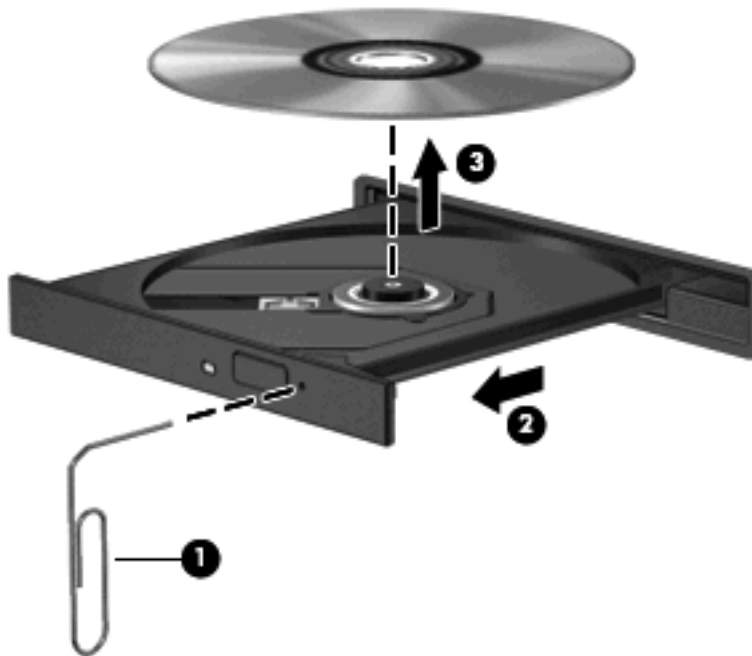

4. Close the disc tray and place the disc in a protective case.

### Slot load

1. Press the release button (1) next to the drive.
2. Remove the disc (2) by holding it by the edges and avoid touching the flat surfaces.



3. Place the disc in a protective case.

## Sharing optical drives

Although your computer may not have an integrated optical drive, you can access software and data, and install applications, by sharing an optical drive connected to another computer in your network. Sharing drives is a feature of the Windows operating system that allows a drive on one computer to be accessible to other computers on the same network.

 **NOTE:** You must have a network set up in order to share an optical drive; refer to [Networking \(select models only\) on page 2](#) for additional information on setting up a network.

**NOTE:** Some discs, such as DVD movies and game discs, may be copy-protected and therefore unusable through DVD or CD drive sharing.

---

To share an optical drive:

- 1. Windows 7**—From the computer with the optical drive you are sharing, select **Start > Computer**.  
**Windows XP**—From the computer with the optical drive you are sharing, select **Start > My Computer**.
- Right-click the optical drive you want to share, and click **Properties**.
- Windows 7**—Select the **Sharing** tab > **Advanced Sharing**.  
**Windows XP**—Select the **Sharing** tab.
- Select the **Share this folder** check box.
- Type a name for the optical drive in the **Share name** text box.
- Click **Apply**, and then click **OK**.
- To view the shared optical drive:  
**Windows 7**—Select **Start > Control Panel > Network and Internet > Network and Sharing Center**.  
**Windows XP**—Select **Start > Control Panel > Network and Internet Connections**.

## Using RAID (select models only)

Redundant Arrays of Independent Disks (RAID) technology allows a computer to use two or more hard disks at the same time. RAID treats multiple drives as one contiguous drive, either through hardware or software settings. If multiple disks are set up to work together in this fashion, they are referred to as a RAID array.

For additional information about RAID, refer to the HP Web site at <http://www.hp.com/support>.

# 7 Security

## Protecting the computer

Standard security features provided by the Windows® operating system and the non-Windows Setup Utility can protect your personal settings and data from a variety of risks.

 **NOTE:** Security solutions are designed to act as deterrents, but they may not deter software attacks or prevent the computer from being mishandled or stolen.

**NOTE:** Before you send your computer for service, back up and delete confidential files, and remove all password settings.

**NOTE:** Some features listed in this chapter may not be available on your computer.

| Computer risk  | Security feature  |
|--|---|
| Unauthorized use of the computer   | <ul style="list-style-type: none"><li>• QuickLock (select models only)</li><li>• Power-on password</li><li>• Fingerprint reader</li></ul> |
| Computer viruses   | Antivirus software  |
| Unauthorized access to data  | <ul style="list-style-type: none"><li>• Firewall software</li><li>• Windows updates</li><li>• File encryption</li></ul>                   |
| Unauthorized access to Setup Utility, BIOS settings, and other system identification information | Administrator password  |
| Ongoing or future threats to the computer  | Critical security updates from Microsoft  |
| Unauthorized access to a Windows user account  | User password   |
| Unauthorized removal of the computer   | Security cable slot (used with an optional security cable)  |

## Using passwords

A password is a group of characters that you choose to secure your computer information. Several types of passwords can be set, depending on how you want to control access to your information. Passwords can be set in Windows or in the non-Windows Setup Utility that is preinstalled on the computer.

 **NOTE:** To reduce the risk of being locked out of the computer, record each password and store it in a secure place.

You can use the same password for a Setup Utility feature and for a Windows security feature. You can also use the same password for more than one Setup Utility feature.

For additional information about Windows passwords, such as screen-saver passwords, select **Start > Help and Support**.

## Setting passwords in Windows

| Password                       | Function  |
|--------------------------------|---|
| Administrator password         | Protects administrator-level access to computer contents.<br><b>NOTE:</b> This password cannot be used to access Setup Utility contents.  |
| User password                  | Protects access to a Windows user account. It also protects access to the computer contents and must be entered when you exit Sleep or Hibernation.   |
| QuickLock (select models only) | Protects your information by displaying the operating system Log On window. While the Log On window is displayed, the computer cannot be accessed until a Windows user password or a Windows administrator password is entered. After you set a user or administrator password, follow these steps: <ol style="list-style-type: none"><li>1. Initiate QuickLock.</li><li>2. Exit QuickLock by entering your Windows user or administrator password.</li></ol> |

## Setting passwords in Setup Utility

| Password                | Function  |
|-------------------------|---|
| Administrator password* | <ul style="list-style-type: none"><li>• Protects access to Setup Utility.</li><li>• After this password is set, it must be entered each time you access Setup Utility.</li></ul> <p><b>CAUTION:</b> If you forget your administrator password, you cannot access Setup Utility.</p> <p><b>NOTE:</b> The administrator password can be used in place of the power-on password.</p> <p><b>NOTE:</b> Your administrator password is not interchangeable with an administrator password set in Windows, nor is it displayed as it is set, entered, changed, or deleted.</p> <p><b>NOTE:</b> If you enter the power-on password at the first password check before the "Press the ESC key for Startup Menu" message is displayed, you must enter the administrator password to access Setup Utility.</p> |
| Power-on password*      | <ul style="list-style-type: none"><li>• Protects access to the computer contents.</li><li>• After this password is set, it must be entered each time you turn on or restart the computer, or exit Hibernation.</li></ul> <p><b>CAUTION:</b> If you forget your power-on password, you cannot turn on or restart the computer, or exit Hibernation.</p> <p><b>NOTE:</b> The administrator password can be used in place of the power-on password.</p> <p><b>NOTE:</b> A power-on password is not displayed as it is set, entered, changed, or deleted.</p>   |

\*For details about each of these passwords, refer to the following topics.

## Managing an administrator password

To set, change, or delete this password, follow these steps:

1. Open Setup Utility by turning on or restarting the computer. While the “Press the ESC key for Startup Menu” message is displayed in the lower-left corner of the screen, press **esc**. When the Startup Menu is displayed, press **f10**.
2. Use the arrow keys to select **Security > Set Administrator Password**, and then press **enter**.
  - To set an administrator password, type your password in the **Enter New Password** and **Confirm New Password** fields, and then press **enter**.
  - To change an administrator password, type your current password in the **Enter Current Password** field, type a new password in the **Enter New Password** and **Confirm New Password** fields, and then press **enter**.
  - To delete an administrator password, type your current password in the **Enter Password** field, and then press **enter** 4 times.
3. To save your changes and exit Setup Utility, use the arrow keys to select **Exit > Exit Saving Changes**.

Your changes take effect when the computer restarts.

## Entering an administrator password

At the **Enter Password** prompt, type your administrator password, and then press **enter**. After 3 unsuccessful attempts to enter the administrator password, you must restart the computer and try again.

## Managing a power-on password

To set, change, or delete this password, follow these steps:

1. Open Setup Utility by turning on or restarting the computer. While the “Press the ESC key for Startup Menu” message is displayed in the lower-left corner of the screen, press **esc**. When the Startup Menu is displayed, press **f10**.
2. Use the arrow keys to select **Security > Set Power-On Password**, and then press **enter**.
  - To set a power-on password, type your password in the **Enter New Password** and **Confirm New Password** fields, and then press **enter**.
  - To change a power-on password, type your current password in the **Enter Current Password** field, type a new password in the **Enter New Password** and **Confirm New Password** fields, and then press **enter**.
  - To delete a power-on password, type your current password in the **Enter Current Password** field, and then press **enter** 4 times.
3. To save your changes and exit Setup Utility, use the arrow keys to select **Exit > Exit Saving Changes**.

Your changes take effect when the computer restarts.

## Entering a power-on password

At the **Enter Password** prompt, type your password, and then press **enter**. After 3 unsuccessful attempts to enter the password, you must restart the computer and try again.

## Using antivirus software

When you use the computer to access e-mail, a network, or the Internet, you potentially expose it to computer viruses. Computer viruses can disable the operating system, programs, or utilities, or cause them to function abnormally.

Antivirus software can detect most viruses, destroy them, and, in most cases, repair any damage they have caused. To provide ongoing protection against newly discovered viruses, antivirus software must be kept up to date.

An antivirus program may be preinstalled on your computer and may include a trial offer. It is strongly recommended that you upgrade the trial offer or purchase the antivirus program of your choice in order to fully protect your computer.

For more information about computer viruses, type `viruses` in the Search box in Help and Support.

## Using firewall software

Firewalls are designed to prevent unauthorized access to a system or network. A firewall can be a software program you install on your computer and/or network, or it can be a solution made up of both hardware and software.

There are two types of firewalls to consider:

- Host-based firewalls—Software that protects only the computer it is installed on.
- Network-based firewalls—Installed between your DSL or cable modem and your home network to protect all the computers on the network.

When a firewall is installed on a system, all data sent to and from the system is monitored and compared with a set of user-defined security criteria. Any data that does not meet those criteria is blocked.

Your computer or networking equipment may already have a firewall installed. If not, firewall software solutions are available.

---

 **NOTE:** Under some circumstances a firewall can block access to Internet games, interfere with printer or file sharing on a network, or block authorized e-mail attachments. To temporarily resolve the problem, disable the firewall, perform the task that you want to perform, and then reenable the firewall. To permanently resolve the problem, reconfigure the firewall.

---

## Installing critical security updates

---

△ **CAUTION:** Microsoft sends out alerts regarding critical updates. To protect the computer from security breaches and computer viruses, install all critical updates from Microsoft as soon as you receive an alert.

---

Updates to the operating system and other software may have become available after the computer left the factory. To be sure that all available updates are installed on the computer, observe these guidelines:

- Run Windows Update as soon as possible after you set up your computer. Use the update link at **Start > All Programs > Windows Update**.
- Run Windows Update monthly thereafter.
- Obtain updates to Windows and other Microsoft® programs, as they are released, from the Microsoft Web site and through the updates link in Help and Support.

## Installing an optional security cable

 **NOTE:** A security cable is designed to act as a deterrent, but it may not prevent the computer from being mishandled or stolen.

**NOTE:** The security cable slot on your computer may look slightly different from the illustration in this section. Refer to the [Getting Started](#) guide for the location of the security cable slot on your computer.

1. Loop the security cable around a secured object.
2. Insert the key (1) into the cable lock (2).
3. Insert the cable lock into the security cable slot on the computer (3), and then lock the cable lock with the key.

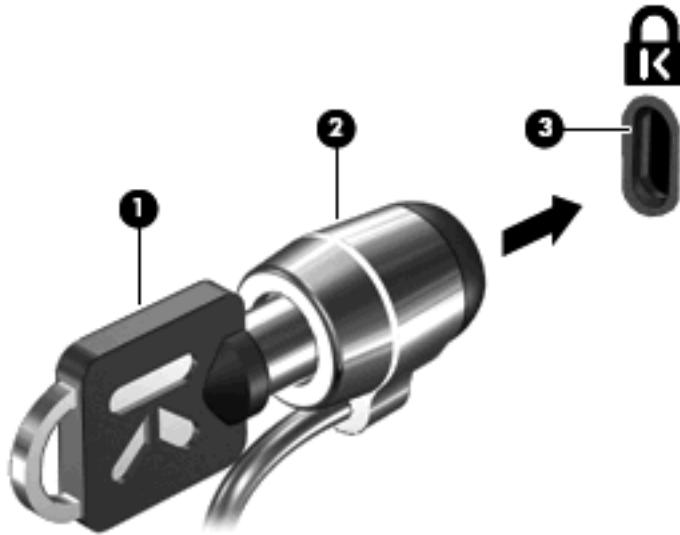

4. Remove the key and keep it in a safe place.

## Using the fingerprint reader (select models only)

Integrated fingerprint readers are available on select computer models. In order to use the fingerprint reader, you must set up a user account with a password on the computer. This account allows you to log on to your computer with a swipe of a designated finger. You may also use the fingerprint reader to fill in password fields on Web sites and other programs that require a logon. Refer to the fingerprint software Help for instructions.

After you create your fingerprint identity, you can set up a Single Sign On service that allows you to use your fingerprint scanner to create credentials for any application that requires a user name and password.

## Locating the fingerprint reader

The fingerprint reader is a small metallic sensor that is located in one of the following areas of your computer:

- Near the bottom of the TouchPad
- On the right side of the keyboard

- On the upper-right side of the display
- On the left side of the display

Depending on your computer model, the fingerprint reader may be oriented horizontally or vertically. Both orientations require that you swipe your finger perpendicular to the metallic sensor. Refer to the *Getting Started* guide for the location of the fingerprint reader on your computer.



---

## 8 Setup Utility (BIOS)

Setup Utility, or Basic Input/Output System (BIOS), controls communication between all the input and output devices on the system (such as disk drives, display, keyboard, mouse, and printer). Setup Utility includes settings for the types of peripherals installed, the startup sequence of the computer, and the amount of system and extended memory.

△ **CAUTION:** Use extreme care when making changes in Setup Utility. Errors can prevent the computer from operating properly.

---

### Starting Setup Utility

 **NOTE:** The fingerprint reader (select models only) cannot be used to access Setup Utility.

---

- ▲ Turn on or restart the computer. While the “Press the ESC key for Startup Menu” message is displayed in the lower-left corner of the screen, press **esc**. When the Startup Menu is displayed, press **f10**.

### Using Setup Utility

#### Changing the language of Setup Utility

1. Start Setup Utility.
2. Use the arrow keys to select **System Configuration > Language**, and then press **enter**.
3. Use the arrow keys to select a language, and then press **enter**.
4. When a confirmation prompt with your language selected is displayed, press **enter**.
5. To save your change and exit Setup Utility, use the arrow keys to select **Exit > Exit Saving Changes**, and then press **enter**.

Your change takes effect immediately.

#### Navigating and selecting in Setup Utility

Because Setup Utility is not Windows based, it does not support the TouchPad. Navigation and selection are by keystroke.

- To choose a menu or a menu item, use the arrow keys.
- To choose an item in a list or to toggle a field—for example an Enable/Disable field—use either the arrow keys or **f5** and **f6**.
- To select an item, press **enter**.
- To close a text box or return to the menu display, press **esc**.
- To display additional navigation and selection information while Setup Utility is open, press **f1**.

## Displaying system information

1. Start Setup Utility.
2. Select the **Main** menu. System information such as the system time and date, and identification information about the computer is displayed.
3. To exit Setup Utility without changing any settings, use the arrow keys to select **Exit > Exit Discarding Changes**, and then press **enter**.

## Restoring factory default settings in Setup Utility

1. Start Setup Utility.
2. Use the arrow keys to select **Exit > Load Setup Defaults**, and then press **enter**.
3. When the Setup Confirmation is displayed, press **enter**.
4. To save your change and exit Setup Utility, use the arrow keys to select **Exit > Exit Saving Changes**, and then press **enter**.

The Setup Utility factory settings take effect when the computer restarts.

---

 **NOTE:** Your password, security, and language settings are not changed when you restore the factory settings.

---

## Exiting Setup Utility

- To exit Setup Utility and save your changes from the current session:  
If the Setup Utility menus are not visible, press **esc** to return to the menu display. Then use the arrow keys to select **Exit > Exit Saving Changes**, and then press **enter**.
- To exit Setup Utility without saving your changes from the current session:  
If the Setup Utility menus are not visible, press **esc** to return to the menu display. Then use the arrow keys to select **Exit > Exit Discarding Changes**, and then press **enter**.

# Updating the BIOS

Updated versions of the BIOS may be available on the HP Web site.

Most BIOS updates on the HP Web site are packaged in compressed files called *SoftPaqs*.

Some download packages contain a file named *Readme.txt*, which contains information regarding installing and troubleshooting the file.

## Determining the BIOS version

To determine whether available BIOS updates contain later BIOS versions than those currently installed on the computer, you need to know the version of the system BIOS currently installed.

BIOS version information (also known as *ROM date* and *System BIOS*) can be displayed by pressing **fn+esc** (if you are already in Windows) or by using Setup Utility.

1. Start Setup Utility.
2. If the system information is not displayed, use the arrow keys to select the **Main** menu.  
BIOS and other system information is displayed.
3. To exit Setup Utility, use the arrow keys to select **Exit > Exit Discarding Changes**, and then press **enter**.

## Downloading a BIOS update

△ **CAUTION:** To reduce the risk of damage to the computer or an unsuccessful installation, download and install a BIOS update only when the computer is connected to reliable external power using the AC adapter. Do not download or install a BIOS update while the computer is running on battery power, docked in an optional docking device, or connected to an optional power source. During the download and installation, follow these instructions:

Do not disconnect power from the computer by unplugging the power cord from the AC outlet.

Do not shut down the computer or initiate Sleep or Hibernation.

Do not insert, remove, connect, or disconnect any device, cable, or cord.

1. Access the page on the HP Web site that provides software for your computer:  
**Windows 7**—Select **Start > Help and Support > Maintain**.  
**Windows XP**—Select **Start > Help and Support**, and then select the software and drivers update.
2. Follow the on-screen instructions to identify your computer and access the BIOS update you want to download.
3. At the download area, follow these steps:
  - a. Identify the BIOS update that is later than the BIOS version currently installed on your computer. Make a note of the date, name, or other identifier. You may need this information to locate the update later, after it has been downloaded to your hard drive.
  - b. Follow the on-screen instructions to download your selection to the hard drive.  
Make a note of the path to the location on your hard drive where the BIOS update is downloaded. You will need to access this path when you are ready to install the update.

📝 **NOTE:** If you connect your computer to a network, consult the network administrator before installing any software updates, especially system BIOS updates.

BIOS installation procedures vary. Follow any instructions that are displayed on the screen after the download is complete. If no instructions are displayed, follow these steps:

1. **Windows 7**—Open Windows Explorer by selecting **Start > Computer**.  
**Windows XP**—Open Windows Explorer by selecting **Start > My Computer**.
2. Double-click your hard drive designation. The hard drive designation is typically Local Disk (C:).
3. Using the hard drive path you recorded earlier, open the folder on your hard drive that contains the update.
4. Double-click the file that has an .exe extension (for example, *filename.exe*).  
The BIOS installation begins.
5. Complete the installation by following the on-screen instructions.

---

 **NOTE:** After a message on the screen reports a successful installation, you can delete the downloaded file from your hard drive.

---

---

# A Traveling with the computer

For best results, follow these traveling and shipping tips:

- Prepare the computer for traveling or shipping:
  - Back up your information.
  - Remove all discs and all external media cards, such as digital cards.
  - △ **CAUTION:** To reduce the risk of damage to the computer, damage to a drive, or loss of information, remove the media from a drive before removing the drive from a drive bay and before shipping, storing, or traveling with a drive.
  - Turn off and then disconnect all external devices.
  - Shut down the computer.
- Take along a backup of your information. Keep the backup separate from the computer.
- When traveling by air, carry the computer as hand luggage; do not check it in with the rest of your bags.
- △ **CAUTION:** Avoid exposing a drive to magnetic fields. Security devices with magnetic fields include airport walk-through devices and security wands. Airport conveyer belts and similar security devices that check carry-on baggage use X-rays instead of magnetism and do not damage drives.
- In-flight computer use is at the discretion of the airline. If you plan to use the computer during a flight, check with the airline in advance.
- If the computer will be unused and disconnected from external power for more than 2 weeks, remove the battery and store it separately.
- If you are shipping the computer or a drive, use suitable protective packaging and label the package “FRAGILE.”
- If the computer has a wireless device or an HP Mobile Broadband Module installed, such as an 802.11b/g device, a Global System for Mobile Communications (GSM) device, or a General Packet Radio Service (GPRS) device, the use of these devices may be restricted in some environments. Such restrictions may apply onboard aircraft, in hospitals, near explosives, and in hazardous locations. If you are uncertain of the policy that applies to the use of a particular device, ask for authorization to use it before you turn it on.
- If you are traveling internationally, follow these suggestions:
  - Check the computer-related customs regulations for each country or region on your itinerary.
  - Check the power cord and adapter requirements for each location in which you plan to use the computer. Voltage, frequency, and plug configurations vary.
- △ **WARNING!** To reduce the risk of electric shock, fire, or damage to the equipment, do not attempt to power the computer with a voltage converter kit sold for appliances.

---

## B Troubleshooting resources

- Access Web site links and additional information about the computer through Help and Support. Select **Start > Help and Support**.

 **NOTE:** Some checkup and repair tools require an Internet connection. HP also provides additional tools that do not require an Internet connection.

- Contact HP Customer Support at <http://www.hp.com/go/contactHP>.

 **NOTE:** For worldwide support, click **Contact HP worldwide** on the left side of the page, or go to [http://welcome.hp.com/country/us/en/wwcontact\\_us.html](http://welcome.hp.com/country/us/en/wwcontact_us.html).

Choose from the following types of support:

- Chat online with an HP technician.

 **NOTE:** When chat is not available in a particular language, it is available in English.

- E-mail HP Customer Support.
- Find HP Customer Support worldwide telephone numbers.
- Locate an HP service center.

---

## C Electrostatic Discharge

Electrostatic discharge is the release of static electricity when two objects come into contact—for example, the shock you receive when you walk across the carpet and touch a metal door knob.

A discharge of static electricity from fingers or other electrostatic conductors may damage electronic components. To prevent damage to the computer, damage to a drive, or loss of information, observe these precautions:

- If removal or installation instructions direct you to unplug the computer, unplug it after being properly grounded and before removing a cover.
- Keep components in their electrostatic-safe containers until you are ready to install them.
- Avoid touching pins, leads, and circuitry. Handle electronic components as little as possible.
- Use nonmagnetic tools.
- Before handling components, discharge static electricity by touching an unpainted metal surface of the component.
- If you remove a component, place it in an electrostatic-safe container.

If you need more information about static electricity or assistance with component removal or installation, contact Customer Support.

---

# Index

## Symbols/Numerics

- 1394 cable, connecting 37
- 1394 devices
  - connecting 37
  - defined 36
  - removing 37
- 16-bit PC Cards 30
- 32-bit PC Cards 30

## A

- AC adapter, testing 28
- action keys
  - media 14
  - volume 14
- administrator password
  - creating 51
  - entering 51
  - managing 51
- airport security devices 41
- antivirus software, using 52
- audio functions, checking 15

## B

- battery
  - conserving power 26
  - discharging 24
  - displaying remaining charge 24
  - disposing 26
  - low battery levels 25
  - replacing 26
  - storing 26
- Battery Check 24
- battery information, finding 24
- battery power 23
- battery temperature 26
- BIOS
  - determining version 57
  - downloading an update 57
  - updating 57
- Bluetooth device 2, 8
- buttons
  - media 14
  - power 20

- volume 14
- wireless 3

## C

- cables
  - 1394 37
  - eSATA 38
  - USB 36
- CardBus PC Cards 30
- checking audio functions 15
- computer, traveling 26, 59
- configuring audio for HDMI 18
- configuring ExpressCards 32
- configuring PC Cards 30
- connecting to a wired network 9
- connecting to an existing wireless network 5
- Connection Manager 4
- connector, docking 40
- conservation, power 26
- creating a wireless connection 2
- critical battery level 21, 25
- critical security updates, installing 52

## D

- default settings, restoring 56
- digital card
  - inserting 29
  - removing 29
  - supported formats 29
- Disk Cleanup software 42
- Disk Defragmenter software 41
- DisplayPort, connecting 17
- docking connector 40
- drive light 43
- drive media 21
- drivers 30
- drives
  - external 39
  - handling 41
  - hard 39
  - optical 39
  - using 41

## E

- electrostatic discharge 61
- entering a power-on password 51
- entering an administrator password 51
- eSATA cable, connecting 38
- eSATA devices
  - connecting 37
  - defined 37
  - removing 38
- existing wireless network, connecting to 5
- expansion port 39
- ExpressCard
  - configuring 32
  - defined 32
  - inserting 33
  - removing 34
  - removing insert 33
- external AC power, using 27
- external devices 39
- external drive 39
- external monitor port 16

## F

- factory settings, restoring 56
- finding more information 1
- fingerprint reader
  - locating 53
  - using 53
- firewall software 6, 52

## G

- GPS 9
- graphics modes, switching 28

## H

- hard drive
  - external 39
  - HP ProtectSmart Hard Drive Protection 42
- HDMI
  - configuring audio 18



- HDMI port, connecting 17
- Hibernation
  - exiting 21
  - initiated during critical battery level 25
  - initiating 21
- high-definition devices, connecting 17
- HP Connection Manager 4
- HP MediaSmart 19
- HP Mobile Broadband Module 7
- HP ProtectSmart Hard Drive Protection 42
- HP SkyRoom 16
- HP USB Ethernet Adapter, connecting 12
- HP Wireless Assistant 4
- hubs 35

**I**

- icons
  - network 2
  - wireless 2
- installing
  - critical security updates 52
  - optional security cable 53
- Internet connection setup 6

**J**

- Java Card
  - defined 34
  - inserting 35
  - removing 35

**K**

- keys
  - media 14
  - volume 14

**L**

- lights, drive 43
- local area network (LAN)
  - cable required 12
  - connecting cable 12
- low battery level 25

**M**

- maintenance
  - Disk Cleanup 42
  - Disk Defragmenter 41

- managing a power-on password 51
- managing an administrator password 51
- media action keys 14
- media activity controls 14
- media hotkeys 14
- MediaSmart 19
- modems
  - connecting a modem cable 9
  - connecting a modem cable adapter 10
  - selecting a location setting 10

**N**

- network cable, connecting 12
- network icon 2

**O**

- operating system controls 5
- optical disc
  - inserting 45
  - removing 46
- optical drive 39
- optional external devices, using 39

**P**

- passwords
  - set in Setup Utility 50
  - set in Windows 50
- PC Cards
  - configuring 30
  - description 30
  - inserting 30
  - removing 32
  - removing insert 31
  - software and drivers 30
  - supported types 30

- ports
  - DisplayPort 17
  - expansion 39
  - external monitor 16
  - HDMI 17
  - VGA 16

- power
  - battery 23
  - conserving 26
  - options 20
- power button 20
- power meter 22

- power plans
  - customizing 22
  - selecting 22
  - viewing current 22
- power switch 20
- power-on password
  - creating 51
  - entering 51
  - managing 51
- power-saving states 20
- protecting the computer 49
- protecting your wireless network 6

**Q**

- QuickLock 49, 50

**R**

- RAID 48
- readable media 21
- roaming to another network 7

**S**

- security cable, installing 53
- security, wireless 6
- setting password protection on wakeup 23
- setting power options 20
- setup of WLAN 6
- Setup Utility
  - changing the language 55
  - displaying system information 56
  - exiting 56
  - navigating 55
  - passwords set in 50
  - restoring default settings 56
  - selecting 55
  - starting 55
- sharing optical drives 48
- shutdown 20
- SIM
  - inserting 7
  - removing 8
- SkyRoom 16
- Sleep
  - exiting 21
  - initiating 21
- slot-load optical drive 45
- smart card
  - defined 34

- inserting 35
- removing 35
- software
  - Disk Cleanup 42
  - Disk Defragmenter 41
  - HP Connection Manager 4
  - HP MediaSmart 19
  - HP ProtectSmart Hard Drive Protection 43
  - HP SkyRoom 16
  - HP Wireless Assistant 4
- Standby 20
- storing a battery 26
- switch, power 20
- switchable graphics 28
- system information, displaying 56

## T

- temperature 26
- testing an AC adapter 28
- traveling with the computer 26, 59
- tray-load optical drive 45
- troubleshooting resources 60
- turning off the computer 20
- turning wireless devices on or off 3

## U

- unresponsive system 20
- USB cable, connecting 36
- USB devices
  - connecting 35
  - description 35
  - removing 36
- USB hubs 35
- using a modem 9
- using external AC power 27
- using passwords 49
- using power plans 22
- using power-saving states 20
- using the power meter 22

## V

- VGA port, connecting 16
- video 16
- volume
  - adjusting 14
  - buttons 14
  - keys 14

## W

- webcam 16
- Windows, passwords set in 50
- wireless
  - action key 3
  - button 3
  - icons 2
  - protecting 6
  - set up 6
  - switch 3
- Wireless Assistant software 4
- wireless connection, creating 2
- wireless devices, turning on or off 3
- wireless encryption 6
- wireless network (WLAN)
  - connecting to existing 5
  - equipment needed 6
  - security 6
- writable media 21
- WWAN device 7

## Z

- zoomed video PC Cards 30

# Regulatory, Safety and Environmental Notices

User Guide

© Copyright 2008–2011 Hewlett-Packard  
Development Company, L.P.

Bluetooth is a trademark owned by its proprietor and used by Hewlett-Packard Company under license. ENERGY STAR is a registered mark owned by the U.S. government. Java is a trademark of Sun Microsystems. Microsoft, Windows, and Windows Vista are U.S. registered trademarks of Microsoft Corporation.

The information contained herein is subject to change without notice. The only warranties for HP products and services are set forth in the express warranty statements accompanying such products and services. Nothing herein should be construed as constituting an additional warranty. HP shall not be liable for technical or editorial errors or omissions contained herein.

First Edition: February 2011

Document Part Number: 653267-001

---

# Table of contents

|  |          |
|--|----------|
| <b>1 Regulatory notices</b> .....  | <b>1</b> |
| Federal Communications Commission notice .....   | 2        |
| Modifications .....  | 2        |
| Cables .....   | 2        |
| Declaration of Conformity for products marked with the FCC logo (United States only) ..... | 3        |
| Products with wireless LAN devices or HP Mobile Broadband Modules .....                    | 3        |
| Brazil notice .....  | 4        |
| Canada notices .....   | 4        |
| Avis Canadien .....  | 4        |
| European Union Regulatory notices .....  | 4        |
| Products with HP Mobile Broadband Modules .....  | 5        |
| Ergonomics notice .....  | 6        |
| Germany .....  | 6        |
| Japan notices .....  | 7        |
| Wireless LAN 802.11b devices .....   | 7        |
| Wireless LAN 802.11g devices .....   | 7        |
| Bluetooth devices .....  | 7        |
| Wireless LAN, Wireless WAN, and Bluetooth certification markings .....                     | 8        |
| South Korea notice .....   | 8        |
| Mexico notice .....  | 8        |
| Singapore wireless notice .....  | 8        |
| Thailand WWAN wireless notice .....  | 8        |
| Taiwan notices .....   | 9        |
| Wireless LAN 802.11a devices .....   | 9        |
| Wireless LAN 802.11b devices .....   | 9        |
| Vietnam Compliance Marking Notice .....  | 9        |
| Airline travel notice .....  | 10       |
| Battery notices .....  | 10       |
| ENERGY STAR compliance .....   | 10       |
| Laser compliance .....   | 11       |
| Modem notices .....  | 11       |
| Telecommunications device approvals .....  | 11       |
| U.S. modem statements .....  | 12       |
| U.S. modem declarations .....  | 12       |
| Canada modem statements .....  | 15       |
| Japan modem statements .....   | 15       |

|  |           |
|--|-----------|
| New Zealand modem statements .....   | 15        |
| Voice support .....  | 16        |
| Power cord notice .....  | 16        |
| Japan power cord notice .....  | 16        |
| DC plug of external HP power supply .....  | 16        |
| Macrovision Corporation notice .....   | 16        |
| <b>2 Safety notices .....</b>  | <b>17</b> |
| Heat-related safety warning notice .....   | 17        |
| Potential safety conditions notice .....   | 17        |
| Battery notices .....  | 17        |
| Headset and earphone volume level notice .....   | 17        |
| Power cord notices .....   | 18        |
| Cleaning the keyboard .....  | 18        |
| Travel notice .....  | 18        |
| Norway and Sweden: Cable grounding notice for products with a TV tuner .....           | 18        |
| <b>3 Environmental notices .....</b>   | <b>19</b> |
| Electronic hardware and battery recycling .....  | 19        |
| Disposal of waste equipment by users in private households in the European Union ..... | 19        |
| Chemical substances .....  | 19        |
| China material content declarations .....  | 20        |
| Japan material content declaration .....   | 22        |
| Turkey EEE regulation .....  | 22        |
| Ukraine Restriction of Hazardous Substances .....                                      | 23        |
| United States mercury disposal .....   | 23        |
| Perchlorate material—special handling may apply .....                                  | 23        |
| <b>Index .....</b>   | <b>24</b> |

---

# 1 Regulatory notices

This guide provides country- and region-specific non-wireless and wireless regulatory notices and compliance information for the computer product. Some of these notices may not apply to your product.

One or more integrated wireless devices may be installed. In some environments, the use of wireless devices may be restricted. Such restrictions may apply on-board airplanes, in hospitals, near explosives, in hazardous locations, and so on. If you are uncertain of the policy that applies to the use of this product, ask for authorization to use it before you turn it on.

To identify a hardware device such as a wireless LAN (WLAN) network device, choose the procedure below that corresponds to the operating system running on your computer.

**For Windows® XP Professional and Windows XP Home**, follow these steps:

1. Select **Start > My Computer**.
2. If the left pane, select **View System Information > Hardware tab > Device Manager**.

**For Windows Vista®**, follow these steps:

1. Select **Start > Computer > System properties**.
2. In the left pane, click **Device Manager**.

**For later Windows operating systems, such as Windows 7**, follow these steps:

- ▲ Select **Start > Control Panel > System and Security > Device Manager**.

**For non-Windows operating systems**, follow the instructions provided by your operating system to identify a hardware device such as a wireless LAN (WLAN) network device.

Regulatory markings for your country or region may be located on the bottom of the product, either under the battery, under a user-removable door (or some other user-accessible location), or on the wireless or modem module.

To view the FCC IDs for any radio modules in your notebook (Bluetooth®, WLAN, or WWAN), follow these steps:

1. Turn on or restart the computer, and then press **esc** while the "Press the ESC key for Startup Menu" message is displayed at the bottom of the screen.
2. Press **f10** to enter BIOS Setup.
3. Select the **System Configuration** menu.

The FCC IDs are displayed at the bottom of the screen.

---

 **CAUTION:** Devices not for sale or use in the United States may not have an FCC ID.

---

## Federal Communications Commission notice

This equipment has been tested and found to comply with the limits for a Class B digital device, pursuant to Part 15 of the FCC Rules. These limits are designed to provide reasonable protection against harmful interference in a residential installation. This equipment generates, uses, and can radiate radio frequency energy and, if not installed and used in accordance with the instructions, may cause harmful interference to radio communications. However, there is no guarantee that interference will not occur in a particular installation.

If this equipment does cause harmful interference to radio or television reception, which can be determined by turning the equipment off and on, the user is encouraged to try to correct the interference by one or more of the following measures:

- Reorient or relocate the receiving antenna.
- Increase the separation between the equipment and receiver.
- Connect the equipment to an outlet on a circuit different from that to which the receiver is connected.
- Consult the dealer or an experienced radio or television technician for help.

### Modifications

The FCC requires the user to be notified that any changes or modifications made to this device that are not expressly approved by HP may void the user's authority to operate the equipment.

### Cables

To maintain compliance with FCC Rules and Regulations, connections to this device must be made with shielded cables having metallic RFI/EMI connector hoods.



## Declaration of Conformity for products marked with the FCC logo (United States only)

This device complies with Part 15 of the FCC Rules. Operation is subject to the following 2 conditions:

1. This device may not cause harmful interference.
2. This device must accept any interference received, including interference that may cause undesired operation.

If you have questions about the product that are *not* related to this declaration, write to

Hewlett-Packard Company

P. O. Box 692000, Mail Stop 530113

Houston, TX 77269-2000

For questions regarding this FCC declaration, write to

Hewlett-Packard Company

P. O. Box 692000, Mail Stop 510101

Houston, TX 77269-2000

or call HP at 281-514-3333

To identify your product, refer to the part, series, or model number located on the product.

## Products with wireless LAN devices or HP Mobile Broadband Modules

This device must not be co-located or operating in conjunction with any other antenna or transmitter.

 **WARNING! Exposure to Radio Frequency Radiation** The radiated output power of this device is below the FCC radio frequency exposure limits. Nevertheless, the device should be used in such a manner that the potential for human contact is minimized during normal operation of tablet PCs and notebook computers.

During normal operation of tablet PCs and notebook computers with displays equal to or less than 12 inches: To avoid the possibility of exceeding the FCC radio frequency exposure limits, human proximity to the antennas should not be less than 2.5 cm (1 inch). To identify the location of the wireless antennas, refer to the computer user guides. To access the user guides, select **Start > Help and Support > User Guides**.

During normal operation of notebook computers with displays greater than 12 inches: To avoid the possibility of exceeding the FCC radio frequency exposure limits, human proximity to the antennas should not be less than 20 cm (8 inches), including when the computer display is closed. To identify the location of the wireless antennas, refer to the computer user guides. To access the user guides, select **Start > Help and Support > User Guides**.

 **CAUTION:** When using IEEE 802.11a wireless LAN, this product is restricted to indoor use, due to its operation in the 5.15- to 5.25-GHz frequency range. The FCC requires this product to be used indoors for the frequency range of 5.15 GHz to 5.25 GHz to reduce the potential for harmful interference to co-channel mobile satellite systems. High-power radar is allocated as the primary user of the 5.25- to 5.35-GHz and 5.65- to 5.85-GHz bands. These radar stations can cause interference with and/or damage to this device.

## Brazil notice

Este equipamento opera em caráter secundário, isto é, não tem direito a proteção contra interferência prejudicial, mesmo de estações do mesmo tipo, e não pode causar interferência a sistemas operando em caráter primário.

Este equipamento atende aos limites de Taxa de Absorção Específica referente à exposição a campos elétricos, magnéticos e eletromagnéticos de radiofrequências adotados pela ANATEL.

## Canada notices

This Class B digital apparatus meets all requirements of the Canadian Interference-Causing Equipment Regulations. If this device has WLAN or Bluetooth capability, the device complies with Industry Canada licence-exempt RSS standard(s). Operation is subject to the following two conditions: (1) this device may not cause interference, and (2) this device must accept any interference, including interference that may cause undesired operation of the device.

---

**⚠ CAUTION:** When using IEEE 802.11a wireless LAN, this product is restricted to indoor use, due to its operation in the 5.15- to 5.25-GHz frequency range. Industry Canada requires this product to be used indoors for the frequency range of 5.15 GHz to 5.25 GHz to reduce the potential for harmful interference to co-channel mobile satellite systems. High-power radar is allocated as the primary user of the 5.25- to 5.35-GHz and 5.65- to 5.85-GHz bands. These radar stations can cause interference with and/or damage to this device.

---

The antennas for this device are not replaceable. Any attempt at user access will damage your computer.

## Avis Canadien

Cet appareil numérique de la classe B respecte toutes les exigences du Règlement sur le matériel brouilleur du Canada.

## European Union Regulatory notices

Products bearing the CE marking comply with the following EU Directives:

- Low Voltage Directive 2006/95/EC
- EMC Directive 2004/108/EC
- Ecodesign Directive 2009/125/EC where applicable

CE compliance of this product is valid if powered with the correct CE-marked AC adapter provided by HP.

If this product has wired and/or wireless telecommunications functionality, it also complies with the essential requirements of EU Directive R&TTE Directive 1999/5/EC.

Compliance with these directives implies conformity to applicable harmonized European standards (European Norms) that are listed in the EU Declaration of Conformity issued by HP for this product or product family and available (in English only) either within the product documentation or at the following Web site: [www.hp.eu/certificates](http://www.hp.eu/certificates) (type the product number in the search box).

The compliance is indicated by one of the following conformity markings placed on the product:



For non-telecommunications products and for EU harmonized telecommunications products, such as Bluetooth®, within power class below 10 mW.



For EU non-harmonized telecommunications products (if applicable, a 4-digit notified body number is inserted between CE and ! (the exclamation mark).

Please refer to the regulatory label provided on the product.

The telecommunications functionality of this product may be used in the following EU and EFTA countries: Austria, Belgium, Bulgaria, Cyprus, Czech Republic, Denmark, Estonia, Finland, France, Germany, Greece, Hungary, Iceland, Ireland, Italy, Latvia, Liechtenstein, Lithuania, Luxembourg, Malta, Netherlands, Norway, Poland, Portugal, Romania, Slovak Republic, Slovenia, Spain, Sweden, Switzerland, and United Kingdom.

The telephone connector (not available for all products) is intended for connection to analog telephone networks.

---

 **NOTE:** For products with wireless LAN devices, some countries may have specific obligations or special requirements about the operation of wireless LAN networks such as indoor use only or restrictions of the channels available. Be sure that the country settings of the wireless network are correct.

---

In France, certain restrictions apply for the 2.4-GHz wireless LAN operation of this product. This product may be used indoors for the entire 2400-MHz to 2483.5-MHz frequency band (channels 1 to 13). For outdoor use, only the 2400-MHz to 2454-MHz frequency band (channels 1 to 7) may be used. For the latest requirements, see <http://www.arcep.fr>.

The point of contact for regulatory matters is Hewlett-Packard GmbH, Dept./MS: HQ-TRE, Herrenberger Strasse 140, 71034 Boeblingen, GERMANY.

## Products with HP Mobile Broadband Modules

THIS DEVICE MEETS INTERNATIONAL GUIDELINES FOR EXPOSURE TO RADIO FREQUENCY RADIATION.

The HP Mobile Broadband Module in your notebook is a radio transmitter and receiver. The device is designed not to exceed the limits for exposure to radio frequency (RF) recommended by international guidelines (ICNIRP). These limits are part of comprehensive guidelines that establish permitted levels of RF radiation for the general population. The guidelines were developed by independent scientific organizations through periodic and thorough evaluation of scientific studies. The device also meets the European R&TTE directives, including the protection of the health and the safety of the user and any other person.

The exposure standard for mobile devices employs a unit of measurement known as the Specific Absorption Rate (SAR).\* The SAR was obtained by testing the device at standard operating positions

with the device transmitting at its highest certified power level in all tested frequency bands. The actual SAR of the device while operating can be well below the maximum value, because the device operates at multiple power levels and uses only the power required to reach the network.

When installed in the notebook computer, this device meets RF exposure guidelines when the antennas are positioned at a minimum distance from the body. In order to transmit data or messages, this device requires a quality connection to the network. In some cases, transmission of data or messages may be delayed until such a connection becomes available. Be sure that the recommended distance is observed until the transmission is complete.

\*The non-FCC, international guidelines state that the SAR limit for mobile devices used by the public is 2.0 watts/kilogram (W/kg) averaged over 10 grams of body tissue. The guidelines incorporate a substantial margin of safety to give additional protection for the public and to account for any variations in measurements. SAR values may vary depending on national reporting requirements and the network band.

This equipment incorporates a radio transmitting device. In normal use, a separation distance of 20 cm ensures that radio frequency exposure levels comply with the Australian and New Zealand Standards.

## Ergonomics notice

### Germany

Mobile computers bearing the "GS" approval mark meet the ergonomic requirements and are suitable only for short-time use of VDU tasks. When a mobile computer is used for display work tasks where the Visual Display Unit (VDU) Directive 90/270/EEC is applicable, an adequate external keyboard is required. Depending on the application and task, an adequate external monitor may also be necessary to attain working conditions comparable to a workstation setup.

Ref: EK1-ITB 2000:2008

This device is intended for use at visual display workplaces in compliance with BildscharbV, only with external keyboard and adequate external monitor.

During mobile use with disadvantageous illumination conditions (e.g. direct sun light) reflections may occur which result in reduced readability.

Mobile Computer, welche das "GS" Zeichen tragen, entsprechen den ergonomischen Anforderungen und sind nur für kurzzeitige Benutzung von Bildschirmarbeitsaufgaben geeignet. Wird ein mobiler Computer für Bildschirmarbeitsaufgaben verwendet, wo die Richtlinie 90/270/EEG (Bildschirmarbeitsrichtlinie) anzuwenden ist, wird eine geeignete externe Tastatur notwendig. Abhängig von der Anwendung und der Aufgabe kann ein geeigneter externer Monitor erforderlich sein, um vergleichbare Arbeitsbedingungen zu einem stationären Arbeitsplatz zu erreichen.

Ref: EK1-ITB 2000:2008

Das Gerät ist für die Benutzung am Bildschirmarbeitsplatz gemäß BildscharbV nur mit externer Tastatur und geeignetem Monitor vorgesehen.

Bei mobiler Nutzung mit ungünstigen Lichtverhältnissen (z.B. direkte Sonneneinstrahlung) kann es zu Reflexionen und damit zu Einschränkungen der Lesbarkeit der dargestellten Zeichen kommen.

## Japan notices

この装置は、クラスB情報技術装置です。この装置は、家庭環境で使用することを目的としていますが、この装置がラジオやテレビジョン受信機に近接して使用されると、受信障害を引き起こすことがあります。

取扱説明書に従って正しい取り扱いをして下さい。 VCCI-B

この機器の使用周波数帯では、電子レンジ等の産業・科学・医療用機器のほか工場の製造ライン等で使用されている移動体識別用の構内無線局（免許を要する無線局）及び特定小電力無線局（免許を要しない無線局）が運用されています。

- 1 この機器を使用する前に、近くで移動体識別用の構内無線局及び特定小電力無線局が運用されていないことを確認して下さい。
- 2 万一、この機器から移動体識別用の構内無線局に対して電波干渉の事例が発生した場合には、速やかに使用周波数を変更するか又は電波の発射を停止した上、下記連絡先にご連絡頂き、混信回避のための処置等（例えば、パーティションの設置など）についてご相談して下さい。
- 3 その他、この機器から移動体識別用の特定小電力無線局に対して電波干渉の事例が発生した場合など何かお困りのことが起きたときは、次の連絡先へお問い合わせ下さい。

連絡先：日本ヒューレット・パッカード株式会社 TEL：0120-014121

5 GHz帯を使用する特定無線設備（802.11a相当）は屋内使用に限られています。この機器を屋外で使用する場合は電波法で禁じられています。

## Wireless LAN 802.11b devices

2.4DS4

## Wireless LAN 802.11g devices

2.4OF4

## Bluetooth devices

2.4FH1

## Wireless LAN, Wireless WAN, and Bluetooth certification markings

This product contains certified radio equipment.



### South Korea notice

B급 기기  
(가정용 방송통신기기)

이 기기는 가정용(B급)으로 전자파적합등록을 한 기기로서 주로 가정에서 사용하는 것을 목적으로 하며, 모든 지역에서 사용할 수 있습니다.

### Mexico notice

La operación de este equipo está sujeta a las siguientes dos condiciones: (1) este equipo puede que no cause interferencia y (2) este equipo debe aceptar cualquier interferencia, incluyendo interferencia que pueda ser causada por la operación no deseada.

### Singapore wireless notice

Turn off any WWAN devices while you are onboard aircraft. The use of these devices onboard aircraft is illegal, may be dangerous to the operation of the aircraft, and may disrupt the cellular network. Failure to observe this instruction may lead to suspension or denial of cellular services to the offender, or legal action, or both.

Users are reminded to restrict the use of radio equipment in fuel depots, chemical plants, and where blasting operations are in progress.

As with other mobile radio transmitting equipment, users are advised that for satisfactory operation of the equipment and for the safety of personnel, no part of the human body should be allowed to come too close to the antennas during operation of the equipment.

This device has been designed to comply with applicable requirements for exposure to radio waves, based on scientific guidelines that include margins intended to assure the safety of all people, regardless of health and age. These radio wave exposure guidelines employ a unit of measurement known as the specific absorption rate (SAR). Tests for SAR are conducted using standardized methods, with the phone transmitting at its highest certified power level in all used frequency bands. The SAR data information is based on CENELEC's standards EN50360 and EN50361, which use the limit of 2 watts per kilogram, averaged over 10 grams of tissue.

### Thailand WWAN wireless notice

This telecom equipment has complied with NTC regulations.

เครื่องโทรคมนาคมและอุปกรณ์นี้ มีความสอดคล้องตามข้อกำหนดของ กทช.

## Taiwan notices

### Wireless LAN 802.11a devices

在5.25G ~5.35G頻帶內操作之無線  
資訊傳輸設備僅適於室內使用

### Wireless LAN 802.11b devices

#### 低功率電波輻射性電機管理辦法

第十二條 經型式認證合格之低功率射頻電機，非經許可，公司、商號或使用者均不得擅自變更頻率、加大功率或變更原設計之特性及功能。

第十四條 低功率射頻電機之使用不得影響飛航安全及干擾合法通信；經發現有干擾現象時，應立即停用，並改善至無干擾時方得繼續使用。  
前項合法通信，指依電信規定作業之無線電信。低功率射頻電機須忍受合法通信或工業、科學及醫療用電波輻射性電機設備之干擾。

## Vietnam Compliance Marking Notice

This marking is for applicable products only.

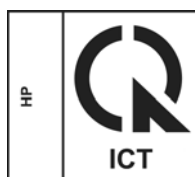
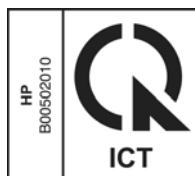



## Airline travel notice

Use of electronic equipment onboard commercial aircraft is at the discretion of the airline.

## Battery notices

**⚠ WARNING!** Risk of explosion if battery is replaced by an incorrect type. Dispose of used batteries according to the instructions.

For information about removing a battery, refer to the user guide included with the product.

## ENERGY STAR compliance

As an ENERGY STAR Partner, Hewlett-Packard Company has followed the EPA's enhanced product qualification and certification process to ensure that the products marked with the ENERGY STAR logo are ENERGY STAR qualified per the applicable ENERGY STAR guidelines for energy efficiency. The following logo appears on all ENERGY STAR-qualified computers:



The ENERGY STAR program for computers was created by the EPA to promote energy efficiency and reduce air pollution through more energy-efficient equipment in homes, offices, and factories. One way that products achieve this goal is by using the Microsoft® Windows® power management feature to reduce power consumption when the product is not in use.

The power management feature allows the computer to initiate a low-power or "Sleep" mode after a period of user inactivity. When used with an external ENERGY STAR qualified monitor, this feature also supports similar power management features of the monitor. To take advantage of these potential energy savings, the power management feature has been preset to behave in the following ways when the system is operating on AC power:

- Turn off the display after 15 minutes
- Initiate Sleep after 30 minutes

The computer exits Sleep when the power/Sleep button is pressed. When the Wake On LAN (WOL) feature is enabled, the computer can also exit Sleep in response to a network signal.

Additional information on the potential energy and financial savings of the power management feature can be found on the EPA ENERGY STAR Power Management Web site at <http://www.energystar.gov/powermanagement>.

Additional information on the ENERGY STAR program and its environmental benefits are available on the EPA ENERGY STAR Web site at <http://www.energystar.gov>.



## Laser compliance

**⚠ WARNING!** Use of controls or adjustments, or performance of procedures other than those specified in the laser product installation guide, may result in hazardous radiation exposure. To reduce the risk of exposure to hazardous radiation:

Do not try to open the module enclosure. There are no user-serviceable components inside.

Do not operate controls, make adjustments, or perform procedures to the laser device other than those specified in the laser product installation guide.

Allow only authorized service providers to repair the unit.

This product may be provided with an optical storage device (for example, a CD or DVD drive) and/or a fiber optic transceiver. Each of these devices that contain a laser is classified as a Class 1 Laser Product in accordance with IEC 60825-1 and meets the requirements for safety of that standard.

Each laser product complies with US FDA regulations of 21 CFR 1040.10 and 1040.11 or complies with those regulations except for deviations pursuant to Laser Notice No. 50 dated June 24, 2007.

## Modem notices

**⚠ WARNING!** To reduce the risk of fire, electric shock, and injury to persons when using this device, always follow basic safety precautions, including the following:

Do not use this product near water—for example, near a bathtub, wash bowl, kitchen sink or laundry tub, in a wet basement, or near a swimming pool.

Avoid using this product during an electrical storm. There is a remote risk of electric shock from lightning.

Do not use this product to report a gas leak while in the vicinity of the leak.

Always disconnect the modem cable before opening the equipment enclosure or touching an uninsulated modem cable, jack, or internal component.

If this product was not provided with a telephone line cord, use only No. 26 AWG or larger telecommunication line cord.

Do not plug a modem or telephone cable into the RJ-45 (network) jack.

SAVE THESE INSTRUCTIONS

## Telecommunications device approvals

The telecommunications device in the computer is approved for connection to the telephone network in the countries and regions whose approval markings are indicated on the product label located on the bottom of the computer or on the modem.

Refer to the user guide included with the product to ensure that the product is configured for the country or region in which the product is located. Selecting a country or region other than the one in which it is located may cause the modem to be configured in a way that violates the telecommunication regulations/laws of that country or region. In addition, the modem may not function properly if the correct country or region selection is not made. If, when you select a country or region, a message appears that states that the country or region is not supported, this means that the modem has not been approved for use in this country or region and thus should not be used.

## U.S. modem statements

This equipment complies with Part 68 of the FCC Rules and the requirements adopted by the ACTA. On the bottom of the computer or on the modem is a label that contains, among other information, a product identifier in the format US:AAAEQ##TXXXX. Provide this information to the telephone company if you are requested to do so.

**Applicable certification jack USOC = RJ11C.** A plug and jack used to connect this equipment to the premises wiring and telephone network must comply with the applicable FCC Part 68 rules and requirements adopted by the ACTA. A compliant telephone cord and modular plug is provided with this product. It is designed to be connected to a compatible modular jack that is also compliant. See installation instructions for details.

The REN is used to determine the number of devices that may be connected to a telephone line. Excessive RENs on a telephone line may result in the devices not ringing in response to an incoming call. In most but not all locations, the sum of RENs should not exceed five (5.0). To be certain of the number of devices that may be connected to a line, as determined by the total RENs, contact the local telephone company. For products approved after July 23, 2001, the REN for this product is part of the product identifier that has the format US:AAAEQ##TXXXX. The digits represented by ## are the REN without a decimal point (e.g., 03 is a REN of 0.3). For earlier products, the REN is separately shown on the label.

If this HP equipment causes harm to the telephone network, the telephone company will notify you in advance that temporary discontinuance of service may be required. But, if advance notice isn't practical, the telephone company will notify you as soon as possible. Also, you will be advised of your right to file a complaint with the FCC if you believe it is necessary.

The telephone company may make changes to its facilities, equipment, operations, or procedures that could affect the operation of the equipment. If this happens, the telephone company will provide advance notice in order for you to make necessary modifications to maintain uninterrupted telephone service.

If trouble is experienced with this equipment, call technical support. If the equipment is causing harm to the telephone network, the telephone company may request that you disconnect the equipment until the problem is resolved. You should perform repairs only to the equipment specifically discussed in the "Troubleshooting" section of the user guide, if one is provided.

Connection to party line service is subject to state tariffs. Contact the state public utility commission, public service commission, or corporation commission for information.

If your home has specially wired alarm equipment connected to the telephone line, ensure that the installation of this HP equipment does not disable your alarm equipment. If you have questions about what will disable alarm equipment, consult your telephone company or a qualified installer.

The Telephone Consumer Protection Act of 1991 makes it unlawful for any person to use a computer or other electronic device, including a fax machine, to send any message unless such message clearly contains in a margin at the top or bottom of each transmitted page, or on the first page of the transmission, the date and time it is sent and an identification of the business, other entity, or other individual sending the message, and the telephone number of the sending machine or such business, other entity, or individual. (The telephone number provided may not be a 900 number or any other number for which charges exceed local or long-distance transmission charges).

In order to program this information into your fax machine, you should complete the steps outlined in the faxing software instructions.

## U.S. modem declarations

Refer to the following modem vendor declarations for the modem device installed in your computer:

### Supplier's Declaration of Conformity

Reference Number: Delphi D40  
Place of Issue: Allentown, PA, USA  
Date of Issue: 21st July 2005

Agere Systems Inc. at 1110 American Parkway NE, Lehigh Valley Central Campus, Allentown, PA 18109 in the United States of America, hereby certifies that the Delphi Modem, bearing labelling identification number **US: AGSMD01BDELPHI** complies with the Federal Communications Commission's ("FCC") Rules and Regulations 47 CFR Part 68, and the Administrative Council on Terminal Attachments ("ACTA")-adopted technical criteria TIA/EIA/IS-968-A-3, Telecommunications – Telephone Terminal Equipment – Technical Requirements for Connection of Terminal Equipment To the Telephone Network.



Brad Grand  
Technical Manager

### Supplier's Declaration of Conformity

Reference Number: Delphi D40 (revision AM5)  
Place of Issue: Allentown, PA, USA  
Date of Issue: 30<sup>th</sup> November 2006

Agere Systems Inc. at 1110 American Parkway NE, Lehigh Valley Central Campus, Allentown, PA 18109 in the United States of America, hereby certifies that the Modem, bearing labelling identification number US: AGSMD01BDELPHI complies with the Federal Communications Commission's ("FCC") Rules and Regulations 47 CFR Part 68, and the Administrative Council on Terminal Attachments ("ACTA")-adopted technical criteria TIA/EIA/IS-968, 968-A, 968-A-1, 968-A-2 and 968-A-3 Telecommunications – Telephone Terminal Equipment – Technical Requirements for Connection of Terminal Equipment To the Telephone Network.



---

Brad Grand  
Technical Manager

## Canada modem statements

This equipment meets the applicable Industry Canada technical specifications.

The Ringer Equivalence Number, REN, is an indication of the maximum number of devices allowed to be connected to a telephone interface. The termination on an interface may consist of any combination of devices, subject only to the requirement that the sum of the RENs of all devices does not exceed 5. The REN for this terminal equipment is 1.0.

## Japan modem statements

If the computer does not have the Japanese certification mark on the bottom of the computer, refer to the appropriate certification marking below.

The Japanese certification mark for the V.92 56K Data/Fax Modem is below:



## New Zealand modem statements

The grant of a Telepermit for any item of terminal equipment indicates only that Telecom has accepted that the item complies with minimum conditions for connection to its network. It indicates no endorsement of the product by Telecom, nor does it provide any sort of warranty. Above all, it provides no assurance that any item will work correctly in all respects with another item of Telepermitted equipment of a different make or model, nor does it imply that any product is compatible with all of Telecom's network services.

This equipment is not capable, under all operating conditions, of correct operation at the higher speeds for which it is designed. Telecom will accept no responsibility should difficulties arise in such circumstances.

If this device is equipped with pulse dialing, note that there is no guarantee that Telecom lines will always continue to support pulse dialing.

Use of pulse dialing, when this equipment is connected to the same line as other equipment, may give rise to bell tinkle or noise and may also cause a false answer condition. Should such problems occur, the user should *not* contact the Telecom Faults Service.

Some parameters required for compliance with Telecom's Telepermit requirements are dependent on the equipment (PC) associated with this device. The associated equipment shall be set to operate within the following limits for compliance with Telecom's Specifications:

- a. There shall be no more than 10 call attempts to the same number within any 30-minute period for any single manual call initiation.
- b. The equipment shall go on-hook for a period of not less than 30 seconds between the end of one attempt and the beginning of the next attempt.
- c. Where automatic calls are made to different numbers, the equipment shall be set to go on-hook for a period of not less than 5 seconds between the end of one attempt and the beginning of the next attempt.
- d. The equipment shall be set to ensure that calls are answered between 3 and 30 seconds of receipt of ringing (So set between 2 and 10).

## Voice support

All persons using this device for recording telephone conversations shall comply with New Zealand law. This requires that at least one party to the conversation is aware that it is being recorded. In addition, the Principles enumerated in the Privacy Act 1993 shall be complied with in respect to the nature of the personal information collected, the purpose for its collection, how it is to be used, and what is disclosed to any other party.

This equipment shall not be set to make automatic calls to the Telecom '111' Emergency Service.

## Power cord notice

If you were not provided with a power cord for the computer or for an external power accessory intended for use with the computer, you should purchase a power cord that is approved for use in your country or region.

The power cord must be rated for the product and for the voltage and current marked on the product's electrical ratings label. The voltage and current rating of the cord should be greater than the voltage and current rating marked on the product. In addition, the diameter of the wire must be a minimum of **0.75 mm<sup>2</sup>/18AWG**, and the length of the cord must be between **1.5 m** (5 ft) and **2 m** (6½ ft). If you have questions about the type of power cord to use, contact your authorized service provider.

A power cord should be routed so that it is not likely to be walked on or pinched by items placed upon it or against it. Particular attention should be paid to the plug, electrical outlet, and the point where the cord exits from the product.

## Japan power cord notice

製品には、同梱された電源コードをお使い下さい。  
同梱された電源コードは、他の製品では使用出来ません。

## DC plug of external HP power supply



 **NOTE:** This product is designed for IT power systems in Norway with phase-to-phase voltage not exceeding 240 V rms.

**NOTE:** The computer operating voltage and current can be found on the system regulatory label.

## Macrovision Corporation notice

This product incorporates copyright protection technology that is protected by method claims of certain U.S. patents and other intellectual property rights owned by Macrovision Corporation and other rights owners. Use of this copyright protection technology must be authorized by Macrovision Corporation and is intended for home and other limited viewing uses only, unless otherwise authorized by Macrovision Corporation. Reverse engineering or disassembly is prohibited.

---

## 2 Safety notices

### Heat-related safety warning notice

 **WARNING!** To reduce the possibility of heat-related injuries or of overheating the computer, do not place the computer directly on your lap or obstruct the computer air vents. Use the computer only on a hard, flat surface. Do not allow another hard surface, such as an adjoining optional printer, or a soft surface, such as pillows or rugs or clothing, to block airflow. Also, do not allow the AC adapter to contact the skin or a soft surface, such as pillows or rugs or clothing, during operation. The computer and the AC adapter comply with the user-accessible surface temperature limits defined by the International Standard for Safety of Information Technology Equipment (IEC 60950).

### Potential safety conditions notice

If you notice any of the following conditions (or if you have other safety concerns), do not use the computer: crackling, hissing, or popping sound, or a strong odor or smoke coming from the computer. It is normal for these conditions to appear when an internal electronic component fails in a safe and controlled manner. However, these conditions may also indicate a potential safety issue. Do not assume it is a safe failure. Turn off the computer, disconnect it from its power source, and contact technical support for assistance.

### Battery notices

 **WARNING!** To reduce the risk of fire or burns, do not disassemble, crush, or puncture; do not short external contacts; do not dispose of in fire or water.

**WARNING!** Keep the battery away from children.

**WARNING!** To reduce potential safety issues, only the battery provided with the computer, a replacement battery provided by HP, or a compatible battery purchased as an accessory from HP should be used with the computer.

### Headset and earphone volume level notice

 **WARNING!** Listening to music at high volume levels and for extended durations can damage one's hearing. To reduce the risk of hearing damage, lower the volume to a safe, comfortable level and reduce the amount of time listening at high levels.

For your own safety, before using headsets or earphones, always reset the volume. Some headphones are louder than other headphones, even if the volume control setting is the same.

Changing the default audio or equalizer settings might lead to higher volume and should only be done with caution.

For your own safety, headsets or earphones used with this product should comply with the headphone limits in EN 50332-2.

If the computer includes a headset or earphones, this combination is in compliance to EN 50332-1.

## Power cord notices

---

 **WARNING!** To reduce the risk of electric shock or damage to the equipment:

Plug the power cord into an AC outlet that is easily accessible at all times.

Disconnect power from the computer by unplugging the power cord from the AC outlet (not by unplugging the power cord from the computer).

If provided with a 3-pin attachment plug on the power cord, plug the cord into a grounded (earthed) 3-pin outlet. Do not disable the power cord grounding pin, for example, by attaching a 2-pin adapter. The grounding pin is an important safety feature.

**WARNING!** To reduce potential safety issues, only the AC adapter provided with the computer, a replacement AC adapter provided by HP, or an AC adapter purchased as an accessory from HP should be used with the computer.

---

## Cleaning the keyboard

---

 **WARNING!** To reduce the risk of electric shock or damage to internal components, do not use a vacuum cleaner attachment to clean the keyboard. A vacuum cleaner can deposit household debris on the keyboard surface. Clean the keyboard regularly to prevent keys from sticking and to remove dust, lint, and particles that can become trapped beneath the keys. A can of compressed air with a straw extension can be used to blow air around and under the keys to loosen and remove debris.

---

## Travel notice

---

 **WARNING!** To reduce the risk of electric shock, fire, or damage to the equipment, do not attempt to power the computer with a voltage converter kit sold for appliances.

---

## Norway and Sweden: Cable grounding notice for products with a TV tuner

---

 **CAUTION:** To reduce potential safety issues, use a galvanic isolator when connecting to a cable distribution system.

---



---

## 3 Environmental notices

This chapter provides country- and region-specific environmental notices and compliance information. Some of these notices may not apply to your product.

### Electronic hardware and battery recycling

HP encourages customers to recycle used electronic hardware, HP original print cartridges, and rechargeable batteries. For more information about recycling programs, see the HP Web site at <http://www.hp.com/recycle>.

### Disposal of waste equipment by users in private households in the European Union



This symbol means do not dispose of your product with your other household waste. Instead, you should protect human health and the environment by handing over your waste equipment to a designated collection point for the recycling of waste electrical and electronic equipment. For more information, please contact your household waste disposal service.

### Chemical substances

HP is committed to providing our customers with information about the chemical substances in our products as needed to comply with legal requirements such as REACH (Regulation EC No 1907/2006 of the European Parliament and the Council). A chemical information report for this product can be found at <http://www.hp.com/go/reach>.

# China material content declarations

## 微型计算机电源声明书

### 能耗信息说明

惠普公司对笔记本电脑提供能耗信息说明，更多信息请登陆  
<http://www.hp.com/hpinfo/globalcitizenship/environment/productdata/chinasepa.html>

当本产品进行操作时，若在未接任何外部输入电源的状态下，产品将实现零能耗的状况，特此声明。

### 回收信息说明

惠普公司对废弃的电子计算机（笔记本电脑）提供回收服务，更多信息请登陆  
<http://h20423.www2.hp.com/program/suppliesrecycling/cn/zh/hardware/index.asp>

### 环境标志信息

笔记本电脑已在中国环境标志认证产品的范围中，环境标志表明该产品不仅品质合格，而且在生产、使用和处理处置过程中符合特定的环境保护要求，与同类产品相比，具有低毒少害、节约资源等环境优势，在国家环境保护部网站（<http://www.sepa.gov.cn>）上可浏览到关于环境标志的信息。

## The Table of Toxic and Hazardous Substances/Elements and their Content

As required by China's Management Methods for Controlling Pollution by Electronic Information Products



| Toxic and Hazardous Substances and Elements |           |              |              |                              |                                |                                       |
|---|-----------|--------------|--------------|------------------------------|--------------------------------|---------------------------------------|
| Part Name                                   | Lead (Pb) | Mercury (Hg) | Cadmium (Cd) | Hexavalent Chromium (Cr(VI)) | Polybrominated biphenyls (PBB) | Polybrominated diphenyl ethers (PBDE) |
| Battery                                     | X         | O            | O            | O                            | O                              | O                                     |
| Cables                                      | X         | O            | O            | O                            | O                              | O                                     |
| Camera                                      | X         | O            | O            | O                            | O                              | O                                     |
| Chassis/Other                               | X         | O            | O            | O                            | O                              | O                                     |
| Flash memory card reader                    | X         | O            | O            | O                            | O                              | O                                     |
| Floppy disk drive                           | X         | O            | O            | O                            | O                              | O                                     |
| Hard disk drive                             | X         | O            | O            | O                            | O                              | O                                     |
| Headphones                                  | X         | O            | O            | O                            | O                              | O                                     |
| I/O PCAs                                    | X         | O            | O            | O                            | O                              | O                                     |
| Keyboard                                    | X         | O            | O            | O                            | O                              | O                                     |

**Toxic and Hazardous Substances and Elements**

| <b>Part Name</b>                   | <b>Lead (Pb)</b> | <b>Mercury (Hg)</b> | <b>Cadmium (Cd)</b> | <b>Hexavalent Chromium (Cr(VI))</b> | <b>Polybrominated biphenyls (PBB)</b> | <b>Polybrominated diphenyl ethers (PBDE)</b> |
|------------------------------------|------------------|---------------------|---------------------|-------------------------------------|---------------------------------------|--|
| Liquid crystal display (LCD) panel | X                | X                   | O                   | O                                   | O                                     | O  |
| Media (CD/DVD/floppy)              | O                | O                   | O                   | O                                   | O                                     | O  |
| Memory                             | X                | O                   | O                   | O                                   | O                                     | O  |
| Motherboard, processor, heat sinks | X                | O                   | O                   | O                                   | O                                     | O  |
| Mouse                              | X                | O                   | O                   | O                                   | O                                     | O  |
| Optical disk drive                 | X                | O                   | O                   | O                                   | O                                     | O  |
| Optional docking device            | X                | O                   | O                   | O                                   | O                                     | O  |
| Power adapter                      | X                | O                   | O                   | O                                   | O                                     | O  |
| Power supply                       | X                | O                   | O                   | O                                   | O                                     | O  |
| Remote control                     | X                | O                   | O                   | O                                   | O                                     | O  |
| Smart card/Java™ card reader       | X                | O                   | O                   | O                                   | O                                     | O  |
| Speakers, external                 | X                | O                   | O                   | O                                   | O                                     | O  |
| TV tuner                           | X                | O                   | O                   | O                                   | O                                     | O  |
| USB flash memory drive             | X                | O                   | O                   | O                                   | O                                     | O  |
| USB hub                            | X                | O                   | O                   | O                                   | O                                     | O  |
| Web camera                         | X                | O                   | O                   | O                                   | O                                     | O  |
| Wireless receiver                  | X                | O                   | O                   | O                                   | O                                     | O  |
| Wireless cards                     | X                | O                   | O                   | O                                   | O                                     | O  |

O: Indicates that this toxic or hazardous substance contained in all of the homogeneous materials for this part is below the limit requirement in SJ/T11363-2006.

X: Indicates that this toxic or hazardous substance contained in at least one of the homogeneous materials used for this part is above the limit requirement in SJ/T11363-2006.

All parts named in this table with an X are in compliance with the European Union's RoHS Legislation "Directive 2002/95/EC of the European Parliament and of the Council of 27 January 2003 on the restriction of the use of certain hazardous substances in electrical and electronic equipment" and its amendments.

**NOTE:** The referenced Environmental Protection Use Period Marking was determined according to normal operating use conditions of the product such as temperature and humidity.

## 产品中有毒有害物质或元素的名称及含量

根据中国《电子信息产品污染控制管理办法》



Toxic and Hazardous Substances and Elements

| 部件名称                 | 铅 (Pb) | 汞 (Hg) | 镉 (Cd) | 六价铬 (Cr(VI)) | 多溴联苯 (PBB) | 多溴二苯醚 (PBDE) |
|----------------------|--------|--------|--------|--------------|------------|--------------|
| 电池                   | X      | ○      | ○      | ○            | ○          | ○            |
| 电池                   | X      | ○      | ○      | ○            | ○          | ○            |
| 数码相机                 | X      | ○      | ○      | ○            | ○          | ○            |
| 相机 / 其他              | X      | ○      | ○      | ○            | ○          | ○            |
| 闪存卡/器                | X      | ○      | ○      | ○            | ○          | ○            |
| 键盘                   | X      | ○      | ○      | ○            | ○          | ○            |
| 硬盘                   | X      | ○      | ○      | ○            | ○          | ○            |
| 耳机                   | X      | ○      | ○      | ○            | ○          | ○            |
| I/O PCBs             | X      | ○      | ○      | ○            | ○          | ○            |
| 键盘                   | X      | ○      | ○      | ○            | ○          | ○            |
| 液晶显示屏                | X      | X      | ○      | ○            | ○          | ○            |
| 光盘 (CD/DVD/ 软盘)      | ○      | ○      | ○      | ○            | ○          | ○            |
| 内存条                  | X      | ○      | ○      | ○            | ○          | ○            |
| 主板, 处理器和散热器          | X      | ○      | ○      | ○            | ○          | ○            |
| 鼠标                   | X      | ○      | ○      | ○            | ○          | ○            |
| 光驱                   | X      | ○      | ○      | ○            | ○          | ○            |
| 网络设备选项               | X      | ○      | ○      | ○            | ○          | ○            |
| 电源适配器                | X      | ○      | ○      | ○            | ○          | ○            |
| 电源                   | X      | ○      | ○      | ○            | ○          | ○            |
| 温控器                  | X      | ○      | ○      | ○            | ○          | ○            |
| Smart 卡 / Java 卡/读卡器 | X      | ○      | ○      | ○            | ○          | ○            |
| 内置扬声器                | X      | ○      | ○      | ○            | ○          | ○            |
| 电视接收器                | X      | ○      | ○      | ○            | ○          | ○            |
| USB 闪存盘              | X      | ○      | ○      | ○            | ○          | ○            |
| USB 集线器              | X      | ○      | ○      | ○            | ○          | ○            |
| 网络摄像头                | X      | ○      | ○      | ○            | ○          | ○            |
| 无线接收器                | X      | ○      | ○      | ○            | ○          | ○            |
| 无线网卡                 | X      | ○      | ○      | ○            | ○          | ○            |

○: 表示该有毒有害物质在该部件所有均质材料中的含量均在 SJ/T11363-2006 标准规定的限量要求以下。  
 X: 表示该有毒有害物质至少在该部件的某一均质材料中的含量超出 SJ/T11363-2006 标准规定的限量要求。  
 表中标有“X”的所有部件都符合欧盟 RoHS 法规“欧洲议会和欧盟理事会 2002 年 1 月 27 日关于电子电气设备中限制使用某些有害物质 2002/95/EC 号指令”。

注: 环保使用期限的参考知识取决于产品正常工作的温度和湿度等条件。

## Japan material content declaration

A Japanese regulatory requirement, defined by specification JIS C 0950, 2008, mandates that manufacturers provide material content declarations for certain categories of electronic products offered for sale after July 1, 2006. To view the JIS C 0950 material declaration for this product, see the HP Web site at <http://www.hp.com/go/jisc0950>.

2008年、日本における製品含有表示方法、JISC0950が公示されました。製造事業者は、2006年7月1日以降に販売される電気・電子機器の特定化学物質の含有につきまして情報提供を義務付けられました。製品の部材表示につきましては、[www.hp.com/go/jisc0950](http://www.hp.com/go/jisc0950)を参照してください。

## Turkey EEE regulation

In Conformity with the EEE regulation

EEE Yönetmeliğine Uygundur

## Ukraine Restriction of Hazardous Substances

The equipment complies with requirements of the Technical Regulation, approved by the Resolution of Cabinet of Ministry of Ukraine as of December 3, 2008 № 1057, in terms of restrictions for the use of certain dangerous substances in electrical and electronic equipment.

### **Україна обмеження на наявність небезпечних речовин**

Обладнання відповідає вимогам Технічного регламенту щодо обмеження використання деяких небезпечних речовин в електричному та електронному обладнанні, затвердженого постановою Кабінету Міністрів України від 3 грудня 2008 № 1057.

## United States mercury disposal

This HP product contains the following materials that might require special handling at end-of-life:

- Mercury in the fluorescent lamp in the display LCD

Disposal of mercury can be regulated because of environmental considerations. For disposal or recycling information, please contact your local authorities or the Electronic Industries Alliance (EIA) <http://www.eiae.org>.



---

**NOTE:** Notebook computers configured with LED backlights do not contain mercury lamps.

---

## Perchlorate material—special handling may apply

See <http://www.dtsc.ca.gov/hazardouswaste/perchlorate>.

This product's real-time clock battery or coin cell battery may contain perchlorate and may require special handling when recycled or disposed of in California.

---

# Index

- A**
  - airline travel notice 10
- B**
  - battery notice 10, 17, 23
  - battery recycling 19
  - Brazil notice 4
- C**
  - cable grounding notice 18
  - Canada modem statement 15
  - Canada notices 4
  - Canadian French notices 4
  - China Material Content Declarations 20
- D**
  - DC plug of external HP power supply notice 16
  - Declaration of Conformity 3
  - disposal notices
    - battery 10, 23
    - equipment 19
    - mercury 23
- E**
  - electronic hardware and battery recycling 19
  - ENERGY STAR compliance 10
  - environmental notices 19
  - equipment disposal notice 19
  - ergonomics notice 6
  - European Union notices 4
- F**
  - Federal Communications Commission
    - cables 2
    - modifications 2
    - notice 2
- G**
  - GS Notice 6
- H**
  - hardware device, identifying 1
  - headset and earphone volume level notice 17
- J**
  - Japan material content declaration 22
  - Japan modem statement 15
  - Japan notice 7
  - Japan power cord notice 16
- K**
  - keyboard notice 18
- L**
  - laser safety notice 11
- M**
  - Macrovision Corporation notice 16
  - mercury disposal notice 23
  - Mexico wireless notice 8
  - modem notices 11
  - modem statements
    - Canada 15
    - Japan 15
    - New Zealand 15
    - U.S. 12
  - modifications, Federal Communications Commission 2
- N**
  - New Zealand modem statement 15
  - notices
    - airline travel 10
    - battery 10, 17, 23
    - Brazil 4
    - Canada 4
    - Canadian French 4
    - DC plug of external HP power supply 16
    - environmental 19
    - equipment disposal 19
    - ergonomics 6
    - European Union 4
    - Federal Communications Commission 2
    - headset and earphone volume level 17
    - Japan 7
    - Japan power cord 16
    - keyboard 18
    - laser safety 11
    - Macrovision Corporation 16
    - mercury disposal 23
    - Mexico 8
    - modem 11
    - perchlorate material 23
    - power cords 16, 18
    - Singapore 8
    - South Korea 8
    - Taiwan 9
    - Thailand WWAN wireless notice 8
    - travel 18
    - Ukraine restriction of hazardous substances 23
    - Vietnam compliance marking 9
- P**
  - power cord notice 16, 18
- R**
  - recycling, electronic hardware and battery 19
- S**
  - Singapore wireless notice 8
  - South Korea notice 8
- T**
  - Taiwan notice 9
  - Thailand WWAN wireless notice 8
  - travel notice 18
  - TV tuner, cable grounding notice 18

## U

U.S. modem statement 12

Ukraine restriction of hazardous  
substances notice 23

## V

Vietnam compliance marking  
notice 9

voice support 16

volume level notice, headset and  
earphone 17

## W

wireless LAN devices 3