



**Bluetooth Low Energy
(BLE) 4.2 Module
Model MB-N2 Data Sheet**

Date: Nov 2016

Version: 0.1 (Initial Draft)

E-mail: info@redbear.cc

Website: www.redbear.cc

Red Bear Company Limited assumes no responsibility for any errors which may appear in this manual. And reserves the right to alter the hardware, software, and/or specifications detailed here at any time without notice.



Document release	Date	Modification	Initials
Version 0.1	2016/11/01	Initial version	Ping

Red Bear Company Limited



Description

MB-N2 BLE module houses the Nordic nRF52832 SoC with an on-board chip antenna tuning for great performance and low power consumption.

MB-N2 offers all Bluetooth low energy features: radio, stack, profiles and application space for customer applications, so no external processor is needed. The module also provides flexible hardware interfaces to connect sensors, simple user interfaces or even displays directly to the module.

MB-N2 can be powered directly with a standard 3V coin cell batteries or pair of 3A batteries. In lowest power sleep mode, it consumes only 0.4uA and will wake up in few hundred microseconds.

For the nRF52832 SoC, refers to the nRF52832 Product Specification and the SDK is available from the Nordic Semiconductor website.

Key Features

- Bluetooth 4.2 certified, 5.0 ready (BLE only)
- 32-bit ARM Cortex-M4F processor @ 64MHz
- FPU, DSP
- Up to 64 KB SRAM and 512 KB Flash
- Certified for CE, FCC and Bluetooth
- Small size 10 mm x 18 mm
- An on-board chip antenna tuning for great performance
-

Applications

- Sports and leisure equipment
- Heart rate collector
- Pedometer
- Watches
- Cycling and cadence sensor
- Consumer electronics
- Human Interface Devices (Keyboard, Mouse)
- Consumer medical
- Smart energy
- Security finder
- Proximity and presence
- Home and building automation

1. Package Pinout Diagram

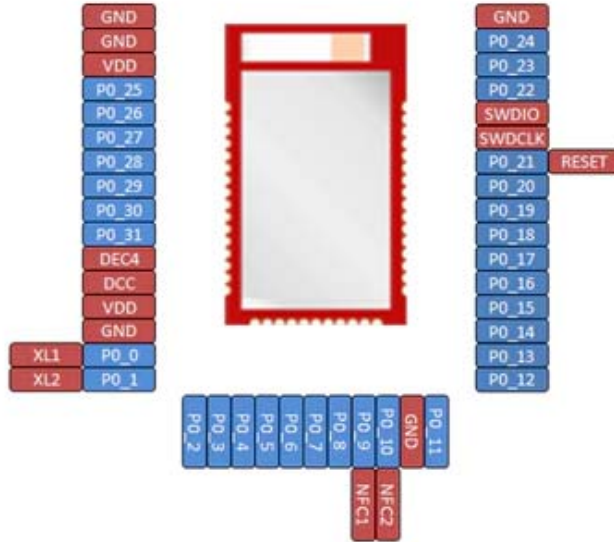

2. Reference Schematic

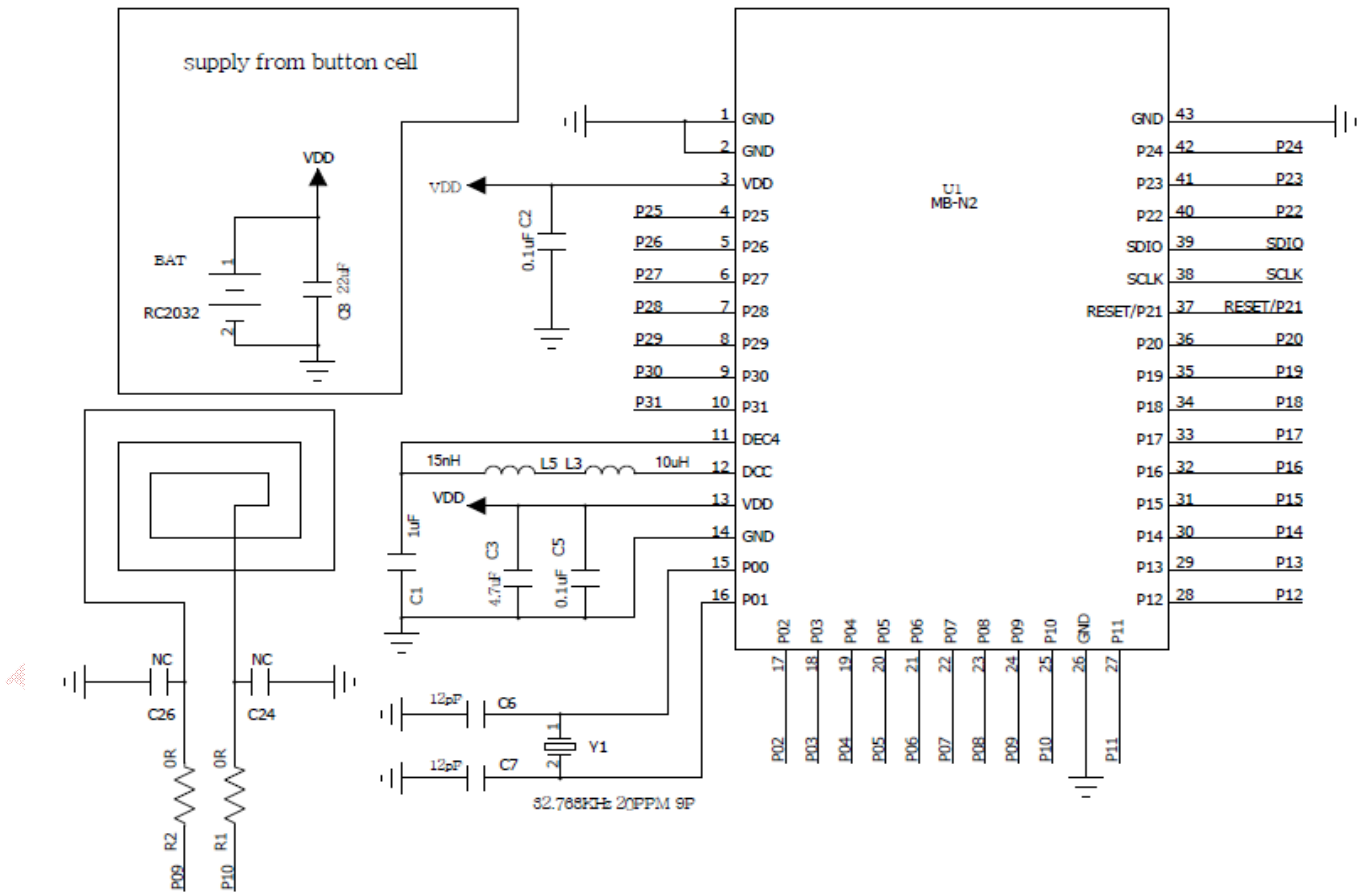

3. Module Physical Dimensions

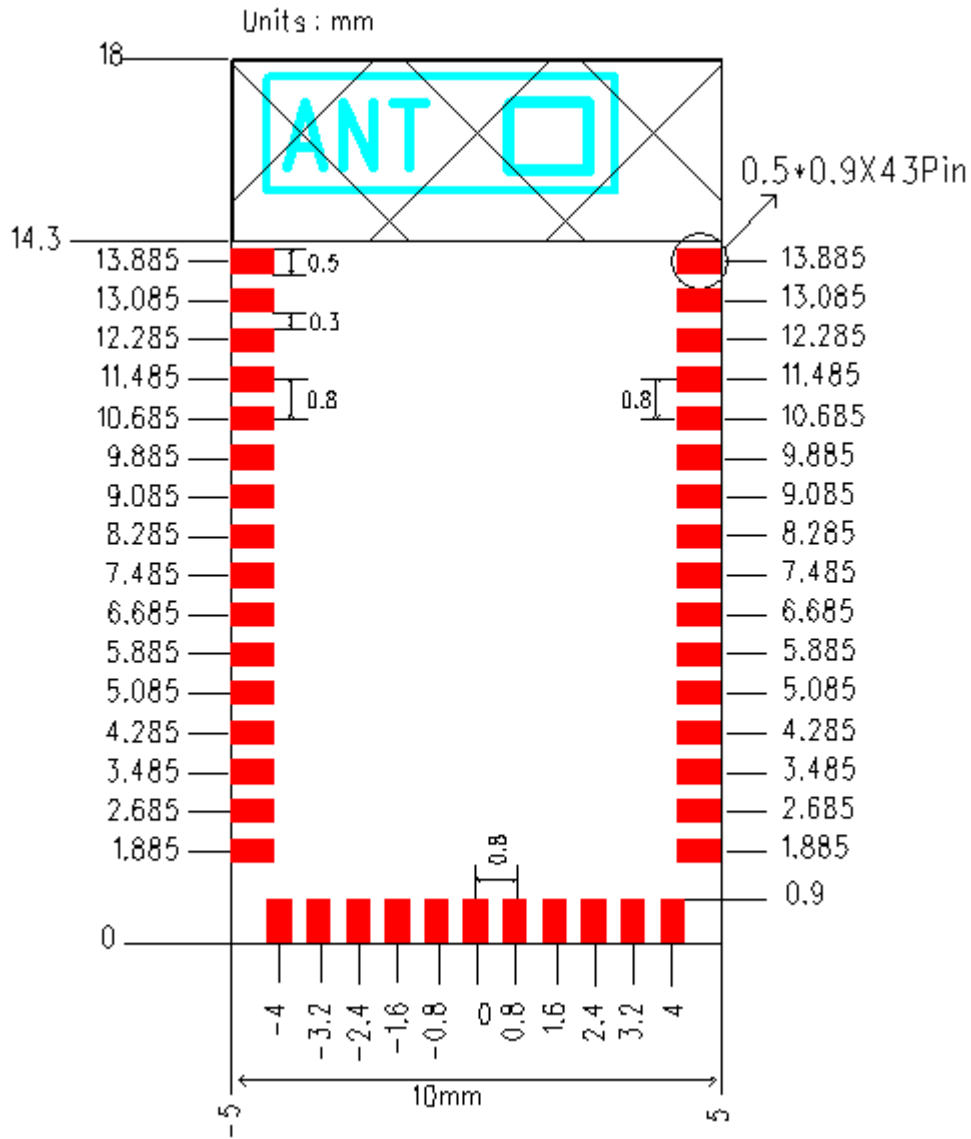

4. Layout Guide

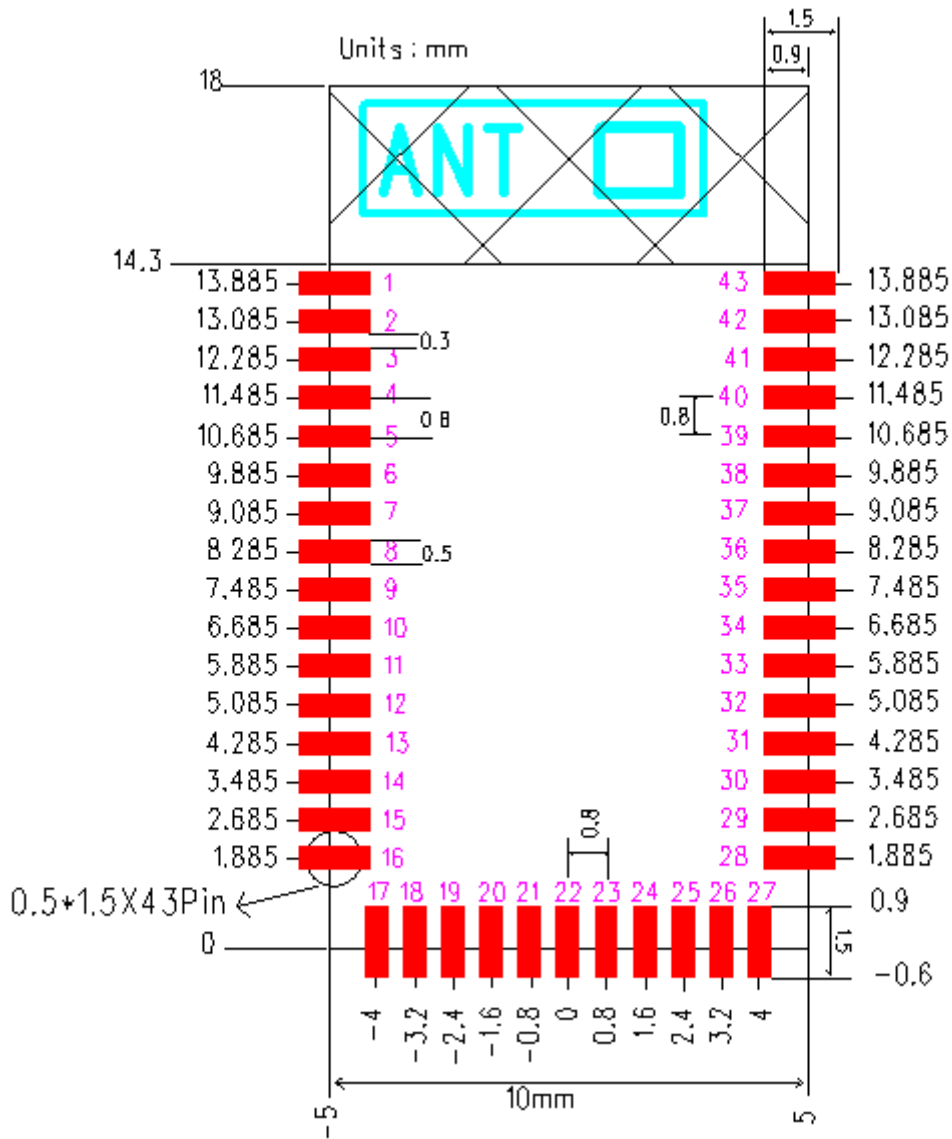

5. Pin Assignment

Pin No.	Name	Type	Description
(1)(2)(14) (26)(43)	GND	Ground	Ground. The pad must be connected to a solid ground plane
(3)(13)	VDD	POWER	Power supply (1.9 – 3.6V)
(4)	P0.25	Digital I/O	General purpose I/O pin
(5)	P0.26	Digital I/O	General purpose I/O pin
(6)	P0.27	Digital I/O	General purpose I/O pin.
(7)	P0.29 AIN4	Digital I/O Analog Input	General purpose I/O pin. SAADC/COMP/LPCOMP input.
(8)	P0.29 AIN5	Digital I/O Analog Input	General purpose I/O pin. SAADC/COMP/LPCOMP input.
(9)	P0.30 AIN6	Digital I/O Analog Input	General purpose I/O pin. SAADC/COMP/LPCOMP input.
(10)	P0.31 AIN7	Digital I/O Analog Input	General purpose I/O pin. SAADC/COMP/LPCOMP input.
(11)	DEC4	POWER	1V3 regulator supply decoupling. Input from DC/DC regulator. Output from 1.3 V LDO.
(12)	DCC	POWER	DC/DC regulator output pin.
(15)	P0.00 XL1	Digital I/O Analog Input	General purpose I/O pin. Connection for 32.768 kHz crystal (LFXO).
(16)	P0.01 XL2	Digital I/O Analog Input	General purpose I/O pin. Connection for 32.768 kHz crystal (LFXO).
(17)	P0.02 AIN0	Digital I/O Analog Input	General purpose I/O pin. SAADC/COMP/LPCOMP input.



Pin No.	Name	Type	Description
(18)	P0.03 AIN1	Digital I/O Analog Input	General purpose I/O pin. SAADC/COMP/LPCOMP input.
(19)	P0.04 AIN2	Digital I/O Analog Input	General purpose I/O pin. SAADC/COMP/LPCOMP input.
(20)	P0.05 AIN3	Digital I/O Analog Input	General purpose I/O pin. SAADC/COMP/LPCOMP input.
(21)	P0.06 AIN4	Digital I/O Analog Input	General purpose I/O pin. SAADC/COMP/LPCOMP input.
(22)	P0.07	Digital I/O	General purpose I/O pin.
(23)	P0.08	Digital I/O	General purpose I/O pin.
(24)	P0.09	Digital I/O	General purpose I/O pin.
(25)	P0.10	Digital I/O	General purpose I/O pin.
(27)	P0.11	Digital I/O	General purpose I/O pin.
(28)	P0.12	Digital I/O	General purpose I/O pin.
(29)	P0.13	Digital I/O	General purpose I/O pin.
(30)	P0.14 TRACEDATA(3)	Digital I/O	General purpose I/O pin. Trace port output.
(31)	P0.15 TRACEDATA(2)	Digital I/O	General purpose I/O pin. Trace port output.
(32)	P0.16 TRACEDATA(1)	Digital I/O	General purpose I/O pin. Trace port output.
(33)	P0.17	Digital I/O	General purpose I/O pin.



Pin No.	Name	Type	Description
(34)	P0.18 TRACEDATA(0) SWO	Digital I/O	General purpose I/O pin. Single Wire Output.
(35)	P0.19	Digital I/O	General purpose I/O pin.
(36)	P0.20 TRACECLK	Digital I/O	General purpose I/O pin. Trace port clock output.
(37)	P0.21 RESET	Digital I/O	General purpose I/O pin. Configurable as pin reset.
(38)	SWDCLK	Digital Input	Serial Wire Debug clock input for debug and programming.
(39)	SWDIO	Digital I/O	Serial Wire Debug I/O for debug and programming.
(40)	P0.22	Digital I/O	General purpose I/O pin.
(41)	P0.23	Digital I/O	General purpose I/O pin.
(42)	P0.24	Digital I/O	General purpose I/O pin.

FCC Statement

This device complies with part 15 of the FCC Rules. Operation is subject to the following two conditions: (1) This device may not cause harmful interference, and (2) this device must accept any interference received, including interference that may cause undesired operation.

Changes or modifications not expressly approved by the party responsible for compliance could void the user's authority to operate the equipment.

This modular complies with FCC RF radiation exposure limits set forth for an uncontrolled environment. This transmitter must not be co-located or operating in conjunction with any other antenna or transmitter.

If the FCC identification number is not visible when the module is installed inside another device, then the outside of the device into which the module is installed must also display a label referring to the enclosed module. This exterior label can use wording such as the following: "Contains Transmitter Module FCC ID: 2AKGS-MBN2 Or Contains FCC ID: 2AKGS-MBN2"

When the module is installed inside another device, the user manual of the host must contain below warning statements;

1. This device complies with Part 15 of the FCC Rules. Operation is subject to the following two conditions:
(1) This device may not cause harmful interference.
(2) This device must accept any interference received, including interference that may cause undesired operation.

2. Changes or modifications not expressly approved by the party responsible for compliance could void the user's authority to operate the equipment.

The devices must be installed and used in strict accordance with the manufacturer's instructions as described in the user documentation that comes with the product

6. PCB Layout Guide

For optimal performance of the antenna, place the module at the corner of the PCB as shown in the diagram below, do not place any metal (traces, components, battery etc.) within the clearance area of the antenna. Place the GND vias as close to the GND pins as possible.

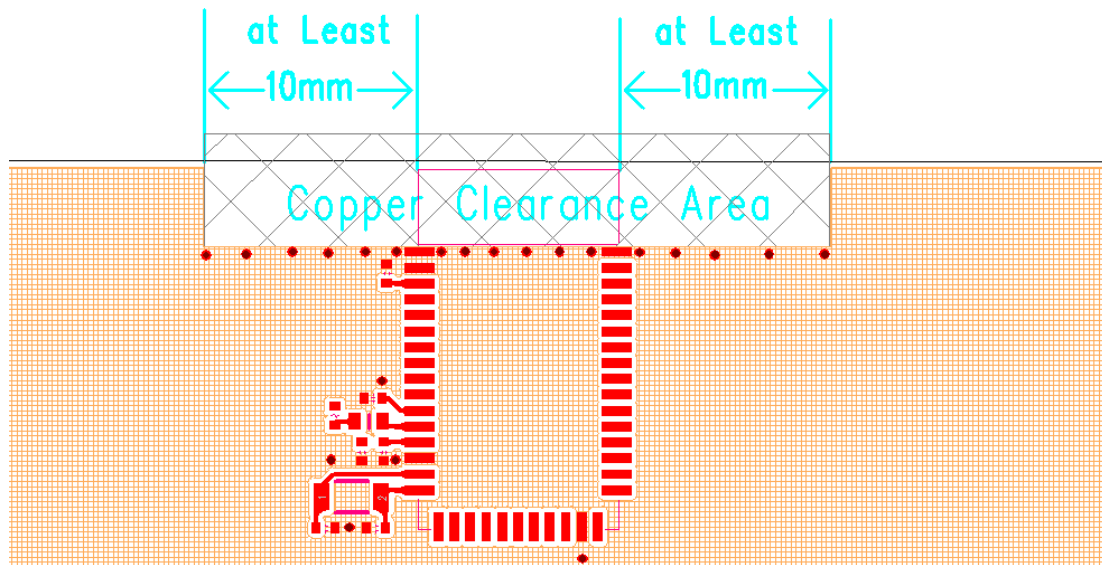

Recommended layout

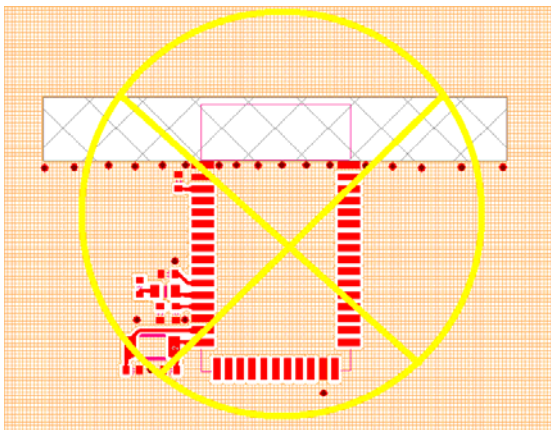

Bad design

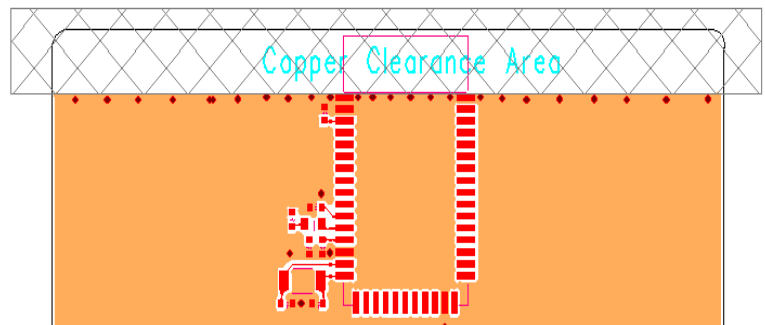

Best design

7. 3D Radiation Pattern

ACX
Advanced Ceramic X

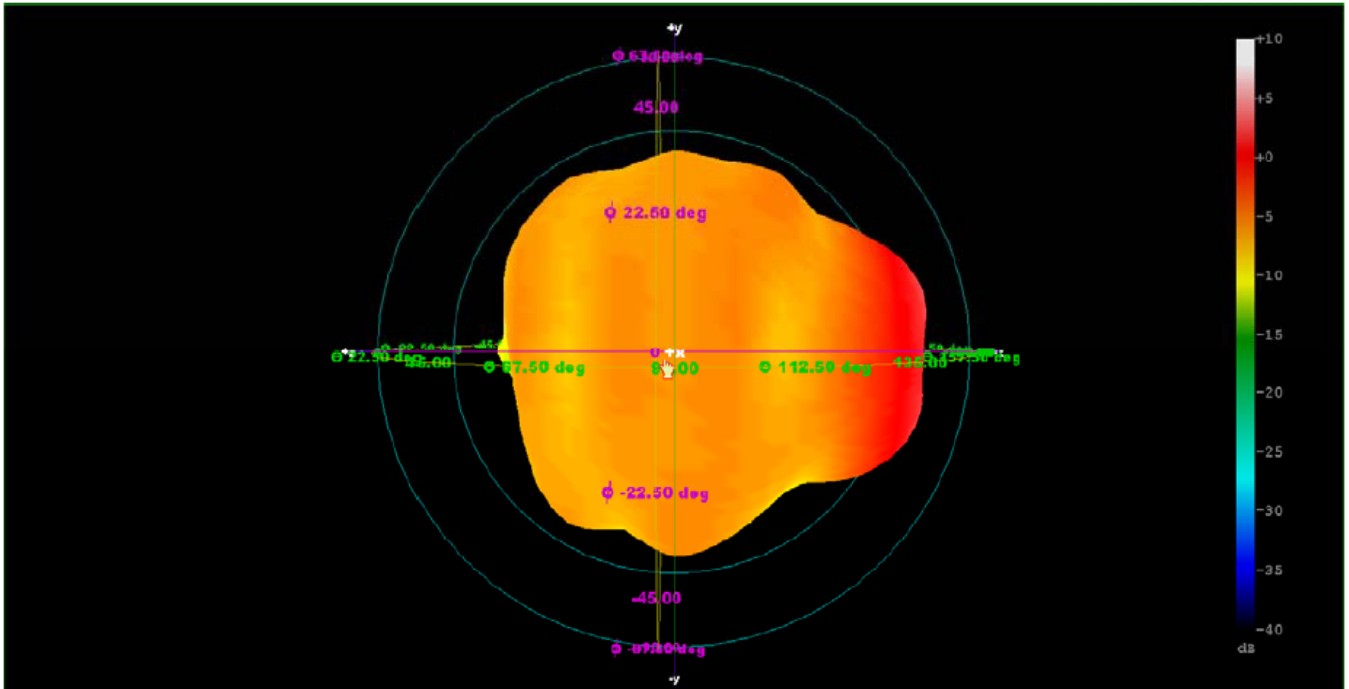

Red Bear Com

◆ XY-plane

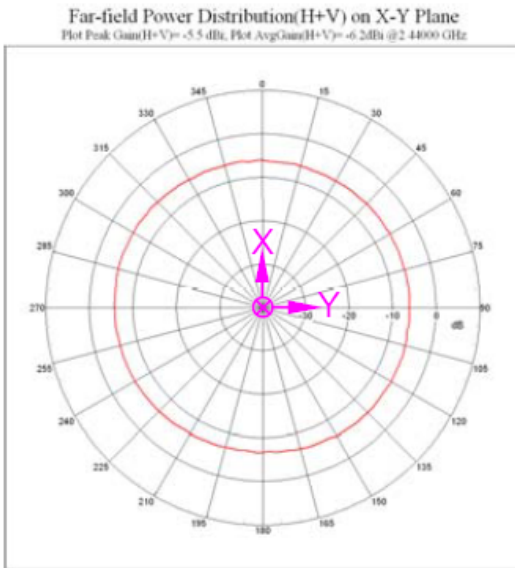

◆ XZ-plane

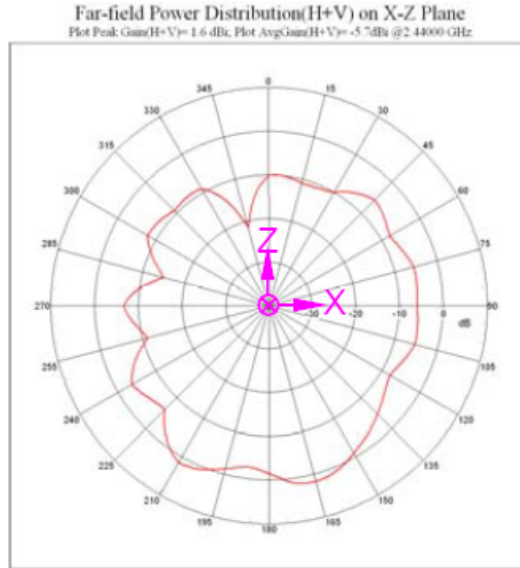

◆ YZ-plane

