

**EVERYONE
CAN NOW
ENJOY
HOT WATER
ON TAP.**



HOT WATER CYLINDERS

Unvented Direct, Indirect and
Solar 400-2500 litres.

OR remeha
commercial

REMEHA HOT WATER CYLINDERS OVERVIEW

INTRODUCTION

60% of the buildings that will be standing in 2050 are already here with us today. So tomorrow, there will be a great need for intelligent heating technology specifically designed for refurbished buildings. This is where Remeha's advanced thinking is leading the way. To a future where our highly efficient heating systems help to improve the overall energy efficiency of refurbished buildings. Giving them new life and a more sustainable future.

Remeha is committed to helping create a more sustainable future with our comprehensive range of energy-efficient, low-carbon heating solutions. Our superior quality, British-manufactured hot water cylinder range offers 24 options of Unvented Direct, Indirect and Solar cylinders with 400l, 500l, 800l, 1000l, 1250l, 2000l and 2500l models available in each of the three categories. A range of optional immersion heater units is also available to provide boost and backup.

WHY CHOOSE DUPLEX STAINLESS STEEL?

Remeha Commercial cylinders are manufactured from Duplex 2205 stainless steel to EN 1.4462, ASTM S3 2205/S31803 (with PRE value of 35). This Ferritic-Austenitic steel combines high strength, excellent corrosion resistance and stress corrosion cracking resistance as well as excellent pitting resistance. This marine-grade Duplex gives a low thermal expansion and high chloride resistance. It has a great strength-to-weight ratio which allows the finished cylinder to be substantially lower than other materials.

2205 is a high specification grade of Duplex stainless steel, making it highly suitable for commercial water cylinders. 2205 has approximately twice the proof strength of standard 304 and 316 types of stainless steel, meaning it is well equipped to deal with the system pressures involved. The pitting and crevice corrosion resistance in potable water is greater than that of 316 stainless and other leaner alloyed Duplex stainless types often used in water cylinders. End users can therefore be assured of a long trouble-free service life.

The Duplex metallurgical structure is carefully balanced to provide dual austenitic and ferritic phases, which provides the high strength level and acts as an effective impediment to stress corrosion and cracking.

Remeha Commercial cylinders come with a 6 bar operating pressure as standard. The design options being maximised by this choice.

Flow rates are crucial to today's hot water specifiers

We have all been in a hotel where the shower does not perform and we have to run around to get wet. Why? Because the hot water system was not designed correctly. Today this all changes with Remeha Commercial, typically massive flow rates in excess of 100 litres/min can be achieved. If you have higher than that coming in, the cylinder will deliver that too.

Heat recovery in minutes, not hours

Remeha Commercial cylinders are designed in such a way that if provided with the prescribed heat input, the units will recover from cold in less than 60* minutes. This is done by the inclusion of super high performance coils or commercial electrical elements.

Remeha Hot Water Cylinders are approved and certified by a third party for safety and performance and manufactured in the UK.



* Depending on incoming cold water temperature and primary flow conditions.

REMEHA HOT WATER CYLINDERS OVERVIEW

Remeha's range of Hot Water Cylinders meets all British environmental legislation and regulation standards as well as EU Directives. This includes the recommendations of HSE Document L8 relating to Legionella Pneumophila, with the cylinders containing a minimum of two inspection ports (three on larger models) and three optional destratification loop kits to circulate the hot water and enable pasteurisation.

CODES OF PRACTICE/LEGISLATION

EU Directives

Pressure Equipment Directive 97/23/EC.

Low Voltage Directive (LVD) 2006/95/EC.

Electromagnetic Compatibility (EMC) Directive 2004/108/EC.

Ecodesign Requirements for Energy Related Products (ERP) Directive 2009/125/EC.

Legislation

Building Regulations Part G and Part L (England and Wales).

Scottish Building Standards Section 4 and Section 6.

Building Regulations (Northern Ireland) Parts F1 and F2 and Part P.

Water Supply (Water Fittings) Regulations (England and Wales).

The Water Byelaws 2004 Scotland.

Water Supply (Water Fittings) Regulations (Northern Ireland).

Standards

Relevant clauses of the following standards are complied with: EN 12897, EN 60335-2-21.

The stainless steel materials used comply with the relevant clauses of: EN 10088.

Components supplied comply with the following standards:

BS EN 1490 Building Valves – Combined Temperature and Pressure Relief Valves.

BS EN 1491 Building Valves – Expansion Valves.

BS 6144 Specification for Expansion Vessels Using An Internal Diaphragm For Unvented Water Supply Systems.

BS EN 1567 Building Valves – Water Pressure Reducing Valves and Combination Reducing Valves.

BS EN 60730-2-9 Automatic Electrical Controls – Particular Requirements for Temperature Sensing Controls.

BS EN 60730-2-8 Automatic Electrical Controls – Particular Requirements for Electrically Operated Water Valves.

BS EN 13959 Anti-pollution Check Valves.

The use of these water heaters will aid in compliance with:

Health and Safety Executive Approved Code of Practice L8: The control of legionella bacteria in water systems.

BS EN 806 Parts 1 to 5: Specification for installations inside buildings conveying water for human consumption.

BS 8558 Guide to the design, installation, testing and maintenance of services supplying water for domestic use within buildings.

Chartered Institute of Building Services Engineers Guide B and Guide F.

Manufactured in a factory approved to:

BS EN ISO 9001 · OHSAS 18001 · ISO 14001

LEGIONELLA PNEUMOPHILIA – MEETING RECOMMENDATIONS OF HSE DOCUMENT L8

- It is the responsibility of us all to consider the safety of others when designing and installing hot water systems. Advice on doing so is contained in HSE document L8, this advice is heavily detailed and precise
- Essentially, it is recommended that any cylinder should have access for inspection and cleaning, a system of pasteurisation and where possible dead legs in the system are designed out
- Remeha Commercial provides features which meet these needs.
- A minimum of two inspection ports (three on larger models)
- Three optional destratification loop kits (shunt pumps) are available to circulate the hot water from top to bottom to enable pasteurisation

Temperature vs state of legionella bacteria:

20°C and below	Legionella bacteria are dormant
20°C to 45°C	Legionella bacteria multiply
55°C	Legionella bacteria die in five to six hours
60°C	Legionella bacteria die in 32 minutes
66°C	Legionella bacteria die in two minutes
Above 70°C	Disinfection taking place

Some large cylinders have high heat losses, substantially increasing fuel costs and pollution. All this ends with the Remeha Commercial range.

- The Remeha Commercial range of cylinders are insulated with 100mm of polyurethane foam of initial K-value 0.024 W/m.k, flammability to BS 4735
- The foam is applied to all surfaces of the cylinder including around the legs and the lifting lugs at the top

Remeha Commercial cylinders are fully approved and certified.

Typically calorifiers are made to British and European manufacturing standards. These units are generally bespoke and essentially one-off, the performance is not tested or qualified by any third party. Claims made for performance will be based on calculations rather than testing.

That is not the case with Remeha Commercial cylinders. The range has been tested by Kiwa and Nemko for safety and performance. They are built entirely in a purpose-designed manufacturing facility in the UK.

REMEHA HOT WATER CYLINDERS OVERVIEW

REMEHA COMMERCIAL HOT WATER CYLINDERS MODEL RANGE

24 models in the range:

400, 500, 800, 1000, 1250, 2000, 2500 in Direct, Indirect and Solar

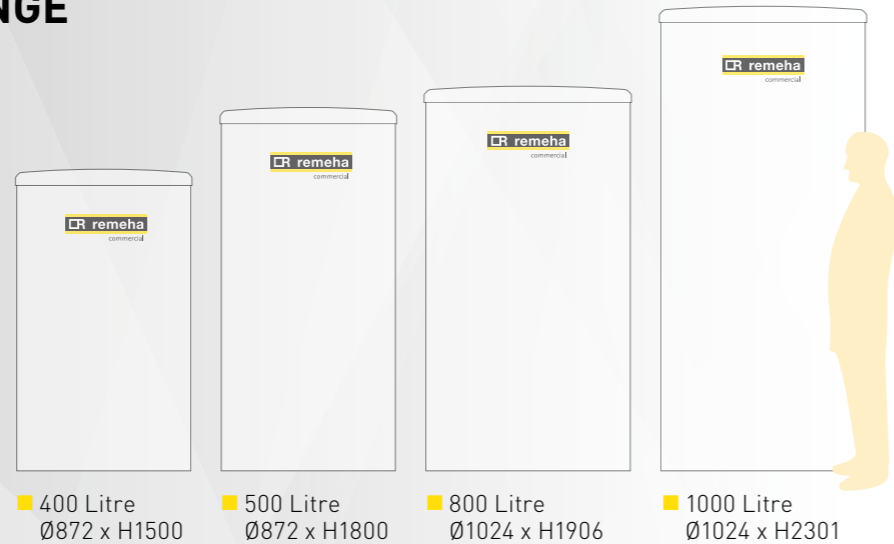

REMEHA HOT WATER CYLINDERS INDIRECT

REMEHA COMMERCIAL INDIRECT

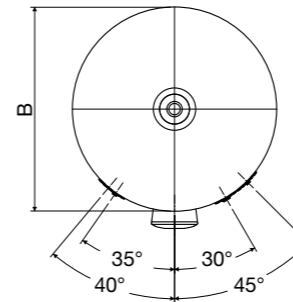
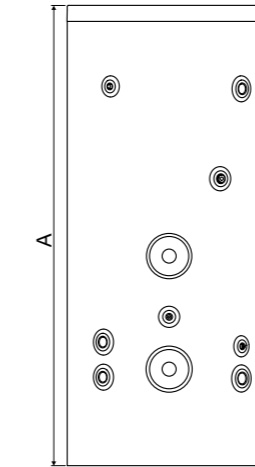

Remeha Commercial cylinders offer a range of indirect cylinders.

Each unit is equipped with a high performance coil which is designed to heat the cylinder from cold, in less than 60* minutes. No more do you have to turn the hot water system on the day before you use it.

Optional immersion heater units are available to provide boost and backup.

All units are delivered with a full unvented hot water kit which comprises:

Expansion vessel and support (WRAS approved, CE marked in accordance with Directive PED/97/23/CE to BS6144/1980).
Pressure reducing valve to BS EN 1567 (WRAS approved, DVGW certified).
Single check valve to BS 6282 Part 1 1981
Expansion relief valve to BS 6283 Part 1 1991
Isolating ball valve to BS 5174
Isolating drain valve
Tundish
Temperature and pressure relief valve
Commercial isolation zone valve

INDIRECT

Nominal capacity (litre)	400	500	800	1000	1250	1450	2000	2500
A (mm)	1500	1800	1906	2301	1937	2253	2011	2416
B (mm)	872	872	1024	1024	1224	1224	1476	1476
Material	Duplex 2205	Duplex 2205	Duplex 2205	Duplex 2205	Duplex 2205	Duplex 2205	Duplex 2205	Duplex 2205
Operating pressure (6 bar)	Yes	Yes	Yes	Yes	Yes	Yes	Yes	Yes
Insulation	100mmPU	100mmPU	100mmPU	100mmPU	100mmPU	100mmPU	100mmPU	100mmPU
Outlet	1"	1"	2"	2"	2"	2"	2"	2"
Inlet	1"	1"	1½"	1½"	1½"	1½"	2"	2"
Coil	1"	1"	1¼"	1¼"	1½"	1½"	1½"	1½"
Tappings	½"	½"	½"	½"	½"	½"	½"	½"
Secondary return	1"	1"	1"	1"	1"	1"	1"	1"
Inspection port (mm)	115	115	115	115	115	115	115	115
Coil - area/rating @ 30 l/min	2m²/43.6kW	2m²/41.8kW	3m²/52.7kW	3m²/51.4kW	5m²/63.6kW	5m²/61.2kW	7.5m²/98.4kW	7.5m²/86.4kW
Element (kW) (Max)	24	24	45	45	54	54	54	54
Empty weight (kg)	105	110	164	188	319	322	445	450
Full weight (kg)	505	610	964	1188	1569	1872	2445	2950

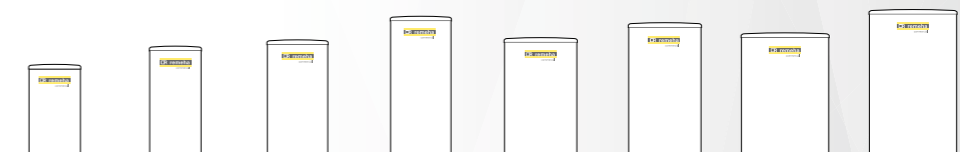

* Depending on incoming cold water temperature and primary flow conditions.

REMEHA HOT WATER CYLINDERS DIRECT

REMEHA COMMERCIAL DIRECT

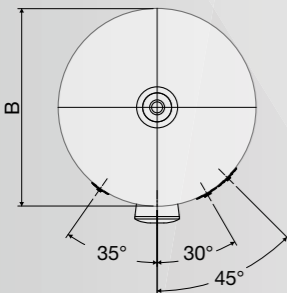
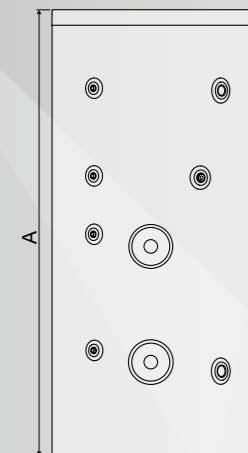

Remeha Commercial cylinders offer a range of direct cylinders which when combined with our range of electrical elements can give the specifier multiple options of generating hot water.

Depending on the choice of elements the cylinder is capable of heating from cold in less than 60 minutes.

All units are delivered with a full unvented hot water kit which comprises:

Expansion vessel and support (WRAS approved, CE marked in accordance with Directive PED/97/23/CE to BS6144/1980).
Pressure reducing valve to BS EN 1567 (WRAS approved, DVGW certified).
Single check valve to BS 6282 Part 1 1981
Expansion relief valve to BS 6283 Part 1 1991
Isolating ball valve to BS5174
Isolating drain valve
Tundish
Temperature and pressure relief valve

DIRECT

Nominal capacity (litre)	400	500	800	1000	1250	1450	2000	2500
A (mm)	1500	1800	1906	2301	1937	2253	2011	2416
B (mm)	872	872	1024	1024	1224	1224	1476	1476
Material	Duplex 2205	Duplex 2205	Duplex 2205	Duplex 2205	Duplex 2205	Duplex 2205	Duplex 2205	Duplex 2205
Operating pressure (6 bar)	Yes	Yes	Yes	Yes	Yes	Yes	Yes	Yes
Insulation	100mmPU	100mmPU	100mmPU	100mmPU	100mmPU	100mmPU	100mmPU	100mmPU
Outlet	1"	1"	2"	2"	2"	2"	2"	2"
Inlet	1"	1"	1½"	1½"	1½"	1½"	2"	2"
Secondary return	1"	1"	1"	1"	1"	1"	1"	1"
Inspection port (mm)	115	115	115	115	115	115	115	115
Element (kW) (Max)	24	24	63	81	84	90	90	90
Empty weight (kg)	95	100	153	178	297	304	415	421
Full weight (kg)	495	600	953	1178	1547	1754	2415	2921

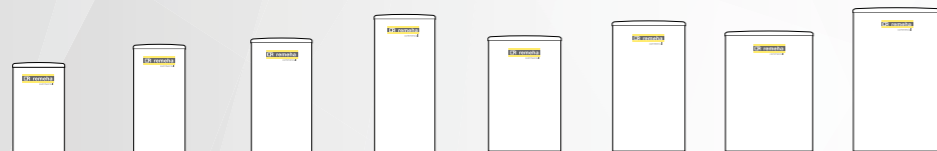

Range of optional elements

Single Phase Elements

- 6kW immersion heater
- 9kW immersion heater

Bespoke Three Phase Elements

- 12kW immersion heater
- 18kW immersion heater
- 24kW immersion heater
- 30kW immersion heater
- 36kW immersion heater
- 45kW immersion heater
- 54kW immersion heater

NOTE: Please refer to the fitting instructions when considering high output immersion heaters. Each cylinder has a maximum input which must not be exceeded for safety reasons.

REMEHA HOT WATER CYLINDERS SOLAR

REMEHA COMMERCIAL SOLAR

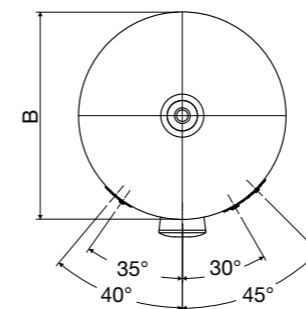
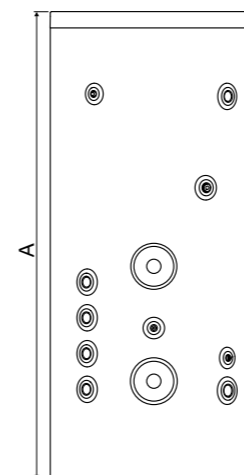

Progressively we are being educated to consider the environment when making choices which have an environmental impact. Renewable energy sources should be considered not only for their reduction in one's carbon footprint but also as they make fiscal good sense.

Remeha Commercial solar cylinders can be used to store the energy gained from the sun and deliver it to your hot water system.

Built in to the units are highly efficient coil heat exchangers which maximise the efficiency of your solar collectors.

Alternatively you can use a standard indirect unit to provide a solar preheat system.

All units are delivered with a full unvented hot water kit which comprises:

Expansion vessel and support (WRAS approved, CE marked in accordance with Directive PED/97/23/CE to BS6144/1980).
Pressure reducing valve to BS EN 1567 (WRAS approved, DVGW certified).
Single check valve to BS 6282 Part 1 1981
Expansion relief valve to BS 6283 Part 1 1991
Isolating ball valve to BS5174
Isolating drain valve
Tundish
Temperature and pressure relief valve
Commercial isolation zone valve

SOLAR

Nominal capacity (litre)	400	500	800	1000	1250	1450	2000	2500
A (mm)	1500	1800	1906	2301	1937	2253	2011	2416
B (mm)	872	872	1024	1024	1224	1224	1476	1476
Material	Duplex 2205	Duplex 2205	Duplex 2205	Duplex 2205	Duplex 2205	Duplex 2205	Duplex 2205	Duplex 2205
Operating pressure (6 bar)	Yes	Yes	Yes	Yes	Yes	Yes	Yes	Yes
Insulation	100mmPU	100mmPU	100mmPU	100mmPU	100mmPU	100mmPU	100mmPU	100mmPU
Outlet	1"	1"	2"	2"	2"	2"	2"	2"
Inlet	1"	1"	1½"	1½"	1½"	1½"	2"	2"
Coil	1"	1"	1¼"	1¼"	1½"	1½"	1½"	1½"
Solar Coil	1"	1"	1¼"	1¼"	1½"	1½"	1½"	1½"
Secondary return	1"	1"	1"	1"	1"	1"	1"	1"
Inspection port (mm)	115	115	115	115	115	115	115	115
Element (kW) (Max)	24	24	45	45	54	54	54	54
Empty weight (kg)	105	110	164	188	319	322	445	450
Full weight (kg)	505	610	964	1188	1569	1872	2445	2950



REMEHA HOT WATER CYLINDERS TECHNICAL DATA

INDIRECT

		400 Indirect	500 Indirect	800 Indirect	1000 Indirect	1250 Indirect	1450 Indirect	2000 Indirect	2500 Indirect
Max direct kW rating		24	24	45	45	54	54	54	54
Direct heat time (based on max kW rating in mins)		52	66	56	70	73	84	117	146
Coil surface area m ²		2		3		5		7.5	
Coil rating (kW)	15 l/min	29.4	28.7	31.3	32.9	35.0	30.1	40.2	37.5
	30 l/min	43.6	41.8	52.7	51.4	63.6	61.2	98.4	86.4
	60 l/min	59.7	55.8	76.9	76.5	97.9	91.7	132.2	126.4
Indirect heat time (mins)	15 l/min	43	55	80	91	112	130	180	225
	30 l/min	29	38	48	59	62	72	99	124
	60 l/min	21	28	32	39	40	50	48	62
Pressure drop through primary coil (Mpa)	15 l/min	0.002		0.001					
	30 l/min	0.004		0.008		0.006		0.007	
	60 l/min	0.032		0.044		0.025		0.03	
Heat loss (kWh in 24h)		1.72	2.14	2.74	3.33	3.60	4.17	4.30	4.50
Hot water capacity (volume of water drawn off >40°C)		384	482	776	961	1206	1399	1930	2482
Weight full (kg)		505	610	964	1188	1569	1872	2445	2950
Weight empty (kg)		105	110	164	188	319	322	445	450
Max supply pressure 1.6 MPa (16 bar)		1.6 MPa (16 bar)							
Max design pressure 0.8 MPa (8 bar)		0.8 MPa (8 bar)							
Max operating pressure 0.6 MPa (6 bar)		0.6 MPa (6 bar)							
Max expansion vessel charge pressure 1.0 MPa (10 bar)		1.0 MPa (10 bar)							
Expansion relief valve setting 0.8 MPa (8 bar)		0.8 MPa (8 bar)							
T&P valve setting 1 MPa (10 bar), 90-95°C		1 MPa (10 bar), 90-95°C							
Maximum primary pressure (indirect only)		0.3 MPa (3 bar)							

NOTES:

1. Indirect cylinders tested in conformance with BS EN 12897:2006.
2. Heat up time from cold through 45°C, based on a flow temperature of 80°C +/- 2°C and normal volume.

REMEHA HOT WATER CYLINDERS TECHNICAL DATA

DIRECT

	400 Direct	500 Direct	800 Direct	1000 Direct	1250 Direct	1450 Direct	2000 Direct	2500 Direct
Max direct kW rating	24	24	63	81	84	90	90	90
Direct heat time (based on max kW rating in mins)	52	66	40	39	47	51	70	87
Heat loss (kWh in 24h)	1.72	2.14	2.74	3.33	3.60	4.17	4.30	4.50
Hot water capacity (volume of water drawn off >40°C)	384	482	776	961	1206	1399	1930	2482
Weight full (kg)	495	600	953	1178	1547	1754	2415	2921
Weight empty (kg)	95	100	153	178	297	304	415	421
Max supply pressure	1.6 MPa (16 bar)							
Max design pressure	0.8 MPa (8 bar)							
Max operating pressure	0.6 MPa (6 bar)							
Max expansion vessel charge pressure	1.0 MPa (10 bar)							
Expansion relief valve setting	0.8 MPa (8 bar)							
T&P valve setting	1 MPa (10 bar), 90-95°C							

REMEHA HOT WATER CYLINDERS TECHNICAL DATA

SOLAR

		400 Solar	500 Solar	800 Solar	1000 Solar	1250 Solar	1450 Solar	2000 Solar	2500 Solar
Max direct kW rating		24	24	45	45	54	54	54	54
Direct heat time (based on max kW rating in mins)		52	66	56	70	73	84	117	146
Coil surface area m ²		2		3		5		7.5	
Auxiliary coil surface area m ²		1		1.5		2.5		5	
Solar coil rating (kW)	15 l/min	29.4	28.7	31.3	32.9	35.0	30.1	40.2	37.5
	30 l/min	43.6	41.8	52.7	51.4	63.6	61.2	98.4	86.4
	60 l/min	59.7	55.8	76.9	76.5	97.9	91.7	132.2	126.4
	Auxiliary coil rating (kW)	28.4	27.2	30.5	33.2	48.6	46.4	97.9	91.7
Solar coil heat time (mins)	15 l/min	43	55	80	91	112	130	180	225
	30 l/min	29	38	48	59	62	72	99	124
	60 l/min	21	28	32	39	40	50	48	62
Pressure drop through primary coil (Mpa)	15 l/min	0.002		0.001					
	30 l/min	0.004		0.008		0.006		0.007	
	60 l/min	0.032		0.044		0.025		0.03	
Heat loss (kWh in 24h)		1.72	2.14	2.74	3.33	3.60	4.17	4.30	4.50
Hot water capacity (volume of water drawn off >40°C)		384	482	776	961	1206	1399	1930	2482
Weight full (kg)		505	610	964	1188	1569	1872	2445	2950
Weight empty (kg)		105	110	164	188	319	322	445	450
Max supply pressure		1.6 MPa (16 bar)							
Max design pressure		0.8 MPa (8 bar)							
Max operating pressure		0.6 MPa (6 bar)							
Max expansion vessel charge pressure		1.0 MPa (10 bar)							
Expansion relief valve setting		0.8 MPa (8 bar)							
T&P valve setting		1 MPa (10 bar), 90-95°C							
Maximum primary pressure		0.3 MPa (3 bar)							

NOTES:
 1. Cylinders tested in conformance with BS EN 12897:2006.
 2. Heat up time from cold through 45°C, based on a flow temperature of 80°C +/- 2°C and normal volume.

REMEHA HOT WATER CYLINDERS TECHNICAL DATA

ELEMENT ALLOCATION TABLE

Element	DY0616		DY0916		DY1216		DY1816		DY2416		DY3027		DY3627		DY4527		DY5436		
kw	6		9		12		18		24		30		36		45		54		
Location	Upper	Lower	Upper	Lower	Upper	Lower	Upper	Lower	Upper	Lower	Upper	Lower	Upper	Lower	Upper	Lower	Upper	Lower	
Direct	400	✓	✓	✓	✓		✓		✓		✓								
	500	✓	✓	✓	✓		✓		✓		✓								
	800	✓	✓	✓	✓	✓	✓	✓	✓	✓		✓				✓			
	1000	✓	✓	✓	✓	✓	✓	✓	✓	✓	✓	✓	✓			✓		✓	
	1250	✓	✓	✓	✓	✓	✓	✓	✓	✓	✓	✓	✓	✓		✓		✓	
	1450	✓	✓	✓	✓	✓	✓	✓	✓	✓	✓	✓	✓	✓	✓	✓		✓	✓
	2000	✓	✓	✓	✓	✓	✓	✓	✓	✓	✓	✓	✓	✓	✓	✓	✓	✓	✓
Indirect	400	✓		✓		✓		✓		✓									
	500	✓		✓		✓		✓		✓									
	800	✓		✓		✓		✓		✓		✓		✓		✓			
	1000	✓		✓		✓		✓		✓		✓		✓		✓			
	1250	✓		✓		✓		✓		✓		✓		✓		✓			
	1450	✓		✓		✓		✓		✓		✓		✓		✓			
	2000	✓		✓		✓		✓		✓		✓		✓		✓		✓	

Element	DY0616		DY0916		DY1216		DY1816		DY2416		DY3027		DY3627		DY4527		DY5436	
kw	6		9		12		18		24		30		36		45		54	
Location	Upper	Lower	Upper	Lower	Upper	Lower	Upper	Lower	Upper	Lower	Upper	Lower	Upper	Lower	Upper	Lower	Upper	Lower
Solar	400	✓		✓		✓		✓		✓								
	500	✓		✓		✓		✓		✓								
	800	✓		✓		✓		✓		✓		✓		✓		✓		
	1000	✓		✓		✓		✓		✓		✓		✓		✓		
	1250	✓		✓		✓		✓		✓		✓		✓		✓		✓
	1450	✓		✓		✓		✓		✓		✓		✓		✓		✓
	2000	✓		✓		✓		✓		✓		✓		✓		✓		✓

IMPORTANT NOTE:
 400 and 500 ltr calorifiers are only allowed a maximum of 24kW when fitting elements.

REMEHA HOT WATER CYLINDERS ORDERING GUIDE

ORDERING GUIDE

Please note cylinders and unvented kit cannot be supplied separately

	Unit	Kit
Direct		
Remeha Commercial 400 litre	94-050:399	90:002:867
Remeha Commercial 500 litre	94-050:400	90:002:867
Remeha Commercial 800 litre	94-050:401	90:002:493
Remeha Commercial 1000 litre	94-050:402	90:002:494
Remeha Commercial 1250 litre	94-050:403	90:002:495
Remeha Commercial 1450 litre	94-050:404	90:002:805
Remeha Commercial 2000 litre	94-050:405	90:002:496
Remeha Commercial 2500 litre	94-050:406	90:002:496
Indirect		
Remeha Commercial 400 litre	94-050:407	90:002:885
Remeha Commercial 500 litre	94-050:408	90:002:885
Remeha Commercial 800 litre	94-050:409	90:002:540
Remeha Commercial 1000 litre	94-050:410	90:002:541
Remeha Commercial 1250 litre	94-050:411	90:002:542
Remeha Commercial 1450 litre	94-050:412	90:002:800
Remeha Commercial 2000 litre	94-050:413	90:002:543
Remeha Commercial 2500 litre	94-050:414	90:002:543
Solar Indirect		
Remeha Commercial 400 litre	94-050:415	90:002:924
Remeha Commercial 500 litre	94-050:416	90:002:924
Remeha Commercial 800 litre	94-050:417	90:002:913
Remeha Commercial 1000 litre	94-050:418	90:002:914
Remeha Commercial 1250 litre	94-050:419	90:002:915
Remeha Commercial 1450 litre	94-050:420	90:002:916
Remeha Commercial 2000 litre	94-050:421	90:002:917
Remeha Commercial 2500 litre	94-050:422	90:002:917

Remeha Commercial Accessories	
De-stratification loop kit – 400-500 litre	95:970:140
De-stratification loop kit – 800-1450 litre	95:970:157
De-stratification loop kit – 2000-2500 litre	95:970:158
Temperature gauge	95:970:141
Pressure gauge	95:970:142
Single Phase Elements	
6kW immersion heater	DY0616
9kW immersion heater	DY0916
Bus bar conversion kits (single >3ph)	HR94970110

Bespoke Three Phase Elements	
12kW immersion heater	DY1216
18kW immersion heater	DY1816
24kW immersion heater	DY2416
30kW immersion heater	DY3027
36kW immersion heater	DY3627
45kW immersion heater	DY4527
54kW immersion heater	DY5436

NOTE: Please refer to the fitting instructions when considering high output immersion heaters. Each cylinder has a maximum input which must not be exceeded for safety reasons.

REMEHA HOT WATER CYLINDERS



- 1** Sensor pockets
- 2** Temperature and pressure relief valve boss
- 3** Secondary return
- 4** Immersion heater/ inspection hatches
- 5** Cold inlet
- 6** Hot water outlet

Illustration does not represent all models or connection positions.



Remeha Commercial
Innovation House
3 Oaklands Business Centre
Oaklands Park
Wokingham
RG41 2FD
T: 0118 978 3434

boilers@remeha.co.uk
www.remeha.co.uk



The data published in this brochure is based on the latest information (at date of publication) and may be subject to revisions. We reserve the right to continuous development in both design and manufacture, therefore any changes to the technology or equipment employed may not be retrospective, nor may we be obliged to adjust earlier supplies accordingly.

Version 2, March 2015
©Remeha 2015