

CAPTUR

DRIVER'S HANDBOOK



RENAULT recommends ELF

ELF has developed a complete range of lubricants for RENAULT:

- ▶ engine oils
- ▶ manual and automatic gearbox oils

Warning: to ensure the engine operates optimally, the use of a lubricant may be restricted to certain vehicles. Please refer to your maintenance document.

Benefiting from the research applied to Formula 1, lubricants are very high-tech products.

Updated with the help of RENAULT's technical teams, this range is perfectly compatible with the specific features of the brand's vehicles.

▶ ELF lubricants enhance your vehicle's performance significantly.



RENAULT recommends approved ELF lubricants for oil changes and top-ups.
Contact your RENAULT Dealer or visit www.lubrifiants.elf.com



Une marque de TOTAL

Welcome to your new vehicle

This Driver's Handbook contains the information necessary:

- for you to familiarise yourself with your vehicle, to use it to its best advantage and to benefit fully from all the functions and the technical developments it incorporates.
- to ensure that it always gives the best performance by following the simple, but comprehensive advice concerning regular maintenance.
- to enable you to deal quickly with minor faults not requiring specialist attention.

It is well worth taking a few minutes to read this handbook to familiarise yourself with the information and guidelines it contains about the vehicle and its functions and new features. If certain points are still unclear, our Network technicians will be only too pleased to provide you with any additional information.

The following symbol will help you when reading this handbook:



To indicate a hazard, danger or safety recommendation.

The descriptions of the models given in this handbook are based on the technical specifications at the time of writing. **This handbook covers all items of equipment** (both standard and optional) **available for these models but whether or not these are fitted to the vehicle depends on the version, options selected and the country where the vehicle is sold.**

This handbook may also contain information about items of equipment to be introduced later in the model year.

Throughout the manual, the “approved Dealer” is your RENAULT Dealer.

Enjoy driving your new vehicle.

Translated from French. Copying or translation, in part or in full, is forbidden unless prior written permission has been obtained from the vehicle manufacturer.



C O N T E N T S

Sections

Getting to know your vehicle

1

Driving

2

Your comfort

3

Maintenance

4

Practical advice

5

Technical specifications

6

Alphabetical index

7



Section 1: Getting to know your vehicle

RENAULT card: general information, use, deadlocking	1.2
Opening and closing the doors	1.9
Locking, unlocking the opening elements	1.11
Automatic locking when driving	1.13
Headrests - Seats	1.14
Seat belts.	1.16
Additional methods of restraint	1.19
to the front seat belts	1.19
to the rear seat belts	1.23
side.	1.24
Child safety: general information.	1.26
Choosing a child seat mounting.	1.29
Fitting a child seat	1.31
Deactivating, activating the front passenger airbag	1.35
Driving position	1.38
Instrument panel	1.42
On-board computer	1.47
Steering wheel/Power-assisted steering	1.57
Clock and exterior temperature	1.58
Door mirrors.	1.60
Exterior lighting and signals.	1.61
Audible and visual signals	1.64
Headlight adjustment.	1.65
Windscreen washers and wipers.	1.67
Fuel tank (filling with fuel)	1.70

RENAULT CARD: general information (1/2)

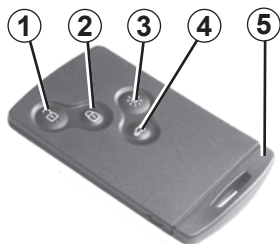

26787

- 1 Unlocking the doors and tailgate.
- 2 Locking all doors and tailgate.
- 3 Switch on the courtesy lighting remotely.
- 4 Unlocking/locking the tailgate
- 5 Integrated key.

The RENAULT card is used for:

- locking/unlocking the doors and tailgate (doors, tailgate) and the fuel filler flap (see the following pages);
- switch on the vehicle lighting remotely (refer to the following pages);
- starting the engine; refer to the information on “Starting the engine” in Section 2.

Battery life

Make sure that the correct battery type is being used, and that the battery is in good condition and inserted correctly. Its service life is approximately two years: replace it when the message “KEYCARD BATTERY LOW” appears on the instrument panel (refer to the information on the “RENAULT card: battery” in section 5).

RENAULT card operating range

This varies according to the surroundings: when handling the RENAULT card, it is important to make sure that you do not lock or unlock the doors by inadvertently pressing the buttons.

When the battery is flat, you can still lock/unlock and start your vehicle. Refer to the information on “Locking/unlocking the doors” in Section 1 and “Starting the engine” in Section 2.



Driver's responsibility

Never leave your vehicle with the RENAULT card inside and never leave a child (or a pet) unsupervised, even for a short while.

They may pose a risk to themselves or to others by starting the engine, activating equipment such as the electric windows or by locking the doors.

Risk of serious injury.

RENAULT CARD: general information (2/2)

26788

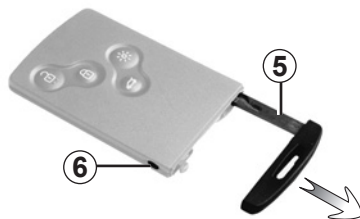

Integrated key 5

The integrated key is used to lock or unlock the front left-hand door if the RENAULT card does not work:

- when the RENAULT card battery is drained, flat battery, etc.
- use of devices using the same frequency as the card;
- vehicle located in a high electromagnetic radiation zone.

Access to key 5

Press button **6** and pull on key **5** then release the button.

Using the key

Please refer to the information on “Locking and unlocking the opening elements”.

Once you have accessed the vehicle using the integrated key, replace it in its housing in the RENAULT card, then insert the RENAULT card into the card reader to start the vehicle.

Advice

Avoid leaving the card in hot, cold or humid areas.

Do not keep the RENAULT card in a place where it could be bent or damaged accidentally, such as in a back pocket of a garment.

Replacement: need for an additional RENAULT Card

If you lose your RENAULT card or require another, you can obtain one from an authorised dealer.

If a RENAULT card is replaced, it will be necessary to take the vehicle and **all of its RENAULT** cards to an approved Dealer to initialise the system.

You may use up to four RENAULT cards per vehicle.

REMOTE CONTROL RENAULT CARD: use

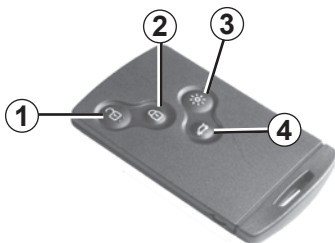

26787

Unlocking the doors and tailgate

Press button **1**.

The hazard warning lights **flash once** to indicate that the doors have been unlocked.

When unlocking is only active for the driver's door, (refer to the information on the "vehicle settings customisation menu" in Section 1):

- pressing button **1** unlocks only the driver's door and the fuel filler flap;
- pressing button **1** twice unlocks all the doors and the tailgate.

Locking the doors and luggage compartment

Press the locking button **2**. The hazard warning lights **flash twice** to indicate that the doors have locked. If a door or the luggage compartment is open or not properly shut, or if a RENAULT card is still in the reader, the doors and luggage compartment lock then quickly unlock and the hazard warning lights **do not flash**.

If the vehicle has been unlocked but neither the doors or tailgate are open, it locks again automatically after two minutes.

The card buttons are deactivated when the engine is running.

The flashing status of the hazard warning lights informs you of the vehicle status:

- **one flash** indicates that the vehicle is completely unlocked;
- **two flashes** indicate that the vehicle is completely locked.

Unlocking/locking the luggage compartment only

Press button **4** to unlock/lock the luggage compartment.

RENAULT card not detected alarm

If you open a door while the engine is running and the card is not in the reader, the message "Keycard not detected" and a beep will warn you. The warning disappears when the card is inserted in the reader again.

Distance lighting function

The interior lights come on for approximately 30 seconds when button **3** is pressed. This can be used, for example, to identify the vehicle from a distance when parked in a car park.

Note: pressing button **3** again switches off the lighting.

“HANDS-FREE” RENAULT CARD: use (1/3)



Use

On equipped vehicles, in addition to the functions of the remote control RENAULT card, it can be used to lock/unlock without using the RENAULT card, when it is in access zone **1**.

Do not store the RENAULT card anywhere it may come into contact with other electronic equipment (computer, PDA, phone, etc.) as this could hinder its operation.



Unlocking the vehicle

With the RENAULT card in zone **1** and the vehicle locked, press button **3** on handle **2** on one of the two front doors: the vehicle will unlock.

Pressing button **4** also unlocks all the doors and the tailgate.

The hazard warning lights **flash once** to indicate that the doors have been unlocked.

NB: the vehicle cannot be locked again for three seconds after unlocking after pressing button **3**.



After unlocking the vehicle using the RENAULT card, the “hands-free” locking and unlocking is deactivated.

To reactivate the hands-free mode: restart the vehicle.

“HANDS-FREE” RENAULT CARD: use (2/3)

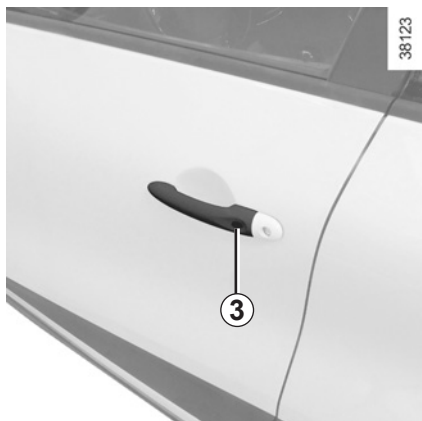

Locking the vehicle

There are three ways to lock the vehicle: remotely, using button **3**, or using the RENAULT card.

Remote locking

With the RENAULT card on you, and doors and tailgate closed, move away from the vehicle: it will lock automatically once you have left zone **1**.

Note: the distance at which the vehicle locks depends on the surroundings.



The hazard warning lights **flash twice** and a beep sounds to indicate that the doors have locked.

The beep may be switched off. Please contact an authorised dealer.

If an opening element (door or boot) is open or not properly closed, or a card is in the passenger compartment (or the card reader), the vehicle will not lock. In this situation, no beep sounds and the hazard warning lights do not flash.

Locking using button **3**

With the doors and boot closed, press button **3** on one of the front door handles. The vehicle will lock. If a door or the boot is open or not closed properly, the vehicle will quickly lock/unlock.

Note: a RENAULT card must be within the vehicle's access zone (zone **1**) to be able to lock the vehicle using the button.

NB: the vehicle cannot be locked again for three seconds after unlocking after pressing button **3**.

“HANDS-FREE” RENAULT CARD: use (3/3)



26787



38166

Locking using the RENAULT card

With the doors and luggage compartment closed, press button **5**: the vehicle will lock.

The hazard warning lights **flash twice** to indicate that the doors have locked.

Note: the maximum distance at which the vehicle locks depends on the surroundings.

Special features

The vehicle will not lock if:

- a door or the tailgate is open or not properly closed;
- a card is still in zone **6** (or in the card reader) and no other card is in the external detection zone.

After locking/unlocking the vehicle using the buttons on the RENAULT card, "hands-free" locking and unlocking is deactivated.

To reactivate the "hands-free" mode: restart the vehicle.

With the engine running, if having once opened and closed a door, the card is no longer in the passenger compartment, the message "Keycard not detected" (accompanied by a warning beep once the speed passes a threshold value) will tell you that the card is no longer in the vehicle. This avoids you driving away after having dropped off a passenger who has the card, for example.

The warning disappears when the card is detected again.



Driver's responsibility

Never leave your vehicle with the RENAULT card inside and never leave a child (or a pet) unsupervised, even for a short while.

They may pose a risk to themselves or to others by starting the engine, activating equipment such as the electric windows or by locking the doors.

Risk of serious injury.

RENAULT CARD: deadlocking

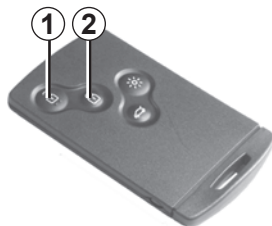

26787

If the vehicle is equipped with a deadlocking function, this allows you to lock the opening elements and to prevent the doors from being unlocked using the interior handles (for example, by breaking the window and then trying to open the door from the inside).



Never use deadlocking if someone is still inside the vehicle.



38123

To activate deadlocking

Deadlocking can be activated in one of two ways:

- press button **2** twice in quick succession;
- or, with the vehicle unlocked, press button **4** on handle **3** on the driver or passenger side door twice in quick succession.

The hazard warning lights flash **five** times to indicate locking.

To deactivate deadlocking

Unlock the vehicle using button **1** on the RENAULT card.

The hazard warning lights flash once to indicate that the doors have been unlocked.

Operating fault

If the RENAULT card does not work (worn batteries in the RENAULT card, batteries run down, etc.), use the key integrated in the card to unlock the front-left door (refer to the information in “Locking, unlocking the opening elements” in Section 1).

After activating the deadlocking function using button **2**, “hands-free” locking and unlocking are deactivated.

To reactivate the “hands-free” mode: restart the vehicle.

OPENING AND CLOSING THE DOORS (1/2)

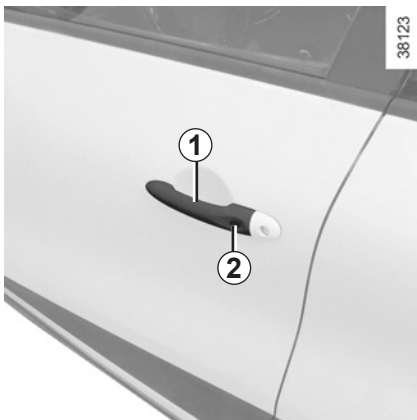

Opening the doors from the outside

With the doors unlocked, pull handle **1**.

Special feature of the RENAULT “hands-free” card

With the doors locked, press button **2** on handle **1** of one of the two front doors and pull towards you.



Opening from the inside

Pull handle **4**.

Lights-on reminder buzzer

If you have switched off the ignition and left the lights switched on, a reminder buzzer will sound when a door is opened.



As a safety precaution, the doors should only be opened or closed when the vehicle is stationary.

Card reminder buzzer

On opening the driver's door, if the card is still in the reader, the message “PLEASE REMOVE KEYCARD” is displayed on the instrument panel accompanied by a warning beep.

Door/tailgate open buzzer

If an opening (door or boot) is left open or closed badly, once the vehicle reaches around 12 mph (20 km/h), either the message “BOOT OPEN” or “DOOR OPEN” (depending on which opening) is displayed on the instrument panel together with a beep.

Special note

After switching off the engine, the lights and any accessories that are in operation (radio, etc.) will continue to operate.

They will cease on opening the driver's door or on locking the vehicle after opening another door.

OPENING AND CLOSING THE DOORS (2/2)

38144



Child safety

To make it impossible for the rear doors to be opened from the inside, move lever **5** on each door and check from the inside that the doors are securely locked.



Driver's responsibility when parking or stopping the vehicle

Never leave an animal, child or adult who is not self-sufficient alone on your vehicle, even for a short time.

They may pose a risk to themselves or to others by starting the engine, activating equipment such as the electric windows or locking the doors.

Also, in hot and/or sunny weather, please remember that the temperature inside the passenger compartment increases very quickly.

RISK OF DEATH OR SERIOUS INJURY.

LOCKING/UNLOCKING THE DOORS (1/2)

Locking/Unlocking the doors from the outside

This is done using the RENAULT Card; see the “RENAULT Card” information in Section 1.

In certain cases, the RENAULT card may not work:

- if the RENAULT card battery is weak, flat, etc.
- if equipment operating on the same frequency as the card (mobile phones, etc.) is used;
- vehicle located in a high electromagnetic radiation zone.

It is then possible:

- to use the key integrated into the card to unlock the front left-hand door;
- to lock each of the doors manually;
- to use the interior door locking/unlocking control (refer to the following pages).



Using the key integrated in the RENAULT card

Insert key **1** into the lock in the driver's door and lock or unlock.



Locking the doors manually

Turn screw **2** with the door open (using the end of the key) and close the door.

This means that the doors are then locked from the outside.

The doors may then only be opened from the inside or by using the key in the front left-hand door.

LOCKING/UNLOCKING THE DOORS (2/2)



Interior locking/unlocking door control

Switch **3** controls the doors, boot and, depending on the vehicle, the fuel filler flap simultaneously.

If a door or the tailgate is open or not closed properly, the doors and tailgate lock/unlock quickly.

If you need to transport objects with the boot open, the other opening elements can still be locked: **with the engine stopped**, press switch **3** for more than five seconds to lock the other opening elements.

Locking the doors without the RENAULT card

For example, in the event of a discharged battery or the RENAULT card temporarily not working, etc.

With the engine switched off and an opening element (door or boot) open, press and hold switch **3** for more than five seconds.

When the door is closed, all the doors and the tailgate will be locked.

Unlocking the vehicle from the outside is only possible with the RENAULT card in the vehicle's access zone or using the key integrated in the RENAULT card.

After locking/unlocking the vehicle or the luggage compartment only using the buttons on the RENAULT card, remote locking and unlocking in hands-free mode are deactivated.

To reactivate the "hands-free" mode: restart the vehicle.

Door and tailgate status indicator

With the ignition on, the warning light integrated in switch **3** informs you of the locking status of the opening elements:

- indicator light on, the doors and tailgate are locked,
- indicator light off, the doors and tailgate are unlocked.

When you lock the doors, the indicator light remains lit and then goes out.



Never leave your vehicle with the RENAULT card inside.



Driver's responsibility

If you decide to keep the doors locked when you are driving, remember that it may be more difficult for those assisting you to gain access to the passenger compartment in the event of an emergency.

RENAULT ANTI-INTRUDER DEVICE (RAID)



Operating principle

After the vehicle is started, the system automatically locks the doors when you are driving at approximately 6 mph (10 km/h) and over.

The door can be unlocked:

- by pressing the button **1** to unlock the doors;
- by opening a front door (vehicle stationary).

NB: if a door is opened or closed, it will automatically lock again when the vehicle reaches a speed of 6 mph (10 km/h).

Activating/deactivating the function

With the engine running, press the button **1** for approximately 5 seconds, until you hear a warning beep.

Operating faults

If you experience an operating fault (no automatic locking, the indicator light incorporated in button **1** does not light up when trying to lock the opening elements, etc.), firstly check that the opening elements are properly closed. If they are properly closed, contact an authorised dealer.



Driver's responsibility

If you decide to keep the doors locked when you are driving, remember that it may be more difficult for those assisting you to gain access to the passenger compartment in the event of an emergency.

FRONT HEADRESTS

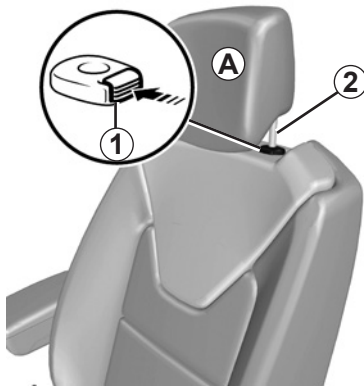

To raise the headrest

Pull the headrest upwards to the desired height. Check that it is correctly locked.

To lower the headrest

Press button **1** and guide the headrest down to the desired height. Check that it is correctly locked.

To raise the headrest

Raise the headrest to its highest position (tilt the seatback backwards if necessary). Press button **1** and lift the headrest to release it.

To refit the headrest

Insert the headrest rods into the holes (tilt the seatback backwards if necessary). Lower the headrest until it locks and press button **1** to adjust to the desired height. Check that each rod **2** on the seatback is securely locked.

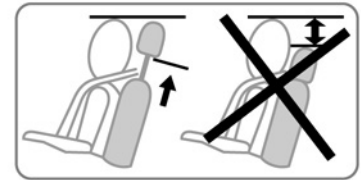

The headrest is important for safety. Ensure that it is in place and in the correct position: the top of the headrest should be as close as possible to the top of the head and there must be a minimal distance between the head and the headrest **A**.

FRONT SEATS

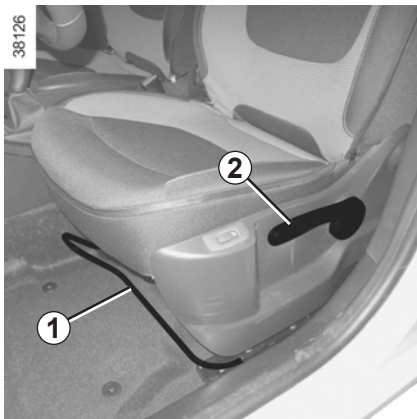

To move the seat forwards or backwards

Lift handle **1** to unlock. Release the handle once the seat is in the correct position and ensure that the seat is locked.

To raise or lower the seat base

Move lever **2** as many times as necessary upwards or downwards.

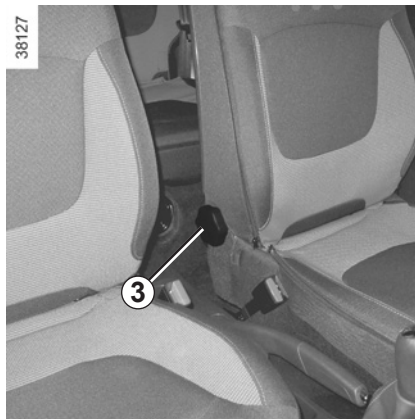

To tilt the seatback

Turn the control knob **3** and tilt the seatback to the desired position.



For safety reasons, carry out any adjustments when the vehicle is not being driven.

Nothing should be placed on the floor (area in front of driver) as such objects may slide under the pedal during braking manoeuvres, thus obstructing its use.

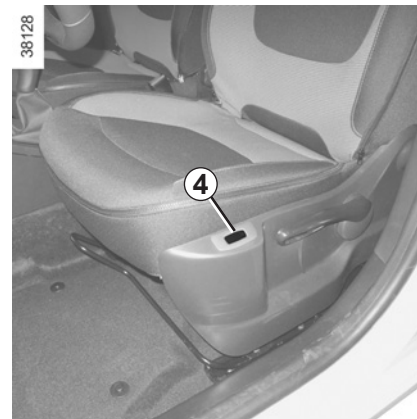

Heated seats

With the ignition on, press the switch **4** for the seat desired. The indicator light in the switch lights up.

The system, which has a thermostat, regulates the heating and deactivates it if necessary.



We would advise you not to recline the seatbacks too far to ensure that the effectiveness of the seat belts is not reduced.

SEAT BELTS (1/3)

Always wear your seat belt when travelling in your vehicle. You must also comply with the legislation of the particular country you are in.

Make sure that the rear bench seat is locked in position correctly so that the rear seat belts will operate efficiently. Refer to the information on the “Rear bench seat: functions” in Section 3.



Incorrectly adjusted or twisted seat belts may cause injuries in the event of an accident.

Use one seat belt per person, whether child or adult.

Even pregnant women should wear a seat belt. In this case, ensure that the lap belt is not exerting too much pressure on the abdomen, but do not allow any slack.

Before starting, first adjust your driving position, then ask all occupants to adjust their seat belts to ensure optimum protection.

Adjusting your driving position

- **Sit well back in your seat** (having first removed your coat or jacket). This is essential to ensure your back is positioned correctly;
- **adjust the distance between the seat and the pedals.** Your seat should be as far back as possible while still allowing you to depress the clutch pedal fully. The seatback should be adjusted so that your arms are slightly bent when you hold the steering wheel;
- **adjust the position of your headrest.** For the maximum safety, your head must be as close as possible to the headrest;
- **adjust the height of the seat.** This adjustment allows you to select the seat position which offers you the best possible view;
- **adjust the position of the steering wheel.**



Adjusting the seat belts

Sit with your back firmly against the seatback.

Shoulder strap **1** should be as close as possible to the base of the neck but not on it.

Lap belt **2** should be worn flat over the thighs and against the pelvis.

The belt should be worn so that it is as close as possible to your body, i.e.: avoid wearing heavy clothing or keeping bulky objects under the belts, etc.

SEAT BELTS (2/3)



Locking

Unwind the belt **slowly and smoothly** and ensure that buckle **3** locks into catch **5** (check that it is locked by pulling on buckle **3**).

If the belt jams, allow it to return slightly before attempting to unwind it again.

If your seat belt is completely jammed, pull slowly, but firmly, so that just over 3 cm unwinds. Allow it to return slightly before attempting to unwind it again.

If there is still a problem, contact an approved dealer.

Front seat belt reminder warning light

This lights up on the central display when the engine is started then, if the driver's or front passenger's seat belt (if this seat is occupied) is not fastened and the vehicle has reached approximately 12 mph (20 km/h), it flashes and a bleep sounds for around 2 minutes.

Note: an object placed on the passenger seat base may activate the warning light in some cases.

Rear seat belt reminder (depending on vehicle)

The  warning light comes on on the central display, accompanied by a message on the instrument panel, indicating the number of seat belts buckled for approximately 30 seconds each:

- the vehicle is started;
- a door is opened;
- a rear seat belt is fastened or unfastened.

Check that the rear passengers are wearing seat belts and that the number of seat belt shown as fastened corresponds to the number of rear bench seat places occupied.



Adjusting the height of the front seat belts

Press button **6** to adjust the seat belt height so that shoulder strap **1** is worn as shown previously. Press button **6** and raise or lower the seat belt. Make sure that the seat belt is locked in position correctly after you have adjusted it.

Unlocking

Press button **4** and the seat belt will be rewound by the inertia reel. Guide the belt.

SEAT BELTS (3/3)



Rear seat belts 7

The belts are locked, unlocked and adjusted in the same way as the front belts.



Check that the rear seat belts are positioned and operating correctly each time the rear bench seat is moved.

The following information applies to the vehicle's front and rear seat belts.



- No modification may be made to the component parts of the originally fitted restraint system: seat belts, seats and their mountings. For special operations (e.g. fitting child seats), contact an authorised dealer.
- Do not use devices which allow any slack in the belts (e.g. clothes pegs, clips, etc.): a seat belt which is worn too loosely may cause injury in the event of an accident.
- Never wear the shoulder strap under your arm or behind your back.
- Never use the same belt for more than one person and never hold a baby or child on your lap with your seat belt around them.
- The belt should never be twisted.
- Following an accident, have the seat belts checked and replaced if necessary. Always replace your seat belts as soon as they show any signs of wear.
- When putting back the rear bench seat, make sure the seat belts are correctly positioned so that they can be used properly.
- Make sure that the buckle is inserted into the appropriate catch.
- Ensure that no objects are placed in the area around the seat belt catch as they could prevent it from being properly secured.
- Make sure the seat belt catch is properly positioned (it should not be hidden away, crushed or flattened by people or objects).

METHODS OF RESTRAINT IN ADDITION TO THE FRONT SEAT BELTS (1/4)

Depending on the vehicle, they will consist of:

- front seat belt inertia reel pretensioners;
- chest-level load limiters;
- air bags for driver and front passenger.

These systems are designed to act independently or together when the vehicle is subjected to a frontal impact.

Depending on the severity of the impact, the system can trigger:

- seat belt locking;
- the seat belt inertia reel pretensioner (which engages to correct seat belt slack);
- airbags.

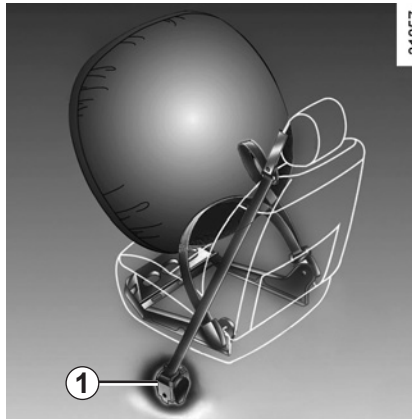

Pretensioners

The pretensioners hold the seat belt against the body, holding the occupant more securely against the seat, thus increasing the seat belt's efficiency.

With the ignition on, following a significant frontal impact and depending on the severity of the impact, the system may trigger the seat belt inertia reel pretensioner **1**, which instantly retracts the seat belt.



– Have the entire restraint system checked following an accident.

– No operation whatsoever is permitted on any part of the system (pretensioners, air bags, computers, wiring) and the system components must not be reused on any other vehicle, even if identical.

– To avoid incorrect triggering of the system which may cause injury, only qualified personnel from an approved Dealer may work on the pretensioner and air bag system.

– The electric trigger system may only be tested by a specially trained technician using special equipment.

– When the vehicle is scrapped, contact an approved Dealer for disposal of the pretensioner and air bag gas generators.

METHODS OF RESTRAINT IN ADDITION TO THE FRONT SEAT BELTS (2/4)

Load limiter

Above a certain severity of impact, this mechanism is used to limit the force of the belt against the body so that it is at an acceptable level.

Airbags for driver and front passenger

Fitted to the driver and passenger side.

The presence of this equipment is indicated by the word “Air bag” on the steering wheel and dashboard (air bag zone **A**) and, depending on the vehicle, a symbol on the lower section of the windscreen.

Each air bag system consists of:

- an air bag and gas generator fitted on the steering wheel for the driver and in the dashboard for the front passenger;
- an electronic unit for system monitoring which controls the gas generator electrical trigger system;
- a single  warning light on the instrument panel.



The air bag system uses pyrotechnic principles. This explains why, when the air bag inflates, it will generate heat, produce smoke (this does not mean that a fire is about to start) and make a noise upon detonation. In a situation where an air bag is required, it will inflate immediately and this may cause some minor, superficial grazing to the skin or other problems.

METHODS OF RESTRAINT IN ADDITION TO THE FRONT SEAT BELTS (3/4)

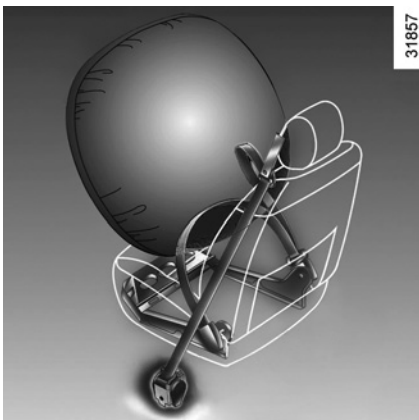

Operation

This system is only operational when the ignition is switched on.

In a severe **frontal** impact, the air bags inflate rapidly, cushioning the impact of the driver's head and chest against the steering wheel and of the front passenger against the dashboard. The air bags then deflate immediately so that the passengers are not in any way hindered from leaving the vehicle.



Operating faults

Warning light 4  will light up on the instrument panel when the ignition is turned on and then go out after a few seconds.

If it does not light up when the ignition is switched on, or comes on when the engine is running, there is a fault in the system.

Contact your approved Dealer as soon as possible. Your protection will be reduced until this fault is rectified.

METHODS OF RESTRAINT IN ADDITION TO THE FRONT SEAT BELTS (4/4)

All of the warnings below are given so that the air bag is not obstructed in any way when it is inflated and also to prevent the risk of serious injuries caused by items which may be dislodged when the air bag inflates.



Warnings concerning the driver's air bag

- Do not modify the steering wheel or the steering wheel boss.
- Do not cover the steering wheel boss under any circumstances.
- Do not attach any objects (badge, logo, clock, telephone holder, etc.) to the steering wheel boss.
- The steering wheel must not be removed (except by qualified personnel from our Network).
- When driving, do not sit too close to the steering wheel. Sit with your arms slightly bent (see the information on “Adjusting your driving position” in Section 1). This will allow sufficient space for the air bag to deploy correctly and be fully effective.

Warnings concerning the passenger air bag

- Do not attach or glue any objects (badge, logo, clock, telephone holder, etc.) to the dashboard on or near the air bag.
- Do not place anything between the dashboard and the passenger (pet, umbrella, walking stick, parcels, etc.).
- The passenger must not put his or her feet on the dashboard or seat as there is a risk that serious injuries may occur. In general, parts of the body should be kept away from the dashboard (knees, hands, head, etc.).
- The devices in addition to the front passenger seat belt should be reactivated as soon as a child seat is removed, to ensure the protection of the passenger in the event of an impact.

A REAR-FACING CHILD SEAT MUST NOT BE FITTED TO THE FRONT PASSENGER SEAT UNLESS THE ADDITIONAL RESTRAINT SYSTEMS, I.E. THE PASSENGER AIR BAG, ARE DEACTIVATED.

(refer to the information on “Child safety: deactivating/activating the front passenger air bag” in Section 1)

METHODS OF RESTRAINT IN ADDITION TO THE REAR SIDE SEAT BELTS

Force limiter

Above a certain severity of impact, this mechanism is used to limit the force of the belt against the body so that it is at an acceptable level.



- Have the entire restraint system checked following an accident.
- No operation whatsoever is permitted on any part of the system (air bags, electronic control units, wiring) and the system components must not be reused on any other vehicle, even if identical.
- Only qualified personnel from our Network may work on the air bags; otherwise the system may trigger accidentally and cause injury.

SIDE PROTECTION DEVICES

Side Airbags

This airbag may be fitted to each of the front seats and is activated at the sides of the seats (door side) to protect the occupants in the event of a severe side impact.

Depending on the vehicle, a marking on the windscreen informs you of the presence of additional means of restraint (air bags, pretensioners, etc.) in the passenger compartment.



Warning relating to the side airbag

- **Fitting seat covers:** seats equipped with an airbag require covers specifically designed for your vehicle. Contact an approved Dealer to find out if these covers are available. The use of any covers other than those designed for your vehicle (and including those designed for another vehicle) may affect the operation of the airbags and reduce your protection.
- Do not place any accessories, objects or even pets between the seatback, the door and the internal fittings. Do not cover the seatback with any items such as clothes or accessories. This may prevent the air bag from operating correctly or cause injury when the airbag is deployed.
- No work or modification whatsoever may be carried out on the seat or internal fittings, except by qualified personnel from an approved Dealer.
- This airbag operates through slits in the front seatbacks (door side): never insert any objects in these slits.

ADDITIONAL METHODS OF RESTRAINT

All of the warnings below are given so that the airbag is not obstructed in any way when it is inflated and also to prevent the risk of serious injuries caused by items which may be dislodged when it inflates.



The airbag is designed to complement the action of the seat belt. Both the air bags and seat belts are integral parts of the same protection system. It is therefore essential to wear seat belts at all times. If seat belts are not worn, the occupants are exposed to the risk of serious injury in the event of an accident. It may also increase the risk of minor superficial injuries occurring when the airbag is deployed, although such minor injuries are always possible with air bags.

If the vehicle should overturn or in the event of a rear impact, however severe, the pretensioners and airbags are not always triggered. Impacts to the underside of the vehicle, e.g. from pavements, potholes or stones, can all trigger these systems.

- No work or modification **whatsoever** may be carried out on any part of the airbag system (airbags, pretensioners, computer, wiring harness, etc.), except by qualified Network personnel.
- To ensure that the system is in good working order and to avoid accidental triggering of the system which may cause injury, only qualified Network personnel may work on the airbag system.
- As a safety precaution, have the airbag system checked if your vehicle has been involved in an accident, or is stolen or broken into.
- When selling or lending the vehicle, inform the user of these points and hand over this handbook with the vehicle.
- When scrapping your vehicle, contact your approved Dealer for disposal of the gas generator(s).

CHILD SAFETY: General information (1/2)

Carrying children

Children, and adults, must be correctly seated and strapped in for all journeys. The children being carried in your vehicle are your responsibility.

A child is not a miniature adult. Children are at risk of specific injuries as their muscles and bones have not yet finished growing. The seat belt alone would not provide suitable protection. Use an approved child seat and ensure you use it correctly.



To prevent the doors being opened, use the “Child safety” device (refer to the information on “Opening and closing the doors” in Section 1).



A collision at 30 mph (50 km/h) is the same as falling a distance of 10 metres.

Transporting a child without a restraint is the equivalent of allowing him or her to play on a fourth-floor balcony without railings.

Never travel with a child held in your arms. In the event of an accident, you will not be able to keep hold of the child, even if you yourself are wearing a seat belt.

If your vehicle has been involved in a road accident, replace the child seat and have the seat belts and ISOFIX anchorage points checked.



Driver's responsibility when parking or stopping the vehicle

Never leave an animal, child or adult who is not self-sufficient alone on your vehicle, even for a short time.

They may pose a risk to themselves or to others by starting the engine, activating equipment such as the electric windows or by locking the doors.

Also, in hot and/or sunny weather, please remember that the temperature inside the passenger compartment increases very quickly.

RISK OF DEATH OR SERIOUS INJURY.

CHILD SAFETY: General information (2/2)

Using a child seat

The level of protection offered by the child seat depends on its ability to restrain your child and on its installation. Incorrect installation compromises the protection it offers the child in the event of harsh braking or an impact.

Before purchasing a child seat, check that it complies with the regulations for the country you are in and that it can be fitted in your vehicle. Consult an approved dealer to find out which seats are recommended for your vehicle.

Before fitting a child seat, read the manual and respect its instructions. If you experience any difficulties during installation, contact the manufacturer of the equipment. Keep the instructions with the seat.

Set a good example by always fastening your seat belt and teaching your child:

- to strap themselves in correctly;
- to always get in and out of the car at the kerb, away from busy traffic.

Do not use a second-hand child seat or one without an instruction manual.

Check that there are no objects in the vicinity of the child seat which could impede its operation.



Never leave a child unattended in the vehicle.

Check that your child is always strapped in and that the belt or safety harness used is correctly set and adjusted. Avoid wearing bulky clothing which could cause the belts to slacken.

Never let your child put their head or arms out of the window.

Check that the child is in the correct position for the entire journey, especially if asleep.

CHILD SAFETY: choosing a child seat



31235

Rear-facing child seats

A baby's head is, proportionally, heavier than that of an adult and its neck is very fragile. Transport the child in this position for as long as possible (until the age of 2 at the very least). It supports both the head and the neck.

Choose a bucket type seat for best side protection and change it as soon as the child's head is higher than the shell.



31233

Forward-facing child seats

The child's head and abdomen need to be protected as a priority. A forward-facing child seat which is firmly attached to the vehicle will reduce the risk of impact to the head. Ensure your child travels in a forward-facing seat with a harness or buckle for as long as their size permits. Choose a bucket type seat for optimum side protection.



31234

Booster cushions

From 15 kg or 4 years, the child can travel using a booster seat, which will enable the seat belt to be adapted to suit his/her size and shape. The booster seat cushion must be fitted with guides to position the seat belt on the child's thighs rather than the stomach. It is recommended that you use a seat-back fitted with a belt strap guide which can be adjusted in terms of height to position the seat belt in the centre of the shoulder. It must never rest on the neck or on the arm.

Choose a bucket type seat for optimum side protection.

CHILD SAFETY: choosing a child/baby seat mounting (1/2)

There are two ways of attaching child seats: via the seat belt or using the ISOFIX system.

Attachment via the seat belt

The seat belt must be adjusted to ensure that it is effective in the event of harsh braking or an impact.

Ensure that the strap paths indicated by the child seat manufacturer are respected.

Always check that the seat belt is correctly fastened by pulling it up, then pulling it out fully whilst pressing on the child seat.

Check that the seat is correctly held by moving it from side to side and back to front: the seat should remain firmly fixed.

Check that the child seat has not been installed at an angle and that it is not resting against a window.



Do not use the child seat if it may unfasten the seat belt restraining it: the base of the seat must not rest on the buckle and/or catch of the seat belt.



Before using an ISOFIX child seat that you purchased for another vehicle, check that its installation is authorised. Consult the list of vehicles which can be fitted with the seat from the equipment manufacturer.



The seat belt must never be twisted or the tension relieved. Never pass the shoulder strap under the arm or behind the back. Check that the seat belt has not been damaged by sharp edges. If the seat belt does not operate normally, it will not protect the child. Consult an approved dealer. Do not use this seat until the seat belt has been repaired.

Attachment using the ISOFIX system

Authorised ISOFIX child seats are approved in accordance with regulation ECE-R44 in one of the three following cases:

- ISOFIX universal 3-point forward-facing seat;
- ISOFIX semi-universal 2-point seat;
- specific.

For the latter two, check that your child seat can be installed by consulting the list of compatible vehicles.

Attach the child seat with the ISOFIX locks, if these are provided. The ISOFIX system allows quick, easy, safe fitting.

The ISOFIX system consists of 2 rings and, in some cases, a third ring.



No modifications may be made to the component parts of the restraint system (seat belts, ISOFIX and seats and their mountings) originally fitted.

CHILD SAFETY: choosing a child/baby seat mounting (2/2)

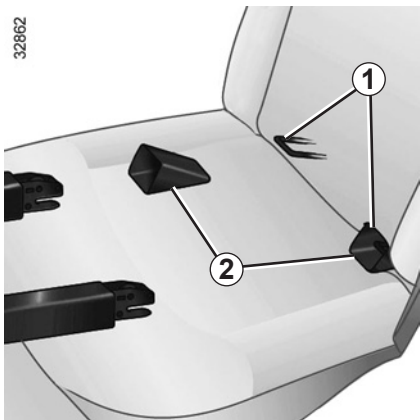

The two rings **1** are located between the seatback and the seat base and are identified by a marking. Use the access guides **2** of the child seat to ease it into place and lock it into the rings **1**. The third ring **4** or **5** is used to attach the upper strap on some child seats.

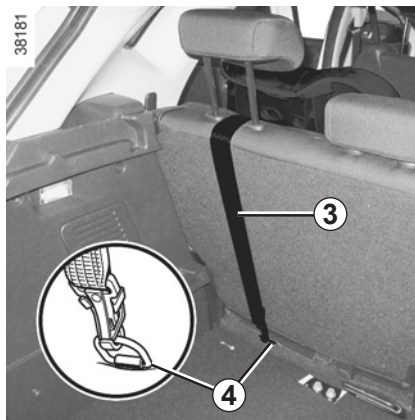

Rear seats

Put the rear parcel shelf down in order to be able to pass the strap **3** between the seatback and the parcel shelf (see the information on "Rear parcel shelf" in Section 3). Fix the hook on the ring **4**, identified by the  symbol on the back of the seat in question and located under the mobile floor.



Front passenger seat

Attach the belt hook **3** to the ring **5**.

All seats

Pull the belt **3** so that the back of the child seat comes into contact with the back of the vehicle seat.



The ISOFIX anchorage points have been exclusively designed for child seats with the ISOFIX system. Never fit a different type of child seat, seat belt or other objects to these anchorage points.

Check that nothing is obstructing the anchorage points.

If your vehicle has been involved in a road accident, have the ISOFIX anchorage points checked and replace your child seat.



Check that the seatback of the forward-facing child seat is in contact with the back of the vehicle seat.

In this case, the child seat may not always rest on the base of the vehicle seat.

CHILD SAFETY: fitting a child seat (1/4)

Some seats are not suitable for fitting child seats. The diagram on the following page shows you how to attach a child seat.

The types of child seat indicated may not be available. Before using a different child seat, check with the manufacturer that it can be fitted.



Ensure that the child seat or the child's feet do not prevent the front seat from locking correctly. Refer to the information on the "Front seat" in Section 1.

Check that when installing the child seat in the vehicle it is not at risk of coming loose from its base.

If you have to remove the headrest, check that it is correctly stored so that it does not come loose under harsh braking or impact.

Always attach the child seat to the vehicle even if it is not in use so that it does not come loose under harsh braking or impact.

In the front seat

The laws concerning children traveling in the front passenger seat differ in every country. Consult the legislation in force and follow the indications on the diagram on the following page.

Before fitting a child seat in this seat (if authorised):

- lower the seat belt as far as possible;
- move the seat as far back as possible;
- gently tilt the seatback away from vertical (approximately 25°);
- on equipped vehicles, raise the seat base as far as possible.

In all situations, reinsert the headrest to its full extent so that it does not interfere with the child seat (see the information on "Front headrests" in Section 1);

After installing the child seat, if necessary, the seat may be advanced (so as to leave enough space in the rear seats for passengers or other child seats). For a rear-facing child seat, do not let it touch the dashboard or move it to the furthest forward position.

Do not change other settings after installing the child seat.



RISK OF DEATH OR SERIOUS INJURY:

Before installing a child seat on the front passenger seat, check that the airbag has been deactivated (please refer to "Child safety: front passenger airbag deactivation and activation" in Section 1).

CHILD SAFETY: fitting a child seat (2/4)

In the rear side seat

A carrycot can be installed across the vehicle and will take up at least two seats.

Position the child with their feet nearest the door.

Move the front seat as far forward as possible to install a rear-facing child seat, then move back the seat in front as far as it will go, although without allowing it to come into contact with the child seat.

For the safety of the child in the forward-facing seat, do not move the seat in front back past the middle of the runner, do not tilt the seatback too far (maximum of 25°) and raise the seat as much as possible.

In all situations, remove the rear headrests (refer to the information on the "Rear headrests" in Section 3). This must be done before fitting the child seat.

Check that the forward-facing child seat is resting against the back of the vehicle seat.



Fit the child seat in a rear seat wherever possible. Fitting a seat ISOFIX in the rear-left seat means the middle seat cannot be used. The central seat belt will no longer be either accessible or useable. To install an ISOFIX seat in this seat, detach the central seat belt by hand before engaging the bolts.

CHILD SAFETY: fitting a child seat (3/4)

Fitting diagram

36192



 Check the status of the airbag before fitting a child seat or allowing a passenger to use the seat.



RISK OF DEATH OR SERIOUS INJURY: Before installing a child seat on the front passenger seat, check that the airbag has been deactivated (please refer to “Child safety: front passenger airbag deactivation and activation” in Section 1).

Child seat attached using the belt

U Seat which allows a seat with “universal” approval to be fitted using a seat belt;

UD Seat which allows a **rearfacing seat** with “universal” approval **only** to be attached with a seat belt.



Using a child safety system which is not approved for this vehicle will not correctly protect the baby or child. They risk serious or even fatal injury.

Child seat attached using the ISOFIX mounting



Seat which allows an ISOFIX child seat to be fitted.



The seats ISOFIX are fitted with an anchorage point which allows a forward-facing ISOFIX child seat with “Universal” approval to be attached. The anchorage points  are located in the boot for the rear seats, and on the seatbacks for the front seats.

The size of the ISOFIX child seat is indicated by a letter:

- A, B and B1: for forward-facing seats in group 1 (9 to 18 kg);
- C and D: shell seat or rear-facing seats in group 0+ (less than 13 kg) or group 1 (9 to 18 kg);
- E: rear-facing shell seats in group 0 (less than 10 kg) or 0+ (less than 13 kg);
- F and G: carrycots in group 0 (less than 10 kg).

CHILD SAFETY: fitting a child seat (4/4)

The table below summarises the information already shown on the diagram on the previous page, to ensure the regulations in force are respected.

Type of child seat	Weight of the child	Seat size	Front passenger seat (5) (1)	Rear side seats	Rear centre seat
Carrycot fitted across the vehicle Group 0	< 10 kg	F, G	X	U (2)	X
Rear-facing shell seat Group 0 or 0+	< 10 kg and < 13 kg	E	U - IL	U - IL (3)	X
rear-facing seat Group 0+ and 1	< 13 kg and 9 to 18 kg	C, D	U - IL	U - IL (3)	X
Forward-facing seat Group 1	9 to 18 kg	A, B, B1	IUF - IL	U - IUF - IL (4)	X
Booster seat Group 2 and 3	15 to 25 kg and 22 to 36 kg	-	X	U (4)	X

X = Seat not suitable for fitting child seats.

U = Seat which allows a child seat with “Universal” approval to be installed using a seat belt; check that it can be fitted.

IUF/IL = On equipped vehicles, seat which allows an approved “Universal/semi-universal or vehicle specific” child seat to be attached using the ISOFIX system; check that it can be fitted.

- (1) raise the seat to the maximum and position it as far back as possible, tilting the seatback slightly (approximately 25°).
- (2) A carrycot can be installed across the vehicle and will take up at least two seats. Position the child with their feet nearest the door.
- (3) Move the front seat as far forward as possible to install a rear-facing child seat, then move back the seat in front as far as it will go, although without allowing it to come into contact with the child seat.
- (4) Forward-facing child seat; position the seatback of the child seat in contact with the seatback of the vehicle seat. In all situations, remove the rear headrest of the seat on which the child seat is positioned. This must be done before fitting the child seat. Refer to the information on “Rear headrests” in Section 3.



(5) RISK OF DEATH OR SERIOUS INJURY: before installing a child seat on the front passenger seat, check that the air bag has been deactivated (refer to “Child safety: front passenger air bag deactivation/activation” Section 1).

CHILD SAFETY: deactivating/activating the front passenger air bag (1/3)

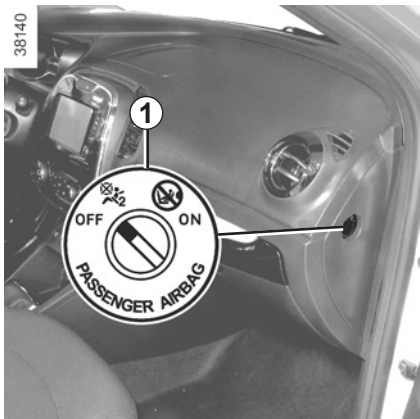

Deactivating the front passenger airbags (on equipped vehicles)

You **must** deactivate the devices in addition to the front passenger seat belt before fitting a child seat in the front passenger seat.

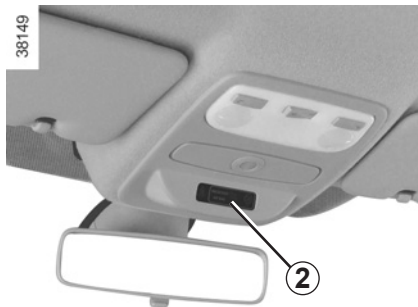



To deactivate the airbags: with the vehicle stopped and the ignition off, push and turn lock **1** to the **OFF** position.

With the ignition on, you **must** check

that the warning light  **2** on the display **2** is lit up and, depending on the vehicle, that the message “airbag passenger deactivated” is displayed.

This light remains permanently lit to let you know that you can fit a child seat.



The passenger air bag must only be deactivated or activated **with the ignition off**. If it is interfered with when the vehicle is being driven, indicator lights  and  will come on. Switch the ignition off then on again to reset the air bag in accordance with the lock.

CHILD SAFETY: deactivating/activating the front passenger air bag (2/3)



A



The markings on the dashboard and labels **A** on each side of passenger sun blind **3** (example: label shown above) remind you of these instructions.



DANGER

Since operation of the front passenger airbag is not compatible with the position of a rear-facing child seat, **NEVER** fit a restraint system for a rear-facing child in a seat protected by an **ACTIVATED front AIRBAG**. This can cause the **CHILD'S DEATH** or **SERIOUS INJURY**.

CHILD SAFETY: deactivating/activating the front passenger air bag (3/3)





Activating the front passenger air bags

You should reactivate the airbags as soon as you remove the child seat from the front passenger seat to ensure the protection of the front passenger in the event of an impact.



To reactivate the airbags: with the vehicle stopped and the ignition off, push and turn lock **1** to the **ON** position.

With the ignition switched on, you **must** check that the warning light  **2** is out and that the warning light  comes on the display **2** after each start-up for around 60 seconds.

The front passenger seat belt additional restraint systems are activated.

Operating faults

It is forbidden to fit a rear-facing child seat to the front passenger seat if the airbags activation/deactivation system is faulty.

Allowing any other passenger to sit in that seat is not recommended.

Contact your approved dealer as soon as possible.



The passenger airbag must only be deactivated or activated when the **vehicle is stationary**.

If it is interfered with when the vehicle is being driven, indicator lights



and  will come on.

Switch the ignition off then on again to reset the airbag in accordance with the lock position.

DRIVING POSITION: LEFT-HAND DRIVE (1/2)

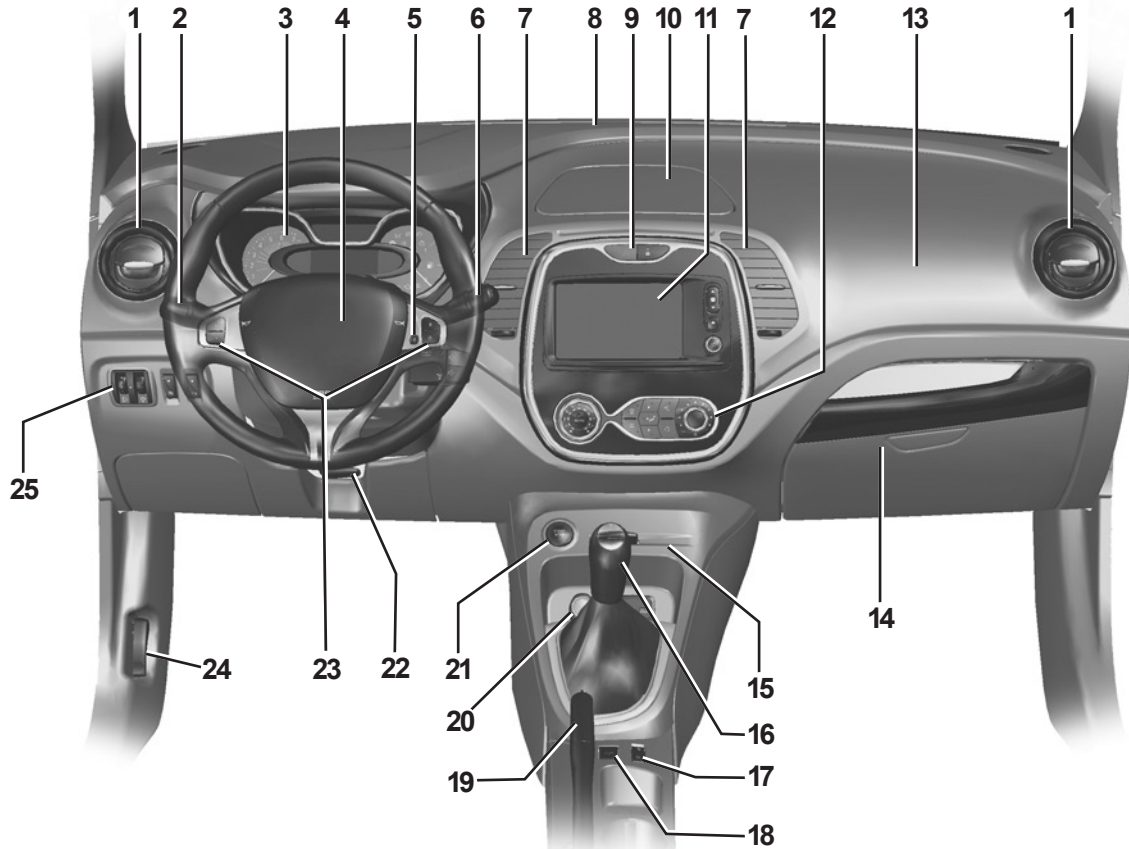

DRIVING POSITION: LEFT-HAND DRIVE (2/2)

The equipment fitted, described below, **DEPENDS ON THE VERSION AND COUNTRY.**

- 1** Side air vent.
- 2** Stalk for:
 - direction indicator lights;
 - exterior lights;
 - front fog lights;
 - rear fog lights.
- 3** Instrument panel.
- 4** Driver Airbag and horn location.
- 5** Multimedia system voice control button.
- 6** Stalk:
 - windscreen and rear screen wash/wipe;
 - trip computer and warning system information readout.
- 7** Centre air vents.
- 8** Windscreen demister outlet.
- 9** Switch for:
 - hazard warning lights,
 - electric door locking.
- 10** Storage.
- 11** Multimedia touch-screen.
- 12** Heating or air conditioning controls.
- 13** Passenger Airbag location.
- 14** Storage drawer.
- 15** RENAULT card reader.
- 16** Gear lever.
- 17** Cruise control/speed limiter main control.
- 18** ECO mode switch.
- 19** Handbrake.
- 20** Cigarette lighter/accessories socket.
- 21** Engine start/stop button.
- 22** Control for adjusting steering wheel height and reach.
- 23** Cruise control/speed limiter controls.
- 24** Bonnet release control.
- 25** Controls for:
 - electric headlight beam adjustment,
 - instrument panel lighting dimmer,
 - activate/deactivate the parking distance control system,
 - activation/deactivation of the Stop and Start function.

DRIVING POSITION: RIGHT-HAND DRIVE (1/2)

38163

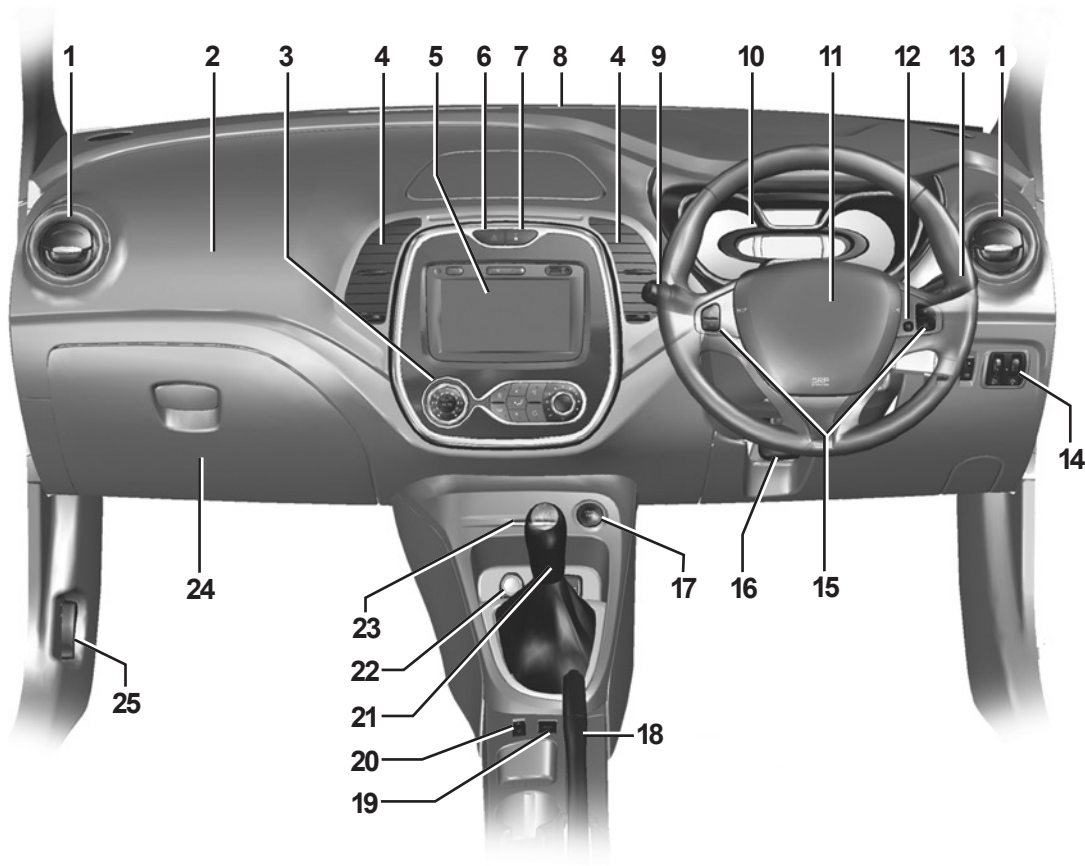

DRIVING POSITION: RIGHT-HAND DRIVE (2/2)

The equipment fitted, described below, **DEPENDS ON THE VERSION AND COUNTRY.**

- 1 Side air vent.
- 2 Passenger Airbag location.
- 3 Heating or air conditioning controls.
- 4 Centre air vents.
- 5 Multimedia touch screen.
- 6 Hazard warning lights switch.
- 7 Door electric locking switch.
- 8 Windscreen demister outlet.
- 9 Stalk:
 - direction indicator lights;
 - exterior lights;
 - front fog lights;
 - rear fog lights.
- 10 Instrument panel.
- 11 Driver Airbag and horn location.
- 12 Multimedia system voice control button.
- 13 Stalk:
 - windscreen and rear screen wash/wipe;
 - trip computer and warning system information readout.
- 14 Controls for:
 - electric headlight beam adjustment,
 - instrument panel lighting dimmer,
 - activate/deactivate the parking distance control system,
 - activation/deactivation of the Stop and Start function.
- 15 Cruise control/speed limiter controls.
- 16 Control for adjusting steering wheel height and reach.
- 17 Engine start/stop button.
- 18 Handbrake.
- 19 ECO mode switch.
- 20 Cruise control/speed limiter control.
- 21 Gear lever.
- 22 Cigarette lighter/accessories socket.
- 23 RENAULT card reader.
- 24 Glovebox.
- 25 Bonnet release control.

WARNING LIGHTS (1/4)

The display of information shown below **DEPENDS ON THE VEHICLE EQUIPMENT AND COUNTRY.**



Instrument panel A: lights up when the ignition is switched on.

With the lights on, you can adjust the brightness by turning the knob **1**.

The  warning light means you should **drive very carefully** to an approved dealer as soon as possible. If you fail to follow this recommendation, you risk damaging your vehicle.

In some cases, the appearance of a warning light is accompanied by a message.



Side light warning light



Main beam headlight tell-tale



Dipped beam headlight tell-tale



Front fog light tell-tale



Rear fog light tell-tale



Left-hand direction indicator tell-tale



Right-hand direction indicator tell-tale



Warning light **STOP** requires you to stop immediately, for your own safety, as soon as traffic conditions allow. Switch off the engine and do not restart it. Contact an approved Dealer.



Air bag warning light

This lights up when the ignition is switched on and goes out after a few seconds.

If it does not come on when the ignition is switched on, or comes on when the engine is running, there is a fault in the system.

Contact your approved Dealer as soon as possible.



Low fuel level warning light

This lights up when the ignition is switched on and goes out after a few seconds.

If it lights up when driving, fill up with fuel as soon as possible. There is only approximately 30 miles (50 km) worth of fuel left.



If no lights or sounds are apparent, this indicates a fault in the instrument panel. This indicates that it is essential to stop immediately (as soon as traffic conditions allow). Ensure that the vehicle is correctly immobilised and contact an approved Dealer.

WARNING LIGHTS (2/4)

The display of information shown below **DEPENDS ON THE VEHICLE EQUIPMENT AND COUNTRY.**



STOP light
This lights up when the ignition is switched on and goes out as soon as the engine is started. It comes on with other warning lights and/or messages, and is accompanied by a beep.

It requires you to stop immediately, for your own safety, as soon as traffic conditions allow. Switch off the engine and do not restart it.

Contact an approved Dealer.

Handbrake on and brake circuit incident warning light

This comes on when the ignition is switched on and goes out as soon as the handbrake is released.

If it comes on during braking and is accompanied by the **STOP** warning light and a beep, it indicates that the fluid level in the circuit is low or that there is a braking system fault.

Stop as soon as traffic conditions allow and contact an approved Dealer.

Battery charge warning light

This lights up when the ignition is switched on and goes out after a few seconds.

If it comes on on the road, accompanied by the **STOP** warning light and a beep, this indicates an overload or discharge in the electrical circuit.

Stop as soon as traffic conditions allow and contact an approved Dealer.

Oil pressure warning light

This lights up when the ignition is switched on and goes out after a few seconds.

If it comes on on the road, accompanied by the **STOP** warning light and a beep, stop immediately and cut the ignition.

Check the oil level. If the level is normal, the indicator light is being lit by something else. Contact an approved Dealer.

Warning light

This lights up when the ignition is switched on and goes out as soon as the engine is started. It can light up in conjunction with other indicator lights and/or messages on the instrument panel.

It means you should **drive very carefully** to an approved dealer as soon as possible. If you fail to follow this recommendation, you risk damaging your vehicle.

WARNING LIGHTS (3/4)

The display of information shown below **DEPENDS ON THE VEHICLE EQUIPMENT AND COUNTRY.**



Electronic Stability Program (ESP) and traction control system (ASR) warning light

This lights up when the ignition is switched on and goes out after a few seconds.

There are several reasons for the warning light to come on: please refer to the information on “Dynamic driving control: ESP” and “Traction control: ASR” in Section 2.



Toxic Fume Filter System Warning Light

For vehicles equipped with this option, the light comes on when the ignition is switched on then goes out.

- If it lights up continuously, consult your approved dealer as soon as possible;
- if it flashes, reduce the engine speed until the light stops flashing. Contact your approved Dealer as soon as possible.

Refer to the information on “Advice: antipollution, fuel economy and driving” in Section 2.



Anti-lock braking warning light

This lights up when the ignition is switched on and goes out after a few seconds.

If it lights up when you are driving, it indicates a fault in the anti-lock braking system.

Braking will then be as normal, without the ABS. Contact an approved Dealer as soon as possible.



Coolant temperature warning light

This comes on when the ignition is switched on.

If it turns red, stop and let the engine idle for a minute or two.

The temperature should lower and the warning light should return to a blue colour. If not, stop the engine. Let the engine cool down before checking the coolant.

Contact an approved Dealer.

WARNING LIGHTS (4/4)

The display of information shown below **DEPENDS ON THE VEHICLE EQUIPMENT AND COUNTRY.**



Preheating warning light (diesel version)

This should come on when the ignition is switched on. It indicates that the heater plugs are in operation.

It goes out when preheating is complete. The engine can be started.

Speed limiter and cruise control indicator lights

See the information on the “Speed limiter” and “Cruise control” in Section 2.

Engine standby warning light

Please see information about “Stop and Start function” in Section 2.

ECO mode warning light

This comes on when ECO mode is activated.

Please refer to the information on “Eco-driving” in Section 2.

Door(s) open warning light

 **Fuel economy indicator light**
This lights up to advise you to change to a higher gear (up arrow) or lower gear (down arrow).

 **Not used**

DISPLAYS AND INDICATORS

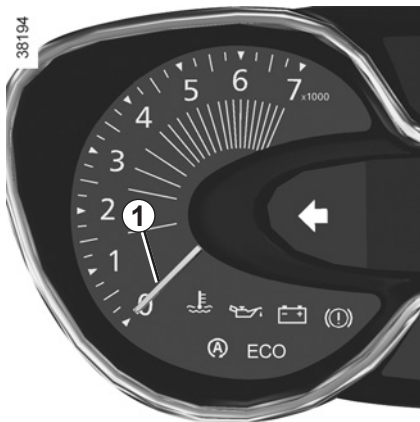

Rev counter 1
(graduations x 1000)



Speedometer 2
(km or miles per hour)

Overspeed buzzer

Depending on the vehicle, a warning beep sounds for approximately 10 seconds every 30 seconds, as long as the vehicle is travelling in excess of 75 mph (120 km/h).



Low engine oil level warning

When the engine is started, display 3 alerts the driver when the oil level is at its minimum. Refer to the information on the "Engine oil level" in Section 4.

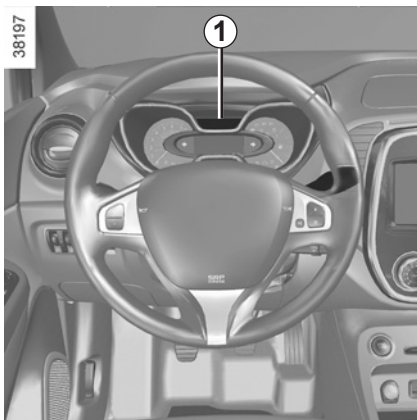

Fuel level gauge 4

ON-BOARD COMPUTER: general information (1/2)



On-board computer 1

Depending on the vehicle, this includes the following functions:

- distance travelled;
- journey settings;
- information messages;
- operating fault messages (connected to the  warning light);
- warning messages (connected to the  warning light);
- vehicle settings customisation menu.

All these functions are described on the following pages.



Display selection keys 2 and 3

Scroll through the following information upwards (key 2) or downwards (key 3) by pressing briefly and successively (the display depends on the vehicle equipment and country).

- a) total mileage and trip mileage recorder;
- b) fuel used;
- c) average fuel consumption;
- d) current fuel consumption;
- e) estimated range;

- f) distance travelled;
- g) average speed;
- h) distance before service;
 - service counter;
 - oil change counter;
- i) cruise control/speed limiter programmed speed;
- j) clock and temperature;
- k) trip log, operating faults and information message readout.

ON-BOARD COMPUTER: general information (2/2)



Resetting the trip mileage

With “trip mileage recorder” selected on the display, press button **2** or **3** until the mileage recorder resets to zero.

Resetting the journey parameters (reset button)

With one of the trip parameters selected as the display, press and hold button **2** or **3** until the display resets.

Interpreting some of the values displayed after resetting

The values showing average fuel consumption, range and average speed will become more stable and reliable the further you travel after pressing the reset button.

For the first few miles after pressing the reset key you will notice that the range increases as you travel. This range takes into account the average fuel consumption since the last time the reset button was pressed. Therefore, the average fuel consumption may decrease when:



- the vehicle stops accelerating;
- the engine reaches its operating temperature (if the engine was cold when the reset key was pressed);
- when driving from an urban area onto the open road.

Automatic resetting of the journey parameters

Resetting occurs automatically when the maximum value of any of the parameters is exceeded.



TRIP COMPUTER: trip settings (1/5)

The display of information shown below **DEPENDS ON THE VEHICLE EQUIPMENT AND COUNTRY.**

Examples of selections	Interpreting the display selected
<p>101778 km 112.4 km</p>	<p>⇒ a) Total mileage and trip mileage recorder.</p>
<p>FUEL USED 8L </p>	<p>⇒ b) Journey parameters. Fuel used. Fuel consumed since the last reset.</p>
<p>AVERAGE 5.8 L/100 </p>	<p>⇒ c) Average fuel consumption since the last reset. The value is displayed after having travelled at least 400 metres since the last reset.</p>
<p>CURRENT 9.4 L/100 </p>	<p>⇒ d) Current fuel consumption. This value is displayed after a speed of approximately 20 mph (30 km/h) is reached.</p>

TRIP COMPUTER: trip settings (2/5)

The display of information shown below **DEPENDS ON THE VEHICLE EQUIPMENT AND COUNTRY.**

Examples of selections	Interpreting the display selected
<p>RANGE 541 km</p> 	<p>⇒ e) Estimated range with remaining fuel. The value is displayed after driving 400 metres.</p>
<p>DISTANCE 522 km</p> 	<p>⇒ f) Distance travelled since last reset.</p>
<p>AVERAGE 123.4 km/H</p> 	<p>⇒ g) Average speed since the last reset. The value is displayed after driving 400 metres.</p>

TRIP COMPUTER: trip settings (3/5)

The display of information shown below **DEPENDS ON THE VEHICLE EQUIPMENT AND COUNTRY.**

Examples of selections	Interpreting the display selected
<p data-bbox="92 288 356 395">SERVICE INTERVALS</p> <p data-bbox="364 322 435 361">➔</p> <p data-bbox="447 288 722 395">SERVICE IN 30,000 kms / 12 months</p> <p data-bbox="364 445 435 484">➔</p> <p data-bbox="447 412 722 518">SERVICE DUE 300 kms / 24 days</p> <p data-bbox="364 568 435 608">➔</p> <p data-bbox="447 535 722 641">Service required</p>	<p data-bbox="765 348 1214 372">h) Mileage before service or oil change.</p> <p data-bbox="792 387 1049 412">Mileage before service</p> <p data-bbox="792 415 1425 518">With the ignition switched on but the engine not running, when the message “Mileage before service” is displayed, press button 2 or 3 for around five seconds to display the mileage before the next due service.</p> <p data-bbox="792 521 1425 596">Distance remaining until the next service (displayed in miles/kilometres and months), then when the service nears, several scenarios are possible:</p> <ul data-bbox="792 600 1425 759" style="list-style-type: none"><li data-bbox="792 600 1425 675">– distance/time remaining less than 900 miles (1,500 km) or one month: the message “Service due in” is displayed accompanied by the nearest term (distance or time);<li data-bbox="792 678 1425 759">– distance equal to 0 miles or service date reached: the message “service vehicle” is displayed accompanied by the  warning light. <p data-bbox="792 762 1335 787">The vehicle requires a service as soon as possible.</p>
<p data-bbox="84 885 1425 932">Resetting: to reset the distance before service, press and hold button 2 or 3 for approximately 10 seconds until the display shows the mileage permanently.</p> <p data-bbox="84 947 1425 994">NB: if a service is performed without changing the engine oil, only the mileage before the next service should be reset. In the event of an oil change, both the distance before the next service and the next oil change should be reset.</p>	



TRIP COMPUTER: trip settings (4/5)

The display of information shown below **DEPENDS ON THE VEHICLE EQUIPMENT AND COUNTRY.**

Examples of selections	Interpreting the display selected
<p data-bbox="92 297 356 404">SERVICE INTERVALS</p> <p data-bbox="364 331 435 370">➔</p> <p data-bbox="447 297 722 404">OIL CHANGE IN 30,000 kms / 24 months</p> <p data-bbox="364 465 435 505">➔</p> <p data-bbox="447 432 722 538">Service due 300 kms / 24 days</p> <p data-bbox="364 600 435 639">➔</p> <p data-bbox="447 566 722 673">Service required</p>	<p data-bbox="792 337 1052 359">Mileage before service</p> <p data-bbox="792 365 1425 516">With the ignition switched on and the engine not running, when the “Mileage before service” message is displayed, press button 2 or 3 for approximately five seconds to display the mileage before the next service, then briefly press button 2 or 3 to view the mileage before the next oil change.</p> <p data-bbox="792 533 1425 605">Distance remaining until the next oil change (displayed in miles/kilometres and months), then when the time nears, several scenarios are possible:</p> <ul data-bbox="792 611 1425 768" style="list-style-type: none"><li data-bbox="792 611 1425 684">– distance/time remaining less than 900 miles (1,500 km) or one month: the message “Service due in” is displayed accompanied by the nearest term (distance or time);<li data-bbox="792 689 1425 768">– range equal to 0 km/miles or service date reached: the message “service vehicle” is displayed accompanied by the  warning light. <p data-bbox="792 773 1384 796">The vehicle requires an oil change as soon as possible.</p>
<p data-bbox="84 880 1425 930">Resetting: to reset the mileage before an oil change, press and hold button 2 or 3 for approximately 10 seconds until the display shows the range permanently.</p> <p data-bbox="84 947 1425 997">NB: if a service is performed without changing the engine oil, only the mileage before the next service should be reset. In the event of an oil change, both the distance before the next service and the next oil change should be reset.</p>	

TRIP COMPUTER: trip settings (5/5)

The display of information shown below **DEPENDS ON THE VEHICLE EQUIPMENT AND COUNTRY.**

Examples of selections	Interpreting the display selected
<div data-bbox="92 286 399 418" style="border: 1px solid black; padding: 5px; text-align: center;">SPEED LIMITER 90 km/H</div>	 i) Cruise control/speed limiter programmed speed. Refer to the information on the “Speed limiter” and “Cruise control” in Section 2.
<div data-bbox="92 439 399 571" style="border: 1px solid black; padding: 5px; text-align: center;">CRUISE CONTROL 90 km/H</div>	
<div data-bbox="92 598 399 723" style="border: 1px solid black; padding: 5px; text-align: center;">13° 16:30</div>	 j) Clock and temperature. Please refer to the information under “Clock and exterior temperature”.
<div data-bbox="92 750 399 882" style="border: 1px solid black; padding: 5px; text-align: center;">No message available</div>	 k) Trip log. Successive display: <ul style="list-style-type: none">– information messages (passenger airbag OFF etc.);– operating fault messages (Check injection system, etc.).

TRIP COMPUTER AND WARNING SYSTEM: information messages

These can help in the vehicle starting phase, or give information about a selection or a driving status. Examples of information messages are given in the following pages.

Examples of messages	Interpreting the display selected
« PARKING BRAKE ON »	Indicates that the parking brake has been applied.
« PLEASE REMOVE KEYCARD »	Request to remove the RENAULT card from the reader when you leave the vehicle.
« TRACTION CONTROL OFF »	Indicates that you have deactivated the ASR function.
« TURN STEERINGWHEEL + START »	Turn the steering wheel slightly whilst pressing the vehicle start button to unlock the steering column.
« STEERING WHEEL NOT LOCKED »	Indicates that the steering column has not been locked.

TRIP COMPUTER AND WARNING SYSTEM: operating fault messages

These appear with the  warning light and mean that you should drive very carefully to an authorised dealer as soon as possible. If you fail to follow this recommendation, you risk damaging your vehicle.

They disappear when the display selection key is pressed or after several seconds and are stored in the computer log. The  warning light stays on. Examples of operating fault messages are given in the following pages.

Examples of messages	Interpreting the display selected
« CLEAN DIESEL FILTER »	Indicates the presence of water in the diesel filter; contact an approved Dealer as soon as possible.
« CHECK VEHICLE »	Indicates a fault in one of the pedal sensors, battery management system or oil level sensor.
« CHECK AIRBAG »	Indicates a fault in the restraint system in addition to the seat belts. In the event of an accident, it is possible that they may not be triggered.
« Check antipollution system »	Indicates a fault in the vehicle's particle filter system.

TRIP COMPUTER AND WARNING SYSTEM: warning message

These appear with the **STOP** warning light and require you to stop immediately, for your own safety, as soon as traffic conditions allow. Stop your engine and do not restart it. Contact an approved Dealer.

Examples of warning messages are given in the following pages. **Note:** the messages appear on the display either individually or alternately (when there are several messages to be displayed), and may be accompanied by a warning light and/or a beep.

Examples of messages	Interpreting the display selected
« GEAR BOX RISK OF BREAKAGE »	Indicates an injection fault, the vehicle's engine has overheated or there is a serious engine fault.
« Braking system fault »	Indicates a fault in the braking system.
« BATTERY CHARGING FAULT »	Indicates a fault in the vehicle battery charging circuit (alternator etc.).

STEERING WHEEL/POWER-ASSISTED STEERING

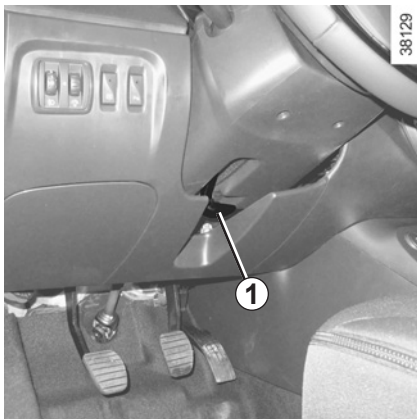

Adjusting the steering wheel height and depth

Pull lever **1** and place the steering wheel in the required position; push the lever beyond the point of resistance to lock the steering wheel in place.

Make sure that the steering wheel is correctly locked.



For safety reasons, only adjust the steering wheel when the vehicle is stationary.

Power Assisted Steering

Never drive with an inadequately charged battery.

Variable power assisted steering

The variable power assisted steering system is equipped with an electronic control system which alters the level of assistance to suit the vehicle speed.

Steering is made easier during parking manoeuvres (for added comfort) whilst the force needed to steer increases progressively as the speed rises (for enhanced safety at high speeds).

With the engine switched off, or if there is a system fault, it is still possible to turn the steering wheel. The force required will be greater.



Never switch off the ignition when travelling downhill, and avoid doing so in normal driving (assistance is not provided).

Never leave the steering wheel at full lock while stationary.

CLOCK AND EXTERIOR TEMPERATURE (1/2)

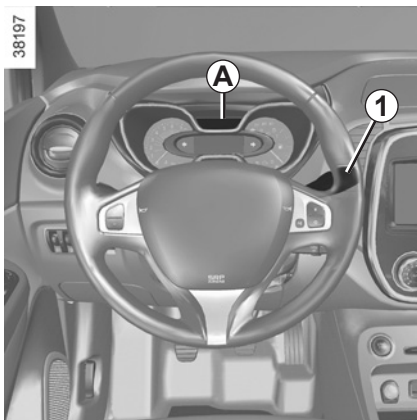

Display A

To access the display **2** for setting the time, press button **3** or **4** on the stalk **1**.

Wait a few seconds; the hours and minutes will begin to flash. You are now in setting mode, press and hold button **3** or **4** to set the hour.

Once the minutes flash, repeatedly press or press and hold button **3** or **4** to set the time.

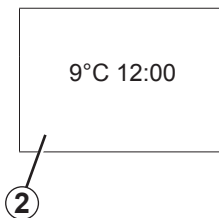

Wait a few seconds, the minutes will flash: repeatedly press or press and hold button **3** or **4** to set the time.

When setting is complete, the hours and minutes remain displayed continuously for 2 seconds: your setting is registered.

You may change the display.

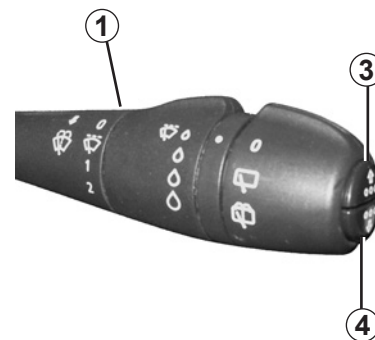

If the power supply is cut (battery disconnected, supply wire cut, etc.), the clock must be reset.

We recommend that you do not adjust these settings while driving.

CLOCK AND EXTERIOR TEMPERATURE (2/2)



Display B

Vehicles fitted with touch-screen multimedia, navigation aid systems, telephones, etc.

Refer to the separate instructions for the function to understand the special features of this equipment.

External temperature indicator

Special note:

When the exterior temperature is -3°C to $+3^{\circ}\text{C}$, the $^{\circ}\text{C}$ characters flash (signalling a risk of ice on the road).



External temperature indicator

As ice formation is related to climatic exposure, local air humidity and temperature, the external temperature alone is not sufficient to detect ice.

If the power supply is cut (battery disconnected, supply wire cut, etc.), the clock must be reset.

We recommend that you do not adjust these settings while driving.

REAR VIEW MIRRORS

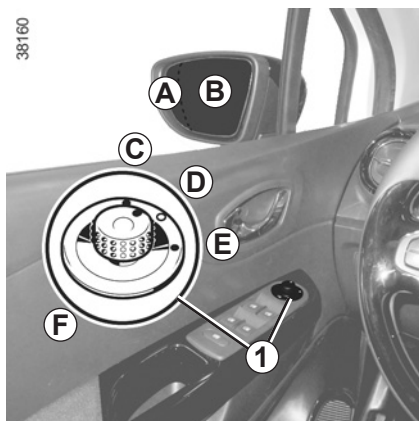

Door mirrors with electrical adjustment

With the ignition on, turn button **1**:

- position **C** to adjust the left-hand door mirror;
- position **E** to adjust the right-hand door mirror;

D is the inactive position.



For safety reasons, carry out any adjustments when the vehicle is not being driven.

Heated door mirrors

With the engine running, mirror de-icing is activated simultaneously with rear screen de-icing/demisting.

Folding door mirrors

(depending on vehicle)

Move button **1** to position **F**: the door mirrors fold away. To reset them for driving, return to position **C**, **D** or **E**.

If you manually fold the door mirrors, before setting them to the driving position (**C**, **D**, **E**), you must position control **1** to **F**.



The driver's door mirror may have two clearly defined zones. Zone **B** shows what can normally be seen in an ordinary rear view mirror. Zone **A** increases rear side visibility.

Objects in zone A look much further away than they really are.



Interior rear view mirror

Its position can be adjusted. For night driving, to avoid being dazzled by the headlights of the car behind you, flip the small lever **2** located behind the rear view mirror.

EXTERIOR LIGHTING AND SIGNALS (1/3)

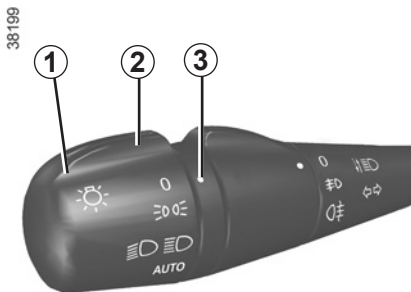

Side lights

Turn the ring **2** until the symbol is opposite mark **3**.

An indicator light on the instrument panel will come on.



Daytime running lights function

(front lights only)

Depending on the vehicle, daytime running lights come on automatically when the engine is started.



Dipped beam headlights

Manual operation

Turn the ring **2** until the symbol is opposite mark **3**. This indicator light on the instrument panel comes on.

Automatic operation

(depending on vehicle)

Turn ring **2** until the AUTO symbol is opposite mark **3**: with the engine running, the dipped beam headlights switch on or off automatically depending on the brightness of the light outside, without any action on stalk **1**.



Before driving at night, check that the electrical equipment is operating correctly and adjust the headlight beams (if your vehicle is not carrying its normal load). As a general precaution, check that the lights are not obscured (by dirt, mud, snow or objects being transported).

When driving on the left in a left-hand drive vehicle (or vice versa), drivers must re-adjust their lights throughout their stay (see "Adjusting headlight beams" in Section 1).

EXTERIOR LIGHTING AND SIGNALS (2/3)

38189

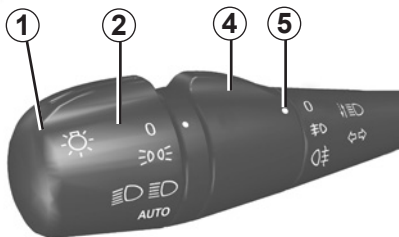

Main beam headlights

With the engine running and the dipped beam headlights on, push stalk **1**. This indicator light on the instrument panel comes on.

To return to the dipped headlight position, pull stalk **1** towards you again.

Switching off the lights

There are two possibilities:

- Manually, move ring **2** to position **0**;
- automatically, the lights will go out when the engine is switched off, the driver's door is opened or the vehicle is locked. In this case, the next time the engine is started the lights will be switched back on according to the position of the ring **2**.

Lights-on reminder buzzer

When the lights have been left on after turning the engine off, a warning beep will sound when the driver's door is opened to remind you that the lights are still on.

Front fog lights

Turn centre ring **4** on the stalk **1** until the symbol faces mark **5**, then release it.

Operation of the fog lights depends on the exterior lighting position selected, and an indicator light will light up on the instrument panel.

Cornering lights function

Whenever the side lights are on and under certain conditions (at speed, the steering wheel at an angle, in forward gear, the indicator lights on, etc.), when cornering, one of the fog lights will come on to light the inside of the bend.

EXTERIOR LIGHTING AND SIGNALS (3/3)

38189



Rear fog light

Turn centre ring **4** on the stalk until the symbol faces mark **5**, then release it.

Operation of the fog lights depends on the exterior lighting selected, and an indicator light will light up on the instrument panel.

To avoid inconveniencing other road users, remember to switch off the rear fog light when it is no longer needed.

Turning off the fog lights

There are two possibilities:

- Manually, turn the ring **4** again to bring the reference mark **5** in line with the symbol corresponding to the fog light you want to turn off. The corresponding indicator light will go out on the instrument panel;
- the lights will go out automatically when the engine is switched off, the driver's door is opened or the vehicle is locked.

The front and rear fog lights switch off when the exterior lights are switched off.

When driving in fog or snow, or when transporting objects which are higher than the roof, the headlights do not come on automatically.

Switching on the fog lights remains the responsibility of the driver: the indicator lights on the instrument panel inform you whether the fog lights are lit (indicator light on) or not (indicator light not on).

AUDIBLE AND VISUAL SIGNALS

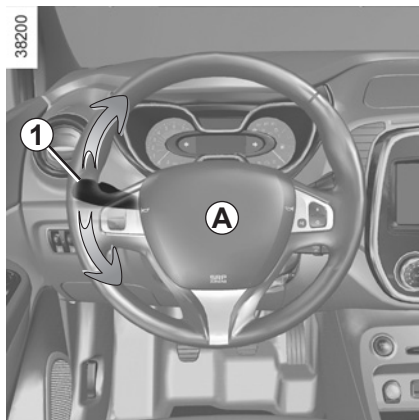

Horn

Press steering wheel boss **A**.

Headlight flasher

Pull stalk **1** towards you to flash the headlights.

Direction indicators

Move stalk **1** parallel to the steering wheel and in the direction you are going to turn it.

One-touch mode

When driving, it is possible that the steering wheel may not be turned sufficiently to return the stalk automatically to its starting position.

In this case, move the stick **1** to halfway, then release it: it will return to its initial position and the indicator light flashes three times.



Hazard warning lights

Press switch **2**.

This switch activates all four direction indicators and the side indicator lights simultaneously. It must only be used in an emergency to warn drivers of other vehicles that you have had to stop in an area where stopping is prohibited or unexpected, or that you are obliged to drive under special conditions.

Depending on the vehicle, the hazard warning lights may come on automatically under heavy deceleration. You can switch them off by pressing switch **2** once.

HEADLIGHT BEAM ADJUSTMENT (1/2)

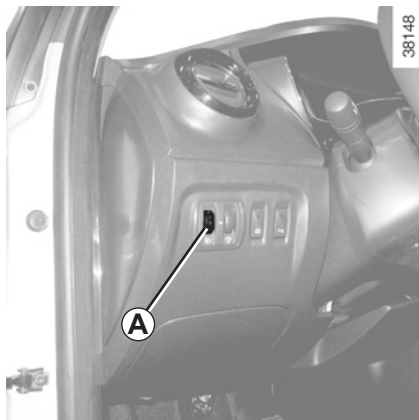

On vehicles fitted with this function, control **A** allows you to adjust the height of the beams according to the load.

Turn control **A** downwards to lower the headlights and upwards to raise them.

For manual settings	
Examples of positions for adjusting control A according to the load	
0	Driver alone or with front passenger
1	Driver with a passenger in front, two or three passengers in the rear and luggage
2	Driver with luggage or (load) reaching the maximum permissible all-up weight
3 et 4	Do not use

HEADLIGHT BEAM ADJUSTMENT (2/2)

When driving on the left in a left-hand drive vehicle (or vice versa), you must adjust your lights temporarily during your stay.

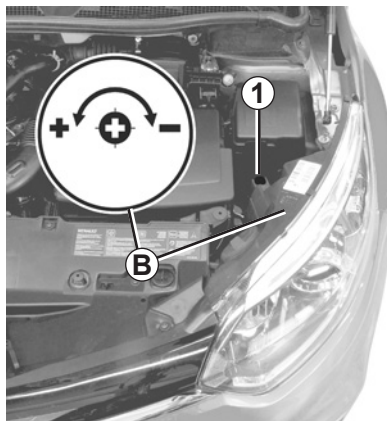

Temporary adjustment

Open the bonnet and identify the marking **B** next to one of the front headlight projectors.

For each headlight, using a screwdriver, turn the screw **1** by a quarter turn towards the - symbol to lower the beams.

Return to the starting point once your trip is over: turn the screw **1** by a quarter turn towards the + symbol to raise the beams.

WINDSCREEN WASH/WIPE (1/2)

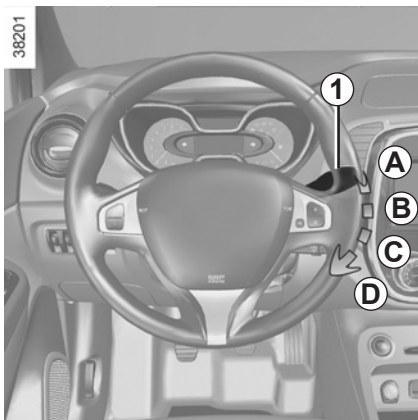

With the ignition on, move stalk **1**

- **A park.**
- **B intermittent wiping.**
The wipers will pause for several seconds between sweeps. It is possible to change the time between sweeps by turning ring **2**.
- **C normal wiping speed.**
- **D fast wiping speed.**

Positions **B** and **C** are accessible with the ignition on. Position **D** is accessible only when the engine is running.

Vehicles with automatic wiper function

With the engine running, move stalk **1**

- **A park.**
- **B automatic wiper function**
When this position is selected, the system detects water on the windscreen and triggers the wipers at a suitable wiping speed. It is possible to change the triggering threshold and the time sweeps by turning ring **2**:
 - **E**: minimum sensitivity
 - **F**: maximum sensitivity**NB:** in foggy weather or during snowfalls, the wiping is not automatically triggered and remains under the driver's control.
- **C normal wiping speed.**
- **D fast wiping speed.**

Position **C** is accessible with the ignition on. Positions **B** and **D** are accessible only with the engine running.

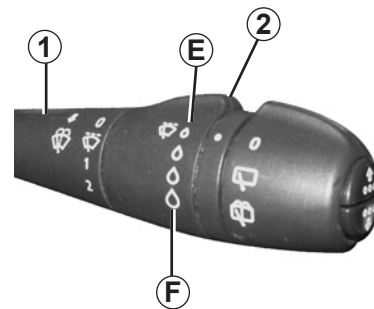

Special note

When driving, the wiping speed slows down whenever the vehicle stops. For example: the speed will change from a fast wiping speed to normal wiping speed.

As soon as the vehicle moves off, wiping will return to the speed originally selected.

Any action on stalk **1** overrides and cancels automatic operation.

WINDSCREEN WASH/WIPE (2/2)

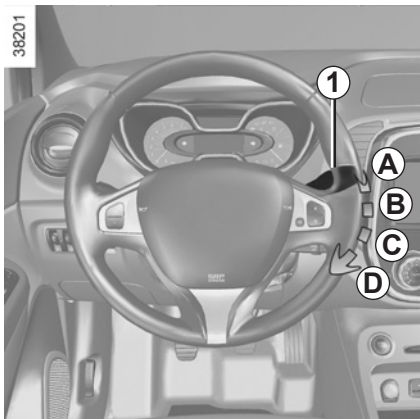

Windscreen washer

With the ignition on, pull stalk **1** towards you.

A brief pull will trigger a single sweep of the wipers, in addition to the windscreen washer.

A longer pull triggers, as well as the windscreen washer, continuous sweeping until the end of the request, then three return sweeps, then after a few seconds, a fourth.

Do not try to lift the wiper blades. They cannot remain detached from the windscreen. To replace the blades, refer to Section 5: “Wiper blades”.



When working in the engine compartment, ensure that the windscreen wiper stalk is in position **A** (park).

Risk of injury.



Before any action involving the windscreen (washing the vehicle, de-icing, cleaning the windscreen, etc.) return stalk **1** to position **A** (park).

Risk of injury and/or damage.

In freezing or snowy weather, ensure they are not stuck to the windscreen (including the central area located behind the interior rear-view mirror) and the rear screen before starting the wipers (risk of motor overheating).

Check the condition of the wiper blades. You are responsible for their service life:

- they must remain clean: clean the blades, windscreen and rear screen regularly with soapy water;
- do not use them when the windscreen or rear screen are dry;
- free them from the windscreen or rear screen when they have not been used for a long time.

In all cases, replace them as soon as they begin to lose efficiency: approximately once a year.

REAR SCREEN WASH/WIPE

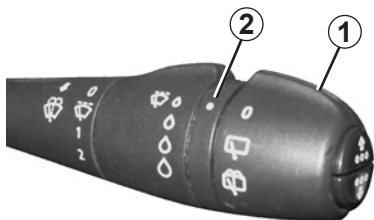

35570

Speed-dependent timed rear screen wiper

With the ignition on, turn the end of stalk **1** to align mark **2** with the symbol. Wiping frequency varies with speed.



Before any action on the windscreen (washing the vehicle, de-icing, cleaning the windscreen, etc.) return stalk **1** to the park position.

Risk of injury or damage.

Rear screen wash/wipe

With ignition on, turn the end of the stalk **1** to bring the mark **2** in line with the symbol. When the stalk is released, it returns to the rear windscreen wiper position.

A short pull triggers the rear windscreen wipers.

A prolonged action triggers, in addition to the rear windscreen wipers, a continuous sweep until the stalk is released, then two return wipes followed by a third, after a few seconds.

Special note

If the windscreen wipers are operating or are in automatic mode, the rear screen wiper wipes intermittently when reverse gear is engaged.

Depending on the vehicle, you can deactivate this function on the touch screen. Please see the equipment instructions for further information.

In freezing or snowy weather, ensure they are not stuck to the windscreen (including the central area located behind the interior rear-view mirror) and the rear screen before starting the wipers (risk of motor overheating).

Check the condition of the wiper blades. You are responsible for their service life:

- they must remain clean: clean the blades, windscreen and rear screen regularly with soapy water;
- do not use them when the windscreen or rear screen are dry;
- free them from the windscreen or rear screen when they have not been used for a long time.

In all cases, replace them as soon as they begin to lose efficiency: approximately once a year.

Before using the rear wiper, check that no object obstructs the travel of the blade.

Do not use the wiper arm to open or close the tailgate.

FUEL TANK (1/3)

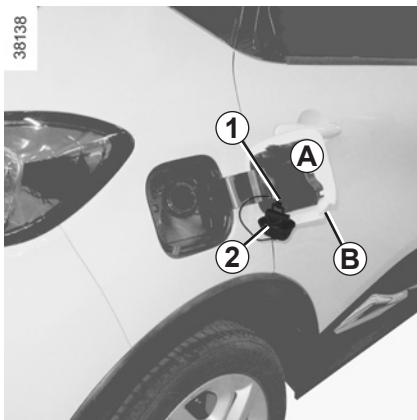

Useful capacity of fuel tank: approx. 45 litres.

The engine **0,9 TCe** has a fuel tank capacity of **40 litres** or **45 litres** (depending on the vehicle).

To open cover **A**, place your finger into recess **B**.

When filling, use the cap holder **1** on the cover **A** to secure the cap **2**.

After filling, check that the cap and cover are closed.

Fuel grade

Use a high-grade fuel that complies with the legislation in force in each country and which **must** comply with the specifications given on the label on the cover **A**. Please refer to the information on “Engine specifications” in Section 6.

Diesel version

Only use diesel fuel which complies with the information on the label located inside the cover **A**.



Fuel filler cap: this is specific.

If you have to replace it, make sure it is identical to the original cap. Contact an approved Dealer. Never place the cap near a source of heat or flame.

Do not wash the filler area with a high-pressure washer.

Petrol version

It is **essential** to use unleaded petrol. The octane rating (RON) must comply with the information given on the label on the cover **A**. Refer to Section 6 for information on “Engine specifications”.



Do not mix even small amounts of petrol (unleaded or E85) with diesel.

Do not use ethanol-based fuel if your vehicle is not compatible with this fuel.

Do not add additive to the fuel – otherwise you risk damaging the engine.

FUEL TANK (2/3)

Filling with fuel

With the ignition off, insert the nozzle and insert it **fully** before turning it on to fill the fuel tank (risk of splashing).

Keep the nozzle in this position throughout the entire filling operation.

When the pump cuts out automatically at the end of the filling procedure, a maximum of two further filling attempts may be made, as there must be sufficient space in the fuel tank to allow for expansion.

Make sure that no water enters the fuel tank during filling. The cover **A** and its surround must remain clean.

Petrol versions

Using leaded petrol will damage the antipollution system and may lead to a loss of warranty.

To ensure that the fuel tank is not filled with leaded petrol, the fuel tank filler neck contains a restrictor fitted with a foolproof system which **only allows the nozzle for unleaded petrol to be used** (at the pump).



Vehicle fitted with the Stop and Start function

To fill up with fuel, the engine must be stopped (and not on standby): stop the engine by pressing the engine stop button **3** (please refer to the information on “Starting and Stopping the engine” in Section 2).



Persistent fuel odour

If you notice a persistent fuel odour you should:

- stop the vehicle as soon as traffic conditions allow and switch off the ignition;
- switch on the hazard warning lights and ask your passengers to leave the vehicle and stay clear of the traffic;
- contact an approved Dealer.

FUEL TANK (3/3)

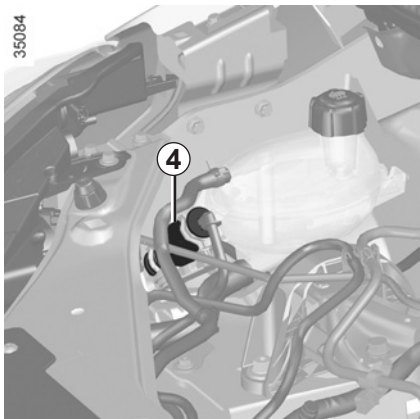

Running out of fuel on diesel versions

Vehicles with priming bulb 4

After a breakdown caused by completely running out of fuel, the system must be reprimed before the engine is restarted:

Fill the tank with at least 8 litres of diesel fuel.

Press priming bulb 4 several times.

The engine can now be restarted.

If the engine does not start after several attempts, contact an approved Dealer.



Vehicles without priming bulb 4

Insert the **RENAULT** card into the 5 card reader. Press the start button 3 without pressing any of the pedals. Wait a few minutes before starting. This will enable the fuel circuit to be primed. If the engine does not start, repeat the procedure.



No modifications whatsoever are permitted on any part of the fuel supply system (electronic units, wiring, fuel circuit, injectors, protective covers, etc.) as this may be dangerous (unless undertaken by qualified Network personnel).



The engine may be hot when working in close proximity. In addition, the engine cooling fan may come on at any moment.
Risk of injury.

Section 2: Driving

(Advice on use relating to fuel economy and the environment)

Running in	2.2
Starting, stopping the engine.	2.3
Stop and Start Function.	2.6
Special features of petrol versions	2.9
Special features of diesel versions	2.10
Gear lever/Handbrake	2.11
Eco-driving.	2.12
Advice: antipollution and fuel economy.	2.14
Environment	2.17
Driver correction devices and aids	2.18
Speed limiter	2.22
Cruise control	2.25
Parking distance control	2.29
Reversing camera	2.31
Automatic gearbox.	2.33

RUNNING IN

Petrol version

For the first **600 miles** (1,000 km), do not exceed 78 mph (130 km/h) in the highest gear, or 3,000 to 3,500 rpm.

You may only expect top performance from your vehicle after approximately **1,800 miles (3,000 km)**.

Service intervals: refer to the Maintenance Document for your vehicle.

Diesel version

For the first **1,000 miles (1,500 km)**, do not exceed 80 mph (130 km/h) in the highest gear, or 2,500 rpm. After completing this mileage you may drive faster, although you may only expect top performance after approximately 3,600 miles (6,000 km).

During the running in period, do not accelerate hard while the engine is still cold and do not let the engine over-rev.

Service intervals: refer to the Maintenance Document for your vehicle.

STARTING/STOPPING THE ENGINE (1/3)



Remote control RENAULT card

When you get into the vehicle, insert the RENAULT card integrated key, pointing towards you, fully into the card reader **2**.

To start, press button **1**. If a gear is engaged, depress the clutch pedal to start the vehicle.



Hands-free RENAULT card

The RENAULT card must be inserted in card reader **2** or in detection zone **3**.

To start, depress the brake or clutch pedal and press button **1**. If a gear is engaged, the vehicle may only be started by depressing the clutch pedal.

Starting with the boot open in hands-free mode

In this case, the RENAULT card must not be located in the luggage compartment.

Special features

vehicles with an automatic gearbox

The lever should be in position **P**.

All vehicles

- If one of starting conditions is not applied, the message “PRESS BRAKE + START” or “PRESS CLUTCH + START” or “GEAR LEVER TO P” is displayed on the instrument panel;
- in some cases, it will be necessary to move the steering wheel whilst pressing the start button **1** to help unlock the steering column; the message “TURN STEERINGWHEEL + START” will warn you of this;
- in the event of starting the engine in very low exterior temperatures (lower than -10°C): hold down the clutch pedal until the engine starts.

38166

STARTING/STOPPING THE ENGINE (2/3)



Accessories function

(switching on the ignition)

Once you have gained access to your vehicle, you may use some of its functions (radio, navigation, wipers, etc.).

For other functions:

- **vehicles with remote control RENAULT card**, insert the card into reader 2;
- **vehicles with a RENAULT “hands-free” card**, with the card in the passenger compartment or inserted in the card reader 2, press button 1 without depressing the pedals.

Note: depending on the vehicle, pressing button 1 starts the engine.

Operating faults

In certain cases, the hands-free RENAULT card may not work:

- when the RENAULT card battery is drained, flat battery, etc.
- near to appliances operating on the same frequency as the card (monitor, mobile phone, video game, etc.);
- vehicle located in a high electromagnetic radiation zone.

The message “PLEASE INSERT KEYCARD” appears on the instrument panel.

Insert the RENAULT card fully into card reader 2.



Never leave your vehicle with the RENAULT card in the reader or in the passenger compartment while there is a child (or an animal) in the vehicle, even for a short while.

They may pose a risk to themselves or to others by starting the engine.

Risk of serious injury.

STARTING/STOPPING THE ENGINE (3/3)



Conditions for stopping the engine

The vehicle must stationary, with the lever positioned in **N** or **P** for vehicles with an automatic transmission.

Remote control RENAULT card

With the card in reader **2**, press button **1**: the engine will stop. Removing the card from the reader locks the steering column.

Special note

If the card is no longer in the reader when you try to switch the engine off, the message “NO KEYCARD PRESS AND HOLD” will appear on the instrument panel: press the button **1** for longer than two seconds.

Hands-free RENAULT card

With the card in the vehicle, press button **1**: the engine will stop. The steering column is locked when the driver's door is opened or the vehicle is locked.

If the card is no longer in the passenger compartment when you try to switch the engine off, the message “NO KEYCARD PRESS AND HOLD” appears on the instrument panel: press the button **1** for longer than two seconds.

With the engine switched off, any accessories being used (radio, etc.) will continue to function for approximately 10 minutes.

When the driver's door is opened, the accessories stop working.



When you leave your vehicle, especially if you have your RENAULT card with you, check that the engine is completely switched off.



Never leave your vehicle with the RENAULT card inside and never leave a child (or a pet) unsupervised, even for a short while.

There is a risk that they could start the engine or operate electrical equipment (electric windows etc.) and trap part of their body (neck, arms, hands, etc.).
Risk of serious injury.

Never switch off the ignition before the vehicle has stopped completely. Once the engine has stopped, the brake servo, power-assisted steering, etc. and the passive safety devices such as air bags and pretensioners will no longer operate.

STOP AND START function (1/3)

This system enables a reduced fuel consumption and lower greenhouse gas emissions.

The system is activated automatically when the vehicle is started.

While driving, the system stops the engine (standby) when the vehicle is at a standstill (traffic jam, traffic lights, etc).

System operating conditions

Engine standby is activated if:

- the vehicle has been driven since its last stop;
 - the gearbox is in neutral;
 - the clutch pedal is released;
- and
- the vehicle is travelling at less than 3 km/h.



Do not drive off when the engine is on standby (warning light  is displayed on the instrument panel).

Warning light  is displayed on the instrument panel. This notifies you that the engine is on standby.

The vehicle equipment remain operational while the engine is stopped.

The engine will restart as soon as you press the clutch pedal and move into gear.

If you get out of the vehicle, a beep and the message “IGNITION OFF” notifies you that the engine is on standby and has not been switched off.



Before getting out of the vehicle, you must switch off the ignition by pressing the engine stop (please see “Starting, stopping the engine”).

Special feature of the automatic engine re-start

Under certain conditions, the engine can restart on its own in order to guarantee your safety and comfort.

This can occur especially when:

- the outdoor temperature is too low or too high (less than around 0 °C or higher than around 30 °C);
- the “Clear View” function is activated (please see the information on “Air conditioning” in Section 3);
- the battery is not sufficiently charged;
- the vehicle speed is above 7 km/h (downhill slope, etc.);
- repeated pressing on the brake pedal or braking system requirement;
- ...

Special note: when opening the passenger side door, some of these conditions prevent the engine from automatically restarting.



Engine on standby - braking assistance is no longer operational.

STOP AND START function (2/3)

Conditions preventing the standby of the engine

Depending on the vehicle, certain conditions prevent the system from using the engine standby function, including when:

- reverse gear is engaged;
- the bonnet is not locked;
- the driver's door is not closed;
- the driver's seatbelt is not fastened;
- the outdoor temperature is too low or too high (less than around 0 °C or higher than around 30 °C);
- the battery is not sufficiently charged;
- the difference between the vehicle interior temperature and the automatic climate control instruction is too high;

- the “Clear View” function is activated (please see the information on “Air conditioning” in Section 3);
 - the engine coolant temperature is too low;
 - automatic particle filter cleaning is underway;
- or
- ...

The message “AUTOSTOP UNAVAILABLE” on the instrument panel indicates that the engine is on standby.

To fill up with fuel, the engine must be stopped (and not on standby): always stop the engine by pressing the engine stop button (please see “Starting, stopping the engine”).

Special cases

- Depending on the vehicle, while the system is operating and the engine is stopped (traffic jam, traffic lights, etc.), if the driver gets out of their seat or unfastens their seatbelt and opens the driver's door, the ignition will be switched off. To restart and reactivate the Stop and Start system, press the start button (please see “Starting, stopping the engine”).
- In the event of the engine stalling, if the system is operational, press down the clutch pedal as far as it will go to restart.



Deactivate the Stop and Start function for any operation performed in the engine compartment.

STOP AND START function (3/3)

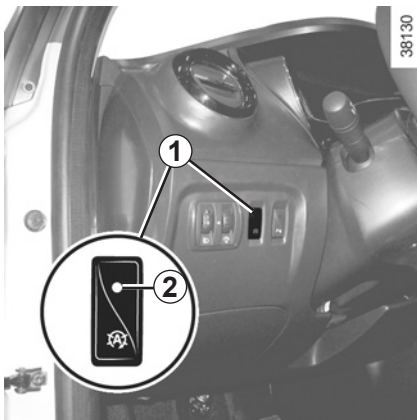

Deactivating, activating the function

Press **1** to deactivate the function. The message “STOP AND START DEACTIVATED” will appear on the instrument panel and the integrated warning light **2** on the switch will light up.

Pressing this again will reactivate the system. The message “STOP AND START ACTIVATED” will appear on the instrument panel and the integrated warning light **2** on switch **1** will go out.

The system is automatically reactivated each time the vehicle is started using the start button (please see “Starting, stopping the engine”).

Special note: engine on standby, press switch **1** to automatically restart the engine.

Operating faults

When the message “CHECK STOP AND START” appears on the instrument panel and the integrated warning light **2** lights up on the switch **1**, the system is deactivated.

Please consult an authorised dealer.



Before getting out of the vehicle, you must switch off the ignition by pressing the engine stop (please see “Starting, stopping the engine”).



In the event of an emergency, the engine can be restarted by pressing on the clutch pedal if the Stop and Start function is activated.

SPECIAL FEATURES OF PETROL VERSIONS

The following operating conditions:

- driving for long periods when the low fuel level warning light is lit;
- using leaded petrol;
- using fuel or lubrication additives which are not approved.

Or operating faults such as:

- faulty ignition system, running out of fuel or disconnected spark plugs resulting in the engine misfiring or cutting out when driving;
- loss of power,

as they may cause the catalytic converter to overheat and thus reduce its efficiency, **or damage it irreparably and cause heat damage to the vehicle.**

If you notice any of the above operating faults, have the necessary repairs carried out as soon as possible by an approved Dealer.

These faults may be avoided by regularly taking your vehicle to an approved Dealer at the intervals specified in the Maintenance document.

Starting problems

To avoid damaging the catalytic converter, **do not keep** trying to start the engine (using the start button, or by pushing or towing the vehicle) **without having identified and corrected the starting fault.**

If the fault cannot be identified, do not keep trying to start the engine, but contact an approved Dealer.





Do not park the vehicle or run the engine in locations where combustible substances or materials such as grass or leaves can come into contact with the hot exhaust system.

SPECIAL FEATURES OF DIESEL VERSIONS

Diesel engine speed

Diesel engines are fitted with injection equipment **which prevents the engine speed being exceeded** irrespective of the gear selected.

If the message “Check antipollution system” is displayed along with warn-

ing lights  and , consult an authorised dealer immediately.

When driving, depending on the fuel grade used, it is possible that white smoke may be emitted.

This is due to the exhaust particle filter being cleaned automatically, and does not affect the way the vehicle runs.

Running out of fuel

If the **tank has been completely drained**, the system must be reprimed after the tank is refilled: see information on the “fuel tank” in section 1 before re-starting the engine.

Precautions to be taken in winter

To avoid any faults in icy weather:

- ensure that the battery is always fully charged,
- always keep the diesel tank relatively full to avoid water vapour condensing in it and accumulating at the bottom of the tank.



Do not park the vehicle or run the engine in locations where combustible substances or materials such as grass or leaves can come into contact with the hot exhaust system.

GEAR LEVER/HANDBRAKE

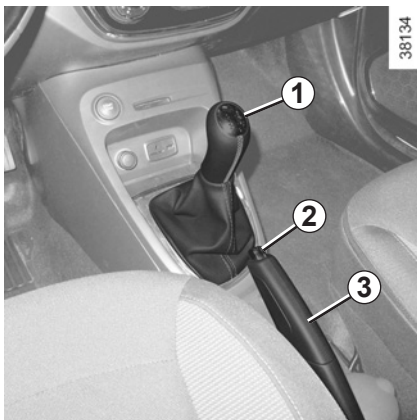

Gear lever

Selecting reverse gear

Vehicles with manual gearbox: refer to the grid on the gear lever knob **1**.

Vehicles with automatic gearbox: refer to the information on the “Automatic gearbox” in Section 2.

The reversing lights will come on as soon as reverse gear is selected with the ignition on.

Handbrake

To release:

Pull the lever **3** up slightly, press button **2** and then lower the lever to the floor.

The red warning light on the instrument panel will come on if you are driving with an incorrectly released handbrake.

To apply:

Pull lever **3** upwards. Check that the vehicle is immobilised. The warning light  on the instrument panel will come on.



An impact to the underside of the vehicle while manoeuvring (e.g.: striking a post, raised kerb or other street furniture) may result in damage to the vehicle (e.g.: deformation of an axle).

To avoid any risk of accident, have your vehicle checked by an approved Dealer.



Make sure that the handbrake is properly released when driving (red indicator light off), otherwise overheating, or even damage, may occur.



When stationary, and depending on the slope and/or vehicle load, it may be necessary to pull up the handbrake at least two extra notches and engage a gear (1st or reverse gear) for vehicles with a manual gearbox or position **P** for vehicles with an automatic gearbox.

ECO-DRIVING (1/2)



Depending on the vehicle, you will have various functions which enable you to lower your fuel consumption:

- the rev counter;
- the gear change indicator;
- the driving style indicator;
- the journey record and eco-driving advice via the multimedia display;
- ECO mode – activated by the ECO button.

If fitted on the vehicle, the navigation system provides additional information.

Gear change indicator 1

Depending on the vehicle, to obtain optimum consumption levels, a warning light on the instrument panel lets you know the best time to move up or down a gear:

-  move up a gear;
-  move down a gear.



Driving style indicator 2

Informs you about the driving style adopted in real time. You will be notified by the colour of warning light 2.

- Green: measured, economical driving;
- Yellow: opt for a calmer driving style;
- Orange: driving too fast.

The driving style indicator is activated by default. If you wish to deactivate it, please see the multimedia system instructions.



Journey record

Once the engine is switched off, you will see “Journey record” displayed on the screen 3, enabling you to view information relating to your last journey.

This indicates:

- average fuel consumption;
- total consumption;
- number of miles/kilometres travelled;
- number of miles/kilometres saved.

An overall statement on your eco-driving performance is displayed, along with three indices detailing: the results for the gear changes, acceleration management and the management of your anticipation and braking.

ECO-DRIVING (2/2)



ECO mode

ECO mode is a function which optimises fuel consumption. It acts on all elements which consume fuel (engine power, heating and/or air conditioning, etc).

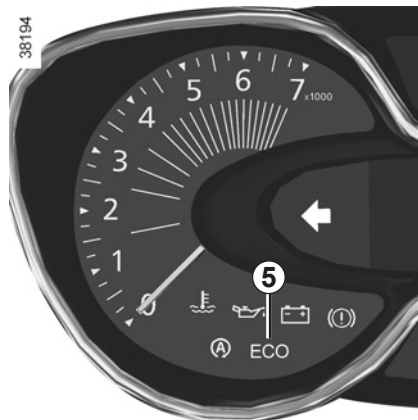

Activating the function

Press switch **4**.

The **5 ECO** warning light comes on on the instrument panel to confirm activation.

While driving, it is possible to leave the ECO mode temporarily in order to improve engine performance.

To do so, press down firmly and fully on the accelerator pedal; the **5 ECO** light will flash on the instrument panel.

The ECO mode is reactivated once you relax the accelerator pedal, the **5**

ECO light will remain lit on the instrument panel.

Disabling the function

Press switch **4**.

The **5 ECO** light goes out on the instrument panel to confirm deactivation.

ADVICE: antipollution, fuel economy and driving (1/3)

Your vehicle complies with criteria for recycling and recovering vehicles at the end of their service life which will come into force in 2015.

Some parts of your vehicle have therefore been designed to facilitate future recycling.

These parts are easy to remove so that they can be recovered and reprocessed by recycling companies.

By virtue of its design, moderate fuel consumption and initial settings, your vehicle also conforms to current antipollution regulations. The manufacturer is actively striving to reduce pollutant exhaust gas emissions and to save energy. But the fuel consumption of your vehicle and the level of pollutant exhaust gas emissions are also your responsibility. Ensure that it is maintained and used correctly.

Aiding fuel economy

Depending on the vehicle, in order to optimise consumption, an indicator light on the instrument panel will inform you of the best moment to upshift or downshift gears:



move up a gear;



move down a gear.

Maintenance

It is important to remember that failure to respect antipollution regulations could lead to legal action being taken against the vehicle owner. In addition, replacing engine, fuel supply system and exhaust components with parts other than those originally recommended by the manufacturer may alter your vehicle so that it no longer complies with antipollution regulations.

Have your vehicle adjusted and checked by an approved Dealer, in accordance with the instructions given in your maintenance schedule: they will have all the equipment necessary for ensuring that your vehicle is maintained to its original standard.

Engine adjustments

- **ignition:** this does not require adjustment.
- **spark plugs:** for optimum fuel economy, efficiency and performance the specifications laid down by our Design Department must be strictly applied.

If the spark plugs have to be changed, use the make, type and gap specified for your vehicle's engine. Contact an approved dealer for this.

- **idle:** this does not require adjustment.
- **air filter, diesel filter:** a clogged element reduces performance. It must be replaced.

ADVICE: antipollution, fuel economy and driving (2/3)

Exhaust gas monitoring system

The exhaust gas monitoring system will detect any operating faults in the vehicle's antipollution system.

If this system malfunctions, toxic substances may be released into the atmosphere or damage may occur.



This warning light on the instrument panel will indicate if there are any faults in the system:

This lights up when the ignition is switched on and goes out when the engine is started.

- If it lights up continuously, consult an approved Dealer as soon as possible;
- if it flashes, reduce the engine speed until the light stops flashing. Contact your approved dealer as soon as possible.

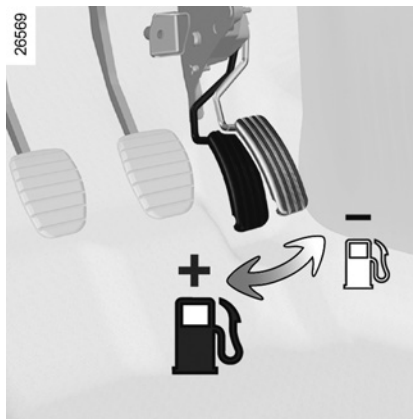

Driving

- Drive carefully for the first few miles until the engine reaches its normal operating temperature, rather than let it warm up while the vehicle is stationary.
- Speed is expensive.
- Sporty driving uses a lot of fuel: drive with a light right foot.
- Do not overrev the engine in the intermediate gears.
Always use the highest gear possible without labouring the engine.
- Avoid sudden acceleration.

- Brake as little as possible. If you anticipate an obstacle or bend in advance, you may then simply release the accelerator pedal.
- Do not try to maintain the same speed up a hill, accelerate no more than you would on the level. Keep your foot in the same position on the accelerator pedal.
- Double declutching and accelerating before switching off are unnecessary in modern vehicles.
- Bad weather, flooded roads:



Do not drive through floods if the water is above the lower edge of the wheel rims.



Obstructions to the driver

On the driver's side, only use mats adapted to the vehicle that attach to the pre-installed parts, and regularly check their mounting. Do not place several mats on top of each other.

There is a risk of wedging the pedals

ADVICE: antipollution, fuel economy and driving (3/3)

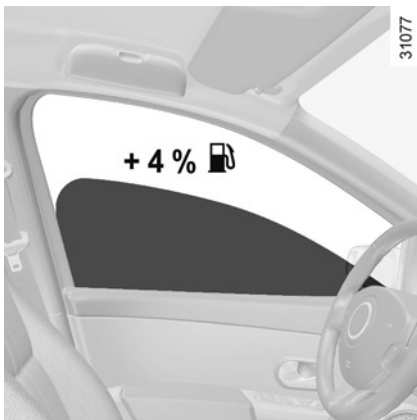

Advice on use

- Electricity is fuel; switch off all the electrical components which are not really needed. **However** (safety first), keep your lights on when the visibility is bad (“see and be seen”).
- Use the air vents. Driving with the windows open at 60 mph (100 km/h) will increase fuel consumption by 4%.

- In vehicles fitted with air conditioning, it is normal to observe an increase in fuel consumption (especially in urban conditions) when it is used. For vehicles fitted with manual air conditioning, switch off the system when it is not required.

Advice for reducing consumption and therefore helping to preserve the environment:

If the vehicle has been parked in the sun, open the doors for a few moments to let the hot air escape before starting the engine.

- Never fill the fuel tank right to the brim to avoid overflow.
- Do not leave an empty roof rack fitted to the vehicle.
- Favour ECO mode. Refer to the information on “Eco-driving”.

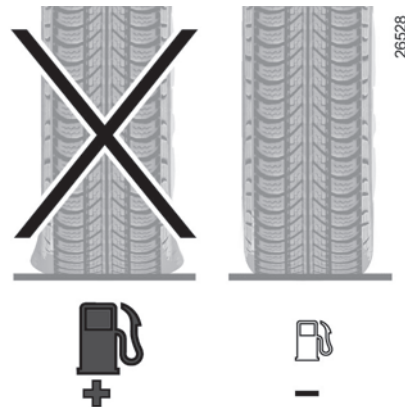

- It is better to fit a trailer for bulky objects.
- When towing a caravan, fit a wind deflector and adjust it carefully.
- Avoid using the car for door-to-door calls (short journeys with long waits in between) because the engine never reaches its normal operating temperature.

Tyres

- An underinflated tyre increases fuel consumption.
- The use of non-recommended tyres can increase fuel consumption.

ENVIRONMENT

Your vehicle has been designed with respect for the **environment** in mind for its entire service life: during production, use and at the end of its life.

This commitment is illustrated by the of the manufacturer eco² signature.

Manufacture

Your vehicle has been manufactured at a factory which complies with a policy to reduce the environmental impact on the surrounding areas (reduction of water and energy consumption, visual and noise pollution, atmospheric emissions and waste water; sorting and re-using waste).

Emissions

Your vehicle has been designed to emit fewer greenhouse gases (CO₂) while in use, and therefore to consume less fuel (eg. 140 g/km, equivalent to 5.3 l/100 km for a diesel vehicle).

Our vehicles are also equipped with a particle filter system including a catalytic converter, an oxygen sensor and an active carbon filter (the latter prevents vapour from the fuel tank being released into the open air).

For certain diesel vehicles, this system also has a particle filter to reduce the volume of soot particles emitted.

Please make your own contribution towards protecting the environment too

- Worn parts replaced in the course of routine vehicle maintenance (vehicle battery, oil filter, air filter, batteries, etc.) and oil containers (empty or filled with used oil) must be disposed of through specialist organisations.

- At the end of the vehicle's service life, it should be sent to approved centres to ensure that it is recycled.
- In all cases, comply with local legislation.

Recycling

Your vehicle is 85% recyclable and 95% recoverable.

To achieve these objectives, many of the vehicle components have been designed to enable them to be recycled. The materials and structures have been carefully designed to allow these components to be easily removed and reprocessed by specialist companies.

In order to preserve raw material resources, this vehicle incorporates numerous parts made from recycled plastics or renewable materials (vegetable or animal-derived materials such as cotton or wool).

DRIVER CORRECTION DEVICES AND AIDS (1/4)

Depending on the vehicle, this is composed of:

- **anti-lock braking system (ABS);**
- **electronic stability control (ESC) with understeer control and traction control (ASR);**
- **emergency brake assist;**
- **hill start assistance.**



These functions are an additional aid in the event of critical driving conditions, enabling the vehicle behaviour to be adapted to suit the driving conditions.

However, the functions do not take the place of the driver. **They do not increase the vehicle's limits and should not encourage you to drive more quickly.** Therefore, they can under no circumstances replace the vigilance or responsibility of the driver when manoeuvring the vehicle (the driver must always be ready for sudden incidents which may occur when driving).

Anti-lock braking system (ABS)







Under heavy braking, the ABS prevents the wheels from locking, allowing the stopping distance to be managed and keeping control of the vehicle.

Under these circumstances, the vehicle can be steered to avoid an obstacle whilst braking. In addition, this system can increase stopping distances, particularly on roads with low surface grip (wet ground etc.).

You will feel a pulsation through the brake pedal each time the system is activated. The ABS does not in any way improve the vehicle's physical performance relating to the road surface and road-holding. It is still **essential** to follow the rules of good driving practice (such as driving at a safe distance from the vehicle in front etc.).

In an emergency, apply **firm and continuous pressure** to the brake pedal. There is no need to pump it repeatedly. The ABS will modulate the force applied in the braking system.

Operating faults:

-  and  lit up on the instrument panel alongside messages "CHECK ABS", "CHECK BRAKING SYSTEM" and "CHECK ESC": ABS, ESC and emergency brake assist are deactivated. **Braking is always enabled;**
-  ,  ,  and  lit up on the instrument panel alongside the message "BRAKING SYSTEM FAULT": **this indicates a fault in the braking system.**

In both cases, consult an approved Dealer.



Your braking systems are partially operational. However, it is **dangerous to brake suddenly** and it is essential to stop immediately, as soon as traffic conditions allow. Contact an approved dealer.

DRIVER CORRECTION DEVICES AND AIDS (2/4)

Electronic stability program (ESC) with understeer control and traction control (ASR)

Electronic stability control ESC

This system helps you to keep control of the vehicle in critical driving conditions (avoiding an obstacle, loss of grip on a bend, etc.).

Operating principle

A sensor in the steering wheel detects the direction selected by the driver.

Other sensors throughout the vehicle measure the actual direction.

The system compares driver input to the actual trajectory of the vehicle and corrects the trajectory if necessary by controlling the braking of certain wheels and/or engine power. In the event that the system is engaged, indicator light



flashes on the instrument panel.

Understeer control

This system optimises the action of the ESC in the case of pronounced understeer (loss of front axle road holding).

Traction control ASR

This system helps to limit wheelspin of the drive wheels and to control the vehicle when pulling away accelerating or decelerating.

Operating principle

Using the wheel sensors, the system measures and compares the speed of the drive wheels at all times and slows down their over-rotation. If a wheel is starting to slip, the system brakes automatically until the drive supplied becomes compatible with the level of grip under the wheel again.

The system also adjusts the engine speed to the grip available under the wheels, independently of the pressure exerted on the accelerator pedal.

Operating faults

When the system detects an operating fault the message “CHECK ESC” and

warning light  and  appear on the instrument panel. In this case, the ESC and ASR are deactivated.

Consult an approved dealer.

Disabling the ASR function

In some situations (driving on very wet ground: snow, mud, etc. or driving with snow chains fitted), the system may reduce the engine output to limit wheel-spin.

DRIVER CORRECTION DEVICES AND AIDS (3/4)

Emergency brake assist

This system supplements the ABS and helps reduce vehicle stopping distances.

Operating principle

The system allows an emergency braking situation to be detected when the brake pedal is pressed. In this case, the braking assistance immediately develops maximum power and may trigger ABS regulation.

ABS braking is maintained as long as the brake pedal is applied.

Hazard warning lights switching on

Depending on the vehicle, these may light up in the event of sudden deceleration.

Braking anticipation

Depending on the vehicle, when you rapidly release the accelerator, the system anticipates the braking manoeuvre in order to reduce stopping distances.

When using the cruise control:

- if you use the accelerator, when you release it, the system may be triggered;
- if you do not use the accelerator, the system will not be triggered.

Operating faults

When the system detects an operating fault the message “CHECK BRAKING SYSTEM” appears on the instrument panel along with the  warning light.

Consult an approved dealer.



These functions are an additional aid in the event of critical driving conditions, enabling the vehicle behaviour to be adapted to suit the driving conditions.

However, the functions do not take the place of the driver. **They do not increase the vehicle's limits and should not encourage you to drive more quickly.** Therefore, they can under no circumstances replace the vigilance or responsibility of the driver when manoeuvring the vehicle (the driver must always be ready for sudden incidents which may occur when driving).

DRIVER CORRECTION DEVICES AND AIDS (4/4)

Hill start assistance

This function assists the driver when starting on hills. It prevents the vehicle from rolling backwards, depending on the slope, by automatically applying the brakes when the driver lifts his/her foot off the brake pedal to depress the accelerator pedal.

System operation

It only operates when the gear lever is in a position other than neutral (other than **N** or **P** for automatic transmissions) and the vehicle is completely stationary (brake pedal depressed)

The system holds the vehicle for approximately **2 seconds**. The brakes are then gradually released (the vehicle will move according to the slope).



The hill start assistance system cannot completely prevent the vehicle from rolling backwards in all situations (extremely steep gradients, etc.).

In all cases, the driver may depress the brake pedal to prevent the vehicle from rolling forwards or backwards.

The hill start assistance function should not be used for prolonged stops: use the brake pedal.

This function is not designed to immobilise the vehicle permanently.

If necessary, use the brake pedal to stop the vehicle.

The driver must remain particularly vigilant when driving on slippery or low-grip surfaces and/or on hills.

Risk of serious injury.

CRUISE CONTROL/SPEED LIMITER: speed limiter function (1/3)

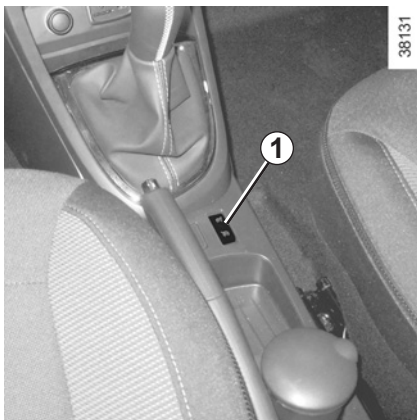

The speed limiter function helps you stay within the driving speed limit that you choose, known as the **limit speed**.

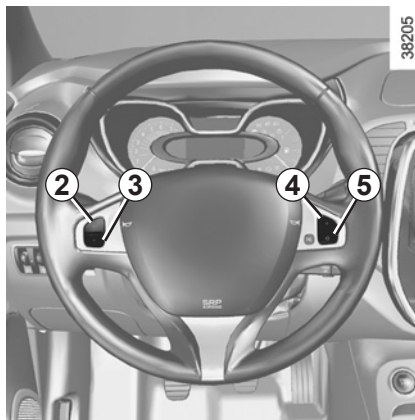

Controls

- 1 Main “On/Off” switch.
- 2 Limit speed activation, storage and increase switch (+).
- 3 Decreasing the limit speed (-).
- 4 Activation and recall of memorised limit speed (R).
- 5 Speed limiter function standby (with limited speed memory) (O).

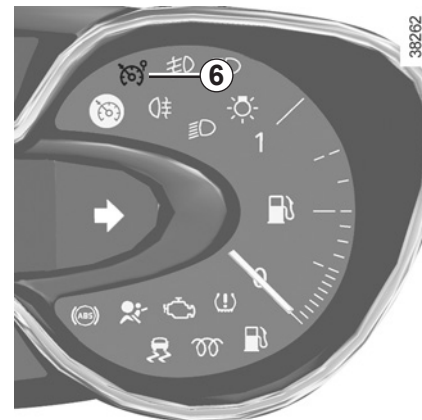

Switching on

Press the side switch **1** . Indicator light **6** comes on, lit orange, and the message “SPEED LIMITER” appears on the instrument panel, accompanied by dashes to indicate that the speed limiter function is activated and waiting to store a limited speed.

To store the current speed, press switch **2** (+): the limited speed will replace the dashes.

The minimum stored speed is 20 mph (30 km/h).

CRUISE CONTROL/SPEED LIMITER: speed limiter function (2/3)

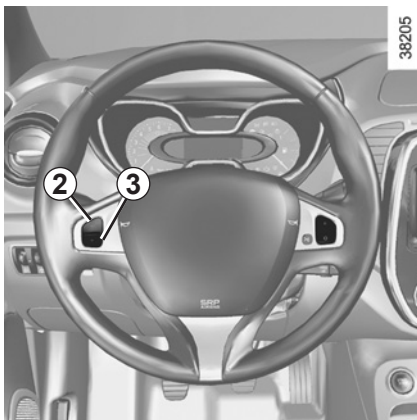

Driving

When a limited speed has been stored and this speed is not reached, driving is similar to driving a vehicle without the speed limiter function.

Once you have reached the stored speed, no effort on the accelerator pedal will allow you to exceed the programmed speed except in an emergency (refer to information on “Exceeding the limit speed”).

Varying the limit speed

The limit speed may be changed by repeatedly pressing:

- switch **2** (+) to increase speed;
- switch **3** (-) to reduce speed.

Exceeding the limit speed

It is possible to exceed the limit speed at any time. To do this: press the accelerator pedal **firmly and fully** (beyond the resistance point).

If the speed is exceeded, the limited speed flashes on the instrument panel accompanied by a beep.

Then, release the accelerator: the speed limiter function will return as soon as you reach a speed lower than the stored speed.

Limited speed cannot be maintained

If driving up or down a steep gradient, the system is unable to maintain the limited speed: the memorised speed flashes on the instrument panel and a beep sounds at regular intervals to inform you.



The speed limiter function is in no way linked to the braking system.

CRUISE CONTROL/SPEED LIMITER: speed limiter function (3/3)

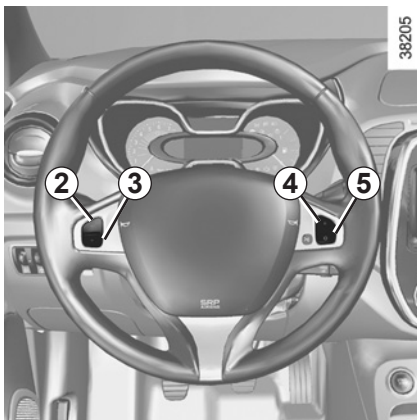

Putting the function on standby

The speed limiter function is suspended when you press switch **5** (O). In this case, the limit speed remains stored and the message “MEMORISED” accompanied by this speed appears on the instrument panel.

Recalling the limit speed

If a speed has been saved, it can be recalled by pressing switch **4** ((R)).

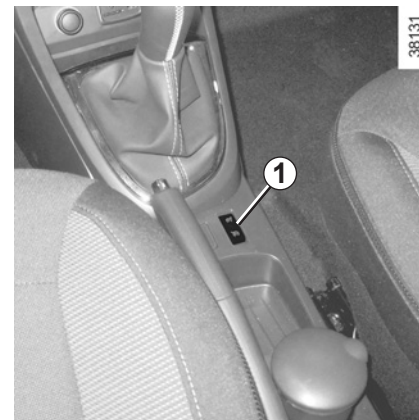

Switching off the function

The speed limiter function is deactivated if you press switch **1**: in this case a speed is no longer stored. The orange instrument panel warning light  goes out, confirming that the function is stopped.

When the speed limiter is put on standby, pressing switch **2** (+) reactivates the function without taking into account the stored speed: it is the speed at which the vehicle is moving that is taken into account.

CRUISE CONTROL/SPEED LIMITER: cruise control function (1/4)

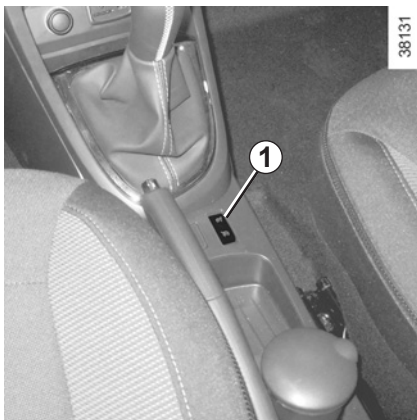

The cruise control function helps you to maintain your driving speed at a speed that you choose, called the **cruising speed**.

This cruising speed may be set at any speed above 20 mph (30 km/h).



The cruise control function is in no way linked to the braking system.



This function is an additional driving aid. However, the function does not take the place of the driver.

Therefore, it can under no circumstances replace the driver's responsibility to respect speed limits and to be vigilant (the driver must always be ready to brake).

Cruise control must not be used in heavy traffic, on undulating or slippery roads (black ice, aquaplaning, gravel) and during bad weather (fog, rain, side winds etc.).

There is a risk of accidents.

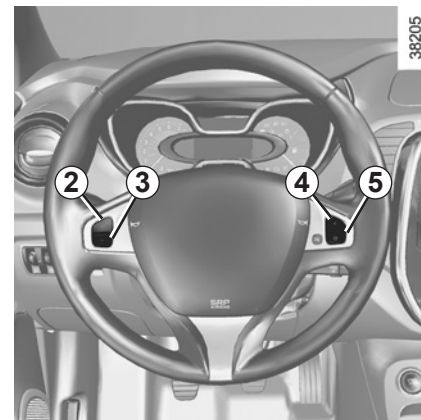

Controls

- 1 Main "On/Off" switch.
- 2 Cruising speed activation, storage and increase switch (+).
- 3 Decreasing cruising speed (-).
- 4 Activation with recall of saved cruising speed (R).
- 5 Switch the function to standby (with cruising speed saved) (O).

CRUISE CONTROL/SPEED LIMITER: cruise control function (2/4)

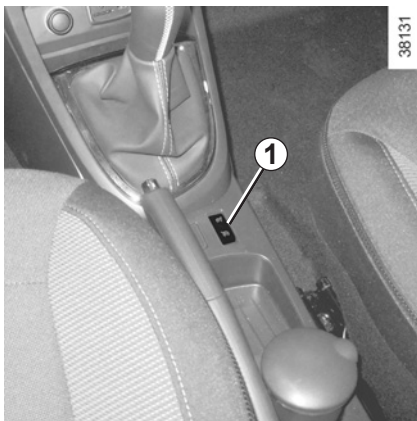

Switching on

Press switch **1** side .

Indicator light **6** comes on, lit green, and the message “CRUISE CONTROL” appears on the instrument panel, accompanied by dashes to indicate that the cruise control function is activated and waiting to store a cruising speed.

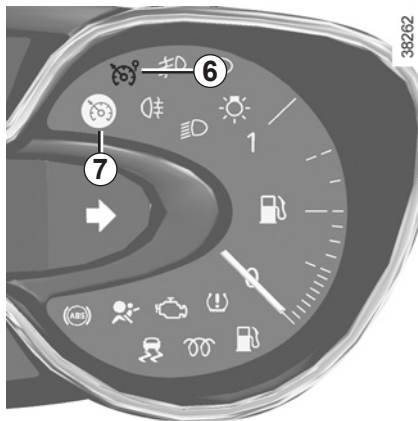

Activating cruise control

At a steady speed (above 18 mph (30 km/h approximately)) press switch **2** or (+): the function is activated and the current speed is saved.

The cruising speed replaces the dashes and the cruise control is confirmed by the appearance of warning light **7** lit green, as well as warning light **6**.

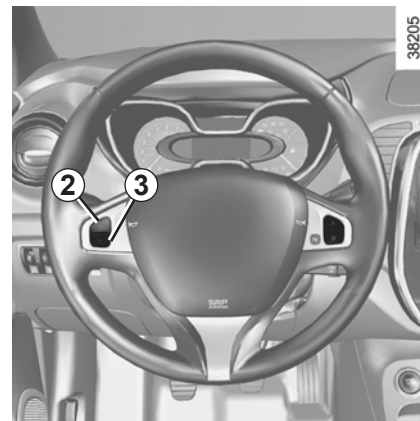

Driving

Once a cruising speed is stored and the cruise control function is active, you may lift your foot off the accelerator pedal.



Important: you are nevertheless advised to keep your feet close to the pedals in order to react if necessary.

CRUISE CONTROL/SPEED LIMITER: cruise control function (3/4)

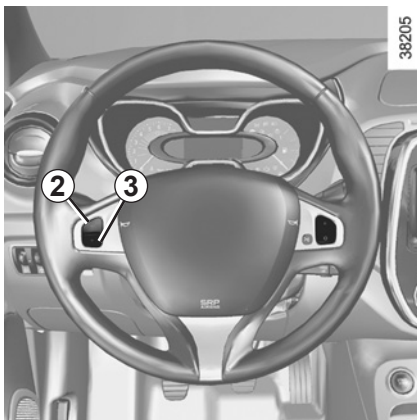

Adjusting the cruising speed

The cruising speed may be changed by pressing the following repeatedly:

- switch **2** (+) to increase the speed,
- switch **3** (-) to decrease the speed.



The cruise control function is in no way linked to the braking system.

Exceeding the cruising speed

The cruising speed may be exceeded at any time by depressing the accelerator pedal. While it is being exceeded, the cruising speed flashes on the instrument panel.

Then, release the accelerator: after a few seconds, the vehicle will automatically return to its set cruising speed.

Cruising speed cannot be maintained

When driving down a steep gradient, the system is unable to maintain the cruising speed: the stored speed will flash on the instrument panel information display to inform you of this situation.

CRUISE CONTROL/SPEED LIMITER: cruise control function (4/4)

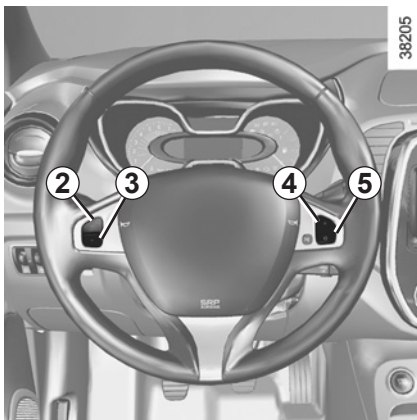

Putting the function on standby

The function is set to standby if you:

- use the switch **5** (O);
- the brake pedal;
- depress the clutch pedal or the shift into neutral if the vehicle has an automatic gearbox.

In all three cases, the cruising speed remains stored and the message “MEMORISED” appears on the instrument panel.

Standby is confirmed when indicator light  goes out.

Returning to the cruising speed

If a speed is stored, it can be recalled, once you are sure that the road conditions are suitable (traffic, road surface, weather conditions, etc.). Press switch **4** (R) if the vehicle speed is above 20 mph (30 km/h).



When the stored speed is recalled, activation of the cruise control is confirmed by the illumination of the  warning light.

NB: if the speed previously stored is much higher than the current speed, the vehicle will accelerate more rapidly to reach this threshold.

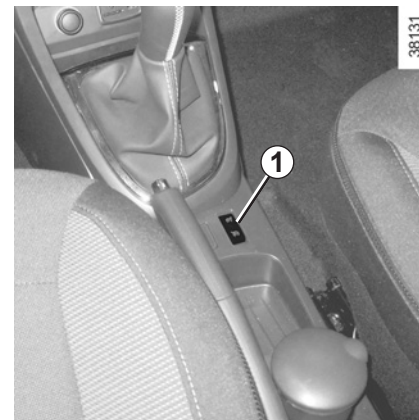
When the cruise control function is put on standby, pressing switch **2** (+) reactivates the cruise control function without taking into account the stored speed: it is the speed at which the vehicle is moving that is taken into account.



Switching off the function

The cruise control function is deactivated if you press switch **1**: in this case a speed is no longer stored. The two instrument panel warning lights  and  go out to confirm that the function is deactivated.



Putting the cruise control on standby or switching it off does not cause a rapid reduction in speed: you must brake by depressing the brake pedal.

PARKING DISTANCE CONTROL (1/2)

Operating principle

Ultrasonic detectors, installed in the rear bumper (depending on the vehicle), measure the distance between the vehicle and an obstacle whilst reversing.

This measurement is indicated by beeps which become more frequent the closer you come to the obstacle, until they become a continuous beep when the vehicle is approximately 30 centimetres from the obstacle.

NB: make sure that the ultrasonic sensors are not obscured (by dirt, mud, snow, etc.).



Note: depending on the vehicle, the screen **1** shows the vehicle surroundings alongside the beeps.

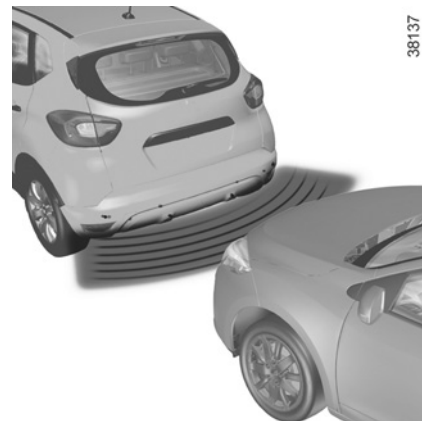

Operation

When reverse gear is selected, most objects which are less than approximately 1.20 metres from the rear of the vehicle are detected, a beep sounds and, depending on the vehicle, the display **1** comes on.



This function is an additional aid that indicates the distance between the vehicle and an obstacle whilst reversing, using sound signals.

Under no circumstances should it replace the driver's care or responsibility whilst reversing.

The driver should always look out for sudden hazards during driving: always ensure that there are no moving obstacles (such as a child, animal, pram or bicycle, etc.) or small, narrow objects such as stones or posts in your path when manoeuvring.

PARKING DISTANCE CONTROL (2/2)



Adjusting the parking distance control volume

Depending on the vehicle, certain settings can be adjusted from the touch-screen **1**. Please see the equipment instructions for further information.

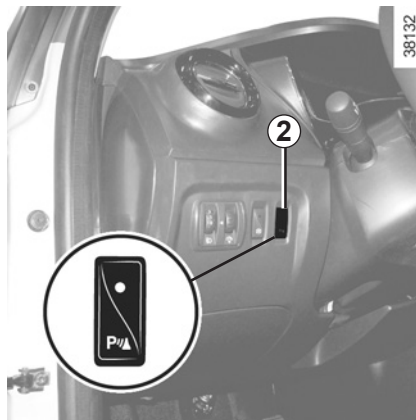

Deactivating the system

Press switch **2** to deactivate the system.

The indicator light built into the switch lights up to remind you that the system is deactivated.

Pressing the switch again will reactivate the system and switch off the indicator light.

Depending on the vehicle, you can deactivate the parking distance control from the touch-screen. Please see the equipment instructions for further information.

Operating faults

Depending on the vehicle, when the system detects an operating fault, the message “check parking distance control” appears on the instrument panel, accompanied by the warning light  and a beep lasting approximately 5 seconds. Please contact an authorised dealer.



An impact to the underside of the vehicle while manoeuvring (e.g.: striking a post, raised kerb or other street furniture) may result in damage to the vehicle (e.g.: deformation of an axle).

To avoid any risk of accident, have your vehicle checked by an approved Dealer.

REVERSING CAMERA (1/2)



Operation

When going into reverse gear (and up to around 5 seconds after shifting into another gear), the camera **1** placed next to the lights transmits a view of the rear surroundings of the vehicle on the touch screen **2**, accompanied by a mobile and fixed gauge.

This system is initially used with the aid of several gauges (mobile for trajectory and fixed for distance). When the red zone is reached, use the bumper image to stop accurately.



Note:

- ensure that the reversing camera is not obscured (dirt, mud, snow, etc.);
- depending on the vehicle, certain settings can be adjusted from the touch screen **2**. Refer to the handbook for the equipment.



This function is an additional aid. It cannot, therefore, under any circumstances replace the vigilance or the responsibility of the driver.

The driver should always pay attention to sudden incidents during driving: always ensure that there are no moving obstacles (such as a child, animal, pram, bicycle, etc.) or small, narrow objects such as stones or posts in your path when manoeuvring.

REVERSING CAMERA (2/2)

35987

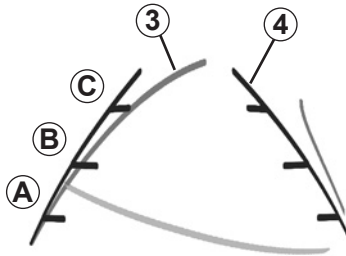

Dynamic gauge 3 (depending on the vehicle)

This is shown in blue on screen 2. It indicates the vehicle trajectory according to the position of the steering wheel.

Static guide line 4:

The fixed clearance gauge comprises coloured markers **A**, **B** and **C**, indicating the distance behind the vehicle:

- **A** (red) approximately 30 centimetres from the vehicle;
- **B** (yellow) approximately 70 centimetres from the vehicle;
- **C** (green) approximately 150 centimetres from the vehicle.

This gauge remains fixed and indicates the vehicle trajectory if the wheels are in line with the vehicle.



This function is an additional aid. It cannot, therefore, under any circumstances replace the vigilance or the responsibility of the driver.

The driver should always pay attention to sudden incidents during driving: always ensure that there are no moving obstacles (such as a child, animal, pram, bicycle, etc.) or small, narrow objects such as stones or posts in your path when manoeuvring.

The screen shows a reverse image.

The frames are a representation projected onto flat ground; this information must not be taken into account when superimposed on a vertical object or an object on the ground.

Objects which appear on the edge of the screen may be deformed.

In very bright light (snow, vehicle in sunshine etc.), the camera vision may be adversely affected.

When the boot is open or badly closed, the message "BOOT OPEN" appears and, depending on the vehicle, the camera display will disappear.

AUTOMATIC TRANSMISSION (1/3)



Selector lever 1

- P:** park
- R:** reverse
- N:** Neutral
- D:** automatic mode
- M:** manual mode
- 4:** displays the gear engaged in manual mode.



Operation

With the selection lever **1** in position **P**, switch on the ignition.

To move out of position **P**, you must depress the brake pedal before pressing the unlocking button **2**.

With the foot on the brake pedal (the warning light **3** on the display goes out), move the lever out of position **P**.

Only engage D or R when the vehicle is stopped, with your foot on the brake and the accelerator pedal released.

Driving in automatic mode

Move lever **1** to position **D**.

In most road conditions you will encounter, you will not need to touch your lever again: the gears will change automatically at the right time and at the most suitable engine speed because the automatic system takes into account the vehicle load and road contour and adjusts itself to the particular driving style you have chosen.

Economical driving

When driving, always leave the lever in position **D**, keeping the accelerator pedal lightly depressed to ensure automatic gear changes at a lower engine speed.

Accelerating and overtaking

Depress the accelerator pedal firmly and fully (so that it goes beyond the kickdown point).

This will enable you to change down to the optimum gear within the engine range.

AUTOMATIC TRANSMISSION (2/3)



Driving in manual mode

With the selection lever **1** in position **D**, move the lever to the left.

Shifting the lever repeatedly allows you to change gears manually:

- to move down through the gears, push the lever forwards;
- to move up through the gears, push the lever backwards.

The gear selected is displayed on the instrument panel.

Special cases

In certain driving conditions (for example, engine protection, operation of the Electronic Stability Programme: the automatic system may change gear automatically.

Likewise, to prevent incorrect manoeuvres, a gear change may be refused by the automatic system: in this case the gear display flashes for a few seconds as a warning.

Special circumstances

- **If the bends and road surface** do not allow you to stay in automatic mode (e.g. in the mountains), we recommend that you change to manual mode. This will prevent the automatic gearbox from changing gear repeatedly when climbing, and permit engine braking on long descents.
- **In cold weather**, start the engine and wait a few seconds before moving the selector lever from position **P** or **N** and engaging it in **D** or **R** to prevent the engine stalling.
- **Vehicles not fitted with traction control**: on a slippery surface or surface with a low level of adhesion, change to manual mode and select second gear (or even third) before starting the engine to avoid wheel-spin when accelerating.

In very cold weather, the system may prevent the gears from being shifted in manual mode until the gearbox reaches the right temperature.

AUTOMATIC TRANSMISSION (3/3)

Parking the vehicle

When the vehicle is stopped, move the lever to position **P** while keeping your foot on the brake pedal: the gearbox is in neutral and the drive wheels are mechanically locked by the driveshaft.

Apply the handbrake.



An impact to the underside of the vehicle while manoeuvring (e.g.: striking a post, raised kerb or other street furniture) may result in damage to the vehicle (e.g.: deformation of an axle).

To avoid any risk of accident, have your vehicle checked by an approved Dealer.

Operating faults

– **when driving**, if the ‘check gearbox’ message appears on the instrument panel, it indicates a fault.

Contact your approved Dealer as soon as possible;

– **when driving**, if the message “gearbox overheating” appears on the instrument panel, avoid leaving the lever in position **D** (or **R**) where traffic conditions allow: always return to **N** while the vehicle is stationary.

Contact your approved Dealer as soon as possible;

– **If a vehicle with an automatic gearbox breaks down**, refer to the information on “Towing” in Section 5.



For safety reasons, do not switch off the ignition before the vehicle has come to a complete standstill.

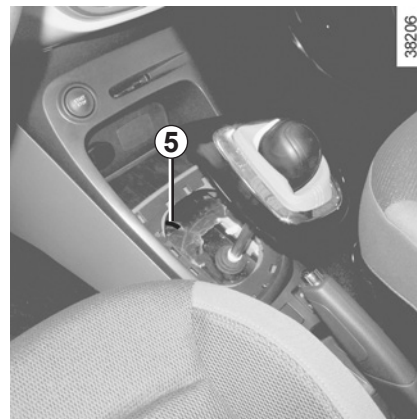

When setting off, if the lever is locked in position **P** even though you are pressing the brake pedal, the lever can be released manually. For this, unclip the base of the lever then insert a tool (with a hard rod to it) into the slot **5** to unlock the lever.

Contact an authorised dealer as soon as possible.



Section 3: Your comfort

Air vents	3.2
Manual air conditioning and heating system	3.4
Automatic climate control	3.7
Air conditioning: information and advice on use	3.11
Electric windows	3.12
Interior lighting	3.14
Passenger compartment storage space and fittings	3.15
Sun visor	3.19
Ashtray, cigarette lighter	3.20
Sliding rear bench seat	3.22
Boot	3.24
Rear parcel shelf	3.25
Boot storage	3.26
Transporting objects in the boot	3.28
Transporting objects:	3.29
towbar	3.29
Roof bars	3.30
Spoiler	3.30
Multimedia equipment	3.31

AIR VENTS, air outlets (1/2)

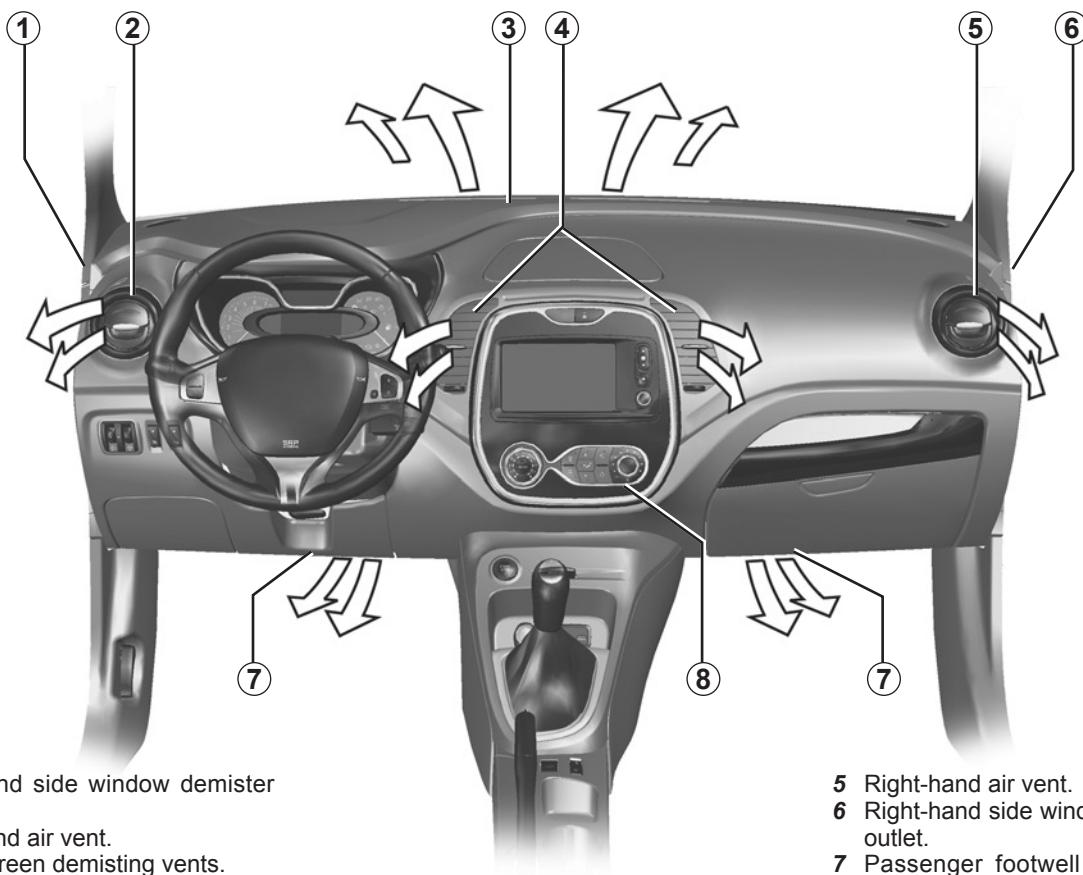

- 1 Left-hand side window demister outlet.
- 2 Left-hand air vent.
- 3 Windscreen demisting vents.
- 4 Centre air vents.

- 5 Right-hand air vent.
- 6 Right-hand side window demister outlet.
- 7 Passenger footwell heater outlets.
- 8 Control panel

AIR VENTS, air outlets (2/2)



Centre air vents.

Air flow

Move the control knob **10** (beyond the resistance point).

To the right: maximum air flow.

To the left: closed.

Direction

Move cursors **9** to the required position.

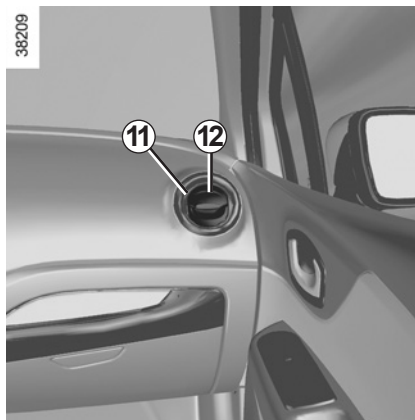

Side air vents

Air flow

To open air vent **11**, press on the air vent (point **12**) until it is open as far as required.

Direction

To direct the air flow, swivel side air vent **11**.



Do not add anything to the vehicle's ventilation circuit (for example, to remove bad odours).

There is a risk of damage or of fire.

MANUAL AIR CONDITIONING (1/3)

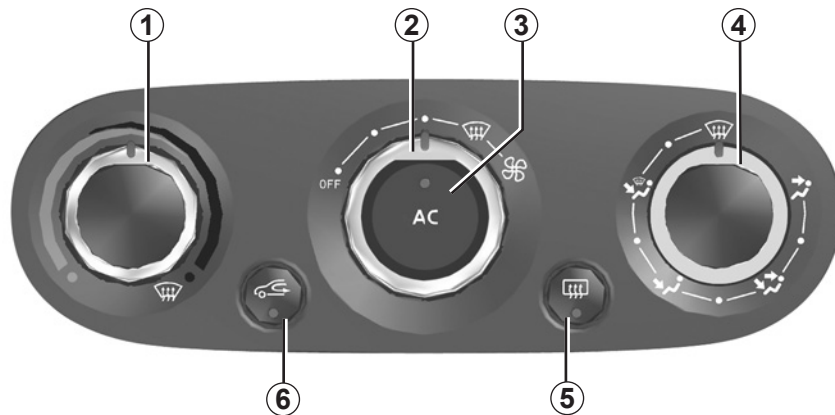

The controls

- 1 Adjusting the air temperature.
- 2 Adjusting the ventilation speed.
- 3 Air conditioning.
- 4 Distribution of air in the passenger compartment.
- 5 De-icing/demisting of the rear screen and, depending on the vehicle, the door mirrors.
- 6 Air recirculation.

Switching air conditioning on or off

(depending on vehicle)

The button **3** allows you to put the air conditioning on (indicator light lit) or off (indicator light unlit).

Activation is not possible if control **2** is set to OFF.

The air conditioning system is used for:

- lowering the temperature inside the passenger compartment;
- eliminating condensation more quickly.

MANUAL AIR CONDITIONING (2/3)

Distribution of air in the passenger compartment

There are five air distribution options. Turn control **4** to choose the distribution option.



The air flow is directed to the windscreen and the front side window demisting vents.



The air flow is distributed between all the air vents, the front side window demisting vents, the windscreen demisting vents and the footwells.



The air flow is directed mainly towards the footwells.



The air flow is directed towards the dashboard air vents, the front footwells and, depending on the vehicle, the second row footwells.



All the air flow is directed to the dashboard vents.

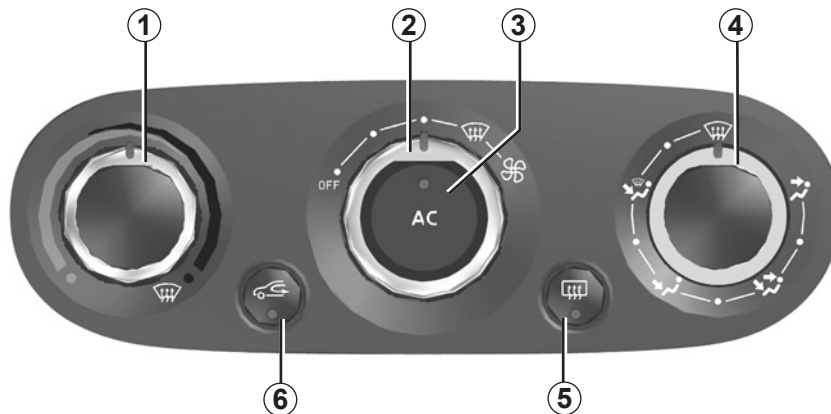

35606

Switching the air recirculation on

Press button **6**: the integrated indicator light comes on. In these conditions, air is taken from the passenger compartment and is recycled, with no air being taken from outside the vehicle.

Air recirculation is for:

- isolating the vehicle from the external atmosphere (driving in polluted areas, etc.);
- lowering the passenger compartment temperature as quickly as possible.

Prolonged use of air recirculation can lead to condensation forming on the side windows and windscreen, and discomfort due to the use of non-renewed air in the passenger compartment. We therefore advise you to return to normal mode (external air) as soon as the air recirculation function is no longer required, by pressing the button **6** again.

MANUAL AIR CONDITIONING (3/3)

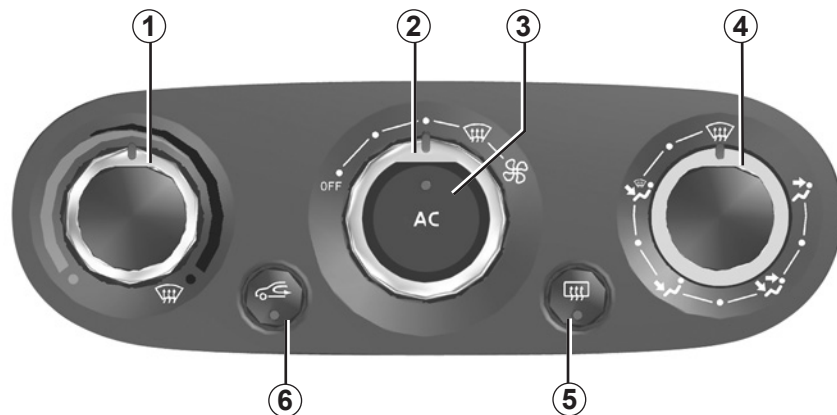

Adjusting the ventilation speed

Move control **2**. The further the control is positioned to the right, the greater the amount of air blown into the passenger compartment. If you want to shut off the flow of air, set control **2** to OFF.

The system is deactivated: the ventilation speed is zero (vehicle stationary). You can, however, still feel a slight flow of air when the vehicle is moving.

Rapid demisting

Turn controls **1**, **2** and **4** to positions



- air from the outside;
- maximum temperature;
- demisting.

Positions  and  prevent air recirculation mode to avoid any risk of condensation forming on the windscreen and triggers the air conditioning function.

Adjusting the air temperature

Turn control **1** to obtain the desired temperature. The further towards the red the slide is, the higher the temperature will be.

When the air conditioning system is used for long periods, it may begin to feel cold. To increase the temperature, turn control **1** to the right.

Rear screen de-icing/demisting

With the engine running, press button **5**. The integrated indicator light comes on.

This function permits rapid demisting/de-icing of the rear screen and de-icing of the door mirrors (on equipped vehicles).

To exit this function, press button **5** again.

Demisting automatically stops.

AUTOMATIC CLIMATE CONTROL (1/4)

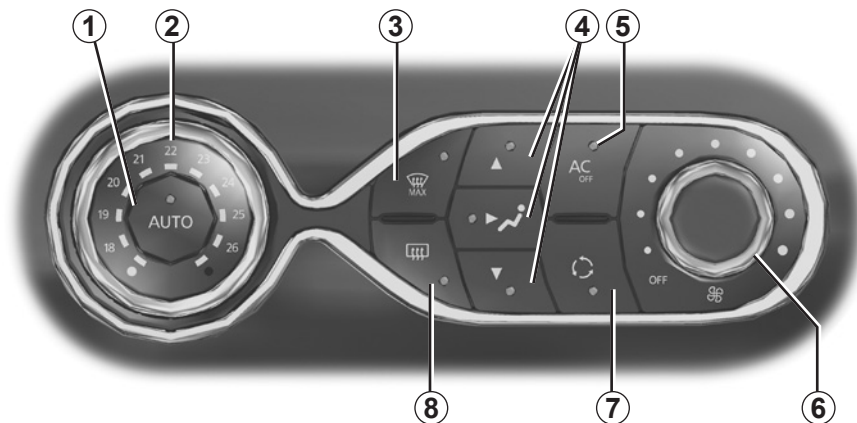

35605

The controls

- 1 Automatic mode.
- 2 Air temperature adjuster.
- 3 “Clear View” function.
- 4 Passenger compartment air distribution adjustment.
- 5 Air conditioning control.
- 6 Adjusting the ventilation fan speed.
- 7 Air recirculation.
- 8 De-icing/demisting of the rear screen and, depending on the vehicle, the door mirrors.

Automatic mode

The automatic climate control system guarantees comfort in the passenger compartment and good visibility (except in the event of extreme conditions), while optimising consumption. The system controls the ventilation speed, air distribution, air recirculation, and starting and stopping the air conditioning and air temperature.

AUTO: allows the selected comfort level to be best attained, depending on the exterior conditions. Press button 1.

Varying the ventilation speed

In automatic mode, the system uses the most suitable amount of air to reach and maintain the desired comfort level.

You can still adjust the ventilation speed by turning control 6 to increase or reduce the ventilation speed.

Adjusting the air temperature

Turn control 2 to obtain the desired temperature.

Turning the control to the right increases the temperature.

Special note: the maximum and minimum settings allow the system to produce a minimum or maximum temperature (18°C and 26°C).

AUTOMATIC CLIMATE CONTROL (2/4)

Clear View function

Press button **3** – the integrated indicator light comes on.

This function quickly demists and deices the windscreen, the rear screen, the front side windows, and the door mirrors (depending on the vehicle). The air conditioning and rear screen de-icing functions must be activated.

Press button **8** to stop the heated rear screen operating, and the integrated indicator goes out.

To exit this function, press button **3** or **1**.

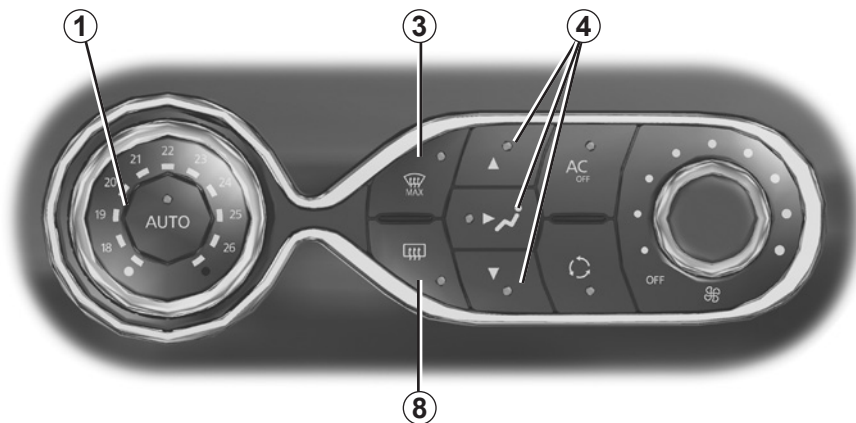



35605

Adjusting the distribution of air in the passenger compartment

Press one of the buttons **4**. The integrated warning light in the button comes on.

It is possible to combine two positions simultaneously – press both buttons **4**.

-  The air flow is distributed between all the air vents, the front side window demisting air vents and the windscreen demisting vents.
-  The air flow is mainly directed to the dashboard air vents.
-  The air flow is directed mainly towards the footwells.

Some buttons have an operating tell-tale which indicates the operating status.

AUTOMATIC CLIMATE CONTROL (3/4)

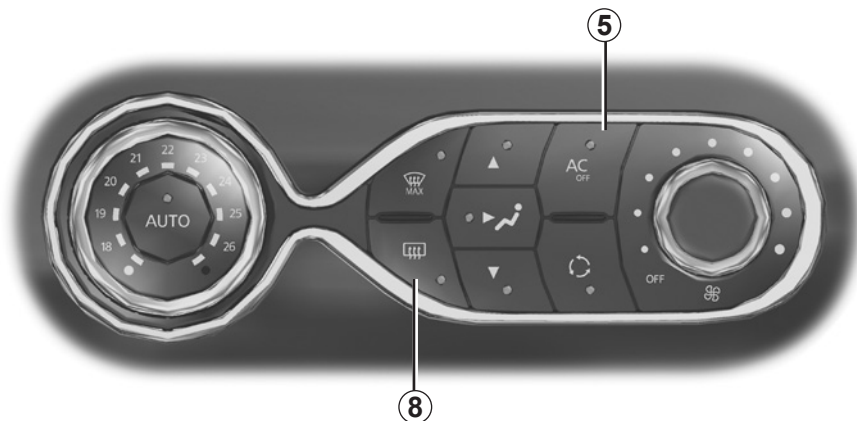

Rear screen de-icing/ demisting

Press button **8** – the integrated indicator light comes on. This function enables rapid demisting or de-icing of the rear screen and de-icing of the door mirrors (on equipped vehicles).

To exit this function, press button **8** again. Demisting automatically stops.

Switching air conditioning on or off

In automatic mode, the system switches the air conditioning system on or off, depending on the climate conditions.

Press button **5** to switch off the air conditioning; the integrated indicator comes on.

35605

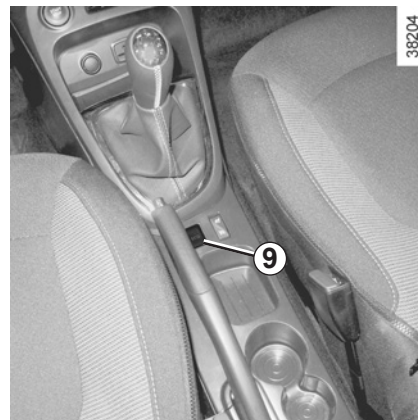

38204

Vehicles fitted with the ECO mode (button 9): once activated, the ECO mode may reduce the effective performance of the air conditioning. Please refer to the information on “Eco-driving” in Section 2.

AUTOMATIC CLIMATE CONTROL (4/4)

Air recirculation (isolation of the passenger compartment)



This function is managed automatically (operation is confirmed by a warning light on button 7), but you can also activate it manually.

The system determines whether or not the air recycling function is used, based on the quality of the outside air.

Depending on the vehicle, the air quality is signalled by one of the following indicator lights coming on on the touch screen (respectively, for cleaner or more polluted air):



NB:

- during recirculation, air is taken from the passenger compartment and is recycled, with no air being taken from outside the vehicle;
- air recirculation allows the external atmosphere to be cut off (when driving in polluted areas, etc.);
- the recirculation of air makes it possible to reach the desired passenger compartment temperature quicker.

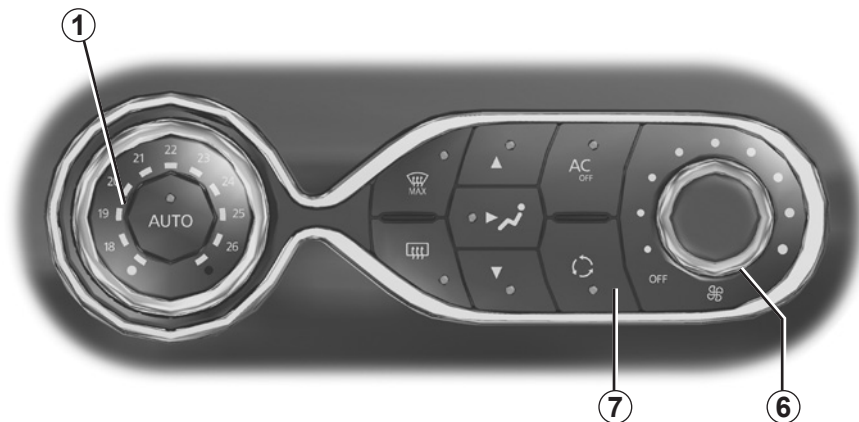

35605

Manual use

Press button 7 – the integrated indicator light comes on.

Prolonged use of this position may lead to odours, caused by non-renewal of air, and the formation of condensation on the windows.

We therefore advise you to return to automatic mode as soon as air recirculation is no longer needed, by pressing button 7.

To exit this function, press button 7 again.

Stopping the system

Turn the control 6 to “OFF” to stop the system. To start it, turn the control 6 again, then adjust the fan speed or press the button 1.

The demisting/de-icing will still take priority over the air recirculation.

AIR CONDITIONING: information and advice on use

Advice on use

In some situations, (air conditioning off, air recirculation activated, ventilation speed at zero or low, etc.) you may notice that condensation starts to form on the windows and windscreen.

If there is condensation, use the “**Clear View**” function to remove it, then use the air conditioning in automatic mode to stop it forming again.

Vehicles equipped with the ECO mode: once activated, the ECO mode may reduce the effective performance of the air conditioning. Please refer to the information on “Eco-driving” in Section 2.

Fuel consumption

You will normally notice an increase in fuel consumption (especially in town) when the air conditioning is operating.

For vehicles fitted with air conditioning with no automatic mode, switch off the system when it is not required.

Advice for reducing consumption and helping to preserve the environment

Drive with the air vents open and the windows closed.

If the vehicle has been parked in the sun, open the doors for a few moments to let the hot air escape before starting the engine.

Maintenance

Refer to the Maintenance Document for your vehicle for the inspection frequency.

Operating faults

As a general rule, contact your approved dealer in the event of an operating fault.

- **Reduction in de-icing, demisting or air conditioning performance.**
This may be caused by the passenger compartment filter cartridge becoming clogged.
- **No cold air is being produced.**
Check that the controls are set correctly and that the fuses are sound. Otherwise, switch off the system.

Presence of water under the vehicle

After prolonged use of the air conditioning system, it is normal for water to be present under the vehicle. This is caused by condensation.



Do not open the refrigerant fluid circuit. The fluid may damage eyes or skin.

ELECTRIC WINDOWS (1/2)

These systems operate with the ignition on or off, until one of the front doors is opened (limited to about 3 minutes).



Safety of rear occupants

The driver can prevent operation of the rear electric windows by pressing switch **4**. A confirmation message is displayed on the instrument panel.

Driver's responsibility

Never leave your vehicle with the RENAULT card inside and never leave a child (or a pet) unsupervised, even for a short while. They may pose a risk to themselves or to others by starting the engine, activating equipment such as the electric windows or by locking the doors. If any part of the body becomes trapped, reverse the direction of the window immediately by pressing the relevant switch.

Risk of serious injury.

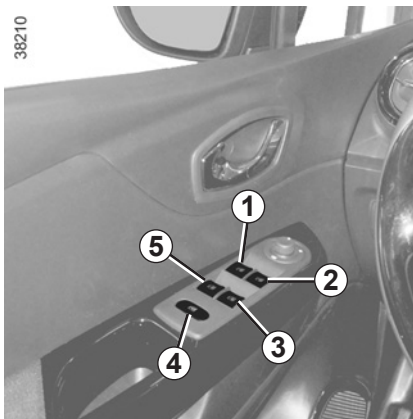

Electric windows

Press or pull the switch to raise or lower a window to the desired height (the rear windows do not open fully);

From the driver's seat, use switch:

- 1** for the driver's side;
- 2** for the front passenger side;
- 3** and **5** for the rear passenger windows.

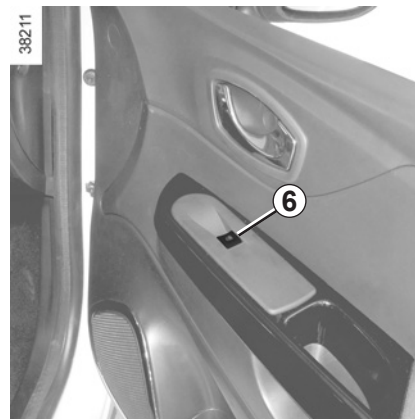

From the passenger seats, use switch **6**.

Avoid resting any objects against a half-open window: there is a risk that the electric window could be damaged.

ELECTRIC WINDOWS (2/2)

One-touch mode

Depending on the vehicle, this mode works in addition to the operation of the electric windows described previously. It is only fitted to the driver's window. Briefly press or pull switch **1** fully: the window is fully lowered or raised. Pressing the switch again stops the window moving.

NB: if the driver's window detects resistance when closing (e.g.: fingers, branch of a tree, etc.), it stops and then lowers again by a few centimetres.

Operating faults

In case of a fault when closing a window, the system reverts to normal mode: pull the switch concerned up as often as necessary to fully close the window (the window will close gradually), hold the switch (still on the closure side) for one second then lower and raise the window fully to reinitialise the system.

If necessary, contact your authorised dealer.



Closing windows can cause serious injury.

INTERIOR LIGHTING

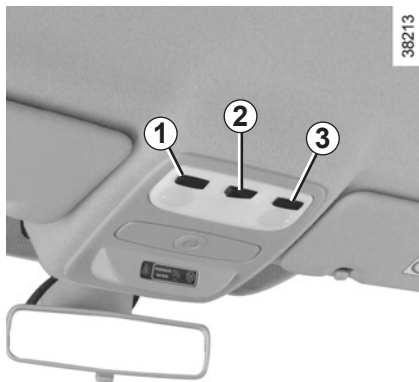

Courtesy light

Press switch **2** for:

- permanent lighting;
- lighting controlled by the unlocking of the vehicle or by opening one of the doors. This switches off after a time delay, once the doors concerned have been closed correctly;
- lighting switches off immediately.

Map reading lights

Press switch **1** for the driver, **3** for the front passenger.



Soft lighting 4

It comes on:

- on opening the storage drawer;
- on opening one of the doors. This switches off after a time delay, once the doors concerned have been closed correctly;
- at the same time as the side lights come on.

Unlocking and opening the doors or tailgate switches on the timed courtesy lights and lights.

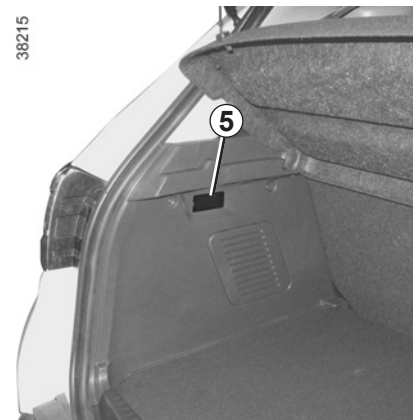

Boot light 5

It comes on when the boot is opened.

With the doors properly shut, locking or starting the engine make the interior lights and the courtesy lights go out.

PASSENGER COMPARTMENT STORAGE, FITTINGS (1/5)

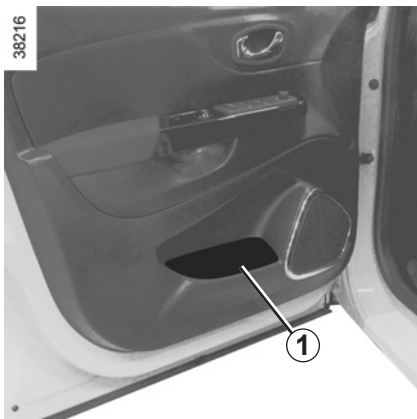

Front door storage pockets 1

They can hold a 1.5-litre bottle.



Nothing should be placed on the floor area in front of the driver as such objects may slide under the pedal during braking manoeuvres, thus obstructing its use.

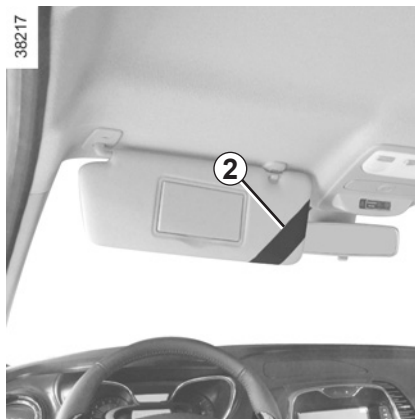

Sun visor storage 2

This can be used for storing motorway tickets, cards, etc.



Ensure that no hard, heavy or pointed objects are placed in the “open” storage compartments in such a way that they may fall onto passengers during sudden turning, braking or in the event of an accident.

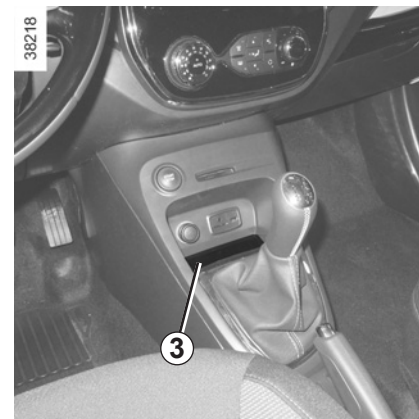

Centre console storage compartment 3

PASSENGER COMPARTMENT STORAGE, FITTINGS (2/5)



Dashboard storage compartment 5

To open it, press the lid 4.

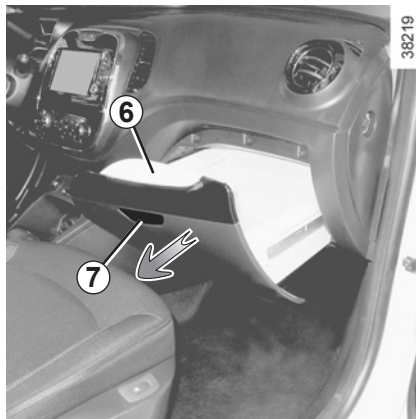

Passenger storage drawer

To open, press the button 7 to unlock the drawer and pull the handle 6.

Maximum load allowed in the passenger storage compartment: 6 kg, evenly distributed.



When driving, ensure that the storage drawer is closed. Risk of injury.

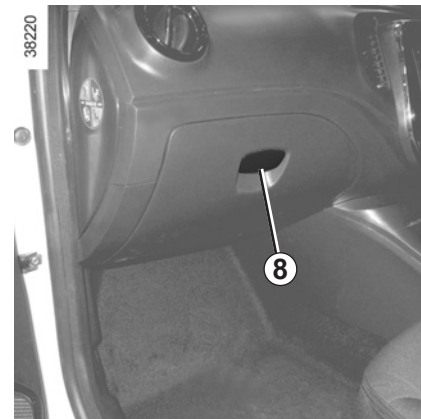

Glovebox

To open the glovebox, lift catch 8.

PASSENGER COMPARTMENT STORAGE, FITTINGS (3/5)

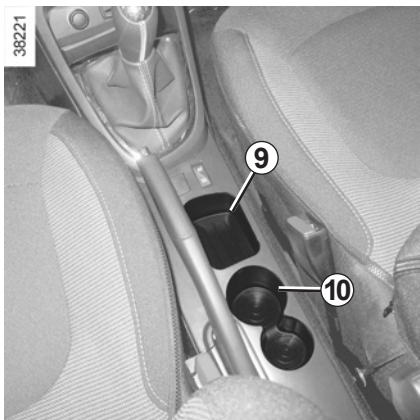

Storage compartment 9

Cup holders 10

This can be used for storing a mobile ashtray, cup holder, etc.



When turning corners, accelerating or braking, ensure that the receptacle being held by the cup holder is not dislodged.

There is a risk of injury if hot liquid escapes.

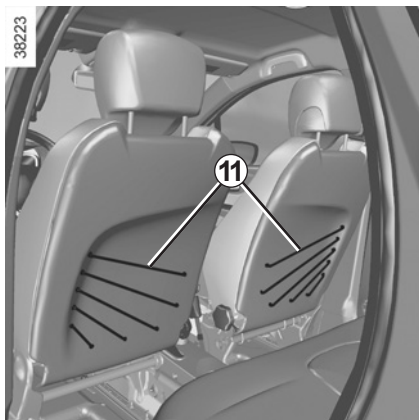

Front seat storage net 11



Ensure that no hard, heavy or pointed objects are placed in the “open” storage compartments in such a way that they may fall onto passengers during sudden turning, braking or in the event of an accident.

PASSENGER COMPARTMENT STORAGE, FITTINGS (4/5)



Rear centre console storage compartment 12

This can be used for storing a mobile ashtray, cup holder, etc.



Removable rear central storage compartment 13

It is fixed on the rear central storage console 12.



Rear door storage compartment 14

They can hold a 0.5-litre bottle.



When turning corners, accelerating or braking, ensure that the receptacle being held by the cup holder is not dislodged.

There is a risk of injury if hot liquid escapes.



Ensure that no hard, heavy or pointed objects are placed in the “open” storage compartments in such a way that they may fall onto passengers during sudden turning, braking or in the event of an accident.

STORAGE, CABIN FITTINGS (5/5)/SUN VISOR

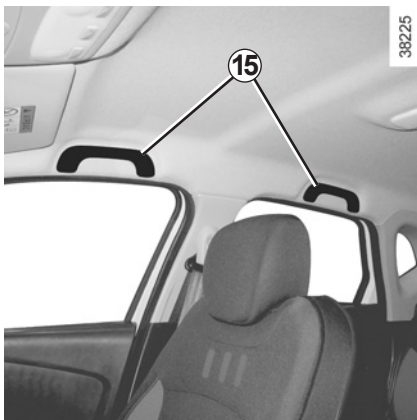

Grab handle 15

This offers support and can be held when the vehicle is being driven. Do not use it for getting into or out of the vehicle.



Front sun visor

Lower sun visor 16.

Courtesy mirrors

Lift the cover 17.



When driving, ensure the courtesy mirror cover is closed. Risk of injury.

ASHTRAY, CIGARETTE LIGHTER, ACCESSORIES SOCKET

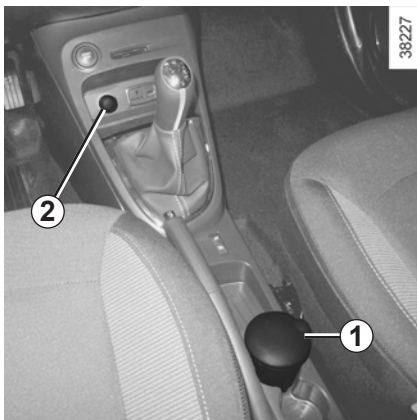

Ashtray

It can be housed in either position **1** or **3**.

Cigarette lighter **2**

With the ignition on, push in the cigarette lighter **2**. It will spring back with a click when it is ready. Pull it out to use.

After use, replace it without pushing it all the way in.

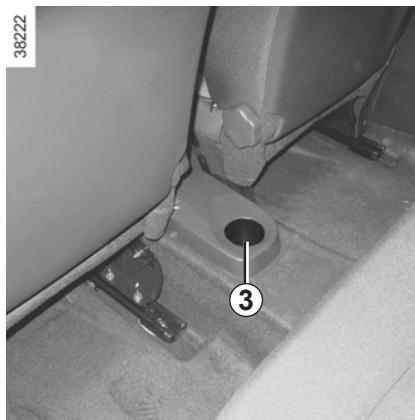

Accessories socket **2**

It is provided for connecting accessories approved by our Technical Department with a maximum power of 120 Watts (12V).



Connect accessories with a maximum power of 120 Watts only.

Fire hazard.

If your vehicle is not fitted with a cigar lighter and an ashtray, these can be obtained from an approved Dealer.

REAR HEAD RESTS



Position for use

Raise the headrest as far as possible to use it in the high position. Check that it is correctly locked.

Storage position

Press button **A** and lower the headrest completely.

When the headrest is set at the lowest position, this is for storage only. It should not be in this position when a seat is occupied.



To raise the headrest

Raise the headrest as far as it will go, then press button **A** and remove the headrest.

If necessary, fold the seatback down to take out the headrest (see the information on "Sliding rear bench seat" in Section 3).

To refit the headrest

Enter the rods in their housing and push down the headrest until it locks to use it in the high position. Check that it is correctly locked.

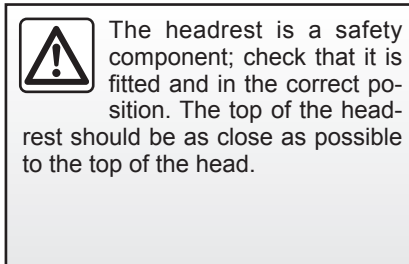
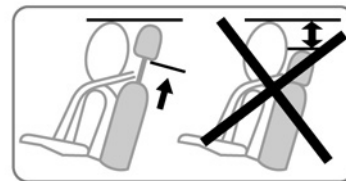

SLIDING REAR BENCH SEAT (1/2)



To move forwards or backwards

To unlock the seat:

- lift one of the levers **1** under the rear seats;
- from the boot, pull the handle **2**.

Move the seat forwards or back to the required position.

Release lever **1** or handle **2** and make sure that the seat is locked correctly in position.

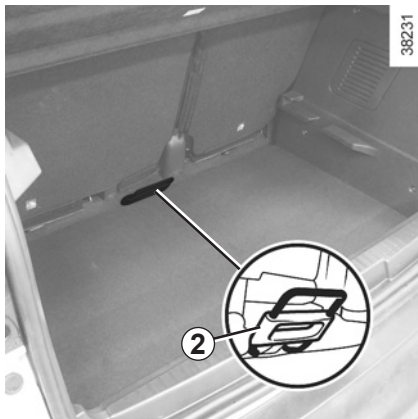

When moving the rear seats, ensure that nothing obstructs the anchorage points (passenger's arm or leg, a pet, gravel, cloth, toys, etc.).



For safety reasons, carry out any adjustments when the vehicle is not being driven.

SLIDING REAR BENCH SEAT (2/2)

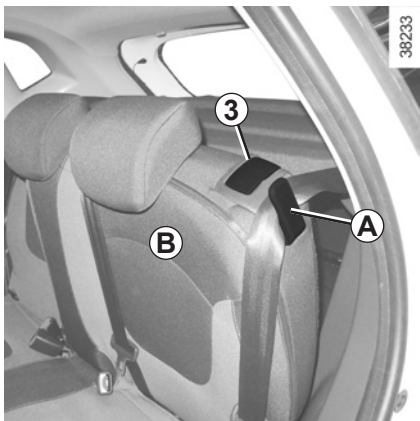

To fold down the seatback

Ensure that the front seats are far enough forward.

Lower the headrests fully.

Place the seat belts in their guides **A**.

Lift the handle **3** and lower the seatback **B**.

Before moving the seatback, put the seat belt in belt guide **A** to avoid damaging it.

To replace the seatback, proceed in the reverse order to removal.

Refit the seatback and click it back into place.



For safety reasons, carry out any adjustments when the vehicle is not being driven.

The configuration of the two-seat bench with the small seatback **B** pulled down, does not allow the central seat to be used as it would be impossible to buckle the seat belt (belt buckles inaccessible).



When moving the rear seats, ensure that nothing obstructs the anchorage points (passenger's arm or leg, a pet, gravel, cloth, toys, etc.).



When refitting the seatback, make sure it is correctly locked in place.

If seat covers are fitted, make sure these do not prevent the seatback latch from locking in. Make sure that the seat belts are positioned correctly. Reposition the headrests.

BOOT



38176

To open

Press button **1** and lift the tailgate.

To close

Lower the tailgate using the handles **2** inside the tailgate to help you.

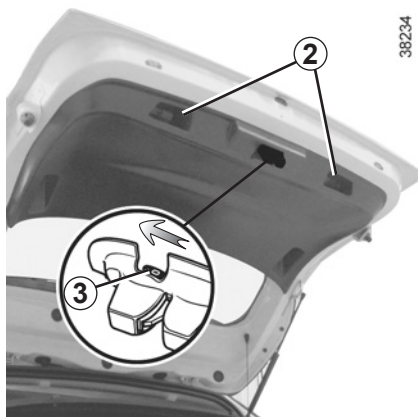

38234

Opening the doors manually from the inside

If it is impossible to unlock the tailgate, it can be done manually from inside:

- access the luggage compartment by tilting the rear bench seatback(s),
- insert a pencil or similar object in recess **3** and slide the unit as shown in the illustration;
- push the tailgate to open it.

REAR PARCEL SHELF

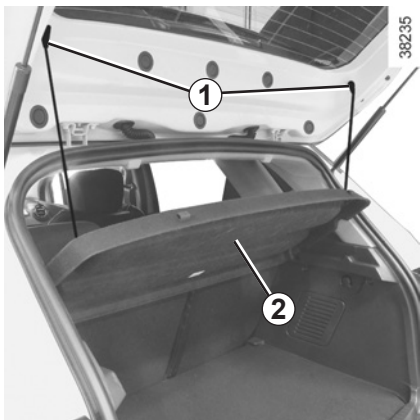

Removal

- Unhook the two straps **1** of the door of the boot;
- lift the parcel shelf **2** to half height in order to unclip it (movement **A**);

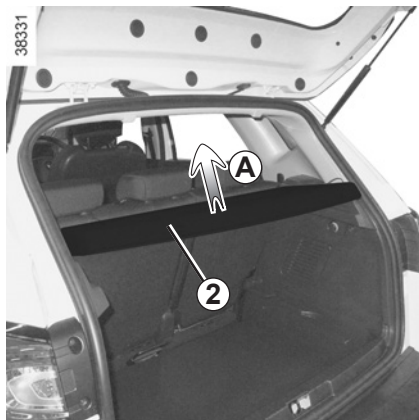

- lift one side of the parcel shelf;
- pull the parcel shelf towards you (movement **B**), beginning with the part most raised.

To refit, proceed in the reverse order to removal.

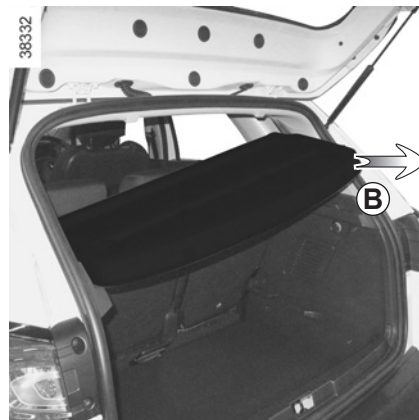

Do not place any objects, especially heavy or hard objects, on the parcel shelf. These may pose a risk to the vehicle occupants if the driver has to brake suddenly or if the vehicle is involved in an accident.

BOOT FITTINGS (1/2)



Mobile floor 1

Depending on the vehicle, the mobile floor is reversible.

Flat position

It allows you to have a flat floor by folding down the back of the rear bench-seat and to compartmentalise the boot into two distinct spaces.

The mobile floor is positioned on the runners (2 and 3).

Maximum load allowed on the mobile floor: 120 kg, evenly distributed.



Intermediate position

In the blocked position, it allows you to access the tools stored under the boot carpet.

- Remove the mobile floor 1;
- place it in the boot, letting it be guided by the runners (2 and 3).



Storage position

This allows for more space to store things in the boot.

- Remove the mobile floor 1;
- place it in the boot under the runners (2 and 3).

BOOT FITTINGS (2/2)



Hook 4

You can use this to secure a bag.

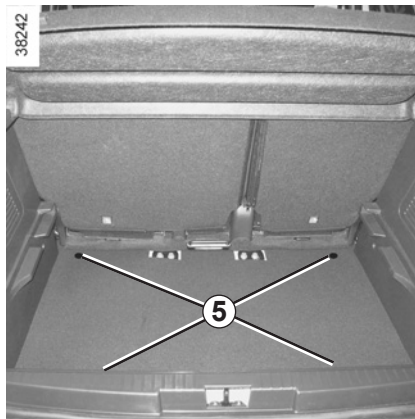

Anchorage points

Attachment points 5

If your vehicle is not equipped with anchorage points, you can get them from an authorised dealer.

TRANSPORTING OBJECTS IN THE LUGGAGE COMPARTMENT

Always position the objects transported so that the largest surface is against:

- The rear bench seatback for normal loads (example **A**).
- The front seatbacks with the rear seatbacks folded down, the mobile floor in the flat-floor position (example **B**).
- The front seatbacks with the rear seatbacks folded down, the mobile floor in the stored-away position, as is the case for maximum loads (example **C**).

If you have to place objects on the folded seatback, it is necessary that you lower the headrests before folding the seatback so that it can be folded as flat as possible against the seat.

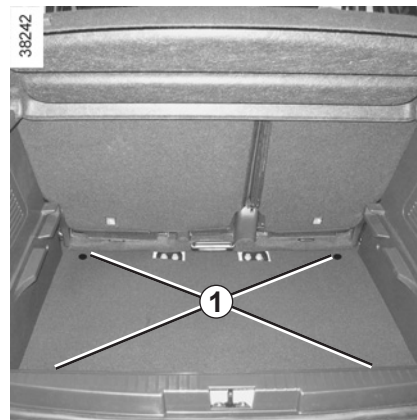

Always position the heaviest items directly on the floor. Use the lashing points **1** on the boot floor, if these are fitted to the vehicle. The luggage should be loaded in such a way that no items will be thrown forward and strike the occupants if the driver has to brake suddenly. Fasten the rear seat belts, even if the seats are not occupied.

TRANSPORTING OBJECTS towbar

24981

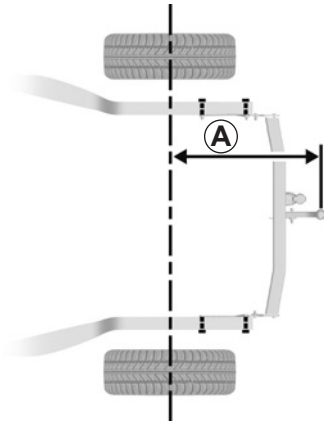

24982



A: 777 mm.

Permissible nose weight, maximum permissible towing weight, braked and unbraked: refer to the information on “Weights” in Section 6.

For fitting and conditions of use, refer to the equipment’s fitting instructions.

Please keep these instructions with the rest of the vehicle documentation.

If the towbar ball obscures the registration plate or the rear fog lights, it should be removed when not in use.

In all cases, comply with local legislation.

ROOF BARS/SPOILER

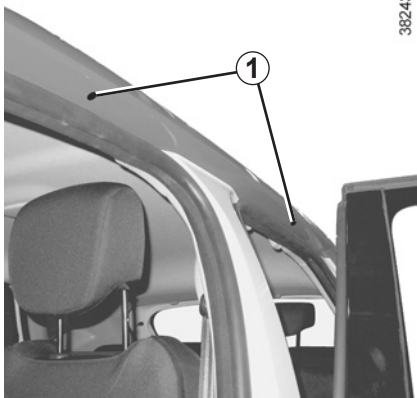

38243

Accessing the mounting points

Open the doors to access the mounting points **1**.



If original roof bars, approved by our Technical Department, are supplied with screws, only use these screws for attaching the roof bars to the vehicle.

Precautions during use

Handling the tailgate

Before handling the tailgate, check the objects and/or accessories (bike rack, roof box, etc.) fitted to the roof bars: these must be correctly positioned and secured, so as not to hinder the operation of the tailgate.

For information on the range of equipment adapted to your vehicle, we advise you to consult an approved Dealer.

Refer to the manufacturer's instructions for information on how to fit and use the roof rack bar.

Please keep these instructions with the rest of the vehicle documentation.

Maximum permissible load on roof rack: 80 kg (including the carrying device).



38244

Spoiler A



It is forbidden to fix objects and/or accessories (bike racks, etc.) to the spoiler.

MULTIMEDIA EQUIPMENT

The presence and location of this equipment depends on the vehicle version.

- 1 Multimedia touch-screen;
- 2 Multimedia sockets;
- 3 Steering column control;
- 4 Voice commands;
- 5 Microphone.

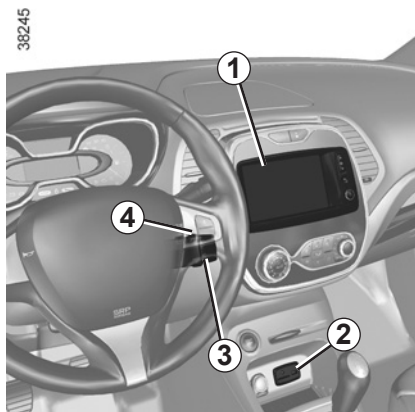

To use this equipment, consult the instructions for the equipment which should be kept with the other vehicle documentation.



Using the telephone

We remind you of the need to conform to the legislation in force concerning the use of such equipment.

Section 4: Maintenance

Bonnet	4.2
Engine oil level: general information	4.3
Engine oil level: topping up, filling	4.4
Engine oil change	4.5
Levels	4.6
engine coolant	4.6
brake fluid	4.7
windscreen washer reservoir	4.8
Filters	4.8
Tyre pressure	4.9
Battery	4.10
Bodywork maintenance	4.11
Interior trim maintenance	4.13
Seat covers	4.15

BONNET



To open the bonnet, pull the handle 1.



When working in the engine compartment, ensure that the windscreen wiper stalk is in the park position.

Risk of injury.



The engine may be hot when carrying out operations in close proximity. In addition, the engine cooling fan can come on at any moment.

Risk of injury.

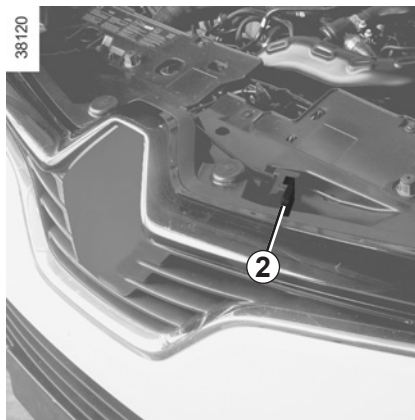

Unlocking the bonnet catch

To open, push tab 2 to the left as you open the bonnet.

Opening the bonnet

Lift the bonnet, helping it up, and it will rest in position with the help of struts.



Do not press down on the bonnet: there is a risk that the bonnet may accidentally close.

Closing the bonnet

Check that nothing has been left in the engine compartment.

To close the bonnet again, hold the bonnet in the middle and lower it to 30 cm above the closed position, then release it. It will latch automatically under its own weight.



After carrying out any work in the engine compartment, check that nothing has been left behind (cloth, tools, etc.). These may damage the engine or cause a fire.



Ensure that the bonnet is properly locked. Check that nothing is preventing the catch from locking (gravel, cloth, etc.).



In the event of even a slight impact involving the radiator grille or bonnet, have the bonnet lock checked by an approved dealer as soon as possible.

ENGINE OIL LEVEL: general information

It is normal for an engine to use oil for lubrication and cooling of moving parts and it is normal to top up the level between oil changes.

However, contact your approved Dealer if more than 0.5 litres is being consumed every 600 miles (1,000 km) after the running in period.

Oil change frequency: check the oil level from time to time and certainly before any long journey to avoid the risk of damaging your engine.

Reading the oil level

The oil level should be read with the vehicle on level ground, after the engine has been switched off for some time.

The dipstick must be used to read the exact oil level and make sure that the maximum level has not been exceeded (risk of engine damage). Refer to the following pages.

The instrument panel display only alerts the driver when the oil level is at its minimum.

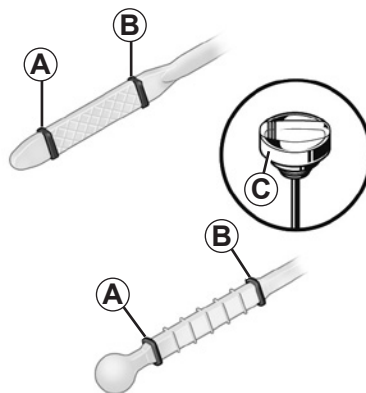

- remove the dipstick and wipe with a clean, lint-free cloth;
- push the dipstick in as far as it will go (for vehicles equipped with a cap-type dipstick **C**, screw the cap in as far as it will go);
- take out the dipstick again;
- read the level: it should never fall below minimum mark **A** or exceed maximum mark **B**.

Once the operation has been completed, ensure that the dipstick is pushed in as far as it will go or that the “cap-type dipstick” is completely screwed in.

In order to prevent splashback, it is recommended that a funnel be used when topping up/filling with oil

Exceeding the maximum engine oil level

The oil level should only be read with the dipstick as explained above. If the oil level exceeds the maximum level, **do not start your vehicle** and contact an approved Dealer.



Deactivate the Stop and Start function for any operation performed in the engine compartment.



Under no circumstances should maximum filling level **B** be exceeded: this could damage the engine and the catalytic converter.

ENGINE OIL LEVEL: topping up/filling (1/2)

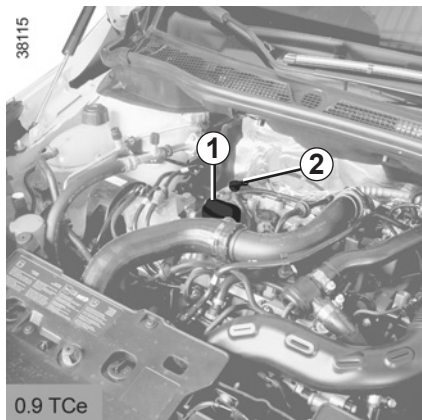

Topping up/filling

The vehicle must be parked on level ground and the engine should be cold (for instance, before the engine is started up for the first time in the day).

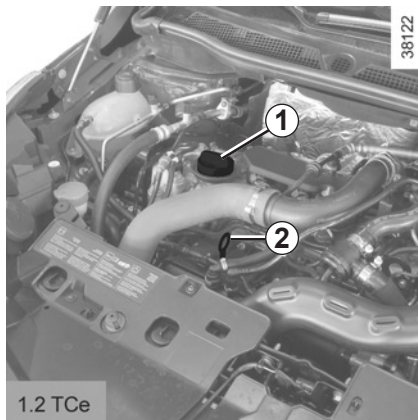

- Unscrew cap **1**;
- top up the level (as a guide, the capacity between the minimum and maximum reading on the dipstick **2** is between 1.5 and 2 litres, depending on the engine);
- wait for approximately 10 minutes to allow the oil to flow into the engine;
- check the level using the dipstick **2** (as described above).

Once the operation has been completed, ensure that the dipstick is pushed in as far as it will go and that the cap is completely screwed in.

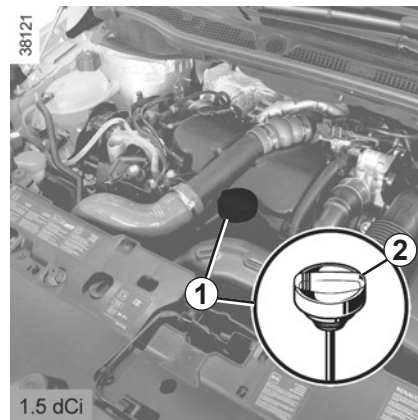

In order to prevent splashback, it is recommended that a funnel be used when topping up/filling with oil.

Do not exceed the **max** level and do not forget to refit cap **1** and dipstick **2**.

ENGINE OIL LEVEL: topping up, filling (2/2) OIL CHANGE

Oil change

Service interval: refer to the Maintenance Service Booklet for your vehicle.

Average capacities for oil change including oil filter

(for information)

Engine 0.9 TCe: 4.1 litres

Engine 1.2 TCe: 4.6 litres

Engine 1.5 dCi: 4.5 litres



Deactivate the Stop and Start function for any operation performed in the engine compartment.



When working in the engine compartment, ensure that the windscreen wiper stalk is in the park position.

Risk of injury.

Engine oil grade

Refer to the Maintenance Service Booklet for your vehicle.

Consult your approved dealer at once if you notice an abnormal or repeated drop in any of the fluid levels.



The engine may be hot when carrying out operations in close proximity. In addition, the engine cooling fan can come on at any moment.

Risk of injury.



Filling: take care when topping up the oil that no oil drips onto engine components - risk of fire. Remember to refit the cap securely as there is a risk of fire if oil splashes onto hot engine components.



Never run the engine in an enclosed space as exhaust gases are poisonous.



Engine oil change: if you are changing the oil when the engine is hot, be careful not to scald yourself if the oil overflows.

LEVELS (1/3)

38113

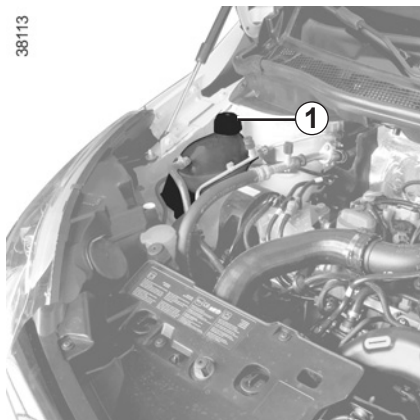

Coolant level

With the engine switched off and on level ground, the level **when cold** must be between the MINI and MAXI marks on reservoir **1**.

Top this level up **when cold** before it reaches the MINI mark.



When working in the engine compartment, ensure that the windscreen wiper stalk is in the park position.

Risk of injury.



No operations should be carried out on the cooling circuit when the engine is hot.

Risk of burns.

Frequency of checking coolant level

Check the coolant level regularly (very severe damage is likely to be caused to the engine if it runs out of coolant).

If the level needs to be topped up, only use products approved by our Technical Department which ensure:

- protection against freezing;
- an anti-corrosion protection for the cooling system.

Replacement interval

Refer to the Maintenance Document for your vehicle.



Deactivate the Stop and Start function for any operation performed in the engine compartment.

Consult your approved dealer at once if you notice an abnormal or repeated drop in any of the fluid levels.

LEVELS (2/3)

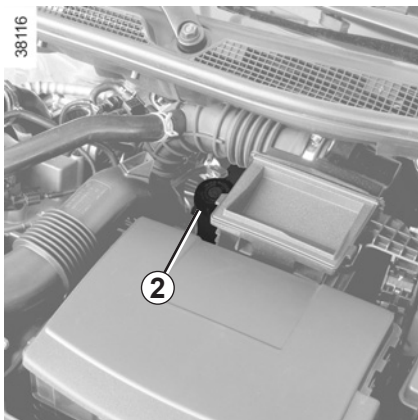

Brake fluid level

The level should be read with the engine switched off and on level ground.

This should be checked frequently, and immediately if you notice even the slightest loss in braking efficiency.



The engine may be hot when carrying out operations in close proximity. In addition, the engine cooling fan can come on at any moment.

Risk of injury.

Level 2

It is normal for the level to drop as the brake shoes become worn, but it must never drop lower than the “MINI” warning line.

If you wish to check the disc and drum wear yourself, you should obtain the document explaining the checking procedure from the manufacturer’s network or web site.

Topping up

After any operation on the hydraulic circuit, a specialist must replace the brake fluid.

Only use fluids approved by our Technical Department (and taken from a sealed container).

Replacement interval

Refer to the Maintenance Document for your vehicle.

Consult your approved dealer at once if you notice an abnormal or repeated drop in any of the fluid levels.

LEVELS (3/3)/FILTERS

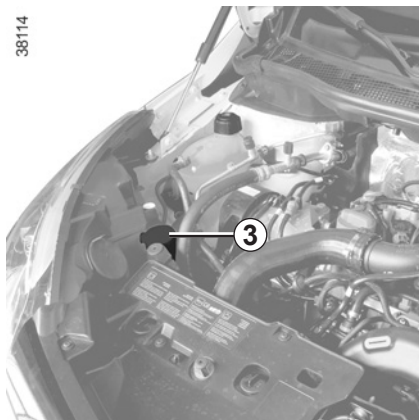

Windscreen washer reservoir

Topping up

With the engine switched off, open the cap **3**. Fill until you can see the fluid, then replace the cap.

Liquid

Screen wash product (product with antifreeze in winter).



Deactivate the Stop and Start function for any operation performed in the engine compartment.

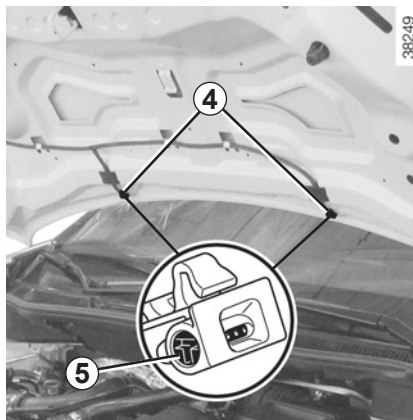

Jets

To adjust the angle of the windscreen washer jets **4**:

- open the bonnet;
- unscrew the setting screw **5** using a tool like a screwdriver.



When working in the engine compartment, ensure that the windscreen wiper stalk is in the park position.

Risk of injury.

Filters

The replacement of filter components (air filter, cabin filter, diesel filter, etc.) is scheduled in the maintenance operations for your vehicle.

Replacement intervals for filter elements: refer to the Maintenance Document for your vehicle.



The engine may be hot when carrying out operations in close proximity. In addition, the engine cooling fan can come on at any moment.

Risk of injury.

TYRE PRESSURE

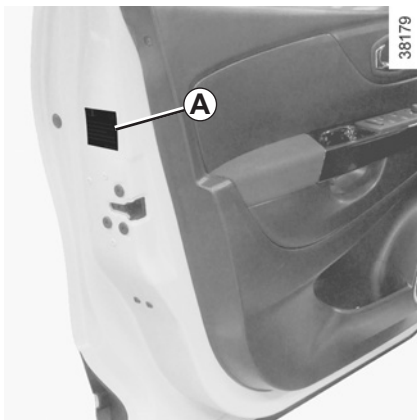

Label A

Open the driver's door to read it.

Tyre pressures should be checked when the tyres are cold.

If the tyre pressures cannot be checked when the tyres are **cold**, increase the pressures from **0.2 to 0.3 bar** (or **3 PSI**).
Never deflate a hot tyre.

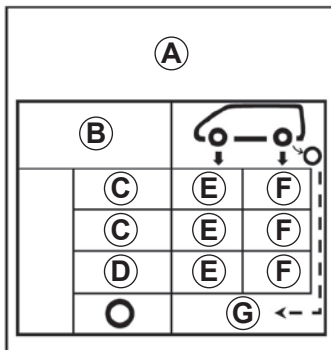

B: dimension of the tyres fitted to the vehicle.

C: intended driving speed.

D : recommended pressure for optimising fuel consumption.

NB: driving comfort may be altered.

E: front tyre pressure.

F: rear tyre pressure.

G: tyre pressure for the emergency spare wheel.

Special note concerning fully laden vehicles (Maximum Permissible All-Up Weight) **and towing a trailer:** the maximum speed must be limited to **60 mph** (100 kph) and the tyre pressure increased by **0.2 bar**.

Please refer to the information on "Weights" in Section 6.

Tyre safety and use of snow chains:

Refer to the information on "Tyres" in Section 5 for the servicing conditions and, depending on the version, the use of chains.



When they need to be replaced, only tyres of the same make, size, type and profile should be used on a single axle.

Tyres fitted to the vehicle should either be identical to those fitted originally or conform to those recommended by your approved dealer.

BATTERY

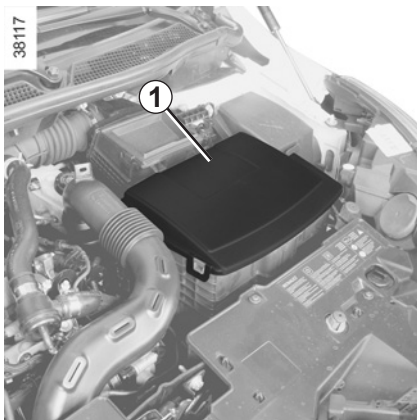

This is located under cover **1** and does not need to be serviced.



Handle the battery with care as it contains sulphuric acid, which must not come into contact with eyes or skin. If it does, wash the affected area with plenty of cold water. If necessary, consult a doctor.

Ensure that naked flames, red hot objects and sparks do not come into contact with the battery as there is a risk of explosion.

Replacing the battery

As this operation is complex, we advise you to contact an approved Dealer.



The battery is a **specific type**, please ensure it is replaced with the same type. Consult an approved dealer.

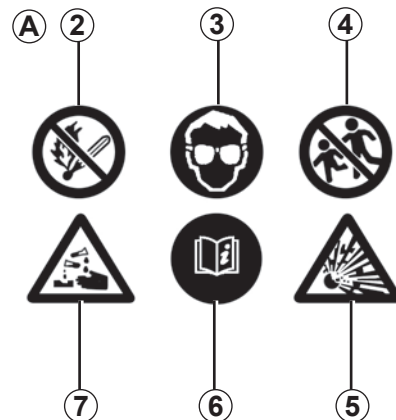

Label A

Observe the indications on the battery:

- **2** naked flames and smoking are forbidden;
- **3** eye protection required;
- **4** keep away from children;
- **5** explosive materials;
- **6** refer to the handbook;
- **7** corrosive materials.



The engine may be hot when carrying out operations in close proximity. In addition, the engine cooling fan can come on at any moment. Risk of injury.

BODYWORK MAINTENANCE (1/2)

A well-maintained vehicle will last longer. It is therefore recommended to maintain the exterior of the vehicle regularly.

Your vehicle has been treated with very effective anti-corrosion products. It is nevertheless subject to various outside influences.

Corrosive agents in the atmosphere

- atmospheric pollution (built-up and industrial areas),
- saline atmospheres (near the sea, particularly in hot weather),
- seasonal and damp weather conditions (e.g. road salt in winter, water from road cleaners, etc.).

Minor impacts

Abrasive action

Dust and sand in the air, mud, road grit thrown up by other vehicles, etc.

You should take a number of minor precautions in order to safeguard your vehicle against such risks.

What you should not do

Do not degrease or clean mechanical components (e.g. the engine compartment), underneath the body, parts with hinges (e.g. inside the doors) and painted plastic external fittings (e.g. bumpers) using high-pressure cleaning equipment or by spraying on products not approved by our Technical Department. Doing this could give rise to corrosion or operational faults.

Wash the vehicle in bright sunlight or freezing temperatures.

Do not scrape off mud or dirt without pre-wetting.

Allow dirt to accumulate on the exterior.

Allow rust to form following minor impacts.

Do not use solvents not approved by our Technical Department to remove stains as this could damage the paintwork.

Do not drive in snow or muddy conditions without washing the vehicle, particularly under the wheel arches and body.

You should

Wash your car frequently, **with the engine off**, with cleaning products recommended by the manufacturer (never use abrasive products). Rinse thoroughly beforehand with a jet:

- spots of tree resin and industrial grime;
- mud in the wheel arches and underneath the body which forms damp patches;
- **bird droppings**, which cause a chemical reaction with the paint that **rapidly discolours paintwork and may even cause the paint to peel off**;
wash the vehicle **immediately** to remove these marks since it is impossible to remove them by polishing;
- salt, particularly in the wheel arches and underneath the body after driving in areas where the roads have been gritted.

Remove any plant matter (resin, leaves, etc.) from the vehicle regularly.

BODYWORK MAINTENANCE (2/2)

Respect local regulations about washing vehicles (e.g. do not wash your vehicle on a public highway).

Observe the vehicle stopping distances when driving on gravelled surfaces to prevent paint damage.

Repair, or have repaired quickly, areas where the paint has been damaged, to prevent corrosion spreading.

Remember to visit the body shop periodically in order to maintain your anti-corrosion warranty. Refer to the Maintenance Document.

If it is necessary to clean mechanical components, hinges, etc., spray them with products approved by our Technical Department to protect them after they have been cleaned.

We have selected special products to care for your vehicle and you can obtain these from the manufacturer's accessory outlets.

Vehicles with a matte paint finish

This type of paint requires certain precautions.

Do not do the following

- use wax-based products (polishing);
- rub hard;
- wash the vehicle in a roller-type car wash;
- wash the vehicle using a high-pressure device;
- attach stickers to the paintwork (risk of leaving marks).

You should do the following

Wash the vehicle by hand using plenty of water, using a soft cloth or a gentle sponge.

Using a roller type car wash

Return the windscreen wiper stalk to the Park position (refer to the information on the “Windscreen washer, wiper” in Section 1). Check the mounting of external accessories, additional lights and mirrors, and ensure that the wiper blades are secured with adhesive tape. Remove the radio aerial mast if your vehicle is fitted with this equipment. Remember to remove the tape and refit the antenna after washing.

Cleaning the headlights

As the headlights are made of plastic “glass”, use a soft cloth or cotton wool to clean them. If this does not clean them properly, moisten the cloth with soapy water, then wipe clean with a soft damp cloth or cotton wool. Finally, carefully dry off with a soft dry cloth.

Cleaning products containing alcohol must not be used.

INTERIOR TRIM MAINTENANCE (1/2)

A well-maintained vehicle will last longer. It is therefore recommended to maintain the interior of the vehicle regularly.

A stain should always be dealt with swiftly.

Whatever type of stain is on the trim, use **cold** (or warm) **soapy water with natural soap**.

Detergents (washing-up liquid, powdered products, alcohol-based products) should not be used.

Use a soft cloth.

Rinse and soak up the excess.

For further recommendations for maintaining the interior, and/or for any unsatisfactory results, please see an authorised dealer.

Glass instrument panel

(e.g. instrument panel, clock, exterior temperature display, radio display, etc.)

Use a soft cloth (or cotton wool).

If this does not clean it properly, use a soft cloth (or cotton wool) slightly moistened with soapy water and then wipe clean with a soft damp cloth or cotton wool.

Finally, **carefully** dry off with a soft dry cloth.

Cleaning products containing alcohol must not be used under any circumstances.

Seat belts

These must be kept clean.

Use products selected by our Technical Department (Approved outlets) or warm, soapy water and a sponge and wipe with a dry cloth.

Detergents or dyes must not be used under any circumstances.

Textiles (seats, door trim, etc)

For vehicles fitted with removable seat covers, refer to the information on "Seat covers" in Section 4.

Vacuum-clean the textiles **regularly**.

Liquid stain

Use soapy water.

Dab lightly (never rub) with a soft cloth, rinse and remove the excess.

Solid or pasty stain

Carefully remove the excess solid or pasty material **immediately** with a spatula (working from the edges to the centre to avoid spreading the stain). Clean as for a liquid stain.

Special instructions for sweets or chewing gum

Put an ice cube on the stain to solidify it, then proceed as for a solid stain.

INTERIOR TRIM MAINTENANCE (2/2)

Removal/replacing removable equipment originally fitted in the vehicle

If you need to remove equipment in order to clean the passenger compartment (for example, mats), always ensure that they are correctly refitted and are the right way around (the driver's mat should be fitted on the driver's side, etc.) and fit them with the components supplied with the equipment (for example, the driver mat should always be fixed using the pre-fitted mounting components).

With the vehicle stationary, ensure that nothing will impede driving (anything obstructing the pedals, heel wedged by the mat, etc.).

You should not:

You are strongly advised not to position objects such as deodorants, scents, etc. near air vents, as this could damage your dashboard trim.



You are strongly recommended not to use high-pressure or spray cleaning equipment inside the passenger compartment: use of such equipment could impair the correct functioning of the electrical or electronic components in the vehicle, or have other detrimental effects.

SEAT COVERINGS (1/5)



Depending on the vehicle, it is possible to remove the seat covers (cleaning, customisation, etc.).

Principle of seat cover removal

Whether it's for the back or the base, **always remove as shown in the picture above A : do not rip the self-grip bands out.**

Precautions in use

Once the covers are removed:

- do not use the seats;
- take care of the self-grip bands;
- respect the washing instructions given on the seat covers (labels);
- do not wash them more than five times.

Serious risk of deterioration.



For safety reasons, carry out these operations when the vehicle is stationary.



With the seat covers off, ensure that the seatbelt buckles and ISOFIX attachments are clear.

SEAT COVERINGS (2/5)

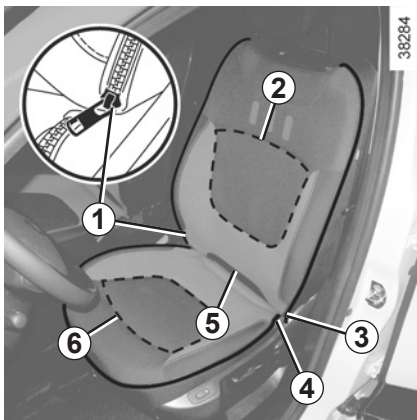

Front seat

Taking off the seatback cover

- Incline the seatback towards the rear;
- open the zip fasteners **1** and **3** on the seatback;
- remove the self-grip bands **5** between the seatback and the base;
- remove the cover according to the method shown (movement **A**).

Replacing the seatback cover

- Incline the seatback towards the rear;
- position the cover on the seatback;
- close the zip fasteners **1** and **3**;
- attach the self-grip bands **5** between the seatback and the base;
- attach the self-grip bands **2**.

Removing the base cover

- Open the zip fastener **4** of the base;
- remove the cover according to the method shown (movement **A**).

Replacing the base cover

- Position the base cover;
- close the zip fastener **4** for the base;
- attach the self-grip bands **6**.



With the seat covers off, ensure that the seatbelt buckles and ISOFIX attachments are clear.



For safety reasons, carry out these operations when the vehicle is stationary.

SEAT COVERINGS (3/5)

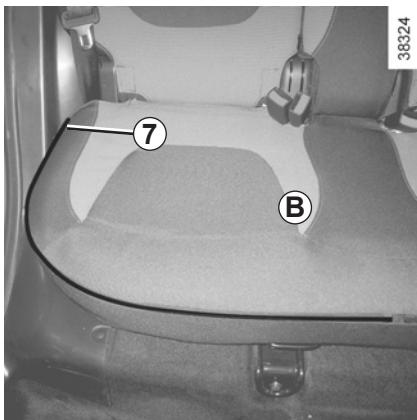

Rear bench seat

- Bring the front seats forward;
- reinsert the headrest for the rear bench seat;
- disengage the seat belts.



When moving the rear seats, ensure that nothing obstructs the anchorage points (passenger's arm or leg, a pet, gravel, cloth, toys, etc.).

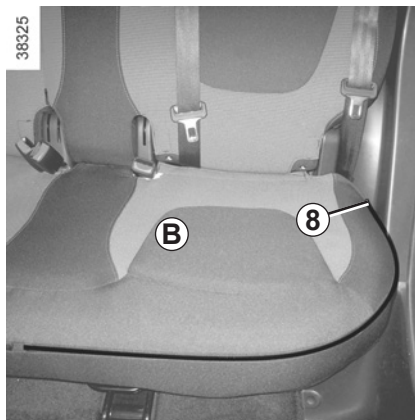

Removing the base cover *B*

- Open the zip fasteners **7** and **8** for the base *B*;
- remove the cover according to the method shown (movement *A*).



For safety reasons, carry out these operations when the vehicle is stationary.

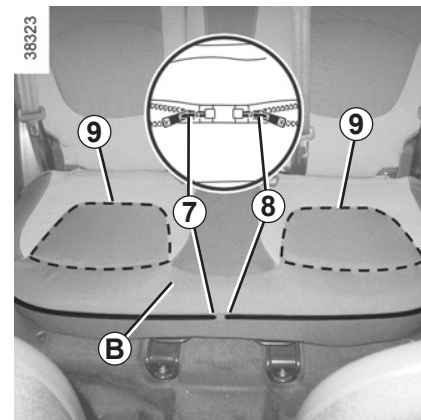

Replacing the base cover *B*

- Position the cover on the base *B*;
- close the zip fasteners **7** and **8**;
- attach the self-grip bands **9**.

SEAT COVERINGS (4/5)

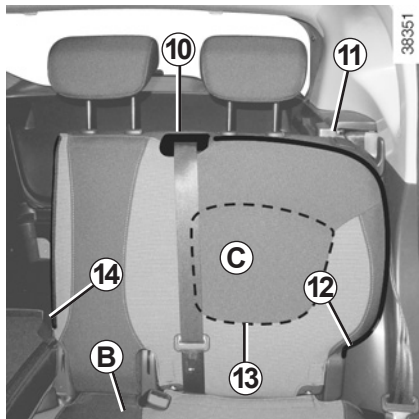

Removing the seatback cover C

- fold down the seatback **C** to the base using the stalk **11**;
- remove the self-grip bands **15** between the seatback and the base;
- reinsert the seatback **C** and ensure that it is well locked;
- open the zip fasteners **12** and **14** for the seat back **C**;
- remove the cover according to the method shown (movement **A**).

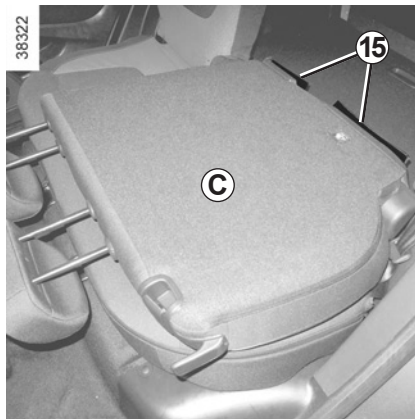

Replacing the seatback cover C

- Position the cover on the seatback **C**;
- keep the rear central seatbelt out of the way to position the cover;
- close the zip fastener **12** and **14** of the seatback **C**;



With the seat covers off, ensure that the seatbelt buckles and ISOFIX attachments are clear.

- attach the self-grip bands;
- ensure that the seatback cover is correctly positioned **C** under the guide of the central seatbelt **10**;
- slide the lower cover between the seatback **C** and the base **B**;
- fold down the seatback **C** to the base using the stalk **11**;
- attach the self-grip bands **15** between the seatback **C** and the base **B**;
- reinsert the seatback **C** and ensure that it is well locked;
- attach the self-grip bands **13**.



When refitting the seatback, make sure it is correctly locked in place.

If seat covers are fitted, make sure these do not prevent the seatback latch from locking in. Make sure that the seat belts are positioned correctly. Reposition the headrests.

SEAT COVERINGS (5/5)

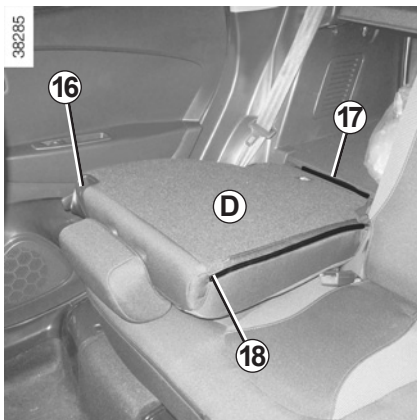

Removing the seatback cover *D*

- Fold down the seatback *D* to the base using the stalk **16**;
- remove the self-grip bands **17** between the seatback and the base;
- open the zip fastener **18** of the seat back *D*;
- reinsert the seatback *D* and ensure that it is well locked;

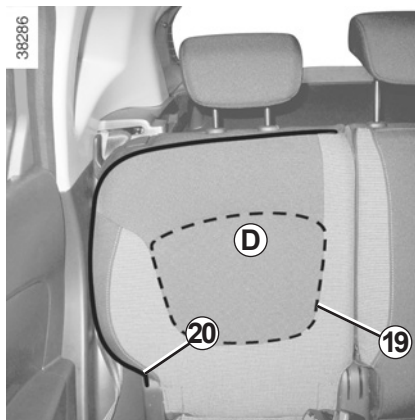

- open the zip fastener **20** of the seat back *D*;
- remove the cover according to the method shown (movement **A**).



When moving the rear seats, ensure that nothing obstructs the anchorage points (passenger's arm or leg, a pet, gravel, cloth, toys, etc.).

Replacing the seatback cover *D*

- Position the cover on the seatback *D*;
- close the zip fastener **20**;
- slide the lower cover between the seatback *D* and the base;
- move the seatback *D* onto the base using the stalk **16**;
- close the zip fastener **18** of the seat back *D*;
- attach the self-grip bands **17** between the seatback and the base;
- raise the seatback completely *D* and ensure that it is well locked;
- attach the self-grip bands **19**.



When refitting the seatback, make sure it is correctly locked in place.

If seat covers are fitted, make sure these do not prevent the seatback latch from locking in. Make sure that the seat belts are positioned correctly. Reposition the headrests.

Section 5: Practical advice

Puncture, emergency spare wheel	5.2
Tyre inflation kit	5.3
Tools	5.6
Wheel trims - wheel	5.7
Changing a wheel	5.8
Tyres (tyre and wheel safety, use in winter)	5.10
Headlights (changing bulbs)	5.13
Rear lights and side lights (changing bulbs)	5.16
Interior lighting (changing bulbs)	5.18
RENAULT card: battery	5.20
Fuses	5.21
Battery	5.24
Fitting a radio	5.26
Accessories	5.27
Wipers (replacing blades)	5.28
Towing	5.30
Operating faults	5.32

PUNCTURE, EMERGENCY SPARE WHEEL

In case of puncture

Depending on the vehicle, a tyre inflation kit or emergency spare wheel is provided (refer to the following pages).



Emergency spare wheel

- Open the tailgate;
- place the mobile floor in the mid-way position (please refer to the section on “Boot storage” in Section 3);
- lift the boot carpet;
- remove the tool kit by lifting it by its handles;
- unscrew the central mounting;
- remove the emergency spare wheel.

Note: Store the punctured wheel in the storage bag provided, along with the tool kit and put them in the boot.



If the emergency spare wheel has been stored for several years, have it checked by your Dealer to ensure that it is safe to use.

Vehicle fitted with an emergency spare wheel that differs from the other wheels:

- Never fit more than one emergency spare wheel to the same vehicle.
- As the punctured wheel is wider than the emergency spare wheel, the vehicle's ground clearance is reduced.
- Replace the emergency spare wheel as soon as possible with a wheel identical to the original one.
- When this is fitted to the vehicle, which must only be a temporary measure, the driving speed must not exceed the speed indicated on the label on the wheel.
- Fitting an emergency spare wheel may alter the way the vehicle usually runs. Avoid sudden acceleration or deceleration and reduce your speed when cornering.
- If you need to use snow chains, fit the emergency spare wheel to the rear axle and check the tyre pressure.

TYRE PRESSURE KIT (1/3)

32788



The kit repairs tyres when tread **A** has been damaged by objects smaller than 4 mm. It cannot repair all types of puncture, such as cuts larger than 4 mm, or cuts in tyre sidewall **B**.

Ensure also that the wheel rim is in good condition.

Do not pull out the foreign body causing the puncture if it is still in the tyre.



Do not attempt to use the inflation kit if the tyre has been damaged as a result of driving with a puncture.

You should therefore carefully check the condition of the tyre sidewalls before any operation.

Driving with underinflated, flat or punctured tyres can be dangerous and may make the tyre impossible to repair.

This repair is temporary

A tyre which has been punctured should always be inspected (and repaired, where possible) as soon as possible by a specialist.

When taking a tyre which has been repaired using this kit to be replaced, you must inform the specialist.

When driving, vibration may be felt due to the presence of the repair product injected into the tyre.



The kit is only approved for inflating the tyres of the vehicle originally equipped with the kit.

It must never be used to inflate the tyres of another vehicle, or any other inflatable object (rubber ring, rubber boat, etc.).

Avoid spillage on skin when handling the repair liquid bottle. If droplets do leak out, rinse them off with plenty of water.

Keep the repair kit away from children.

Do not dispose of the empty bottle in the countryside. Return it to your approved dealer or to a recycling organisation.

The bottle has a limited service life which is indicated on its label. Check the expiry date.

Contact an approved dealer to replace the inflation tube and repair product bottle.

TYRE PRESSURE KIT (2/3)

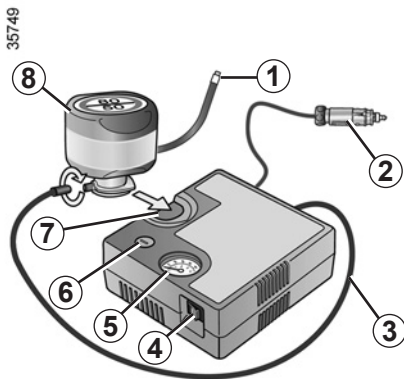

Depending on the vehicle, in the event of a puncture, use the kit located in the boot or underneath the luggage compartment carpet.



Before using this kit, park the vehicle at a sufficient distance from traffic, switch on the hazard warning lights, apply the handbrake, ask all passengers to leave the vehicle and keep them away from traffic.

With the engine running and the parking brake applied,

- unroll the hose from the container;
- connect the compressor hose **3** to the container's inlet **8**;
- depending on the vehicle, connect the container **8** to the compressor from the container recess **7**;
- unscrew the valve cap on the relevant wheel and screw on the container's inflation adapter **1**;
- adapter **2** must be connected to the vehicle accessories socket;
- press switch **4** to inflate the tyre to the recommended pressure (please refer to the information in the section on "Tyre pressure");

- after a maximum of **15** minutes, stop inflating and read the pressure (on pressure gauge **5**).

Note: while the container is emptying (approximately 30 seconds), the pressure gauge **5** will briefly indicate a pressure of up to **6** bar. The pressure will then drop.

- adjust the pressure: to increase it, continue inflation with the kit; to reduce it, press button **6**.

If a minimum pressure of 1.8 bar is not reached after 15 minutes, repair is not possible; do not drive the vehicle but contact an approved dealer.



If the vehicle is parked on the hard shoulder, you must warn other road users of your vehicle's presence with a warning triangle or with other devices as per the legislation applying to the country you are in.

TYRE PRESSURE KIT (3/3)

35749

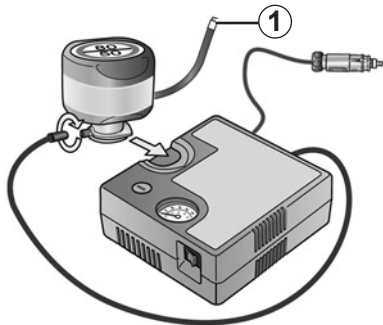

Once the tyre is correctly inflated, remove the kit: slowly unscrew the inflation adapter **1** to prevent any repair product from escaping and store the container in plastic packaging to prevent the product from escaping.



Nothing should be placed around the driver's feet as such objects may slide under the pedals during sudden braking manoeuvres and obstruct their use.

- Affix the driving recommendation label to the dashboard where it can easily be seen by the driver;
- Put the kit away.
- At the end of this initial inflation operation, air will still escape from the tyre. You must drive a short distance in order to seal the hole.
- Start immediately and drive at between 12 and 40 mph (20 and 60 km/h) in order to distribute the product evenly in the tyre and, after driving for 2 miles (3 km), stop and check the pressure.
- If the pressure is greater than 1.3 bar but less than the recommended pressure (refer to the label affixed to the edge of the driver's door), readjust it. Otherwise, please contact an authorised dealer: the tyre cannot be repaired.

Precautions when using the kit

The kit should not be operated for more than 15 consecutive minutes.



Please be aware that a poorly tightened or missing valve cap can make the tyres less airtight and may lead to pressure loss.

Always use valve caps identical to those fitted originally and tighten them fully.



Following repair with the kit, do not travel further than 120 miles (200 km). In addition, reduce your speed and under no circumstances exceed 48 mph (80 km/h). The sticker, which you must affix in a prominent position on the dashboard, reminds you of this.

Depending on the country or local legislation, a tyre repaired with the inflation kit may need to be replaced.

TOOLS

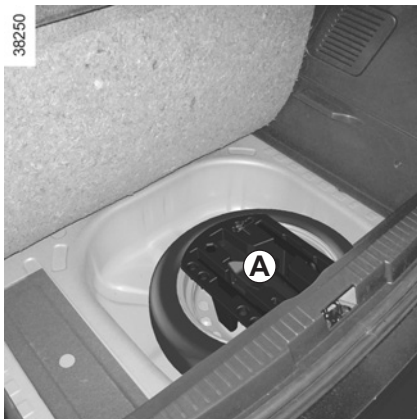

The tools included in the tool kit depend on the vehicle.
Tool kit **A** is located in the tray under the luggage compartment carpet.
Lift the cover and remove it.

Wheel bolt bag

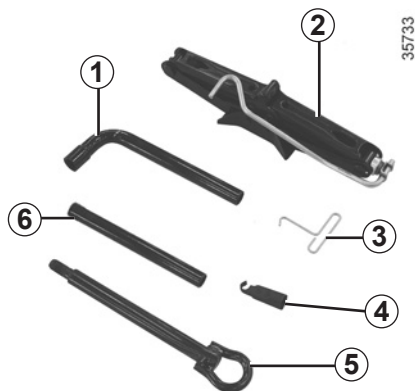

Storage bag

Supplied with the tool kit, this allows you to store a punctured wheel in the boot.

Wheelbrace 1

Locks or unlocks the wheel bolts and tow eye **5**.

Jack 2

Fold it correctly before refitting it in its housing (ensure that the wheelbrace is correctly positioned).

Hubcap tool 3

This tool is used to remove the wheel trims.

Wheel bolt guide 4

To finish loosening or starting to tighten the wheel bolts.

Tow eye 5

Please see “Towing: breakdown recovery” in Section 5.

Lever 6

This tightens or releases the tow eye **5**.



Do not leave the tools unsecured inside the vehicle as they may come loose under braking. After use, check that all the tools are correctly clipped into the tool kit, then position it correctly in its housing: there is a risk of injury.

If wheel bolts are supplied in the tool kit, only use these bolts for the emergency spare wheel: refer to the label affixed to the emergency spare wheel.

The jack is designed for wheel changing purposes only. Under no circumstances should it be used for carrying out repairs underneath the vehicle or to gain access to the underside of the vehicle.

WHEEL TRIMS - WHEEL

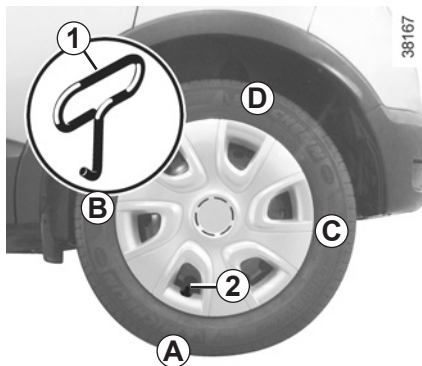

Remove the wheel trim using hubcap tool **1** (located in the tool kit) by engaging the hook in the opening near valve **2**.

To refit it, align it with valve **2**. Push the retaining hooks in fully, starting with side **A** near the valve, followed by **B** and **C**, finishing at **D** opposite the valve.



Do not leave the tools unsecured inside the vehicle as they may come loose under braking. After use, check that all the tools are correctly clipped into the tool kit, then position it correctly in its housing: risk of injury.

CHANGING A WHEEL (1/2)

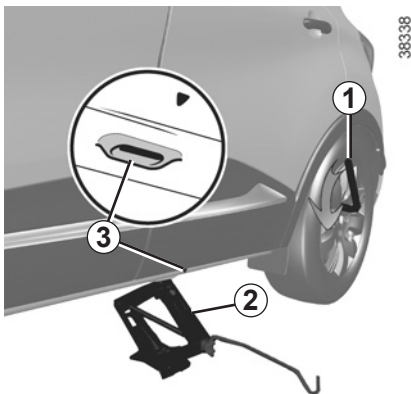

Switch on the hazard warning lights.

Keep the vehicle away from traffic and on a level surface where it will not slip (if necessary, place a solid support under the jack base).

Apply the parking brake and engage a gear (first or reverse, or **P** for automatic transmissions).

Ask all the passengers to leave the vehicle and keep them away from traffic.

Vehicles equipped with a jack and wheelbrace

If necessary, remove the wheel trim.

Use the wheelbrace **1** to slacken off the wheel bolts. Position it so as to be able to push from above.

Crank up jack **2** by hand to position the jack head against the jacking point closest to the relevant wheel and marked by an arrow **3**.



If the vehicle is parked on the hard shoulder, you must warn other road users of your vehicle's presence with a warning triangle or with other devices as per the legislation applying to the country you are in.

Continue to crank the jack so that the baseplate is correctly positioned (it should be underneath the vehicle and aligned with the jack head).

Turn it a few times to lift the wheel off the ground.

If the vehicle is not equipped with a jack or wheelbrace, you can obtain these from your approved dealer.



To prevent any risk of injury or damage to the vehicle, only crank the jack until the wheel you are replacing is a maximum of 3 centimetres off the ground.

CHANGING A WHEEL (2/2)

Undo the bolts and take off the wheel.

Fit the emergency spare wheel on the central hub and turn it to locate the mounting holes in the wheel and the hub.

Tighten the bolts, checking that the wheel is correctly positioned on its hub.

Lower the jack.

With the wheel on the ground, tighten the bolts fully and have the tightness of the bolts checked (tightening torque: 105 N.m) and the emergency spare tyre pressure checked as soon as possible.



If you have a puncture, replace the wheel as soon as possible.

A tyre which has been punctured should always be inspected (and repaired, where possible) by a specialist.



Do not leave the tools unsecured inside the vehicle as they may come loose under braking. After use, check that all the tools are correctly clipped into the tool kit, then position it correctly in its housing: risk of injury.

If wheel bolts are supplied in the tool kit, only use these bolts for the emergency spare wheel: refer to the label affixed to the emergency spare wheel.

The jack is designed for wheel changing purposes only. Under no circumstances should it be used for carrying out repairs underneath the vehicle or to gain access to the underside of the vehicle.

TYRES (1/3)

Tyre and wheel safety

The tyres are the only contact between the vehicle and the road, so it is essential to keep them in good condition.

You must make sure that your tyres conform to local road traffic regulations.



When they need to be replaced, only tyres of the same make, size, type and profile should be used.

Tyres fitted to the vehicle should either be identical to those fitted originally or conform to those recommended by your approved dealer.



Maintaining the tyres

The tyres must be in good condition and the tread form must have sufficient depth; tyres approved by our Technical Department have wear warning strips **1** which are **indicators moulded into the tread at several points.**

When the tyre tread has been worn to the level of the warning strips, **they become visible 2**: it is **then** necessary to replace your tyres because the tread rubber is now only **1.6 mm deep at most, resulting in poor road holding on wet roads.**

An overloaded vehicle, long journeys by motorway, particularly in very hot weather, or continual driving on poorly surfaced minor roads will lead to more rapid tyre wear and affect safety.



Incidents which occur when driving, such as striking the kerb, may damage the tyres and wheel rims, and could also lead to misalignment of the front or rear axle geometry. In this case, have the condition of these checked by an approved dealer.

TYRES (2/3)

Tyre pressures

Adhere to the tyre pressures (including the emergency spare wheel). The tyre pressures should be checked at least once a month and additionally before any long journey (refer to the label affixed to the edge of the driver's door).



Incorrect tyre pressures

lead to abnormal tyre wear and unusually hot running. These are factors which may seriously affect safety and lead to:

- poor road holding,
- risk of bursting or tread separation.

The pressure depends on the load and the speed of use. Adjust the pressure according to the conditions of use (refer to the label affixed to the edge of the driver's door).

Pressures should be checked when the tyres are cold; ignore higher pressures which may be reached in hot weather or following a fast journey.

If tyre pressures cannot be checked when the tyres are **cold**, assume an increase of **0.2 to 0.3 bar** (or **3 PSI**).

Never deflate a hot tyre.



Please be aware that a poorly tightened or missing valve cap can make the tyres less airtight and lead to pressure loss.

Always use valve caps identical to those fitted originally and tighten them fully.

Emergency spare wheel

Refer to the information on the “Emergency spare wheel” and instructions on “Changing a wheel” in Section 5.

Changing wheels around

This practice is not recommended.

Fitting new tyres



For safety reasons, this operation must be carried out by a specialist.

Fitting different tyres may change your vehicle as follows:

- it may mean that your vehicle no longer conforms to current regulations;
- it may change the way it handles when cornering;
- it may cause the steering to be heavy;
- it may affect the use of snow chains.

TYRES (3/3)

Use in winter

Chains

For safety reasons, fitting snow chains to the rear axle is strictly forbidden.

Chains cannot be fitted to tyres which are larger than those originally fitted to the vehicle.



Chains may only be fitted to tyres of the same size as those originally fitted to **your vehicle**.



17" wheels cannot be fitted with chains.

If you wish to fit snow chains, you must use **special equipment**.

Consult an approved Dealer.

Snow or Winter tyres

We would recommend that these be fitted to all **four wheels** to ensure that your vehicle retains maximum adhesion.

Warning: These tyres sometimes have a specific direction of rotation and a maximum speed index which may be lower than the maximum speed of your vehicle.

Studded tyres

This type of equipment may only be used for a limited period and as laid down by local legislation. It is necessary to observe the speed specified by current legislation.

These tyres must, at a minimum, be fitted to the two front wheels.

In all cases, we would recommend that you contact an approved dealer who will be able to advise you on the choice of equipment which is most suitable for your vehicle.

FRONT HEADLIGHTS: changing bulbs (1/3)

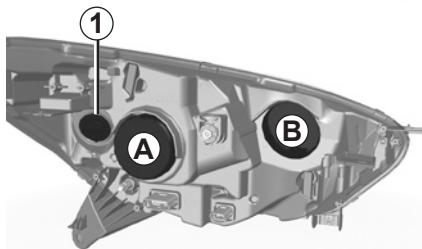

Direction indicator lights

Turn the bulb holder **1** a quarter of a turn and take out the bulb.

Bulb type: PY21W.

Once the bulb has been replaced, check that it is properly secured.



Deactivate the Stop and Start function for any operation performed in the engine compartment.

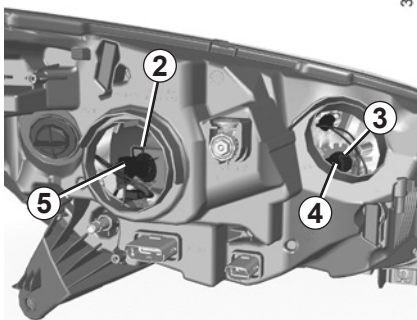

Dipped beam headlight

To change the bulb:

- remove cover **A**;
- disconnect the wiring **5** (black lead);
- unclip the spring **2** and remove the bulb.

Bulb type: H1.



The bulbs are under pressure and can break when replaced.

Risk of injury.

Main beam headlight

To change the bulb:

- remove cover **B**;
- disconnect the wiring **4** (black lead);
- unclip the spring **3** and remove the bulb.

Bulb type: H1.

It is **essential** to use anti-U.V. 55W bulbs so as not to damage the plastic on the headlights.

Do not touch the bulb glass. Hold it by its base.

When the bulb has been changed, make sure you refit the cover correctly.



The engine may be hot when carrying out operations in close proximity. In addition, the engine cooling fan can come on at any moment.

Risk of injury.

FRONT HEADLIGHTS: changing bulbs (2/3)

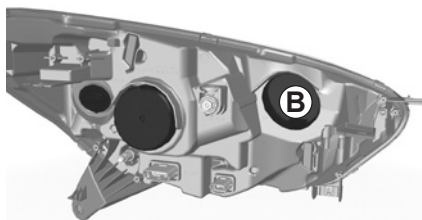

Front side light

To change a bulb, remove the cover **B**.
Pull the bulb holder **6** to access the bulb.

Bulb type: W5W.



The engine may be hot when carrying out operations in close proximity. In addition, the engine cooling fan can come on at any moment.

Risk of injury.

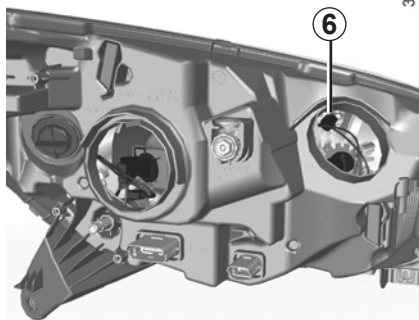

To comply with local legislation, or as a precaution, you can obtain an emergency kit containing a set of spare bulbs and fuses from an approved dealer.



Deactivate the Stop and Start function for any operation performed in the engine compartment.



The bulbs are under pressure and can break when replaced.

Risk of injury.

FRONT HEADLIGHTS: changing bulbs (3/3)



Daytime running lights 7

Please see an authorised dealer.

Front fog lights 8

- Access the bulb holder via the underneath of the vehicle;
- unclip the flap;
- turn the bulb holder a quarter turn.

Bulb type: H16LL.

Type of bulb for vehicles fitted with cornering lights: H11LL.

Additional lights

If you wish to fit fog lights to your vehicle, please see an authorised dealer.



Any operation on (or modification to) the electrical system must be performed by an approved dealer since an incorrect connection might damage the electrical equipment (harness, components and in particular the alternator). In addition, your Dealer has all the parts required for fitting these units.

REAR AND SIDE LIGHTS: changing bulbs (1/2)

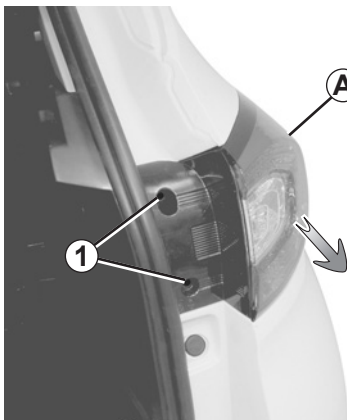

38182

Side lights/brake and direction indicator lights

Open the boot lid and remove screws **1**.

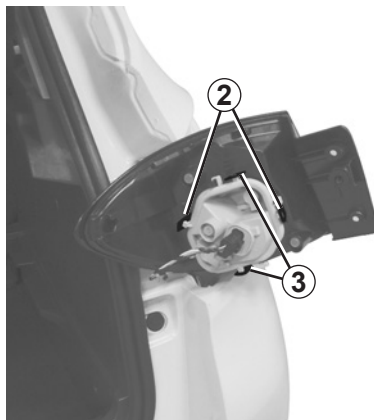

38183

Pull on the outside **A** of the light and remove the rear light unit.

Remove the bulb holder by releasing clip **2**, then clips **3**.

Change the bulb.

Refit the bulb holder and push the unit in fully until it locks in place.

Check that the light is properly locked in position.

Tighten screws **1**.

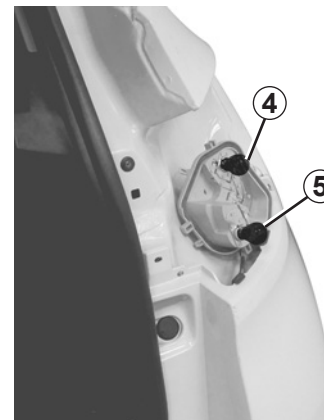

38184

4 Side light and brake light
Bulb type: P21/5W.

5 Direction indicator lights
Bulb type: PY21.



The bulbs are under pressure and can break when replaced.

Risk of injury.

REAR AND SIDE LIGHTS: changing bulbs (2/2)

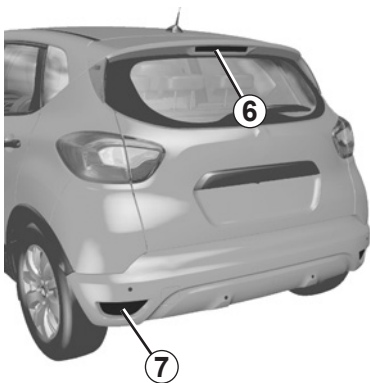

High-level brake light 6

Consult an approved dealer.

Reversing lights and rear fog lights 7

The front bumper needs to be removed; consult an authorised dealer.

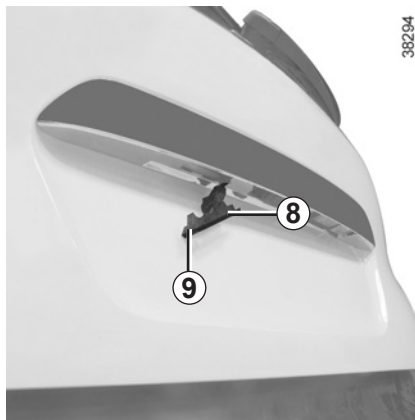

Number plate lights 8

- Unclip light 8 by pressing tab 9;
- remove the light cover to gain access to the bulb.

Bulb type: W5W.



The bulbs are under pressure and can break when replaced.

Risk of injury.

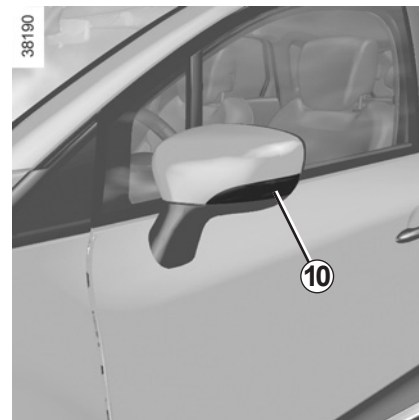

Side indicator lights 10

The wing mirror needs to be removed; consult an authorised dealer.

Bulb type: W5W.

INTERIOR LIGHTING: changing bulbs (1/2)



Courtesy light

Unclip the lens (using a flat-blade screwdriver or similar).

Remove the bulb concerned.

Bulb type 1: W5W.



The bulbs are under pressure and can break when replaced.

Risk of injury.



Soft lighting 2

Please contact an authorised dealer.

INTERIOR LIGHTING: changing bulbs (2/2)

38215

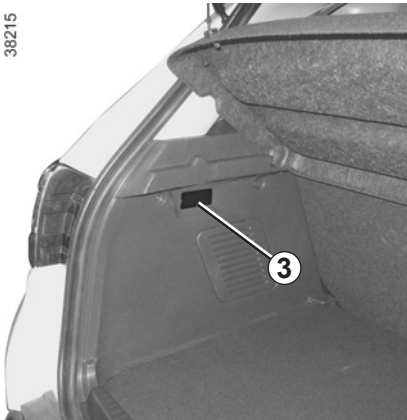

Luggage compartment light

Unclip light **3** by pressing the tabs on each side (using a flat-blade screwdriver or similar).

Disconnect the light.

25014

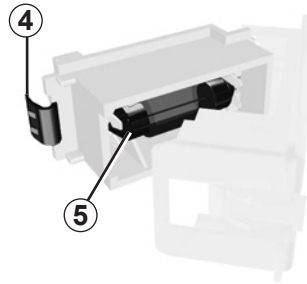

Press tab **4** to release the bulb holder and access bulb **5**.

Bulb type: C5W festoon type bulb.



The bulbs are under pressure and can break when replaced.

Risk of injury.

RENAULT CARD: battery

26860

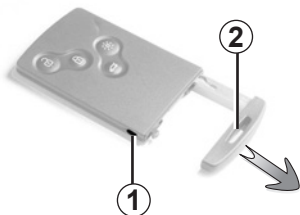

Replacing the battery

When the message “KEYCARD BATTERY LOW” appears on the instrument panel, replace the RENAULT card battery, press button **1** pulling on emergency key **2**, then unclip the cover **3** using tab **4**.

Remove the battery by pressing on one side (movement **A**) and by lifting the other (movement **B**) then replace it, ensuring the polarity and model, shown on cover **3** are respected.

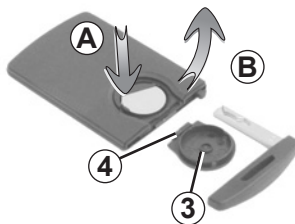

26862

When refitting, proceed in the reverse order, then press one of the buttons on the card four times, close to the vehicle: the next time the vehicle is started, the message will disappear.

Note: it is not advisable to touch the electronic circuit or contacts on the RENAULT card when replacing the battery.

Check that the cover is clipped shut.

The batteries are available from approved Dealers, and their service life approximately two years. Check that there is no dye on the battery: risk of an incorrect electrical contact.

26913

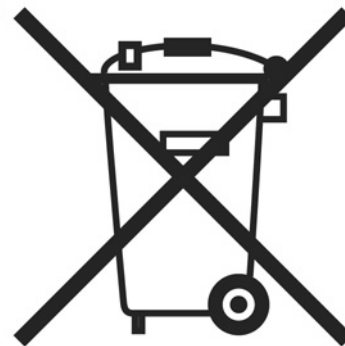

Operating faults

If the battery is too weak to ensure correct operation, you may start (insert the RENAULT card in the card reader) and lock/unlock the vehicle (refer to the information on “Locking/unlocking the doors” in Section 1).



Do not throw away your used batteries; give them to an organisation responsible for collecting and recycling batteries.

FUSES (1/3)



Fuses in passenger compartment A

If any electrical component does not work, check the condition of the fuses.

Unclip the access flap **A**.

To comply with current legislation, or as a precaution, you can obtain an emergency kit from your approved dealer containing a set of spare bulbs and fuses.

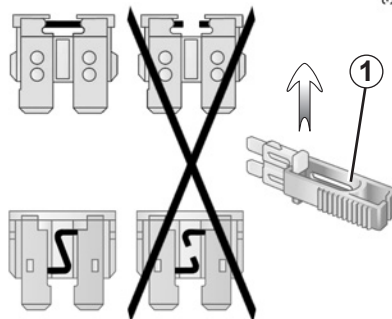

Clip 1

Remove the fuse using tweezers **1**, located at the back of flap **A**.

To remove the fuse from the tweezers, slide the fuse to the side.

It is not advisable to use the free fuse locations.



Check the fuse in question and **replace it**, if necessary, **by a fuse of the same rating**.

If a fuse is fitted with too high a rating, it may cause the electrical circuit to overheat (risk of fire) in the event of an item of equipment using an excessive amount of current.



Fuses in engine compartment B

Some functions are protected by fuses located in the engine compartment (unit **B**).

However, because of their reduced accessibility, **we advise you to have your fuses replaced by an approved Dealer**.

FUSES (2/3)

Allocation of fuses

(the presence of certain fuse depends on the vehicle equipment level)

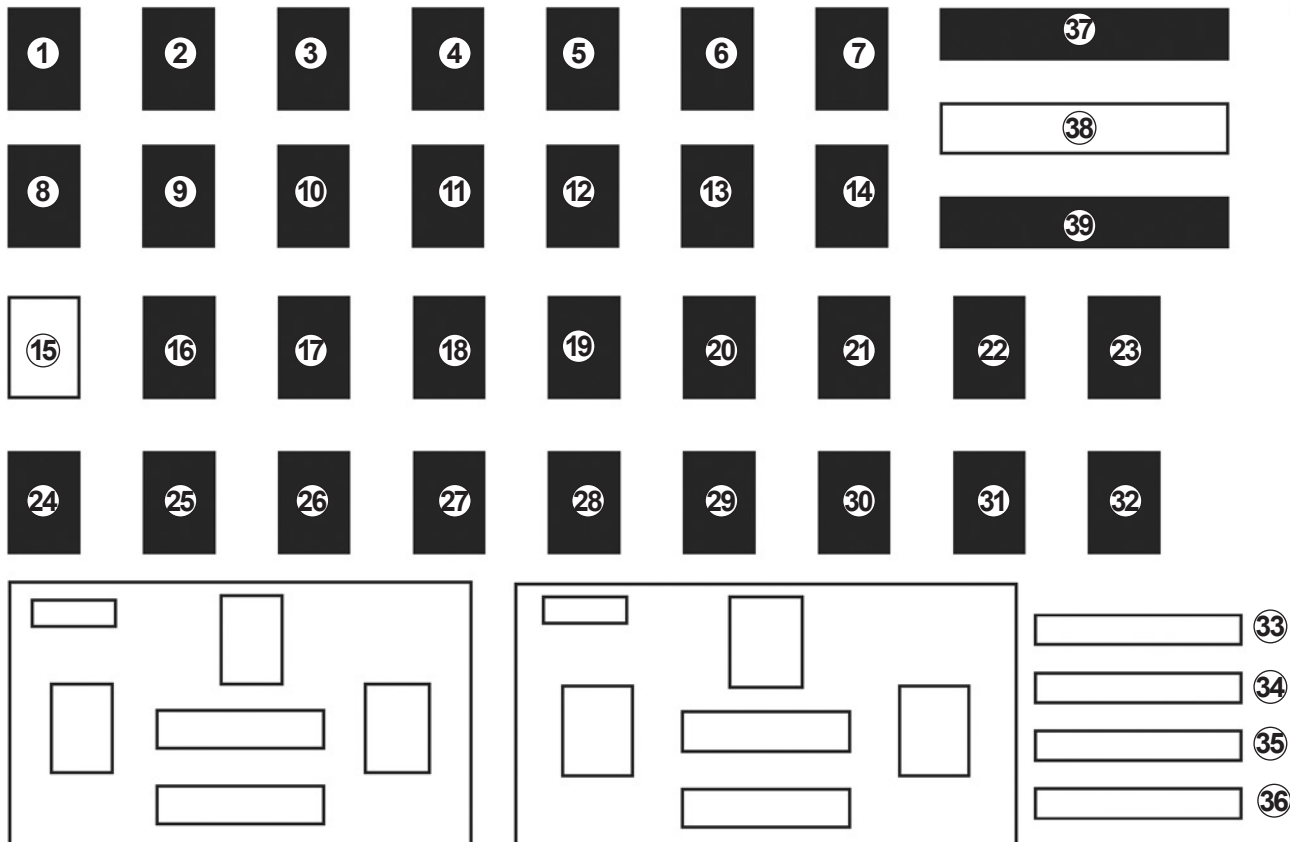

38339

FUSES (3/3)

Number	Allocation
1	Power-assisted steering
2	Injection
3	Airbag
4	Automatic gearbox, LPG
5	Dipped beam headlights
6	Front fog lights, front side lights, main beam headlights
7	Horn
8	Left-hand main beam headlight
9	Right-hand main beam headlight
10	Right-hand dipped beam headlight
11	Left-hand dipped beam headlight
12	Left-hand side lights
13	Right-hand side lights

Number	Allocation
14	Rear windscreen wiper
15	Empty location
16	Headlight beam adjustment
17	Daytime running lights
18	Brake lights
19	Electric door mirrors
20	ABS, ESP
21	Interior lighting
22	Vehicle On/Off button
23	Radio
24	Passenger compartment ECU
25	Passenger compartment ECU
26	Direction indicator lights

Number	Allocation
27	Central locking of opening elements
28	UCE energy management
29	UCE energy management
30	Alarm
31	Instrument panel
32	Cigarette lighter
33	Rear fog lights
34	Front seat heating
35	Rear screen de-icer
36	Towbar
37	Front windscreen wiper
38	Empty location
39	Front windscreen wiper

BATTERY: breakdown recovery (1/2)

To avoid all risk of sparks:

- Ensure that any electrical consumers (courtesy lights, etc.) are switched off before disconnecting or reconnecting the battery.
- When charging, stop the charger before connecting or disconnecting the battery.
- Do not place metal objects on the battery to avoid creating a short circuit between the terminals.
- Always wait at least one minute after the engine has been switched off before disconnecting a battery.
- Make sure that you reconnect the battery terminals after refitting.



Deactivate the Stop and Start function for any operation performed in the engine compartment.

Connecting a battery charger

The battery charger must be compatible with a battery with nominal voltage of 12 volts.

Do not disconnect the battery when the engine is running. **Follow the instructions given by the manufacturer of the battery charger you are using.**



Special procedures may be required to charge some batteries. Contact your approved dealer.

Avoid all risk of sparks which may cause an immediate explosion, and charge the battery in a well-ventilated area. Risk of serious injury.



Handle the battery with care as it contains sulphuric acid, which must not come into contact with eyes or skin. If it does, wash the affected area with plenty of cold water. If necessary, consult a doctor.

Ensure that naked flames, red hot objects and sparks do not come into contact with the battery as there is a risk of explosion.

The engine may be hot when carrying out operations in close proximity. In addition, the engine cooling fan can come on at any moment.

Risk of injury.

BATTERY: breakdown recovery (2/2)

Starting the vehicle using the battery from another vehicle

If you have to use the battery from another vehicle to start, obtain suitable jump leads (with a large cross section) from an approved dealer or, if you already have jump leads, ensure that they are in perfect condition.

The two batteries must have an identical nominal voltage of 12 volts. The battery supplying the current should have a capacity (amp-hours, Ah) which is at least the same as that of the discharged battery.

Ensure that there is no risk of contact between the two vehicles (risk of short circuiting when the positive terminals are connected) and that the discharged battery is properly connected. Switch off your vehicle ignition.

Start the engine of the vehicle supplying the current and run it at an intermediate engine speed.

38248

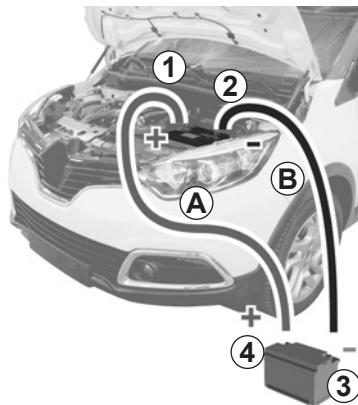

Depending on the vehicle, unclip the battery cover.

Connect the positive cable **A** to the support on the (+) terminal **1**, then to the (+) terminal **4** of the battery supplying the current.

Connect the negative cable **B** to the (-) terminal **3** of the battery supplying the current and then to the (-) terminal **2** of the discharged battery.

Start the engine, and as soon as it starts running, disconnect cables **A** and **B** in reverse order (**2 - 3 - 4 - 1**).

38253

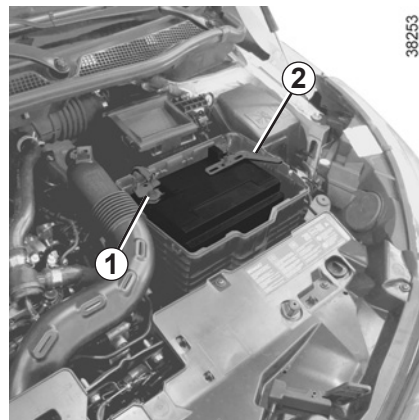

Check that there is no contact between leads **A** and **B** and that the positive lead **A** is not touching any metal parts on the vehicle supplying the current.

Risk of injury and/or damage to the vehicle.

FITTING A RADIO



Radio location 1

Unclip the blanking cover. The aerial, + and – supply and speaker wire connections are located behind it.

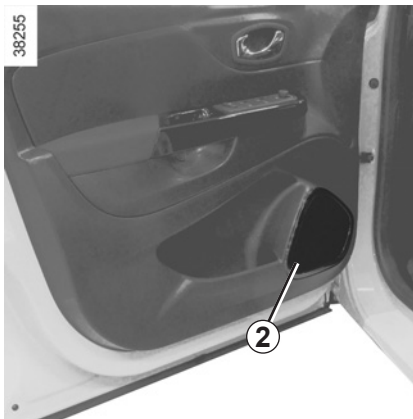

Door speakers 2

To install any equipment, please consult an authorised dealer.

- In all cases, it is very important to follow the manufacturer's instructions carefully.
- The specifications of the brackets and wires (available from our network) vary depending on the equipment level of your vehicle and the type of radio.

Consult an approved Dealer to find out the correct part number.

- No work may be carried out on the vehicle's electrical or radio circuits, except by approved dealers: an incorrectly connected system may result in damage being caused to the electrical equipment and/or the components connected to it.

ACCESSORIES



Electrical and electronic accessories

Before installing this type of accessory, make sure it is compatible with your vehicle. You can get advice from an authorised dealer.

Connect accessories with a maximum power of 120 watts only. **Fire hazard.**

No work may be carried out on the vehicle's electrical or radio circuits, except by authorised dealers: an incorrectly connected system may result in damage being caused to the electrical equipment and/or the components connected to it.

If the vehicle is fitted with any aftermarket electrical equipment, make sure that the installation is correctly protected by a fuse. Establish the rating and position of this fuse.

Use of transmission/receiving devices (telephones, CB equipment etc.).

Telephones and CB equipment with integrated aerials may cause interference to the electronic systems originally fitted to the vehicle: it is advisable only to use equipment with an external aerial. **Furthermore, we remind you of the need to conform to the legislation in force concerning the use of such equipment.**

Fitting after-market accessories

If you wish to install accessories on the vehicle: please contact an authorised dealer. Also, to ensure the correct operation of your vehicle, and to avoid any risk to your safety, we recommend that you use only accessories specifically designed for your vehicle, which are the only accessories for which the manufacturer will provide a warranty.

If you are using an anti-theft device, only attach it to the brake pedal.

Obstructions to the driver

On the driver's side, only use mats suitable for the vehicle, attached with the pre-fitted components, and check the fitting regularly. Do not lay one mat on top of another. **There is a risk of wedging the pedals**

WINDSCREEN WIPER BLADES (1/2)

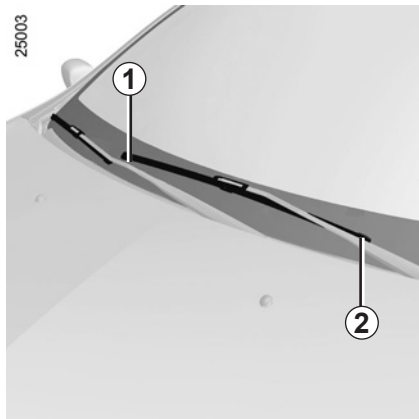

Replacing windscreen wiper blades 1

With the ignition on and the engine stopped:

- for vehicles equipped with the automatic windscreen wiper function, lower the windscreen wiper stalk fully: they stop slightly away from the bonnet;
- lift the wiper arm 2;
- turn blade 1.

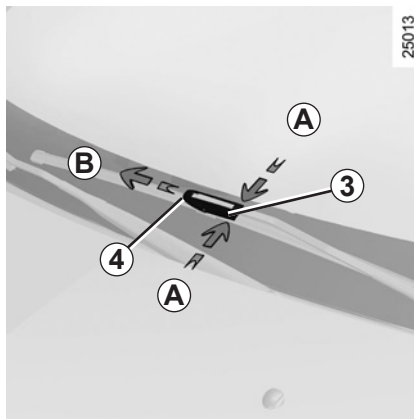

Lower tab 3, by pressing on either side A.

Then push the blade forwards B, to release hook 4.

To refit

To refit the wiper blade, proceed in reverse order to removal. Make sure that the blade is correctly locked in position.

Check the condition of the wiper blades. You are responsible for their service life:

- clean the blades, windscreen and rear screen regularly with soapy water;
- do not use them when the windscreen or rear screen are dry;
- free them from the windscreen or rear screen when they have not been used for a long time.



- In frosty weather, make sure that the wiper blades are not stuck by ice (to avoid the risk of the motor overheating).
- Check the condition of the wiper blades.
They should be replaced as soon as they become less efficient: approximately once a year.
When changing the blade, when it has been removed, do not let the wiper arm fall against the window: risk of breaking the window.

WINDSCREEN WIPER BLADES (2/2)

38340

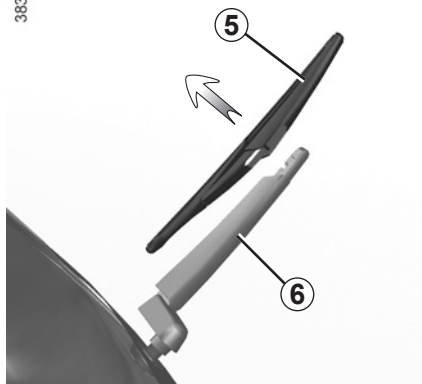

Rear screen wiper blade 5

- With the ignition off, lift wiper arm 6;
- release the blade 5 by pulling it.

To refit

To refit the wiper blade, proceed in reverse order to removal. Make sure that the blade is correctly locked in position.



– In frosty weather, make sure that the wiper blades are not stuck by ice (to avoid the risk of the motor overheating).

- Check the condition of the wiper blades. They should be replaced as soon as they become less efficient: approximately once a year.

When changing the blade, when it has been removed, do not let the wiper arm fall against the window: risk of breaking the window.

Check the condition of the wiper blades. You are responsible for their service life:

- clean the blades, windscreen and rear screen regularly with soapy water;
- do not use them when the windscreen or rear screen are dry;
- free them from the windscreen or rear screen when they have not been used for a long time.

TOWING: breakdown recovery (1/2)

Before towing, unlock the steering column: with the clutch depressed, engage **first gear** (lever in position **N** or **R** for vehicles with automatic gearboxes), insert the RENAULT card in the card reader, then press the engine start button for **two seconds**.

Reposition the lever to neutral (position **N** for vehicles fitted with an automatic gearbox).

The column is unlocked, the accessory functions are supplied: the vehicle lights can be used (indicators, brake lights etc.). At night the vehicle must have its lights on.

Once you have finished towing, press the engine start button twice (risk of running down the battery).



Do not remove the RENAULT card from the reader when the vehicle is being towed.

The speed specified by current legislation for towing must always be observed. If your vehicle is the towing vehicle, do not exceed the maximum towing weight for your vehicle (refer to the information on “Weights” in Section 6).

Towing a vehicle with an automatic gearbox

With the engine switched off, the transmission is no longer lubricated. It is preferable to tow this type of vehicle on a trailer or tow it with the front wheels off the ground.

Under **exceptional** circumstances, you may tow the vehicle with all four wheels on the ground, only going forward, with the gear lever in the neutral **N** position, and for a distance not exceeding 30 miles (50 km).

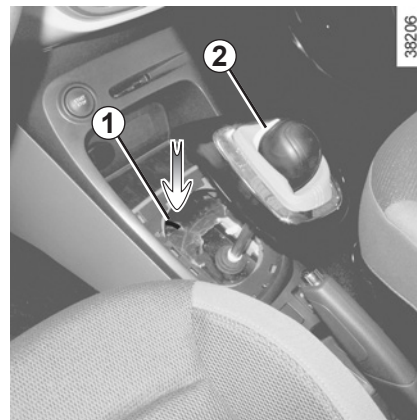

If the lever is stuck in **P**, even though you are depressing the brake pedal, the lever can be released manually. To do this, unclip the base of the lever, then insert a tool (with a hard rod to it) into the slot **1** and press the button **2** at the same time in order to unlock the lever.

Contact an authorised dealer as soon as possible.

TOWING: breakdown recovery (2/2)

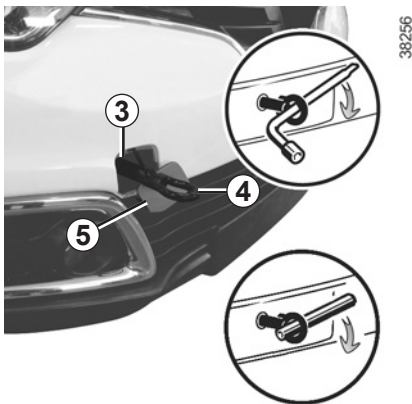

Only use the front 3 and rear 6 towing points (never use the drive shafts or any other part of the vehicle)

These towing points may only be used for towing: never use them for lifting the vehicle directly or indirectly.



When the engine is stopped, steering and braking assistance are not operational.

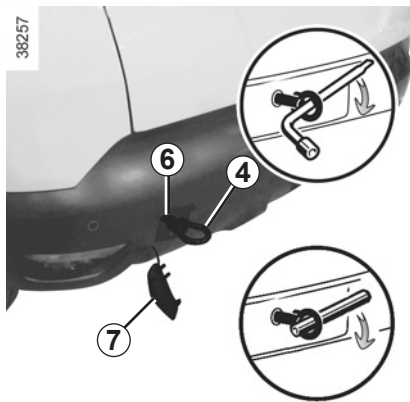

Access to towing points

Unclip cover 5 or 7 by sliding a flat tool (or the key integrated in the RENAULT card) under the cover.

Tighten towing hitch 4 fully: as much as possible by hand at first, then finish tightening it using the wheelbrace or, depending on the vehicle, the lever.

Only use the towing eye 4 and the wheelbrace located under the luggage compartment carpet in the tool kit (please refer to the information under "Tools" in Section 5).



– Use a rigid towing bar. If a rope or cable is used (where the law allows this), the vehicle being towed must be able to brake.

- A vehicle must not be towed if it is not fit to be driven.
- Avoid accelerating or braking suddenly when towing, as this may result in damage being caused to the vehicle.
- When towing a vehicle, it is advisable not to exceed **30 mph (50 km/h)**.
- Do not push the vehicle if the steering column is locked.



Do not leave the tools unsecured inside the vehicle as they may come loose under braking.

OPERATING FAULTS (1/6)

The following advice will enable you to carry out quick, temporary repairs. For safety reasons you should always contact an approved Dealer as soon as possible.

Using the RENAULT card	POSSIBLE CAUSES	WHAT TO DO
The RENAULT card does not lock or unlock the doors.	Card battery is flat.	Replace the battery. You can still lock/unlock and start your vehicle (refer to the information on “Locking, unlocking the opening elements” in Section 1 and “Starting, stopping the engine” in Section 2).
	Use of appliances operating on the same frequency as the card (mobile phone, etc.).	Stop using the equipment or use the integrated key (refer to the information on “Locking, unlocking the opening elements” in Section 1).
	Vehicle located in a high electromagnetic radiation zone. Vehicle battery flat.	Use the key integrated in the card (refer to the information on “Locking, unlocking the opening elements” in Section 1).
	The vehicle is started.	With the engine running, the card’s locking/unlocking device is blocked. Turn off the ignition.

OPERATING FAULTS (2/6)

The starter is activated	POSSIBLE CAUSES	WHAT TO DO
The instrument panel indicator lights are weak or fail to light up and the starter does not turn.	Battery terminals not tight, battery terminals disconnected or oxidised.	Retighten or reconnect the terminals, or clean them if they are oxidised.
	Discharged battery or not operational.	Connect another battery to the faulty battery. Refer to information on “Battery: troubleshooting” in Section 5 or replace the battery if necessary. Do not push the vehicle if the steering column is locked.
	Faulty circuit.	Consult an approved dealer.
The engine will not start.	Starting conditions are not fulfilled.	Please refer to the information on “Starting, stopping the engine” in Section 2.
	The RENAULT “hands-free” card does not work.	Insert the card in the card reader in order to start the engine. Please refer to the information on “Starting, stopping the engine” in Section 2.
The engine cannot be switched off.	Card not detected.	Insert the card in card reader.
	Electronic fault.	Press the starter button quickly five times.
The steering column remains locked.	Steering wheel locked.	Move the steering wheel while pressing the engine start button (please refer to Section 2 “Starting, stopping the engine”).
	Faulty circuit.	Consult an approved dealer.

OPERATING FAULTS (3/6)

On the road	POSSIBLE CAUSES	WHAT TO DO
Vibrations.	Tyres not inflated to correct pressures, incorrectly balanced or damaged.	Check the tyre pressures: if this is not the problem, have them checked by an approved Dealer.
White smoke from the exhaust.	In the diesel version, this is necessarily a fault. Smoke may be caused by particle filter regeneration.	Please refer to the information on “Special features of diesel versions” in Section 2.
Smoke under the bonnet.	Short-circuit or cooling system leak.	Stop, switch off the ignition, stand away from the vehicle and contact an approved dealer.
The oil pressure warning light comes on:		
while cornering or braking	The level is too low.	Top up the engine oil level (refer to the information on “Engine oil level: topping up, filling” in Section 4).
is slow to go out or remains lit under acceleration	Loss of oil pressure.	Stop the vehicle and contact an approved Dealer.

OPERATING FAULTS (4/6)

On the road	POSSIBLE CAUSES	WHAT TO DO
Steering becomes heavy.	Assistance overheating.	Consult an approved dealer.
The engine is overheating. The coolant temperature indicator is in the warning zone and warning light STOP comes on.	Engine cooling fan not working.	Stop the vehicle, switch off the engine and contact an approved dealer.
	Coolant leaks.	Check the coolant reservoir: it should contain fluid. If there is no coolant, consult an approved dealer as soon as possible.
Coolant boiling in the coolant reservoir.	Mechanical fault: damaged cylinder head gasket.	Stop the engine. Contact an approved dealer.



Radiator: If there is a significant lack of coolant, remember that it must never be topped up using cold coolant while the engine is very warm. After any procedure on the vehicle which has involved even partial draining of the cooling system, it must be refilled with a new mixture prepared in the correct proportions. Reminder: only products approved by our Technical Department may be used for this purpose.

OPERATING FAULTS (5/6)

Electrical equipment	POSSIBLE CAUSES	WHAT TO DO
The wipers do not work.	Wiper blades stuck.	Free the blades before using the wipers.
	Faulty electrical circuit.	Consult an approved dealer.
	Fuse damaged.	Replace the fuse, refer to the information on "Fuses".
The wiper does not stop.	Faulty electrical controls.	Consult an approved dealer.
Direction indicators flashing more quickly.	Blown bulb.	See information on "Headlights: changing bulbs" or "Rear and side lights: changing bulbs".
The direction indicators do not work.	Faulty electrical circuit or control.	Consult an approved dealer.
	Fuse damaged.	Replace the fuse, refer to the information on "Fuses".
The lights do not come on or go off.	Faulty electrical circuit or control.	Consult an approved dealer.
	Fuse damaged.	Replace the fuse, refer to the information on "Fuses".

OPERATING FAULTS (6/6)

Electrical equipment	POSSIBLE CAUSES	WHAT TO DO
Traces of condensation in the lights.	Traces of condensation may be a natural phenomenon caused by variations in temperature. In this case, the traces will disappear slowly once the lights are switched on.	
The front seat belt reminder light comes on when the seat belts are fastened.	An object is stuck between the floor and the seat and is disrupting the operation of the sensor.	Remove all objects from underneath the front seats.

Section 6: Technical specifications

Vehicle identification plate	6.2
Engine identification plate	6.3
Dimensions	6.4
Engine specifications.	6.5
Towing weights	6.6
Weights	6.6
Replacement parts and repairs	6.7
Service sheets	6.8
Anti-corrosion check	6.14
	6.1

ENGINE IDENTIFICATION PLATES

33293

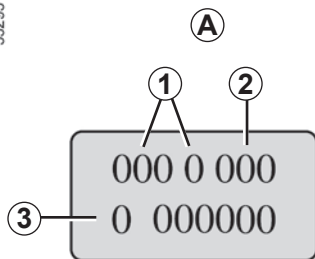

Please quote the information on the engine plate or label A in all correspondence or orders.

(Location varies depending on engine)

- 1 Engine type.
- 2 Engine suffix.
- 3 Engine number.

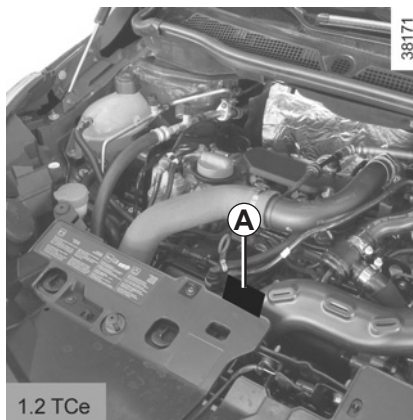
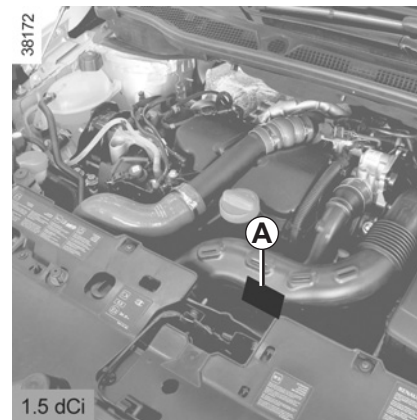

DIMENSIONS (in metres)

38173

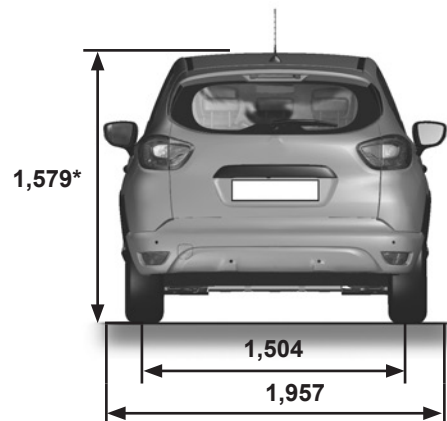
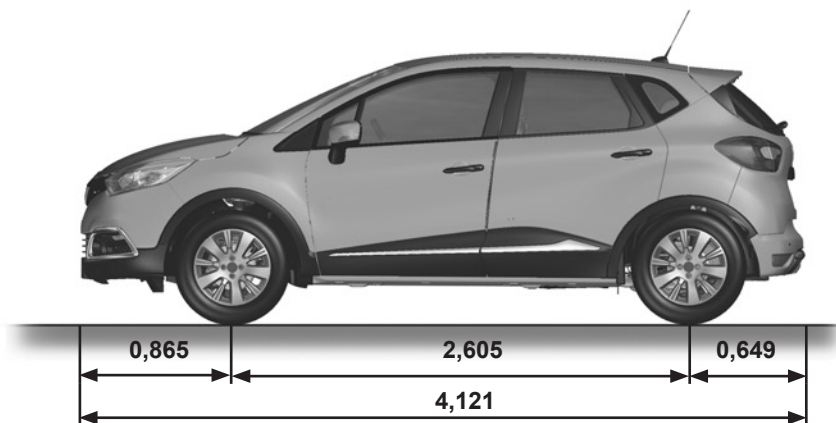

* unladen

ENGINE SPECIFICATIONS

Versions	0.9 TCe	1.2 TCe	1.5 dCi
Engine type (see engine plate)	H4B Turbo	H5F Turbo	K9K Turbo
Cubic capacity (cc)	898	1 197	1461
Type of fuel Octane rating	<p>It is essential that you use unleaded petrol of the octane rating stated on the label inside the fuel filler flap.</p> <p>If not available, unleaded fuel with an octane rating 91 may exceptionally be used for labels indicating 95 or 98.</p>	<p>It is essential that you use unleaded petrol of the octane rating stated on the label inside the fuel filler flap.</p> <p>If not available, for a limited time only, use unleaded fuel:</p> <ul style="list-style-type: none"> – with an octane rating of 91 for a label with the ratings 95 or 98, – with an octane rating of 87 for a label with the ratings 91, 95 or 98. 	<p>Diesel: the label located in the fuel filler flap indicates authorised fuels.</p>
Spark plugs	<p>Only use the spark plugs specified for your vehicle's engine.</p> <p>The type should be marked on a label affixed inside the engine compartment. If it is not then contact an approved Dealer.</p> <p>Fitting spark plugs other than those specified may damage the engine.</p>		–

WEIGHTS (in kg)

The weights indicated for a basic vehicle without options: they vary depending on the your vehicle's equipment. Consult your approved Dealer.

Maximum permissible all-up weight (MMAC) Maximum permissible all-up weight (MMTA) Gross Train Weight (MTR)	Weights are indicated on the vehicle identification plate (refer to the information on "Vehicle identification plates" in Section 6)
Braked Trailer Weight*	found by calculating: MTR - MMAC
Unbraked Trailer Weight*	575
Permissible nose weight*	60
Maximum permissible load on roof	80 kg (including the carrying device)

* Towing weight (towing a caravan, boat, etc.)

Towing is prohibited when the $MTR - MMAC$ calculation is equal to zero, or when the MTR is equal to zero (or is not listed) on the identification plate.

- It is important to comply with the towing weights, governed by local legislation in each country and, in particular, laid down in the Road Traffic Regulations. Contact an approved Dealer about any towing equipment.
- When towing, under no circumstances may **the total train weight (vehicle + trailer) be exceeded**. However the following is permitted:
 - rear axle MMTA exceeded by no more than 15%,
 - maximum MMAC exceeded by no more than 10% or 100 kg (whichever is reached first).In either case, the maximum speed of the vehicle and trailer must not exceed 60 mph (100 km/h) and the tyre pressures must be increased by 0.2 bar (3 PSI).
- The engine output and climbing capability are reduced with altitude. We recommend that the maximum load be reduced by 10% at an altitude of 1,000 metres and by an additional 10% for each 1,000 metres thereafter.

Weight transfer (except utility version)

Depending on the local legislation, if the Maximum Authorised Mass of the vehicle has not been reached, up to 300 kg can be transferred to the braked trailer, within the limits of the Gross Train Weight.

REPLACEMENT PARTS AND REPAIRS

Original parts are based on strict specifications and are subject to highly-specialised tests. Therefore, they are of at least the same level of quality as the parts fitted originally.

If you always fit genuine replacement parts to your vehicle, you will ensure that it performs well. Furthermore, repairs carried out within the manufacturer's Network using original parts are guaranteed according to the conditions set out on the reverse of the repair order.

SERVICE SHEETS (1/6)

VIN:

Date: _____ Miles (Km): _____		Invoice number: _____		Comments/miscellaneous	
Type of operation:		Stamp			
Service <input type="checkbox"/>					
..... <input type="checkbox"/>					
Anti-corrosion check:					
OK <input type="checkbox"/> Not OK* <input type="checkbox"/>					
*See specific page					

Date: _____ Miles (Km): _____		Invoice number: _____		Comments/miscellaneous	
Type of operation:		Stamp			
Service <input type="checkbox"/>					
..... <input type="checkbox"/>					
Anti-corrosion check:					
OK <input type="checkbox"/> Not OK* <input type="checkbox"/>					
*See specific page					

Date: _____ Miles (Km): _____		Invoice number: _____		Comments/miscellaneous	
Type of operation:		Stamp			
Service <input type="checkbox"/>					
..... <input type="checkbox"/>					
Anti-corrosion check:					
OK <input type="checkbox"/> Not OK* <input type="checkbox"/>					
*See specific page					

SERVICE SHEETS (2/6)

VIN:

Date: _____ Miles (Km): _____		Invoice number: _____		Comments/miscellaneous	
Type of operation:		Stamp			
Service <input type="checkbox"/>					
..... <input type="checkbox"/>					
Anti-corrosion check:					
OK <input type="checkbox"/> Not OK* <input type="checkbox"/>					
*See specific page					
Date: _____ Miles (Km): _____		Invoice number: _____		Comments/miscellaneous	
Type of operation:		Stamp			
Service <input type="checkbox"/>					
..... <input type="checkbox"/>					
Anti-corrosion check:					
OK <input type="checkbox"/> Not OK* <input type="checkbox"/>					
*See specific page					
Date: _____ Miles (Km): _____		Invoice number: _____		Comments/miscellaneous	
Type of operation:		Stamp			
Service <input type="checkbox"/>					
..... <input type="checkbox"/>					
Anti-corrosion check:					
OK <input type="checkbox"/> Not OK* <input type="checkbox"/>					
*See specific page					

SERVICE SHEETS (3/6)

VIN:

Date: _____ Miles (Km): _____		Invoice number: _____		Comments/miscellaneous	
Type of operation:		Stamp			
Service <input type="checkbox"/>					
..... <input type="checkbox"/>					
Anti-corrosion check:					
OK <input type="checkbox"/> Not OK* <input type="checkbox"/>					
*See specific page					

Date: _____ Miles (Km): _____		Invoice number: _____		Comments/miscellaneous	
Type of operation:		Stamp			
Service <input type="checkbox"/>					
..... <input type="checkbox"/>					
Anti-corrosion check:					
OK <input type="checkbox"/> Not OK* <input type="checkbox"/>					
*See specific page					

Date: _____ Miles (Km): _____		Invoice number: _____		Comments/miscellaneous	
Type of operation:		Stamp			
Service <input type="checkbox"/>					
..... <input type="checkbox"/>					
Anti-corrosion check:					
OK <input type="checkbox"/> Not OK* <input type="checkbox"/>					
*See specific page					

SERVICE SHEETS (4/6)

VIN:

Date: _____ Miles (Km): _____		Invoice number: _____		Comments/miscellaneous	
Type of operation:		Stamp			
Service <input type="checkbox"/>					
..... <input type="checkbox"/>					
Anti-corrosion check:					
OK <input type="checkbox"/> Not OK* <input type="checkbox"/>					
*See specific page					

Date: _____ Miles (Km): _____		Invoice number: _____		Comments/miscellaneous	
Type of operation:		Stamp			
Service <input type="checkbox"/>					
..... <input type="checkbox"/>					
Anti-corrosion check:					
OK <input type="checkbox"/> Not OK* <input type="checkbox"/>					
*See specific page					

Date: _____ Miles (Km): _____		Invoice number: _____		Comments/miscellaneous	
Type of operation:		Stamp			
Service <input type="checkbox"/>					
..... <input type="checkbox"/>					
Anti-corrosion check:					
OK <input type="checkbox"/> Not OK* <input type="checkbox"/>					
*See specific page					

SERVICE SHEETS (5/6)

VIN:

Date: _____ Miles (Km): _____		Invoice number: _____		Comments/miscellaneous	
Type of operation:		Stamp			
Service <input type="checkbox"/>					
..... <input type="checkbox"/>					
Anti-corrosion check:					
OK <input type="checkbox"/> Not OK* <input type="checkbox"/>					
*See specific page					
Date: _____ Miles (Km): _____		Invoice number: _____		Comments/miscellaneous	
Type of operation:		Stamp			
Service <input type="checkbox"/>					
..... <input type="checkbox"/>					
Anti-corrosion check:					
OK <input type="checkbox"/> Not OK* <input type="checkbox"/>					
*See specific page					
Date: _____ Miles (Km): _____		Invoice number: _____		Comments/miscellaneous	
Type of operation:		Stamp			
Service <input type="checkbox"/>					
..... <input type="checkbox"/>					
Anti-corrosion check:					
OK <input type="checkbox"/> Not OK* <input type="checkbox"/>					
*See specific page					

SERVICE SHEETS (6/6)

VIN:

Date: _____ Miles (Km): _____		Invoice number: _____		Comments/miscellaneous	
Type of operation:		Stamp			
Service <input type="checkbox"/>					
..... <input type="checkbox"/>					
Anti-corrosion check:					
OK <input type="checkbox"/> Not OK* <input type="checkbox"/>					
*See specific page					
Date: _____ Miles (Km): _____		Invoice number: _____		Comments/miscellaneous	
Type of operation:		Stamp			
Service <input type="checkbox"/>					
..... <input type="checkbox"/>					
Anti-corrosion check:					
OK <input type="checkbox"/> Not OK* <input type="checkbox"/>					
*See specific page					
Date: _____ Miles (Km): _____		Invoice number: _____		Comments/miscellaneous	
Type of operation:		Stamp			
Service <input type="checkbox"/>					
..... <input type="checkbox"/>					
Anti-corrosion check:					
OK <input type="checkbox"/> Not OK* <input type="checkbox"/>					
*See specific page					

ANTICORROSION CHECK (1/5)

If the continuation of the warranty is subject to repair, it is indicated below.

VIN:

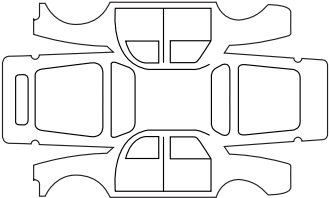
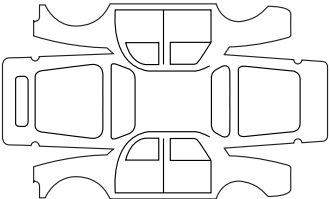
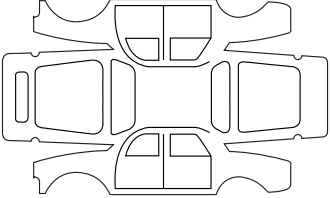
Corrosion repair operation to be carried out:		
Corrosion repair operation to be carried out:		Stamp
Date of repair:		
Repair to be carried out:		
Repair to be carried out:		Stamp
Date of repair:		
Repair to be carried out:		
Repair to be carried out:		Stamp
Date of repair:		

ANTICORROSION CHECK (2/5)

If the continuation of the warranty is subject to repair, it is indicated below.

VIN:

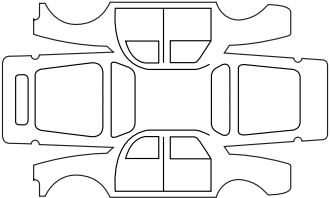
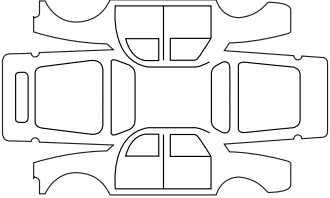
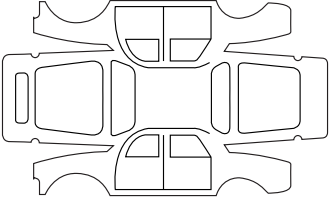
Corrosion repair operation to be carried out:		
Corrosion repair operation to be carried out:		Stamp
Date of repair:		
Repair to be carried out:		
Repair to be carried out:		Stamp
Date of repair:		
Repair to be carried out:		
Repair to be carried out:		Stamp
Date of repair:		

ANTICORROSION CHECK (3/5)

If the continuation of the warranty is subject to repair, it is indicated below.

VIN:

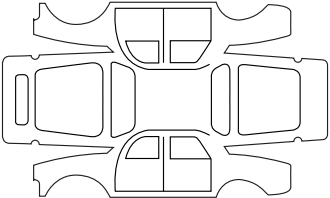
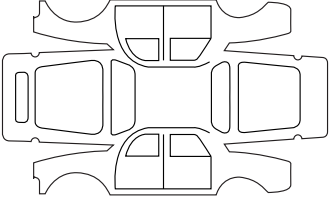
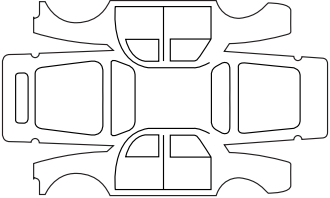
Corrosion repair operation to be carried out:		
Corrosion repair operation to be carried out:		Stamp
Date of repair:		
Repair to be carried out:		
Repair to be carried out:		Stamp
Date of repair:		
Repair to be carried out:		
Repair to be carried out:		Stamp
Date of repair:		

ANTICORROSION CHECK (4/5)

If the continuation of the warranty is subject to repair, it is indicated below.

VIN:

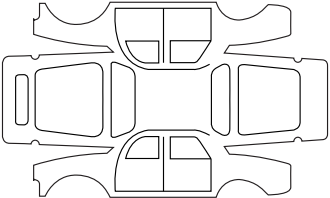
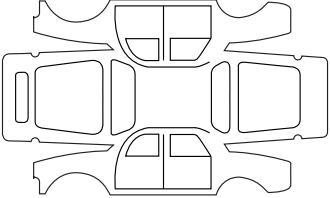
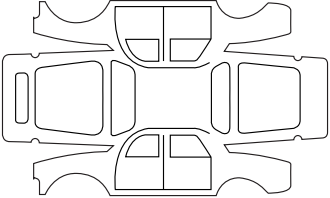
Corrosion repair operation to be carried out:		Stamp
Date of repair:		
Repair to be carried out:		Stamp
Date of repair:		
Repair to be carried out:		Stamp
Date of repair:		

ANTICORROSION CHECK (5/5)

If the continuation of the warranty is subject to repair, it is indicated below.

VIN:

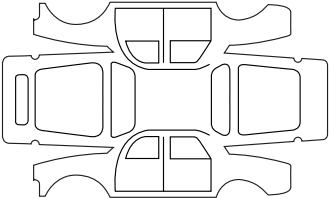
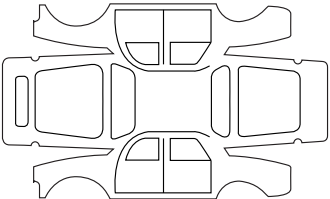
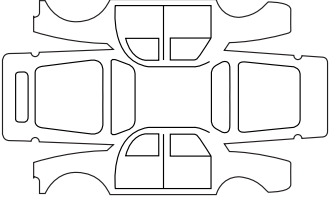
Corrosion repair operation to be carried out:		
Corrosion repair operation to be carried out:		Stamp
Date of repair:		
Repair to be carried out:		
Repair to be carried out:		Stamp
Date of repair:		
Repair to be carried out:		
Repair to be carried out:		Stamp
Date of repair:		

ALPHABETICAL INDEX (1/5)

A

ABS	1.44, 2.18 → 2.21
accessories	5.27
accessories socket	3.20
additional methods of restraint	1.25
side protection	1.24
to the front seat belts	1.19 → 1.22
to the rear seat belts	1.23
adjusting your driving position	1.14 → 1.18, 3.21
advice on antipollution	2.14 → 2.16
air bag	1.19 → 1.25, 1.42
activating the front passenger air bags	1.37
deactivating the front passenger air bags	1.35
air conditioning	3.4 → 3.11
air vents	3.2 – 3.3
anti-corrosion check	6.14 → 6.18
anti-corrosion protection	4.11
anti-lock braking system: ABS	2.18 → 2.21
antipollution	
advice	2.14
armrest:	
front	3.16
ashtray	3.20
ASR (traction control)	2.18 → 2.21
audible and visual signals	1.64
automatic gearbox (use)	2.33 → 2.35
automatic gearbox selector lever	2.33 → 2.35

B

battery	4.10, 5.24 – 5.25
troubleshooting	5.24 – 5.25
bonnet	4.2
brake fluid	4.7
bulbs	
changing	5.13 → 5.19

C

catalytic converter	2.9 – 2.10
central door locking	1.4 → 1.8, 1.11 → 1.13
changing a bulb	5.13 → 5.19
changing a wheel	5.8 – 5.9
changing gear	2.11, 2.33 → 2.35
child restraint/seat	1.26 – 1.27, 1.29 → 1.35
child safety	1.7, 1.10, 1.22, 1.26 – 1.27, 1.29 → 1.35, 2.3, 3.12 – 3.13
child seats	1.26 – 1.27, 1.29 → 1.34
children	1.2, 1.7, 1.26 – 1.27, 3.12 – 3.13
children (safety)	1.2, 1.10
cigar lighter	3.20
cleaning:	
inside the vehicle	4.13 – 4.14
clock	1.58 – 1.59
closing the doors	1.9 → 1.13
control instruments	1.42 → 1.48, 1.58 – 1.59
controls	1.38 → 1.41
courtesy light	3.14, 5.18
courtesy mirrors	3.19
cruise control	1.45, 2.25 → 2.28
cruise control-speed limiter	2.22 → 2.28

D

dashboard	1.38 → 1.41
deadlocking the doors	1.8
demisting	
rear screen	3.4, 3.7 → 3.10
windscreen	3.5, 3.7 → 3.10
dimensions	6.4
dipstick	4.3
display	1.42 → 1.46
doors/tailgate	1.2 → 1.13
driver's position	1.38 → 1.45

ALPHABETICAL INDEX (2/5)

driving 2.2 → 2.5, 2.9 – 2.10, 2.14 → 2.16, 2.18 → 2.30,
2.33 → 2.35
driving position
 settings 1.16 → 1.18

E

electric beam height adjustment 1.65 – 1.66
electric windows 3.12 – 3.13
electronic stability control: ESC 2.18 → 2.21
emergency brake assist 2.18 → 2.21
emergency braking 2.18 → 2.21
emergency key 1.2 – 1.3
emergency spare wheel 5.2
engine
 technical specifications 6.5
engine coolant 4.6
engine oil 4.3 → 4.5
engine oil capacity 4.4 – 4.5
engine oil level 4.3 → 4.5
engine specifications 6.3, 6.5
engine standby 2.6 → 2.8
engine start/stop button 2.3 → 2.5
environment 2.17
ESC: electronic stability control 1.44, 2.18 → 2.21
external temperature 1.59

F

faults
 operating faults 5.32 → 5.37
filter
 air filter 4.8
 oil filter 4.4 – 4.5
 passenger compartment filter 4.8
fitting a radio 5.26
fittings 3.15 → 3.19
front passenger air bag deactivation 1.35

front seat adjustment 1.15
front seats 4.15
 adjustment 1.14 → 1.16
fuel
 advice on fuel economy 2.14
 filling 1.42, 1.70 → 1.72
 grade 1.70 → 1.72
fuel economy 2.14 → 2.16
fuel filler cap 1.70 → 1.72
fuel level 1.42 → 1.46
fuel tank
 capacity 1.70
fuel tank capacity 1.70 → 1.72
fuses 5.21 → 5.23

G

gear lever 2.11

H

handbrake 2.11
hands-free telephone integrated control 3.31
hazard warning lights signal 1.64
headlight beam adjustment 1.65 – 1.66
headrest 1.14, 3.21
heated seats 1.15
heated windscreen 3.7 → 3.10
heating and air conditioning system 3.4 → 3.11
heating system 3.4 → 3.11
Hill Start Assist 2.18 → 2.21
horn 1.64
horn:
 flash 1.64
hubcap tool 5.6 – 5.7

I

indicators 1.64, 5.13 → 5.17

ALPHABETICAL INDEX (3/5)

indicators:

direction indicators.....	1.64
instrument panel.....	1.42 → 1.48
instrument panel.....	1.42 → 1.56
instrument panel messages.....	1.47 → 1.56
interior trim	
maintenance.....	4.13 – 4.14
Isofix.....	1.29 – 1.30

J

jack.....	5.6
-----------	-----

L

levels.....	4.6 → 4.8
levels:	

brake fluid.....	4.7
coolant.....	4.6
windscreen washer reservoir.....	4.8

lifting the vehicle

changing a wheel.....	5.8 – 5.9
-----------------------	-----------

lighting:

exterior.....	1.61 → 1.66
instrument panel.....	1.61
interior.....	3.14, 5.18 – 5.19

lights

adjustment.....	1.65 – 1.66
changing bulbs.....	5.13 → 5.15
front.....	5.13 → 5.15

lights:

adjusting.....	1.65 – 1.66
brake lights.....	5.16 – 5.17
dipped beam headlights.....	1.42, 1.61, 5.13 → 5.15
direction indicators.....	1.42, 1.64, 5.13 → 5.16
fog lights.....	1.42, 1.63, 5.17
hazard warning.....	1.64
main beam headlights.....	1.42, 1.61, 5.13

reversing lights.....	5.17
side lights.....	1.61, 5.13 → 5.16
load permitted on the roof.....	6.6
locking the doors.....	1.2 → 1.13

M

maintenance:

bodywork.....	4.11 – 4.12
interior trim.....	4.13 – 4.14
mechanical.....	4.3, 4.10, 6.8 → 6.13
map reading lights.....	3.14
methods of restraint in addition to the seat belts...1.19 → 1.25	
mobile floor.....	3.26
multimedia equipment.....	3.31, 5.26

N

navigation system.....	3.31
------------------------	------

O

oil change.....	4.4 – 4.5
opening the doors.....	1.9 → 1.12
operating faults.....	1.42 → 1.45, 5.32 → 5.37

P

paintwork

maintenance.....	4.11 – 4.12
parking distance control.....	2.29 – 2.30
power-assisted steering.....	1.57
pretensioners.....	1.19 → 1.22
puncture.....	5.2, 5.6, 5.8 – 5.9

R

radio.....	3.31
rear bench seat.....	3.22 – 3.23, 4.18 – 4.19
rear parcel shelf.....	3.25
rear seat.....	4.18 – 4.19

ALPHABETICAL INDEX (4/5)

rear seats.....	1.18
functions	3.22 – 3.23
rear view mirrors.....	1.60
RENAULT ANTI-INTRUDER DEVICE (RAID).....	1.13
RENAULT card	
battery.....	5.20
use	1.2 → 1.8, 2.3 → 2.5
RENAULT card battery.....	5.20
replacement parts.....	6.7
reverse gear	
selecting.....	2.11, 2.33 → 2.35
reversing sensor.....	2.29 – 2.30
roof bars.....	3.30
roof rack	
roof bars.....	3.30
running in.....	2.2

S

seat belt pretensioners	
front seat belt.....	1.19 → 1.22
seat belts	1.16 → 1.22, 1.25
seat trim.....	4.15 → 4.19
seats: trim.....	4.15 → 4.19
service sheets.....	6.8 → 6.13
side protection devices.....	1.24
signals and lights.....	1.61 → 1.66
speakers	
location	5.26
special features of diesel versions.....	2.10
special features of petrol vehicles	2.9
speed limiter.....	1.45, 2.22 → 2.24
starting the engine.....	2.3 → 2.8
steering wheel	
adjustment	1.57
Stop & Start.....	1.45, 2.6 → 2.8
Stop & Start function.....	2.6 → 2.8

stopping the engine.....	2.3 → 2.5
storage compartment.....	3.15 → 3.19
storage compartments.....	3.15 → 3.19
sun visor.....	3.19
switching on the vehicle ignition.....	2.3 → 2.5

T

tailgate.....	3.24, 3.26 → 3.28
tanks and reservoirs	
brake fluid.....	4.7
coolant.....	4.6
tanks and reservoirs:	
windscreen washer.....	4.8
technical specifications.....	6.4 → 6.7
telephone.....	3.31
temperature regulation.....	3.7 → 3.11
tool kit.....	5.6
towing	
breakdown.....	5.30 – 5.31
towing equipment.....	3.29
towing a caravan.....	3.29, 6.6
towing equipment	
fitting.....	3.29
towing hitch.....	5.6, 5.30 – 5.31
towing rings.....	3.28
towing weights.....	6.6
traction control: ASR.....	2.18 → 2.21
transporting children.....	1.26 – 1.27, 1.29 → 1.35
transporting objects	
in the luggage compartment.....	3.28
on the roof.....	6.6
trims.....	5.7
trip computer and warning system... ..	1.42 → 1.45, 1.47 → 1.56
tyre inflation kit.....	5.3 → 5.5
tyre pressure.....	4.9, 5.11
tyre pressures.....	4.9

ALPHABETICAL INDEX (5/5)

tyres4.9, 5.10 → 5.12

U

unlocking the doors 1.11 – 1.12

V

variable power-assisted steering 1.57

vehicle identification plates 6.3

ventilation3.2 → 3.11

W

warning lights1.42 → 1.56

washing 4.11 – 4.12

weights 6.6

wheelbrace 5.6

wheels (safety)5.10 → 5.12

windscreen de-icing/demisting3.7 → 3.10

windscreen washer1.67 → 1.69

wiper blades 5.28 – 5.29

wipers1.67 → 1.69

 blades 5.28 – 5.29

(www.renault.ie) (www.renault.co.uk) (www.renault.is)



9 9 9 1 0 8 5 7 3 R

L2