



RENAULT
Clio





**RENAULT
recommends**



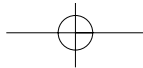

*Welcome to your new **RENAULT***

This driver's handbook contains all the information you will need:

- to get to know your Renault, to use it to the best advantage and to benefit from all the latest technical developments which are incorporated in it.
- to ensure that it is always running well by following the simple, but strict, advice concerning regular maintenance.
- to enable you to deal quickly with minor faults which do not require specialist attention.

The few minutes you spend reading this handbook will be amply rewarded by the information which it provides and the technical innovations it will bring to your attention. If certain points are still unclear, the technicians in our Network will be happy to provide you with any additional information you may require.

The following symbols are used in this handbook to help you while you are reading it:



To indicate a risk, danger or safety advice.

The description of the models given in this handbook is based on the technical specifications known at the date this document was produced. **The handbook covers all equipment** (standard or optional) **which is available for these models, but their presence on the vehicle depends on the version, options selected and country of marketing. Certain equipment which is due to be made available during the year may also be included in this handbook.**

Enjoy driving your new Renault.

Copying or translation, in part or in full, is forbidden without written permission from Renault, 92100 Billancourt 2002.

0.01

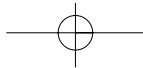

Brief overview

	• Tyre pressures	0.04 - 0.05
	• Adjusting the seats and driving position	1.11 → 1.14
	• Child restraints	1.24 → 1.36
	• Warning lights	1.42 → 1.52
	• Horn and headlamp flash	1.55 → 1.57 - 1.62
	• De-icing	1.61
	• Running in, driving	2.02 → 2.30
	• Heating/air conditioning	3.04 → 3.22
	• Opening the bonnet	4.02
	• Levels (engine oil, windscreen washer, etc.)	4.03 → 4.11
	• Emergency spare wheel	5.02 → 5.05
	• Practical advice (changing the bulbs, fuses, repairs, operating incidents)	5.02 → 5.34





C O N T E N T S

Sections

Getting to know your car	1
Driving	2
Your comfort	3
Maintenance	4
Practical advice	5
Technical specifications	6
Alphabetical index	7

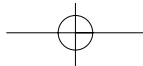

Tyre inflation pressures when cold (in bar)

Versions	1.2 1.2 16V	1.4 16V 1.6 16V	2.0 16V		1.5 dCi 1.9 dCi
Tyre sizes	175/65 R14 T 185/55 R15 H	175/65 R14 T 185/55 R15 H	195/45 R16	195/50 R15	175/65 R14 T 185/55 R15 H
Normal use (2) • Front • Rear	1.9 1.8	2.2(1) 2	2.3 2.1	2.3 2.1	2.2 2
Motorway use (2) • Front • Rear	2 2	2.3(1) 2.1(1)	2.7 2.2	2.5 2.2	2.3 2.1
Wheel sizes	5.5 J 14 6.0 J 15		7 J 16	7 J 16	5.5 J 14 6.0 J 15

Tyre safety and use of chains

Refer to the information on tyres in Section 5 for information on maintenance and, depending on the version, the conditions under which snow chains may be fitted to the vehicle.

Special features of the 2.0 16V version

The tyres on this vehicle cannot be fitted with chains. If you wish to fit snow chains, you must use **special equipment**. Consult your Renault Dealer.

(1) **Vehicle with automatic transmission:** add **0.1 bar**.

(2) **Special note concerning vehicles used under full load (maximum permissible all-up weight) and towing a trailer:** Maximum speed must be limited to 60 mph (100 km/h) and the tyre pressure increased by **0.2 bar** (or **3 PSI**). Refer to the information on weights in Section 6 for more details.

0.04

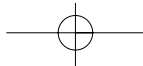

Tyre pressures when cold (in PSI) (continued)

Versions	1.2 1.2 16V	1.4 16V 1.6 16V	2.0 16V		1.5 dCi 1.9 dCi
Tyre sizes	175/65 R14 T 185/55 R15 H	175/65 R14 T 185/55 R15 H	195/45 R16	195/50 R15	175/65 R14 T 185/55 R15 H
Normal use					
• Front	28	32 (1)	33	33	32
• Rear	26	29	30	30	29
Motorway use (2)					
• Front	29	33 (1)	39	36	33
• Rear	28	30 (1)	32	32	30
Wheel sizes	5.5 J 14 6.0 J 15		7 J 16	7 J 16	5.5 J 14 6.0 J 15

Tyre safety and use of chains

Refer to the information on tyres in Section 5 for information on maintenance and, depending on the version, the conditions under which snow chains may be fitted to the vehicle.

Special features of the 2.0 16V version

The tyres on this vehicle cannot be fitted with chains. If you wish to fit snow chains, you must use **special equipment**. Consult your Renault Dealer.

(1) **Vehicle with automatic transmission: add 3 PSI.**

(2) **Special note concerning vehicles used under full load (maximum permissible all-up weight) and towing a trailer:** Maximum speed must be limited to 60 mph (100 km/h) and the tyre pressure increased by **0.2 bar (or 3 PSI)**. Refer to the information on weights in Section 6 for more details.

0.05

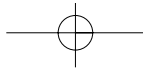

0.06

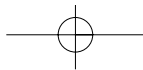

Section 1: Getting to know your car

Keys - plip remote control unit	1.02 - 1.03
Doors	1.04 - 1.05
Automatic locking of doors when driving	1.06
Engine immobiliser system	1.07 - 1.08
Head restraints - Seats	1.09 → 1.12
Seat belts/Methods of restraint in addition to the front seat belts	1.13 → 1.23
Child safety	1.24 → 1.36
Clock and external temperature	1.37
Driving position	1.38 → 1.41
Instruments	1.42 → 1.49
On-board computer	1.50 → 1.52
Rear-view mirrors	1.53 - 1.54
Steering wheel	1.54
Lighting and external signals	1.55 - 1.56
Headlight beam adjustment	1.57
Wipers	1.58 → 1.60
De-icing	1.61
Visible and audible warning signals	1.62
Fuel tank (filling with fuel)	1.63 - 1.64
	1.01

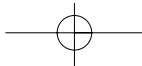

KEYS / RADIO FREQUENCY REMOTE CONTROL

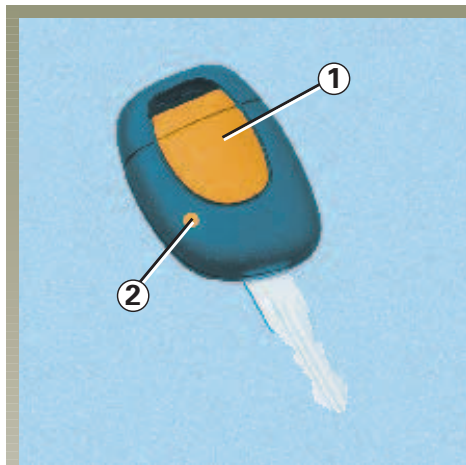

1 Remote control coded ignition key, key for doors and fuel filler cap.

The plip remote control **1** locks and unlocks the doors.

It is supplied with power by a battery which has to be replaced when the battery tell-tale light **2** no longer comes on. (Refer to the information on the radio frequency remote control batteries.)

Locking/unlocking the doors

Press the remote control for approximately one second to lock or unlock the doors. (Tell-tale light **2** will switch on.)

- The hazard warning lights flash **twice** to indicate that the doors have been **locked**.

Note: Depending on the vehicle, if either a door or tailgate is open or not properly closed or if a rear interior light remains in the "continuous lighting" position (see information on interior lights in section 3), the hazard warning lights will not flash.

- The hazard warning lights flash **once** to indicate that the doors have been **unlocked**.



If there is a child (or animal) in the car, never leave it unattended with the key in the ignition. With the key in the ignition it would be possible to operate electrical equipment such as the window risers and there is a risk that the child may be seriously injured (by trapping his or her neck, arm, hand, etc.).

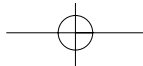

RADIO FREQUENCY REMOTE CONTROL (continued)

The range within which the remote control will operate

This varies according to the environment: therefore take care when handling the remote control that you do not inadvertently lock or unlock the doors.

Note: On certain vehicles, if a door is not opened within approximately 30 seconds of unlocking the door using the remote control, the doors will lock again automatically.

Interference

Interference may be caused to the operation of the remote control by factors in the immediate vicinity (external installations or the use of equipment operating on the same frequency as the remote control).

If you lose your keys or need another set of keys (or a remote control), contact your RENAULT Dealer.

- If a remote control unit is replaced, it will be necessary to take the vehicle to your RENAULT Dealer because both the vehicle and all the remote control units are needed to initialise the system.
- No more than two remote controls can be used on one vehicle.
- Make sure that the batteries are always in good condition - they last for approximately two years.

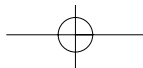

OPENING THE DOORS

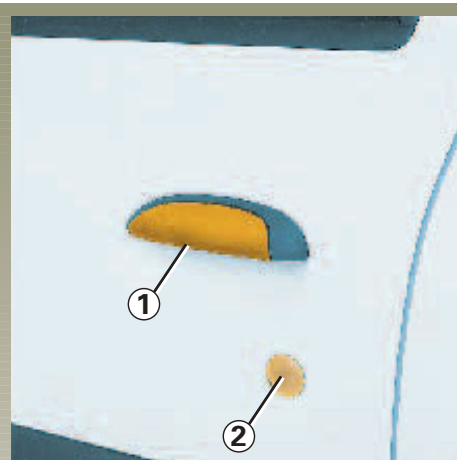

Opening the doors from the outside

Front: Use the key to unlock the front door lock **2**. Slip your hand under the handle **1** and pull it towards you.

Rear: When the front door is open, lift the unlocking knob **3** from inside and pull the door handle.

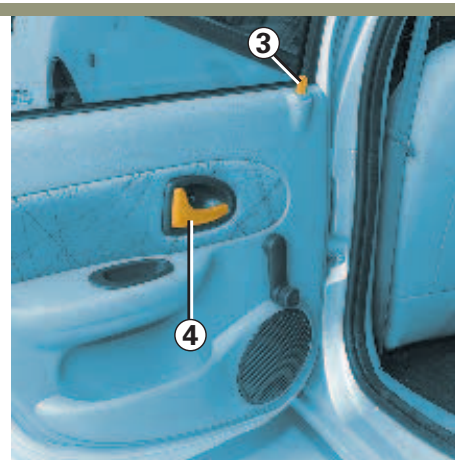

Opening the doors from inside the vehicle

Move handle **4**.

Lights on warning buzzer

If you have left the lights switched on after turning off the ignition, a warning buzzer will sound when a door is opened (risk of battery discharge).

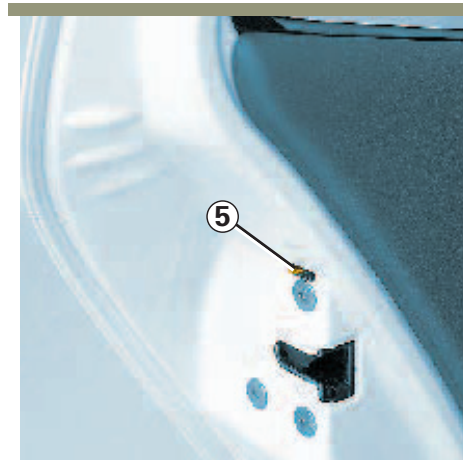

Childproof locks

To prevent the rear doors being opened from inside the vehicle, move lever **5** on each door and check from inside the car that both doors are securely locked.



LOCKING THE DOORS

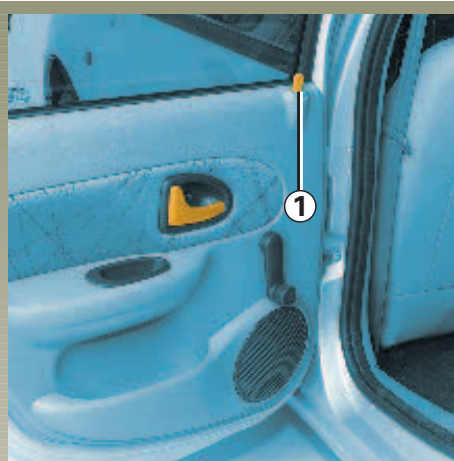

Manual locking

Front: Use the key from the outside.

Rear: Press down knob **1** in each door.



Electric central locking



This enables the doors and the luggage compartment to be locked or unlocked simultaneously. Lock by pressing the indicator light on switch **2**.

The front door mechanism cannot be locked if the door is open.

Opening status warning light

The warning light on switch **2** informs you of the closure status of the doors and tailgate:

- the light comes on when the doors are locked;
- when a door is opened (or incorrectly closed) the indicator light goes out.

When you lock the doors using the plip remote control, the indicator light remains lit for approximately one minute then goes out.



If you decide to keep the doors locked when you are driving, remember that it may be more difficult for those assisting you to gain access to your vehicle in the event of an emergency.

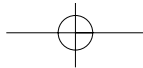

AUTOMATIC LOCKING OF DOORS, ETC. WHEN DRIVING

You must first decide if you want to activate this function.

To activate

With the ignition on, press the central door locking button **1** for approximately 5 seconds, until you hear the beep.

To deactivate

With the ignition on, press the central door locking button **1** for approximately 5 seconds, until you hear the beep.



Operating incident

If you note that the system is not operating correctly (automatic locking does not take place, the indicator light on button **1** does not light up when the doors, etc. are locked), first of all check that all the doors, etc. are properly closed. However, if they are closed correctly, consult your Renault Dealer.

Also make sure that locking has not been deactivated inadvertently. If this occurs, switch the ignition off and on again and reactivate it as described above.

Operating principle

When the vehicle moves off, the system automatically locks the doors, etc. as soon as a speed of 4 mph (6 km/h) is attained. The indicator light on button **1** light ups.

Unlocking occurs automatically:

- if a front door is opened.

Note: If a rear door is opened, this will be locked again automatically when the vehicle attains a speed of approximately 4 mph (6 km/h).

- by pressing the door unlocking button **1**.



If you decide to keep the doors locked when you are driving, remember that it may be more difficult for those assisting you to gain access to your vehicle in the event of an emergency.

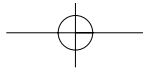

ENGINE IMMOBILISER

This prevents the engine being started by anyone who does not have the coded key for the vehicle.



Operating principle

The vehicle is automatically protected a few seconds after the key has been removed from the ignition.

When the ignition is switched on, warning light **1** comes on for a few seconds then goes out.

The vehicle has recognised the code and the engine may be started.

If the code of the ignition key is not recognised by the vehicle, warning light **1** will flash continuously and the engine cannot be started.

Indicator light

System operational indicator light

When the ignition is switched on, indicator light **1** lights up continuously for approximately three seconds and then goes out. You can then start the engine.

Vehicle protection indicator light

A few seconds after the ignition has been switched off, indicator light **1** will flash continuously.

The vehicle will not be protected until the key has been taken out of the ignition.



Any operation on or modification to the immobiliser system (computers, wiring, etc.) may be dangerous. It must be carried out by qualified RENAULT personnel.

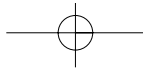

ENGINE IMMOBILISER (continued)



In all instances, you **must** contact a RENAULT Dealer, who are the only people authorised to repair the engine immobiliser system.

If the coded ignition key is faulty, use the second key (supplied with the vehicle).

Warning light to indicate that the system is not operating correctly

When the ignition has been switched on, if warning light **1** continues to flash or remains on, it indicates that the system is not operating correctly.





HEAD RESTRAINTS

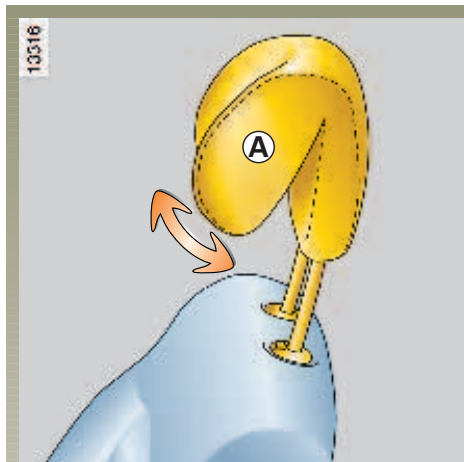

To raise or lower the headrest

Pull the headrest towards you (i.e. towards the front of the vehicle) and slide it up or down at the same time.

To adjust the angle of the headrest

On certain vehicles the angle of the headrest can be adjusted. To do this, move the front section **A** of the headrest forwards or backwards until it feels comfortable.

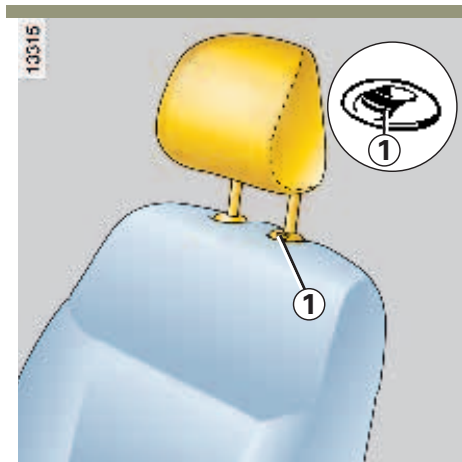

To remove the headrest

First incline the seatback towards the rear.

Raise the headrest until it is at the highest possible setting. Lift up tab **1** and then pull the headrest upwards until it is released.

To refit the headrest

Insert the rods into the sleeves, with the notches facing the front.

Lower the headrest until it locks in position.

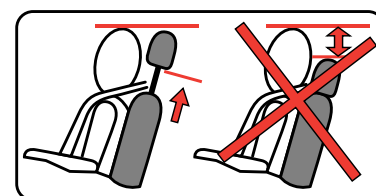

The head restraint is important for safety: ensure that it is positioned correctly. The distance between your head and the head restraint should be as small as possible, and the top of the head restraint should be as close as possible to the top of your head.

1.09



REAR HEAD RESTRAINTS



To adjust the height
Simply slide it up.

To remove it
Press tab **1**.

To refit the headrest
Insert the rods into the sleeves, with the notches to the front, and lower the headrest to the desired height.



Storage position
When the headrest is fully lowered, it is in the storage position; do not use this position when someone is sitting in the rear seats.

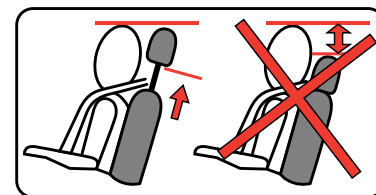

The head restraint is important for safety: ensure that it is positioned correctly. The distance between your head and the head restraint should be as small as possible, and the top of the head restraint should be as close as possible to the top of your head.



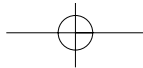

FRONT SEATS

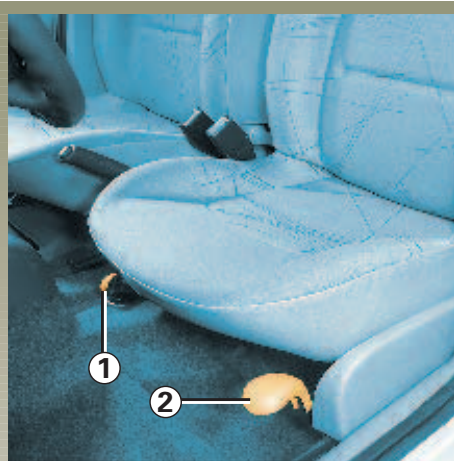

To move forwards or backwards:

Lift lever **2** to unlock the seat. Release the lever when the seat is in the required position and ensure it is locked in place.

To raise or lower the driver's seat:

Lift lever **1**.

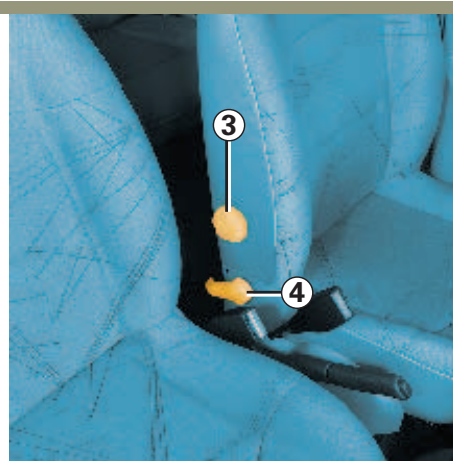

To tilt the seatback:

Move handle **4** and tilt the seat to the required position.

To adjust the lumbar support on the driver's seat:

Turn wheel **3**.



So that the effectiveness of the seat belts is not reduced, we would advise you not to recline the seatbacks excessively.

Make sure the seatback is locked in place correctly.

No objects should be placed on the floor (area in front of driver) as such objects may slide under the pedal during braking manoeuvres, thus obstructing its use.



For safety reasons, adjust the seats only when the vehicle is stationary.

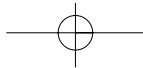

FRONT SEATS (continued)

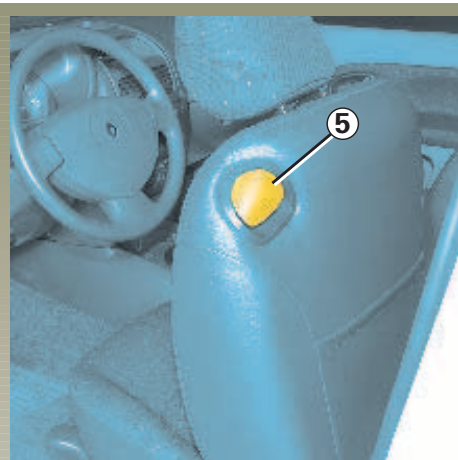

Access to the rear seats (three-door versions)

Lift lever **5** and slide the seat forwards.

To return the seat to its original position (memorised position) on the driver's side, slide the seat backwards until it locks.



Heated seats



With the ignition switched on, press the switch located on the rail cover **6**. An indicator light will light up on the instrument panel.

The system is not necessarily activated if the indicator light is lit up. The system has a thermostat and only operates when the passenger compartment temperature is less than 12°C (with a tolerance of plus or minus 4°C).



SEAT BELTS

Always wear your seat belt when travelling in your car. You must also comply with the local legislation in the particular country you are in.

Before driving off:

- First ensure that your driving position is correct.
- Then, to provide maximum safety, adjust your seat belt correctly.



Incorrectly adjusted seat belts may cause injuries in the event of an accident.

Even pregnant women should wear a seat belt. In this case, ensure that the pressure of the lap belt on the abdomen is not excessive.

Adjusting your driving position

- **Sit with your back firmly against the seatback.**

This is essential to ensure your lumbar vertebrae are in the correct position.

- **Adjust the distance between the seat and the pedals.**

Your seat should be as far back as possible to allow you to press the clutch pedal fully down. The seatback should be adjusted so that your arms remain slightly bent.

- **Adjust the position of the head restraint.**

For maximum safety, your head should be as close as possible to the head restraint.

- **Adjust the height of the seat.**

This adjustment allows you to select the seat position which offers you the best possible vision.

- **Adjust the position of the steering wheel**

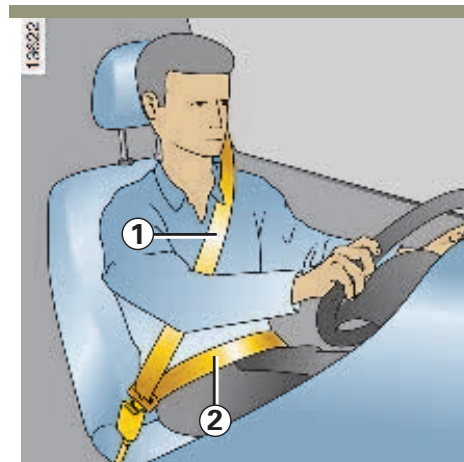

Adjusting the seat belts

Sit with your back firmly against the seatback.

The shoulder strap **1** should be as close to the base of the neck as possible but not on it.

The lap strap **2** should be held firmly over the thighs and against the pelvis.

The belt should be worn so that it is as close to the body as possible, i.e. avoid wearing heavy clothing or having bulky objects under the belts.

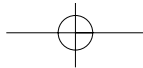

SEAT BELTS (continued)

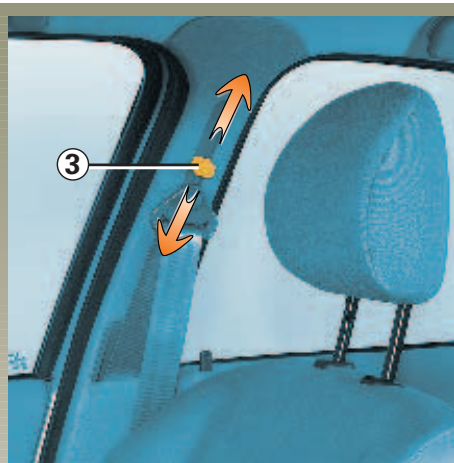

Adjusting the height of the front seat shoulder strap

Move button **3** to adjust the belt so that the shoulder strap **1** is positioned as described above.

After making the adjustment, ensure the belt is correctly locked.



Locking

Unwind the belt **slowly and smoothly** ensuring the buckle **4** clips correctly into housing **6** (check it is locked by pulling on buckle **4**). If the belt jams, allow it to return slightly before unwinding it again

Locking (continued)

- If the belt is jammed completely:
- pull slowly but firmly, to unwind just over an inch (approximately 3 cm);
 - allow the belt to rewind by itself;
 - unwind the belt once more;
 - if the problem persists, consult your RENAULT Dealer.



Driver's seat belt not fastened warning light

If the driver's seat belt is unfastened this lights up, and, when the vehicle reaches a speed of approximately 6 mph (10 km/h), it will flash and a beep will sound for approximately 90 seconds before the light returns to being permanently lit.

Unlocking

Press button **5** on housing **6**. The belt will rewind by itself.

Hold the buckle to help the action.



METHODS OF RESTRAINT IN ADDITION TO THE FRONT SEAT BELTS

These are:

- **Front seat belt pretensioners.**

- **Force limiters.**

- **Driver's and passenger airbags.**

These airbags are adaptable in that they offer a small or large volume depending on the severity of the frontal impact.

These systems are provided to act independently or together when the vehicle is subjected to a frontal impact.

Depending on the force of the impact the system may engage:

- seat belt locking;
- the buckle pretensioner (which triggers to take up the slack in the seat belt);
- the lap belt pretensioner to keep the occupant in their seat, the low volume front airbag and the load limiters;
- the large volume front airbag.

- **Side airbags** are provided to activate in the event of severe side impacts.

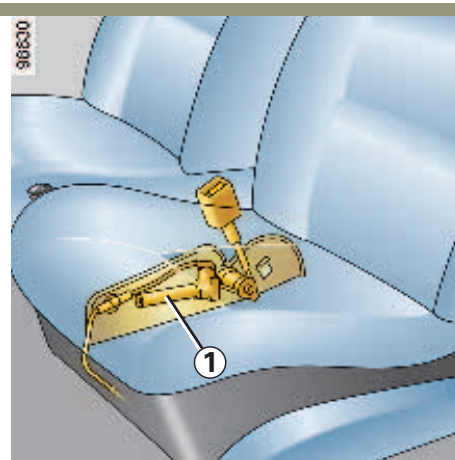

Front seat belt pretensioners

With the ignition switched on, if there is a severe frontal impact and depending on the force of the impact, the system may engage:

- the piston **1** which immediately retracts the seat belt.

The pretensioners pull the seat belt against the body, holding the occupant more securely against the seat, thus increasing the seat belt's efficiency.



- Have the entire restraint system checked following an accident.
- No operation whatsoever is permitted on any part of the system (pretensioners, airbags, computers, wiring) and the system components must not be re-used on any other vehicle, even if identical.
- To avoid premature triggering of the system which may cause injury, only qualified RENAULT Network personnel may work on the pretensioner and airbag system.
- Testing of the electric trigger system may only be carried out by a specially trained technician using special equipment.
- When the vehicle is scrapped, contact your RENAULT Dealer for disposal of the pretensioner and airbag gas generators.



METHODS OF RESTRAINT IN ADDITION TO THE FRONT SEAT BELT (continued)

Force limiter

Above a certain severity of impact, this mechanism is used to limit the force of the belt against the body so that it is at an acceptable level.



Warning relating to the service life of airbags and pretensioners

Pyrotechnic systems for airbags and pretensioners have a limited service life: refer to the servicing booklet for your vehicle for the replacement frequency.

Driver and passenger airbags

These are fitted to both the driver and the front passenger seats.

An "Airbag" marking on the steering wheel and dashboard and a label in the lower section of the windscreen inform you of the presence of additional means of restraint (airbags, pretensioners, etc.) in the passenger compartment.

Each airbag system consists of:

- an airbag and its two gas generators (for the small or large-volume bag depending on the severity of the frontal impact) mounted on the steering wheel for the driver and in the dashboard for the passenger;
- a computer for both systems, which includes the impact detector and the monitor controlling the electrical trigger system for each of the gas generators;
- A single warning light  on the instrument panel.

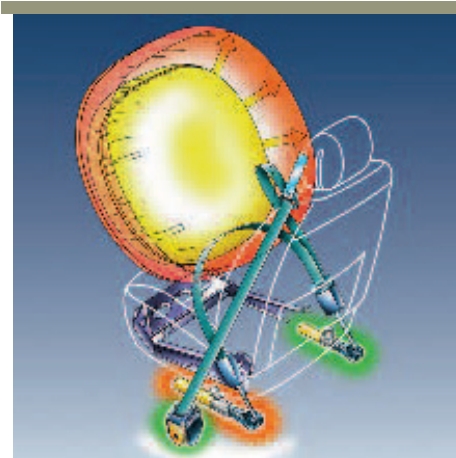

The air bag system uses the principles of pyrotechnics. This explains why, when the air bag inflates, it will generate heat, produce smoke (this does not mean that a fire is about to start) and make a noise upon detonation. In a situation where an air bag is required, it must inflate immediately and this may cause some minor, superficial grazing to the skin.



METHODS OF RESTRAINT IN ADDITION TO THE FRONT SEAT BELT (continued)

Operation

The system waits a few seconds after the ignition has been switched on before being operational.

If a severe **frontal** impact occurs, the airbag(s) inflate(s) rapidly, cushioning the impact of the driver's head and chest against the steering wheel and the front passenger's head against the dashboard. The airbag(s) then deflate(s) immediately so that the passengers are not impeded in any way when they get out of the vehicle.

The passenger airbag system is linked to a front passenger airbag deactivation warning light **2** on the instrument panel. This warning light is linked to the passenger airbag deactivation system through the ignition key.

It lights up to indicate that the passenger airbag will not be inflated in the event of an impact (refer to the section on Deactivating the front passenger airbag).

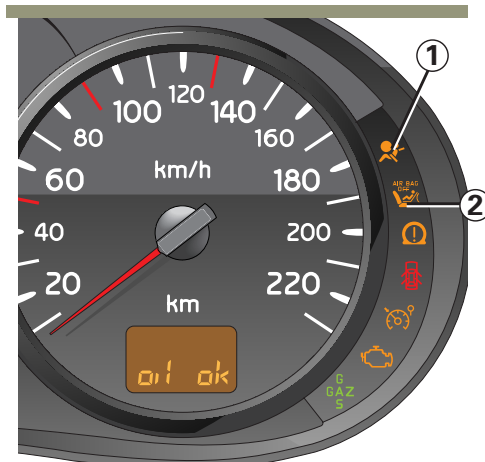

Operational incidents

Warning light **1** lights up on the instrument panel when the ignition is turned on and then goes out after a few seconds.

If it does not light up when the ignition is turned on, there is a fault in the system.

If it lights up while you are driving, stop at once and switch off the ignition.

If it is still lit up after the ignition has been switched on again, there is a fault in the system. In this case, a rear-facing child seat **MUST NOT** be fitted to the front passenger seat.

We do not recommend fitting any other kind of passenger seat device.

In both cases, consult your RENAULT Dealer as soon as possible.



METHODS OF RESTRAINT IN ADDITION TO THE FRONT SEAT BELT (continued)

All the warnings below are given so that the airbag is not obstructed in any way when it is inflated and also to prevent the risk of serious injuries caused by items which may be dislodged when the airbag inflates.



The airbag is designed to complement the action of the seat belt. Both the airbags and seat belts are integral parts of the same protection system. It is therefore essential to wear the seat belt at all times. If the seat belt is not worn, it exposes the occupants to the risk of serious injury in the event of an accident. It may also increase the risk of minor, superficial injuries occurring when the airbag is deployed, although such minor injuries are always possible with airbags.

The airbag does not offer protection against minor and moderately serious frontal impacts, side or rear impacts or if the vehicle turns over.

Airbags for driver and passenger

- **No work or modification whatsoever** may be performed on the entire airbag system for the driver and passenger (computer, wiring, etc.) except by qualified RENAULT network personnel.
- To ensure that the system is in good working order and to avoid incorrect triggering of the system which may cause injury, only qualified RENAULT network personnel may work on the airbag system.
- As a safety precaution, have the airbag system checked if your vehicle has been involved in an accident, is stolen or broken into.
- When selling or lending the vehicle, inform the user of these points and hand over this handbook with the vehicle.
- When scrapping your vehicle, contact your RENAULT Dealer for disposal of the gas generator(s).

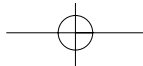

METHODS OF RESTRAINT IN ADDITION TO THE FRONT SEAT BELT (continued)

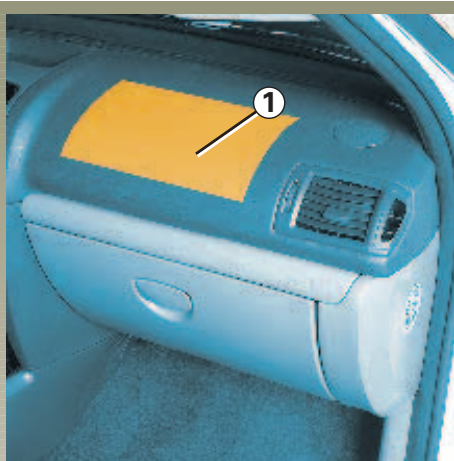

All the warnings given below are designed to ensure that the airbag can inflate correctly and to prevent serious injuries caused by items which may be dislodged when the airbag inflates.



Warnings concerning the driver's airbag

- Do not adjust either the steering wheel or the airbag cushion.
- Do not cover the airbag cushion.
- Do not attach any objects (badge, logo, clock, telephone holder, etc.) to the airbag cushion.
- The steering wheel must not be removed (except by qualified personnel from the RENAULT network).
- Do not sit too close to the steering wheel. If you sit with your arms slightly bent (see the information on Adjusting your driving position in Section 1), you will ensure that there is sufficient space for the airbag to inflate properly and to be fully effective.

Warnings concerning the passenger airbag: location 1

- Do not attach or glue any objects (badges, logo, clock, telephone holder, etc.) onto the front passenger side of the dashboard.
- Nothing should be placed between the dashboard and the passenger (pet, umbrella, walking stick, parcels, etc.).
- The passenger must not put his or her feet on the dashboard or seat as there is a risk that serious injuries may be sustained. As a general rule, keep all parts of the body (knees, hands, head, etc.) well away from the dashboard.
- You should reactivate the airbag as soon as you remove the child seat from the front passenger seat to ensure the protection of the front passenger in the event of an impact.

IT IS FORBIDDEN TO FIT A REAR-FACING CHILD SEAT ON THE FRONT PASSENGER SEAT WHILE THE RESTRAINING METHODS ADDITIONAL TO THE PASSENGER SEAT BELT ARE NOT DEACTIVATED.

(Refer to the information on Deactivation of front passenger airbags in Section 1).

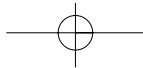

METHODS OF RESTRAINT IN ADDITION TO THE FRONT SEAT BELT (continued)

Side airbags

These airbags may be fitted to the front seats and are deployed at the sides of the seats (door side) to protect the occupants in the event of a severe side impact.



The slits on the front seatbacks (door side) and the gap between the rear bench seatback and the interior fittings form the trigger area for the airbag, so it is forbidden to place any objects there.



Warnings concerning the side airbag

- **Fitting seat covers:** Seats equipped with an airbag require special covers specifically designed for your vehicle. Consult your RENAULT Dealer to see if appropriate covers are available from RENAULT outlets. The use of any covers other than those designed for your vehicle (and including those designed for another vehicle) may affect the operation of these airbags and reduce your protection.
- Do not place any accessories, objects or pets between the seatback and the door. This may prevent the airbag from operating correctly or cause injury if the airbag is deployed.
- No work or modification whatsoever may be carried out on the seat, except by qualified RENAULT Network personnel.





METHODS OF RESTRAINT IN ADDITION TO THE REAR SEAT BELTS

Force limiter

In the event of a frontal impact above a certain severity, this mechanism is used to limit the force of the belt against the body so that it is at an acceptable level.

Rear side seat belt pretensioners

This system is only operational when the ignition is switched on.

If the vehicle is subjected to a severe impact, a device retracts the seat belt, pulling the seat belt tight against the body and thereby improving its efficiency.



Warning relating to the service life of airbags and pretensioners

Pyrotechnic systems for airbags and pretensioners have a limited service life: refer to the servicing booklet for your vehicle for the replacement frequency.

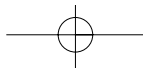

REAR SEAT BELTS

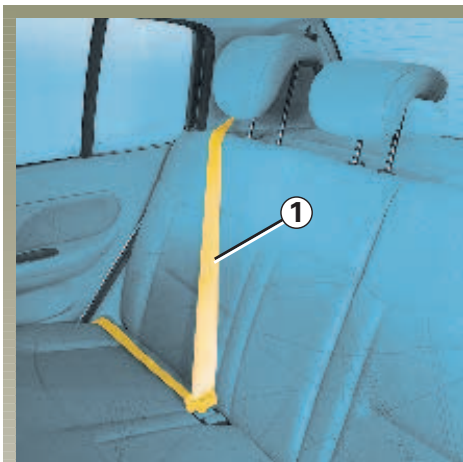

Rear side seat belts 1

The belts are locked, unlocked and adjusted in the same way as for the front seat belts.

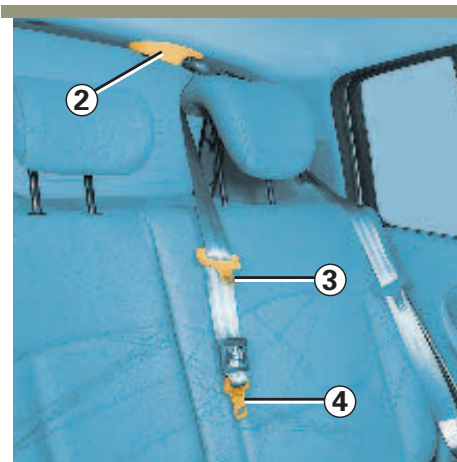

Rear central belt

Unwind the belt slowly from position **2**.

Fasten the black buckle **4** into the black housing **6**.

Fasten the last sliding buckle **2** into the red housing **5**.

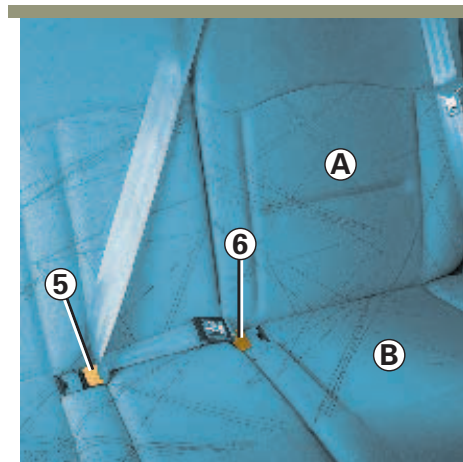

Special point concerning vehicles with a two-part rear bench seat

If you have to fold down the part of the rear bench seat behind the front left-hand seat:

- lift the cushion **B** against the front seat;
- insert the black buckle **4** into the black housing **6**;
- lower the seatback **A** (after removing the head restraint).

Then fasten the last sliding buckle **3** into the red housing **5**.



The rear bench seat must be correctly secured for the seat belts to be efficient.

Refer to the information on rear bench seats in section 3.

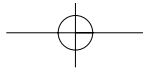

SEAT BELTS

The following information applies to both the vehicle's front and rear seat belts:



- No modifications may be made to the component parts of the original restraint systems: seat belts and their mountings.

Consult your Renault Dealer for special applications (e.g. fitting a child seat).

- Do not use any devices which give any play in the belts (clothes pegs, clips for example).
- Never wear the shoulder strap under your arm or behind your back.
- Never use the same belt for more than one person and never hold a baby or child on your knees with the seat belt around them.
- The seat belt should never be twisted.
- Following a serious accident, replace all the belts which were in use at the time. Likewise, have the belts replaced if they show any signs of wear.
- When refitting the rear bench seat, check that the seat belts are repositioned correctly, to enable them to be used properly.
- If necessary, re-adjust the position and tension of the belt.

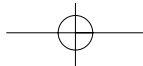

CHILD SAFETY (continued)

In all countries there are regulations governing the use of restraint systems for children and babies.

In Europe, children under 12 years of age, less than 1.50 m tall and weighing less than 36 kg⁽¹⁾ must be restrained with an approved restraint adapted to the child's weight and height.

The driver is responsible for ensuring that this equipment is used correctly.

Child restraints for which type approval was obtained after January 1992 offer a level of safety much greater than for restraints with type approval before that date.

We therefore advise you to select an approved child restraint that complies with European regulation ECE 44.

Restraints that comply with this legislation must be marked with an orange label bearing the letter E followed by a number (which stands for the country where it is an approved type) and the year in which the type approval was granted.

(1) Always comply with the laws of the country in which you are travelling. They may be different to the guidelines in this handbook.

Remember that a collision at 30 mph (50 km/h) is the same as falling a distance of 10 metres. Expressed in other terms, transporting a child without a restraint is the equivalent of allowing him or her to play on a third-floor balcony which does not have any railings.



Under no circumstances should babies or children be allowed to travel sitting on the knees of another passenger in the vehicle.

If a head-on collision occurs at 30 mph (50 km/h) a child weighing 30 kg (66 lbs) will be transformed into a missile equivalent to one tonne: you will find it impossible to hold the child, even if you yourself are wearing a belt.

It is particularly dangerous to put the belt round your child when he or she is sitting on your knee. Never use the same belt for more than one person at the same time.

The tables on the following pages inform you of the types of seat that can be fitted in each of the vehicle seat positions on the vehicle in accordance with the European directive.

Before installing a child seat in the front seat (if fitting is permitted)

If the passenger seat is fitted with one, carry out the following adjustments:

- pull back the seat as far as possible,
- straighten the seatback as much as possible,
- raise the seat squab as far as possible,
- pull the headrest up to its maximum position,
- move the seat belt height control to the low position.

Refer to the Child safety equipment booklet available from the RENAULT Network to choose the seat suited to your child and recommended for your vehicle.

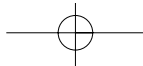

CHILD SAFETY (continued)

Age of child (weight of child)	All versions (except utility version)		
	Front passenger seat (2)	Rear side seats	Rear centre seat
Birth to approximately 9 months (weight below 13 kg)	I (4)	U - I	X
From 9 months to approximately 3 years (weight from 9 to 18 kg)	I (4)	U - I (3)	X
From 3 years to approximately 12 years (1) (weight from 15 to 36 kg)	X	U (3)	X

X : seat not suitable for fitting a child seat for this age range.

U : seat suitable for fitting a belt-fitted child seat classed as universal for this age range, check that it can be fitted.

I : seat equipped with anchoring points for mounting a seat for this age range using Isofix locks, only RENAULT seats are approved.

(1) A child taller than 1.50 m or weighing more than 36 kg can be strapped in the same way as an adult, without a special seat.

(2) Only a rear-facing child seat may be installed in this seat.

(3) Place the back of the child seat against the vehicle seatback, adjust the headrest height or remove it if necessary.



(4) DANGER RISK OF DEATH OR SERIOUS INJURY: CHECK THAT THE FRONT PASSENGER AIRBAG HAS BEEN DEACTIVATED BEFORE INSTALLING A REAR-FACING CHILD SEAT IN THIS SEAT.

(Refer to the Deactivating the front passenger Airbag information in Section 1 of the basic manual).



CHILD SAFETY (continued)

Age of child (weight of child)	Utility version
	Front passenger seat
Birth to approximately 9 months (weight below 13 kg)	I (2)
From 9 months to approximately 3 years (weight from 9 to 18 kg)	I (2)
From 3 years to approximately 12 years (1) (weight from 15 to 36 kg)	X

X : seat not suitable for fitting a child seat for this age range.

I : seat equipped with anchoring points for mounting a seat for this age range using Isofix locks, only RENAULT seats are approved.

(1) A child taller than 1.50 m or weighing more than 36 kg can be strapped in the same way as an adult, without a special seat.



(2) DANGER RISK OF DEATH OR SERIOUS INJURY: CHECK THAT THE FRONT PASSENGER AIRBAG HAS BEEN DEACTIVATED BEFORE INSTALLING A REAR-FACING CHILD SEAT IN THIS SEAT.
(Refer to the Deactivating the front passenger Airbag information in Section 1 of the basic manual).

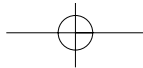

CHILD SAFETY (continued)

The right choice

The safety of your children is also your responsibility.

To give your children maximum protection, we recommend that you use seats obtained from a Renault Dealer.

If your vehicle is equipped with an Isofix system, it is preferable to use an Isofix seat. (Refer to the information in section 1 on the Isofix system of child seats.)

Restraint systems for all categories are available. These systems have been developed in consultation with the manufacturers and have been tested in Renault vehicles.

Take the advice of your Renault Dealer and ask him to help you to install it.

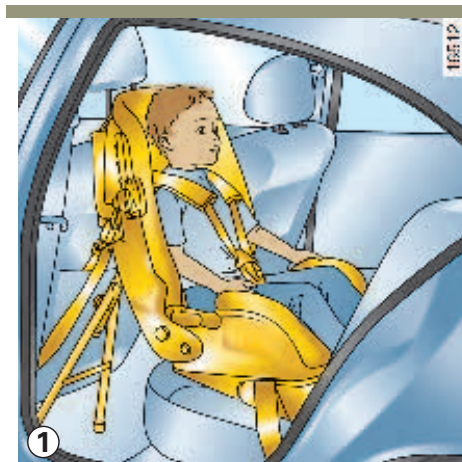

Category 0 and 0+

A child's neck is very susceptible to injury up to the age of two. In a front-facing seat there is a risk that a child will sustain neck injuries in the event of a frontal collision. Renault therefore recommends a rear-facing seat with a harness that gives all-round protection (figure 1).

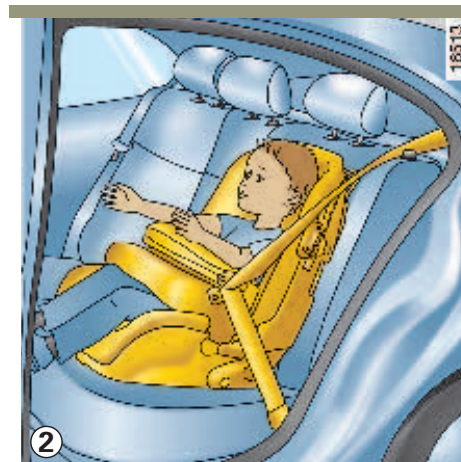

Category 1

Between the ages of 2 and 4, a child's pelvis is not fully developed. Restraints using three-point belts are not adequate and there is a risk that the child will sustain abdominal injuries in the event of a frontal collision. It is therefore advisable to use rear-facing seats (figure 1), bucket type seats (figure 2) or seats with harnesses.



To avoid any risk to your safety, we recommend that you use RENAULT approved accessories because they are suitable for your car and are the only accessories for which RENAULT will provide a warranty.

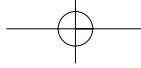

CHILD SAFETY (continued)



Category 2 (15 to 25 kg) and category 3 (22 to 36 kg)

To correctly secure the pelvis of a child of up to 12 years old, smaller than 1.50 m and weighing less than 36 kg, it is preferable to use child seats that can be combined with three-point seat belts. This is a booster seat (figure 3) with belt guides to ensure that the belt will be worn flat over the thighs of the child.

A booster seat with a height-adjustable seatback and a belt guide are recommended as this will allow the belt to be worn as close to the base of the neck as possible but not on it.

Place the head rest in the top position to allow you to press the seat back of the child seat firmly against the vehicle seatback.

If a booster seat without a seatback is used, the vehicle's headrest will have to be adjusted to suit the child's stature; the upper edge of the headrest must be at the same height as the top of the child's head and should never be lower than in line with the child's eyes.

The standard classifies the restraints in five categories:

- Category 0 : from 0 to 10 kg (0 to 22 lbs)
- Category 0+: from 0 to 13 kg (0 to 28 lbs)
- Category 1 : from 9 to 18 kg (20 to 40 lbs)
- Category 2 : from 15 to 25 kg (33 to 55 lbs)
- Category 3 : from 22 to 36 kg (48 to 80 lbs)

We recommend that you remove the headrest and put it in the luggage compartment, to facilitate fitting certain types of child seat.

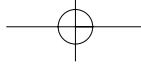

CHILD SAFETY (continued)

④

20555



⑤

20558

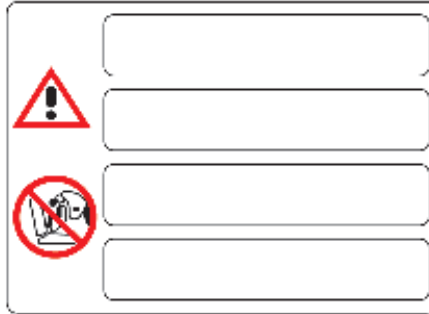

DANGER

Since front passenger airbag triggering and the position of a rear-facing child seat are incompatible, it is not permitted to install such a seat in this position unless the vehicle is fitted with an airbag deactivation device. Refer to the information on deactivating the front passenger airbag. The child may suffer very serious injuries if the airbag inflates.

Label 4 (on the dashboard) and markings 5 (on the sun visors) remind you of these instructions.

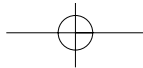

CHILD SAFETY (continued)

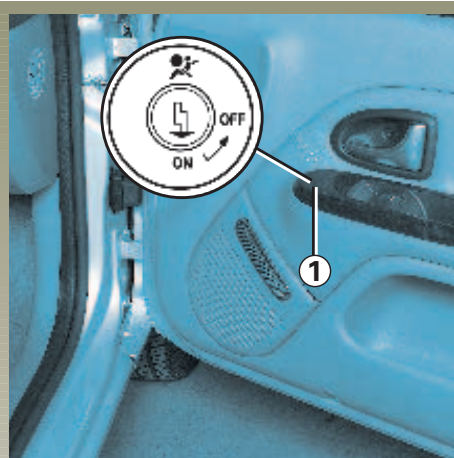

Deactivation of the front passenger airbag

You **must** deactivate the front left-hand airbag before fitting a rear-facing child seat on the front passenger seat.

To deactivate the airbag: switch off the ignition, insert the ignition key in the lock **1**, push and turn the lock to the **OFF** position and remove the key while holding it in the **OFF** position. The airbag is deactivated.



With the ignition switched on, check that the warning light **2**, **AIRBAG OFF**, is lit up on the dashboard.

This indicator light remains lit to confirm that you can fit a child seat, as the left-hand airbag has been deactivated.

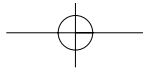

CHILD SAFETY (continued)

Activation of the front passenger airbag

You should reactivate the airbag as soon as you remove the child seat from the front passenger seat to ensure the protection of your front passenger in the event of an impact.

To reactivate the airbag: switch off the ignition and insert the ignition key into lock **1**. The key then turns automatically to the **ON** position.

Switch the ignition back on, and then check that **AIRBAG OFF** indicator light **2** goes out. The airbag is activated.

Operational faults

It is **FORBIDDEN** to fit a rear-facing child seat to the front passenger seat if the air bag activation/deactivation system is faulty.

We do not recommend fitting any other kind of passenger seat device.

Consult your **RENAULT** Dealer as soon as possible.



Activation or deactivation of the passenger airbag must be done with the **ignition off**.

Six seconds after the ignition has been switched on, operating lock **1** will deactivate the supplementary methods of restraint in addition to the seat belt in the front passenger seat and the indicator light  will come on to warn you.

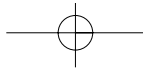

CHILD SAFETY (continued)

Isofix - mounting system for child seats

This is a new procedure for installing a child seat. This system equips the front passenger seat and the rear side seats of the vehicle.

It consists of the following components:

- Two anchoring rings **1** located between the seat and the seatback.
- A special RENAULT child seat fitted with two catches **3** which hook onto the two rings;

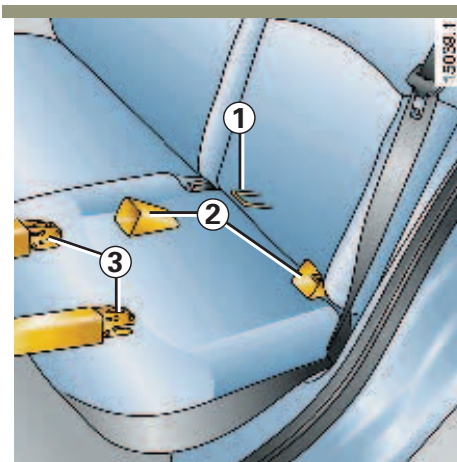

Only RENAULT child seats are approved for this vehicle.

To purchase these seats, please contact your RENAULT Dealer.

They are fitted with locks which can be secured to the Isofix attachments in your vehicle.

They can also be secured in other vehicles using a three-point seat belt.



- Make sure that there is nothing obstructing the seat mounting mechanism at the anchorage points (gravel, rags, toys, etc.).

- Always remember to fasten the seat belt on child seats for all journeys.



Use of this device on the front passenger seat is only authorized if the passenger airbags have been **deactivated**.

Refer to the information in the section on deactivating the front passenger airbag.





CHILD SAFETY (continued)

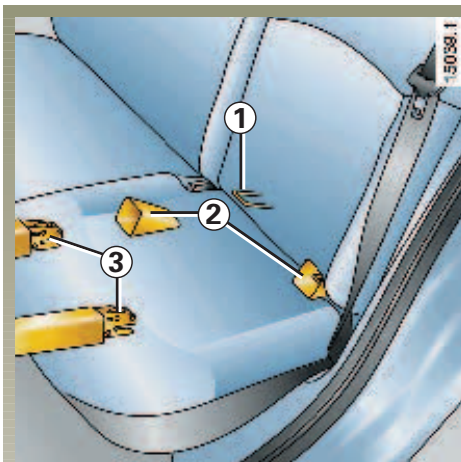

Fitting a child seat (continued)

- Slide the seat catches **3** in the guides **2** and push the seat hard to lock it on the rings;
- Check that the seat is correctly locked by moving it from left to right and forwards and backwards.

Fitting a child seat

- Before fitting and using the seat, read the instructions provided carefully;
- Fix the fitting guides **2** on the rings **1** fitted to the rear seats and front passenger seat of the vehicle;



CHILD SAFETY (continued)

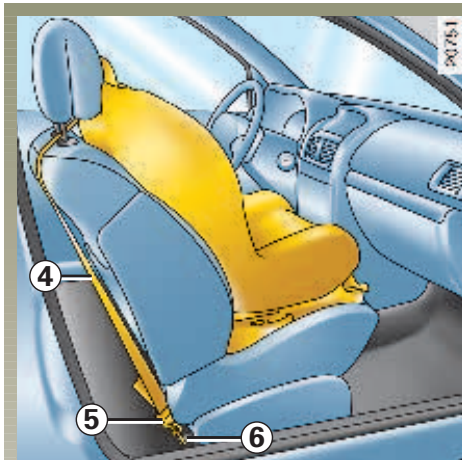

A front-facing Isofix seat fitted on the front passenger seat

Use the belt **4** delivered with the seat:

- pass the belt between the two head restraint rods;
- fix the hook **5** on the ring **6** located under the front passenger seat;
- tighten the belt.

Note: only fit the seat here if all other places are occupied.

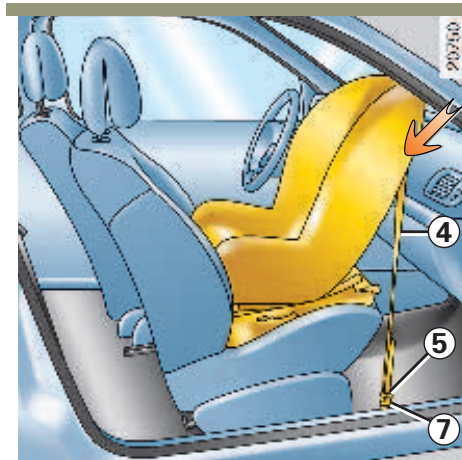

A rear-facing Isofix seat fitted on the front passenger seat

The front passenger seat must be adjusted so that the back of the child seat is touching the dashboard.

Use the belt **4** delivered with the seat:

- remove the cover to access the ring **7**;
- attach the belt catch **5** to the ring **7**;
- tighten the belt.

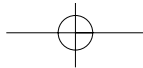

CHILD SAFETY (continued)

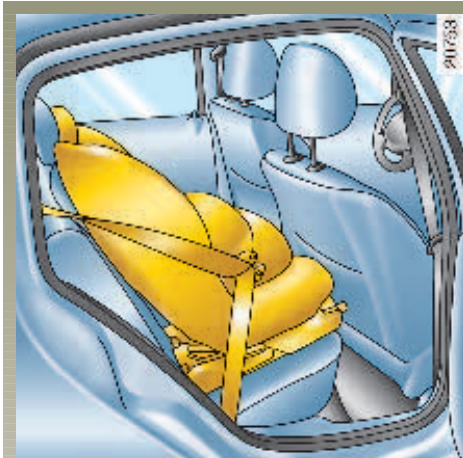

A front-facing Isofix seat fitted on the rear side seat

When a front-facing child seat is installed, the front seat must not be moved back beyond the halfway point on the seat runners and the seatback must not be reclined too far.

Each of the rear seats is fitted with two rings for mounting the base of the seat.

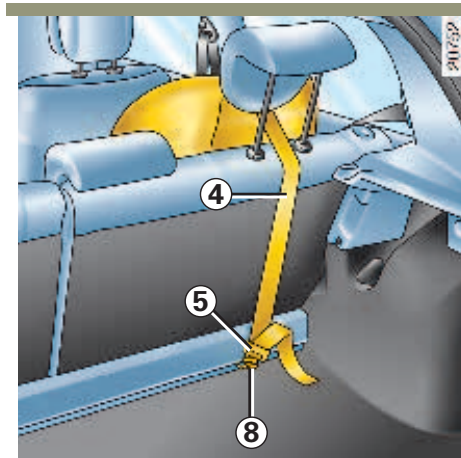

Mounting ring for a front-facing seat

Use belt **4** supplied with the seat:

- pass the belt **4** between the two rear headrest rods;
- attach catch **5** to the ring **8** located inside the luggage compartment;
- tighten the belt.

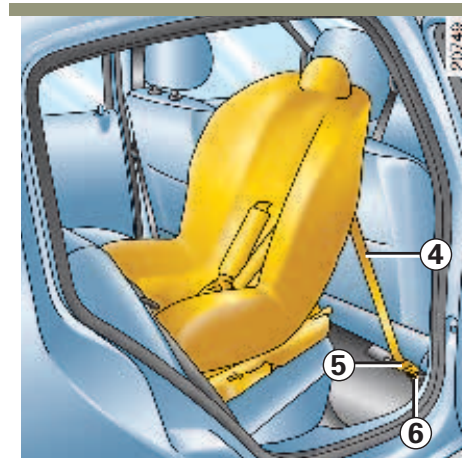

A front-facing Isofix seat fitted on the rear side seat

When a rear-facing child seat is installed, the front seat must not be moved forward beyond the halfway point on the seat runners.

The front seat back must be close to or touching the shell of the child seat.

Use belt **4** supplied with the seat:

- fix the hook **5** on the ring **6** located under the front passenger seat;
- tighten the belt.

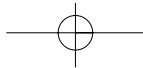

CHILD SAFETY (continued)



CHILD SAFETY

- No modifications may be made to the component parts of the restraint system (belts and seats and their mountings) fitted originally.
- The fitting instructions provided by the manufacturer of the restraint system should be followed carefully.
- Avoid wearing bulky clothing and do not place any objects between the child and the restraint system.
- The seat belt on the vehicle must be taut so that the child's seat is held in position securely. Check the tension regularly.
- Never wear the belt under the arm or behind the back.
- The harness or belt should be taut and fitted to suit the child's stature.
- Never allow your child to stand or kneel on the seat when the vehicle is moving.
- Check that the child is in the correct position for the entire journey, particularly when he or she is asleep.
- Use the seat belts to hold the seat in position, even if it is not occupied. Otherwise, if an accident occurs, it may become dislodged and pose a risk to other vehicle occupants.
- Following a serious accident, have an inspection made of the seat belts and restraint systems fitted at the time.
- Never leave a child unsupervised in a vehicle, even if he or she is in a child seat.
- Activate the rear door locks (if your vehicle is equipped with these).
- Make sure the child does not get out of the vehicle at the side where there is traffic.
- Set your children a good example - always wear your seat belt.



CLOCK / EXTERNAL TEMPERATURE

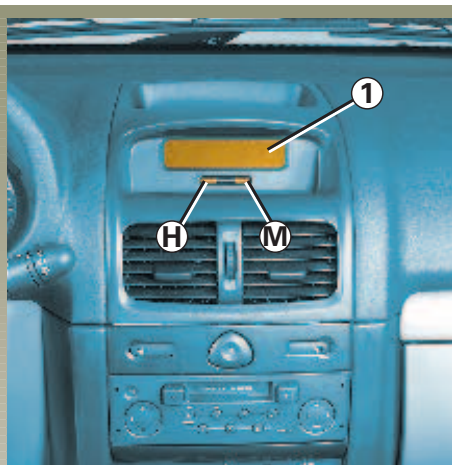

Clock 1 - setting the clock

With the ignition on, press button:

- H** For hours,
- M** For minutes.



Clock 3, setting the time

With the engine switched on, display 3 set to total mileage recorder and clock function, press and hold button 2, to access time setting mode, then release the button.

There are two ways to set the time:

- one long press on button 2 allows you to scroll through the hours and minutes quickly;
- short presses on button 2 allow you to set the time minute by minute.

If the electrical supply is cut (battery disconnected, feed wire broken, etc.), the clock must be reset.

For your safety, we recommend that you do not reset or alter the time while driving.



External temperature display 1

The formation of ice is related to exposure, local hygrometry and temperature. The external temperature alone is not sufficient to detect ice.

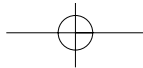

DRIVER'S LAYOUT, LEFT HAND DRIVE

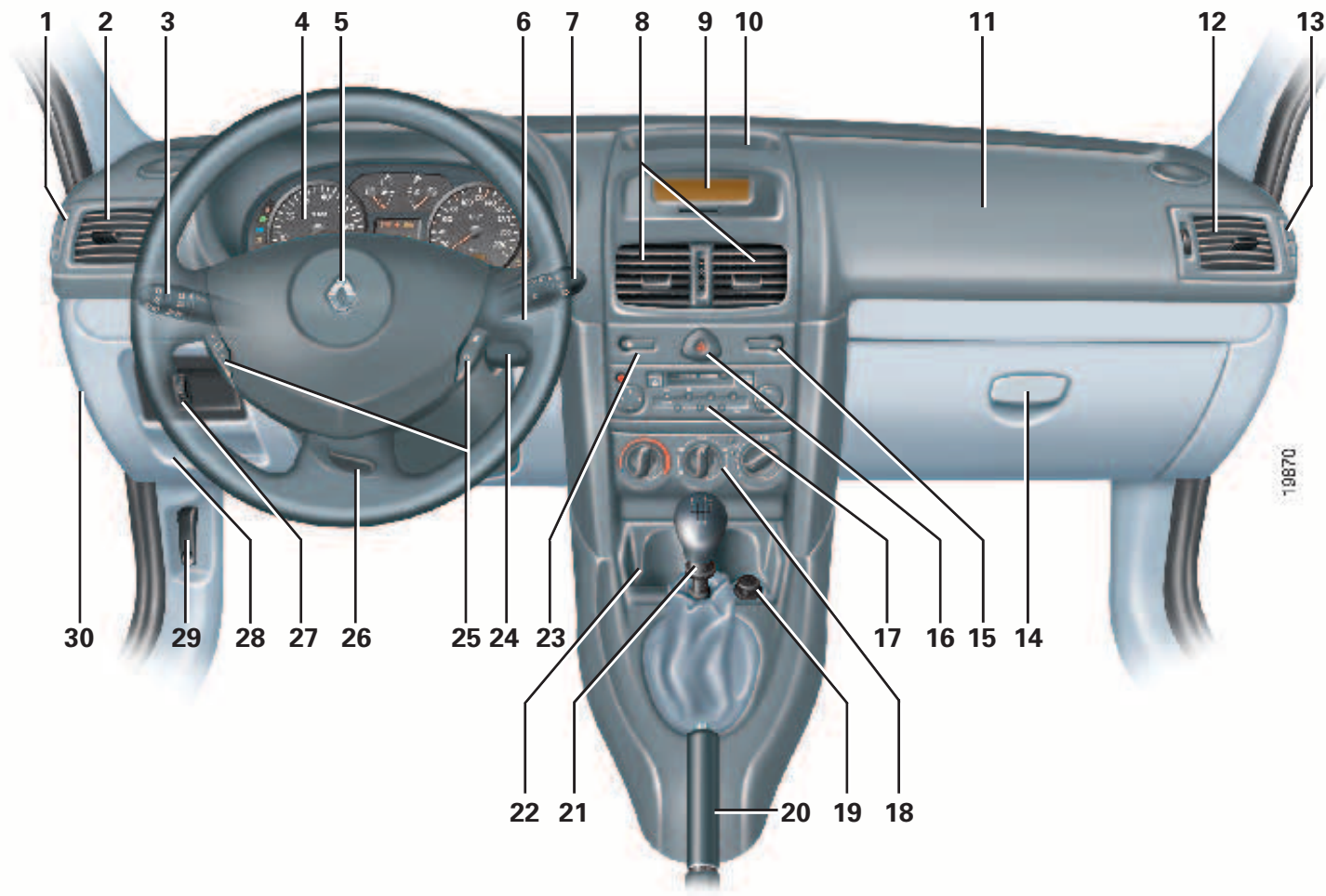

1.38



DRIVER'S LAYOUT, LEFT HAND DRIVE (continued)

The equipment fitted, described below, depends on the version, option and country.

- | | | |
|---|---|---|
| <p>1 Demister outlet for left-hand side window</p> <p>2 Left-hand side vent</p> <p>3 Stalk for:</p> <ul style="list-style-type: none"> • direction indicators, • exterior lights, • front fog lights, • rear fog lights, • horn. <p>4 Instruments.</p> <p>5 • Driver's airbag location.
• Horn</p> <p>6 Radio satellite controls.</p> <p>7 • Stalk for windscreen and rear screen wash/wipe.
• Trip computer information scrolling control.</p> <p>8 Centre air vents.</p> | <p>9 Display:</p> <ul style="list-style-type: none"> • Clock and temperature, • Radio, clock and temperature • Radio, clock, external temperature and navigation system <p>10 Storage compartment.</p> <p>11 Passenger airbag location.</p> <p>12 Right-hand side air vent.</p> <p>13 Demister outlet for right-hand side vent</p> <p>14 Glove box.</p> <p>15 Heated rear screen switch</p> <p>16 Hazard warning lights switch.</p> <p>17 Radio location or storage compartment</p> <p>18 Air conditioning controls.</p> | <p>19 Ashtray and cigarette lighter</p> <p>20 Handbrake</p> <p>21 Gear lever</p> <p>22 Cup holder</p> <p>23 Electric door locking switch</p> <p>24 Ignition switch</p> <p>25 Cruise control/speed limiter controls</p> <p>26 Steering wheel height adjuster</p> <p>27 Controls for:</p> <ul style="list-style-type: none"> • Electric headlight beam adjustment • Dimmer for control lighting • Cruise control • Electronic Stability Program (ESP) <p>28 Storage compartment</p> <p>29 Bonnet release</p> <p>30 Fuse box</p> |
|---|---|---|



DRIVER'S LAYOUT, RIGHT-HAND DRIVE

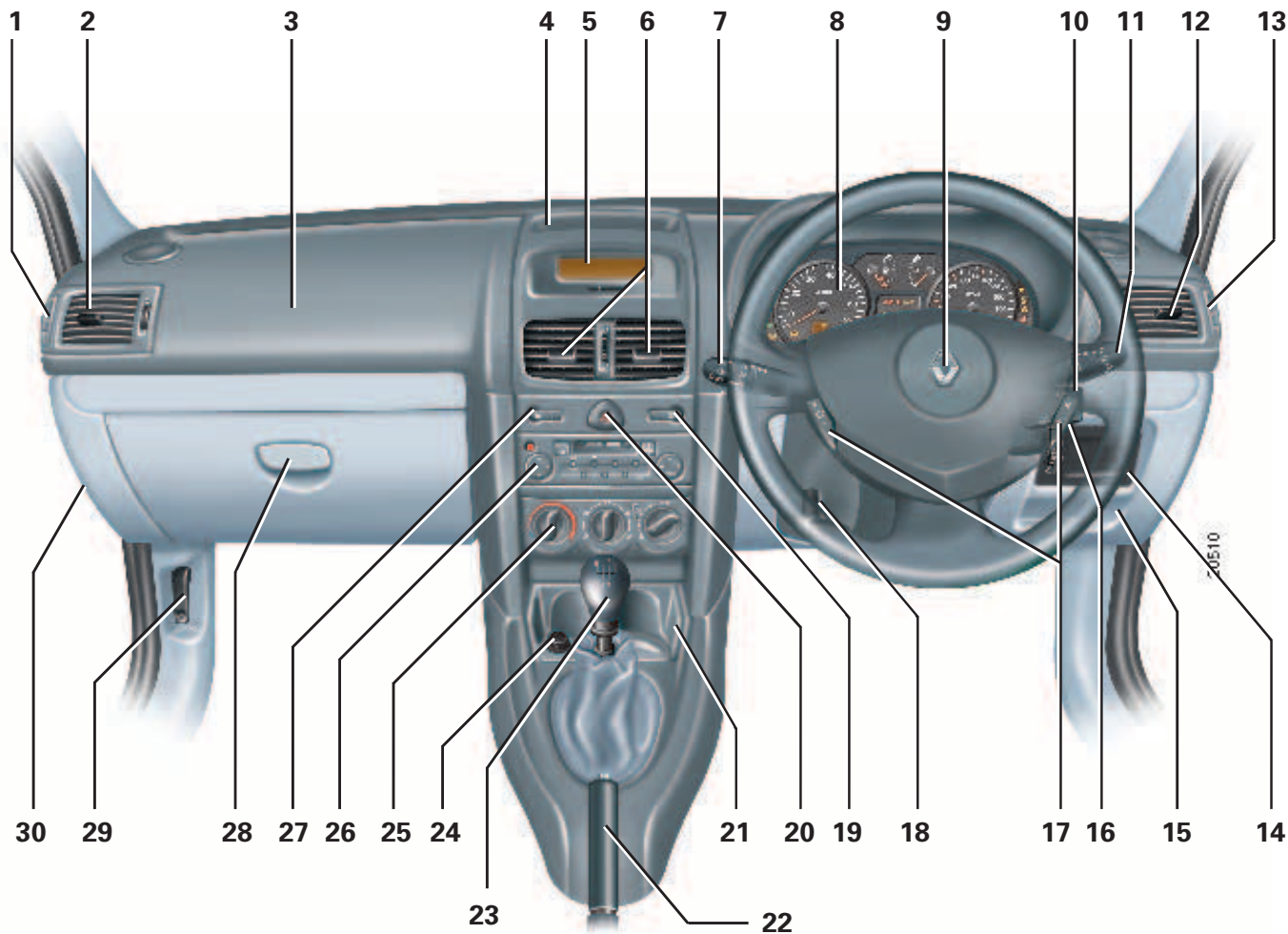

1.40



DRIVER'S LAYOUT, RIGHT-HAND DRIVE (continued)

The equipment fitted, described below, depends on the version, option and country.

- | | | |
|---|---|--|
| <p>1 Demister outlet for left-hand side window</p> <p>2 Left-hand side vent</p> <p>3 Passenger airbag location.</p> <p>4 Storage compartment.</p> <p>5 Display:</p> <ul style="list-style-type: none"> • Clock and temperature, • Radio, clock and temperature, • Radio, clock, external temperature and navigation system <p>6 Centre air vents.</p> <p>7 Stalk for:</p> <ul style="list-style-type: none"> • direction indicators, • exterior lights, • front fog lights, • rear fog lights, • horn. <p>8 Instruments.</p> <p>9 • Driver's airbag location.
• Horn</p> | <p>10 Radio satellite controls</p> <p>11 • Stalk for windscreen and rear screen wash/wipe
• On-board computer information readout control</p> <p>12 Right-hand side vents</p> <p>13 Demister outlet for right-hand side vent</p> <p>14 Controls for:</p> <ul style="list-style-type: none"> • Electric headlight beam adjustment • Instrument panel lighting dimmer • Cruise control and speed limiter • Electronic Stability Program (ESP) <p>15 Storage compartment</p> <p>16 Ignition switch</p> <p>17 Cruise control/speed limiter controls</p> <p>18 Steering wheel height adjuster</p> | <p>19 Heated rear screen switch</p> <p>20 Hazard warning lights switch</p> <p>21 Cup holder</p> <p>22 Handbrake</p> <p>23 Gear lever</p> <p>24 Ashtray and cigarette lighter</p> <p>25 Heating and ventilation controls</p> <p>26 Radio location or storage compartment</p> <p>27 Electric door locking switch</p> <p>28 Glove box</p> <p>29 Bonnet release</p> <p>30 Fuse box</p> |
|---|---|--|



INSTRUMENT PANEL (continued)

The presence and operation of the warning lights described below depend on the vehicle equipment and country.

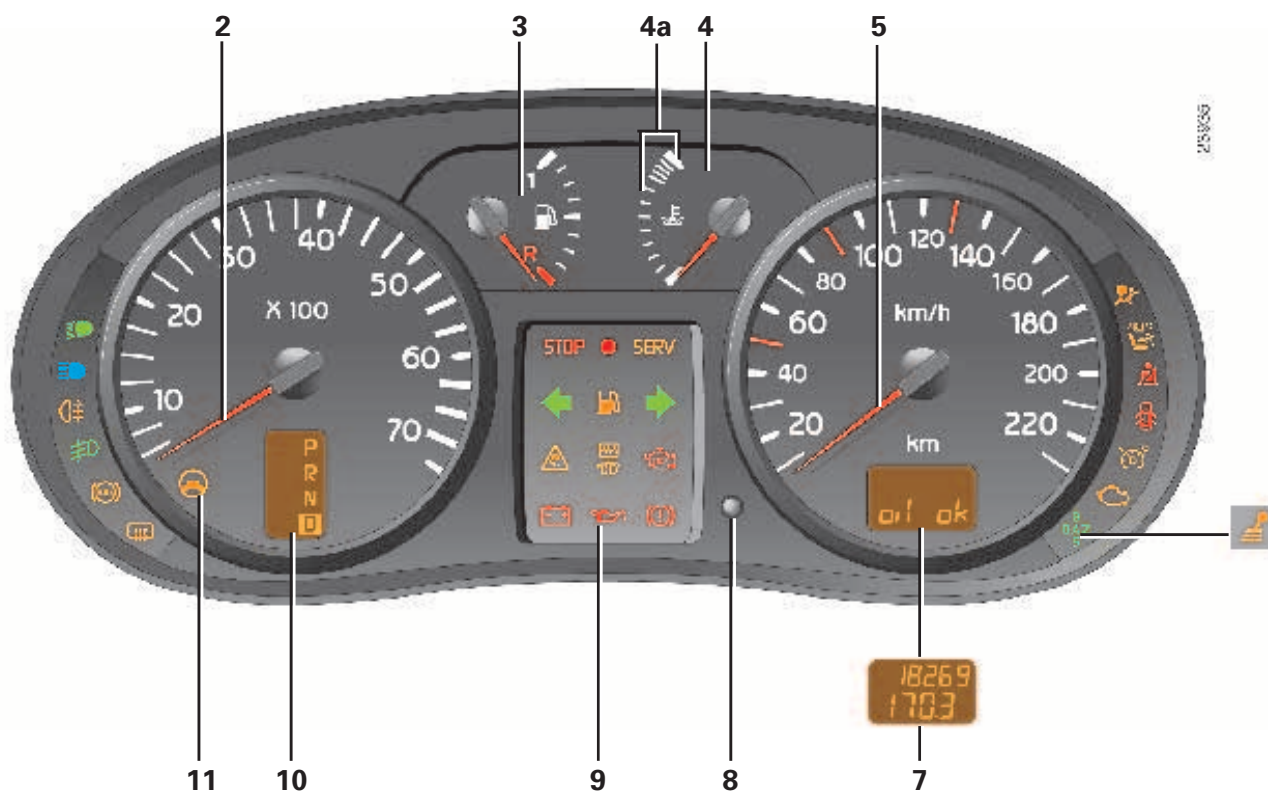





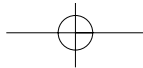





If the **STOP** warning light comes on, you must stop as soon as traffic conditions allow.

If the **SERV** warning light comes on, you should visit a Renault Dealer in the near future.



INSTRUMENT PANEL (continued)

The presence and operation of the warning lights described below depend on the vehicle equipment and country.

- | | | |
|--|--|--|
| <p>1  Headlight dipped beam warning light</p> <p> Main beam headlight indicator light</p> <p> Rear fog light indicator light</p> <p> Front fog light indicator light</p> <p> Anti-lock braking system warning light
This light comes on when the ignition is switched on and goes out within 3 seconds. If it comes on when you are driving, it indicates a fault in the anti-lock braking system. Braking will then occur normally but without the anti-lock braking system. Consult your RENAULT Dealer as soon as possible.</p> <p> Rear screen demisting indicator light</p> | <p>2 Rev counter (scale × 100)</p> <p>3 Fuel level gauge</p> <p>4 Coolant temperature indicator
In normal use, the needle should be below zone 4a. Under severe use the needle may enter this zone. This is not serious unless warning light  lights up.</p> <p>5 Speedometer (km or miles per hour)</p> <p>6  Airbag warning light
This lights up when the ignition is switched on and goes out after a few seconds. If it does not light up when the ignition is switched on, or lights up when the engine is running, there is a fault in the system. Refer to the information in Section 1 on the restraint device additional to the front seat belt, and consult your RENAULT Dealer as soon as possible.</p> | <p>6  Front passenger airbag deactivated warning light
Refer to the information on Child safety in Section 1.</p> <p> Driver's seat belt not fastened warning light
It remains lit when the vehicle is started, then when the car reaches a speed of approximately 6 mph (10 km/h), it flashes and a beep sounds for approximately 90 seconds.</p> <p> Door(s) open warning light</p> |
|--|--|--|

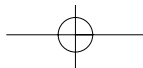

INSTRUMENT PANEL (continued)

The presence and operation of the warning lights described below depend on the vehicle equipment and country.

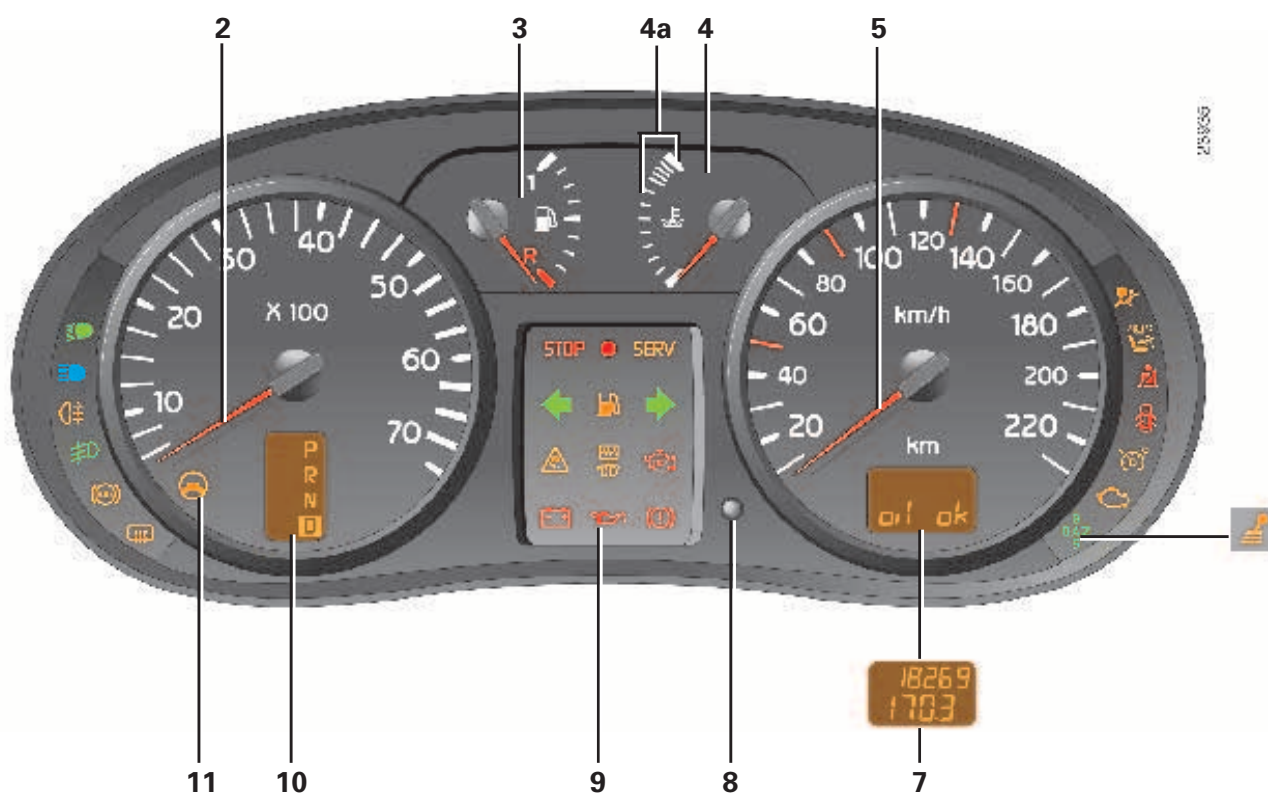

If the **STOP** warning light comes on, you must stop as soon as traffic conditions allow.
 If the **SERV** warning light comes on, you should visit a Renault Dealer in the near future.

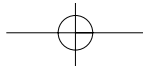

INSTRUMENT PANEL (continued)

The presence and operation of the warning lights, described below, depend on the vehicle equipment and country.

6  **Speed limiter and cruise control indicator light**

To understand how this operates, refer to the information on the cruise control and speed limiter functions in Section 2.

 **Toxic fume monitoring warning light**

For vehicles equipped with this option, the light comes on when the ignition is switched on then goes out.

- If it lights up permanently, consult your Renault Dealer as soon as possible;
- If it flashes, reduce the engine speed until the light stops flashing.

Consult your Renault Dealer as soon as possible.

Refer to the information on anti-pollution, fuel economy and driving in Section 2.

6  **Over-revving warning light**
Indicates that you need to change gear.

or



LPG mode operating indicator

Refer to the LPG-powered vehicles supplement.

7 **Multifunction display**

Oil level display function

The vehicle must be parked on level ground and the engine should have been switched off for some time beforehand to obtain an accurate level reading.

When the ignition has been switched on for approximately 30 seconds:

- **if the level is correct**, the display will show "oil OK"
- **when the minimum oil level is reached**: the word "OK" will no longer be displayed, the dashes and the word "Oil" will flash and the SERV warning light will light up until the engine is switched off.

It is vital to top up as soon as possible.

7 **Total mileage recorder, trip mileage and clock**

Can be read approximately 30 seconds after the ignition is switched on.

8 **Multifunction key**

Press the key repeatedly to select information on the display, to reset the trip mileage recorder or to set the clock.

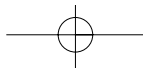

INSTRUMENT PANEL (continued)

The presence and operation of the warning lights described below depend on the vehicle equipment and country.

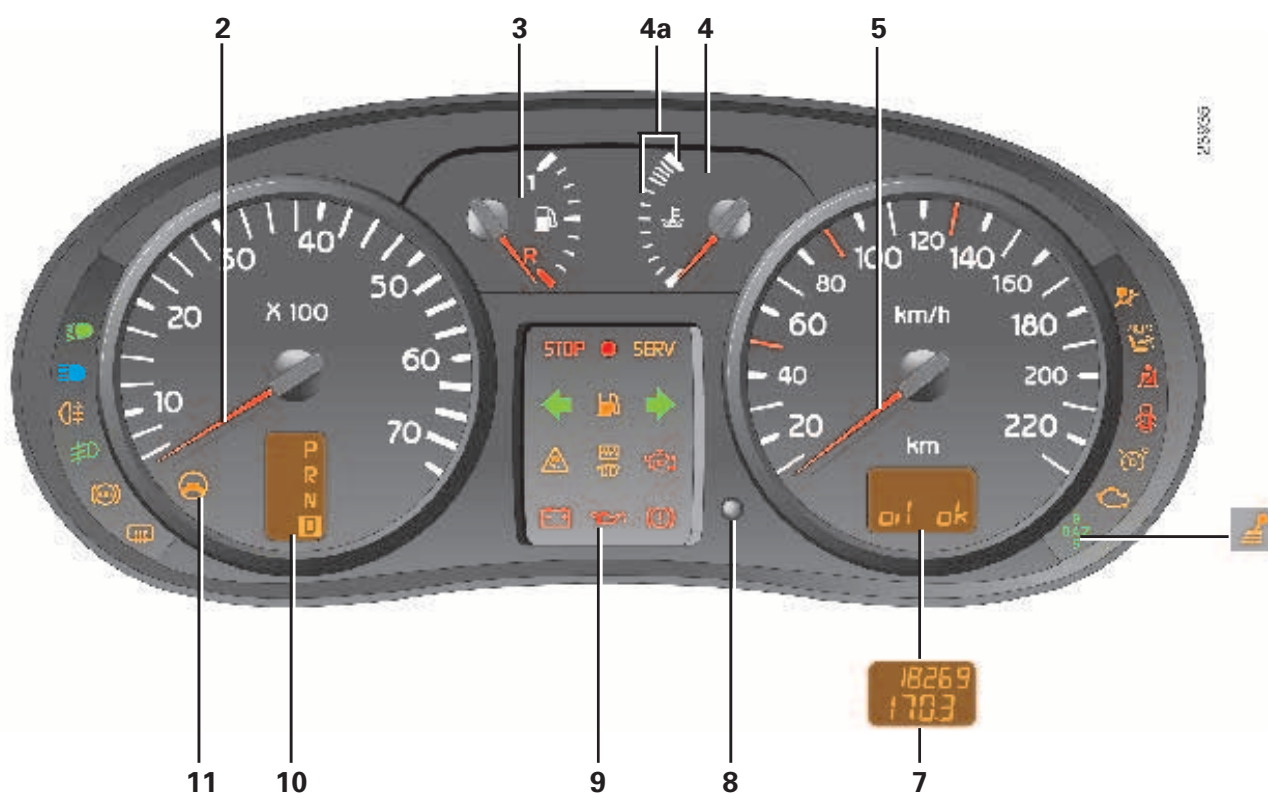

If the **STOP** warning light comes on, you must stop as soon as traffic conditions allow.

If the **SERV** warning light comes on, you should visit a Renault Dealer in the near future.

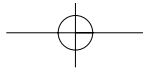



INSTRUMENT PANEL (continued)

The presence and operation of the warning lights, described below, depend on the vehicle equipment and country.

- 9  **STOP light**
It goes out as soon as the engine starts.
This lights up together with one of the warning lights:





-  **Engine immobiliser system indicator light**
This light performs several functions.
Refer to the information on the engine immobiliser in Section 1.

-  **SERVICE warning light**
This lights up when the ignition is switched on and goes out after a few seconds. If it lights up when the vehicle is being driven, it is advisable to stop at a Renault Dealer soon.
It lights up together with one of the warning lights:



- 9  **Left turn signal indicator light**

-  **Low fuel level warning light**
It goes out as soon as the engine starts.
If it lights up or remains lit, fill up with fuel as soon as possible.

-  **Right turn signal indicator light**

-  **Electronic Stability Program (ESP) and traction control indicator light**
There are several reasons for this warning light coming on: see Section 2 for information on the Electronic Stability Program: ESP and the Traction control system.

- 9  **Preheating/electronic fault or water in the diesel warning light.**

- **Preheating indicator light**
This light should come on when the ignition key is in position **M**; it indicates that the heater plugs are functioning. It goes out after preheating is sufficient and the engine can be started.
- **Electronic fault/or water present in the diesel warning light**
If it comes on while driving, it indicates an electronic fault or that water is present in the fuel. Consult your RENAULT Dealer as soon as possible.

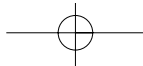

INSTRUMENT PANEL (continued)

The presence and operation of the warning lights described below depend on the vehicle equipment and country.

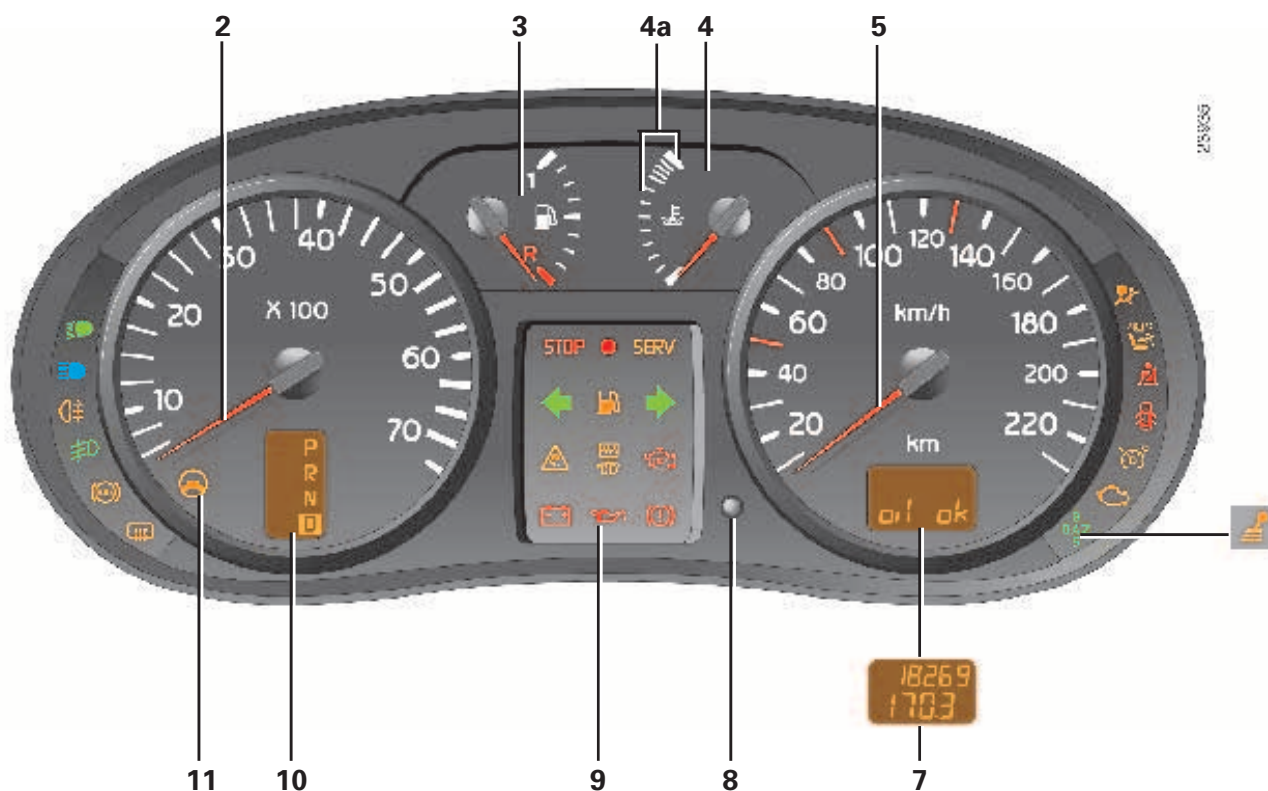





If the **STOP** warning light comes on, you must stop as soon as traffic conditions allow.
 If the **SERV** warning light comes on, you should visit a Renault Dealer in the near future.



INSTRUMENT PANEL (continued)

The presence and operation of the warning lights described below depend on the vehicle equipment and country.

- 9**  **Coolant temperature warning light**
If this lights up when the vehicle is being driven, it indicates that the engine is overheating. Stop and allow the engine to run at idle speed for a minute or two. The temperature should drop. If it does not, stop the engine and check the coolant level (**having let the engine cool down**). Call for the assistance of a Renault Dealer if necessary.
- 9**  **Battery charge warning light**
It should go out as soon as the engine starts. If it lights up when you are driving, it indicates that the circuit is overcharging or discharged. Stop and have the circuit checked.
- 10** **Warning lights relating to the operation of and/or faults in the automatic gearbox or Quickshift 5.**
Refer to the information on automatic gearbox in section 2.
- 11**  **Variable power-assisted steering warning light**
It goes out as soon as the engine starts. If it lights up when you are driving, this indicates a fault in the system. Consult your Renault Dealer as soon as possible.
- Oil pressure warning light**
 It should go out as soon as the engine starts; if it lights up when you are driving, stop at once, switch off the ignition and check the oil level. If this is normal, call for the assistance of a Renault Dealer.
- Handbrake "on" and brake circuit incident warning light.**
 If it lights up when the brakes are applied, it indicates that the fluid level in the circuit is low. It may be dangerous to continue driving. Call for the assistance of a Renault Dealer.



ON-BOARD COMPUTER

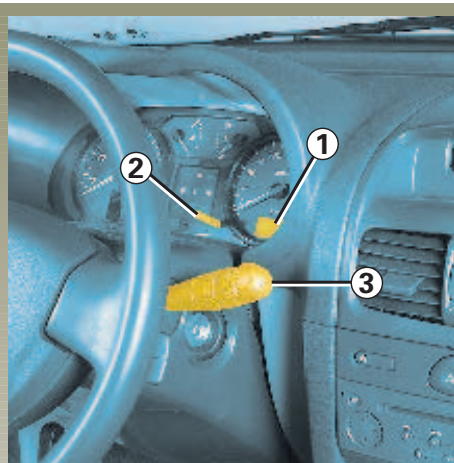

1 Display

2 General reset and trip mileage recorder reset button

To reset the trip mileage recorder, the display must show the “trip mileometer” function.

Automatic reset

Automatic resetting will occur when the maximum of any of the memories is exceeded.

3 Display selection key

Press button **3** repeatedly to scroll through the following information:

- a) total mileage recorder,
- b) trip mileage recorder,
- c) fuel used,
- d) average consumption,
- e) current consumption,
- f) estimated range,
- g) distance covered,
- h) average speed,
- i) recommended speed (speed limiter/cruise control).

Refer to the chart on the following page for display examples.

Interpreting certain values displayed after a reset:

The values showing average fuel consumption, range and average speed will become more stable and reliable the further you travel since the last time the reset key was pressed.

In the first few miles after resetting, you may notice:

- that the range increases as you drive. This is normal as the average consumption may reduce when:
 - the vehicle is no longer accelerating,
 - the engine reaches normal operating temperature (reset when engine was cold),
 - you drive from a built up area to the open road.



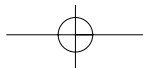

If average consumption is decreased, the expected range will therefore increase.

- average consumption increases when the vehicle is stationary and idling.

This is normal as the computer takes into account the fuel used during idling.





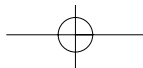

ON-BOARD COMPUTER (continued)

Examples of display selections by pressing button 3	➤	Interpreting the display
	➤	a) Total mileage recorder.
	➤	b) Trip mileage recorder.
	➤	c) Fuel used (in litres or gallons) since the last reset.
	➤	d) Average consumption (in mpg or l/100 km) since the last reset. The value is displayed after covering 400 metres taking into account the distance covered and the fuel used since the last reset.



ON-BOARD COMPUTER (continued)

Examples of display selections by pressing button 3	➔	Interpreting the display
	➔	e) Current consumption (in mpg or litres/100 km) The value is displayed after reaching a speed of 15 mph (25 km/h).
	➔	f) Estimated range with remaining fuel (in miles or km) This function uses the average consumption since the last general reset. The value is displayed after covering 400 metres.
	➔	g) Distance covered (in miles or km) since the last reset.
	➔	h) Average speed (in mph or km/h) since the last reset. The value is displayed after covering 400 metres.
	➔	i) Cruise control or speed limiter recommended speed (depending on vehicle). See the information on speed limiter and cruise control in section 2.



REAR VIEW MIRRORS

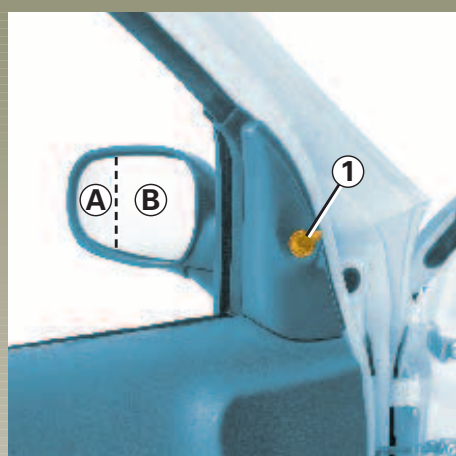

External rear view mirrors with manual adjustment

To adjust the mirror, move lever **1**.

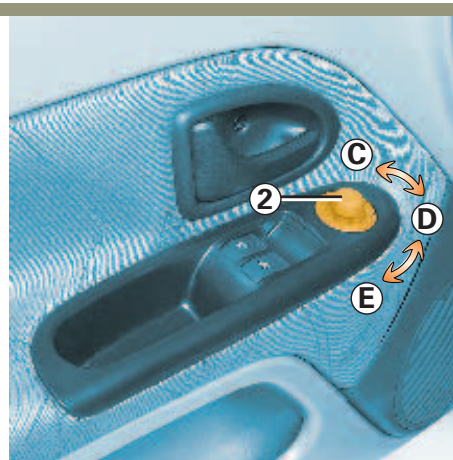

External rear view mirrors with electrical adjustment

Ignition on, move knob **2**:

- position **C** to adjust the left hand mirror;
- position **E** to adjust the right hand mirror;

D is the central neutral position.

Heated rear view mirrors

The mirrors are de-iced at the same time as the rear screen demisting / de-icing is used.



The driver's side external rear view mirror has two clearly marked areas. Zone **B** corresponds to what can normally be seen in a conventional rear view mirror. Zone **A** increases the area visible to the rear and to the side of your vehicle, for your safety.

Objects in zone A appear to be much further away than they really are.

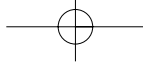

REAR VIEW MIRRORS (continued)

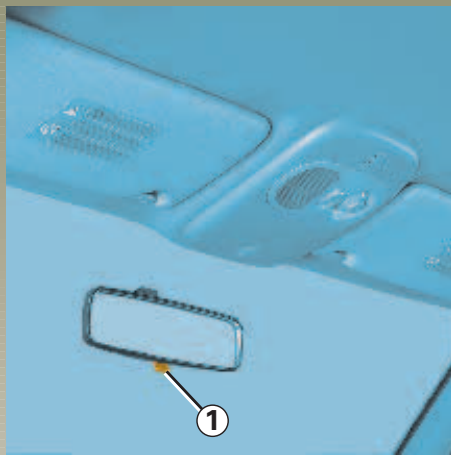

Interior rear view mirror

This is adjustable. When driving at night, to avoid being blinded by the headlights of a following vehicle, lower the small lever **1** located behind the rear view mirror.

STEERING WHEEL



Adjusting the steering wheel

On certain vehicles, the position of the steering wheel can be adjusted.

Lift lever **2** and set the steering wheel in the required position. Lower the lever to lock the steering wheel.



For safety reasons, only adjust the steering wheel when the vehicle is stationary.

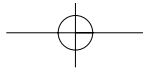

EXTERNAL LIGHTING AND SIGNALS



Side lights



Turn the end of stalk **1** to align the symbol opposite the mark **3**.

The instrument panel lights up. The brightness of the lights can be modified by turning wheel **2**, if this feature is fitted to the vehicle.

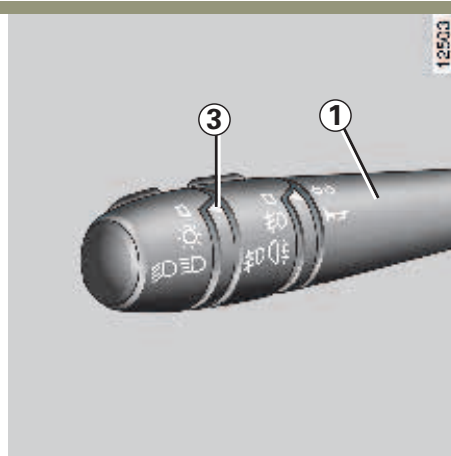

Dipped beam headlights



Automatic operation

With the engine running, vehicles fitted with a **light sensor**, the dipped beam headlights light up automatically as light begins to fade; stalk **1** does not need to be turned (position 0).

To deactivate or reactivate this function, move the end of stalk **1** twice consecutively from 0 to side light position, with the engine stopped and the ignition on.

Automatic operation (continued)

A bleep confirms the deactivation of this function, and two bleeps confirm its reactivation.

Manual operation

Turn the end of stalk **1** until the symbol appears opposite mark **3**.

An indicator light lights up on the instrument panel in all cases.

Headlight main beam



When the dipped beam headlights are on, turn stalk **1** towards you (an indicator light lights up on the instrument panel).

To return to the dipped headlight position, pull the stalk towards you.

Switching off the lights



Turn the end of stalk **1** back to its original position.



Before setting out to drive at night: check that the electrical equipment is in good condition and adjust the headlight beams (if your vehicle is not carrying its normal load). Check that the lights are not obscured (by dirt, mud, snow or objects which could cover them).

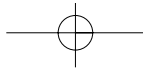

EXTERNAL LIGHTING AND SIGNALS (continued)



Front fog lights

Turn the central ring **4** of the stalk to align the symbol with mark **5**. 

Operation of the fog lights depends on the external lighting selected and a warning light will light up on the instrument panel.

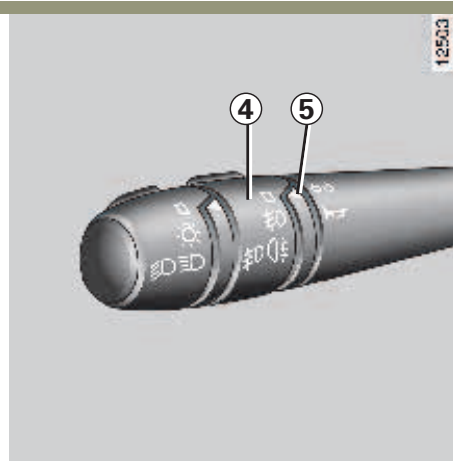

Rear fog light

Turn the central ring **4** of the stalk to align the symbol with mark **5**. 



Operation of the rear fog light depends on the external lighting selected and a warning light will light up on the instrument panel.

Remember to turn this light off when it is no longer needed to avoid inconveniencing other road users.

The front and rear fog lights switch off when the exterior lights are switched off.

Special case

The front and rear fog lights do not operate in automatic mode.

They only come on if the end of ring **1** is in position  or .

Lights on warning buzzer

A warning buzzer will sound when a front door is opened and the lights are left on after the ignition has been switched off (to prevent discharge of the battery).



ELECTRIC HEADLIGHT BEAM ADJUSTMENT

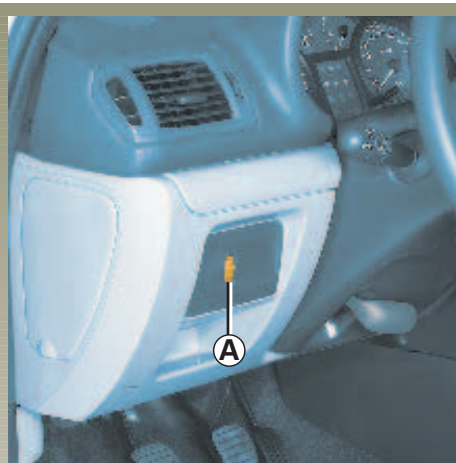

On vehicles fitted with this function, the tumblewheel **A** allows you to adjust the height of the beams according to load.

Turn the tumblewheel **A** down to lower the headlights and up to raise them.

Versions	➔	Tumblewheel adjustment positions A
All versions except utility	➔	Position 0 or 1: basic setting, luggage compartment empty with driver alone or with a front passenger.
	➔	Position 2 or 3: vehicle with 5 persons on board, luggage compartment empty.
	➔	Position 3: Vehicle luggage compartment fully laden and driver only.
	Position 4: intermediate position.	
Utility version	➔	Position 0: Basic setting, vehicle unladen
	➔	Position 3: Vehicle fully laden
	Positions 1, 2, 4: Intermediate positions	





WINDSCREEN WIPER/WASHER

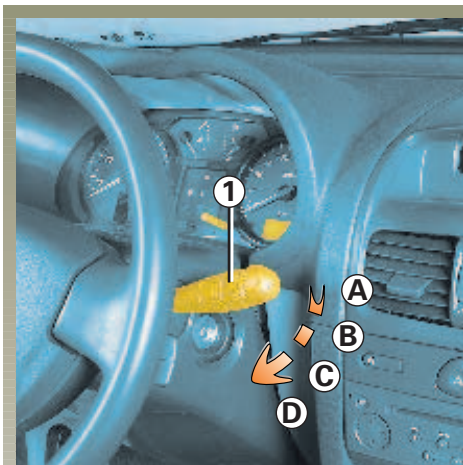

Vehicle fitted with intermittent wipers



With the ignition switched on, turn stalk **1**

- **A off**
- **B intermittent wiper**
The wipers may stop for a few seconds between wipes depending on the version. It is possible to vary the time between sweeps by turning the central ring on the stalk **1**:
- **C continuous slow wiping**
- **D continuous fast wiping**

Vehicle fitted with windscreen wiper and rain sensor

With the ignition switched on, turn stalk **1**

- **A off**
- **B rain sensor position**
When this position is selected, the system detects the presence of water on the windscreen and triggers wiping at a suitable wiping speed.
The central ring on stalk **1** enables you to vary the sensitivity of the rain sensor—

- represents minimum sensitivity
- represents maximum sensitivity.

- **C continuous slow wiping.**
- **D continuous fast wiping.**

The rain sensor is deactivated **every time the ignition is switched off.**

To reactivate the sensor, return to stop position **A**, then move to rain sensor position **B**. This causes the wipers to sweep once.

Vehicles with automatic selection of wiping speed

If a wiping speed is selected when driving, the wiping speed is reduced to a lower speed when the vehicle stops:

- from fast wiping speed the speed will change to normal wiping speed;
- from normal wiping speed the speed will change to intermittent wiping.

As soon as the vehicle moves off, wiping will return to the speed originally selected.

When the vehicle is stationary, pressing stalk **1** overrides and cancels automatic operation.

Note:

If for any reason the wipers cannot move (e.g. stuck to windscreen by ice), the system will automatically cut off the power supply to the wipers.

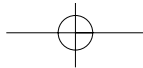

WINDSCREEN WASHER/WIPER (continued)



Windscreen washer, headlight washers

With the ignition on, pull stalk **1** towards you.

A short press triggers one sweep cycle of the wiper, while a longer press triggers three cycles.

- **Car lights off**

You activate the windscreen washer and wiper.

This will make another sweep after a few seconds.

- **Car headlights on**

Press for longer than one second to activate the windscreen washer and headlight washer devices simultaneously.

In frosty weather, make sure that the wiper blades are not stuck by ice (risk of motor overheating).

Keep an eye on the condition of the blades. Change the wiper blades as soon as they become less efficient (approximately once a year).

If you switch off the ignition before switching off the windscreen wiper (position **A**) the blades will stop at random on the windscreen.

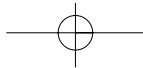

REAR SCREEN WASH/WIPE



Intermittent rear wiper



Ignition on, turn the end of stalk **1** to align reference mark **2** opposite the symbol.

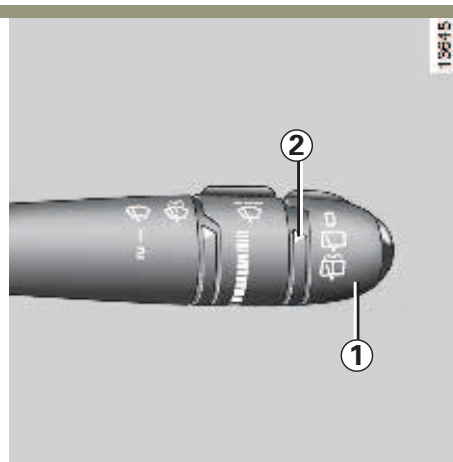

Rear washer



Ignition on, turn the end of stalk **1** to align reference mark **2** opposite the symbol.

When the stalk is released, it returns to the rear wiper position.

Special note

For certain vehicles, if the windscreen wipers are operating when reverse gear is selected, the rear wiper will operate intermittently.

In freezing conditions, make sure that the wiper blades are not stuck to the windscreen (risk of overheating the motor).

Keep an eye on the condition of the blades. Change them as soon as they become less efficient: approximately once a year.



DE-ICING



Heated rear screen



With the engine running, press button **1** (the warning light lights up on the instrument panel).

This function ensures the de-icing and demisting of the rear screen and the heated external rear-view mirrors (if the vehicle is fitted with them).

The function is stopped:

- automatically after 15 minutes operation,
- by pressing button **1** again (the warning light goes out).

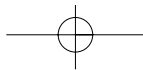

AUDIBLE AND VISIBLE SIGNALS

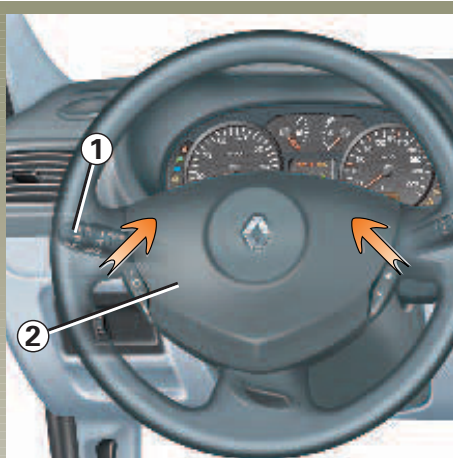

Horn

Press on the central cushion of steering wheel **2**.

Headlight flasher

To flash your headlights, even if the lights are not in use, pull the stalk **1** towards you.

Special case

If automatic operation for dipped headlights is activated, first pull stalk **1** towards you to light the main beam headlight then again to turn them off.



Hazard warning lights



Press switch **3**.

This switch lights up all four indicators at the same time.

It is to be used in cases of danger to warn other road users that you:

- are obliged to stop in a normally prohibited location,
- are obliged to drive under particular conditions.



Direction indicators

Move stalk **1** parallel to the steering wheel and in the direction in which you are going to turn.

When driving on the motorway, the steering wheel is not often turned far enough to return the stalk automatically to position **0**. There is an intermediate position in which the stalk can be held when changing lanes.

When the stalk is released, it automatically returns to **0**.



FUEL TANK

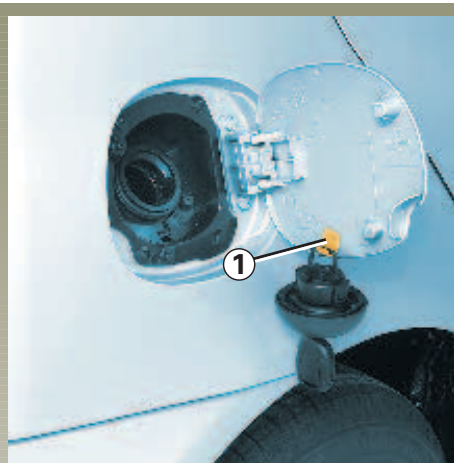

Useful capacity of the fuel tank:
Approximately **11 gallons**
(**50 litres**).

There is a cap holder **1** on the fuel filler flap for holding the cap when filling the tank.



Fuel filler cap: this is of a special type. If you have to change it, make sure the new cap is of the same type.

Never handle the cap near a source of heat or a flame.

Fuel grade

Petrol version

Use fuel which corresponds to the appropriate grade defined by the standards in force in the particular country you are in.

Refer to the Engine specifications section.

Diesel versions

Use diesel fuel only. When filling the tank, ensure that no water enters the tank accidentally. The filler cap and the neck must be clean and dust-free. The fuel must be of high quality.



Rapeseed oil must not be used under any circumstances. Also, do not mix even small amounts of petrol with diesel.



FUEL TANK (continued)

Filling with fuel

Petrol version

Use **unleaded fuel only**.

Using leaded fuel will damage the depollution equipment and may lead to a loss of warranty.

To avoid the tank being filled with leaded fuel, the filler neck has a restrictor with a valve **which only allows an unleaded petrol nozzle to be used** (at the petrol pump).

- Insert the nozzle to open the valve, **as far as it will go**.
- Hold the nozzle in this position while the tank is filled and then release it.

Filling with fuel (continued)

Petrol and diesel versions

To allow room for expansion in the fuel tank, do not top up more than twice after the pump nozzle has cut out automatically.

Persistent fuel odour

Your vehicle has a pressurised fuel supply system. If a persistent fuel odour should occur, please:

- stop the vehicle if traffic conditions allow and switch the ignition off;
- switch on the hazard warning lights and ask all passengers to leave the vehicle to keep them away from the traffic;
- do not intervene or restart before the vehicle has been checked by qualified Renault network staff.



Any operation or modification on the fuel supply system (computers, wiring, fuel circuit, injector, protective covers...) is strictly forbidden due to the safety risks it may cause (except for qualified staff from the Renault network).

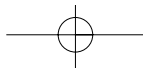

Section 2: Driving

(advice on use relating to fuel economy and the environment)

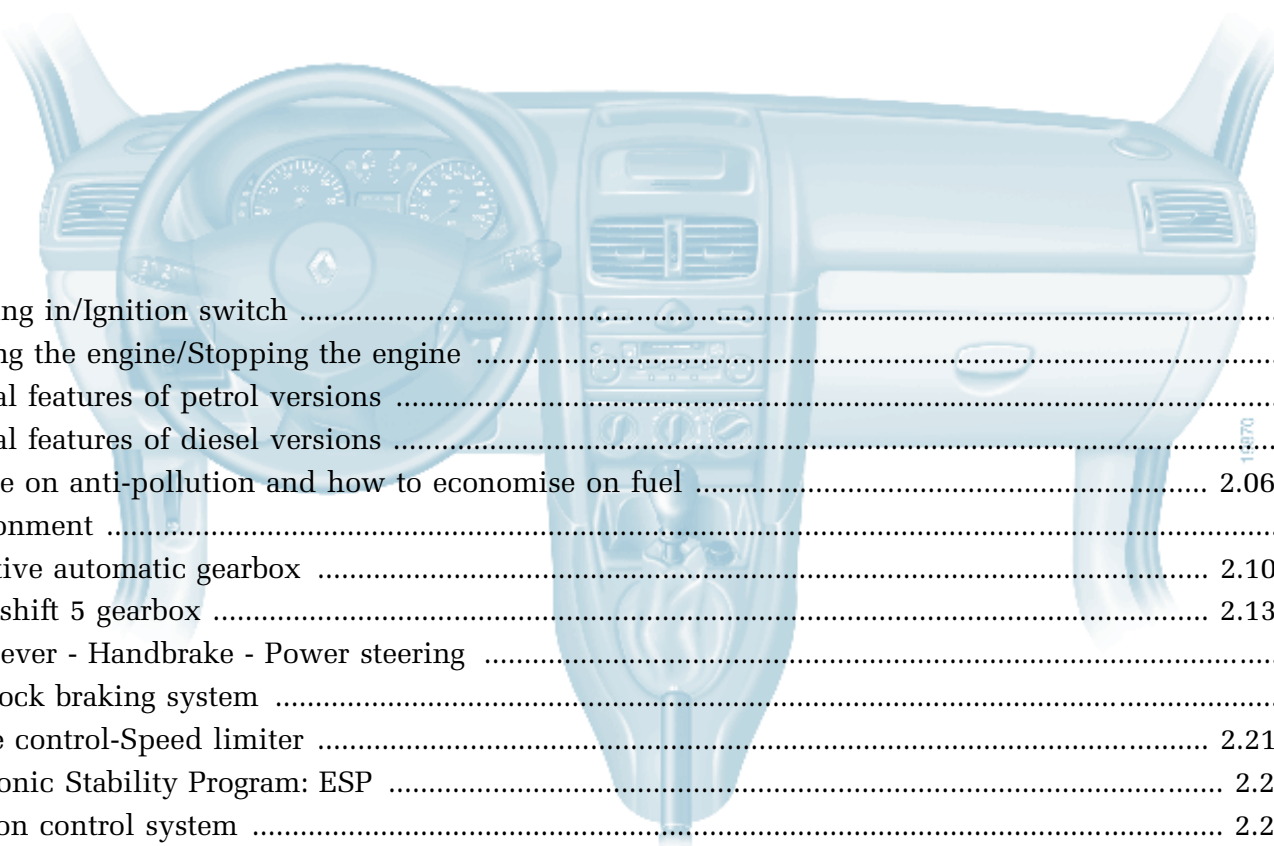

Running in/Ignition switch	2.02
Starting the engine/Stopping the engine	2.03
Special features of petrol versions	2.04
Special features of diesel versions	2.05
Advice on anti-pollution and how to economise on fuel	2.06 → 2.08
Environment	2.09
Proactive automatic gearbox	2.10 → 2.12
Quickshift 5 gearbox	2.13 → 2.18
Gear lever - Handbrake - Power steering	2.19
Anti-lock braking system	2.20
Cruise control-Speed limiter	2.21 → 2.26
Electronic Stability Program: ESP	2.27 - 2.28
Traction control system	2.29 - 2.30
	2.01





RUNNING IN

Petrol version

For the first **625 miles** (1,000 km), do not exceed 80 mph (130 km/h) in the highest gear or 3,000 to 3,500 rpm.

After 625 miles (1,000 km), you may drive your car normally, but it is only after 1,500 miles (3,000 km) have been covered that you may reasonably expect full performance.

Service intervals: refer to the vehicle's Warranty and Servicing booklet.

Diesel version

For the first **750 miles** (1,500 km), do not exceed 2,500 rpm. On completion of this mileage you may drive faster, but the vehicle will only provide top performance after approximately 4,000 miles (6,000 km).

During the running in period, do not accelerate hard while the engine is still cold and do not let the engine rev too high.

Service intervals: refer to the vehicle's Warranty and Servicing booklet.

IGNITION SWITCH



“Stop” position and anti-theft lock applied St

To lock, remove the key and turn the steering wheel until the latch clicks as it engages in the steering column.

To unlock, turn the key and steering wheel slightly.

“Accessories” position A

The ignition is switched off. Any accessories (radio...) will continue to function.

“Ignition on” position M

The ignition is on:

- **petrol version:** the engine may be started
- **diesel version:** the heater plugs are on.

“Start” position D

If the engine does not start, turn the key back before activating the starter motor again. Release the key as soon as the engine starts.

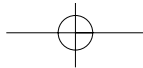

STARTING AND STOPPING THE ENGINE

Starting the engine

■ Petrol injection

Engine hot or cold

- Turn the key to the Start position **without depressing the accelerator.**
- Release the key as soon as the engine starts.

■ Diesel injection

Cold or warm engine

Turn the ignition key to the ignition on position **M**, and hold this position until the preheating warning light goes out.

Turn the key to the starter position **D**, **without accelerating.**

Release the key as soon as the engine starts.



Stopping the engine

With the engine idling, return the key to the "Stop" position.



If there is a child (or pet) in the car, never leave it unattended with the key in the ignition. With the key in the ignition it would be possible to operate the electrical equipment such as the windows and there is a risk that the child may be seriously injured (by trapping his or her neck, arm, hand, etc.).

Never switch off the ignition before the vehicle has stopped completely. Once the engine has stopped, the power steering, brake servo and passive safety devices such as airbags and pretensioners will no longer operate.

When the key has been removed, the steering will lock.

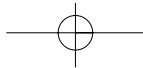

SPECIAL POINTS - PETROL VERSIONS

The following operating conditions may cause the catalytic converter to overheat and thus reduce its efficiency **or even destroy it and cause heat damage to the vehicle:**

- Driving for a long time with the low fuel level warning light illuminated;
- Faulty ignition, running out of fuel or spark plug disconnected occurring as engine misfiring and snatches when driving;
- Using leaded petrol;
- Using lubrication additives or fuel which is not approved by Renault;
- Loss of power;
- The fitting of non-recognised security systems which have been integrated into the fuel injection system for immobilisation purposes;

Bump starting the vehicle, as unburnt petrol in the system, may affect the catalyst if the car does not start quickly. However, jump starting with jump leads across the battery is permissible;

If you note any of the above faults, have the necessary repairs carried out as soon as possible by your Renault Dealer.

These faults may be avoided by taking your vehicle regularly to your Renault Dealer at the intervals specified in your "Warranty and Servicing" booklet.

Starting problems

To avoid damaging the catalytic converter, **do not keep trying** to start the engine (using the starter, or by pushing or pulling the vehicle) **without having identified and corrected the cause of the fault.**

If the fault cannot be found, do not try to start the engine again, but call for the assistance of a Renault Dealer.



Never park the vehicle or run the engine in locations where combustible substances or materials such as grass or leaves may come into contact with a hot exhaust system.



SPECIAL POINTS - DIESEL VERSIONS

Diesel engine speed

Diesel engines have an injection system with a mechanical governor **which prevents overrevving of the engine** regardless of the gear engaged.

Running out of fuel

After filling the tank, **if you have run completely out of fuel**, on condition that the battery is fully charged, the engine may be started normally.

If, after a few seconds, after several attempts, the engine will not start, call for the assistance of a Renault Dealer.

Winter precautions

To avoid any problems in icy conditions:

- ensure your battery is always well charged.
- ensure the fuel level in the tank never drops too low to avoid condensation forming at the bottom of the tank.

Vehicles fitted with a diesel fuel heater

This allows diesel fuel to be used **with no additives down to -18°C** , or, in the case of a vehicle used regularly over short distances (engine cold) **down to -5°C** .

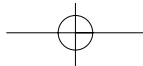

ADVICE ON ANTIPOLLUTION AND HOW TO ECONOMISE ON FUEL WHEN DRIVING

RENAULT actively participates in the reduction of pollutant exhaust gas emissions and in saving energy.

By virtue of its design, its original settings and moderate fuel consumption, your RENAULT conforms to the current antipollution standards. Technical design cannot achieve everything, however. The level of exhaust gas pollutant emissions and the fuel consumption of your vehicle is within your control. Ensure that your vehicle is maintained correctly, and that you drive and use it carefully.

Maintenance

Not observing the antipollution legislation may lead to the owner of the vehicle being prosecuted. Replacing parts of the engine, the fuel supply system and the exhaust with parts which are not original parts recommended by the manufacturer may mean that your vehicle no longer conforms to the antipollution regulations.

Have your vehicle checked and adjusted by your Renault Dealer in accordance with the instructions in your Warranty and Servicing booklet.

Your Renault Dealer has all the equipment necessary to ensure that your vehicle is maintained to its original standard.

Always remember that the emission of pollutant fumes is directly linked to fuel consumption.

Engine adjustments

- **ignition:** this requires no adjustment
- **spark plugs:** optimum conditions of use, performance and output require that the specifications laid down by our Design Department be rigorously adhered to.

If the spark plugs have to be replaced, use the make, type and gap specified for your engine. Consult your Renault Dealer for this information.
- **idle speed:** this requires no adjustment.
- **air filter, diesel fuel filter:** a blocked cartridge reduces output and must be replaced.
- **injection pump setting:** this must be set to the recommended values.

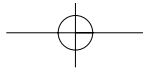

ADVICE ON ANTIPOLLUTION AND HOW TO ECONOMISE ON FUEL WHEN DRIVING (continued)

Monitoring exhaust gas

The exhaust gas monitoring system will detect any malfunctioning of the vehicle's exhaust gas depollution system.

If this system malfunctions, toxic substances may be released into the atmosphere or mechanical damage may occur.



This warning light on the instrument panel will indicate if there are any problems with the system:

This lights up when the ignition is switched on and then goes out.

- If it lights up continuously, consult your Renault Dealer as soon as possible.
- If it flashes, reduce the engine speed until the light stops flashing. Consult your Renault Dealer as soon as possible.

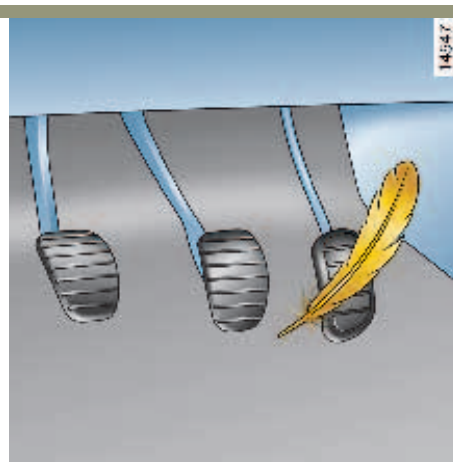

Driving

- Drive carefully for the first few miles until the engine reaches its normal operating temperature rather than letting it warm up while stationary.
- Speed is expensive.
- “Snappy” driving uses a lot of fuel: drive with a “light right foot”.

- Brake as little as possible by suitably anticipating an obstacle or bend and then simply releasing the accelerator pedal.
- Avoid sudden acceleration.
- Do not overrev the engine in intermediate gears. Use the highest gear possible without labouring the engine. (On versions with an automatic gearbox, try to always use position **D**.)
- Try not to maintain the same speed up a hill as you would on the level; keep your foot in the same position on the accelerator pedal.
- Double declutching and accelerating before switching off the engine are superfluous actions in modern cars.

- Bad weather, flooded roads
Do not drive on flooded roads if the depth of water is above the lower edge of the wheel rims.





ADVICE ON ANTIPOLLUTION AND HOW TO ECONOMISE ON FUEL WHEN DRIVING (continued)

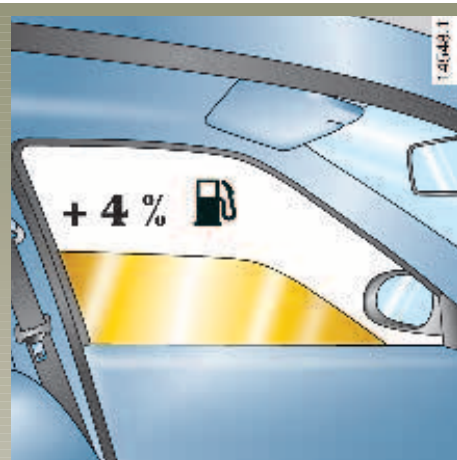

General hints

- Electricity is “fuel”; switch off all the electrical units which are not really needed.

However, (with safety always in mind), keep your lights on when the visibility is bad (see and be seen).

- Try to use the air vents. Driving at a speed of 60 mph (100 km/h) with the windows open will increase the use of fuel by 4%.

- For vehicles fitted with air conditioning, more fuel may be used during urban driving; switch off the system when it is not really needed.
- Never fill the fuel tank up to the brim to avoid it overflowing.
- Do not leave an empty roof rack in position.
- Use a trailer for carrying bulky objects.
- When towing a caravan, fit a wind deflector and adjust it properly.
- Avoid using the car for door to door calls (short journeys with long stops in between), as the engine never reaches its ideal temperature. Try to group your calls.

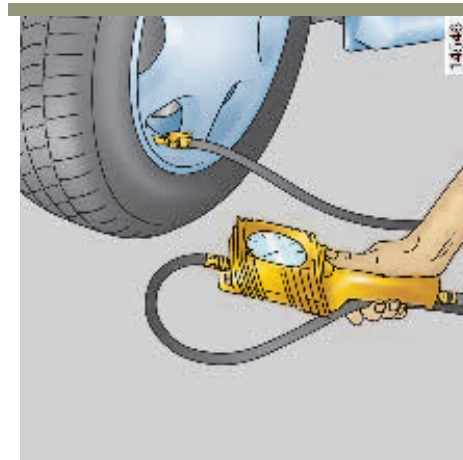

Tyres

- Inflation pressures which are too low may increase fuel consumption.
- The use of non-recommended tyres may also increase fuel consumption.



ENVIRONMENT

Your vehicle has been designed with the aim of caring for **the environment**.

- Most versions are fitted with a depollution system incorporating the **catalytic converter, oxygen sensor and active carbon filter** (which prevents fuel vapour evaporating from the fuel tank into the open air).
- **These vehicles run on unleaded fuel only.**
- your vehicle comprises 87% **recyclable parts** and already contains parts which are made from **recycled materials** (as marked on the diagram above).
- 95% of the plastic parts in your vehicle are marked by a symbol which allows the principal component material to be identified. This marking means that the parts removed can be sorted more easily, making recycling of each of them easier.

In addition, your vehicle meets the requirements of European legislation concerning the protection of the environment.

Make your contribution to environmental protection too !

Do not dispose of parts replaced in the course of routine vehicle maintenance (battery, oil filter, air filter...) and oil cans (empty or filled with old oil...) with household waste.

Dispose of them through specialist organisations. In all cases comply with local legislation.

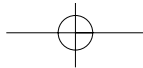

PROACTIVE AUTOMATIC GEARBOX

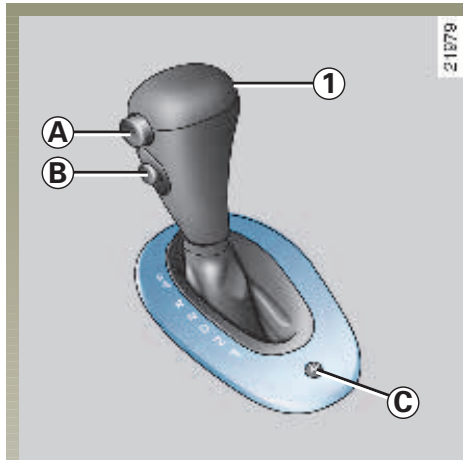

Selector lever 1

P : Park

R : Reverse

N : Neutral

D : Drive in automatic
(gears authorised: 1, 2, 3 and 4)

2 : 2nd gear hold **H**
(gears authorised: 1, 2)

1 : 1st gear hold **H**.

The display **E** and indicator lights **F**, **G**, **H**, **I**, on the instrument panel indicate the position of the gear lever **1** and/or the operating mode of the automatic gearbox.



Position D3 or 3rd gear hold

(Gears authorised: 1, 2, 3).

With the selector lever in position **D**, press button **B**. Indicator light **G** will light up on the instrument panel. Press button **B** again to deselect this position. (indicator light will go out.)

Note: When indicator light is lit, the system will prevent 4th gear being selected.

For safety reasons, certain positions may not be selected until the mechanism is released: press button **A**.

The lever may only be moved to **D** or **R** when the vehicle is stationary, with your foot on the brake and the accelerator pedal released.

Moving off forwards

With the lever in position **P** or **N**, switch on the ignition.

With your foot on the brake pedal, move the lever out of position **P** or **N**.

For safety reasons, to take the lever out of position **P**, the brake pedal must be pressed before pressing the releasing button **A**.

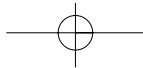

PROACTIVE AUTOMATIC GEARBOX (continued)

Forward gears

Move the lever to position **D**. In the majority of traffic conditions, you will not have to move the lever again: the gears will change automatically at the right time and at the appropriate engine speed, since the automatic system takes into account the vehicle load, the road contour and the particular driving style you have chosen.

Acceleration and overtaking

Fully depress the accelerator pedal quickly (or take your foot off the accelerator and press it in again as far as it will go).

When the pedal is depressed quickly, it activates the “kickdown” switch to obtain maximum performance.

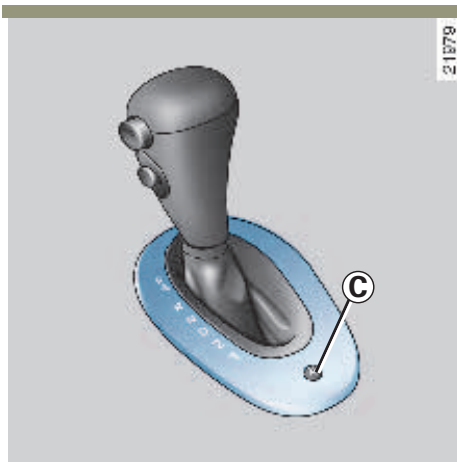

Special circumstances

- **Snow position:** if you are driving on a surface with low adhesion (snow, mud etc.), press switch **C**, warning light **F** will come on.

When these driving conditions no longer apply, turn the system off by pressing button **C again and the warning light will go out.**

- **In hilly or mountainous country:** if the road conditions and the number of bends do not allow you to remain in 4th, we recommend you select position **D3** (by pressing button **B**, with the gear lever in position **D**), or even **2** (2nd gear hold), to avoid the transmission changing to a higher gear than the one selected. Position **1**, which enforces the use of 1st gear, gives good engine braking.

When travelling downhill for a long way, select position **D3** or **2** (or even **1**) to give more efficient engine braking, and to relieve the brakes.

- **In cold weather,** to prevent the engine from stalling, wait for a few moments before moving the lever from position **P** or **N** to position **D** or **R**.



PROACTIVE AUTOMATIC GEARBOX (continued)

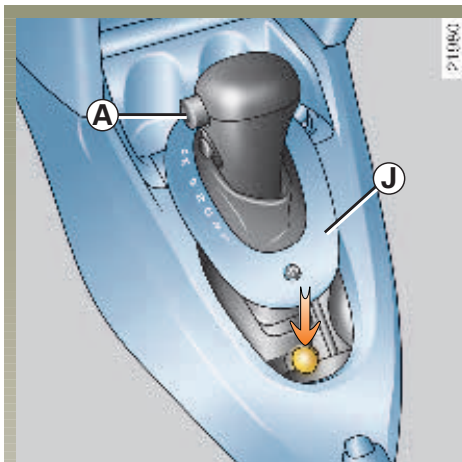

Economical driving

On the open road, always leave the lever in position **D**. Press the accelerator pedal lightly to ensure that the gears change automatically at a low engine speed.

Never use positions D3, 2, 1 and the snow position unless special circumstances apply.

Parking the vehicle

When the vehicle is stationary, place the lever in position **P** while keeping your foot on the brake pedal: the automatic gearbox is in neutral and the drive wheels are mechanically locked by the gearbox.



Apply the handbrake.

Operating faults

- **If the lever becomes jammed in P**, even though you are depressing the brake pedal, it can be released manually.

To do this, unclip the cover **J** then simultaneously press the button (located under the cover **J**) and the unlocking button **A** to move the lever from **P**.

Consult your RENAULT Dealer.

-  If warning light **I** comes on when the vehicle is being driven, it is indicating that there is a failure. Consult a RENAULT Dealer as soon as possible.
-  and  : If these warning lights come on simultaneously when the vehicle is being driven, avoid leaving the gear lever in **D** position (or **R**) when stopping in traffic: always return to **N** position when stopped. Consult a RENAULT Dealer as soon as possible.
- **If a vehicle with an automatic gearbox breaks down**, refer to the information on towing in section 5.

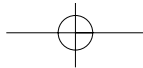

QUICKSHIFT 5 GEARBOX

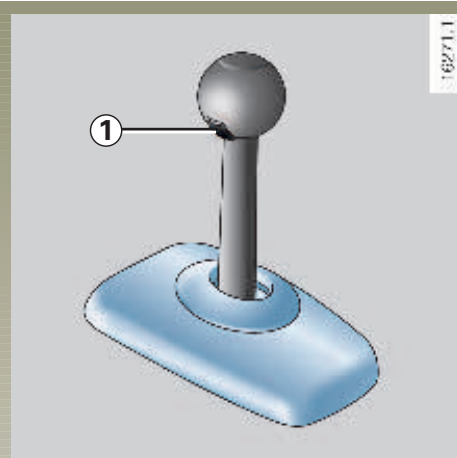

Selector lever

1 Mode selection button: enables you to move from manual mode to automatic mode or from automatic to manual mode at any time with the engine running.

Note: The selector lever automatically returns to the middle position after use.

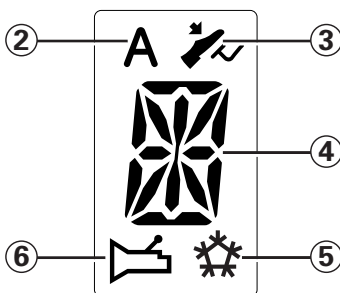

Display

- 2** automatic mode
- 3** brake pedal depressed warning light
- 4** gear display
- 5** not used
- 6** gearbox fault warning light.

The gear used (**1**, **2**., **5**, **N**, **R**) is indicated in the instrument panel display. In automatic mode, (**A**) is also displayed.

Driving

Switch on the ignition.

The display lights up on the instrument panel.

As long as neutral is displayed (**N**), start the engine but do not depress the accelerator.

If a gear other than neutral (**N**) is displayed this will flash; **it will only be possible to start the engine if you press down the brake pedal (the warning light 3 will come on if you forget) when holding the key in starting position.**

The vehicle will then change to neutral (**N**) automatically and the engine will start.

Note: do not attempt to start the engine by pushing the vehicle if the battery is flat (the display remains off when the ignition is switched on).

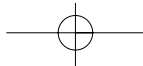

QUICKSHIFT 5 GEARBOX (continued)

Starting up

Moving forwards (starting in neutral)

The gear display shows *N* and *A*.

- **With your foot on the brake pedal**, push the selector lever toward the front and then release it again.
- Release the brake pedal:
 - it is possible to carry out parking manoeuvres when the engine is idling.
 - accelerate gently to move off.

Note: you can pull away in second gear if you are driving on slippery surfaces (snow, mud, etc.).

To do this, move the gear selector lever twice with your foot on the brake pedal.

The figure 2 appears on the dashboard display. The system is then running in semi-automatic mode.

To return to automatic mode, press the mode change button.

Reverse

- **Foot on the brake pedal.** Push the lever as far as it will go to the right, hold and pull back according to the marking on the knob, then release it. Reverse gear is engaged and the letter *R* appears on the display.
- Release the brake pedal:
 - it is possible to carry out parking manoeuvres when the engine is idling.
 - accelerate gently to reverse.

Note: You should put your foot on the brake to engage or disengage a gear when stopping. Otherwise, the gear selected will flash and the warning light **3** will come on.

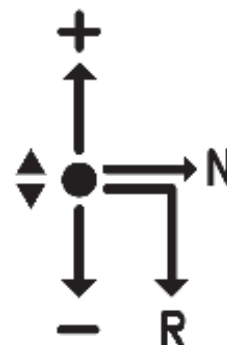

Gear selection gate

- + To move up through the gears
- To move down through the gears
- N* Neutral
- R* Reverse
- Only stable lever position



QUICKSHIFT 5 GEARBOX (continued)

Semi-automatic mode (manual)

When in automatic mode, moving the selector lever up or down through the gears or pushing the automatic mode switch will switch the system into semi-automatic mode. If you push the switch, you do not need to shift up or down through the gears.

You can initiate gear changes using the selector lever.

To move up through the gears simply push the selector lever forwards without necessarily releasing the accelerator.

To move down through the gears simply push the selector lever backwards without necessarily releasing the accelerator.

The system will not tolerate a series of up or down changes that cause the engine to underrev or overrev.

Pushing forwards twice in succession enables a shift up of two gears at once (except in the case of underrev). Pulling backwards twice in succession enables a shift down of two gears at once (except in the case of overrev).

When decelerating with the foot off the pedal, the gears will automatically drop to the low speed limit to avoid stalling. First gear automatically passes below a certain speed limit. You can stop the vehicle at red lights or junctions etc. by pressing the brake pedal; there is no need to change to neutral (N).

The vehicle will move off again:

- slowly, if you release the brake without accelerating (e.g. when in a traffic jam)
- quickly, if you release the brake and accelerate.

Note: neutral is only accessible when you are driving or stationary with **your foot on the brake (if you forget, the warning light 3 will come on and the N sign will flash).**

Push the gear lever to the right to engage neutral.

Moving from one mode to another can be performed with the engine running, at any time and in all ratios.



QUICKSHIFT 5 GEARBOX (continued)

Automatic mode

Automatic mode is selected by default every time the ignition is switched on.

You can change it at any time when driving by pressing the mode change button. The letter **A** appears on the display.

The vehicle is controlled using the accelerator and the brake. Gears will change automatically at the correct moment to a speed suitable for the engine because the automatic function takes into consideration the weight of the car, the road surface and the chosen driving style.

Note:

Automatic mode takes account of:

- the position and speed of depression of the accelerator pedal to assess driving style and select the optimum gear,
- action on the brake pedal to alert the engine brake by anticipating the down-change

You can stop the vehicle at red lights, with the gear engaged, by pressing the brake pedal; there is no need to change to neutral.

The vehicle will move off again:

- slowly, if you release just the brake without accelerating (e.g. when in a traffic jam)
- quickly, if you release the brake and accelerate.



The level of oil in the automatic gearbox system reservoir is variable depending on use. Adding oil is **strictly forbidden** (except by qualified Renault network personnel).

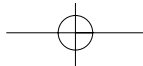

QUICKSHIFT 5 GEARBOX (continued)

Accelerating and overtaking

You have two options:

- 1) slowly depress the accelerator pedal to speed up gradually.
- 2) depress the accelerator pedal as far as it will go (or: take your foot off the pedal and depress the pedal again until you reach the point of resistance).

Parking

It is possible to park in gear (for example, on a slope). To do this:

- with the ignition on, select a gear **with your foot on the brake**.
- check that a gear other than **N** is displayed on the instrument panel, then remove the ignition key.

To disengage the gear, repeat this operation by switching on the ignition without starting the engine and shift the selector lever to neutral **with your foot on the brake**.

Check that **N** is displayed on the instrument panel.

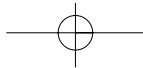

QUICKSHIFT 5 GEARBOX (continued)

Horn

- If you keep the vehicle on a slope for too long without applying the brakes or handbrake, there is a risk that the clutch will overheat.

In this event, an intermittent beep will remind you that you should put your foot on the brake or apply the handbrake.

- Never leave the vehicle with the engine running when in gear. For safety reasons you will hear an intermittent beep when you open the door if you have not shifted into neutral or you have not switched off the ignition or pressed the brake pedal.

- Your vehicle will not start: you can start the engine when the vehicle is moving if the battery is not discharged (display lit up).

Proceed as before:

- switch on the ignition
- select neutral
- push or tow the car or run it down a slope until you reach the speed at which the warning buzzer is activated. This will indicate that moving the selector lever forwards will engage the gear most suited to starting the engine.

Note: never attempt this in reverse.

Operating faults



When driving, if this warning light comes on, it indicates a fault in the system.

In most cases, you may still drive the vehicle, although it will not function perfectly. However, you should consult a Renault Dealer as soon as possible.

Towing a vehicle with a sequential gearbox

If the gearbox is stuck in a gear:

- switch on the ignition
- select neutral with your **foot on the brake**
- check that the gearbox is in neutral (by pushing the vehicle, for example).

If you cannot find neutral you must tow the vehicle with the front wheels raised.

Towing should always take place with the ignition switched off.

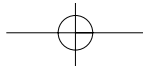

GEAR LEVER

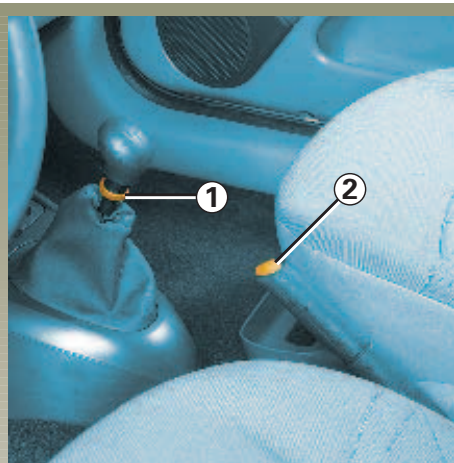

To select reverse (vehicle stationary)

Move the lever to neutral, then lift up ring **1** against the gear lever knob to select reverse gear.

The reversing lights illuminate as soon as reverse gear is selected (ignition on).

HANDBRAKE

To release

Pull the lever up slightly, press in button **2** and lower the lever to the floor.

If you are driving with the handbrake incorrectly released, the red warning light on the instrument panel will remain illuminated.

To apply

Pull the lever upwards.

The lever should travel about 10 notches to hold the vehicle. Your vehicle has self adjusting rear brake shoes and the handbrake should only be adjusted during a brake overhaul.



When the vehicle is stationary, make sure that the handbrake is properly applied so that the vehicle does not move unintentionally.

Make sure the handbrake is properly released when driving, otherwise overheating may occur.

POWER ASSISTED STEERING

Never leave the steering on full lock when the vehicle is parked (risk of damaging the power assisted steering pump).



Never switch off the engine when travelling downhill, and avoid doing so when driving in general (power steering and brake servo will not function).

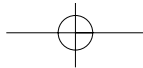

ANTI-LOCK BRAKING SYSTEM (ABS)

When braking sharply, the two main aims are to reduce the stopping distance and to keep the vehicle under control. However, depending on the nature of the ground, the atmospheric conditions and your reactions, dangers due to loss of adherence may exist: the wheels may lock and directional control may be lost. To avoid these risks, your vehicle has been fitted with the anti-lock braking system (ABS).

The safety enhancement is that the brake control system prevents the wheels from locking, even if the brakes are applied too sharply, allowing the vehicle to be steered and thus its direction to be controlled. Under these circumstances, it is quite possible for the driver to steer the vehicle and avoid an obstacle whilst at the same time applying the brake. This system also allows stopping distances to be improved, especially when adherence is limited (wet roads, slippery or uneven road surface).

Although this system allows this optimisation, the ABS system in no way increases performance which is physically related to the local adherence conditions between the tyres and the ground. You must still follow the rules of good driving practice (driving at a safe distance from the vehicle in front etc.). **The fact that the vehicle's safety has been increased should not encourage you to take risks.**



Each time the system is activated, you will feel a certain degree of pulsation at the brake pedal. These tangible signs will warn you that the adhesion between the tyres and the ground has reached its limit and enable you to adapt your driving style to suit the road conditions.

Operating incidents

Two situations must be considered:

1 - The warning light  is illuminated on the instrument panel.

Braking is still assured, but without the action of the ABS system. Consult a Renault Dealer as soon as possible.

2 - The warning lights   are illuminated on the instrument panel.

This indicates a fault in one of the ABS braking components. Braking may be partially assured. It is however **dangerous to brake sharply**, so you must stop immediately as soon as traffic conditions allow. Call for the assistance of a Renault Dealer as soon as possible.

The braking modulation provided by the ABS system is independent of the force applied at the pedal. In an emergency, apply **firm, continuous pressure** at the brake pedal - there is no need to pump it repeatedly.

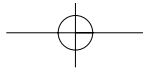

CRUISE CONTROL - SPEED LIMITER: limiter function



The speed limiter function allows you to decide on a maximum driving speed.

This may be useful, for example, in town driving or in areas with speed restriction (roadworks), etc.

The system operates above a driving speed of approximately 20 mph (30 km/h).

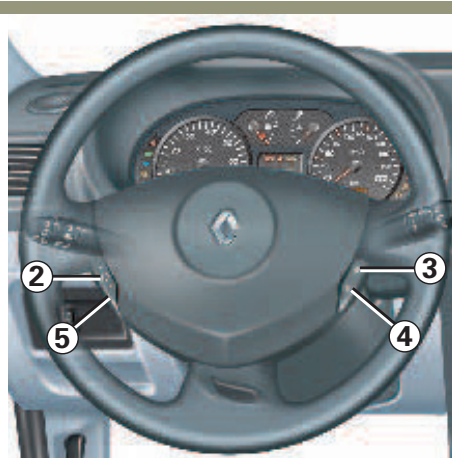

Controls

- 1 Main On/Off switch
- 2 Limited speed storage switch and adjustment of limited speed (increasing).
- 3 Return to stored limited speed.
- 4 Switching the function off (with stored limited speed)
- 5 Limited speed storage switch and adjustment of limited speed (decreasing).



Indicator light



This orange indicator light lights up on the instrument panel to indicate that the limiter function is in operation.

Stored speed information appears on instrument panel display 6 permanently or for approximately 30 seconds, depending on vehicle type.



CRUISE CONTROL - SPEED LIMITER: limiter function (continued)



Switching on

Press the side switch **1**



The indicator light lights up in the instrument panel and the on-board computer enters speed limiter mode.

Limiting the speed

At a stable speed (approximately 20 mph or 30 km/h) and in the correct gear (for vehicles with manual gearboxes), press switch **2**: the speed is stored.

Driving

When a limited speed is stored, press on the accelerator pedal until you reach the limited speed.

From this point, no effort on the accelerator pedal will allow you to exceed the programmed speed except in an emergency (see information on exceeding the limited speed).



Changing the limited speed

The limited speed may be changed by acting (pressing frequently or continuously) on:

- button **2** to increase speed,
- button **5** to reduce speed.

If the car has the temporary display function, the limited speed is displayed for approximately 30 seconds.



CRUISE CONTROL - SPEED LIMITER: limiter function (continued)

Exceeding the limited speed

In the event of an emergency

It is possible to exceed the limited speed at any moment. To do this: depress the accelerator pedal **firmly and fully** (beyond the point of resistance).

The speed flashes on the instrument panel (on-board computer) to inform you that the cruise control speed is being exceeded.

When the emergency has passed, release the accelerator pedal: the speed limiter function will return as soon as you reach a speed lower than the limited speed before the emergency.

Impossible to operate at the limited speed

If the limited speed cannot be maintained by the system (for example in the event of a steep incline), the speed will flash on the instrument panel (on-board computer).



Switching the function off

The speed limiter function is interrupted when you press:

- button **4**, in this case the limited speed remains stored
- button **1**, in this case the limited speed is no longer stored.

Confirmation that the function has been switched off is given when the indicator light on the instrument panel goes out.



Return to limited speed

It is possible to return to a stored speed by pressing button **3**.

If the car has the temporary display function, the limited speed is displayed for approximately 30 seconds.

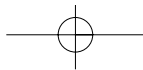

CRUISE CONTROL - SPEED LIMITER: cruising function



When road conditions permit (fluid or motorway traffic), the cruise control allows you to take your foot off the accelerator while your car continues to cruise at the speed you have selected. This is called the “cruising speed”.

This cruising speed may be set at any speed at speeds of 20 mph (30 km/h) and above.

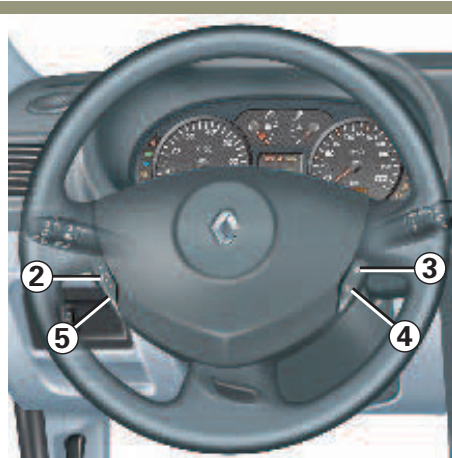

Controls

- 1 Main On/Off switch
- 2 Cruising speed storage switch and adjustment of limited speed (increasing)
- 3 Return to stored cruising speed
- 4 Switching the function off (with stored cruising speed)
- 5 Cruising speed storage switch and adjustment of limited speed (decreasing)



Indicator light



This green indicator light lights up on the instrument panel to indicate that the cruising function is in operation.

Stored speed information appears on instrument panel display 6 permanently or for approximately 30 seconds, depending on vehicle type.

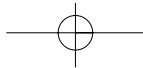

CRUISE CONTROL - SPEED LIMITER: cruising function (continued)



Switching on

Press side switch **1**



The indicator light lights up in the instrument panel and the on-board computer enters cruise control mode.

Activating cruise control

At a stable speed (approximately 20 mph or 30 km/h) and in the correct gear (for vehicles with manual gearboxes), press switch **2**: the speed is stored.



Driving

When a cruise control speed is stored you can lift your foot off the accelerator pedal.

Changing the cruise control speed

The cruise control speed may be changed by acting (pressing repeatedly or continuously) on:

- button **2** to increase speed,
- button **5** to reduce speed.

If the car has the temporary display function, the limited speed is displayed for approximately 30 seconds.

Exceeding the cruise control speed

In the event of an emergency

The cruising speed may be exceeded at any time by pressing the accelerator pedal.

The speed flashes on the instrument panel (on-board computer) to inform you that the cruise control speed is being exceeded.

When the emergency has passed, release the accelerator pedal: your vehicle will automatically return to the speed previously selected and the indicator light will go out.

Impossible to operate at the speed selected

If the adjusted speed cannot be maintained by the system (for example in the event of a steep incline), the speed will flash on the instrument panel (on-board computer).



CRUISE CONTROL - SPEED LIMITER: cruising function (continued)



Switching the function off

The function is switched off when you:

- press the brake pedal,
- press the clutch pedal to shift to neutral for vehicles with automatic gearbox,
- press button **4**; in this case the selected speed remains stored,
- press button **1**; in this case the selected speed is no longer stored.

Confirmation that the function has been switched off is given when the indicator light on the instrument panel goes out.



Return to cruising speed

A stored speed can be recalled by pressing button **3** if you are driving at a speed of approximately 20 mph (30 km/h).

If the car has the temporary display function, the limited speed is displayed for approximately 30 seconds.



This function is an additional aid to driving.

However, the function does not take the place of the driver. Under no circumstances should it replace observation of speed limits nor vigilance and responsibility on the part of the driver.





ELECTRONIC STABILITY PROGRAM: ESP

This system helps you to keep control of the vehicle in “critical” driving conditions (avoiding an obstacle, loss of grip in a bend...).



This function is an additional aid in the event of critical driving conditions to allow the behaviour of the vehicle to be adapted to the driving conditions.

However, the function does not take the place of the driver. **It does not increase the vehicle's limitations and should not encourage you to drive more quickly.**

It can, thus, under no circumstances replace the vigilance or responsibility of the driver when manoeuvring the vehicle (the driver must always be aware of sudden incidents which may occur when driving).

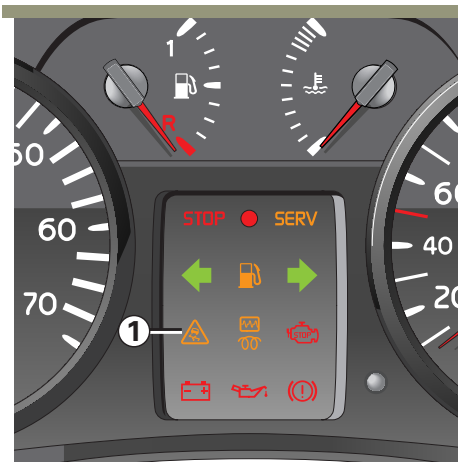

Operating principle

A sensor in the steering wheel detects the path selected by the driver.

Other sensors throughout the vehicle measure the actual path.

The system compares the path selected by the driver and the actual vehicle path and corrects this as necessary by applying the brakes selectively and/or acting on the engine power.

When the function is in operation, message **1** lights up to confirm this.



ELECTRONIC STABILITY PROGRAM: ESP (continued)



Disabling the function

The function is deactivated by pressing switch **2**, warning light **1** will light up to confirm this.

This action also deactivates traction control: see the information on the traction control system in section 2.



As the ESP offers additional safety, it is recommended that you do not drive when the function is disabled. Correct this as soon as possible by pressing button **2** again.

Note: ESP is automatically reactivated when the ignition is switched on.

Faults

When the system detects an operating fault, warning lights **1** and **3** light up.

Consult your Renault Dealer.



TRACTION CONTROL SYSTEM

This system helps to limit skidding on drive wheels and to control the vehicle when pulling away or accelerating.



This function is an additional aid in the event of critical driving conditions to allow the behaviour of the vehicle to be adapted to the driving conditions.

However, the function does not take the place of the driver. **It does not increase the vehicle's limitations and should not encourage you to drive more quickly.**

It can, thus, under no circumstances replace the vigilance or responsibility of the driver when manoeuvring the vehicle (the driver must always be aware of sudden incidents which may occur when driving).

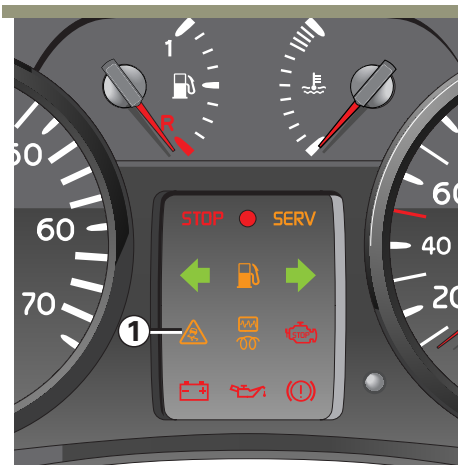

Operating principle

The system uses sensors in the wheels to constantly measure and compare the speed of the drive wheels and prevents them spinning.

If a wheel is tending to skid, the system brakes automatically until the drive delivered becomes compatible with the level of grip.

The system also adjusts the engine speed to the grip available under the wheels, independently of the action exerted on the accelerator pedal.

When the function is in operation, message **1** lights up to confirm this.



TRACTION CONTROL SYSTEM (continued)



Disabling the function

In some situations (driving on very wet ground: snow, mud,... or driving with chained wheels), the system may reduce the engine power to limit skidding. It is possible to deactivate the function by pressing switch **2** if this is not desirable.

Warning light **1** lights up.



Disabling the traction control function also deactivates the ESP function: refer to the information on the ESP in section 2.

Correct this as soon as possible by pressing switch **2** again.

Note: traction control is automatically reactivated when the ignition is switched on.

Operating faults

When the system detects an operating fault, warning lights **1** and **3** light up.

Consult your Renault Dealer.

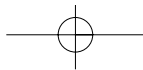

Section 3: Your comfort

Air vents	3.02 - 3.03
Heating and air conditioning	3.04 → 3.22
Interior lights	3.23 - 3.24
Electric windows	3.25
Sun visor/Vanity mirrors/Windscreen	3.26
Sunroof	3.27 → 3.29
Storage compartments	3.30 - 3.31
Ashtrays - Cigarette lighters	3.32
Rear bench seat	3.33
Luggage compartment	3.34 - 3.35
Rear window shelf - separating grille	3.36
Transporting items in the luggage compartment	3.37

3.01



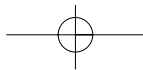

AIR VENTS (air outlets)

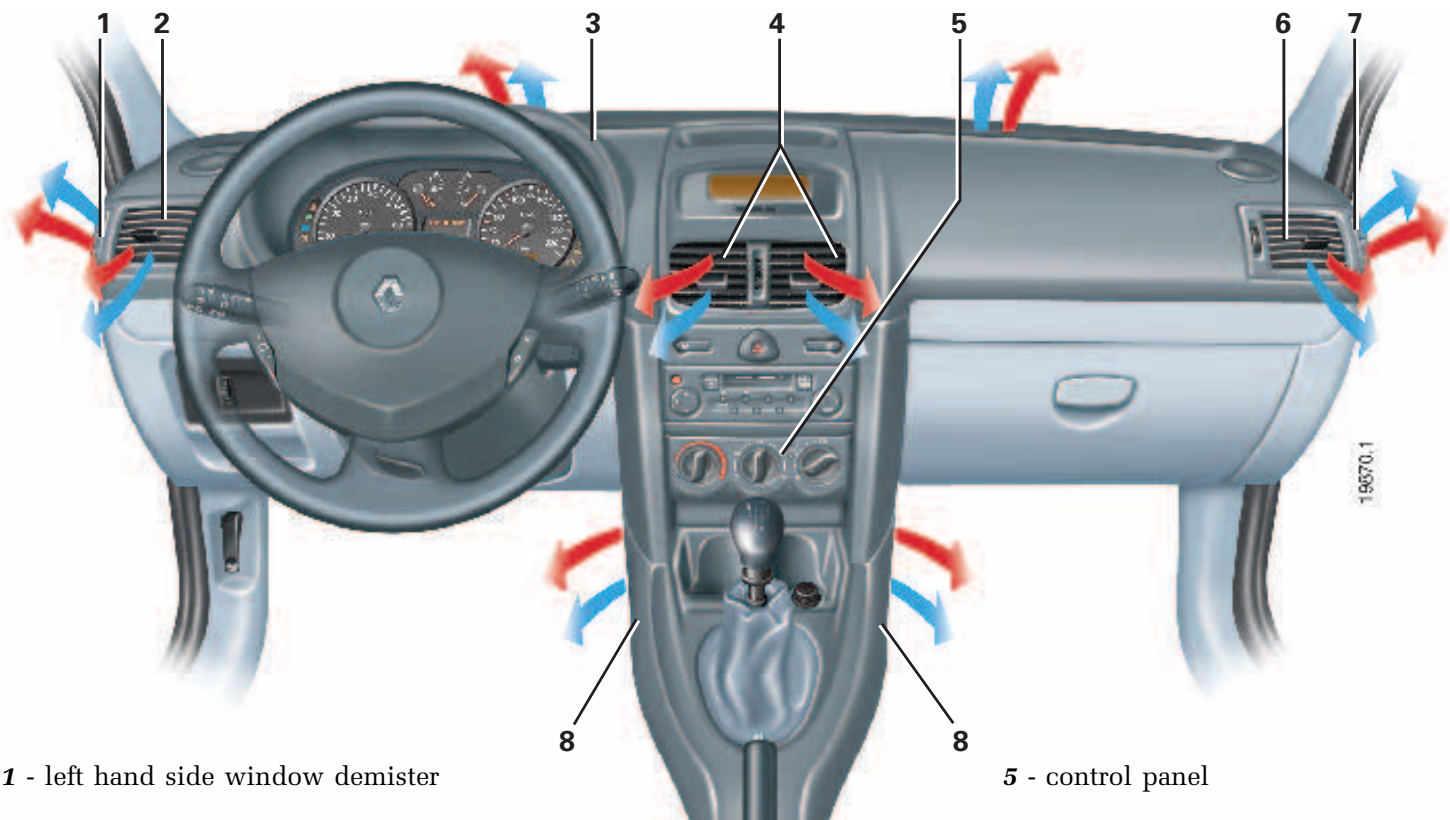

1 - left hand side window demister

2 - left hand side air vent

3 - windscreen demisting vents

4 - centre air vents

3.02

5 - control panel

6 - right hand side air vent

7 - right hand side window demister

8 - heater outlets for front and rear footwells



AIR VENTS (continued)

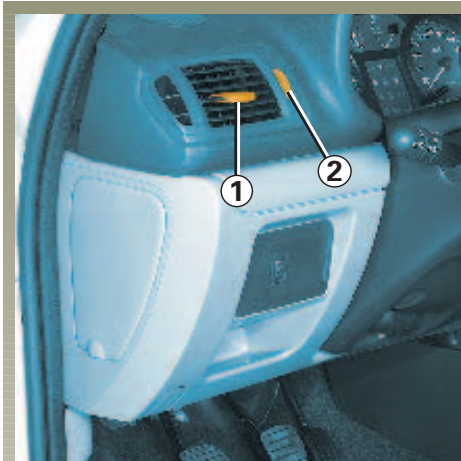

Side air vents

Flow:

Move wheel **2** (beyond the point where a certain resistance is felt).

 : fully open.

 : closed.

Direction:

Right / left: move tab **1**.

Up / down: press on the top or bottom of the air vent



Centre air vent

Flow:

Move wheel **4** (beyond the point where a certain resistance is felt).

 : fully open.

 : closed.

Direction:

Right / left: move tabs **3**.

Up / down: press on the top or bottom of the air vent

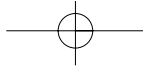

HEATING - VENTILATION

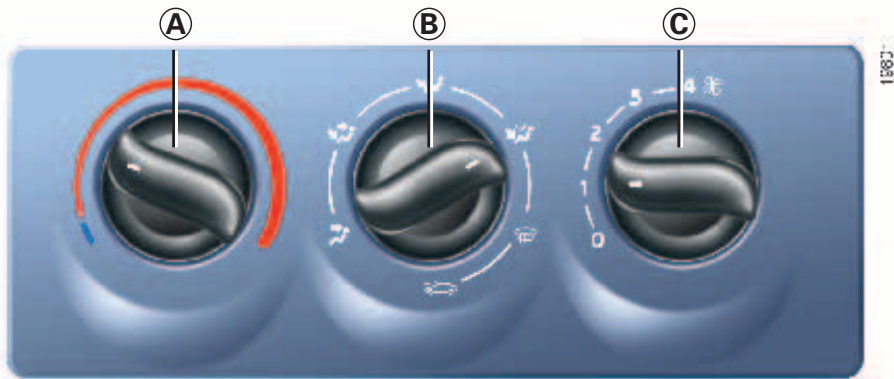

Controls

- A** Air temperature adjustment.
- B** Distribution of air.
- C** Adjusting air volume output.

Adjusting the air temperature

Move control **A**.
The further the control is positioned to the right, the higher the temperature.

Distribution of air in the passenger compartment

Move control **B**.

- **Position**



The air flow is directed to the dashboard air vents only.

This selection is not appropriate if all the air vents are closed.

- **Position**



The air flow is directed to the dashboard air vents and the footwells.

- **Position**



The air flow is directed to the footwells.

- **Position**



The air flow is distributed between all the air vents, the side window demisters, the windscreen demisters and the footwells.



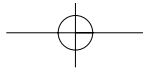

HEATING - VENTILATION (continued)

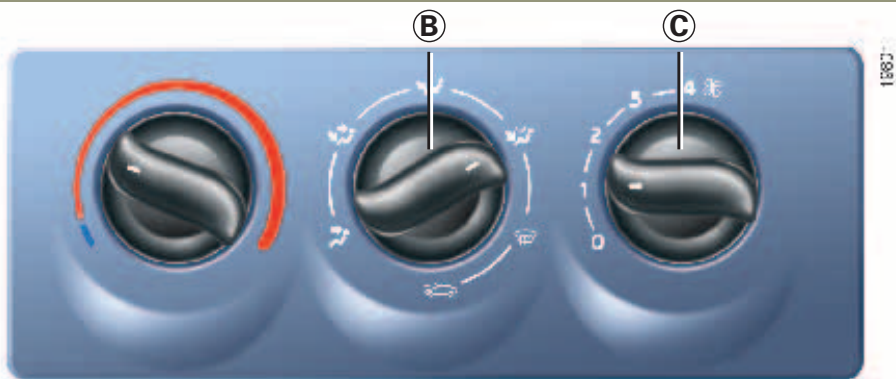

- Position



For improved efficiency, close the dashboard air vents.

All the air flow is directed to the windscreen demisters and the side window demisters.

- Position



(Isolation position)

This position prevents any air from entering (regardless of the position of control **C**). This allows the passenger compartment to be isolated from the external environment (driving through polluted areas, etc.).

Prolonged use of the ISOLATION position may cause the windows to mist up.

We recommend that another position is selected as soon as the polluted area is left behind.

Adjusting the amount of air supplied to the passenger compartment

Move control **C** from **0** to **4**.

Passenger compartment ventilation is by blown air. The blower determines how much air enters but car speed has some effect on this.

The further the control is positioned to the right, the greater the volume of air blown into the passenger compartment.



HEATING - VENTILATION AND ISOLATING THE PASSENGER COMPARTMENT

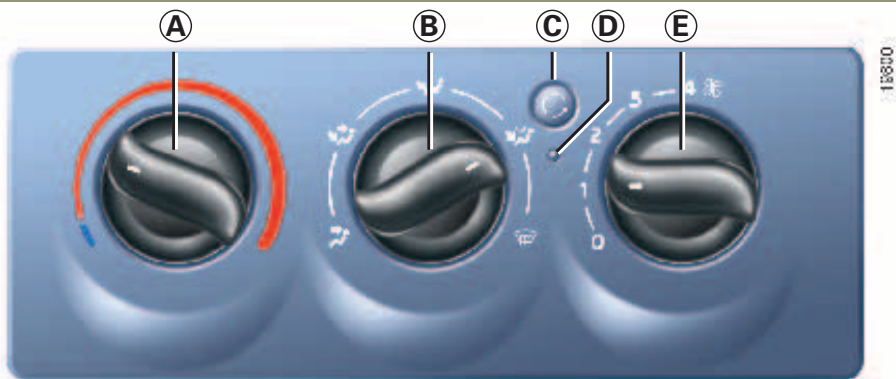

Controls

- A** Air temperature adjustment.
- B** Distribution of air.
- C** Isolation of the passenger compartment (air recirculation).
- D** Air recirculation operation indicator light.
- E** Adjusting air volume output.

Distribution of air in the passenger compartment

Move control **B**.

- **Position** 

The air flow is directed to the dashboard air vents only.

This selection is not appropriate if all the air vents are closed.

- **Position** 

The air flow is directed to the dashboard air vents and the footwells.

- **Position** 

The air flow is directed to the footwells.

- **Position** 

The air flow is distributed between all the air vents, the side window demisters, the windscreen demisters and the footwells.

- **Position** 

For improved efficiency, close the dashboard air vents.

All the air flow is directed to the windscreen demisters and the side window demisters.



HEATING - VENTILATION AND ISOLATING THE PASSENGER COMPARTMENT (continued)



Adjusting the air temperature

Move control **A**.

The further the control is positioned to the right, the higher the temperature.

Adjusting the amount of air supplied to the passenger compartment

Move control **E** from **0** to **4**.

Passenger compartment ventilation is by “blown air”. The ventilation fan determines how much air enters but vehicle speed has a slight effect on this.

The further the control is positioned to the right, the more air is blown into the passenger compartment.

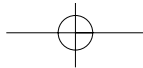

HEATING - VENTILATION AND ISOLATING THE PASSENGER COMPARTMENT (continued)

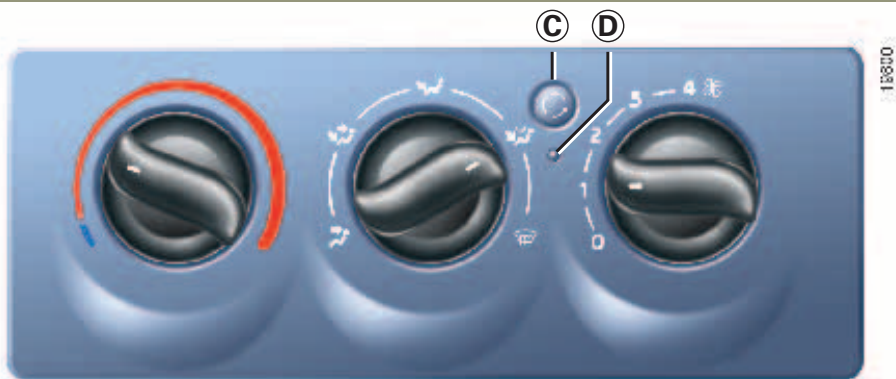

Isolating the passenger compartment

Button C

Normal operation of the system is obtained using external air.

The air recirculation position allows the passenger compartment to be isolated from the external atmosphere (driving in polluted areas...).

To enter the isolation mode, press button C .

This function allows the desired warmth of the passenger compartment to be achieved as quickly as possible.

This button switches the air recirculation system on or off. Warning light **D** comes on when the function is operational. In this position, air is taken from within the passenger compartment and is recycled without outside air entering.

Prolonged use of the isolation mode may cause odours due to the air not being renewed and may cause the windows to mist up.

Return to normal operation (external air) by pressing button **C** as soon as the polluted area is left behind.

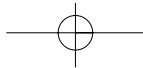

AIR CONDITIONING

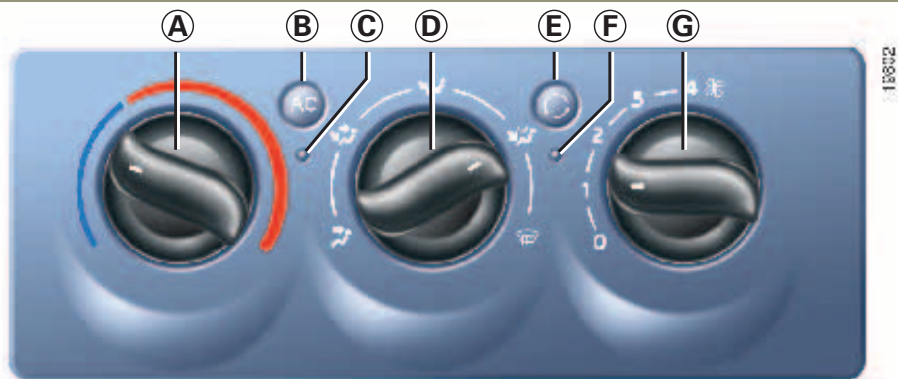

Controls

- A** Air temperature adjustment.
- B** Operating the air conditioning.
- C** Air conditioning operation indicator light.
- D** Air distribution control.
- E** Isolation of the passenger compartment (air recirculation).

- F** Air recirculation operation indicator light.
- G** Adjusting air volume output.

Adjusting the air temperature

Move control **A**.

To the right: maximum temperature possible

To the left: minimum temperature possible.

Adjusting the amount of air supplied to the passenger compartment

Move control **G** from **0** to **4**.

Passenger compartment ventilation is by "blown air". The ventilation fan determines how much air enters but vehicle speed has a slight effect on this.

The further the control is positioned to the right, the more air is blown into the passenger compartment.



AIR CONDITIONING (continued)

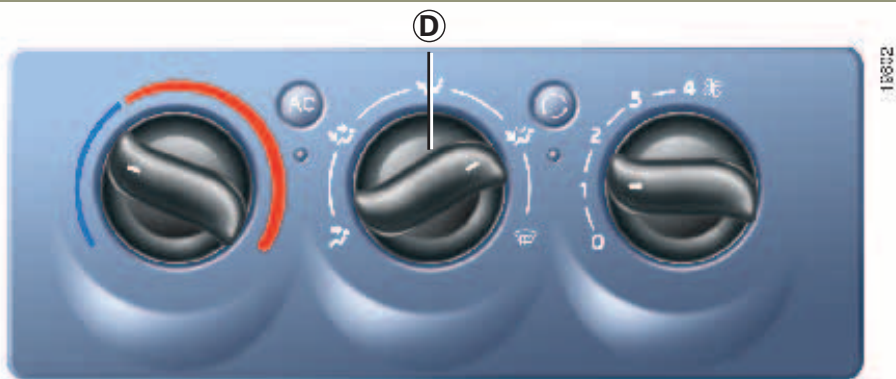

Distribution of air in the passenger compartment

Move control *D*.

• **Position**



The air flow is directed to the dashboard air vents only.

This selection is not appropriate if all the air vents are closed.

• **Position**



The air flow is directed to the dashboard air vents and the footwells.

• **Position**



The air flow is directed to the footwells.

• **Position**



The air flow is distributed between all the air vents, the side window demisters, the windscreen demisters and the footwells.

• **Position**



For improved efficiency, close the dashboard air vents.

All the air flow is directed to the windscreen demisters and the side window demisters.

In this position, simultaneous operation of the air conditioning system could make demisting more efficient.

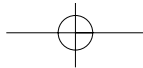

AIR CONDITIONING (continued)

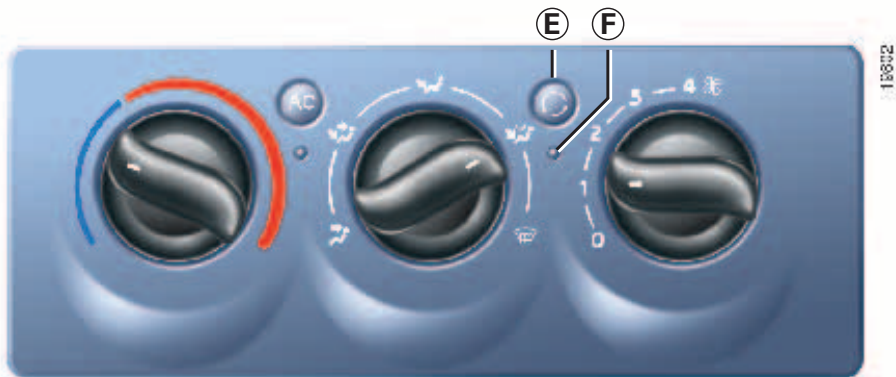

Isolating the passenger compartment



Button *E*

Normal operation of the system is obtained using external air.

The air recirculation position allows the passenger compartment to be isolated from the external atmosphere (driving in polluted areas, etc.).

To enter the isolation mode, press

button *E*



This function allows the desired warmth of the passenger compartment to be achieved as quickly as possible.

This button switches the air recirculation system on or off. Warning light *F* comes on when the function is operational. In this position, air is taken from within the passenger compartment and is recycled without outside air entering.

Prolonged use of the isolation mode may cause odours due to the air not being renewed and may cause the windows to mist up.

Return to normal operation (external air) by pressing button *D* as soon as the polluted area is left behind.

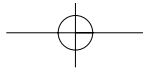

AIR CONDITIONING (continued)

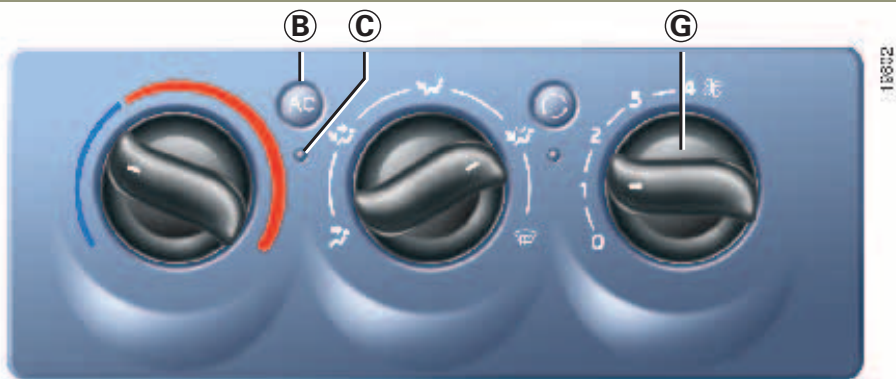

Air conditioning controls

A.C

Control **B** operates or stops the air conditioning system.

The air conditioning **will not operate** if control **G** is positioned on **0**.

Using the air conditioning system:

- lowers the internal passenger compartment temperature, especially in hot weather, when driving in traffic or when the vehicle has been parked in the sun;
- reduces the humidity of the air blown inside the passenger compartment (prevents misting).

Fuel consumption increases when the air conditioning system is being used. (Switch it off when it is not required.)

Note: the air conditioning may be used in all conditions, but does not operate when the external temperature is low.

- **Button B not activated (warning light C off)**

The air conditioning is not operational.

Heating and ventilation are therefore identical to that of a vehicle without air conditioning.

- **Button B activated (warning light C on)**

The air conditioning is operating.

Air is taken from outside the vehicle and is constantly renewed.



AIR CONDITIONING (continued)

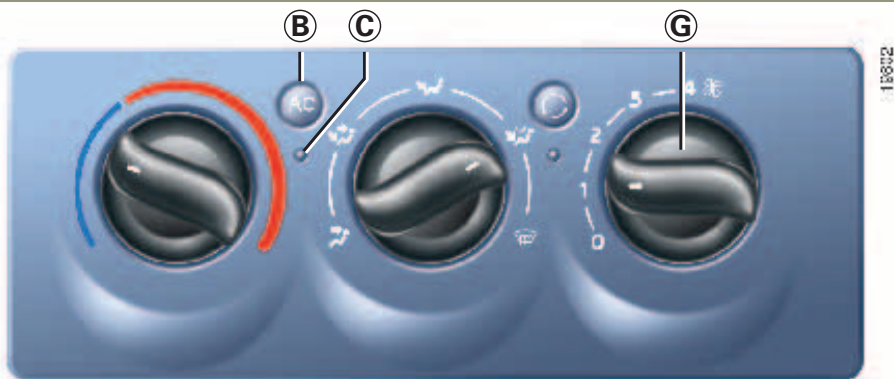

In very hot weather, or when the vehicle has been parked in the sun, open the doors for a few moments to allow the hot air to escape before starting off.

To lower the temperature of the passenger compartment as quickly as possible to the required level, use the “Isolation of the passenger compartment” function. Once the required comfort level has been reached, turn the recirculation function off.

When the air conditioning is operating, all the windows must be closed to give the best efficiency.

If there is an operating fault, contact your Renault Dealer.

No cool air

Check that the controls are correctly positioned and that the fuses are in good condition. If not, stop the air conditioning system (warning light **C** goes out) and call for the assistance of a Renault Dealer.

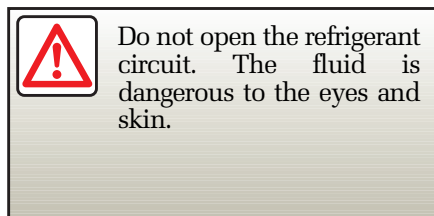

3.13

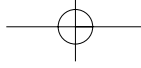

AUTOMATIC AIR CONDITIONING

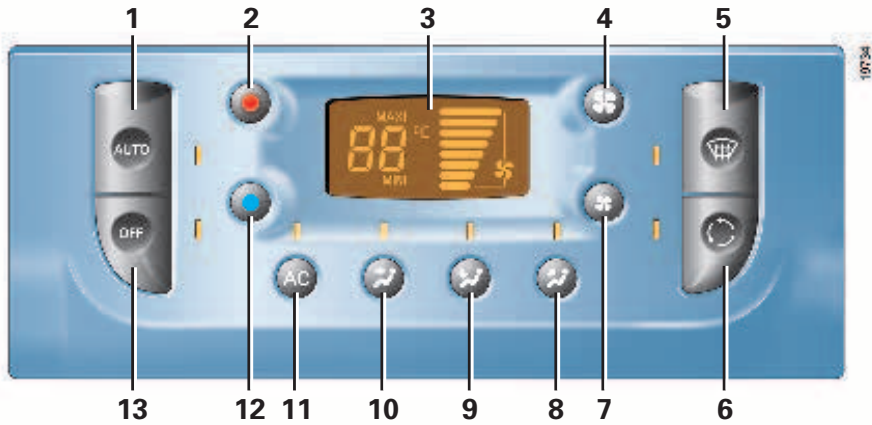

Controls

1 - automatic mode button

5 - automatic windscreen demister-de-icer button

2 and **12** - air temperature adjustment buttons

6 - air recirculation button

3 - display

8 to **10** - air distribution buttons

11 - air conditioning button

4 and **7** - ventilation speed adjustment buttons

13 - unit off button

All buttons except **2**, **4**, **7**, and **12** have associated indicator lights which light up when the function is being used and go out when the function is not in use.

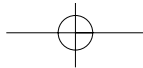

AUTOMATIC AIR CONDITIONING (continued)

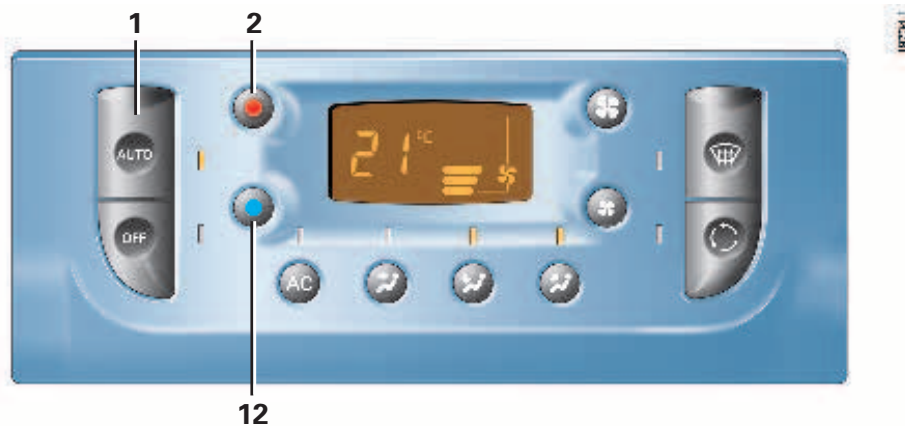

■ Air conditioning (automatic mode)

Automatic air conditioning is a system which will ensure that the temperature in the passenger compartment is maintained at a **comfortable level** (except in extreme conditions of use).

This system is equipped with a comfort level selector to provide in-car comfort whatever the weather.

Operation of the automatic mode

- Press button **1**; the indicator light comes on.
- Choose a comfort level between 16 and 26°C by pressing buttons **2** and **12**.

MAXI position: maximum air temperature,

MINI position: minimum air temperature.

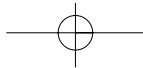

AUTOMATIC AIR CONDITIONING (continued)

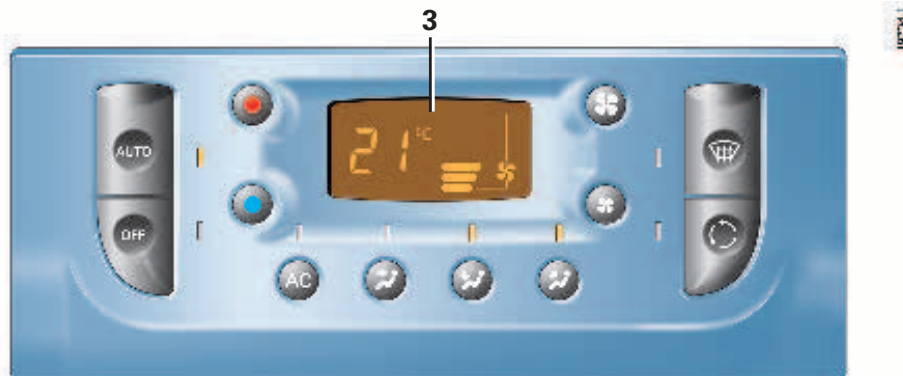

For optimum operation, we recommend that you leave the air vents open in all weathers.

Operation of the automatic mode (continued)

To reach and maintain the selected comfort level, the system acts upon:

- blower speed,
- air distribution,
- air recirculation management,
- air conditioning (on or off).

The indicator lights let you know what the system has selected.

The value on the display **3** indicates the comfort level.

When the vehicle is started in cold or hot weather, increasing or decreasing the values displayed does not mean that the comfort level is reached more quickly (the system optimises the temperature increase or decrease whatever the air temperature indicated).



AUTOMATIC AIR CONDITIONING (continued)



Press button **1** to return to automatic mode. Press button **5** again to switch off automatic windscreen demisting/de-icing mode.

■ Visibility (automatic de-icing - demisting)

Press button **5**  to operate windscreen de-icing/demisting by ventilation.

The indicator light comes on.

The AUTO indicator light goes out.

This system quickly demists and de-ices the windscreen and the front side windows. To improve efficiency, the air conditioning is automatically switched on at the same time (indicator light comes on).

The best possible flow of air is then directed towards the windscreen and front window air outlets.

You may wish to switch on the air conditioning once more if there are high levels of humidity.

In this case, the air conditioning will operate permanently, whatever mode is selected afterwards.

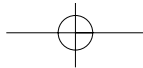

AUTOMATIC AIR CONDITIONING (continued)

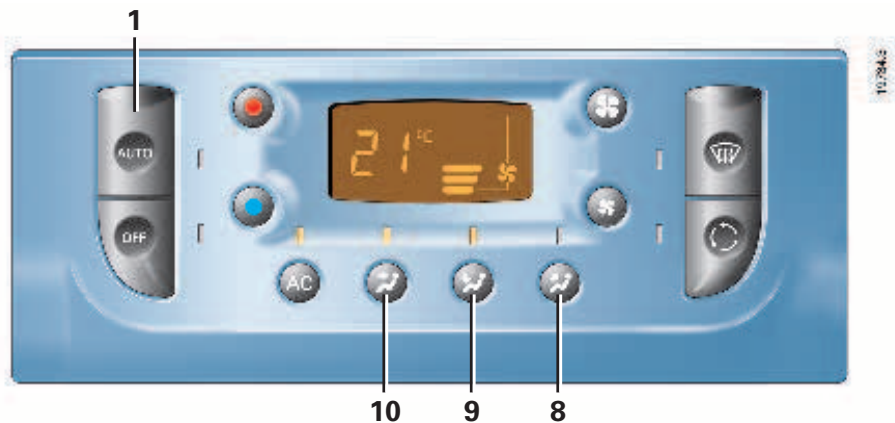

Button 9

The air is only directed to the feet of the front and rear passengers.

Button 10

The air flows mainly to the dashboard air vents.

Personalised operation

■ Selecting air distribution

The system normally operates in automatic mode but you can alter the standard settings used by the system (quantity of air, etc.).

Automatic mode is switched off by pressing one of the following buttons.

The indicator light on button 1 will go out.

Button 8

The air flow is directed to the demisting vents (for the windscreen and the side windows).

In personalised operation mode, you may choose no more than two air distribution selections at once (N.B.: buttons 8 and 10 cannot be selected together).

If you alter the automatic selection, the **AUTO** key 1 indicator light goes out, but **only** the function changed is no longer controlled by the automatic system.

To return to automatic mode, press the **AUTO** button.

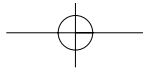

AUTOMATIC AIR CONDITIONING (continued)

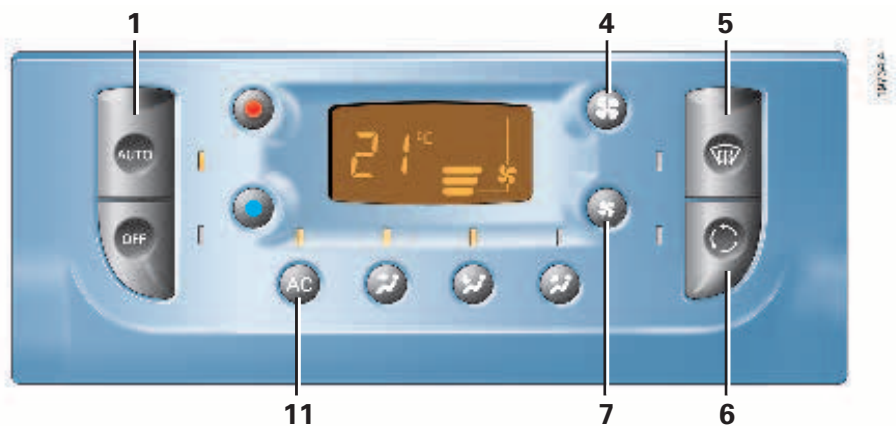

■ Switching the air conditioning on and off

In automatic mode, the system switches the air conditioning system on or off, depending on external weather conditions.

The automatic mode is switched off by pressing button **11**; the indicator light in button **1** will go out.

Button **11** allows you to switch the air conditioning system on or off.

N.B.: switching on the demisting/de-icing function (buttons **5** and **6**) automatically switches on the air conditioning.

■ Altering blower speed

In automatic mode, the system uses the most suitable amount of air to reach and maintain the desired temperature.

Press button **4** or **7** to switch off automatic mode.

The indicator light on button **1** will go out.

These buttons increase or decrease the amount of air blown into the passenger compartment.

In cold weather, the automatic air conditioning system will not start immediately at maximum power but will increase gradually until the engine temperature is warm enough to heat the passenger compartment air. This may take between 30 seconds and several minutes.



AUTOMATIC AIR CONDITIONING (continued)



6

Special instructions

Switching on air recirculation automatically switches on the air conditioning.

The function operates periodically if the external temperature is lower than approximately 10°C; the indicator light on button **6** will go out after a few minutes.

The function operates permanently if the external temperature is above approximately 10°C; press button **6** to switch off.

■ Using recirculated air



Press button **6**; the indicator light will come on.

In this position the air is taken from inside the passenger compartment and is recirculated without admitting external air.

Recirculation of air allows the external atmosphere to be isolated (driving in polluted areas).

Prolonged use of the air recirculation mode may cause the windows to mist up or lead to odours, as the air is not renewed.

We therefore advise you to return to normal mode (external air) by pressing button **6** as soon as air recirculation is no longer required.



AUTOMATIC AIR CONDITIONING (continued)

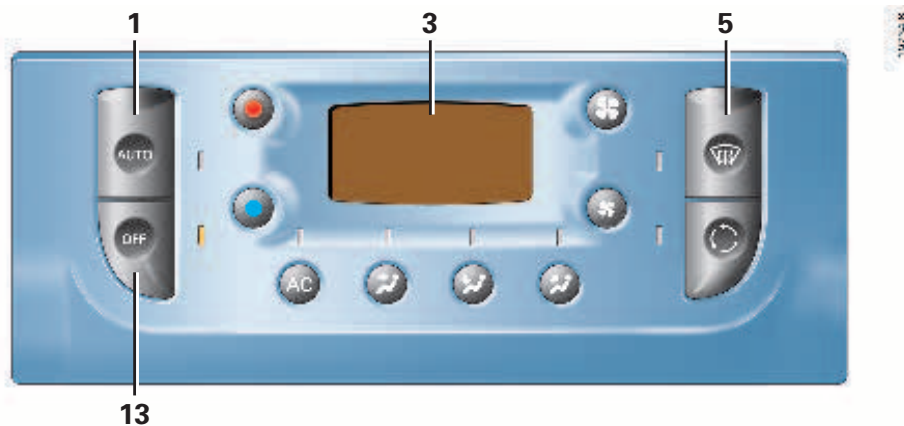

■ Switching the system off

Press button **13** **OFF**

The indicator light comes on. No more information appears on the display **3**. The system is switched off.

The **OFF** button isolates the passenger compartment from the outside atmosphere.

Press buttons **1** or **5** to return to automatic mode.

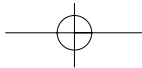

AIR CONDITIONING

If no cool air is produced

Check that the controls are set correctly and that the fuses are in good condition. Otherwise switch off the air conditioning and contact a RENAULT Dealer.

Do not open the refrigerant fluid circuit.

Fuel consumption

When the air conditioning is operating, it is normal to notice an increase in fuel consumption (especially when driving in town).

In winter, use the air conditioning occasionally in order to keep the system in correct working order.

Do not worry about any water which may appear from underneath the vehicle as this results from condensation.

Operating faults

Generally, if you notice a decrease in the efficiency of de-icing, demisting or air conditioning, it may be caused by clogging up of the particle filter cartridge, if one is fitted to the vehicle: consult your RENAULT Dealer.

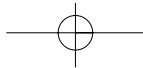

INTERIOR LIGHTING

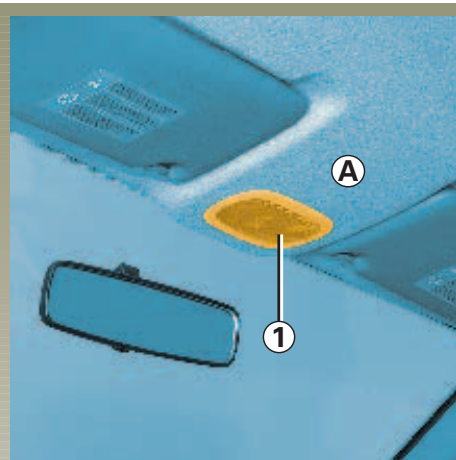

Light A

Tilt light **1** to give:

- continuous lighting,
- lighting controlled, depending on version, by the opening of one of the front doors, or by one of the four doors. It only extinguishes when the doors concerned are correctly closed.

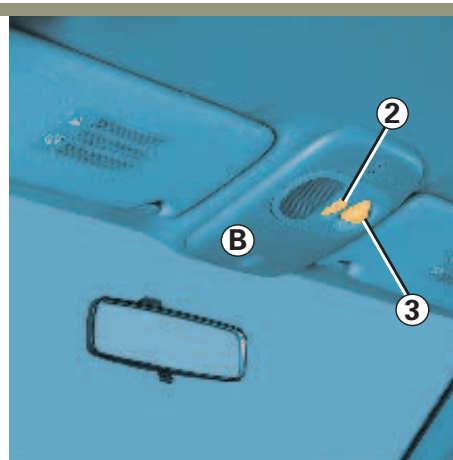

Light B

Tilt switch **2** to give:

- Continuous lighting.
- Lighting controlled, depending on version, by opening one of the front doors, or by one of the four doors. It only extinguishes when the doors concerned are correctly closed.
- Lighting off.
- Lighting up of map reading light **3**.

Adjust map reading light **3** to the required position.

Automatic operation of interior lighting (depending on the vehicle)

- If the doors are unlocked using the flip remote control, the interior lights are switched on for approximately 15 seconds.
- If the doors are locked using the flip remote control, the lights are switched off immediately.
- If the door is open (or not properly closed), the lights are switched on for a period of approximately 15 minutes.
- If all the doors are closed, the interior lights start to dim when the ignition is switched on.



INTERIOR LIGHTING (continued)

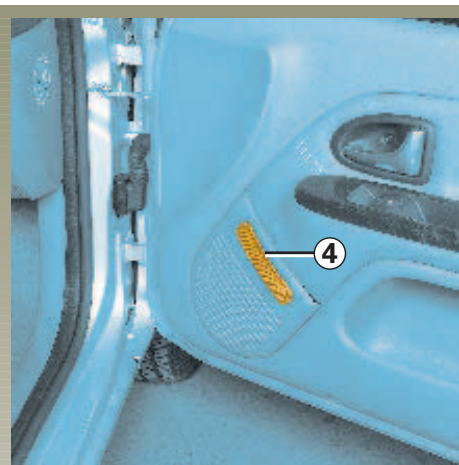

Front door lights 4

They operate in a similar way to the other lights.

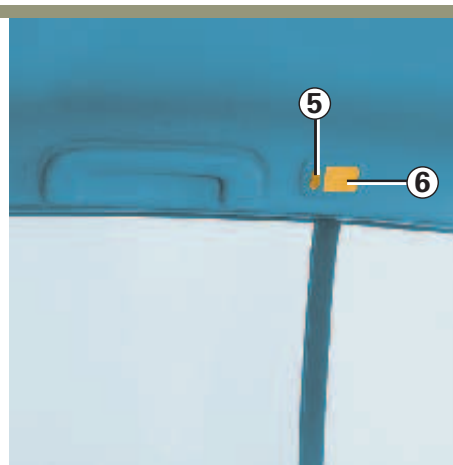

Rear lights 6

Tilt switch 5 to give:

- Continuous lighting.
- Lighting controlled by the opening of one of the four doors. It only goes out when the doors concerned are correctly closed.
- No lighting.

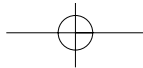

WINDOW RISERS

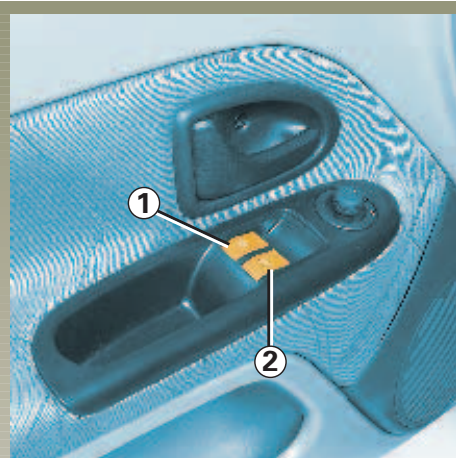

Front driver's side electric window

With the ignition on or off and the driver's door closed:

Press switch **1** to open the window or lift switch **1** to close it.

Front passenger's side electric window

With the ignition on, press switch **2** to open the window or lift switch **2** to close it.

Automatic operation

This is in addition to the driver's window operation described above.

When the engine is running, briefly pressing switch **1** allows the window to be fully closed or opened.

Any action on switch **1** during this operation will stop the window moving.

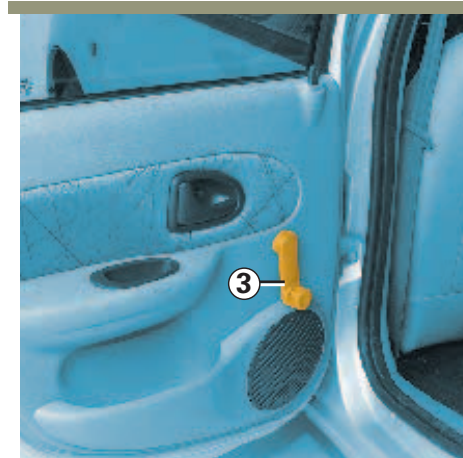

Manual window risers

Operate window winder **3**.



Child safety
Never leave the key in the ignition when there is a child in the car (or an animal). It would be possible to operate the electric windows and there is a risk that the child could trap a part of his/her body in the window (neck, arm, hand, etc.), causing serious injury.

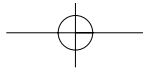

SUN VISOR

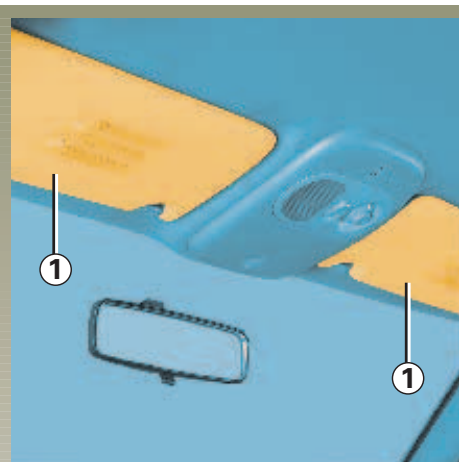

Front sun visor
Lower the sun visor **1**.

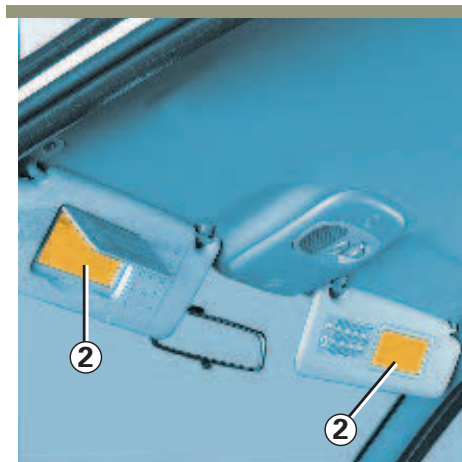

Vanity mirrors 2
Special feature on driver's side:
A vanity mirror in the sun visor has a cover.

WINDSCREEN

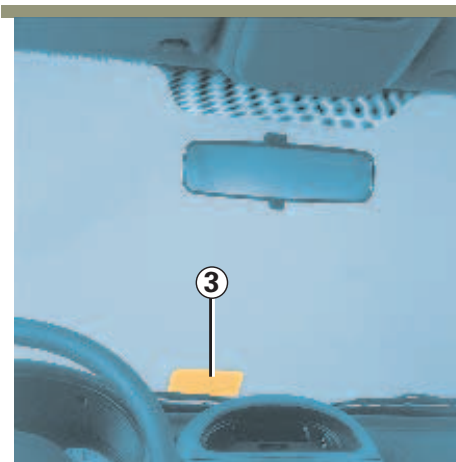

Windscreen with reflective layers
This windscreen reflects the sun and, in particular, limits the infrared rays entering the passenger compartment.
An area **3** is suitable for affixing passes to the windscreen (e.g. motorway permits, car park season tickets, etc.).



MANUAL SUNROOF

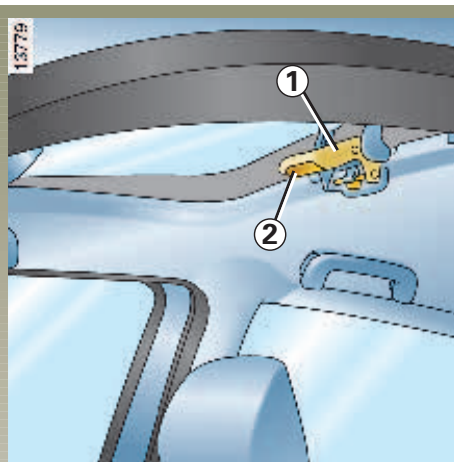

Opening

To the first stage

Tilt handle **1** forwards until it locks.

To the second stage

Press lever **2** and simultaneously tilt handle **1** until the mechanism locks again.

Closing

Keep lever **2** depressed and return handle **1** to its original position.

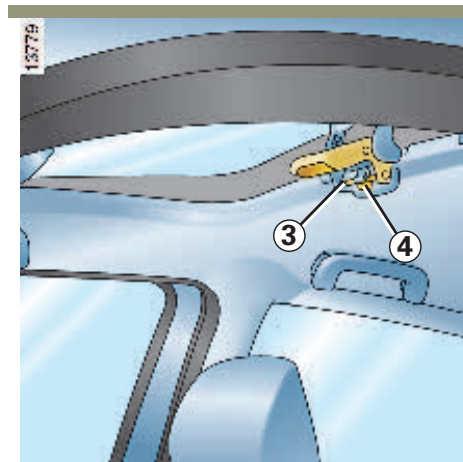

Removal

Open the sunroof to the first stage.

Press button **4** (if necessary, using a tool such as a flat screwdriver) to release the pin **3** from handle **1**: the pin should be freed.

Lift the sunroof glass almost vertically and release it from its hinges.

Refitting

Refitting is the reverse of removal.

Ensure pin **3** is correctly locked in position.

- Check that the sunroof is correctly closed before leaving the vehicle.
- Clean the seal every three months using products provided by our Technical Department



ELECTRIC SUNROOF

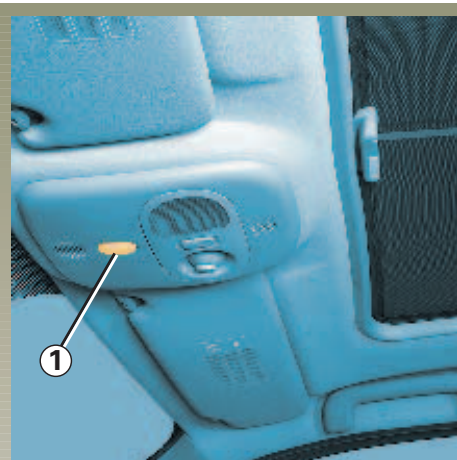

To slide the sunroof

Tilted sunroof,

- Opening: tilt the switch **1** towards the rear and keep it depressed until the required tilt angle is obtained.
- Closing: tilt the switch **1** towards the front.

To tilt the sunroof

With the ignition on:

- Opening: tilt the switch **1** towards the rear and keep it depressed until the required tilt angle is obtained.
- Closing: tilt the switch **1** towards the front.



Child safety

Never leave the key in the ignition when there is a child in the car (or an animal). It would be possible to operate the sunroof and there is a risk that the child could trap a part of his/her body in the sunroof (neck, arm, hand, etc.), causing serious injury.

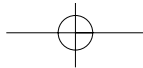

ELECTRIC SUNROOF (continued)



Sunroof screen

Slide it using handle 2.

To keep the screen closed, the hook must be secured into the sunroof frame.

- Check that the sunroof is correctly closed before leaving the vehicle.
- Clean the seal every three months using products provided by our Technical Department.
- Do not open the sunroof immediately after a rain shower or after washing your vehicle.

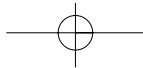

STORAGE COMPARTMENTS

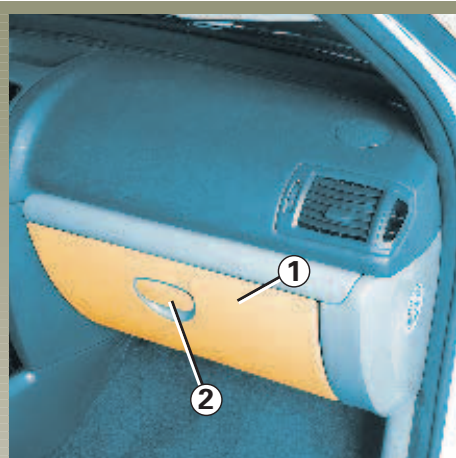

Passenger side glove box 1

To open, lift handle 2. The box contains a sunglasses holder, a pen holder and space for credit cards.

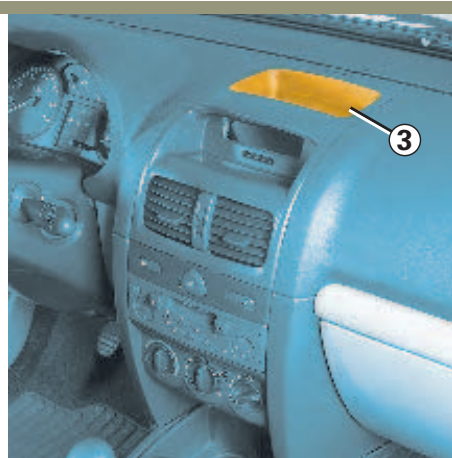

Centre console storage compartment 3



Driver's storage compartment 4



No objects should be placed on the floor (area in front of driver) as such objects may slide under the pedal during braking manoeuvres, thus obstructing its use.

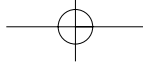

STORAGE COMPARTMENTS (continued)

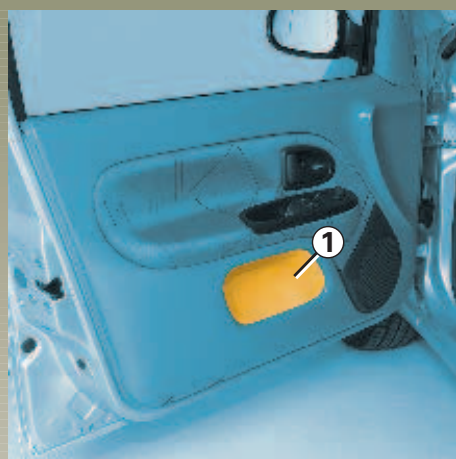

Door storage compartments 1



Rear compartments 2

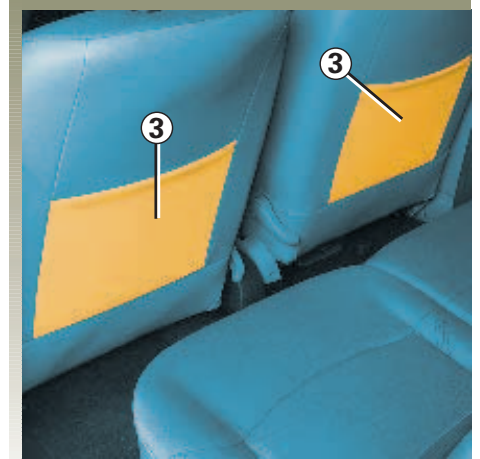

Front seat document pouches 3



Storage compartment under passenger seat 4

3.31

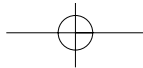

ASHTRAYS - CIGAR LIGHTER

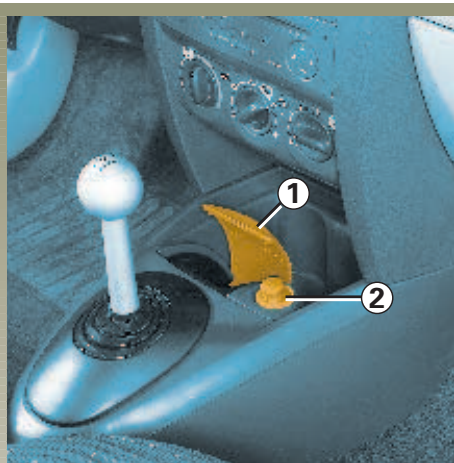

Ashtray

To open, lift cover **1**.

To empty the ashtray, pull the assembly towards you and it will be released from its housing.

Cigar lighter

Ignition on, press in the cigar lighter **2**.

It will click out by itself as soon as it is ready. Pull it out to use it. After use, replace it without pushing it all the way in.



REAR BENCH SEAT (operation)

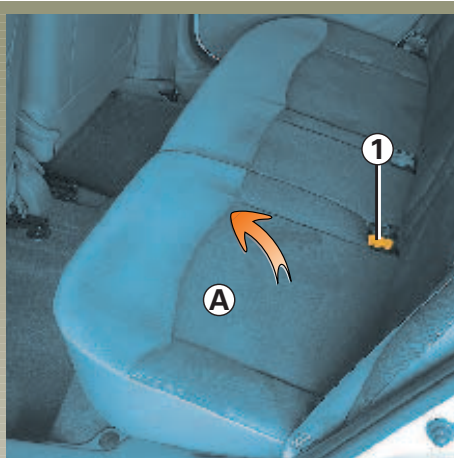

The seat base and the seatback may be folded down (in one or two sections) to allow bulky objects to be carried

To fold down the seat base

Lift seat base **A**, against the front seats.

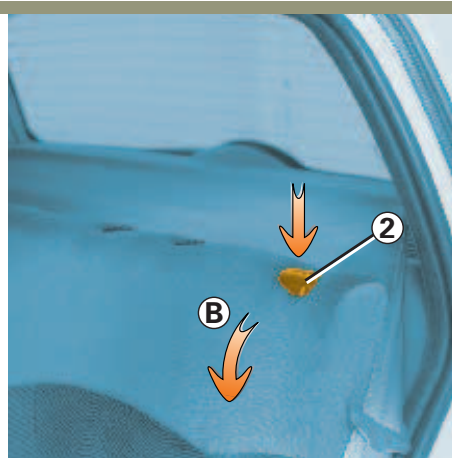

To fold down the seatback

Remove the rear head restraints (if they are fitted to the vehicle). Press button **2** and lower the seatback **B**.

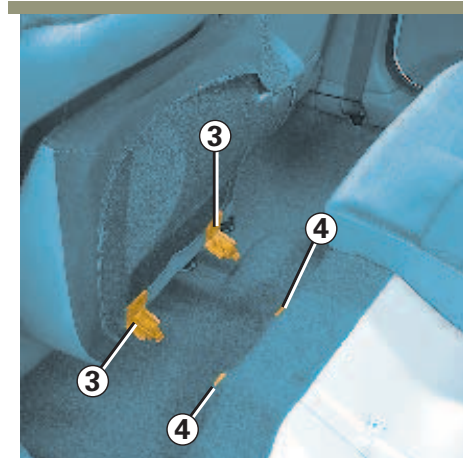

Removing the seat base

Lift the seat base to remove brackets **3** from their housing **4**.

To refit the seat base, carry out the operations in reverse order to removal. **Ensure the seat base is correctly secured.**



- **When refitting the seatback**, ensure it is correctly locked at the top. If seat covers are being used, check that they are not preventing the seatback locking mechanism from operating correctly.
 - **When moving the bench seat**, check that the seat belt housings **1** are correctly positioned before folding down the seat base.
- Once the bench seat is in place again, ensure the seat belts are correctly repositioned.



LUGGAGE COMPARTMENT

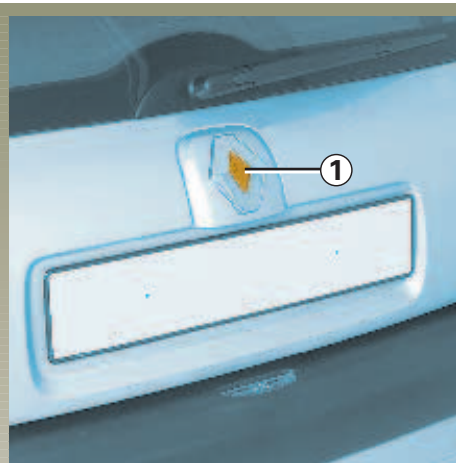

To open

Press button **1** and lift the tailgate.

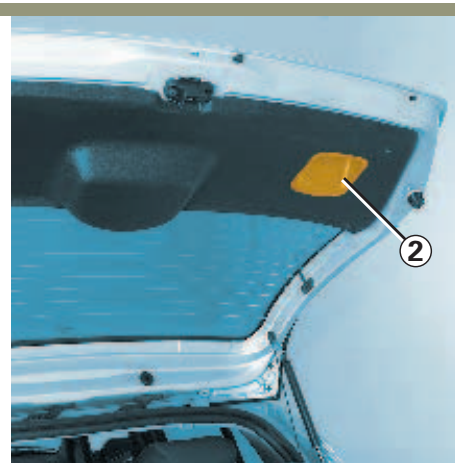

To close:

Lower the tailgate using handle **2** inside the tailgate to help you.

When the tailgate has been lowered to shoulder height, release handle **2** and finish closing the tailgate by pressing down on the tailgate from the outside.



LUGGAGE COMPARTMENT (continued)

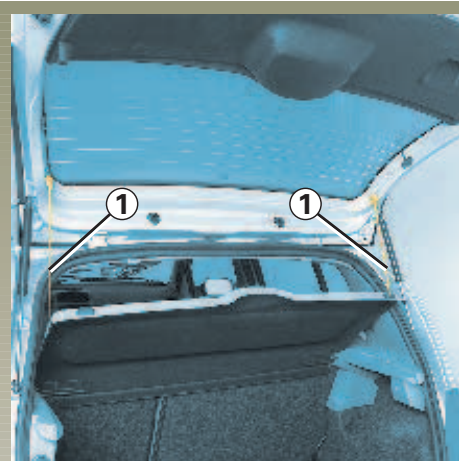

Rear shelf

To remove, release the two return cords **1**.



Gently lift the shelf and pull it towards you.

Refitting is the reverse of removal.

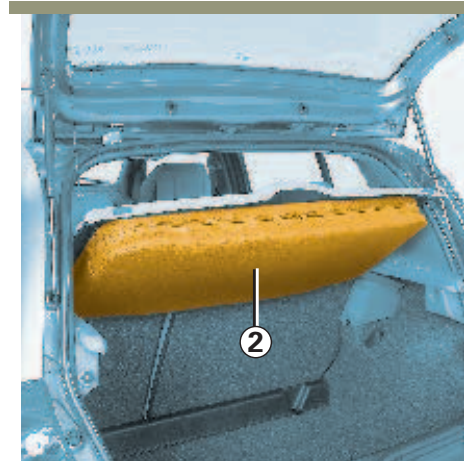

Built-in garment case 2

This is located under the rear parcel shelf and is closed by a zip fastener. It can be used to store clothes.



Do not place any objects, in particular heavy or hard objects, on the rear parcel shelf. These may pose a risk to the vehicle occupants if the driver has to brake suddenly or if the vehicle is involved in an accident.



The total weight of luggage placed in the built-in garment case must not exceed 5 kg (11 lbs).

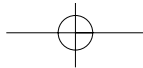

LUGGAGE COVER



The luggage cover consists of three solid sections.

It can be used in one of three ways:

- In the unfolded position.



- In the half-folded position.



- Removed entirely.

To remove the luggage cover, place it in the half-folded position, take hold of the end and pull it towards you.



Do not place any objects, in particular heavy or hard objects, on the luggage compartment cover. These may pose a risk to the vehicle occupants if the driver has to brake suddenly or if the vehicle is involved in an accident.

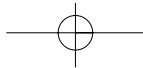

TRANSPORTING OBJECTS IN THE LUGGAGE COMPARTMENT

Always place objects carried in the luggage compartment so that their largest dimension is against:

- the back of the rear bench seat, for normal loading.



- the folded down seat, for maximum loading.



Always put the heaviest items directly onto the floor. When the vehicle is fitted with them, use the lashing points located on the floor at the rear to secure transported items. Luggage should be loaded in such a way that no item will be thrown forward and strike the occupants if the driver has to brake suddenly. Fasten the rear seat belts, even if the seats are not occupied.

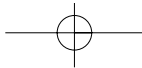

3.38

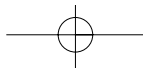

Section 4: Maintenance



Bonnet	4.02
Engine oil level	4.03 → 4.07
Oil changes: Engine	4.07
Levels: Brake fluid	4.08
Coolant	4.09
Power steering pump	4.10
Battery	4.10
Screen washer reservoir	4.11
Filters	4.11
Bodywork maintenance	4.12 - 4.13
Interior trim maintenance	4.14
	4.01

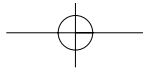

BONNET

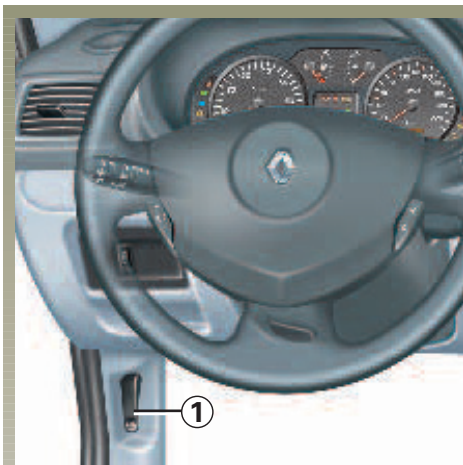

Opening the bonnet

To open, pull handle **1**.

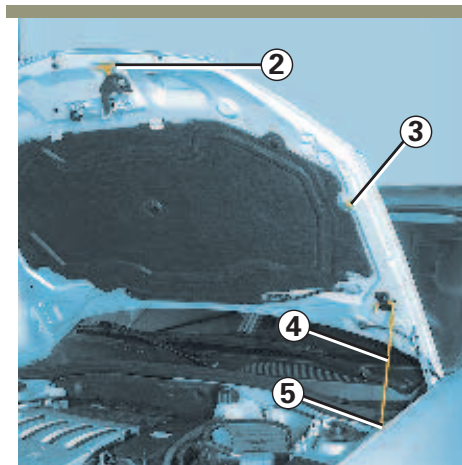

Bonnet safety lock

To unlock, lift lever **2**.

Lift the bonnet, release the strut **4** from its mounting **3**. For your safety, this **must** be placed in location **5**.

Closing the bonnet

To close the bonnet, replace strut **4** in its mounting **3**, hold the bonnet in the middle and lower it to 20 cm above the closed position. Now release it and it will lock under its own weight.

Check that the bonnet is correctly locked.

Check that nothing has been left in the engine compartment before closing the bonnet.

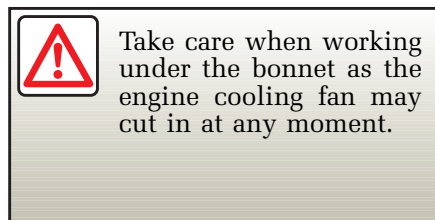
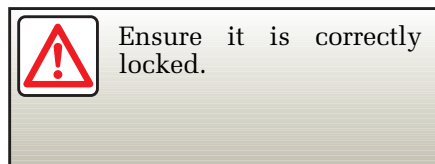

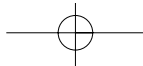

ENGINE OIL LEVEL

An engine uses oil for lubrication and to cool moving parts and it is sometimes necessary to top up the level between oil changes.

However, consult your Renault Dealer if more than 0.5 litre is being consumed every 625 miles (1000 km) after the running-in period.

Oil change frequency: Check the oil level from time to time and always before long journeys, to avoid the risk of damaging your engine.

Reading the oil level

The car must be parked on level ground and the engine should have been switched off for some time beforehand to obtain an accurate reading.

The oil level can be read:

- on the instrument panel;
- using the dipstick.



Message 1
Level
satisfactory

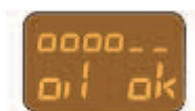

Message 2
Level
display
function



Message 3
Minimum
level
(flashing)

Reading the level on the instrument panel

When ignition has been switched on for approximately 30 seconds:

- **if the level is correct**, the display will show "oil OK": display message **1**

Special note: To gain a more precise indication of the level, press the trip mileage counter reset button or the information scroll button on the on-board computer.

The squares which appear on the display indicate the level. The number of squares displayed decreases as the oil level drops and they are replaced by a dash: display message **2**.

To move to on-board computer reading, press the button again.

- **When the minimum oil level is reached**, the dashes and the word "Oil" flash, and the word "OK" disappears (display message **3**)

and **SERV** some versions lights up on the instrument panel.

It is vital to top up the oil as soon as possible.



ENGINE OIL LEVEL (continued)

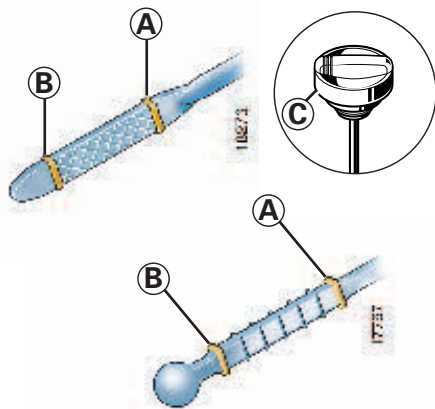

Consult your Renault Dealer at once if you notice an abnormal or repeated drop in any of the fluid levels.

Reading the level using the dipstick

- Take out the dipstick.
- Wipe the dipstick using a clean, lint-free cloth.
- Push the dipstick in as far as it will go. (For vehicles equipped with a cap-type dipstick **C**, screw the cap in as far as it will go.)
- Take out the dipstick again.
- Read the level. It should never fall below the minimum mark **B** or exceed the maximum mark **A**.



Take care when working under the bonnet as the engine cooling fan may cut in at any moment.

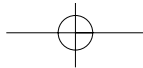

ENGINE OIL LEVEL (continued)

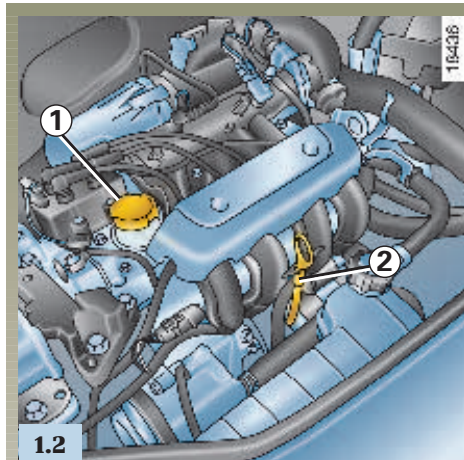

Topping up/filling

The vehicle must be parked on level ground and the engine should be cold (for instance, before the engine is started up for the first time in the day).

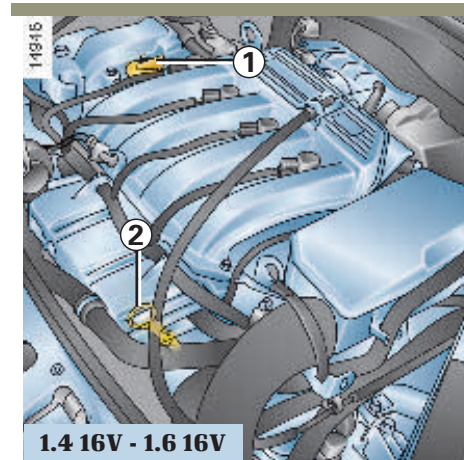
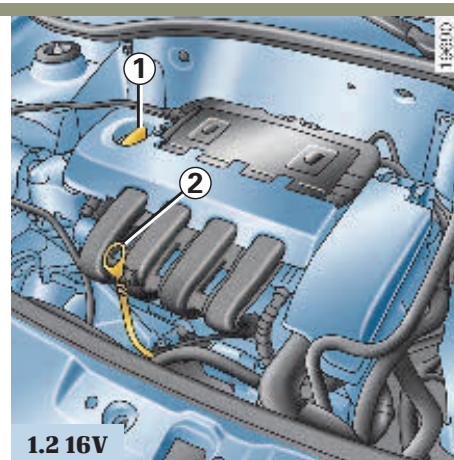

- Unscrew filler cap **1**.
- Top up the level. (For information, the capacity between the minimum and maximum reading on dipstick **2** is between 1.5 and 2 litres depending on the engine.)
- Wait for approx. two minutes to allow the oil to flow into the engine.
- Check the level using dipstick **2** (as explained above).

Do not exceed the **max.** level and do not forget to refit cap **1**.

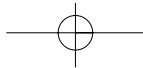

ENGINE OIL LEVEL (continued)

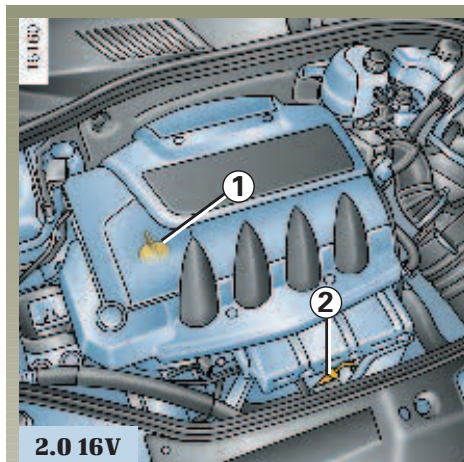

Special features on engine 2.0 16V
Cap **1** is located underneath a filler flap.

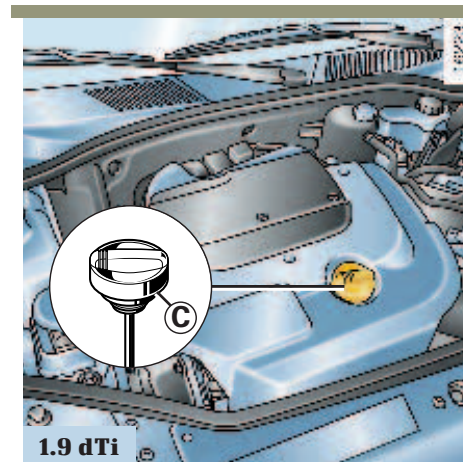
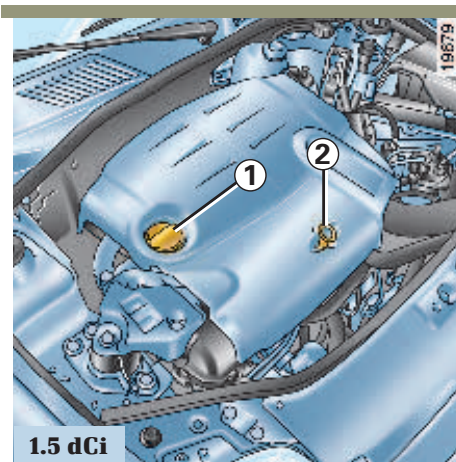



ENGINE OIL LEVEL (continued) / OIL CHANGE

Oil change

Oil change frequency: Refer to the Servicing booklet for your vehicle.

Change the oil more often if the vehicle is subject to severe use.

Average capacities of oil change (for information)

1.2 l - 1.2 l 16V engines:	4.0 litres
1.4 litre 16 V engines:	4.9 litres
1.6 litre 16V engines:	4.9 litres
2.0 16V engines:	4.75 litres
1.5 litre dCi engine:	5.0 litres
1.9 l dTi engine:	5.5 litres

Oil filter included.

The oil filter should be replaced periodically: consult the Servicing booklet for your vehicle.

Engine oil grade

To find out which grade of oil to use, see the Servicing booklet for your vehicle.



Filling: Take care when topping up the oil that no oil drips onto engine components: there is a risk of fire. Do not forget to refit the cap securely as there is a risk of fire if oil splashes onto hot engine components.



Engine oil change: If you change the oil when the engine is hot, be careful to avoid scalding yourself as the oil flows out.



Never run the engine in an enclosed space as exhaust fumes are poisonous.



Take care when working under the bonnet as the engine cooling fan may cut in at any moment.

Consult your Renault Dealer at once if you notice an abnormal or repeated drop in any of the fluid levels.

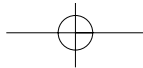

LEVELS

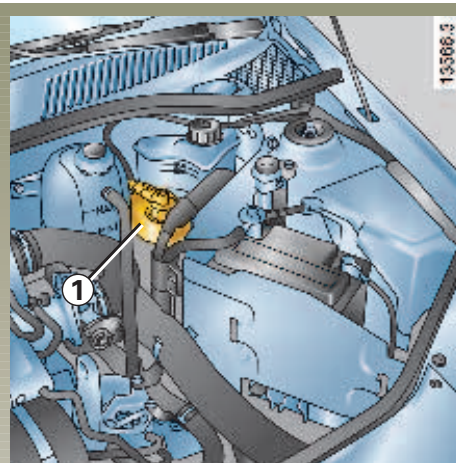

Brake fluid

This must be checked frequently, especially if you notice even the slightest loss in braking efficiency.

Level 1

The level falls naturally as the brake pads wear, but it should never be allowed to fall below the **MINIMUM** warning mark.

Topping up

After any operation on the hydraulic circuit, a specialist must replace the brake fluid.

Only use fluids approved by RENAULT's Technical Department and which have been taken from a sealed container.

Fluid change frequency: Refer to the servicing booklet for your vehicle.



Take care when working under the bonnet as the engine cooling fan may cut in at any moment.



LEVELS (continued)

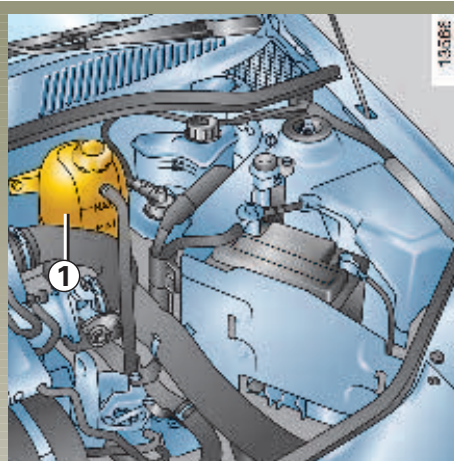

Coolant

The level **when cold** should be between the MINIMUM and MAXIMUM marks on the expansion bottle **1**.

Top up the level **when cold** before it reaches the MINIMUM mark.



No operations may be carried out on the cooling circuit when the engine is hot.

Danger of burns.

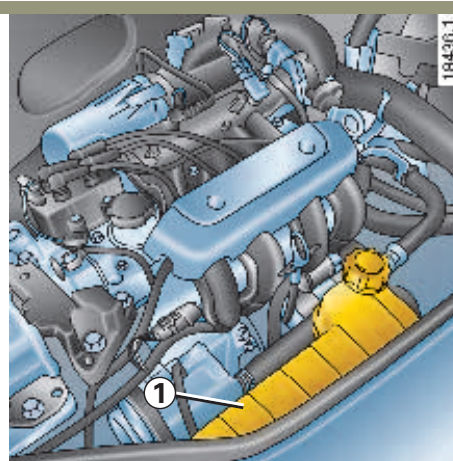

Frequency for checking coolant level

Check the coolant level regularly (very severe damage is likely to be caused to the engine if it runs out of coolant).

If topping up is required, only use products approved by RENAULT's Technical Department:

- Anti-freeze protection;
- Anti-corrosion protection of the cooling system.

Coolant replacement intervals

Refer to your vehicle's Servicing booklet.

If there is an abnormal drop in the coolant level or if coolant loss is repeated, consult your RENAULT Dealer.



LEVELS (continued)

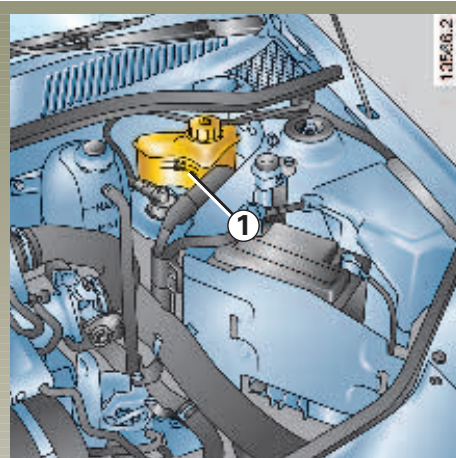

Power assisted steering pump

Frequency of changing: refer to the Servicing booklet for your vehicle.

Level: The correct level when cold should be:

- visible between the **Min** and **Max** marks on reservoir **1**.

For topping up or refilling with oil, use products approved by RENAULT's Technical Department.

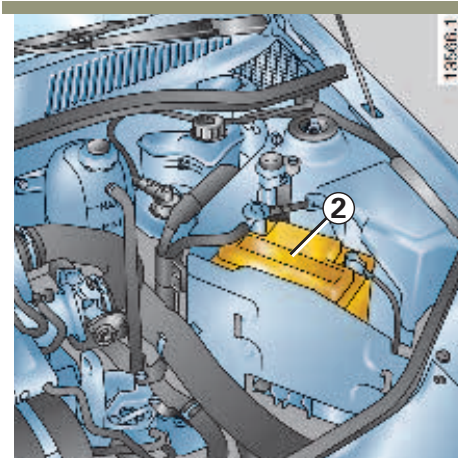

Battery

The battery does not require any maintenance. Never open cover **2**.



Take care when working in the engine compartment as the engine cooling fan may cut in at any moment without warning.



Handle the battery with care as it contains sulphuric acid which must not come into contact with the eyes or skin. If it does, rinse with plenty of water. Keep all sources of flame, heat and sparks away from the battery as there is a risk of explosion.



LEVELS (continued)

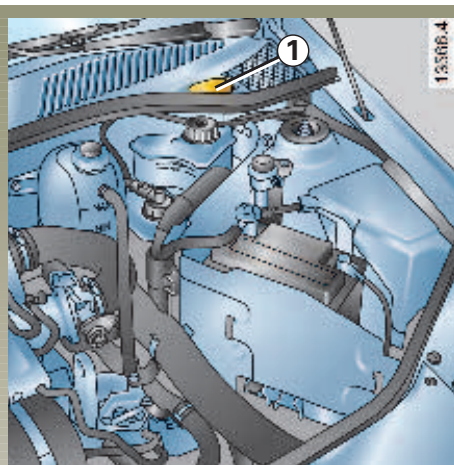

Windscreen washer reservoir

Filling: via plug **1**.

This reservoir also supplies the headlight washers (if fitted to the vehicle).

Liquid: water + washer product (antifreeze product in winter).

Jets: tilt each small sphere with a pin to alter the angle of the spray.

FILTERS

The replacement of filter elements (air filter, passenger compartment filter, diesel filter, etc.) is anticipated in the maintenance operations for your vehicle.

Frequency for replacing filter components: see the Servicing booklet for your vehicle.

If there is an abnormal drop in any of the fluid levels, consult your Renault Dealer at once.

 Take care when working under the bonnet as the engine cooling fan may cut in at any moment.

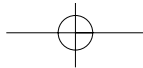

BODYWORK MAINTENANCE

Protection against the action of corrosive agents

Although your vehicle has been treated with very effective anti-corrosion products, it is still subject to the action of:

- **corrosives in the atmosphere**

- atmospheric pollution (urban and industrial areas),
- saline atmosphere (near the sea, particularly in hot weather),
- seasonal and humid climatic conditions, especially road salt in winter.

- **abrasives**

- wind-carried dust and sand, mud, road grit thrown up by other vehicles.

- **minor impacts**

To avoid losing the benefits of this protection, a minimum number of precautions should be taken to ensure against this risk.

What you must not do

- Wash the vehicle in bright sunlight or in freezing temperatures.
 - Scrape off mud or dirt without pre-wetting.
 - Allow external dirt to accumulate.
 - Allow rust to form after minor impacts.
 - Use solvents not recommended by Renault's Technical Department to remove spots as they may damage the paintwork.
 - Drive frequently in snow or muddy conditions without periodically washing the car, particularly under the wheel arches and under the body.
- Degrease or clean mechanical components (e.g. engine compartment), underneath the bodywork, parts with hinges (e.g. inside the fuel tank flap, sunroof) and painted plastic external fittings (e.g. bumpers) using high pressure cleaning apparatus or spraying on products which are not approved by our Technical Department as this could give rise to corrosion or incorrect operation.

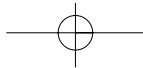

BODYWORK MAINTENANCE (continued)

What you should do

- Wash your car frequently, using our recommended cleaning products and use a high pressure jet to rinse off the wheel arches and under the body to get rid of:
 - spots of tree resin and industrial grime;
 - **bird droppings**, which contain chemicals which **rapidly discolour paintwork and may even cause the paint to peel off**; The vehicle **must** be washed immediately to remove these marks since they cannot be removed by polishing;
 - salt from the wheel arches and under the body, after the vehicle has been driven in areas where the roads are chemically treated;
 - mud forming damp patches in the wheel arches and under the body.
- Keep well away from the vehicle in front when driving on a freshly laid surface to avoid damage to your paintwork.
- Have patches where the paint has been damaged repaired quickly to avoid corrosion spreading.
- If your vehicle is covered by the Renault anti-corrosion warranty, remember to visit the bodyshop periodically. Refer to your vehicle's Warranty and Servicing booklet.
- Respect local regulations relating to washing your vehicle (e.g. do not wash your vehicle on a public highway).
- Before using a revolving brush type car wash, check the mounting of exterior equipment, additional headlights and rear view mirrors. Secure the wiper blades and radio aerial with adhesive tape.
Remove the car phone aerial if the vehicle has one.
- If mechanical components such as hinges have to be cleaned, their protection must be reapplied by spraying on products approved by Renault's Technical Department.

We have selected special products to care for your vehicle which may be obtained from Renault Accessory Outlets.



MAINTAINING INTERIOR TRIM

Do

Whatever type of stain is on the trim, use soapy water (if necessary, with warm water) based on:

- natural soap,
- washing up liquid (with one part washing up liquid to 200 parts water).

Rinse off with a soft, damp cloth.

Special instructions

- **Glass instrument panel** (e.g.: instrument panel, clock, exterior temperature display, radio display, etc...).

Use a soft cloth (or cotton wool).

If this does not clean them properly, use a soft cloth or cotton wool slightly moistened with soapy water and then wipe clean with a soft damp cloth.

Finally, dry off **carefully** with a soft dry cloth.

Cleaning products containing alcohol may not be used under any circumstances.

- **Seat belts**

These must be kept clean.

Use products selected by our Technical Department or warm soapy water using a sponge and dry off with a dry cloth.

Do not use cleaning agents or dyes.

Do not

You are strongly recommended not to use high pressure or atomising cleaning equipment inside the passenger compartment: unless carefully used, such equipment could interfere with correct operation of the electrical or electronic components in the vehicle, amongst other effects.

We have selected special products to care for your vehicle and you can obtain these from Renault accessory outlets.

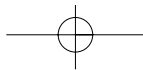

Section 5: Practical advice

Emergency spare wheel	5.02
Toolkit (Jack - Wheelbrace - Tyre levers etc.)	5.03
Hubcaps - Wheels	5.04
Changing a wheel	5.05
Tyres (tyre safety, wheels, winter use)	5.06 → 5.08
Wiper blades	5.09
Changing the bulbs	5.10 → 5.18
Headlights	5.10 → 5.12
Front fog lights	5.13
Rear lights	5.14 - 5.15
Side-mounted repeaters	5.16
Interior lights	5.17 - 5.18
Battery	5.19 - 5.20
Remote control door locking (changing the batteries)	5.21
Fuses	5.22 - 5.23
Towing (breakdown - attachments)	5.24 → 5.26
Fitting a radio/accessories	5.27 - 5.28
Operating incidents	5.29 → 5.34
	5.01

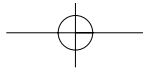

EMERGENCY SPARE WHEEL

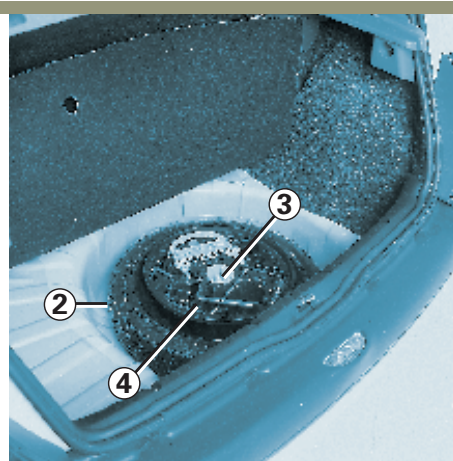

Emergency spare wheel 2

This is located in the luggage compartment.

To reach the emergency spare wheel:

- Open the tailgate.
- Lift the luggage compartment carpet using circular cut-out 1.

- Slacken central fastener 3.
- Remove the tool kit 4.
- Release the emergency spare wheel 2.



If the spare wheel has been stored for several years, have it checked by your Dealer to ensure that it is safe to use.



TOOL KIT

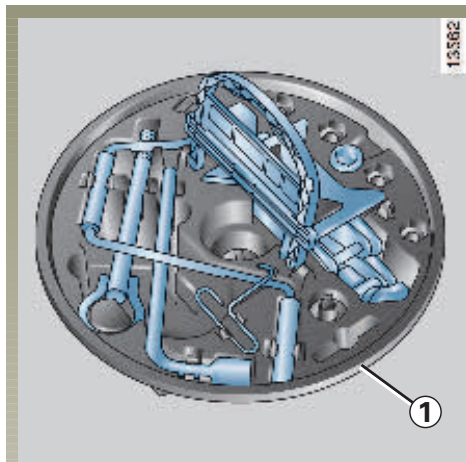

The tool kit **1** is located on the emergency spare wheel. It consists of a set of tools for various operations on the vehicle: jack, wheelbrace, towing hitch, etc. and a space for a bulb unit.

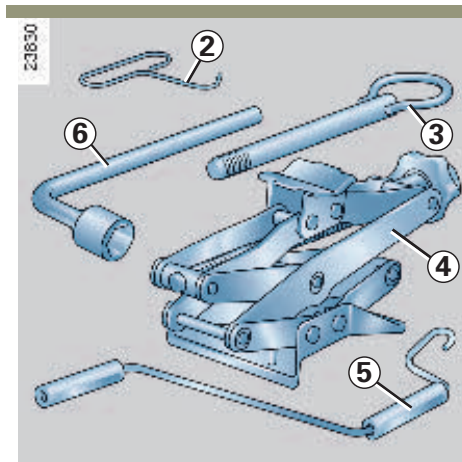

Wheelbrace **5**

Jack **4**

When replacing the jack, fold it down completely before putting it back into position.



The jack is designed for changing a wheel. Under no circumstances should it be used for carrying out repairs or to gain access under the vehicle.

Hubcap spanner **2**

This is used to unclip the hubcaps.

Wheel spanner **6**

This is used to lock or release the wheel bolts.

Towing ring **3**

Refer to the Towing section in section 5 for information on using the towing ring.



WHEEL HUBCAPS - WHEELS

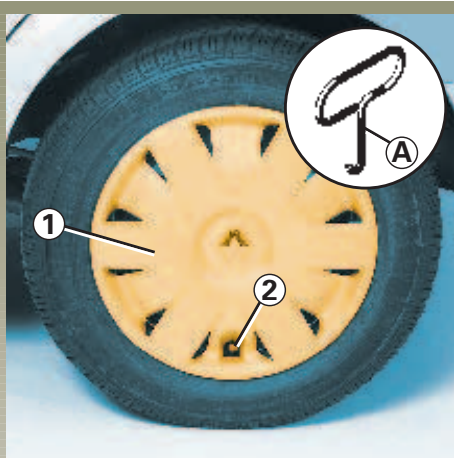

Hubcap with concealed wheel bolts

(example: Hubcap 1)

Remove the Hubcap using the Hubcap spanner **A** (from the tool kit) or the end of the wheelbrace, by engaging the hook into one of the openings around the edge of the Hubcap.

To refit the Hubcap, clip it into position, ensuring it is aligned with the valve **2**.

Wheel or Hubcap with exposed wheel bolts

Remove the bolts and remove the wheel.

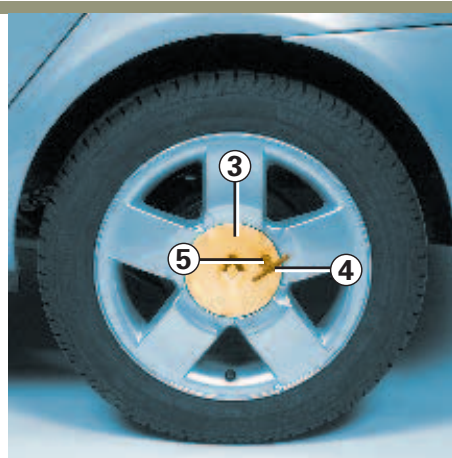

Central embellisher

(example: Hubcap 3)

Remove the Hubcap using the Hubcap spanner (stored in the glove box). Insert the spanner **4** in the recess **5**.

To refit, align recess **5** with rim, clip the Hubcap back into position and refit the nut using spanner **4**.

We would advise you to note the number engraved on the spanner so that you can replace it if it is lost.

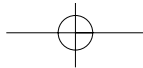

CHANGING A WHEEL



- Remove the wheel embellisher (see section on embellishers).
- Use the wheelbrace **1** to loosen the wheel bolts slightly. Fit it so that you press downwards and not upwards.
- Offer up the jack horizontally, the jack head must be slid underneath the jacking point under the body, nearest the wheel concerned.
- Screw up the jack by hand at first to align the base plate (which should be inclined further inwards than the jack head). Use a piece of wood under the base plate if on soft ground.

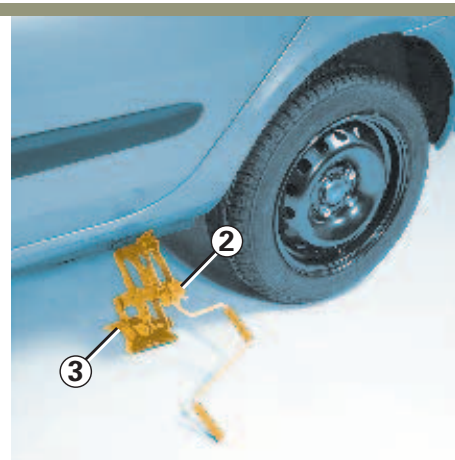

- Insert the end of the wheelbrace **2** into the jack **3** and turn a few times to lift the wheel off the ground:
- Remove the bolts.
- Take off the wheel.
- Position the emergency spare wheel on the central hub and turn it to locate the mounting holes in the wheel and the hub.
- Tighten the bolts and lower the jack.
- Tighten the bolts fully when the wheel is on the ground.



Park your vehicle on firm, flat ground (if necessary, placing a plank under the base of the jack).

Switch on the hazard warning lights.

Apply the handbrake and engage a gear (first or reverse, or **P** on an automatic gearbox).

Ask all the passengers to get out of the vehicle and keep them away from moving traffic.



If you have a puncture, replace the wheel as soon as possible.

A tyre which has been punctured should always be inspected (and repaired if possible) by a specialist.

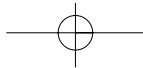

TYRES

Tyre safety - road wheels

The tyres are the only contact between the vehicle and the road, so it is essential to keep them in good condition.

You must make sure that your tyres conform to local road regulations.

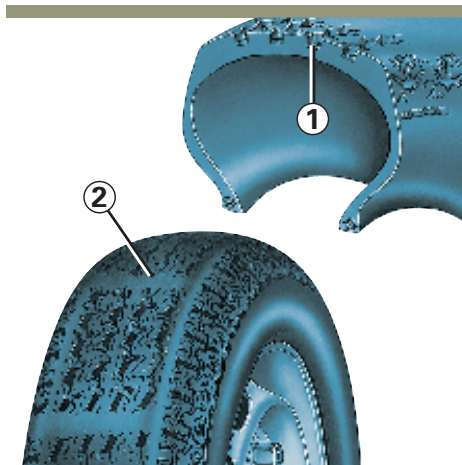

Maintaining the tyres

The tyres must be in good condition and the tread form must have sufficient depth: tyres approved by our Technical Department have wear warning strips **1** which are **risers moulded into the tread at several points**.

When the tread has worn down to the level of these risers, **they become visible 2**: the tyres concerned must be replaced **now** as only **1.6 mm maximum of tread remains and this is not sufficient to maintain good grip on wet roads**.

Incidents which occur when driving such as striking the kerb may damage the tyres and could lead to the misalignment of the front axle geometry.

An overloaded car, long journeys by motorway, especially in very hot weather, or continual driving on poor road surfaces will lead to more rapid tyre wear and affect safety.



When they need to be replaced, only tyres of the same make, dimension, type and profile should be used.

When fitting tyres to the car, they should either be identical to those fitted originally or conform to those recommended by your Renault Dealer.



TYRES (continued)

Tyre inflation pressures

Tyre inflation pressures must be adhered to. (Remember to check the emergency spare wheel at the same time.) Inflation pressures must be checked at least once a month and always before a long journey. (Refer to the section on Tyre inflation pressures).



Incorrect tyre pressures lead to abnormal tyre wear and unusually hot running. Factors which may seriously affect safety and lead to:

- poor roadholding
- possibility of blow-outs or of throwing a tread at high speed.

Inflation pressures depend on the load and the driving speed. Adjust the pressures according to the conditions of use. (Refer to the section on tyre inflation pressures).

Pressures should be checked when the tyres are cold; ignore higher pressures which may be reached in hot weather or after driving at high speeds.

If tyre pressures cannot be checked when the tyres are **cold**, assume an increase of **0.2 to 0.3 bar (3 PSI)**.

Never deflate a hot tyre.

Note: a label (depending on country or version) affixed to the edge or frame of the driver's door gives the recommended tyre pressures.

Replacing tyres



For safety reasons, this operation must only be carried out by a specialist.

Fitting different tyres may change your vehicle as follows:

- It may mean that your vehicle no longer conforms to current regulations.
- It may change the way it handles when cornering.
- It may cause the steering to be heavy.
- It may cause tyre noise.
- It may affect the use of chains.

Changing wheels around

This practice is not recommended.

Emergency spare wheel

Refer to the information on the emergency spare wheel and instructions on how to change a wheel in section 5.

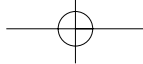

TYRES (continued)

Use in winter

- **Chains**

For safety reasons, chains must never be fitted to the wheels on the rear axle.

Chains must not be fitted to tyres which are larger than those originally fitted to the vehicle.

- **“Snow” or winter tyres**

We recommend that these are fitted to **all four wheels** to ensure that your vehicle retains maximum road holding.

Note: These tyres sometimes have:

- a specific direction of rotation
- a maximum speed which may be lower than the maximum speed of your vehicle.

- **Studded tyres**

This type of equipment may only be used for a limited period and as laid down by local legislation.

It is necessary to keep to the speed specified by current legislation.

As a minimum, these tyres may be fitted to the two front wheels.



Chains may only be fitted to tyres of the same size as those originally fitted to **your vehicle**.

In all cases, we recommend that you consult your Renault Dealer, who will be able to advise you on the choice of equipment which is most suitable for your vehicle.

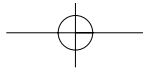

WIPERS

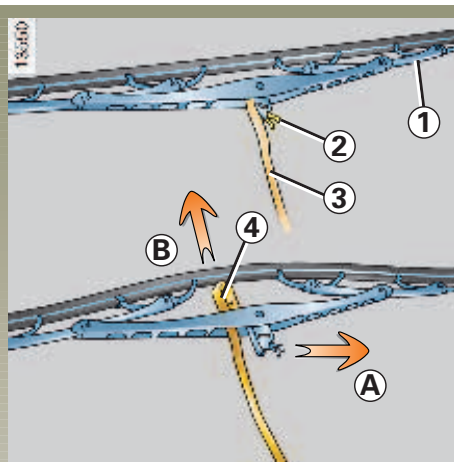

Replacing the windscreen wiper blades 1

- Lift the wiper arm 3.
- Move the blade into a horizontal position.
- Press tab 2 and slide the wiper blade downwards until the hook 4 of the wiper arm is released.
- Remove blade in direction of arrow (A) and fit new blade in direction of arrow (B).

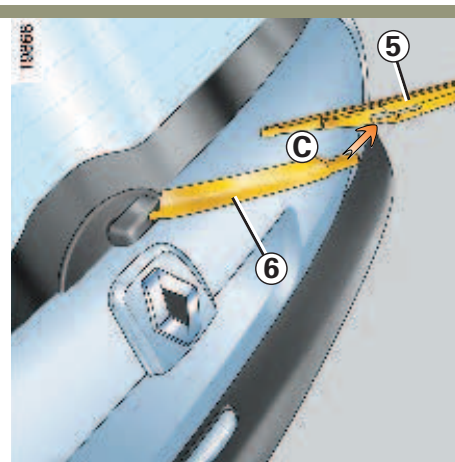

Replacing the rear screen wiper blade 5

- Lift the wiper arm 6.
- Pivot the blade until a resistance is felt.
- Release the blade by pulling it (C).

Refitting a windscreen or rear screen wiper blade

Refitting is the reverse of removal. Ensure the blade is correctly locked in position.

- In freezing conditions, make sure that the wiper blades are not stuck to the windscreen (risk of overheating the motor).
- Keep an eye on the condition of the blades. Change them as soon as they become less efficient: approximately once a year.



HEADLIGHTS WITH HALOGEN BULBS: replacing bulbs

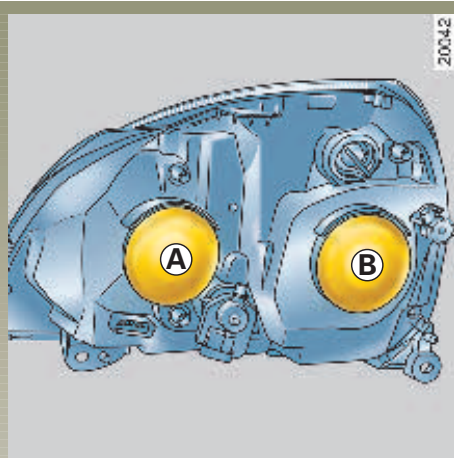

Headlight main beam

Remove the cover **A**.

Unclip bulb connector **1**.

Disengage the springs **2** and remove the bulb.

Dipped beam headlights

Remove cover **B**.

Turn the connector a quarter of a turn and remove bulb **3**.

Type of bulb: **1** ⇒ H1
3 ⇒ H7

anti-UV (see box).

Do not touch the Halogen bulb glass. Hold it by its base.

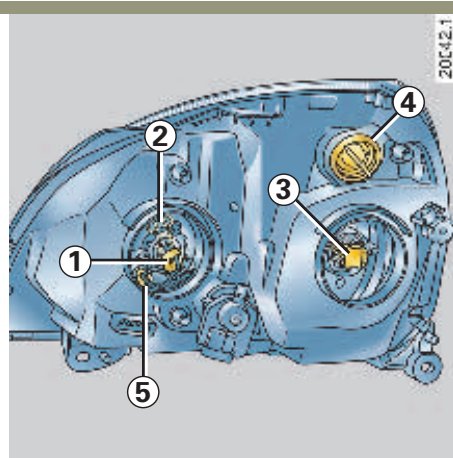

Front side lights

Remove the bulb holder **5** to access the bulb.

Bulb type: W5W.

Direction indicator lights

Turn the bulb holder **4** a quarter of a turn and remove the bulb.

Bulb type: PY21W.

When the bulb has been changed, please refit the cover.

Cleaning the headlights

As the headlights have plastic lenses, use a soft cloth or cotton wool.

If this is not sufficient, use a soft cloth (or cotton wool) dampened with soapy water then rinse using a soft cloth or cotton wool.

Carefully dry off using a soft, dry cloth.

Alcohol based cleaning products must not be used under any circumstances.



As the headlights are fitted with plastic "lenses", it is essential to use anti-UV bulbs.

(If other bulbs are used, this may damage the headlight).

It is advisable to carry a set of spare bulbs for emergencies.

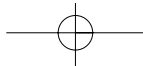

HEADLIGHTS WITH XENON BULBS: replacing bulbs

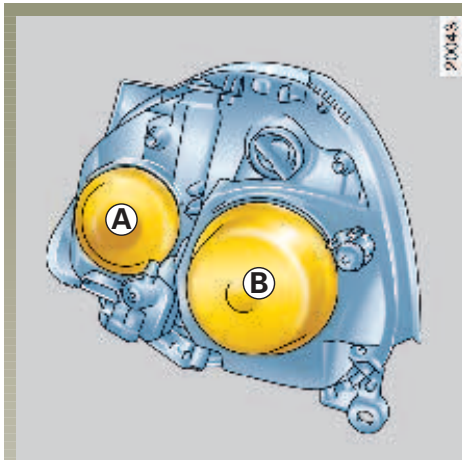

Dipped beam headlights with xenon bulbs

They are marked on the label **3** under the cover **B**.

This type of headlight bulb must be changed by a RENAULT Dealer.

Bulb type: D2S.

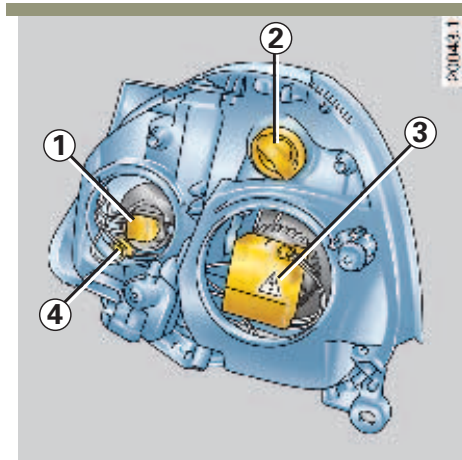

Main beam headlights

Remove cover **A**.

Turn the connector **1** a quarter of a turn and remove the bulb.

Type of bulb: anti U.V. (see box).

Do not touch the Halogen bulb glass. Hold it by its base.

When the bulb has been changed, refit cover **A** correctly.

A special mounting is required to fit this type of headlight. **It is not permitted to fit a headlight fitted with xenon bulbs to a vehicle which was not designed to accept it.**

As headlights are fitted with plastic lenses, you must use anti-UV 55 W bulbs. (Using any other type of H1 bulb may damage the headlight).

It is advisable to carry a set of spare bulbs for emergencies.

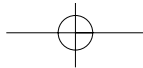

HEADLIGHTS WITH XENON BULBS: replacing bulbs (continued)

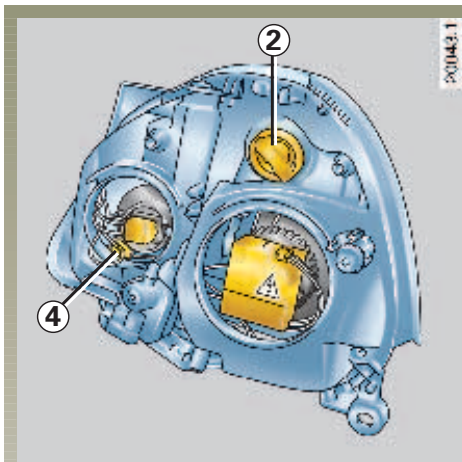

Cleaning headlights

As the headlights are made with plastic lenses, use a soft cloth or cotton wool to clean them.

If this does not clean them properly, use a soft cloth or cotton wool slightly moistened with soapy water and then wipe clean with a soft damp cloth.

Finally, **carefully** dry off with a soft dry cloth.

Cleaning products containing alcohol must not be used under any circumstances.

Direction indicators

Turn the bulb holder **2** a quarter of a turn and take out the bulb.

Bulb type: orange PY21 W bayonet bulb.

Front side lights

Remove the cover **A**.

Remove the bulb holder **4** to access the bulb.

Bulb type: W5W.

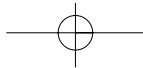

FOG LIGHTS: replacing the bulbs



Front fog lights 1

Changing a bulb and adjusting the headlight beam:

Consult your Renault Dealer.

Additional lights

If you wish to fit fog lights or long range headlights to your vehicle, consult your Renault Dealer.



Any operation on (or modification to) the electrical system must be performed by a Renault Dealer since an incorrect connection might damage the electrical installation (harness, components and in particular, the alternator). In addition, your Dealer has available all the parts required for fitting these units.



REAR LIGHTS: replacing the bulbs

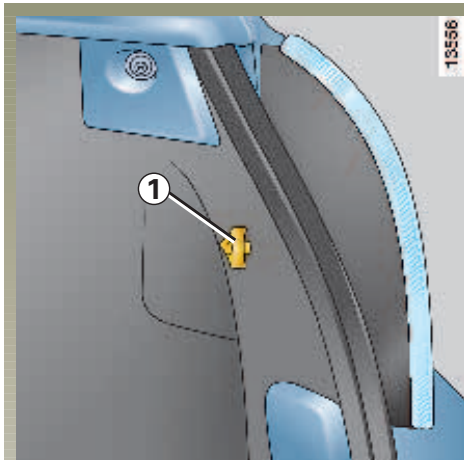

Remove bolt **1** and release the rear lights unit from outside.

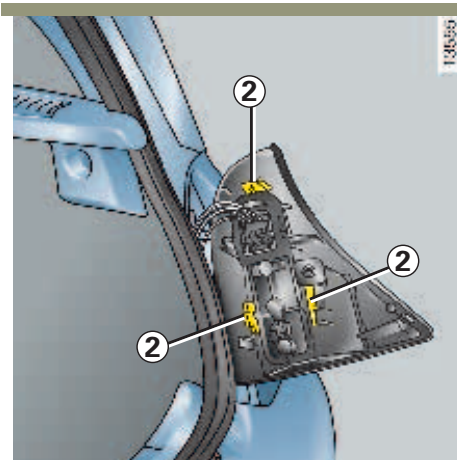

Unclip the bulb holder using tabs **2**.

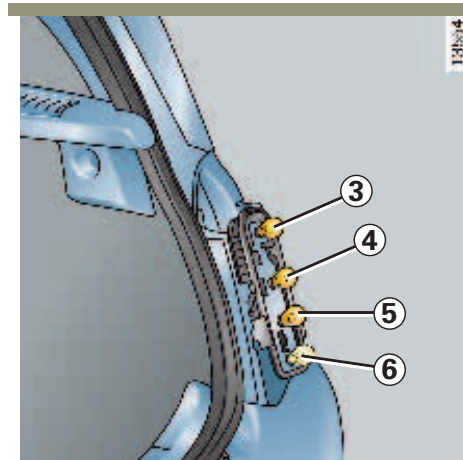

3 Fog light (or nothing)

Bayonet type bulb with 2 filaments P 21 W.

4 Indicator

Orange P 21 W bayonet bulb.

5 Reversing light

Bayonet type bulb with 2 filaments P 21 W.

6 Tail light and stop light

Bayonet type bulb with 2 filaments P 21/5 W.

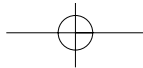

REAR LIGHTS: replacing the bulbs (continued)

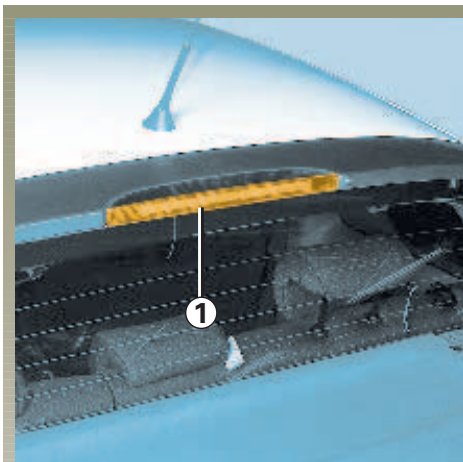

Third centre stop light 1

The third stop light is a special strip light. Consult your Renault Dealer if any work needs to be carried out on this.

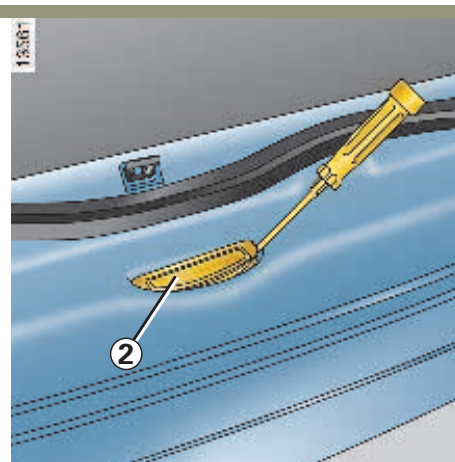

Number plate lights

Release bulb holder 2 (using a flat blade screwdriver for example).

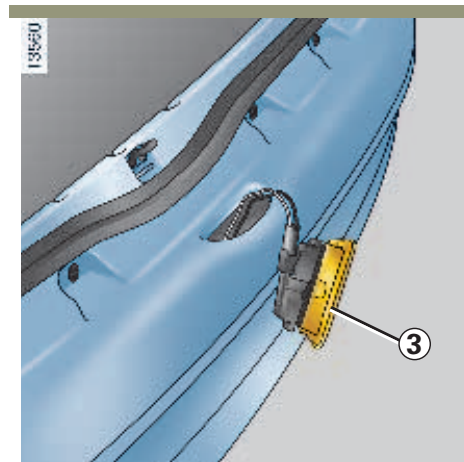

Unclip lens 3 from the bulb holder to reach the bulb.

Bulb type: double ended tubular bulb 5 W.

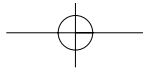

SIDE REPEATERS: replacing the bulbs



Unclip the repeater **1** (using a flat blade screwdriver for example).



Turn the bulb holder **2** a quarter turn and remove the bulb.

Bulb type: W 5 W.

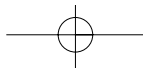

INTERIOR LIGHTS: replacing the bulbs

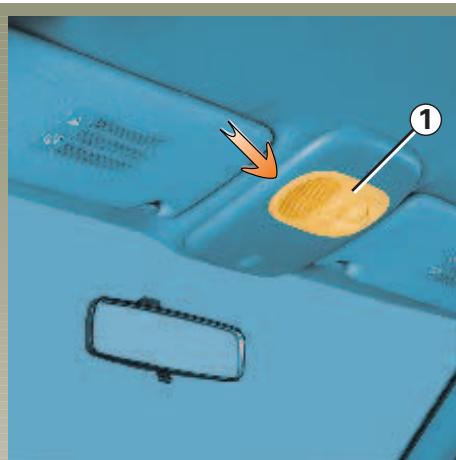

Courtesy light

Unclip cover **1** (using a tool such as a flat screwdriver).

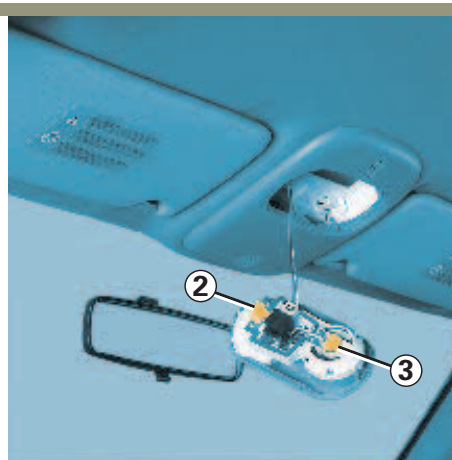

Turn bulb holder **2** or **3** a quarter of a turn.

Bulb type: W 5 W or: festoon type bulb 7W for a single courtesy light.

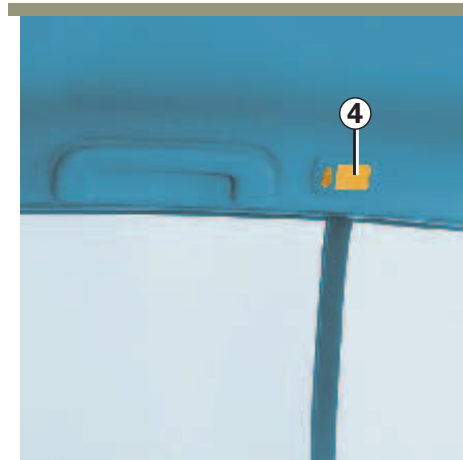

Rear lights **4**

Unclip the light (using a tool such as a flat-bladed screwdriver).

Remove the bulb by turning it a quarter of a turn.

Type of bulb: Bayonet type 5 W.



INTERIOR LIGHTS: replacing the bulbs (continued)

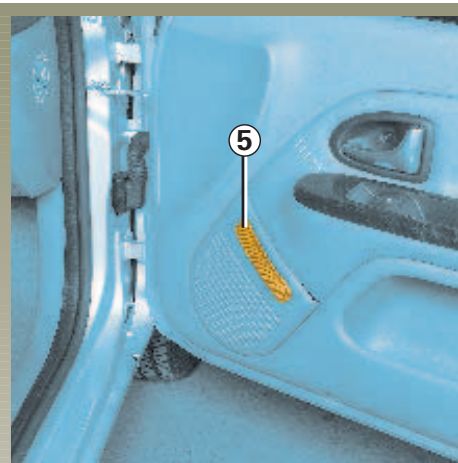

Door lights **5**

Unclip the light **5** (using a tool such as a flat blade screwdriver).

Release the bulb.

Type of bulb: W 5 W.

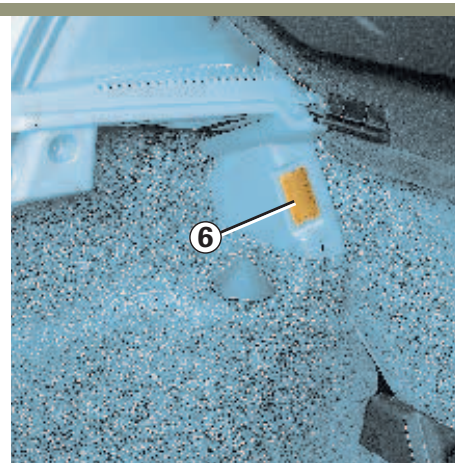

Luggage compartment light **6**

Unclip light **6** by pressing on the tabs on each side of the light (using a tool such as a flat screwdriver).

Disconnect the light.

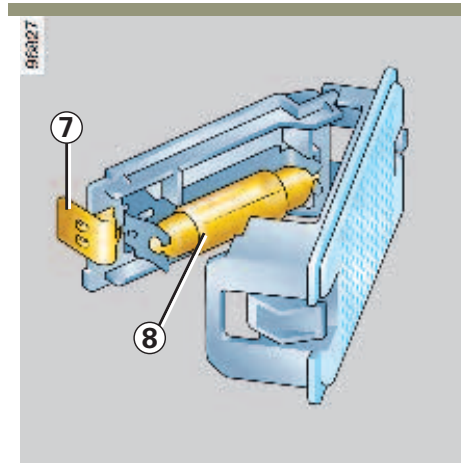

Press tab **7** to release the lens and reach the bulb **8**.

Type of bulb: double-ended tubular bulb 7 W.

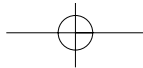

BATTERY breakdown

To avoid all risk of sparks:

- Ensure that the consumers are disconnected before disconnecting or reconnecting the battery.
- When charging, switch off the charger before connecting or disconnecting the battery.
- Do not place metal objects on the battery to avoid creating a short circuit between the terminals.

Connecting a battery charger

Both battery leads must be disconnected (with the engine switched off).

Do not disconnect the battery when the engine is running. **Follow the instructions for use given by the manufacturer of the battery charger you are using.**

Only a well-charged and well-maintained battery will have a long and useful life and enable you to start the vehicle's engine normally.

The battery must be kept clean and dry.

Have the battery's charge status checked regularly:

- especially if you use your vehicle for short journeys or for frequent driving in town;
- When the external temperature drops (in winter), **the charge decreases**. In winter, only use those electrical consumers which are really necessary.
- Finally, you should understand that the charge decreases naturally as a result of certain permanent consumers such as: the clock, aftermarket accessories...

When a large number of accessories are fitted to the vehicle, have them connected **to + after ignition**. In this case, it is advisable to have your vehicle fitted with a battery which has an increased nominal capacity. Consult your Renault Dealer.

If the vehicle is to be left stationary for a long time, disconnect the battery and recharge it regularly, especially in cold weather. The memories, radio etc. will then have to be reprogrammed. The battery must be stored in a dry and ventilated area protected from frost.



Specific procedures may be required to charge some batteries. Consult your Renault Dealer.

Avoid all risk of sparks which may cause an immediate explosion and charge the battery in a well-ventilated area.
Risk of serious injury.

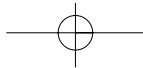

BATTERY: breakdown (continued)

Starting the vehicle using the battery from another vehicle

Proceed as follows when starting your vehicle from another vehicle's battery:

Obtain suitable jump leads (with a large cross section) from a Renault Dealer or, if you already have jump leads, ensure that they are in perfect condition.

Both batteries must have an identical nominal voltage: 12 volts. The battery supplying the current should have a capacity (amp-hours, Ah) which is at least the same as that of the discharged battery.

A frozen battery must be thawed out before current is supplied to it.

Ensure that there is no risk of contact between the two vehicles (risk of short circuiting when the positive terminals are connected) and that the discharged battery is properly connected. Switch off your vehicle ignition.

Start the engine of the vehicle supplying the current and run it at average speed.

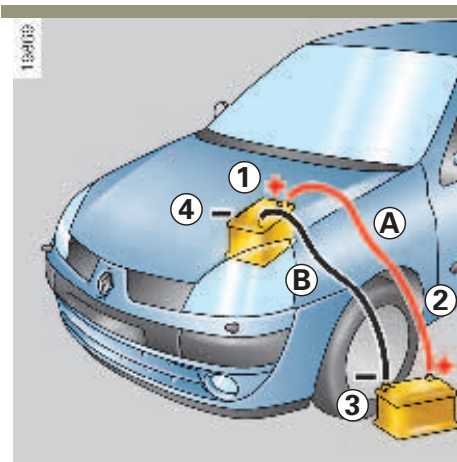

Secure the positive cable (+) **A** to the (+) terminal **1** of the discharged battery then to (+) terminal **2** of the battery supplying the current.

Secure the negative cable (-) **B** to the (-) terminal **3** of the battery supplying the current then to the (-) terminal **4** of the discharged battery.

Check that there is no contact between cables **A** and **B** and that cable **A** is not touching any metal parts on the vehicle supplying the current.

Start the engine as you would normally. As soon as it starts, disconnect cables **A** and **B** in the reverse order (**4-3-2-1**).



Handle the battery with care since it contains sulphuric acid which must never come into contact with eyes or skin. If it does, wash with plenty of water. Keep all flames, light sources and sparks away from the battery: risk of explosion. Take care when working in the engine compartment as the engine cooling fan may cut in at any moment without warning.



REMOTE CONTROL LOCKING DEVICE (batteries)

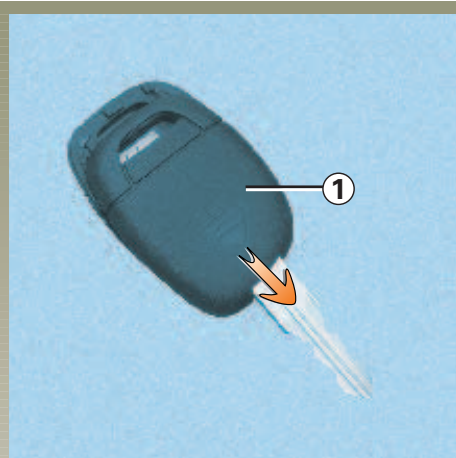

Replacing the battery

Slide off the remote control cover **1**.



Replace the battery **2** according to the direction marked on the cover.

Note: When replacing the battery, it is advisable not to touch the electronic circuit in the key cover.

The batteries can be obtained from your Renault Dealer.

These batteries should last about two years. There is a delay of 1 second between locking and unlocking actions.

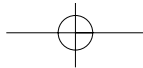

FUSES

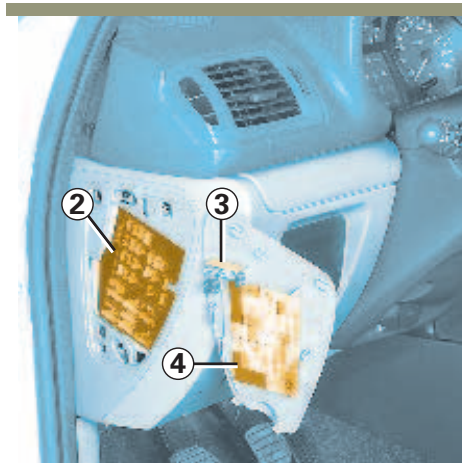
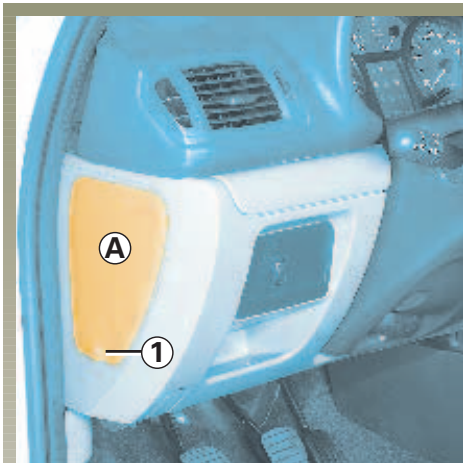

Fuse box 2

If electrical equipment does not work, check the condition of the fuses.

Lift cover **A** using handle **1**.

To identify the fuses, refer to the fuse allocation label **4** (shown on the page opposite).

It is not advisable to use the free fuse locations.



Check the fuse in question and **replace it**, if necessary, **with a fuse which must be of the same rating as the original fuse.**

If a fuse is fitted where the rating is too high, it may cause the electrical circuit to overheat (risk of fire) in the event of an item of equipment using an excessive amount of current.

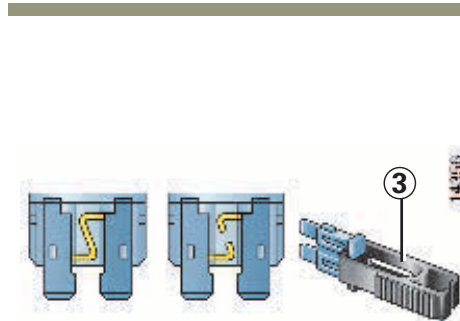

CORRECT **INCORRECT**

Remove the fuse using tweezers **3**. Slide the fuse sideways to remove it from the tweezers.

A sensible precaution:
Obtain an emergency kit containing spare bulbs and fuses from your RENAULT Dealer.

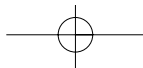

FUSES (continued)

Allocation of fuses (the presence of fuses depends on the vehicle equipment level)

Symbol	Allocation	Symbol	Allocation	Symbol	Allocation
	Air bag/Central timer		Right hand main beam headlight		Left hand side light
STOP	Stop lights		Left hand main beam headlight		Right hand side light
	Heated rear screen		Dual headlights (dipped beam headlights and main beam headlights)		Engine immobiliser
	Windscreen wipers		Heated rear view mirrors		Interior and luggage compartment lights/Radio
	Anti-lock braking (ABS)		Front fog lights		Central door locking
	Fan		Not used		Electric windows
	Radio/Cigar lighter/Clock		Not used		Headlight washers
	Horn		Central timer		Heated seats
	Left hand dipped headlight		Direction indicators/Hazard warning lights		Electric sunroof
	Right hand dipped headlight		Rear fog light		



TOWING breakdown

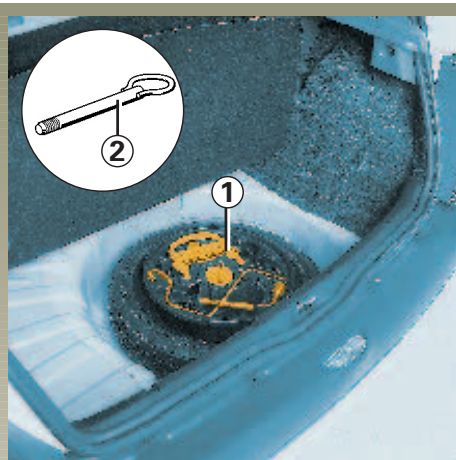

The steering lock must not be applied; the ignition key must be in position "M" (ignition) allowing lights and signals to be used (stop lights and direction indicators). The vehicle lights must be used at night.

It is also important to observe the towing conditions defined by the legislation for the particular country you are in. Do not exceed the towing weight for your vehicle. Consult your Renault Dealer.

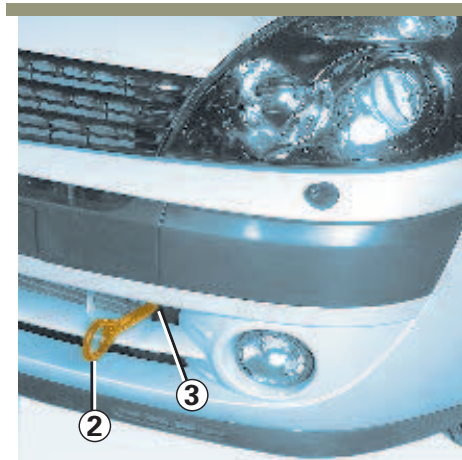

Only use the towing ring 2 (in the tool kit 1) and the towing points at the front 3. (Never use the drive shafts.) These towing points may only be used for pulling the car, never for lifting it either directly or indirectly.



Front towing point 3

Rear towing point 4



First screw in the towing ring 2 by hand as far as it will go. Then use the wheelbrace from the tool kit to finish tightening it.



TOWING breakdown, (continued)



- Renault recommends using a rigid towing bar. If a rope or cable is used (where the law allows this), the vehicle being towed must be able to brake.
- A vehicle must not be towed if it is not fit to be driven.
- Do not accelerate or brake suddenly when towing, as this may result in damage to the vehicle.
- When towing a vehicle, do not exceed **15 mph (25 km/h)**.

Towing a vehicle with automatic transmission: special notes

Engine switched off: The transmission is no longer lubricated. It is preferable to tow this type of vehicle on a trailer or tow it with the front wheels off the ground.

In exceptional cases, you can tow the vehicle with all four wheels on the ground for a maximum distance of 30 miles (50 km).

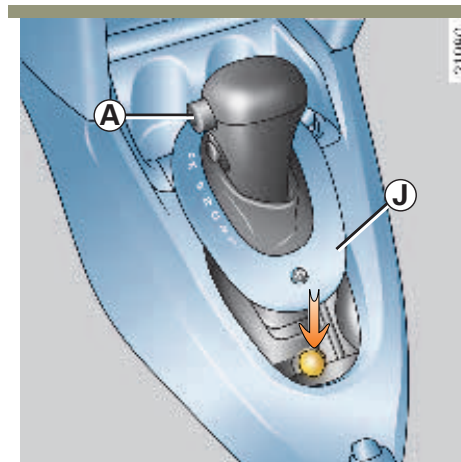

The selector lever must be in neutral (position N).

If the lever becomes jammed in P position, even though you are pressing down the brake pedal, the lever can be released manually.

To do this, unclip cover **J**. Press on both the raised part (under cover **J**) and the unlocking button **A** at the same time to move the lever from position **P**.

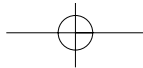

TOWING trailer

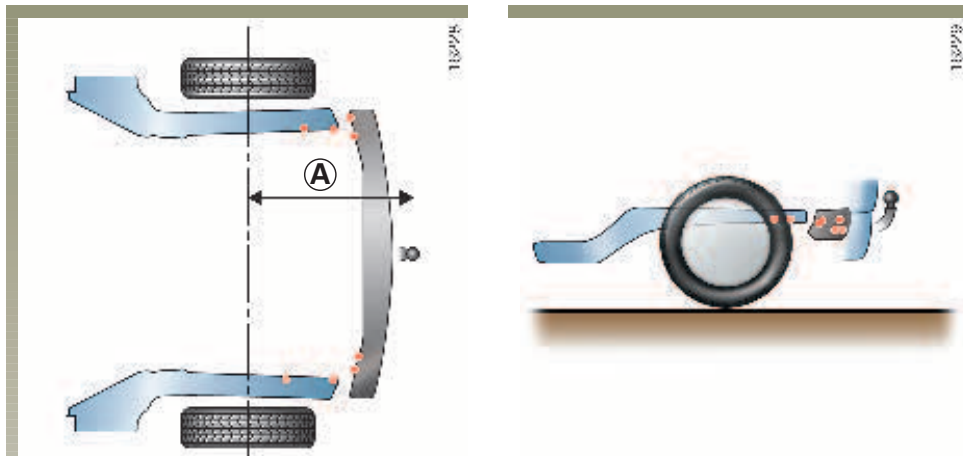

A = 662 mm.

Permissible nose weight when towing a trailer, max. towing weight, braked and unbraked:

Refer to the information on "WEIGHTS" in section 6:

Refer to the manufacturer's instructions for information on how to fit and operate the towing attachment.

It is advisable to keep these instructions with your other vehicle documentation.

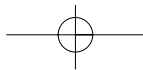

FITTING A RADIO



Radio installation 1

Unclip and remove the cover. The aerial, + and - supply connectors and left and right speaker wires are fixed to the rear face of the cover.

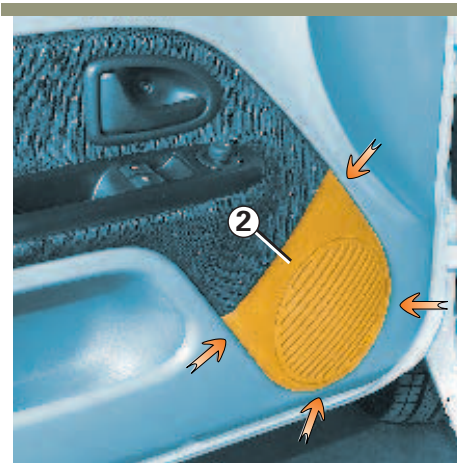

Front speakers

Unclip cover **2** using a flat blade screwdriver type tool at the arrows.

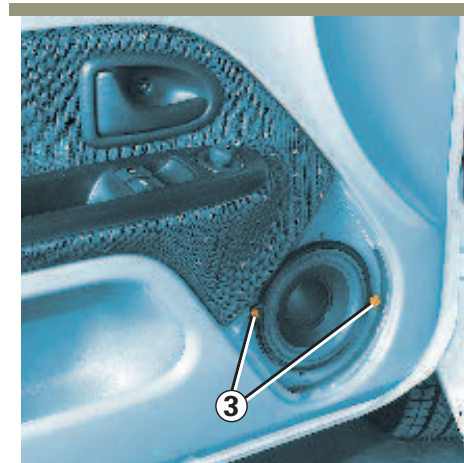

Remove the two screws **3** and then take off the protective card to reach the speaker wires.

- In all cases, follow the manufacturer's fitting instructions carefully.
- The specifications of the supports and wires (available as a Renault parts accessory) vary depending on equipment level of your vehicle and the type of radio.
To find out their reference, consult your Renault Dealer.
- Any operation on (or modification to) the electrical system must be performed by a Renault Dealer since incorrect connections might damage the electrical installations or any components connected to it.



ACCESSORIES



Using mobile phones and CB equipment.

Mobile phone equipment with integrated aerials may cause interference to the original electronic systems fitted to the vehicle: we recommend that you only use equipment with an exterior aerial.

Furthermore, we remind you of the need to conform to the legislation in force concerning the use of such equipment.



After-sales installation of non-electrical accessories (roof bars, towing attachments, etc.)

Accessories approved by Renault are based on a strict specification and are regularly tested. We would recommend that you use approved accessories (particularly where these affect safety) because they are particularly reliable and appropriate for your vehicle.

After-sales installation of electric or electronic accessories

- Any work on the electric circuit of the vehicle must be carried out by Renault network engineers: if the system is connected incorrectly, it may result in damage being caused to the electrical installation and/or the units connected to it.
- If the vehicle is retrofitted with any electrical equipment, make sure that the unit is correctly protected by a fuse. Ask for information on the rating and position of this fuse.

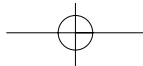

OPERATING FAULTS

Your vehicle should not be affected by faults likely to keep it off the road for long periods if you have followed the Renault Servicing Programme regularly.

The following advice will allow you to get going again quickly, albeit temporarily: for reasons of safety, you should always consult a Renault Dealer as soon as possible.

When starter is activated	CAUSES	REMEDIAL ACTION
<ul style="list-style-type: none"> There is no response. The warning lights fail to illuminate and the starter does not turn. 	Battery lead disconnected or terminals oxidised.	Check battery terminals: scrape clean if oxidised and re-tighten.
	Battery discharged.	Connect another battery to the faulty battery.
	Battery unserviceable.	Replace the battery.
<ul style="list-style-type: none"> Warning lights go dim and starter turns very slowly. 	Battery terminals not tight. Battery terminals oxidised.	Check battery terminals: scrape clean if oxidised and re-tighten.
	Battery discharged.	Connect another battery to the faulty battery.
<ul style="list-style-type: none"> The engine is difficult to start in damp conditions or after washing. The engine is difficult to start when hot. 	Poor ignition, ignition system damp.	Dry the plug leads and ignition coil.
	Poor carburation (bubbles of vaporised fuel in the circuit). Lack of compression.	Let the engine cool down. Consult a Renault Dealer.

5.29

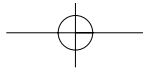

OPERATING FAULTS (continued)

When starter is activated	CAUSES	REMEDIAL ACTION
<ul style="list-style-type: none"> The engine fires once or twice then dies and is difficult to start when cold. 	<p>Immobiliser active.</p> <p>Starting procedure incorrect</p> <p>or</p> <p>Poor fuel supply or ignition fault.</p> <p>System for cutting off fuel supply activated if vehicle has been subject to severe impact.</p>	<p>Refer to the "Engine immobiliser" section.</p> <p>Refer to the "starting the engine" section.</p> <p>If the vehicle will not start, do not keep trying to start it. Consult a Renault Dealer.</p> <p>See a Renault Dealer. (Refer to information on fuel cut-off system in section 5.)</p>
<ul style="list-style-type: none"> Vibrations. 	<p>Tyres incorrectly inflated, incorrectly balanced or damaged.</p>	<p>Check the tyre pressures and, if they are correct, have a Renault Dealer check the condition of the tyres.</p>
<ul style="list-style-type: none"> Coolant boiling in expansion bottle. 	<p>Mechanical fault: cylinder head gasket blown, water pump faulty.</p> <p>Engine cooling fan not working.</p>	<p>Stop the engine. Consult a Renault Dealer.</p> <p>Check the appropriate fuse, otherwise consult a Renault Dealer.</p>

5.30



OPERATING FAULTS (continued)

On the open road	CAUSES	REMEDIAL ACTION
<ul style="list-style-type: none"> Abnormal white smoke from the exhaust. 	Mechanical fault: cylinder head gasket blown.	Stop the engine. Consult a Renault Dealer.
<ul style="list-style-type: none"> Smoke under the bonnet. 	Short circuit. Cooling circuit fault.	Stop the vehicle, switch off the ignition, disconnect the battery. Consult a Renault Dealer.
<ul style="list-style-type: none"> The oil pressure warning light illuminates <ul style="list-style-type: none"> - when cornering or braking. - at idle speed. - is slow to extinguish or remains illuminated on acceleration. 	The level is too low. The oil pressure is too low. Loss of oil pressure.	Top up the oil. Consult the nearest Renault Dealer. Stop and call for the assistance of a Renault Dealer.
<ul style="list-style-type: none"> The engine lacks power. 	Dirty air filter. Fuel supply fault. Spark plugs faulty, incorrect gap.	Replace the cartridge. Check the fuel level. Consult a Renault Dealer.
<ul style="list-style-type: none"> Idle speed unsteady or engine stalls. 	Lack of compression (spark plugs, ignition, air leak)	Consult a Renault Dealer.

5.31

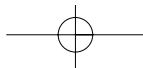

OPERATING FAULTS (continued)

On the open road

CAUSES

REMEDIAL ACTION

<ul style="list-style-type: none"> Steering becomes hard to turn. 	Belt broken. Lack of oil in pump.	Have the belt replaced. Top up oil (see maintenance section). If the fault persists, consult your Renault Dealer.
<ul style="list-style-type: none"> The engine overheats. The coolant temperature warning light illuminates (or the needle on the gauge is in the red zone). 	Water pump: belt slack or broken. Faulty engine cooling fan.	Stop the vehicle, switch off the engine and call for the assistance of a Renault Dealer.
	Coolant leaks.	Check the condition of the hoses and clips. Check the expansion bottle: it should contain coolant. If it does not, top up the level (after letting the engine cool down). Take care not to burn yourself. This action is only temporary: consult your Renault Dealer as soon as possible.



Radiator

Never fill a hot radiator with cold coolant if a considerable quantity has been lost. After any operation on the vehicle which has involved even partial draining of the cooling system, it must be refilled with a new mixture prepared in the correct proportions. Reminder: only products approved by our Technical Department may be used for this purpose.

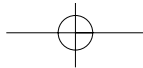

OPERATING FAULTS (continued)

Electrical equipment	CAUSES	REMEDIAL ACTION
• The wipers do not work.	Wiper blades stuck.	Release the blades before use.
	Fuse blown (intermittent, park).	Replace the fuse.
	Motor faulty.	Consult a Renault Dealer.
<hr/>		
• Indicators flash more rapidly.	- Bulb blown.	Replace the bulb.
<hr/>		
• Direction indicators not flashing. On one side:	- bulb blown.	Replace the bulb.
	- feed wire disconnected or connector out of position.	Reconnect the wire.
	- faulty earth.	Find the earth wire which is secured to a metal component, scrape the end of the earth wire and refit it carefully.
<hr/>		
On both sides:	- fuse blown.	Replace the fuse.
	- flasher unit faulty.	Replace: consult a Renault Dealer.

5.33

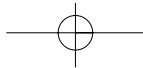

OPERATING FAULTS (continued)

Electrical equipment	CAUSES	REMEDIAL ACTION	
<ul style="list-style-type: none"> Headlights do not work. 	On one side:	- bulb blown.	Replace the bulb.
		- feed wire disconnected or connector out of position.	Check and reconnect the wire or the connector.
		- faulty earth.	See above.
	On both sides:	- if the circuit is protected by a fuse.	Check and replace the fuse if necessary.
<ul style="list-style-type: none"> Traces of condensation in the lights. 	<p>This is not a fault. The presence of traces of condensation in the lights is a natural phenomenon concerned with variations in temperature. These traces will disappear quickly once the lights are in use.</p>		



Section 6: Technical specifications



Identification plates	6.02	→	6.04
Engine specifications			6.05
Weights	6.06	→	6.14
Towing weights	6.06	→	6.14
Dimensions			6.15
Replacement parts			6.16
			6.01

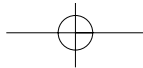

IDENTIFICATION PLATES



A

The information on the vehicle identification plate A (right hand side) must be quoted when writing or ordering parts

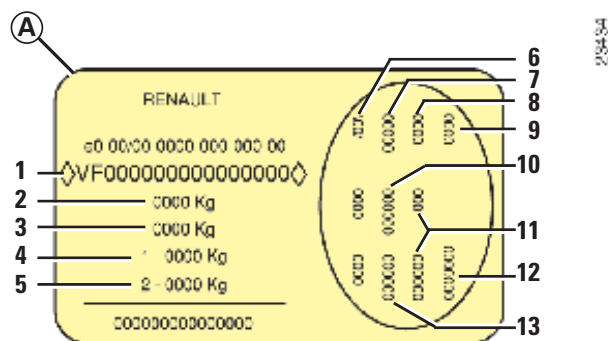

A - Vehicle identification plate

- | | |
|--|---|
| <p>1 Vehicle type and chassis number.
(Number repeated on a plate mounted on the dashboard at the base of the windscreen)</p> <p>2 Maximum permissible all up weight.</p> <p>3 Maximum permissible total train weight (= vehicle loaded and towing a trailer).</p> <p>4 Maximum permissible front axle loading.</p> <p>5 Maximum permissible rear axle loading.</p> | <p>6 Technical specifications of the vehicle.</p> <p>7 Paint code.</p> <p>8 Equipment level.</p> <p>9 Vehicle type.</p> <p>10 Trim code.</p> <p>11 Additional equipment definition code.</p> <p>12 Fabrication number.</p> <p>13 Interior matching trim code.</p> |
|--|---|

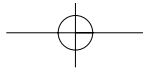

IDENTIFICATION PLATES (continued)

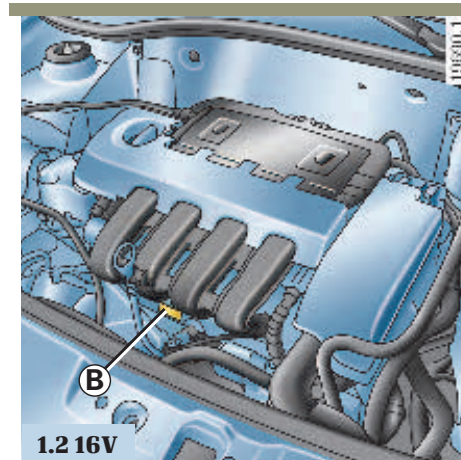
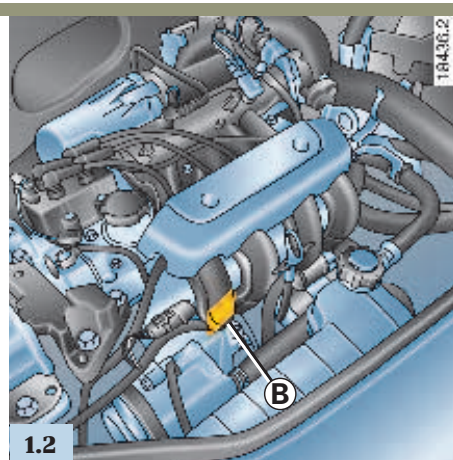
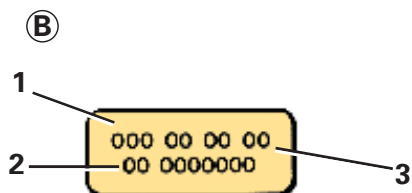

The information on the vehicle identification plate and the engine plate *B* must be quoted when writing or ordering parts.

B - Engine plate or engine label
(location differs depending on engine)

- 1 Engine type
- 2 Engine suffix
- 3 Engine number

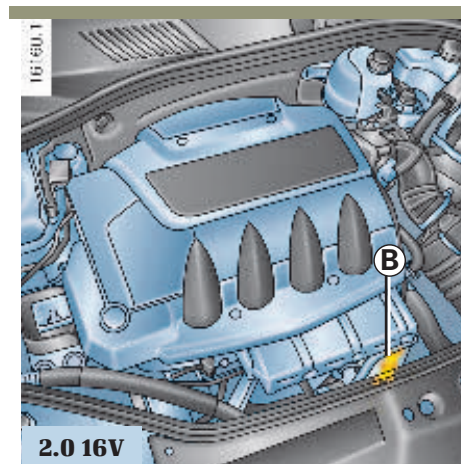
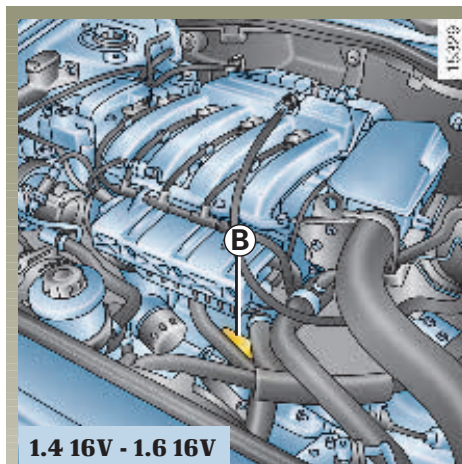



IDENTIFICATION PLATES (continued)

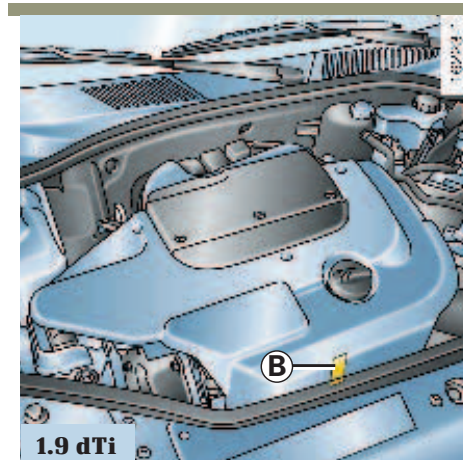
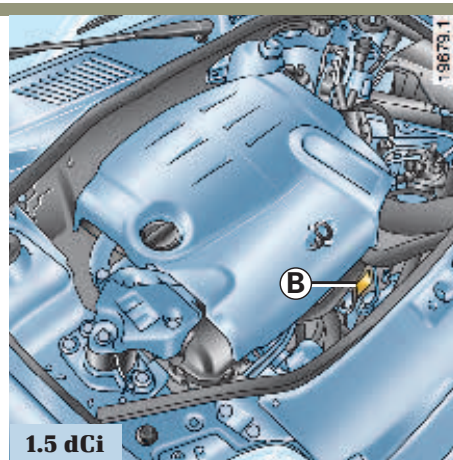
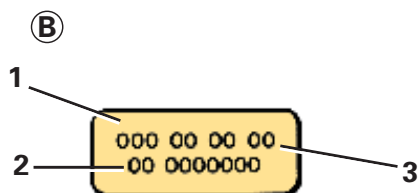

The information on the vehicle identification plate and the engine plate *B* must be quoted when writing or ordering parts.

B - Engine plate or engine label
(location differs depending on engine)

- 1 Engine type
- 2 Engine suffix
- 3 Engine number

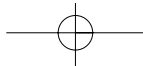

ENGINE SPECIFICATIONS

Versions	1.2	1.2 16V	1.4 16V	1.6 16V	2.0 16V	1.5 dCi	1.9 dTi
Vehicle type (see vehicle identification plate)	B/C/SB0F B/C/SB10 B/C/SB1K B/CB2D	B/C/SB05 B/C/SB11 B/C/SB0W	B/CB1L B/CB0P B/CB13	B/CB14 B/CB1D	CB15 CB1C CB1G CB1N CB1S CB1T	B/C/SB07 B/C/SB08 SB09 BB1W	B/CB2C
Engine type (see engine plate)	D7F	D4F	K4J	K4M	F4R	K9K	F9Q turbo
Capacity (cm ³)	1 149	1 149	1 390	1 598	1 998	1 461	1 870
Fuel grade	Unleaded fuel					Diesel	
Octane rating	95 or 98 (1)				98	–	–
Spark plugs	Only use the type specified for your vehicle's engine. Their type is shown on a label in the engine compartment, otherwise consult your RENAULT Dealer. Fitting spark plugs which are not to specification may damage the engine.					–	–

(1) If unavailable, unleaded fuel with an octane rating of 91 may be used.

6.05

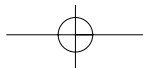

WEIGHTS (in kg) - **Basic vehicle without options, likely to change in the course of the model year:**
Consult your RENAULT Dealer.

5-door petrol versions (versions sold vary according to country)		1.2	1.2 16V	1.2 16V Quickshift 5	1.4 16V	1.4 16V Automatic	1.6 16V	1.6 16V Automatic
Vehicle type (see vehicle identification plate)		BB0F BB10 BB1K BB2D	BB05 BB0W BB11	BB05 BB0W	BB0P BB13 BB1L	BB13 BB1L	BB14 BB1D	BB14 BB1D
Kerb weight Without driver	Total	900	930	940	1 000	1 030	1 040	1 065
	Front	545	565	575	645	670	675	700
	Rear	355	365	365	355	360	365	365
Maximum permitted axle load	Front	780	780	780	850	860	850	860
	Rear	785	785	785	785	785	785	785
Maximum permissible all up weight		1 440	1 470	1 480	1 545	1 570	1 535	1 560
Maximum permissible towed weight, unbraked		485	500	505	535	550	545	555
Maximum permissible towed weight, braked (1)	driver only	1 100	1 100	1 100	1 200	1 200	1 200	1 200
	other cases	800	800	800	900	900	900	900
Maximum permissible total train weight (= maximum permissible all up weight + trailer)		2 200	2 200	2 250	2 400	2 400	2 400	2 400
Maximum permissible nose weight		75						
Max. permissible load on roof rack		70 (including the carrying device)						

6.06

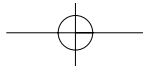

WEIGHTS (continued)

(1) Towed weight (Towing a caravan, boat, etc.)

- It is important that the towing weights in each country governed by local legislation are respected. Consult your Renault Dealer for all towing attachments. **In all cases, never exceed the maximum permissible total train weight (vehicle + trailer).**
- If your vehicle is already being used fully laden (maximum permitted all up weight); your maximum speed must be limited to 60 mph (100 km/h) and the tyre inflation pressures should be increased by 0.2 bar.
- Engine output and performance on hills are reduced with altitude. We recommend that you reduce the maximum load by 10% at an altitude of 1000 metres, then by an additional 10% for each 1000 metres thereafter.

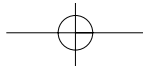

WEIGHTS (in kg) - **Basic vehicle without options, likely to change in the course of the model year:**
Consult your RENAULT Dealer.

3-door petrol versions (versions sold vary according to country)		1.2	1.2 16V	1.2 16V Quickshift 5	1.2 16V	1.2 16V Quickshift 5	1.4 16V	1.4 16V
Vehicle type (see vehicle identification plate)		CB0F CB10 CB1K CB2D	CB05 CB11	CB05	CB0W	CB0W	CB0P CB13 CB1L	CB13 CB1L
Kerb weight Without driver	Total	880	910	920	910	920	980	1 010
	Front	540	560	570	560	570	640	665
	Rear	340	350	350	350	350	340	345
Maximum permitted axle load	Front	780	780	780	780	780	850	860
	Rear	785	785	785	785	785	785	785
Maximum permissible all up weight		1 420	1 450	1 460	1 450	1 460	1 525	1 550
Maximum permissible towed weight, unbraked		475	490	495	490	495	525	540
Maximum permissible towed weight, braked (1)	driver only	1 100	1 150	1 150	1 150	1 150	1 200	1 200
	other cases	850	800	800	850	850	950	900
Maximum permissible total train weight (= maximum permissible all up weight + trailer)		2 200	2 250	2 250	2 250	2 250	2 400	2 400
Maximum permissible nose weight		75						
Max. permissible load on roof rack		60 (including the carrying device)						

6.08

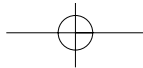

WEIGHTS (continued)

(1) Towing weight (towing a caravan, boat, etc.)

- It is important to comply with the towing weights, governed by local legislation in each country and, in particular laid down in the Road Traffic Regulations. Consult your Renault Dealer about any attachments. **Under no circumstances may the total train weight (= max. permissible all-up weight and weight towed) be exceeded.**
- If your vehicle is already used at full load (max. permissible all-up weight), the maximum speed must be limited to 60 mph (100 km/h) and the tyre inflation pressure increased by 0.2 bar.
- The engine output and climbing capability are reduced with altitude. We recommend that the maximum load be reduced by 10% at an altitude of 1000 metres and by an additional 10% for each 1000 metres thereafter.

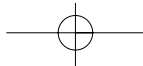

WEIGHTS (in kg) - **Basic vehicle without options, likely to change in the course of the model year:**
Consult your RENAULT Dealer.

3-door petrol versions (continued) (versions sold vary according to country)		1.6 16V	1.6 16V Automatic	1.6 16V	1.6 16V Automatic	2.0 16V
Vehicle type (see vehicle identification plate)		CB14	CB14	CB1D	CB1D	CB15 - CB1C CB1G - CB1N CB1S - CB1T
Kerb weight Without driver	Total Front Rear	1 020 670 350	1 045 695 350	1 030 680 350	1 060 705 355	1 035 660 375
Maximum permitted axle load	Front Rear	850 785	860 785	850 785	860 785	850 700
Maximum permissible all up weight		1 515	1 540	1 515	1 540	1 490
Maximum permissible towed weight, unbraked		535	545	535	545	(2)
Maximum permissible towed weight, braked (1)	driver only	1 200	1 200	1 200	1 200	(2)
	other cases	900	900	950	900	(2)
Maximum permissible total train weight (= maximum permissible all up weight + trailer)		2 350	2 400	2 400	2 400	1 490
Maximum permissible nose weight		75				(2)
Max. permissible load on roof rack		60 (including the carrying device)				

6.10



WEIGHTS (continued)

(1) Towed weight (Towing a caravan, boat, etc.)

- It is important that the towing weights in each country governed by local legislation are respected. Consult your Renault Dealer for all towing attachments. **In all cases, never exceed the maximum permissible total train weight (vehicle + trailer).**
- If your vehicle is already being used fully laden (maximum permitted all up weight); your maximum speed must be limited to 60 mph (100 km/h) and the tyre inflation pressures should be increased by 0.2 bar.
- Engine output and performance on hills are reduced with altitude. We recommend that you reduce the maximum load by 10% at an altitude of 1000 metres, then by an additional 10% for each 1000 metres thereafter.

(2) No towing option

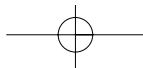

WEIGHTS (in kg) - **Basic vehicle without options, likely to change in the course of the model year:**
Consult your RENAULT Dealer.

Diesel versions (versions marketed depend on country)		1.5 dCi 5 doors			1.9 dTi 5 doors	1.5 dCi 3 doors		1.9 dTi 3 doors	
Vehicle type (see vehicle identification plate)		BB07	BB08	BB1W	BB2C	CB07	CB08	CB2C	
Kerb weight Without driver	Total	980	980	990	1 020	960	960	1 000	
	Front	610	610	620	655	605	605	650	
	Rear	370	370	370	365	355	355	350	
Maximum permitted axle load	Front	860	860	840	860	860	860	860	
	Rear	785	785	785	785	785	785	785	
Maximum permissible all up weight		1 535	1 540	1 510	1 510	1 515	1 520	1 490	
Maximum permissible towed weight, unbraked		535	535	530	545	525	525	535	
Maximum permissible towed weight, braked (1)	driver only	1 200	1 200	1 100	1 200	1 200	1 200	1 200	
	other cases	900	900	800	950	950	950	950	
Maximum permissible total train weight (= maximum permissible all up weight + trailer)		2 400	2 400	2 250	2 400	2 400	2 400	2 400	
Maximum permissible nose weight		75							
Max. permissible load on roof rack		70 (including the carrying device)				60 (including the carrying device)			

6.12

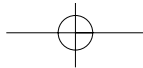

WEIGHTS (continued)

(1) Towing weight (towing a caravan, boat, etc.)

- It is important to comply with the towing weights, governed by local legislation in each country and, in particular laid down in the Road Traffic Regulations. Consult your Renault Dealer about any attachments. **Under no circumstances may the total train weight (= max. permissible all-up weight and weight towed) be exceeded.**
- If your vehicle is already used at full load (max. permissible all-up weight), the maximum speed must be limited to 60 mph (100 km/h) and the tyre inflation pressure increased by 0.2 bar.
- The engine output and climbing capability are reduced with altitude. We recommend that the maximum load be reduced by 10% at an altitude of 1000 metres and by an additional 10% for each 1000 metres thereafter.

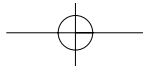

WEIGHTS (in kg) - **Basic vehicle without option, likely to change in the course of the model year.**
Consult your RENAULT Dealer.

Utility versions (versions marketed depend on country)		1.2	1.2 16V	1.5 dCi	1.5 dCi
Vehicle type (see vehicle identification plate)		SB0F SB10 SB1K	SB05 SB11 SB0W	SB07	SB08 SB09
Kerb weight Without driver	Total	880	910	980	980
	Front	540	560	630	630
	Rear	340	350	350	350
Maximum permitted axle load	Front	780	780	860	860
	Rear	785	785	785	785
Maximum permissible all up weight		1 420	1 450	1 515	1 520
Maximum permissible towed weight, unbraked		475	505	525	525
Maximum permissible towed weight, braked (1)	driver only	1 100	1 100	1 150	1 150
	other cases	850	800	900	900
Maximum permissible total train weight (= maximum permissible all up weight + trailer)		2 200	2 200	2 400	2 400
Permissible nose weight		75		50	
Max. permissible load on roof rack		60 (including the carrying device)			

(1) Towed weight

(Towing a caravan, boat, etc.)

- It is important that the towing weights in each country governed by local legislation are respected. Consult your RENAULT Dealer for all towing attachments. **In all cases, never exceed the maximum permissible total train weight (vehicle + trailer).**
- If your vehicle is already being used fully laden (maximum permitted all up weight); your maximum speed must be limited to 60 mph (100 km/h) and the tyre inflation pressures should be increased by 0.2 bar.
- Engine output and performance on hills are reduced with altitude. We recommend that you reduce the maximum load by 10% at an altitude of 1000 metres, then by an additional 10% for each 1000 metres thereafter.

6.14



DIMENSIONS (in metres)

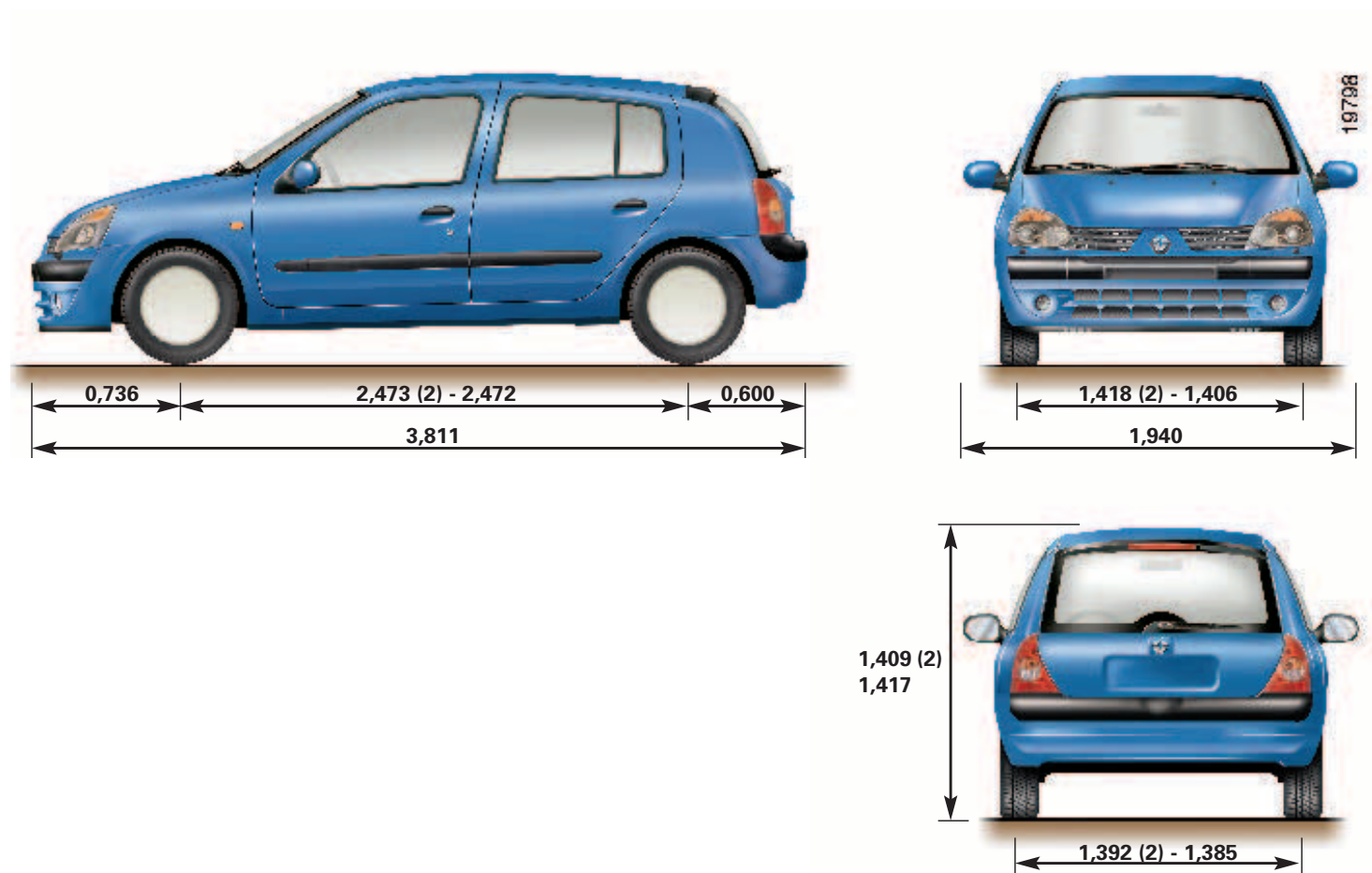

(1) According to equipment
(2) Version 2.0 16V

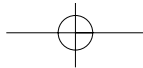

REPLACEMENT PARTS AND REPAIRS

Original RENAULT parts are based on a strict specification and are regularly tested. Therefore, they are of at least the same level of quality as the originally fitted part.

If you always fit RENAULT genuine parts to your vehicle, you will ensure that it performs well. Repairs carried out using original parts in the RENAULT network are guaranteed for one year.

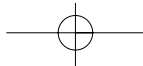

ALPHABETICAL INDEX

- A** ABS 2.20
 Accessories 5.28
 Accessories installation 5.28
 Additional headlights 5.13
 Adjusting beam height 1.57
 Adjusting the driver's position 1.13 - 1.14
 Air conditioning 3.09 → 3.22
 Air vents 3.02 - 3.03
 Airbag 1.15 → 1.20
 Anti-lock braking system 2.20
 Anti-pollution (advice) 2.06 → 2.08
 Anti-theft system (switch) 2.02
 Ashtrays 3.32
 Automatic gearbox (use) 2.10 → 2.12
 Automatic gearbox selector lever 2.10 → 2.12
- B** Battery 4.10 - 5.19 - 5.20
 Bodywork (maintenance) 4.12 - 4.13
 Bonnet 4.02
 Brake fluid 4.08
 Bulbs (changing) 5.10 → 5.18
 Buzzer (lights on) 1.04 - 1.56
- C** Capacity of mechanical components 4.07 - 4.09
 Catalytic converter (special points) 2.04
 Catalytic converter 2.04
 Central door locking 1.02 - 1.03 - 1.05
 Changing a wheel 5.05
 Changing the bulbs 5.10 → 5.18
 Child booster seat 1.23 → 1.32
 Child safety 1.04 - 1.24 → 1.36 - 3.25 - 3.28
 Children 1.04 - 1.19 - 1.24 → 1.36 - 3.25 - 3.28
 Cigarette lighter 3.32
- C** Clock 1.37
 Control instruments 1.42 → 1.52
 Controls 1.38 → 1.41
 Coolant 4.09
 Courtesy lights 3.23 - 3.24
 Courtesy mirrors 3.26
 Cruise control - speedlimiherer 2.21 → 2.26
- D** Dashboard 0.04 → 0.06 - 1.38 → 1.41
 Deactivating front passenger airbags 1.34 - 1.35
 De-icing: windscreen 3.05 - 3.06 - 3.10 - 3.17
 rear screen 1.61
 Demisting: windscreen 3.05 - 3.06 - 3.10 - 3.17
 rear screen 1.61
 Dimensions 6.15
 Dipstick 4.03 → 4.06
 Direction indicators 1.62 - 5.10 - 5.12 - 5.14 - 5.16
 Door locking 1.03 → 1.06
 Doors 1.04 - 1.05
 Driver's layout 1.50 → 1.52
 Driving 2.02 → 2.30
 Driving position 1.38 → 1.41
- E** Electronic stability program: ESP 2.27 - 2.28
 Emergency spare wheel 5.02
 Engine (technical specifications) 6.05
 Engine immobiliser 1.07 - 1.08
 Engine oil 4.03 → 4.07
 Engine specifications 6.05
 Environment 2.09
 ESP: Electronic stability program 2.27 - 2.28
 Exterior temperature 1.37

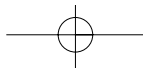

ALPHABETICAL INDEX

- F** Faults (operating faults) 5.29 → 5.34
 Filter: air filter 4.11
 oil filter 4.11
 Fitting a radio 5.27
 Fog lights 1.56 - 5.13
 Front seat adjustment 1.11 - 1.12
 Front seat belt pretensioners 1.15
 Front seats (adjustment) 1.11 - 1.12
 Fuel (advice on economy) 2.06 → 2.08
 Fuel (filling) 1.64
 Fuel (grade) 1.64 - 6.05
 Fuel economy 2.06 → 2.08
 Fuel filler flap 1.63
 Fuel level 1.43 - 1.51 - 1.52
 Fuel tank capacity 1.63
 Fuses 5.22 - 5.23
- G** Gear lever 2.19
- H** Handbrake 2.19
 Hazard warning lights 1.62
 Headlight flashers 1.62
 Headlights (adjusting) 1.57
 Headlights 1.55 → 1.57
 Headrest 1.09 - 1.10
 Heated seats 1.12
 Heating 3.04 → 3.08
 Heating and ventilation 3.09 → 3.22
 Horn 1.62
 Hubcap lever 5.03 - 5.04
 Hubcaps 5.04
- I** Ignition switch 2.02
 Indicator and warning lights 1.42 → 1.49
 Instrument panel 1.42 → 1.49
 Interior trim (maintenance) 4.14
- J** Jack 5.03 - 5.05
- K** Keys 1.02
- L** Levels 4.03 → 4.11
 Lifting the vehicle (changing a wheel) 5.03 → 5.05
 Lighting: exterior 1.55 - 1.56 - 5.10 → 5.16
 interior 3.23 - 3.24 - 5.17 - 5.18
 instrument panel (adjustment) 1.55
 Lighting signals 1.55 → 1.57
 Lights: adjusting 1.57
 brake lights 5.14 - 5.15
 dipped beam headlights 1.55 - 5.10 - 5.11
 direction indicator lights 1.62 - 5.10
 - 5.12 - 5.14 - 5.16
 fog lights 1.56 - 5.13 - 5.14
 hazard warning lights 1.60
 main beam headlights 1.55 - 5.10 - 5.11
 reversing lights 5.14
 side lights 1.55 - 5.10 - 5.12 - 5.14
 Luggage compartment 3.34 → 3.37
- M** Maintenance: bodywork 4.12 - 4.13
 interior trim 4.14
 mechanical 4.03 → 4.11
- O** Oil change 4.07
 On-board computer 1.50 → 1.52
 Operating faults 5.29 → 5.34

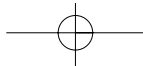

ALPHABETICAL INDEX

- P** Paintwork (maintenance) 4.12 - 4.13
 Paintwork (part number) 6.02
 Petrol and diesel special features 2.04 - 2.05
 Power assisted steering 2.19 - 4.10
 Power assisted steering pump 4.10
 Practical advice 2.06 → 2.08
 Puncture 5.02 → 5.05
- Q** Quickshift 5 gearbox (use) 2.13 → 2.18
 Quickshift 5 gearbox lever 2.13
- R** Radio (fitting) 5.27
 Radio (installation) 5.27
 Reading lights 3.23 - 3.24
 Rear bench seat 3.33
 Rear parcel shelf 3.35 - 3.36
 Rear screen (demisting) 1.61
 Rear seats 3.33
 Rear view mirrors 1.53 - 1.54
 Remote control: electric door locking 1.02 - 1.03
 door locking - batteries 5.21
 Replacement parts 6.16
 Reverse gear 2.19
 Running in 2.02
- S** Seat belts 1.13 → 1.23
 Side repeaters 5.16
 Speakers (locktion) 5.27
 Starting the engine 2.02 - 2.03
 Steering wheel (adjusting) 1.54
 Storage compartments 3.30 - 3.31
 Sun visor 3.26
 Sunroof 3.27 → 3.29
- T** Tank: brake fluid 4.08
 engine coolant 4.09
 fuel 1.58 - 1.64
 windscreen washer 4.11
 Technical specifications 6.02 → 6.15
 Towing (attachments) 5.26
 Towing (breakdown) 5.24 - 5.25
 Towing (caravan) 6.06 → 6.14
 Towing weights 6.06 → 6.14
 Traction control 2.28 - 2.29
 Traction control system 2.29 - 2.30
 Transporting items in the luggage compartment .. 3.37
 Turning circle 6.15
 Tyre pressures 0.04 - 0.05 - 5.07
 Tyre pressures 0.04 → 0.06
 Tyres 5.06 → 5.08
- V** Vehicle identification plates 6.02 → 6.04
 Ventilation and heating 3.04 → 3.22
- W** Washing 4.12 → 4.14
 Weights 6.06 → 6.14
 Wheelbrace 5.03
 Wheels (safety) 5.06 → 5.08
 Window winder 3.25
 Windscreen 3.26
 Windscreen washer 1.58 - 1.59 - 4.11
 Wiper blades 5.09
 Wipers 1.58 → 1.60 - 5.09

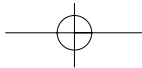

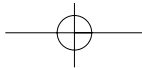



CRÉATEUR D'AUTOMOBILES

Driver's handbook – 82 00 285 818 – NU 654-6 – August 2002 – Edition anglaise