

RLP40 - radio lathe probe



© 2010 Renishaw plc. All rights reserved.

This document may not be copied or reproduced in whole or in part, or transferred to any other media or language, by any means, without the prior written permission of Renishaw plc.

The publication of material within this document does not imply freedom from the patent rights of Renishaw plc.

Renishaw part no: H-5627-8504-01-A

First issued: 01.10

Contents

Contents

Before you begin

Before you begin	1.1
Disclaimer	1.1
Trademarks	1.1
Warranty	1.1
Changes to equipment	1.1
CNC machines	1.1
Care of the probe	1.1
Patents	1.2
EC Declaration of Conformity	1.3
WEEE DIRECTIVE	1.3
FCC DECLARATION (USA)	1.3
Radio approval	1.4
Safety	1.5

RLP40 basics

Introduction	2.1
Getting started	2.1
System interface	2.1
Trigger Logic™	2.2
Modes of operation	2.2
Configurable settings	2.2
Switch on/switch off methods	2.2
Enhanced trigger filter	2.2
Multiple probe mode	2.4
Acquisition mode	2.4
RLP40 dimensions	2.5
RLP40 specification	2.6

System installation

Installing the RLP40 with an RMI	3.1
Operating envelope	3.1
Performance envelope when using the RLP40 with the RMI	3.2
RLP40 / RMI positioning	3.2
Performance envelope	3.2
Preparing the RLP40 for use	3.3
Fitting the stylus	3.3
Installing the batteries	3.4
Mounting the probe on a shank	3.5
Stylus on-centre adjustment.	3.6
Stylus trigger force adjustment.	3.7
Calibrating the RLP40	3.8
Why calibrate a probe?	3.8
Calibrating in a bored hole or on a turned diameter.	3.8
Calibrating the probe length	3.8

Trigger Logic™

Reviewing the current probe settings	4.1
Multiple probe settings	4.2
Probe settings record	4.3
Changing the probe settings	4.4
RLP40 – RMI partnership	4.6
Operating mode.	4.7

Maintenance

Maintenance	5.1
Cleaning the probe	5.1
Changing the batteries	5.2
Battery type	5.3
RLP40 eyelid	5.4
Re-assembling the probe	5.4

Fault finding

Parts list

Before you begin

Before you begin

Disclaimer

RENISHAW HAS MADE CONSIDERABLE EFFORTS TO ENSURE THE CONTENT OF THIS DOCUMENT IS CORRECT AT THE DATE OF PUBLICATION BUT MAKES NO WARRANTIES OR REPRESENTATIONS REGARDING THE CONTENT. RENISHAW EXCLUDES LIABILITY, HOWSOEVER ARISING, FOR ANY INACCURACIES IN THIS DOCUMENT.

Trademarks

RENISHAW® and the probe emblem used in the RENISHAW logo are registered trademarks of Renishaw plc in the UK and other countries.

apply innovation™ and Trigger Logic™ are trademarks of Renishaw plc.

All other brand names and product names used in this document are trade names, service marks, trademarks, or registered trademarks of their respective owners.

Warranty

Equipment requiring attention under warranty must be returned to your equipment supplier. No claims will be considered where Renishaw equipment has been misused, or where repairs or adjustments have been attempted by unauthorised persons. Prior consent must be obtained in instances where Renishaw equipment is to be substituted or omitted. Failure to comply with this requirement will invalidate the warranty.

Changes to equipment

Renishaw reserves the right to change equipment specifications without notice.

CNC machines

CNC machine tools must always be operated by fully trained personnel in accordance with the manufacturer's instructions.

Care of the probe

Keep system components clean and treat the probe as a precision tool.

Patents

Features of the RLP40 probe, and other similar Renishaw probes, are subject of one or more of the following patents and/or patent applications:

CN 100466003	JP 4237051
CN 101287958	TW 200720626
CN 101482402	US. 5150529
EP 0652413	US. 5279042
EP 0695926	US. 5669151
EP 1185838	US. 7285935
EP 1373995	US. 6776344
EP 1425550	US. 2006-0215614
EP 1457786	US. 2009-0049704
EP 1477767	US. 2009-0130987
EP 1477768	US. 6776344
EP 1576560	US. 6941671
EP 1701234	US. 7145468
EP 1734426	US. 7441707
EP 1804020	US. 7486195
EP 1931936	
EP 1988439	
IN 2004-057552	
IN 2004-057552	
IN 2007-028964	
IN 215787	
JP 2004-279417	
JP 2008-203270	
JP 3126797	
JP 3967592	
JP 2004-522961	
JP 2006-313567	
JP 2006-511860	
JP 2009-507240	



Renishaw PLC hereby declares that the RLP40 is in compliance with the essential requirements and other relevant provisions of Directive 1999/5/EC. Contact Renishaw PLC at www.renishaw.com/rlp40/cert for the full EC Declaration of Conformity.

WEEE DIRECTIVE

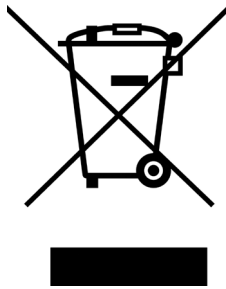

The use of this symbol on Renishaw products and/or accompanying documentation indicates that the product should not be mixed with general household waste upon disposal. It is the responsibility of the end user to dispose of this product at a designated collection point for waste electrical and electronic equipment (WEEE) to enable reuse or recycling. Correct disposal of this product will help to save valuable resources and prevent potential negative effects on the environment. For more information, please contact your local waste disposal service or Renishaw distributor.

FCC DECLARATION (USA)

FCC Section 15.19

This device complies with Part 15 of the FCC rules.

Operation is subject to the following two conditions:

1. This device may not cause harmful interference.
2. This device may accept any interference received, including interference that may cause undesired operation.

FCC Section 15.105

This equipment has been tested and found to comply with the limits for a Class A digital device, pursuant to Part 15 of the FCC rules. These limits are designed to provide reasonable protection against harmful interference when the equipment is operated in a commercial environment. This equipment generates, uses, and can radiate radio frequency energy and, if not installed and used in accordance with the instruction manual, may cause harmful interference to radio communications. Operation of this equipment in a residential area is likely to cause harmful interference, in which case you will be required to correct the interference at your own expense.

FCC Section 15.21

The user is cautioned that any changes or modifications not expressly approved by Renishaw plc, or authorised representative could void the user's authority to operate the equipment.

Radio approval

PENDING RADIO APPROVAL

Safety

Information to the user

The RLP40 is supplied with two non-rechargeable ½ AA lithium metal batteries. Once the charge in these batteries is depleted, please dispose of them in accordance with your local environmental and safety laws. Do not attempt to re-charge these batteries.

Please ensure replacement batteries are of the correct type and are fitted with the correct polarity in accordance with the instructions in this manual and as indicated on the product. For specific battery operating, safety and disposal guidelines, please refer to the battery manufacturers' literature.

- Ensure that all batteries are inserted with the correct polarity.
- Do not store in direct sunlight or rain.
- Do not heat or dispose of the battery in fire.
- Avoid forced discharge of the battery.
- Do not short circuit.
- Do not disassemble, apply excessive pressure, pierce or deform.
- Do not swallow and keep out of reach of children.
- Do not get battery wet.

If battery is damaged, exercise caution when handling.

Please ensure that you comply with international and national battery transport regulations when transporting batteries or the products. Lithium batteries are classified as dangerous goods and strict controls apply on their shipment by air. To reduce the risk of shipment delays, should you need to return the products to Renishaw for any reason, do not return any batteries.

The RLP40 has a glass window. Handle with care if broken to avoid injury.

Information to the machine supplier/ installer

It is the machine supplier's responsibility to ensure that the user is made aware of any hazards involved in operation, including those mentioned in Renishaw product literature, and to ensure that adequate guards and safety interlocks are provided.

Under certain circumstances, the probe signal may falsely indicate a probe seated condition. Do not rely on probe signals to halt the movement of the machine.

Information to the equipment installer

All Renishaw equipment is designed to comply with the relevant EEC and FCC regulatory requirements. It is the responsibility of the equipment installer to ensure that the following guidelines are adhered to, in order for the product to function in accordance with these regulations:

- any interface **MUST** be installed in a position away from any potential sources of electrical noise, i.e. power transformers, servo drives etc;
- all ground connections should be connected to the machine 'star point' (the 'star point' is a single point return for all equipment ground and screen cables). This is very important and failure to adhere to this can cause a potential difference between grounds;
- all screens must be connected as outlined in the user instructions;
- cables must not be routed alongside high current sources, i.e. motor power supply cables etc, or be near high speed data lines;
- cable lengths should always be kept to a minimum.

Equipment operation

If this equipment is used in a manner not specified by the manufacturer, the protection provided by the equipment may be impaired.

This page left intentionally blank

RLP40 basics

Introduction

Welcome to the RLP40 job set-up and inspection probe. At only 40 mm diameter, this compact probe sets industry standards for functionality, reliability and robustness in the harshest of machine tool environments.

RMP40 forms part of Renishaw's family of new generation radio transmission probes, It is ideally suited to large machining centres, where line-of-sight between probe and receiver is difficult to achieve or where Z travel is limited.

RLP40 complies with FCC regulations and operates in the 2.4 GHz band. It delivers interference-free transmission through the use of FHSS (Frequency Hopping Spread Spectrum). This allows many systems to operate in the same machine shop without risk of cross-interference.

All RLP40 settings are configured using 'Trigger Logic'. This technique enables the user to review and subsequently change probe settings by deflecting the stylus whilst observing the LED display.

Configurable settings are:

- Radio on / Radio off
- Radio on / Timer off
- Spin on / Spin off
- Spin on / Timer off
- Filter on / Filter off
- Multiple probe mode on / multiple probe mode off

Getting started

Three multicolour LEDs provide visual indication of selected probe settings.

For example:

- Switch-on and switch-off methods
- Probe status - triggered or seated
- Battery condition

Batteries are inserted or removed as shown (see 'RLP40 batteries' for further information).

On insertion of batteries, the LEDs will begin to flash (see 'Reviewing current probe settings' for further information).

System interface

The RMI integrated interface/receiver is used to communicate between the RLP40 probe and the machine control.

Trigger Logic™

Trigger Logic™ (see Section 4, "Trigger Logic™") is a method that allows the user to view and select all available mode settings in order to customise a probe to suit a specific application. Trigger Logic™ is activated by battery insertion and subsequent stylus deflection. A sequence of stylus deflection (triggering) is then used to systematically lead the user through the available choices to allow selection of the required mode options.

Current probe settings can be reviewed by simply removing the batteries for a minimum of 5 seconds, and then replacing them to activate the Trigger Logic™ review sequence.

Modes of operation

The RLP40 probe can be in one of three modes:

Standby mode: where the probe is awaiting a switch on signal.

Operational mode: activated by one of the switch on methods described on this page. In this mode the RLP40 is ready for use.

Configuration mode: where Trigger Logic™ may be used to configure the following probe settings.

Configurable settings

Switch on/switch off methods

The following switch on/switch off options are user-configurable.

1. Radio on/Radio off
2. Radio on/Timer off
3. Spin on/Spin off
4. Spin on/Timer off

Enhanced trigger filter

Probes subjected to high levels of vibration or shock loads may output signals without having contacted any surface. The enhanced trigger filter improves the probes resistance to these effects.

When the filter is enabled, a constant 10 ms delay is introduced to the probe output.

The RLP40 is factory set to trigger filter off.

NOTE: It may be necessary to reduce the probe approach speed to allow for the increased stylus overtravel during the extended time delay.

RLP40 switch on method Switch on options are configurable	RLP40 switch off method Switch off options are configurable	Switch on time
<p>Radio on</p> <p>Radio switch on is commanded by machine input.</p>	<p>Radio off</p> <p>Radio switch off is commanded by machine input. A timer automatically switches the probe off 90 minutes after the last trigger if it is not turned off by machine input.</p> <p>Timer off (timeout)</p> <p>Timeout will occur 12, 33 or 134 seconds (user configurable) after the last probe trigger or reset.</p>	<p>1 second maximum Note: This assumes a good radio communication link. In a poor RF environment this may rise to a maximum of 3 seconds.</p>
<p>Spin on</p> <p>Spin at 500 rev/min for 1 second minimum (6 seconds maximum).</p>	<p>Spin off</p> <p>Spin at 500 rev/min for 1 second minimum (6 seconds maximum). A timer automatically switches the probe off 90 minutes after the last trigger if it is not spun.</p> <p>Timer off (timeout)</p> <p>Timeout will occur 12, 33 or 134 seconds (user configurable) after the last probe trigger or reset.</p>	<p>2 seconds maximum. Note: The 2 seconds starts from the moment the spindle reaches 500 rev/min.</p>

NOTE: After being switched on, the RLP40 must be on for 1 second minimum (the RLP40 must be spun down before it can be spun off again) before being switched off.

Multiple probe mode

The RLP40 can be configured, using Trigger Logic™, to allow multiple radio probes to be used with a single RMI.

NOTES:

The 'radio on' switch on method cannot be used in multiple probe mode. Multiple probe mode will not appear as an option if the 'radio on' option has been selected.

RLP40 probes which are set to 'multiple probe mode on' can coexist alongside any number of RLP40 probes set to 'mode off'.

To allow multiple radio probes to work in close proximity, and with a single RMI, 16 choices of 'mode on' colours are available, each representing a different machine tool installation. The colour choices available are as shown on page 4.2.

All probes operating with a single RMI must be set to the same 'mode on' colour choice; any multiple probes located on adjacent machines must all be set to an alternative 'mode on' colour choice. Only one probe per 'mode on' colour choice needs to be partnered with the RMI as, by configuring multiple probes to a single 'mode on' colour choice, all probes using this 'mode on' colour choice will have the same identity. The probe to be partnered is partnered after selecting the 'multiple probe mode' setting and choosing the 'mode on' option. See 'Changing the probe settings' in Section 4, "Trigger Logic™".

There is no limit to the number of probes that can be used with a single RMI so long as they all have the same 'mode on' colour choice.

All RLP40 probes are factory set to 'mode off'.

The addition of any further probe(s) into a single probe installation will require that all probes are reconfigured to the same 'mode on' colour choice and that one of the probes is then repartnered with the RMI.

The addition of any further probe(s), or replacements, into a multi-probe installation can be achieved simply through the reconfiguration of the probe to the same 'mode on' colour choice.

Acquisition mode

System set-up is achieved using Trigger Logic™ and powering on the RMI.

Partnering is only required during initial system set-up. Further partnering is only required if either the RLP40 or RMI is changed.

Partnering will not be lost by reconfiguration of probe settings or when changing batteries, except where multiple probe mode is selected.

Partnering can take place anywhere within the operating envelope.

RLP40 dimensions

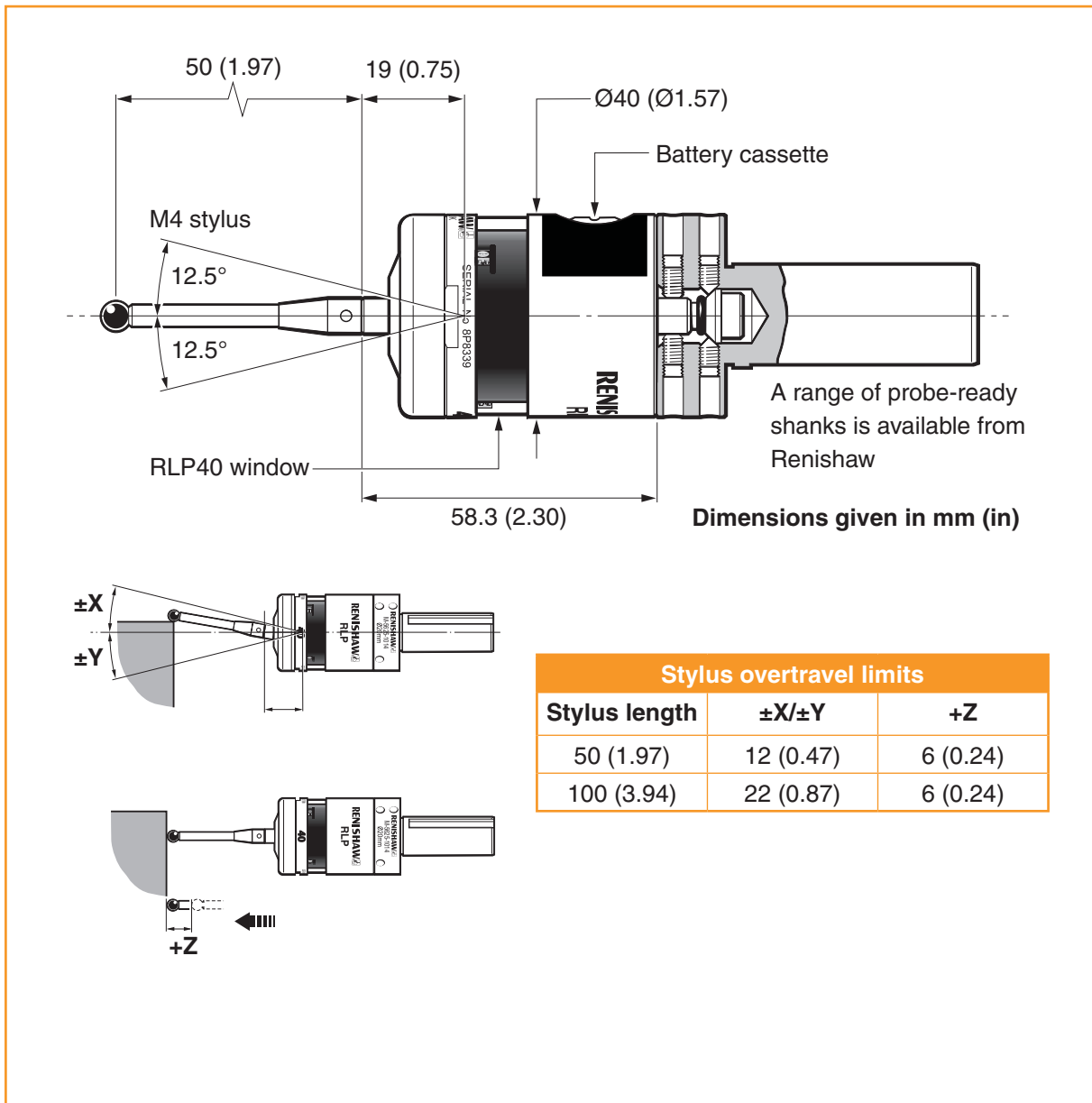

RLP40 specification

Principal application	Workpiece inspection and job setup on turning centres	
Dimensions		
Length	58.3 mm (2.30 in)	
Diameter	40 mm (1.57 in)	
Weight (without shank)		
With batteries	260 g (9.17 oz)	
Without batteries	240 g (8.47 oz)	
Transmission type	Frequency Hopping Spread Spectrum (FHSS) radio	
Radio frequency	2400 MHz to 2483.5 MHz	
Switch ON methods	Radio 'M' code, spin	
Switch OFF methods	Radio 'M' code, spin, time out	
Spindle speed (maximum)	1000 rev/min	
Operating range	Up to 15 m (49.2 ft)	
Receiver/interface	RMI combined antenna, interface and receiver unit	
Sense directions	Omni-directional $\pm X$, $\pm Y$, $+Z$	
Uni-directional repeatability maximum 2σ value in any direction	1.0 μm (0.00004 in) is certified at 480 mm/min (1.57 ft/min) using a 50 mm (1.97 in) long stylus.	
Stylus trigger force (Factory setting§)		The stylus trigger force is the force exerted on the component when the probe triggers. However, the maximum force applied to the component will occur after the trigger point and will be greater than the trigger force. The magnitude depends on a number of factors affecting probe overtravel including measuring speed and machine deceleration. If the forces applied to the component are critical, contact Renishaw for further information.
XY low force	0.4 N, 40 gf (1.4 ozf)	
XY high force	0.8 N, 80 gf (2.8 ozf)	
Z	5.3 N, 530 gf (18.7 ozf)	
(Maximum setting§)		
XY low force	0.8 N, 80 gf (2.8 ozf)	
XY high force	1.6 N, 160 gf (5.6 ozf)	
Z	10.0 N, 1000 gf (35.3 ozf)	
(Minimum setting§)		
XY low force	0.3 N, 30 gf (1.1 ozf)	
XY high force	0.6 N, 60 gf (2.1 ozf)	
Z	4.0 N, 400 gf (14.1 ozf)	
Stylus overtravel		
XY plane	$\pm 12.5^\circ$	
+Z plane	6 mm (0.24 in)	

§ Using a 50 mm (1.97 in) straight stylus.

RLP40 specification (continued)

Environment (As defined in BS EN 61010 - 1:2001)	IP rating	IPX8 (BS5490, IEC 60529) 1 atmosphere
	Storage temperature	-10 °C to 70 °C (14 °F to 158 °F)
	Operating temperature	5 °C to 50 °C (41 °F to 122 °F)
	Altitude	Exceeds 2000 m
	Pollution degree	3
	Relative humidity	No humidity restriction
	Indoor use only	
Battery types	2 x 1/2 AA (3.6V) Lithium Thionyl Chloride	
Battery reserve life	Approximately one week after a low battery warning is first given	
Low battery indication	Blue flashing LED in conjunction with normal red or green probe status LED	
Dead battery indication	Constant or flashing red	

Typical battery life

Battery type	Spin switch on		Radio switch on		Continuous use
	Standby life	5% usage (72 minutes/day)	Standby life	5% usage (72 minutes/day)	
Lithium Thionyl Chloride	240 days	150 days	290 days	170 days	450 hours

This page left intentionally blank

System installation

Installing the RLP40 with an RMI

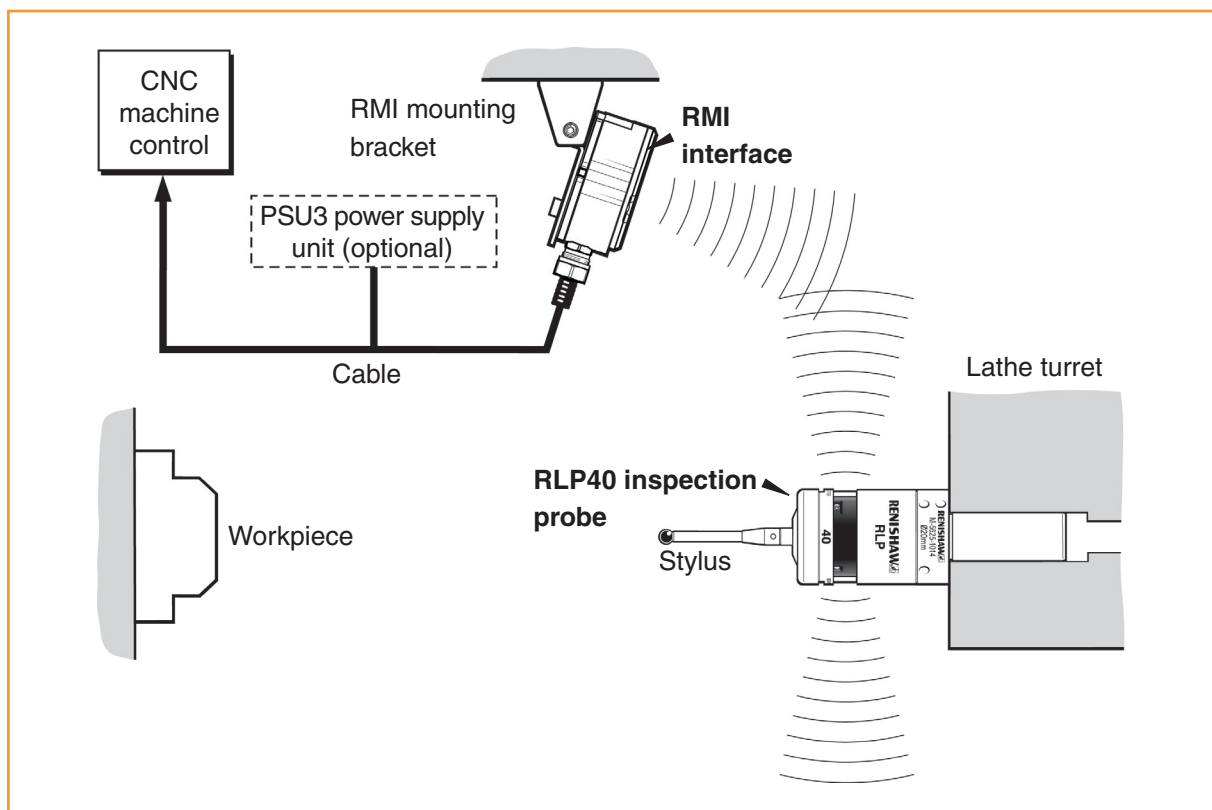

Operating envelope

Radio transmission does not require line-of-sight and will pass through small gaps and machine tool windows. This allows easy installation, either inside or outside the machine enclosure.

Coolant and swarf residue accumulating on the RLP40 and RMI may have a detrimental effect on transmission performance. Wipe clean as often as is necessary to maintain unrestricted transmission.

When operating, do not touch either the RMI cover or the probe glass window with your hand, as this will affect the performance.

Some reduction in range may result when operating in temperatures of 0 °C to 5 °C (32 °F to 41 °F) and 50 °C to 60 °C (122 °F to 140 °F).

Performance envelope when using the RLP40 with the RMI

RLP40 / RMI positioning

The probe system should be positioned so that the optimum range can be achieved over the full travel of the machine's axes. Always face the front cover of the RMI in the general direction of the machining area and the tool magazine, ensuring both are within the performance envelope shown below. To assist in finding the optimum position of the RMI, the signal quality is displayed on an RMI signal LED.

NOTE: RLP40 / RMI installation with RLP40 in radio-on configuration.

RLP40 has a built-in hibernate mode (battery saving mode) that saves battery life when the RMI is unpowered in radio-on (radio-off or time-off) configurations. The RLP40 goes into hibernate mode 30 seconds after the RMI is unpowered (or the RLP40 is out of range). When in hibernate mode, the RLP40 checks for a powered RMI every 30 seconds. If found, the RLP40 goes from hibernate mode to stand-by mode, ready for radio-on.

Performance envelope

The RLP40 and RMI must be within each other's performance envelope as shown below. The performance envelope shows line-of-sight performance, however radio transmission does not require this providing a reflected path (of less than 15 m (49.2 ft)) is available.

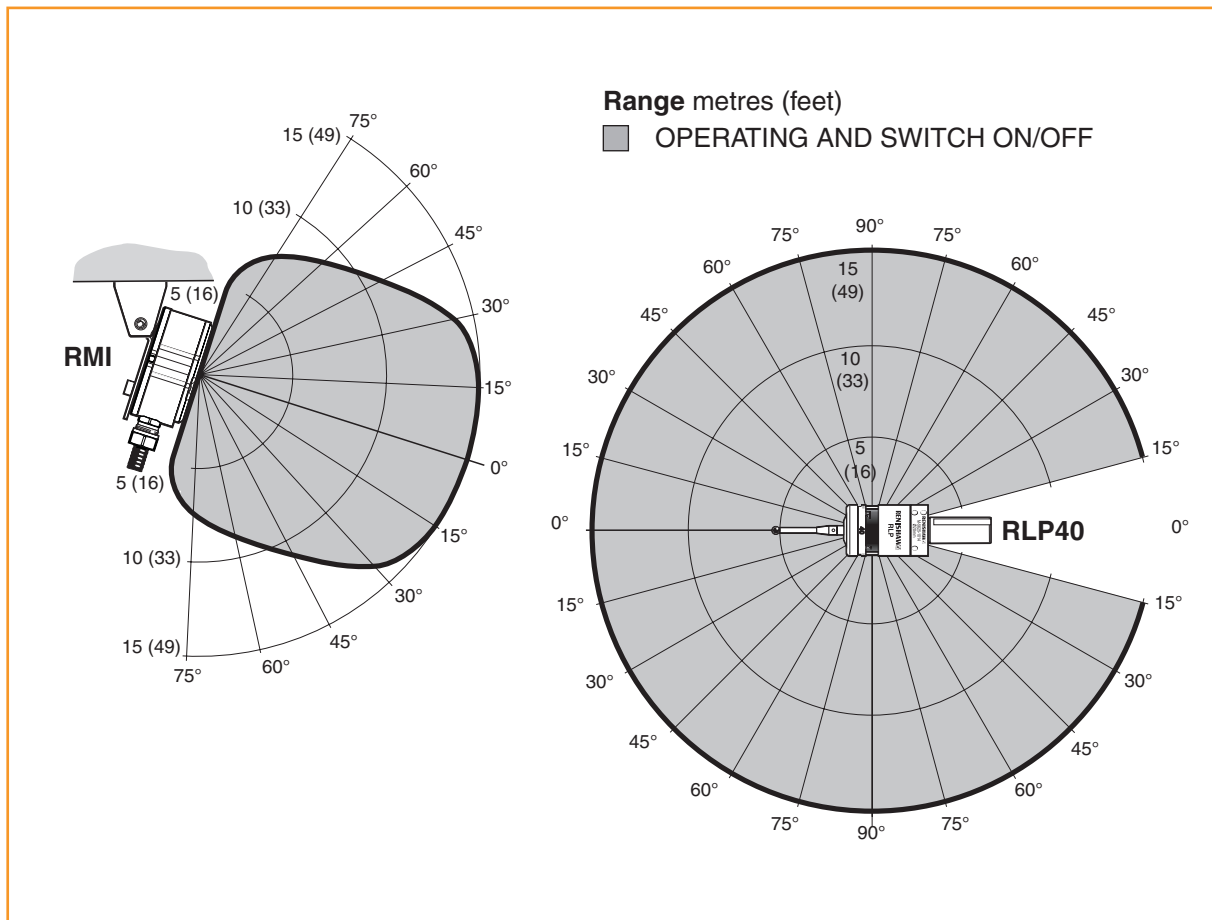

Preparing the RLP40 for use

Fitting the stylus

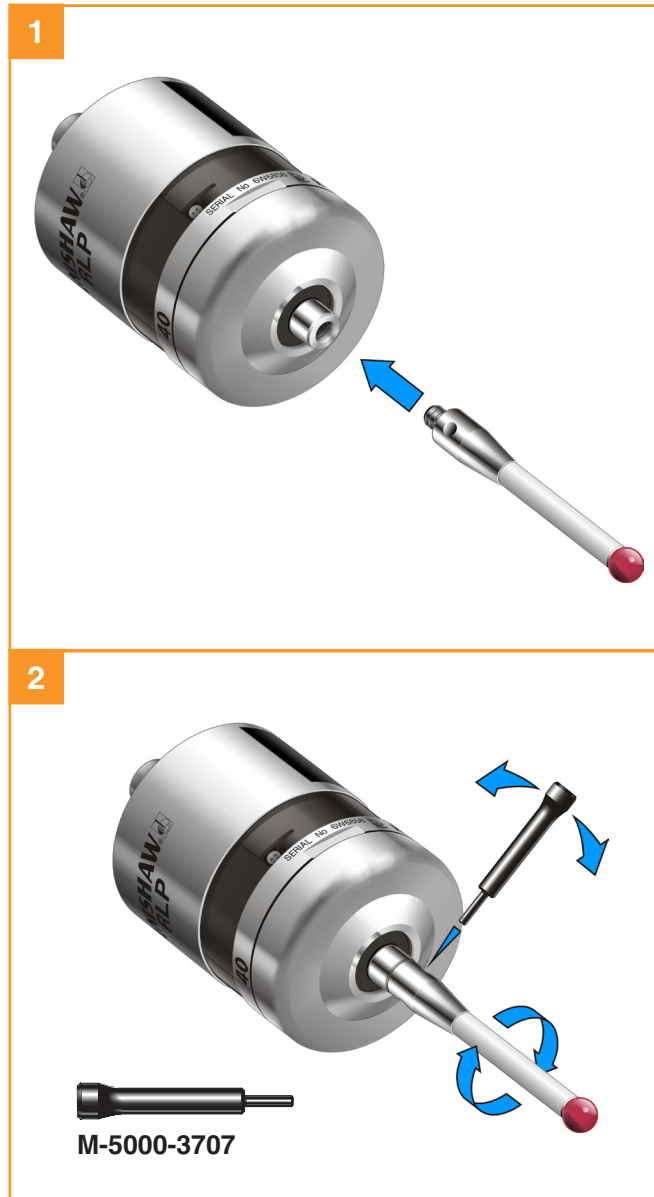

Installing the batteries

1



NOTES:

See **Section 5 - Maintenance** for list of suitable battery types.

When inserting batteries, check that the battery polarity is correct.

If dead batteries are inadvertently inserted into the probe then the LEDs will remain a constant red, see page 4.4.

Do not allow coolant or debris to enter the battery compartment.

After inserting the batteries the LEDs will display the current probe settings (for details see **Section 4 - Trigger Logic™**).

2



Please remove battery isolation device from the battery compartment, before use.

3



Mounting the probe on a shank

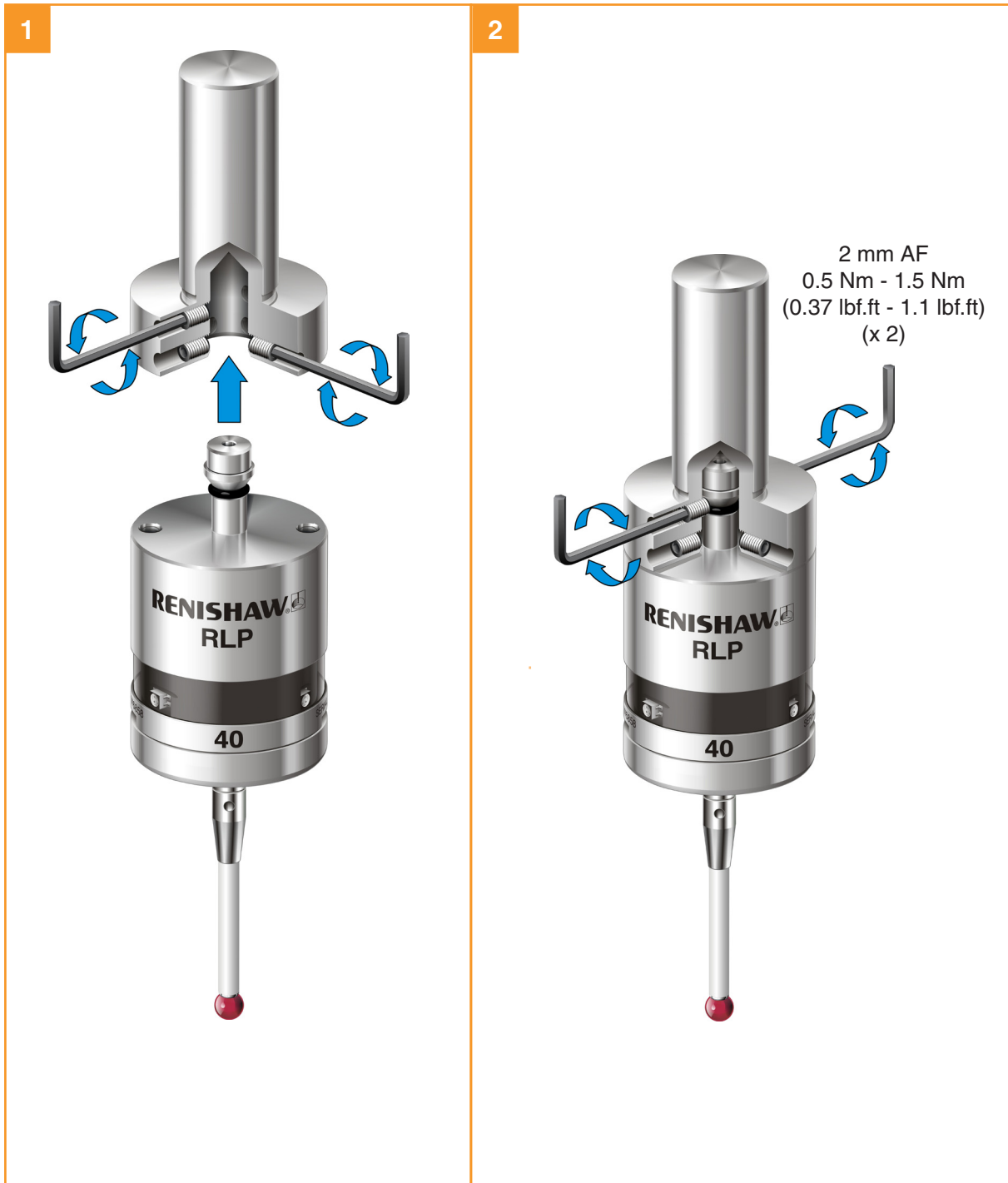

Stylus on-centre adjustment

NOTES:

If a probe and shank assembly is dropped, it must be rechecked for correct on-centre adjustment.

Do not hit or tap the probe to achieve on-centre adjustment.

1

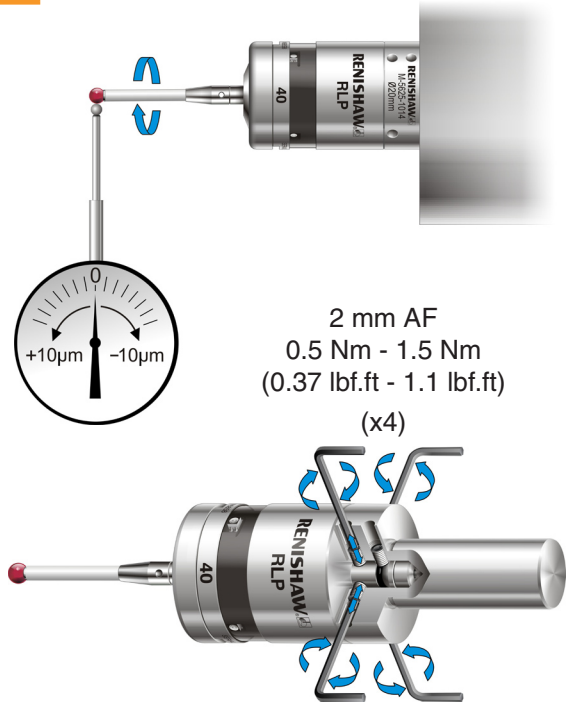

2

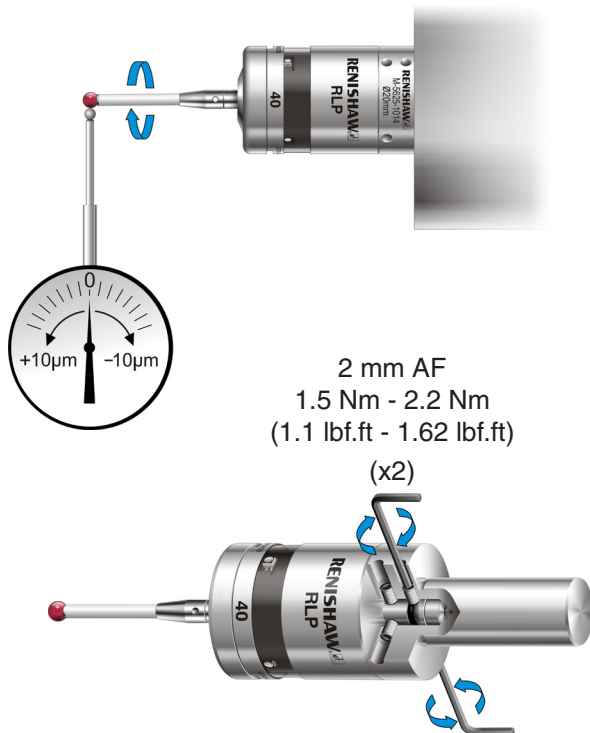

3

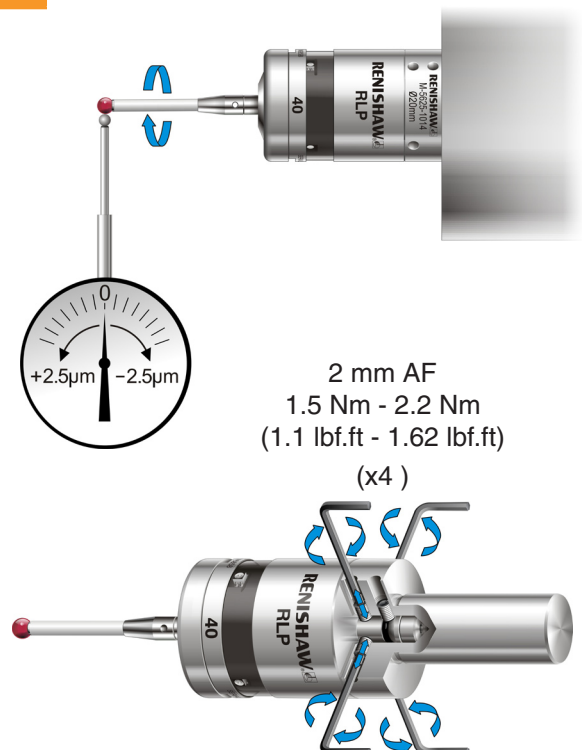

Stylus trigger force adjustment

Spring force within the probe causes the stylus to sit in a unique position and return to this position following each stylus deflection.

Stylus trigger force is set by Renishaw. The user should only adjust trigger force in special circumstances e.g. where there is excessive machine vibration or insufficient force to support the stylus weight.

To adjust the trigger force, turn the adjusting screw anticlockwise (as shown) to reduce the force (more sensitive); eventually it reaches a stop. Turn the adjusting screw clockwise (as shown) to increase the force (less sensitive). If the internal screw becomes disengaged, remove any pressure on the stylus and turn the key anticlockwise to re-engage the thread.

Trigger forces in the XY plane vary around the stylus and depend on trigger direction.

Stylus trigger force adjustment and use of styli other than test stylus types may cause probe repeatability to differ from the calibration certificate results.

Factory setting

XY low force	0.4 N / 40 gf (1.4 ozf)
XY high force	0.8 N / 80 gf (2.8 ozf)
Z	5.3 N / 530 gf (18.7 ozf)

Maximum setting

XY low force	0.8 N / 80 gf (2.8 ozf)
XY high force	1.6 N / 160 gf (5.6 ozf)
Z	10.0 N / 1000 gf (36.3 ozf)

Minimum setting

XY low force	0.3 N / 30 gf (1.1 ozf)
XY high force	0.6 N / 60 gf (2.1 ozf)
Z	4.0 N / 400 gf (14.1 ozf)

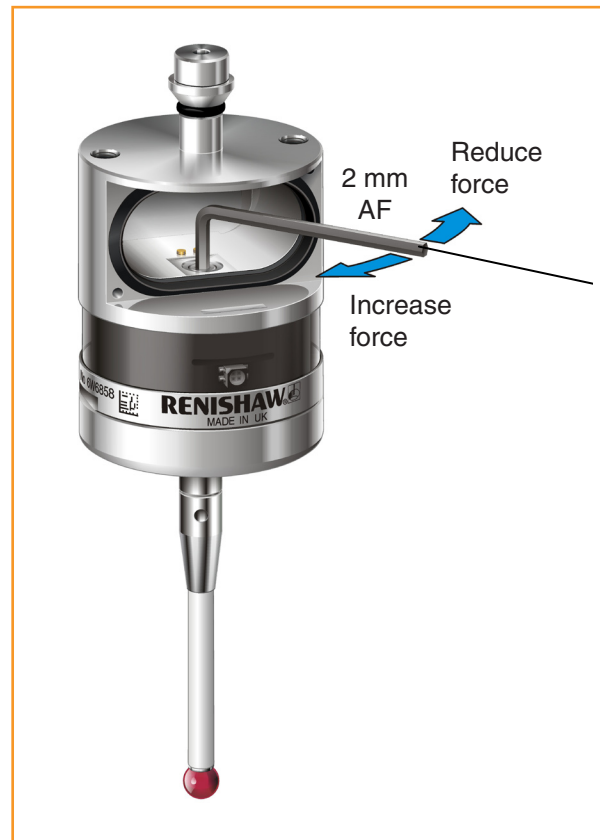

Calibrating the RLP40

Why calibrate a probe?

A spindle probe is just one component of the measurement system which communicates with the machine tool. Each part of the system can introduce a constant difference between the position that the stylus touches and the position that is reported to the machine. If the probe is not calibrated, this difference will appear as an inaccuracy in the measurement. Calibration of the probe allows the probing software to compensate for this difference.

During normal use, the difference between the touch position and the reported position does not change, but it is important that the probe is calibrated in the following circumstances:

- when a probe system is to be used for the first time;
- when a new stylus is fitted to the probe;
- when it is suspected that the stylus has become distorted or that the probe has been crashed;
- at regular intervals to compensate for mechanical changes of your machine tool;
- if repeatability of relocation of the probe shank in the machine spindle is poor. In this case, the probe may need to be recalibrated each time it is selected.

It is good practice to set the tip of the stylus on-centre, because this reduces the effect of any variation in spindle and tool orientation (see page 3.6). A small amount of run-out is acceptable, and can be compensated for as part of the normal calibration process.

Three different operations are to be used when calibrating a probe. They are:

- calibrating either in a bored hole or on a turned diameter of known size;
- calibrating either in a ring gauge or on a datum sphere;
- calibrating the probe length.

Calibrating in a bored hole or on a turned diameter

Calibrating a probe, either in a bored hole or on a turned diameter of known size, automatically stores offset values between actual and theoretical stylus ball position and also the electronic ball radius of the stylus of the stylus being used. The stored values are then used automatically in the measuring cycles. Measured values are compensated by these offsets so that positional and size measurements relative to spindle centre line are accurate.

Calibrating in a ring gauge or on a datum sphere

Calibrating a probe either in a ring gauge or on a datum sphere with a known diameter automatically stores one or more value for the radius of the stylus ball. The stored values are then used automatically by the measuring cycles to give the true size of the feature. The values are also used to give true positions of single surface features.

NOTE: The stored radius values are based on the true electronic trigger points. These values are different from the physical sizes.

Calibrating the probe length

Calibrating a probe on a known reference surface automatically stores the position of the stylus ball (probe length or geometry offset) relative to either a turret or workpiece reference face.





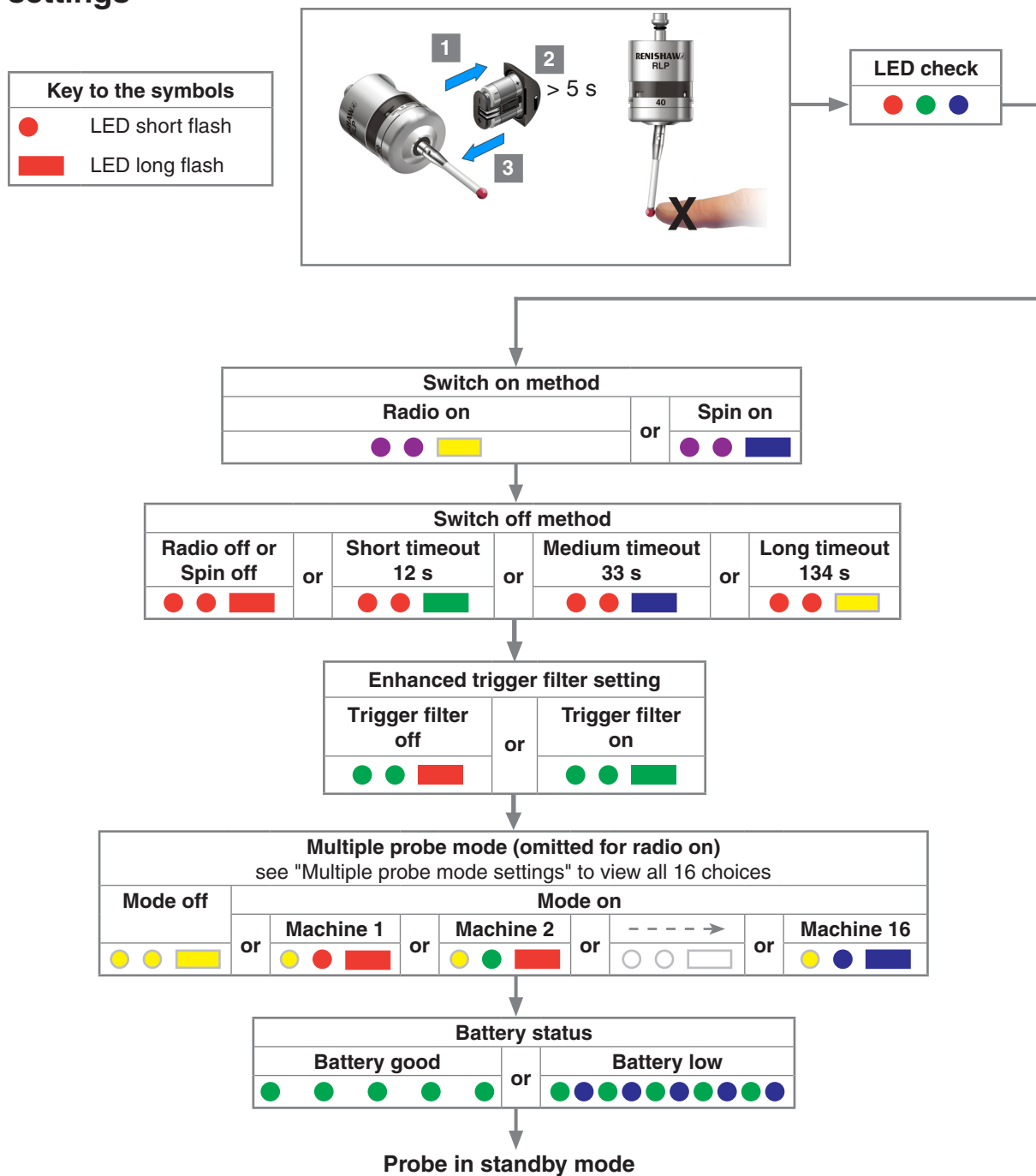



Trigger Logic™

Reviewing the current probe settings



Probe settings record

This page is provided to note your probe's settings.

			✓ tick	✓ tick
			Factory settings	New settings
Switch on method	Radio on		✓	
	Spin on			
Switch off method	Radio or spin		✓	
	Short timeout (12 s)			
	Medium timeout (33 s)			
	Long timeout (134 s)			
Enhanced trigger filter	Trigger filter off		✓	
	Trigger filter on			
Multiple probe mode	Off (factory set)		✓	
	On (machine number)	See "Multiple probe settings"		

Changing the probe settings

Insert the batteries or, if they have already been installed, remove them for five seconds and then refit them.

Following the LED check, immediately deflect the stylus and hold it deflected until five red flashes have been observed (if the battery power is low then each of the five red flashes will be followed by a blue flash).

Keep the stylus deflected until the "Switch on method" setting is displayed, then release the stylus. The probe is now in configuration mode and Trigger Logic™ is activated.

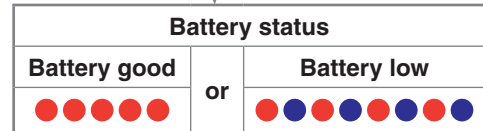
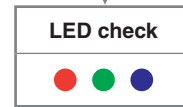
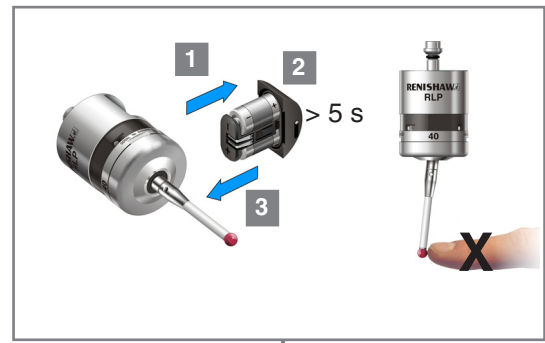

Key to the symbols	
●	LED short flash
	LED long flash
➡	Deflect the stylus for less than 4 seconds to move to the next menu option.
➡	Deflect the stylus for more than 4 seconds to move to the next menu.
➡	To exit, leave the stylus untouched for more than 20 seconds.

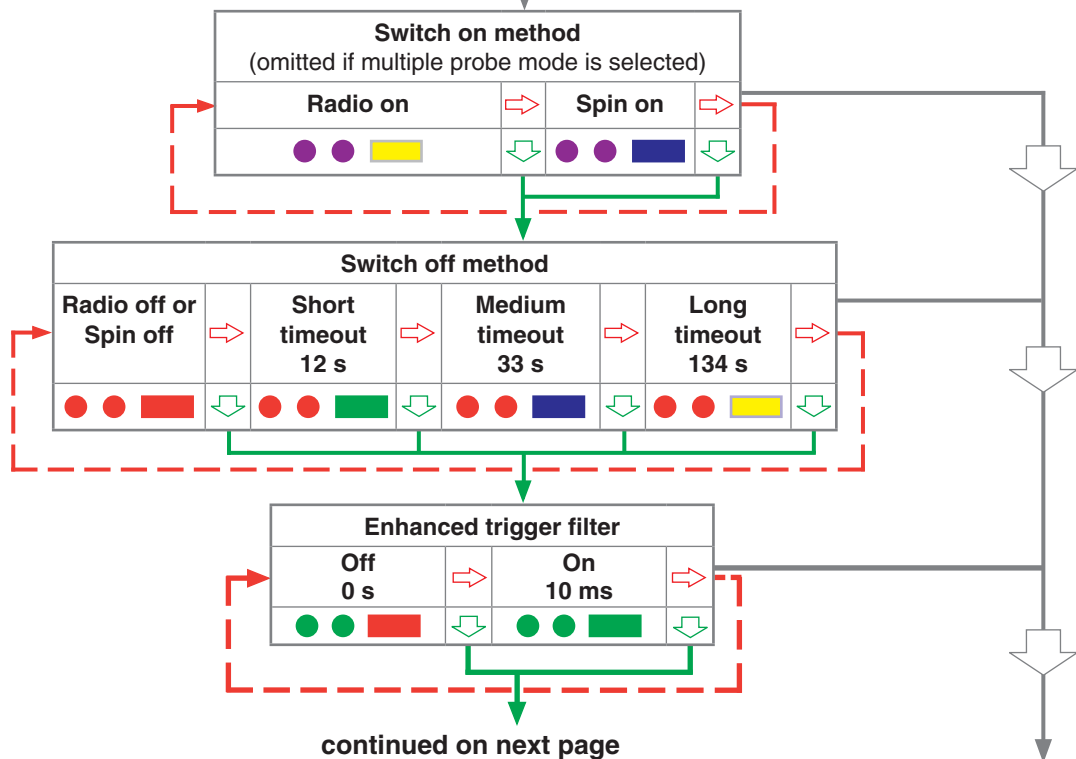

continued on next page

NOTE: To partner an RLP40 with an RMI please see "RLP40 – RMI partnership". Once acquisition has been successful, the RLP40 will revert to 'Acquisition mode off'.

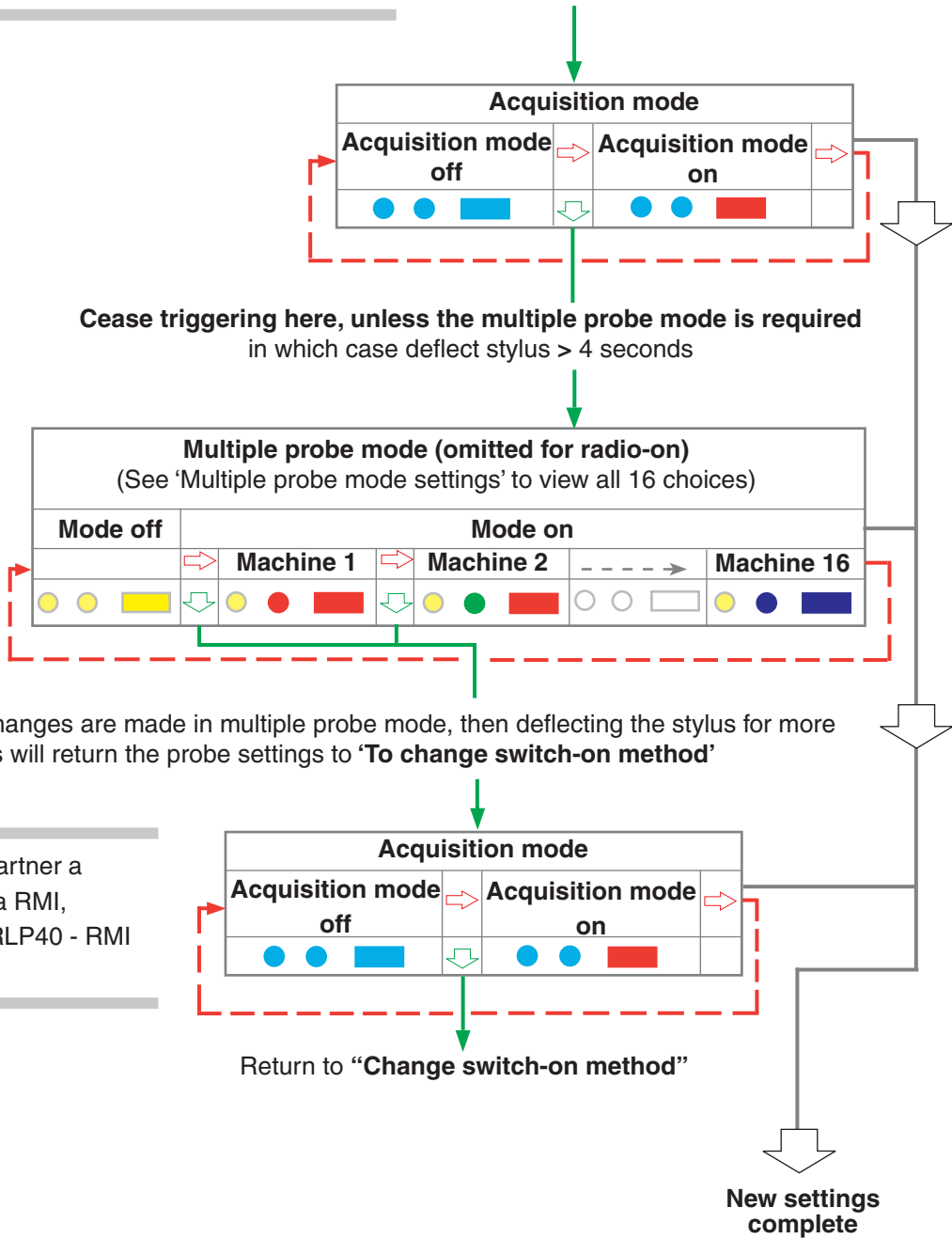

NOTE: To partner a RLP40 with a RMI, please see RLP40 - RMI partnership.

NOTE: Further probes used require the same multiple probe mode setting, but do not need to be partnered with the RMI.

RLP40 – RMI partnership

System set-up is achieved using Trigger Logic™ and powering the RMI. Partnering is only required during initial system set-up. Further partnering is only required if either the RLP40 or RMI is changed, or a system is reconfigured for multiple probes (multiple probe mode).

Partnering will not be lost by reconfiguring the probe settings or when changing batteries, except where multiple probe mode is selected. Partnering can take place anywhere within the operating envelope.

In configuration mode, configure the probe settings as required until you reach the "Acquisition mode" menu. Select "Acquisition mode off".

NOTE: Once in 'Acquisition mode off', ensure the next two steps are completed within 20 seconds.

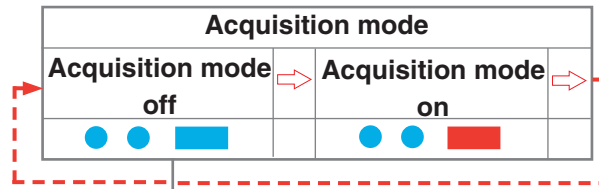

Switch on the RMI

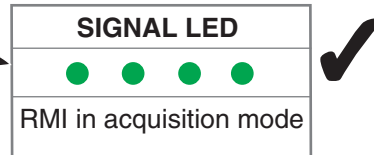

Deflect the stylus to select 'Acquisition mode on'. Ensure this is done within 10 seconds of the RMI signal LED flashing green.

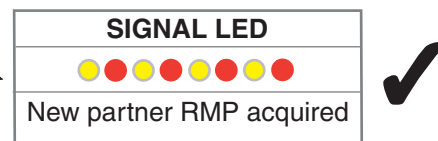



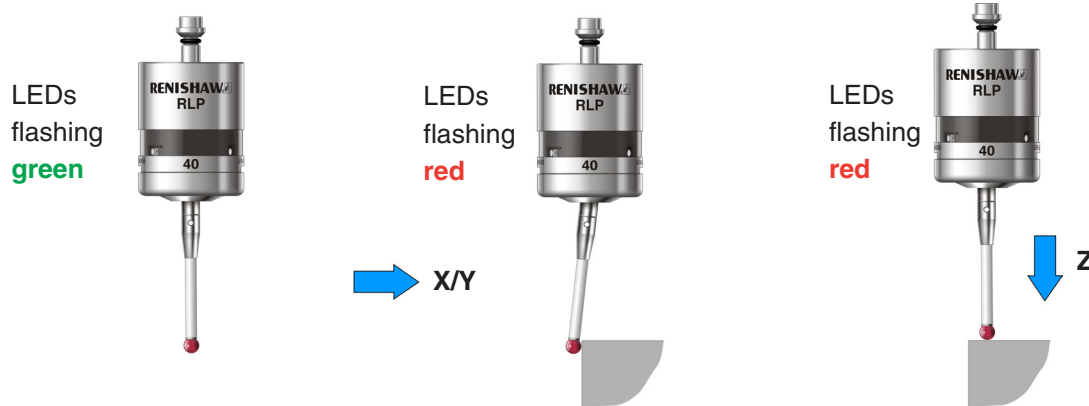

The probe is in stand-by and the system is ready for use.

Operating mode

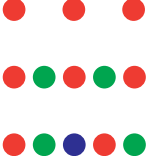

Probe status LEDs

LED colour	Probe status	Graphic hint
Flashing green	Probe seated in operating mode	
Flashing red	Probe triggered in operating mode	
Flashing green and blue	Probe seated in operating mode – low battery	
Flashing red and blue	Probe triggered in operating mode – low battery	
Constant red	Battery dead	
Flashing red or Flashing red and green or Sequence when batteries are inserted	Unsuitable battery	

NOTE: Due to the nature of Lithium Thionyl Chloride batteries, if a 'low battery' LED sequence is ignored or overlooked, then it is possible for the following sequence of events to occur:

1. When the probe is active, the batteries discharge until battery power becomes too low for the probe to operate correctly.
2. The probe stops functioning, but then reactivates as the batteries recover sufficiently to provide the probe with power.
3. The probe begins to run through the LED review sequence (see page 4.1).
4. Again, the batteries discharge and the probe ceases to function.
5. Again, the batteries recover sufficiently to provide the probe with power, and the sequence is repeated.

This page left intentionally blank

Maintenance

Maintenance

You may undertake the maintenance routines described in these instructions.

Further dismantling and repair of Renishaw equipment is a highly specialised operation, which must be carried out at authorised Renishaw Service Centres.

Equipment requiring repair, overhaul or attention under warranty should be returned to your supplier.

Cleaning the probe

Wipe the window of the probe with a clean cloth to remove machining residue. This should be done on a regular basis to maintain optimum transmission.



Changing the batteries



⚠ CAUTIONS:

Do not leave exhausted batteries in probe.

When changing batteries, do not allow coolant or debris to enter the battery compartment.

When changing batteries, check that the battery polarity is correct.

Take care to avoid damaging the battery cassette gasket.

Only use specified batteries (page 5.3).

⚠ CAUTIONS:

Please dispose of exhausted batteries in accordance with local regulations.

Never dispose of batteries in a fire.

NOTES:

After removing the old batteries, wait more than 5 seconds before inserting the new batteries.

Do not mix new and used batteries or battery types, as this will result in reduced life and damage to the batteries.

Always ensure that the cassette gasket and mating surfaces are clean and free from dirt before reassembly.

If dead batteries are inadvertently inserted into the probe, the LEDs will remain a constant red.



Battery type

½ AA Lithium Thionyl Chloride (3.6 V) x 2



Ecocel: EB1426
Saft: LS 14250C,
LS 14250
Tadiran: SL-750
Xeno: XL-050F



Dubilier: SB-AA02
Maxell: ER3S
Sanyo: CR 14250SE
Tadiran: SL-350, SL-550
TL-4902 TL-5902,
TL-2150, TL-5101
Varta: CR 1/2 AA

RLP40 eyelid

The RLP40 is fitted with a metal eyelid that protects the internal components of the probe from hot chip and coolant environment. Dirt may accumulate in the cavity underneath the metal eyelid seal.

To remove this dirt, once a month, remove the front cap (using a coin or flat blade screwdriver) and then remove all of the residue with a low-pressure jet of coolant.

Do not use a sharp tool or a degreasing agent. The cleaning interval may be extended or reduced, depending on the rate dirt accumulates. If the inner diaphragm is damaged, return the probe to your supplier for repair.

Re-assembling the probe

DO NOT use the probe with the cap removed. Check that the probe is firmly secured in its mounting.



Fault finding

Symptom	Cause	Action
Probe fails to power up (no LEDs illuminated or fails to indicate current probe settings).	Dead batteries.	Change batteries.
	Wrong batteries.	Change batteries.
	Batteries inserted incorrectly.	Check battery insertion/polarity.
	Batteries removed for too short a time and probe has not reset.	Remove batteries for a minimum of 5 seconds.
Probe fails to switch on.	Dead batteries.	Change batteries.
	Batteries inserted incorrectly.	Check battery insertion/polarity.
	Probe out of range.	Check position of RMI, see operating envelope.
	No RMI 'start/stop' signal (radio on mode only).	Check RMI for green start LED.
	Incorrect spin speed (spin switch on only).	Check spin speed and duration.
	Incorrect switch on method configured.	Check configuration and alter as required.
	Incorrect multiple probe mode setting configured.	Check configuration and alter as required.
	RLP40 in hibernation mode (radio on mode only).	Ensure probe is in range and wait up to 30 seconds, then resend switch on signal. Check position of RMI, see operating envelope.

Symptom	Cause	Action
Machine stops unexpectedly during a probing cycle.	Radio link failure/RLP40 out of range.	Check interface/receiver and remove obstruction.
	RMI receiver/machine fault.	Refer to receiver/machine user's guide.
	Dead batteries.	Change batteries.
	Probe unable to find target surface.	Check that part is correctly positioned and that stylus has not broken.
	Stylus not given sufficient time to settle from a rapid deceleration.	Add a short dwell before the probing move (length of dwell will depend on stylus length and rate of deceleration). Maximum dwell is one second.
Probe crashes.	Workpiece obstructing probe path.	Review probing software.
	Probe length offset missing	Review probing software.

Symptom	Cause	Action
Poor probe repeatability and/or accuracy.	Debris on part or stylus.	Clean part and stylus.
	Poor tool change repeatability.	Redatum probe after each tool change.
	Loose probe mounting on shank or loose stylus.	Check and tighten as appropriate.
	Calibration out of date and/or incorrect offsets.	Review probing software.
	Calibration and probing speeds not the same.	Review probing software.
	Calibration feature has moved.	Correct position.
	Measurement occurs as stylus leaves surface.	Review probing software.
	Measurement occurs within the machine's acceleration and deceleration zone.	Review probing software and probe filter settings.
	Probing speed too high or too slow.	Perform simple repeatability trials at various speeds.
	Temperature variation causes machine and workpiece movement.	Minimise temperature changes.
	Machine tool faulty.	Perform health checks on machine tool.
RLP40 status LEDs do not correspond to RMI status LEDs.	Radio link failure – RLP40 out of RMI range.	Check position of RMI, see operating envelope.
	RLP40 has been enclosed/shielded by metal.	Remove from obstruction.
	RLP40 and RMI are not partnered.	Partner RLP40 and RMI.

Symptom	Cause	Action
RMI error LED lit during probing cycle.	Probe not switched on or probe timed out.	Change setting. Review turn off method.
	Probe out of range.	Check position of RMI, see operating envelope.
RMI low battery LED lit.	Low batteries.	Change batteries soon.
Reduced range.	Local radio interference.	Identify and remove.
Probe fails to switch off.	Incorrect switch off method configured.	Check configuration and alter as required.
	No RMI 'start/stop' signal (radio on mode only).	Check RMI for green start LED.
	Probe in timeout mode and placed in tool magazine and is being triggered by movement.	Use shorter timeout setting or use different switch off mode.
	Incorrect spin speed (spin turn on only).	Check spin speed.
Probe goes into Trigger Logic™ configuration mode and cannot be reset.	Probe was triggered when batteries were inserted.	Do not touch the stylus or stylus mounting face during battery insertion.

Parts list

Type	Part number	Description
RLP40	A-5627-0001	RLP40 probe with batteries, tool kit and quick-start guide (factory set to radio on/radio off, trigger filter off).
Battery	P-BT03-0007	1/2 AA Lithium Thionyl Chloride (LTC) batteries pack of two.
Stylus	A-5000-3709	PS3-1C ceramic stylus 50 mm long with Ø6 mm ball.
Weak link kit	A-2085-0068	Weak link (Part no. M-2085-0069 x 2) and 5 mm AF spanner.
Tool kit	A-4038-0304	Probe tool kit comprising Ø1.98 mm stylus tool, 2.0 mm AF hexagon key, 2.5 mm AF hexagon key (x 2), 4.0 mm AF hexagon key (x 2) and shank grub screw (x 2).
Service kit	A-5625-0005	RLP40 eyelid service kit.
Battery cassette	A-4071-1166	RLP40 battery cassette assembly.
Cassette seal	A-4038-0301	Battery cassette housing seal.
RMI	A-4113-0050	RMI – side exit – with 15 m (49.2 ft) cable, tool kit and user's guide.
Mounting bracket	A-2033-0830	Mounting bracket with fixing screws, washers and nuts.
Stylus tool	M-5000-3707	Tool for tightening/releasing styli.
Publications. These can be downloaded from our web site at www.renishaw.com		
RLP40	A-5627-8501	Quick-start guide: for rapid set-up of the RLP40 probe, includes CD with installation guide.
Styli	H-1000-3200	Technical specification: Styli and accessories.
Software features	H-2000-2298	Data sheet: Probe software for machine tools – illustrated features.
Software list	H-2000-2298	Data sheet: Probe software for machine tools – list of programs.
RMI	H-2000-5220	Installation and user's guide: RMI – radio machine interface.

This page left intentionally blank

Renishaw plc
New Mills, Wotton-under-Edge,
Gloucestershire, GL12 8JR
United Kingdom

T +44 (0)1453 524524
F +44 (0)1453 524901
E uk@renishaw.com
www.renishaw.com

RENISHAW 
apply innovation™

**For worldwide contact details,
please visit our main website at
www.renishaw.com/contact**



H - 5627 - 8504 - 01