

RICCAR®

1500P

Owner's Manual



IMPORTANT SAFETY INSTRUCTIONS

Read All Instructions Carefully Before Using This Appliance

When using an electrical appliance, basic precautions should always be followed, including the following :

WARNING - To reduce the risk of fire, electric shock, or injury :

1. Do not leave appliance when plugged in. Unplug from outlet when not in use and before servicing.
2. Do not use outdoors or on wet surfaces.
3. Do not allow to be used as a toy. Close attention is necessary when used near children.
4. Use only as described in this manual. Use only manufacturer's recommended attachments.
5. Do not use with damaged cord or plug. If appliance is not working as it should, has been dropped, damaged, left outdoors, or dropped into water, return it to a service center.
6. Do not pull or carry by cord, use cord as a handle, close a door on cord, or pull cord around sharp edges or corners. Do not run appliance over cord.
Keep cord away from heated surfaces.
7. Do not unplug by pulling on cord. To unplug, grasp the plug, not the cord.
8. Do not handle plug or appliance with wet hands.
9. Do not put any object into openings. Do not use with any opening blocked:
keep free of dust, lint, hair, and anything that may reduce air flow.
10. Keep hair, loose clothing, fingers, and all parts of body away from openings and moving parts.
11. Turn off all controls before unplugging.
12. Use extra care when cleaning on stairs.
13. Do not use to pick up flammable or combustible liquids such as gasoline or use in areas where they may be present.
14. This appliance is intended for household use only and not for commercial or industrial use.
15. Do not operate the vacuum if :
 - the power cord is damaged.
 - the hose shows visible signs of damage.
16. Do not use without vacuum bag and/or filters in place.
17. Hold plug when rewinding the cord into cord reel. Do not allow plug to whip when rewinding.
18. The hose contains electrical wires. Do not use if damaged, cut or punctured.
Avoid picking up sharp objects.
19. To reduce the risk of electric shock, this appliance has a polarized plug.
20. Do not pick up anything that is burning or smoking, such as cigarettes, matches, or hot ashes.
21. Always turn off this appliance before connecting or disconnecting motorized nozzle.
22. Use only with motorized nozzle model RPB-220.

SAVE THESE INSTRUCTIONS

CONTENTS

DESCRIPTION AND USING	4~5
HOW TO POWER NOZZLE	6~9
SAFETY PRECAUTIONS	10
REPLACING BAGS & FILTERS	11
TROUBLESHOOTING GUIDE	12

DESCRIPTION AND USING

FULL BAG INDICATOR

How to check the FULL BAG INDICATOR:

- If the red indicator appears:
 - Empty the vacuum bag.
 - If the vacuum bag isn't full and the full bag indicator is red, check the hose for a clog.
- When cleaning with a tool (dusting brush, upholstery nozzle, crevice tool, floor tool), the red indicator may appear. In this case, continue cleaning.

HOSE ADAPT

- When separating the hose from the hose adapter while pressing the

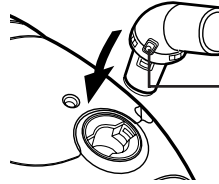

HOSE HANDLE

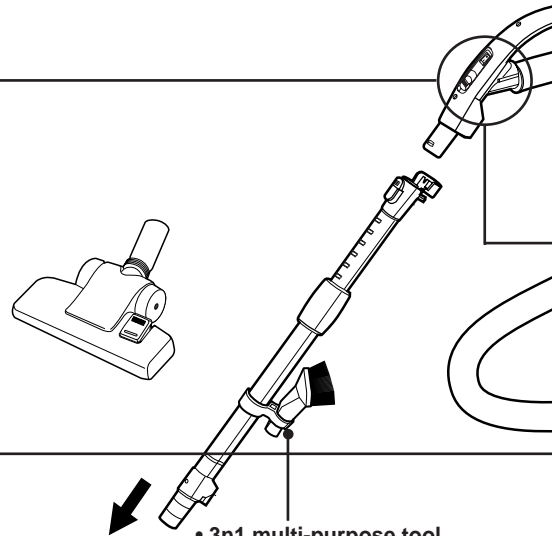
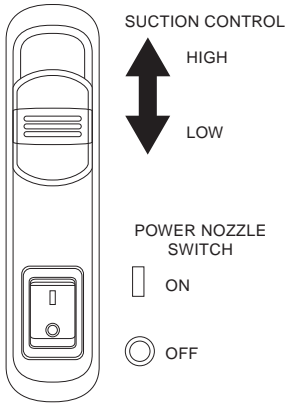

- **3-in-1 multi-purpose tool**
Insert end of wand into either end of tool for multiple cleaning functions.

HARD SURFACE FLOOR TOOL

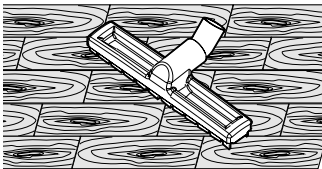

- For use on tile, hard wood, and linoleum floors



Power Nozzle

CLE

Dusting Brush Upholstery Nozzle

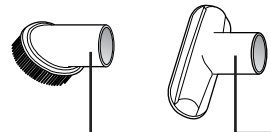

ADAPTER

the body, pull the
e buttons.



– Adapter button

CORD REWIND

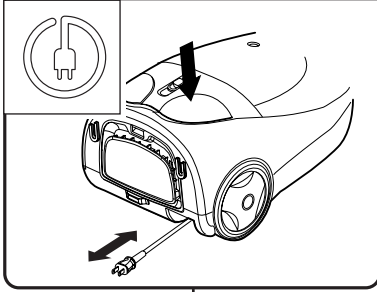

ON/OFF SWITCH

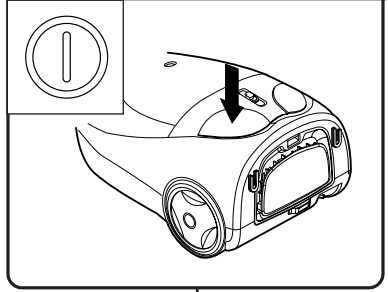

Power control is
on the canister body
not the handle

POWER CONTROL

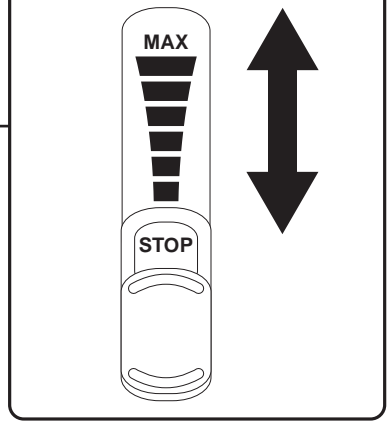

CLEANING TOOLS

le Crevice Tool

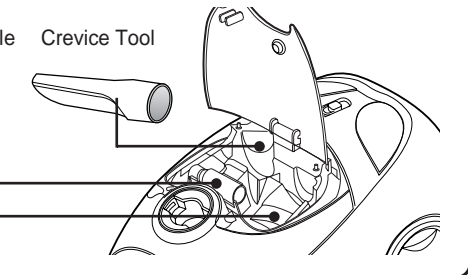

STORAGE

- Insert the brush holder on the neck of the wand into the groove.

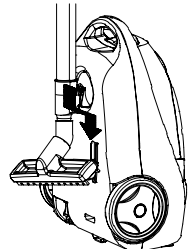

HOW TO USE POWER NOZZLE

OPERATION

1. Turning on the Power Nozzle

The power nozzle can only be turned on if the canister is also turned on (canister on / off switch is located on the main body). The power nozzle on / off switch is located on the handle. Simply press the switch forward to engage the power nozzle.

To achieve best cleaning results, slowly pass the power nozzle back and forth over the carpet or floor.

2. Using the Power Nozzle

After turning on the canister and power nozzle, release the wand by pressing the left pedal on the back side of the power nozzle (see diagram 3)

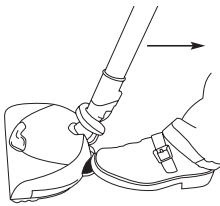

Diagram 3



Diagram 4

3. Remove / Insert the Wand From The Power Nozzle

Removing the wand from the power nozzle allows you, for example, to use cleaning tools for baseboard or ceiling cleaning. To do this, first turn the power nozzle and canister off. Then, press the wand release collar (see diagram 5) and pull the wand out. To reinsert the wand into the power nozzle, simply press the wand back into the neck of the power nozzle. The wand will then "click" back into place.

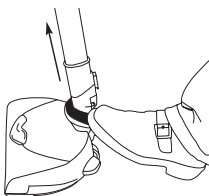

Diagram 5

4. Carpet Height Adjustment

Your power nozzle has six different settings to clean a variety of carpet types and floor surfaces. To adjust the carpet height setting of the power nozzle, press the right pedal located on the back of the power nozzle (see diagram 6). Each press of this pedal will adjust the height to the next carpet height position.

To determine which setting you are currently on, locate and look through the height indicator window on the top of the unit (see diagram 7). You will see one of the six settings as mentioned earlier and detailed below:

Setting: Intended Use:

- | | |
|---------|---|
| 1. XHI | Very plush carpet |
| 2. HI | Plush carpet |
| 3. Auto | General carpet thickness or bare floors |
| 4. MED | Medium pile carpet |
| 5. LO | Low pile carpet |
| 6. XLO | Indoor/Outdoor carpet |

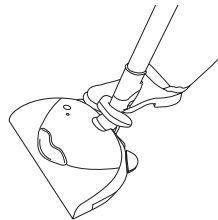

Diagram 6

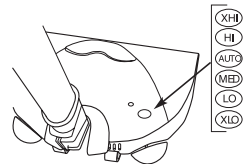

Diagram 7

Carpet Height Notes: When using the power nozzle, start on the "auto" setting. If pushing the power nozzle forward feels sluggish or hard to push, then adjust to a higher setting (i.e. HI or XHI). If the power nozzle feels very easy to push, you may want to lower the power nozzle for more effective cleaning. The "Auto" setting is the recommended setting for hard floor surfaces (i.e. tile, vinyl, wood).

OPERATION

5. Warning Light

Your power nozzle comes equipped with a circuit breaker safety system that protects it from a jammed power nozzle situation. Common items that cause jammed brushrolls include socks, excessive threads, corners of area rugs, etc. The warning indicator light on top of the unit (see diagram 8) will change from green to red should this condition occur.

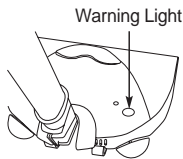

Diagram 8

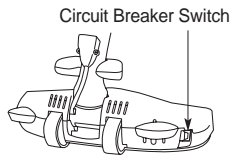

Diagram 9

If the circuit breaker trips:

- Turn off the vacuum cleaner and power brush then unplug the power cord.
- Remove the object preventing the brushroll from turning.
- Locate the circuit breaker switch on the back of the power nozzle and press it to reset the breaker (see diagram 9).
- When the unit is turned back on, the warning light should be green and ready to go. If the breaker trips again, repeat steps a-c again to correct the problem.

If this does not correct the problem, contact your authorized vacuum cleaner retailer for further assistance.

MAINTENANCE AND CARE

1. Removing the Brushroll

IMPORTANT: Before performing any maintenance work on the power nozzle, always unplug the vacuum cleaner and disconnect the wand.

Your brushroll may need to be removed at times, for example, to cut threads that have become tangled around the brushroll or to replace the belt (see "Replacing the Belt").

To remove the brushroll, turn the unit over and lift off the metal bottom plate by first unscrewing the two bottom plate screws located by the rear wheels (see diagram 10). Pull out the belt cover guard (see diagram 11) and pull the brushroll out.

To reinstall the brushroll, reinsert the brushroll back into the unit (make sure the belt is attached properly). Next, insert the belt cover guard. Then, place the metal bottom plate back onto the unit (insert the front end of the bottom plate first). Re-insert the two bottom plate screws and secure.

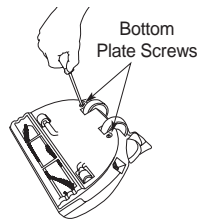

Diagram 10

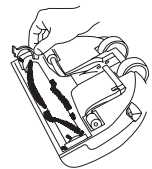

Diagram 11

MAINTENANCE AND CARE

2. Replacing the Power Nozzle Belt

IMPORTANT: Before performing any maintenance work on the power nozzle, always unplug the vacuum cleaner and disconnect the wand.

To replace the power nozzle belt, you must first remove the brushroll (see "Removing the Brushroll"). Locate and discard broken belt.

To install new belt, locate the power nozzle motor pulley and loop the belt around it (see diagram 12). Place the other end of the belt around the brushroll making sure the belt is seated in the "belt groove" of the brushroll (see diagram 13). Insert the brushroll back into the brushroll tray and place the belt guard back into position (see diagram 11). Place the metal bottom plate back onto the unit (insert the front end of the bottom plate first). Re-insert the two bottom plate screws and secure.

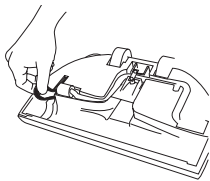

Diagram 12

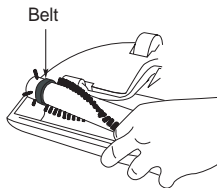

Diagram 13

3. Replacing the Bulb

IMPORTANT: Before performing any maintenance work on the power brush, always unplug the vacuum cleaner and disconnect the wand.

Turn the power brush over and remove the bottom plate by first unscrewing the two bottom plate screws located by the rear wheels (see diagram 10). Locate and remove the two top cover screws (see diagram 14). Turn the power brush back over, push the power brush neck flat, and remove the top cover (see diagram 15). Simply pull the bulb out (no twisting) and reinsert a factory-authorized bulb. Place the top cover back on the unit, turn the machine over and re-insert the two top cover screws. Reinstall the bottom plate.



Diagram 14

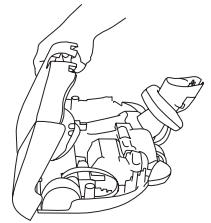

Diagram 15

DIAGRAM 1 REAR VIEW OF POWER WAND AND NOZZLE ASSEMBLY

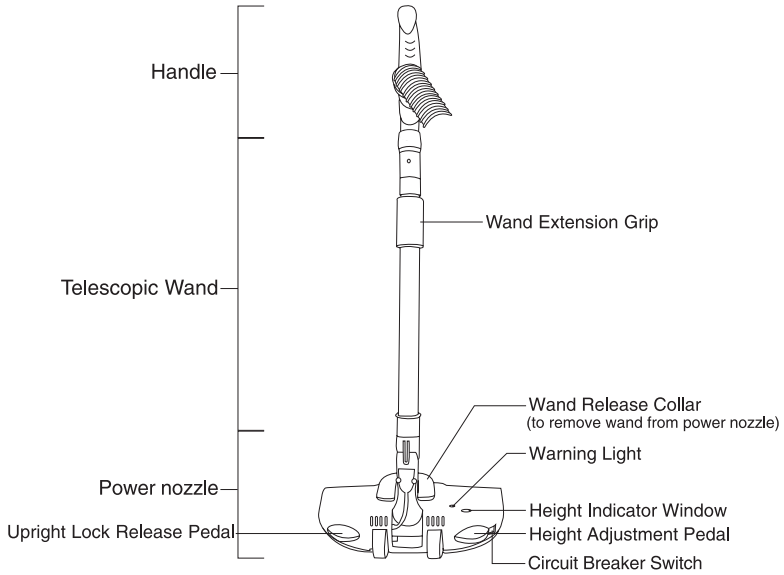
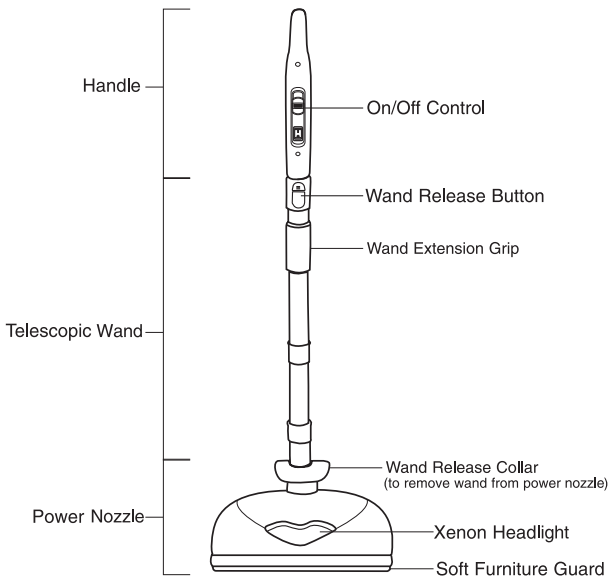

DIAGRAM 2 FRONT VIEW OF POWER WAND AND NOZZLE ASSEMBLY



SAFETY PRECAUTIONS

This vacuum cleaner should be used for normal, dry household dust and dirt.

The manufacturer cannot be held responsible for any damage caused by use or operation of the vacuum contrary to these instructions.

If the vacuum is wrongly operated for a purpose other than that for which it is intended, no liability can be accepted for any possible damage.

- Do not vacuum areas which contain moisture or water, flammable matter, needles, pins, razor blades, matches, cigarettes, etc., since they may damage the vacuum or vacuum bag.

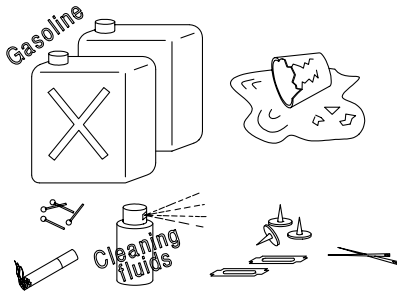

- When rewinding the power cord, hold the plug before pressing the cord rewind button to prevent the cord from whipping.

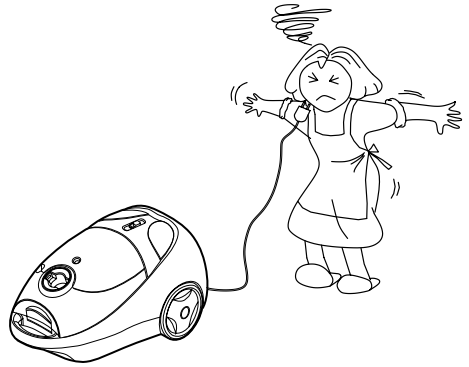

- Make sure a vacuum bag and filters are always inserted.



- This product is equipped with a polarized alternating current line plug (a plug having one blade wider than the other). This plug fits into the power outlet only one way. This is a safety feature. If you are unable to insert the plug fully into the outlet, try reversing the plug. If the plug should still fail to fit, contact an electrician to replace the obsolete outlet. Do not defeat the safety purpose of the polarized plug.

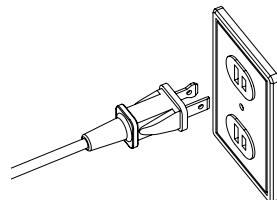

REPLACING VACUUM BAG & FILTERS

REPLACING THE VACUUM BAG

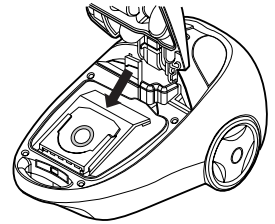
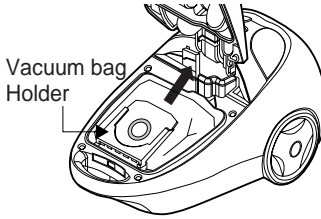
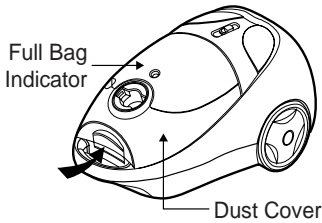

- Turn canister off, remove hose and open the dust cover.
- Pull the shutter of the vacuum bag.
- Hold the cover while removing the vacuum bag from the vacuum bag holder.
- Insert the new bag.

NOTE: We recommend the vacuum bag is changed when indicator is RED or suction power is weak. Dust cover will not close without a bag in the unit or if the bag is not fully inserted.

REPLACING THE FILTERS

Charcoal Filter

- Switch off and open the cover.
- Remove filter.
- Shake the dust out of the filter.
- Insert the filter and close the cover.

Charcoal Filter

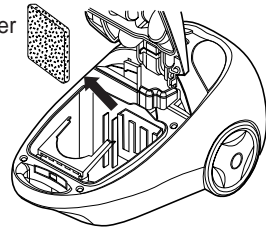

HEPA Filter

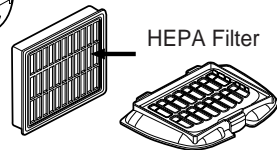
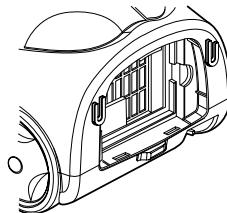
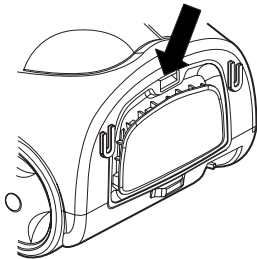

- Switch off and open the grill
- Remove the filter and replace it

TROUBLESHOOTING GUIDE

- Please check each item below if you have trouble with your vacuum.
Before checking, ensure that the vacuum is unplugged from the power supply.

Problem	Check Point	Note
<ul style="list-style-type: none"> • Suction power is weak. 	<ul style="list-style-type: none"> • Vacuum bag • Wand or hose 	<ul style="list-style-type: none"> • If vacuum bag is full, replace it. • If clogged or blocked, remove the object.
<ul style="list-style-type: none"> • The vacuum does not work. 	<ul style="list-style-type: none"> • Is the hose adapter inserted into the suction opening of the vacuum completely? • When the vacuum bag is full or any of the accessories are blocked, the over-heating protection for the motor is activated. 	<ul style="list-style-type: none"> • Insert it completely. • Switch off and unplug the vacuum and check the vacuum bag and accessories and remove any blockages. The vacuum can be switched on again after approximately 20 minutes.
<ul style="list-style-type: none"> • Power cord does not rewind. 	<ul style="list-style-type: none"> • Power cord 	<ul style="list-style-type: none"> • Pull the power cord out a little and press the cord rewind button again.
<ul style="list-style-type: none"> • Power cord won't pull out of the vacuum. 	<ul style="list-style-type: none"> • Power cord 	<ul style="list-style-type: none"> • Do not pull it by force. Rewind it a little by pressing the cord rewind button and try pulling it out again.

SPECIFICATIONS

Model	1500P
Rating	120V/60Hz
Amps	9.5A / 12A (with Power Nozzle)
Weight	15.5 Pounds
Dimension (L X W X H)	19" x 12.5" x 9.3"
Cord Length	18 feet

- Specifications can be changed for improvement without notice.
For assistance please visit www.Riccar.com or call 1-888-6-Riccar.

RICCAR®
www.riccar.com