

# User's Manual

**Model: BTS-68**

**Bluetooth Speaker  
With  
FM Radio**

**(Splash-proof)**

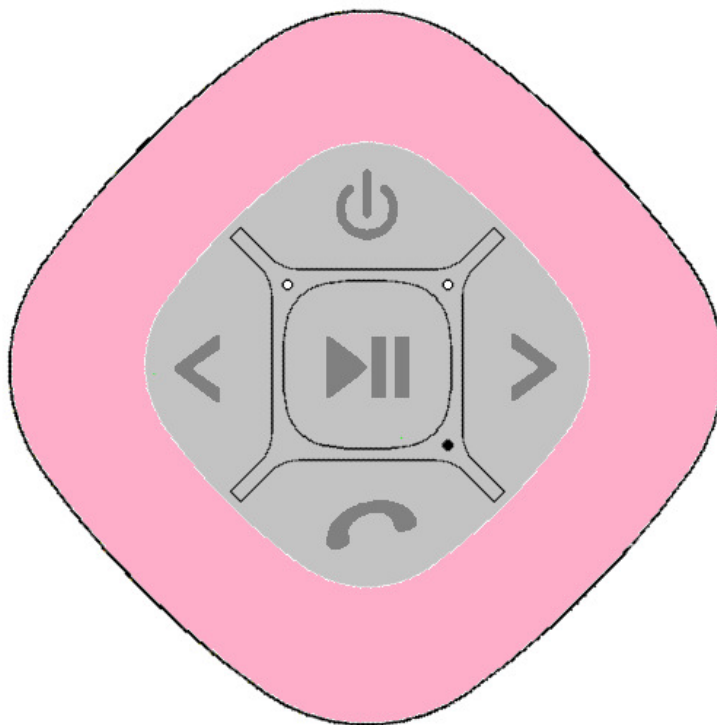

**Transmit music to your shower with our Shower Bluetooth Speaker. Splashes proof design allows for all-round bathroom usage. The hanging window design makes hanging in the shower quick and easy.**

## 1. Important

### Don'ts

- Do not place naked flames, such as lighted candles on or near the product.
- Do not place objects filled with liquids, such as vases on or near the product.
- Do not use or store this product in a place where it is subject to direct sunlight, heat, excessive dust or vibration.
- Do not keep or store this product in wet conditions for long period.
- Do not push foreign objects into the slots or holes in the product.
- Do not attempt to open this product yourself. There are no user serviceable parts inside.
- Do not allow children access to plastic bags.

### Safety Instructions

- Before using this product, read and follow all warnings and instructions.
- This product is not intended for use by young children. Young children should be properly supervised.
- This product is intended for household use only and not for commercial or industrial use.
- No naked flame sources, such as lighted candles, should be placed on the product.
- Ventilation should not be impeded by covering ventilation openings with items such as newspapers, table cloths, curtains and the like.
- Make sure the unit is adjusted to a stable position. Damage caused by using this product in an unstable position or by failure to follow any other warning or precaution contained within this user manual will not be covered by warranty.

We, suggests retaining the packaging in case for future transport of the product.

#### **WARNING:**



- Never remove the casing of this apparatus.
- Never place this apparatus on the other electrical equipment.





### Caution for Splash-proof

- This unit has been constructed to resist mild steam and light splashes from the shower or bath only. It should never be operated under running water and under no circumstances it should never be fully immersed in water.
- This unit has rubber seals to minimize the risk of moisture getting inside. However, do not immerse it in water since permanent damage to the electrical and mechanical parts will result.

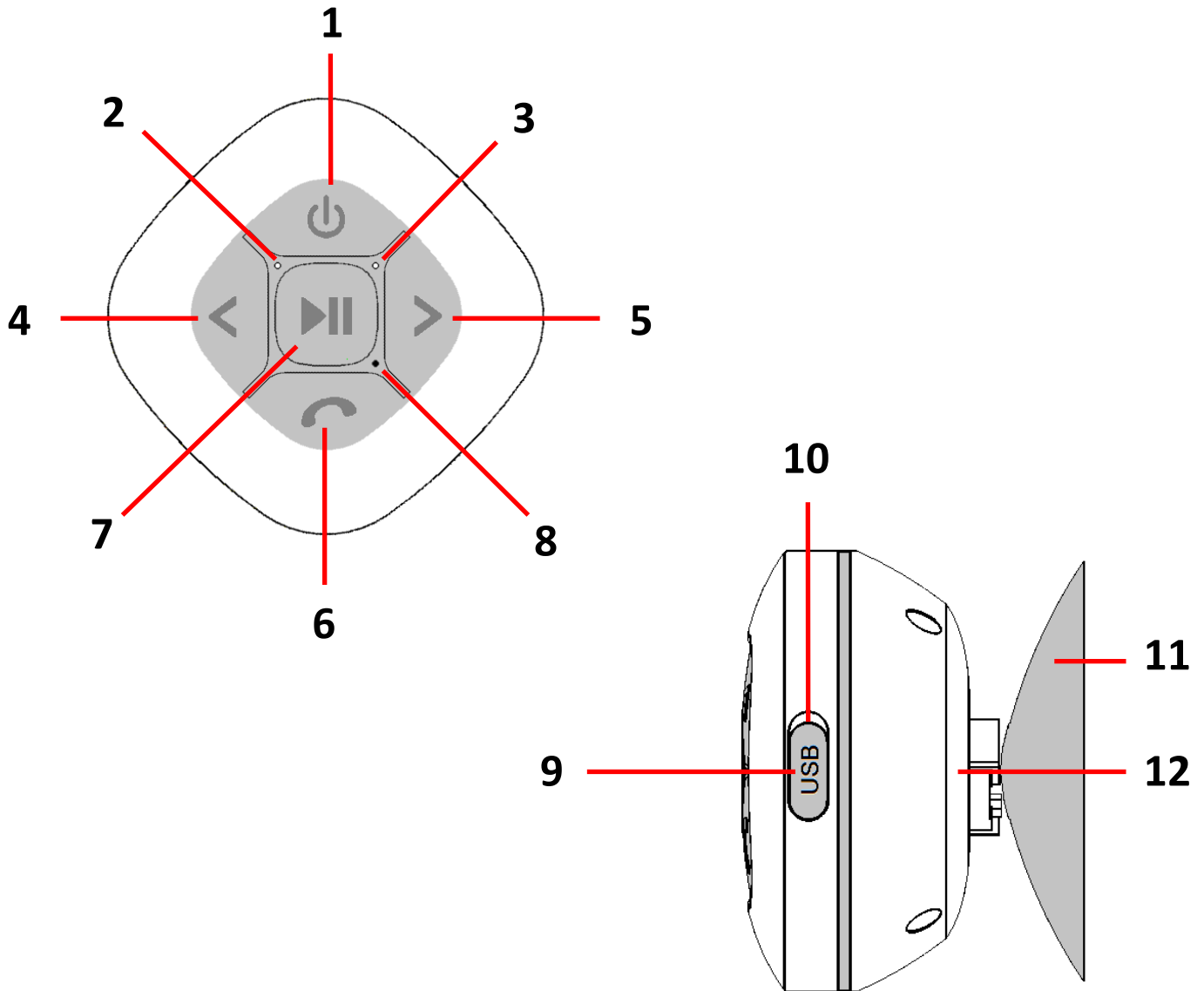
## 2. Getting Start

### A. Outlook and Controls:



Item	Control
1	 <b>Button (ON / OFF)</b>
2	<b>Charge LED Indicator (White)</b>
3	<b>Bluetooth LED Indicator (White)</b>
4	 <b>Button (Previous, Volume down / Preset station down)</b>
5	 <b>Button (Next, Volume up / Preset station up)</b>
6	 <b>Button (Hand Free, FM Mode)</b>
7	 <b>Button (Play / Pause, Radio auto search / Radio Mute)</b>
8	<b>MIC Hole</b>
9	<b>Rubber Seal Cover (Splash-proof cover)</b>
10	<b>Micro USB socket (Under Rubber Seal Cover)</b>
11	<b>Vacuum Cupule</b>
12	<b>Speaker</b>

**B. About the speaker rechargeable battery:**

1. This Bluetooth Speaker has an internal, non–user-replaceable battery. For best results, the first time you use this Bluetooth Speaker, let it charge for about **2 ~ 3 hours** or until the **“Charge LED (2)”** Indicator light from On to off which show the battery is fully charged.
2. For maintain the battery life and performance, if speaker isn’t used for a while, the battery might need to be recharged. Recharge the battery at least once per month.

**C. To recharge the built-in rechargeable battery:**

You can charge the Bluetooth Speaker’s battery in two ways:

1. Connect Bluetooth Speaker to the Computer. Or,
2. Use the USB power charger. **(not included)**

**D. Connection and Charging:**

1. Open the **“Rubber Seal Cover (10)”** and connects the Bluetooth Speaker’s **“Micro USB socket (9)”** with the Computer’s USB port through the USB cable.
2. The **“Charge LED (2)”** Indicator will turn On, the battery is in charging.
3. The **“Charge LED (2)”** Indicator will turn Off when it’s fully charged.
4. Disconnect the USB cable when it is done.

**Charging LED Function**

Item	Mode	Light Status
1.	No DC power input:	LED light Off
2.	In Charging:	Light On
3.	Charge Completed:	Light Off

**E. Power ON/OFF and Pairing:**

1. Press and hold the **“⏻ (1)”** button for 2 ~ 3 seconds to turn On the device, a series of tones will sound and the **“Bluetooth LED (3)”** indicator will light up with blinking.
2. Then, activate the Bluetooth function in your mobile Bluetooth device (such as Mobile Phone, MID or Personal Computer); the mobile device will enter to Bluetooth searching mode automatically, if not, tap the relate selection to manually enter to searching mode. *(refer to your mobile device’s manual when necessary)*
3. Your mobile Bluetooth device should show **“MRX-MW234”** in list, and then select it for pairing. Waiting for some seconds, then you will see connected message as shown on your mobile Bluetooth device when they connected and paired.
4. For some mobile Bluetooth devices, you may need to input **“0000”** as pairing password.

5. However, if pairing is successful, the “**Bluetooth LED (3)**” indicator will slow blinking each 3 ~ 4 seconds once.
6. Now, you can start to music play from the mobile device by it music player program.
7. Press and hold the “**⏻ (1)**” button to turn Off the device when it is not in use.

### Power & Mode Indicator Function:

Item	Mode	Description	Light Status
1.	Power OFF		Light Off
2.	Power ON	At Bluetooth searching mode:	light On & blinking (half second once)
		At Bluetooth paired mode	light On & blinking (3~4 seconds once)
		At Radio mode	light On & blinking
		At Radio auto search & preset mode	Light blinking fast

**Note:** In some circumstances, the Bluetooth connection may break / disconnected; such as some strong interference, beyond the connection distance or object moving in between both Bluetooth devices. However, most of devices can be reconnected in some seconds automatically, but in experience some of device may need to reconnect it by using the Bluetooth device’s list menu manually.

Besides, since there have many Bluetooth versions could be installed into difference type/brand of PCs, and also connect methods will have differences. If you cannot connect your Bluetooth devices, please install with updated Bluetooth driver into your PC or contact your dealer’s help desk for enquiry.

### F. Disconnect from paired device:

1. To disconnect with paired device and for better result, turn OFF the Bluetooth Speaker by power ON/OFF button directly.
2. Or, you can choose disconnect from the Bluetooth device’s list by the paired device, however, most devices will go back to reconnection mode in seconds. Means the Bluetooth Speaker may again reconnected with the paired device within some seconds automatically. So, turn OFF the Bluetooth function on you mobile device in this case if you want.

**Note:** The device is keep using battery energy if it is in power ON mode, Turn OFF the Bluetooth Speaker by the power button if you do not use the

*device for a while. Besides, the Bluetooth speaker will be turned to OFF automatically if it is in idle and without Bluetooth connection in few minutes.*

### **G. Auto reconnect with paired device:**

1. Every time you turn On the Bluetooth speaker power; it will firstly searching for the mobile device, which has been paired previously and still in record. The Bluetooth Speaker will reconnect this mobile device as priority if it is in Bluetooth searching device mode.
2. If not found in some seconds, the Bluetooth Speaker then is turn into new pairing mode internally.
3. Now you can process for new mobile device pairing, please refer to item E.2~5 methods mentioned above.

### **H. Bluetooth device control function:**

#### **On your Bluetooth Device:**

1. Switch to music play mode and choose music to start the play, select music by using ◀◀ / ▶▶ button/icon, Play/Pause the playing music by using ▶|| button/icon and adjust the volume level by using device's volume control " **Down / Up** " button/icon on your Bluetooth device. (refer to your device user's manual when necessary)

#### **On Bluetooth Speaker:**

1. In playing music, press "▶|| (7)" button to pause the music. To resume the music press it again.
2. Press and hold the "➤ (5)" button to increases the volume level.
3. Press and hold the "➤ (4)" button to decreases the volume level.
4. When maximum or minimum volume is reached, a series of tones will sound.
5. Press once the "➤ (5)" button to go to next music.
6. Press once the "➤ (4)" button to go to previous music.



### **I. Hand Free Function:**

1. When there is an incoming call;
2. The ringing sound will up and the playing music will pause automatically.
3. Press "☎ (6)" button to pick up the call if you want.
4. Now you have hand free function with the Bluetooth speaker.
5. Press "☎ (6)" button again to hang up the call when finished. And,
6. The paused music will start to play automatically.









**Tip:** speak to the "MIC (8)" hole direct with distance in 30 ~ 60cm to get the best speakerphone performance when necessary.

## J. Redial for last call:

When you want to redial for last called number by the Bluetooth Speaker;

1. To redial for last called number by the Bluetooth Speaker, even it is in music playing mode.
2. Press twice the “ (6)” button to enter into redial function, the playing will pause and switch to hand free function for redial.
3. Press the “ (6)” button again to hang up the redial call.
4. Make sure that your mobile phone has have last dial call used, if not, the redial for last call function cannot be activated.

## K. FM Radio function:

1. Switch to FM Radio:
  - In power On / Bluetooth mode, press and hold the  (6) button for 2 ~ 3 seconds to switch into FM radio, a voice announce “**Radio**” from speaker. It is in FM Radio function.
  - Press and hold the  (6) button for 2 ~ 3 seconds again to return into Bluetooth mode.
2. Auto Tune / Search and Auto Preset Stations:
  - In FM radio mode, press and hold “ (7)” button for 2 ~ 3 seconds to enter into auto search and auto preset stations, a voice announce “**Radio Channel Searching**” from speaker and the mode LED (3) will blinking fast, the radio is in searching radio stations in range of frequency “**87.5MHz – 108MHz**” simultaneously.
  - The radio’s searching will end and go to the first received radio station for listening and all found radio stations will be preset and stored into device’s memory automatically.
3. Change the Preset Stations:
  - From current receiving preset station;
  - Press the “ (5)” button to next preset station.
  - Press the “ (4)” button to previous preset station.
4. Adjust Volume:
  - Press and hold the “ (5)” button to increases the volume level.
  - Press and hold the “ (4)” button to decreases the volume level.
5. Radio Mute:
  - Press the  (7)” button to mute the radio sound.
  - Press it again to resume for radio listening.



## L. Low power reminder and auto sleep:

1. The Bluetooth Speaker will send tones sound if the rechargeable lithium battery running at low energy level, when you heard this sounds from speaker, please connect the device to the computer / power charger through the USB cable if you still want to use the

device.

2. If not, the Bluetooth Speaker will power Off automatically when the battery is keeping low energy level in some minutes.
3. In this case, the device cannot be turned On, until you recharging the battery at least 10 ~ 15 minutes, because the rechargeable battery has not enough energy.

### M. Reset the Bluetooth Speaker

1. In some circumstances the device’s function may hanging and need to reset. To reset the Bluetooth speaker;
2. Press and hold the  (1) button for 8 ~ 10 seconds, the device should reset and turn itself to On automatically.
3. If not turn On the Bluetooth Speaker by press and hold the  (1) button for 2 ~ 3 seconds.

**Important:** Do not reset the device if it is proper working.

### N. Splash-proof design and handling

1. The Bluetooth Speaker’s splash-proof material and mechanical design allow you can place your Bluetooth Speaker on the wet part of your bathroom.
2. The Bluetooth Speaker can handle a brief jet of water on its surface. However, it should never be operated under running water and under no circumstances it should never be fully immersed in water.
3. Before use this Bluetooth Speaker in bathroom, make sure that the splash-proof rubber seals cover is tighten closed at the right position.
4. After used in bathroom, always wipe the outside of the cabinet thoroughly if it becomes wet with moisture or water splashes. This will help to prevent the internal parts of the unit from entry of water and possible moisture damage.

3. Trouble Shooting	
No power	<ul style="list-style-type: none"> <li>• Check battery is it charged with enough energy.</li> <li>• Check whether the device is in power OFF mode.</li> </ul>
No sound	<ul style="list-style-type: none"> <li>• Check whether volume level is in lower position on your speaker and mobile phone or PC/Mac.</li> <li>• Make sure that your Bluetooth device is within the effective operation range.</li> <li>• Check whether the Bluetooth device is paired.</li> <li>• Check whether the Bluetooth device show connected.</li> <li>• Check if you have selected the correct audio source.</li> </ul>



No response from speaker	• Reset the Bluetooth speaker by using reset function.
--------------------------	--

4. Specification		
Dimension	78.5 mm (L) x 78.5 mm (W) x 46.5 mm (H) (Not included Vacuum Cupule)	
Weight	92g (Not included Vacuum Cupule) 108g (with Vacuum Cupule)	
Bluetooth	Specification	V2.1 + EDR
	Supported Profile	A2DP, AVRCP, HSP/HFP
	Connection Distance	In 10 meters (open area)
Built-In Battery	Lithium 3.7V, 300mAh	
	Music Playing Time: > 2 Hours (at 75% of volume setting)	
Power Source	Micro USB Port	
	PC's USB port Power or DC 5V, 500mA	
Audio	Output Power	2W (RMS) at 4 Ohm
	Frequency Responses	100Hz to 20,000Hz
Radio	FM Band	87.5MHz~108MHz, step 0.1MHz
Operating Temperature	0 to 40°C	

## 5. Disclaimer

Updates to Firmware and/or hardware components are made regularly. Therefore some of the instruction, specifications and pictures in this documentation may differ slightly from your particular situation. All items described in this guide for illustration purposes only and may not apply to particular situation. No legal right or entitlements may be obtained from the description made in this manual.

## 6. Recycling



If at any time in the future you should need to dispose of this product, please note that: Waste electrical products should not be disposed of with household waste. Please recycle where facilities exist. Check with your Local Authority or Retailer for recycling advice. (Waste Electrical and Electronic Equipment Directive)

## **FCC Warning Statement**

Changes or modifications not expressly approved by the party responsible for compliance could void the user's authority to operate the equipment.

This equipment has been tested and found to comply with the limits for a Class B digital device, pursuant to Part 15 of the FCC Rules. These limits are designed to provide reasonable protection against harmful interference in a residential installation. This equipment generates uses and can radiate radio frequency energy and, if not installed and used in accordance with the instructions, may cause harmful interference to radio communications. However, there is no guarantee that interference will not occur in a particular installation. If this equipment does cause harmful interference to radio or television reception, which can be determined by turning the equipment off and on, the user is encouraged to try to correct the interference by one or more of the following measures: --Reorient or relocate the receiving antenna. --Increase the separation between the equipment and receiver. --Connect the equipment into an outlet on a circuit different from that to which the receiver is connected. --Consult the dealer or an experienced radio/TV technician for help.