

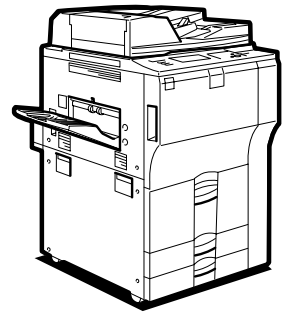

Printer/Scanner Unit Type 8000

Operating Instructions Scanner Reference



-
- 1** Sending Scan Files by E-mail
 - 2** Sending Scan Files to Folders
 - 3** Storing Files Using the Scanner Function
 - 4** Delivering Scan Files
 - 5** Scanning Originals with the Network TWAIN Scanner
 - 6** Various Scan Settings
 - 7** Appendix

Introduction

This manual contains detailed instructions and notes on the operation and use of this machine. For your safety and benefit, read this manual carefully before using the machine. Keep this manual in a handy place for quick reference.

Important

Contents of this manual are subject to change without prior notice. In no event will the company be liable for direct, indirect, special, incidental, or consequential damages as a result of handling or operating the machine.

Notes:

Some illustrations in this manual might be slightly different from the machine.

Certain options might not be available in some countries. For details, please contact your local dealer.

Caution:

Use of controls or adjustments or performance of procedures other than those specified in this manual might result in hazardous radiation exposure.

Two kinds of size notation are employed in this manual. With this machine refer to the inch version.

Trademarks

Adobe, Acrobat, Adobe Type Manager, Flash, Macromedia, PageMaker, PostScript are either registered trademarks or trademarks of Adobe Systems Incorporated in the United States and/or other countries.

Pentium® is a registered trademark of Intel Corporation.

NetWare, IPX, IPX/SPX are either registered trademarks or trademarks of Novell, Inc.

Microsoft®, Windows®, Windows Server®, and Windows Vista® are either registered trademarks or trademarks of Microsoft Corporation in the United States and/or other countries.

Other product names used herein are for identification purposes only and might be trademarks of their respective companies. We disclaim any and all rights to those marks.

The proper names of the Windows operating systems are as follows:

The product name of Windows 2000 are as follows:

Microsoft® Windows® 2000 Professional
Microsoft® Windows® 2000 Server
Microsoft® Windows® 2000 Advanced Server

The product name of Windows XP are as follows:

Microsoft® Windows® XP Professional
Microsoft® Windows® XP Home Edition
Microsoft® Windows® XP Media Center Edition
Microsoft® Windows® XP Tablet PC Edition

The product name of Windows Vista are as follows:

Microsoft® Windows Vista® Ultimate
Microsoft® Windows Vista® Business
Microsoft® Windows Vista® Home Premium
Microsoft® Windows Vista® Home Basic
Microsoft® Windows Vista® Enterprise

The product names of Windows Server 2003 are as follows:

Microsoft® Windows Server® 2003 Standard Edition
Microsoft® Windows Server® 2003 Enterprise Edition
Microsoft® Windows Server® 2003 Web Edition
Microsoft® Windows Server® 2003 Datacenter Edition

The product names of Windows Server 2003 R2 are as follows:

Microsoft® Windows Server® 2003 R2 Standard Edition
Microsoft® Windows Server® 2003 R2 Enterprise Edition
Microsoft® Windows Server® 2003 R2 Datacenter Edition

Manuals for This Machine

Refer to the manuals that are relevant to what you want to do with the machine.

Important

- Media differ according to manual.
- The printed and electronic versions of a manual have the same contents .
- Adobe Acrobat Reader/Adobe Reader must be installed in order to view the manuals as PDF files.
- Depending on which country you are in, there may also be html manuals. To view these manuals, a Web browser must be installed.

❖ About This Machine

Be sure to read the Safety Information in this manual before using the machine. This manual provides an introduction to the functions of the machine. It also explains the control panel, preparation procedures for using the machine, how to enter text, and how to install the CD-ROMs provided.

❖ Troubleshooting

Provides a guide to solving common problems, and explains how to replace paper, toner, and other consumables.

❖ Copy/ Document Server Reference

Explains Copier and Document Server functions and operations. Also refer to this manual for explanations on how to place originals.

❖ Facsimile Reference

Explains Facsimile functions and operations.

❖ Printer Reference

Explains Printer functions and operations.

❖ Scanner Reference

Explains Scanner functions and operations.

❖ Network Guide

Explains how to configure and operate the machine in a network environment, and use the software provided.

This manual covers all models, and includes descriptions of functions and settings that might not be available on this machine. Images, illustrations, and information about operating systems that are supported might also differ slightly from those of this machine.

❖ General Settings Guide

Explains User Tools settings, and Address Book procedures such as registering fax numbers, e-mail addresses, and user codes. Also refer to this manual for explanations on how to connect the machine.

❖ **Security Reference**

This manual is for administrators of the machine. It explains security functions that you can use to prevent unauthorized use of the machine, data tampering, or information leakage. For enhanced security, we recommend that you first make the following settings:

- Install the Device Certificate.
- Enable SSL (Secure Sockets Layer) Encryption.
- Change the user name and password of the administrator using Web Image Monitor.

For details, see “Setting Up the Machine”, Security Reference.

Be sure to read this manual when setting the enhanced security functions, or user and administrator authentication.

❖ **PostScript 3 Supplement**

Explains how to set up and use PostScript 3.

❖ **UNIX Supplement**

For “UNIX Supplement”, please visit our Web site or consult an authorized dealer.

❖ **Other manuals**

- Manuals for DeskTopBinder Lite
 - DeskTopBinder Lite Setup Guide
 - DeskTopBinder Introduction Guide
 - Auto Document Link Guide

 **Note**

- Manuals provided are specific to machine types.
- “PostScript 3 Supplement” and “UNIX Supplement” include descriptions of functions and settings that might not be available on this machine.
- The following software products are referred to using general names:

| Product name | General name |
|---|----------------------------------|
| DeskTopBinder Lite and DeskTopBinder Professional *1 | DeskTopBinder |
| ScanRouter EX Professional *1 and ScanRouter EX Enterprise *1 | the ScanRouter delivery software |

*1 Optional

TABLE OF CONTENTS

| | |
|--|----------|
| Manuals for This Machine | i |
| How to Read This Manual | 1 |
| Symbols | 1 |
| About the Scanner Functions | 2 |
| Display Panel | 3 |
| Simplified Display | 3 |
| Confirmation Displays | 4 |
| Scanner Features | 8 |

1. Sending Scan Files by E-mail

| | |
|--|-----------|
| Before Sending Scan Files by E-mail | 11 |
| Outline of Sending Scan Files by E-mail | 11 |
| Preparation for Sending by E-mail | 12 |
| Registering E-mail Addresses in the Address Book..... | 12 |
| E-mail Screen..... | 13 |
| Basic Operation for Sending Scan Files by E-mail | 14 |
| Switching to the E-mail Screen | 17 |
| Specifying E-mail Destinations | 18 |
| Selecting the Destination from the Machine's Address Book..... | 18 |
| Entering an E-mail Address Manually | 22 |
| Selecting Destinations by Searching an LDAP Server..... | 23 |
| Registering a Directly-Entered Destination in the Address Book | 26 |
| Specifying the E-mail Sender | 27 |
| Selecting a Sender from the List..... | 27 |
| Using a Registration Number to Specify a Sender Name | 28 |
| Selecting the Sender by Searching the Machine's Address Book | 29 |
| Specifying the E-mail Subject | 31 |
| Specifying the E-mail Message | 32 |
| Selecting a Message from the List | 32 |
| Manual Entry of a Message | 33 |
| Simultaneous Storage and Sending by E-mail | 34 |
| Sending the URL by E-mail..... | 35 |

2. Sending Scan Files to Folders

| | |
|--|-----------|
| Before Sending Files by Scan to Folder | 37 |
| Outline of Sending Scan Files by Scan to Folder..... | 37 |
| Preparation for Sending by Scan to Folder | 40 |
| Registering Destination Folders in the Address Book..... | 41 |
| Scan to Folder Screen | 42 |
| Basic Operations When Using Scan to Folder | 43 |
| Switching to the Scan to Folder Screen | 45 |
| Specifying Scan to Folder Destinations | 46 |
| Selecting the Destination from the Machine's Address Book..... | 46 |
| Sending Files to a Shared Network Folder | 50 |
| Sending Files to an FTP Server | 54 |
| Sending Files to an NDS Tree or NetWare Server | 56 |
| Registering the Path to the Selected Destination in the Address Book | 60 |
| Simultaneous Storage and Sending by Scan to Folder | 61 |

3. Storing Files Using the Scanner Function

| | |
|--|-----------|
| Before Storing Files | 63 |
| Outline of File Storage under the Scanner Function | 63 |
| Basic Operation for Storing Scan Files | 65 |
| Specifying File Information for a Stored File | 67 |
| Specifying a User Name | 67 |
| Specifying a File Name | 68 |
| Specifying a Password..... | 69 |
| Displaying the List of Stored Files | 70 |
| List of Stored Files | 70 |
| Searching the List of Stored Files | 72 |
| Checking Stored Files | 74 |
| Checking a Stored File Selected from the List | 74 |
| Checking Stored Files from a Client Computer | 76 |
| Sending a Stored File | 77 |
| Sending Stored Files..... | 77 |
| Managing Stored Files | 79 |
| Deleting a Stored File..... | 79 |
| Changing Data for a Stored File..... | 80 |

4. Delivering Scan Files

| | |
|---|------------|
| Before Delivering Files | 85 |
| Outline of Scan File Delivery | 85 |
| Preparing to Deliver a File | 86 |
| Installing DeskTopBinder Lite from the Supplied CD-ROM | 87 |
| Network Delivery Scanner Screen | 88 |
| Basic Operation for Delivering Files | 89 |
| Switching to the Network Delivery Scanner Screen | 92 |
| Specifying Delivery Destinations | 93 |
| Selecting Destinations Registered in the Delivery Server's Address Book | 93 |
| Specifying the Sender | 97 |
| Selecting a Sender from the Sender List in the Delivery Server's Destination List | 97 |
| Selecting the Sender by Entering the Registration Number | 98 |
| Selecting a Sender by Searching the Delivery Server's Destination List | 99 |
| Specifying the Subject of the E-mail to Be Transmitted via the Delivery Server ... | 101 |
| Simultaneous Storage and Delivery | 102 |

5. Scanning Originals with the Network TWAIN Scanner

| | |
|--|------------|
| Before Using the Network TWAIN Scanner | 103 |
| Outline of the Network TWAIN Scanner | 104 |
| Preparing to Use the Network TWAIN Scanner | 105 |
| Installing the TWAIN Driver from the Supplied CD-ROM | 106 |
| Basic Network TWAIN Scanner Operation | 107 |

6. Various Scan Settings

| | |
|---|------------|
| Scan Settings | 109 |
| Items for Specifying Scan Settings | 110 |
| Scan Type | 110 |
| Resolution | 110 |
| Scan Size | 111 |
| Edit | 119 |
| Adjusting Image Density | 120 |
| Setting of Original Feed Type | 121 |
| Original Orientation | 121 |
| Original Settings | 123 |
| Batch, SADF | 125 |
| Divide | 127 |

- Scanning Multiple Pages of Originals as One File 129**
- Setting File Type and File Name..... 131**
 - Setting File Type 131
 - Setting File Name..... 133
 - Security Settings to PDF Files 135
- Programs 139**
 - Registering Frequently Used Setting 139
 - Recalling a Registered Content 140
 - Changing a Registered Program..... 141
 - Deleting a Program 142
 - Changing the Registered Program Name 142
 - Registering Initial Values for Initial Display 143
- Scan Settings When Using Twain Scanner 144**
 - Setting Original Orientation on the TWAIN Scanner 144
 - When Scanning Originals of Mixed Sizes Using TWAIN Scanner 146

7. Appendix

- Relationship between Resolution and File Size..... 147**
 - When Using E-mail, Folder Sending, Storing or Network Delivery Function 148
 - When Using as a TWAIN Scanner..... 149
- Relationship between File Type Specified for Scanning
and File Types for Sending E-mail and Folder..... 151**
- Software Supplied on CD-ROM 153**
 - Quick Install..... 153
 - TWAIN Driver 153
 - DeskTopBinder Lite..... 154
- Values of Various Set Items for Transmission/Storage/Delivery Function..... 156**
 - Transmission Function 156
 - Storage Function..... 158
 - Network Delivery Function 159
- Specifications..... 160**
- INDEX..... 161**

How to Read This Manual

Symbols

This manual uses the following symbols:

WARNING:

Indicates important safety notes.

Ignoring these notes could result in serious injury or death. Be sure to read these notes. They can be found in the “Safety Information” section of About This Machine.

CAUTION:

Indicates important safety notes.

Ignoring these notes could result in moderate or minor injury, or damage to the machine or to property. Be sure to read these notes. They can be found in the “Safety Information” section of About This Machine.

Important

Indicates points to pay attention to when using the machine, and explanations of likely causes of paper misfeeds, damage to originals, or loss of data. Be sure to read these explanations.

Note

Indicates supplementary explanations of the machine’s functions, and instructions on resolving user errors.

Reference

This symbol is located at the end of sections. It indicates where you can find further relevant information.

[]

Indicates the names of keys that appear on the machine’s display panel.

[]

Indicates the names of keys on the machine’s control panel.

About the Scanner Functions

This section describes functions you can use in the scanner mode.

For details about each function, see respective chapters.

❖ Sending scanned files

There are several methods you can use to send captured data as files to computers.

- Sending scan files by e-mail
For details, see chapter 1 “Sending Scan Files by E-mail”.
- Sending scan files to a shared folder
For details, see chapter 2 “Sending Scan Files to Folders”.
- Sending scan files to an FTP server
For details, see chapter 2 “Sending Scan Files to Folders”.
- Sending scan files to a NetWare server
For details, see chapter 2 “Sending Scan Files to Folders”.
- Delivering scan files using the delivery server
For details, see chapter 4 “Delivering Scan Files”.

❖ Scanning originals using the TWAIN driver

Use the TWAIN driver to specify the machine where originals will be scanned from a client computer. For details, see chapter 5 “Scanning Originals with the Network TWAIN Scanner”.

❖ Storing files

You can store scan files on the machine's hard disc. Stored files can be sent later. For details, see chapter 3 “Storing Files Using the Scanner Function”.

Note

- ❑ When the Copy Data Security Unit is installed, if you scan an original that was printed using the data security for copying function, the machine beeps and an entirely gray page is sent or stored. You can use the log file to check who scanned the confidential original. For details about the data security for copying function, see Security Reference.

Reference

p.11 “Sending Scan Files by E-mail”

p.37 “Sending Scan Files to Folders”

p.85 “Delivering Scan Files”

p.103 “Scanning Originals with the Network TWAIN Scanner”

p.63 “Storing Files Using the Scanner Function”

Display Panel

This section explains the simplified display and three confirmation screens: Check Modes, Preview, and Transmission File Status.

You can find explanations about the E-mail screen, Scan to Folder screen, List of Stored Files screen, or Network Delivery Scanner screen in this manual. For details, see “E-mail Screen”, “Scan to Folder Screen”, “List of Stored Files”, and “Network Delivery Scanner Screen”.

Reference

p.13 “E-mail Screen”

p.42 “Scan to Folder Screen”

p.70 “List of Stored Files”

p.88 “Network Delivery Scanner Screen”

Simplified Display

This section explains how to switch to the simplified display.

When you press the **[Simplified Display]** key, the screen changes from the initial display to the simplified display.

Letters and keys are displayed at a larger size, making operations easier.

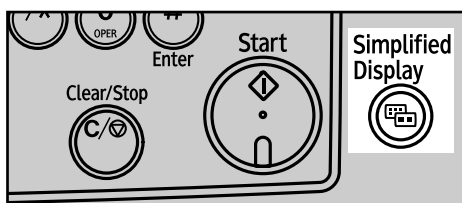

❖ Example of Simplified Display

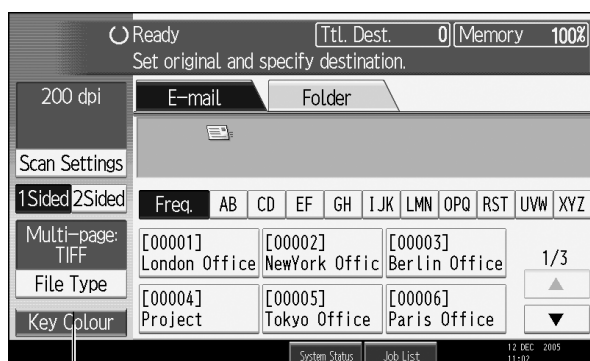

AMW001S

1. [Key Color]

Press to increase screen contrast by changing the color of the keys. This is available only for the simplified display.

Note

- ❑ To return to the initial screen, press the **[Simplified Display]** key again.
- ❑ Certain keys do not appear on the simplified display.

Confirmation Displays

This section explains three confirmation displays: Check Modes, Preview and Transmission File Status.

Check Modes

This section explains items that are displayed and how to display the Check Modes screen.

Use the Check Modes screen to check scanning and transmission settings.

Pressing **[Check Modes]** switches the screen from the initial scanner screen to the Check Modes screen.

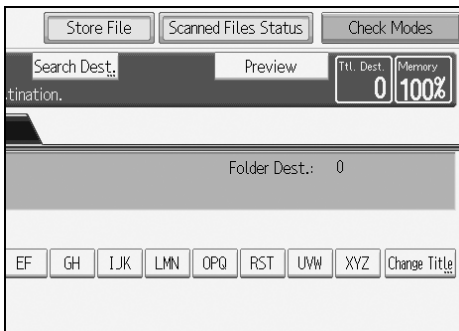

❖ Check Modes

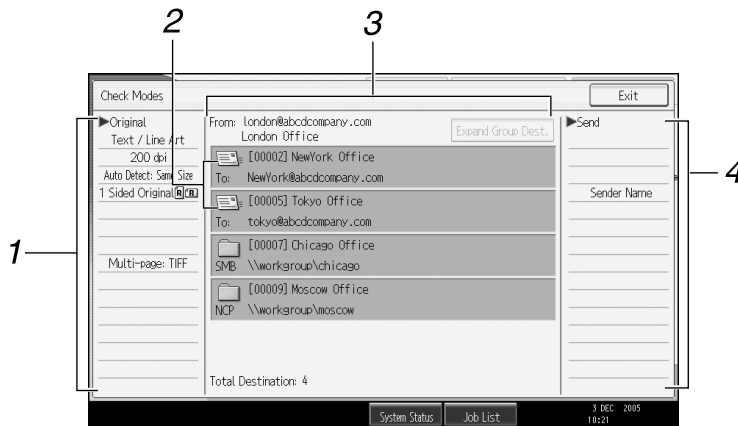

AMW002S

1. Original

Displays Scan Settings, Original Feed Type, and other scanning settings.

2. Transmission function icon

Displays the icon of the transmission function in use.

3. Sender and Destination

Displays the sender and transmission or delivery destinations.

4. Send

Displays transmission settings such as Sender and Subject.

Preview

This section explains items that are displayed and how to display the Preview screen. Use the Preview screen to check that of originals have been scanned correctly. You can display the Preview screen when sending files by e-mail or Scan to Folder, delivering files, or simultaneously sending and delivering files. To display the Preview screen, press **[Preview]**, and then start scanning while **[Preview]** is still selected.

❖ Preview

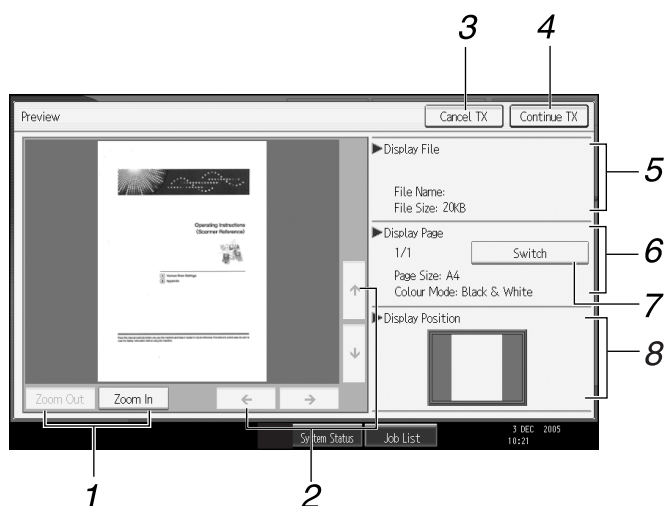

AMW003S

1. **[Zoom Out]** and **[Zoom In]**

Press to reduce or enlarge the displayed preview.

2. **[←]****[→]****[↑]****[↓]**

Press to shift the displayed area.

3. **[Cancel TX]**

Press to close a preview and interrupt a transmission.

4. **[Continue TX]**

Press to close a preview and continue a transmission.

5. **Display File**

Displays a file's name and size.

6. **Display Page**

Displays the number of the currently displayed page, total number of pages, page size, and color mode.

7. **[Switch]**

Press to change the page of the selected file that is displayed.

8. **Display Position**

Displays the position of an image when enlarged.

Note

- Preview is not available if a file is stored using **[Store Only]**.
- Preview is not available when sending a stored file.
- You can view a stored file using the Preview screen displayed from the list of stored files. For details about viewing a stored file, see "Checking a Stored File Selected from the List".
- Preview might not be displayed if scanning failed or the image file is corrupted. If this is the case, scan the original again.

Reference

p.74 "Checking a Stored File Selected from the List"

Transmission File Status

This section explains items that are displayed and how to display the Transmission File Status screen.

Use the Transmission File Status screen to check e-mail transmission, Scan to Folder, and delivery results.

Press [**Scanned Files Status**] to display the Transmission File Status screen.

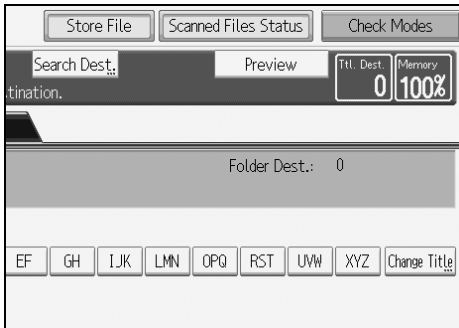

Up to 9 transmission or delivery results are displayed at the same time. Press [**▲**] or [**▼**] to switch between results.

❖ Transmission File Status

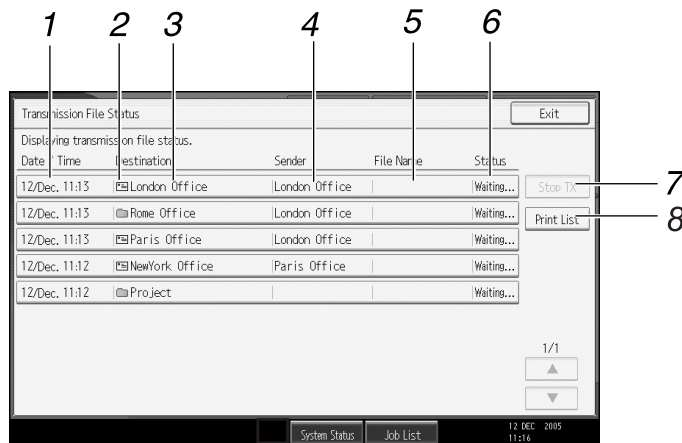

AMW004S

1. Date/Time

Displays the time and date transmission was specified by this machine or the time and date when Completed, Error, or Cancelled was confirmed.

2. Transmission function icon

Displays the icon of the transmission function used.

3. Destination

Displays the transmission destination.

If you have selected multiple destinations, the first selected destination is displayed.

Other destinations appear as "+ 2". (X indicates the number of destinations.)

4. Sender

Displays the sender name.

5. File Name

Displays the stored file name of files that are simultaneously sent and stored, or of stored files that are sent.

6. Status

Displays one of the following transmission statuses: Completed, Sending..., Waiting..., Error, or Cancelled.

Note

- You cannot check scanner function transmission results by pressing **[Job List]** at the bottom of the screen. To check transmission results, press **[Scanned Files Status]**, and then display the Transmission File Status screen.
- Depending on security settings, some transmission results might not be displayed.

7. [Stop TX]

To cancel transmission, select a file whose status is **[Waiting...]**, and then press **[Stop TX]**.

8. [Print List]

Press to print transmission results.

Scanner Features

This section explains Scanner Features settings.

To display the Scanner Features screen, press the **[User Tools / Counter]** key. For detailed setting method, see General Settings Guide.

❖ General Settings

| Items | Description |
|---|---|
| Switch Title | Sets index to use when the list of destinations of this machine is displayed. |
| Update Delivery Server Destination List | Allows you to update the delivery server's destination list by pressing [Update Delivery Server Destination List] . To use this function, under [System Settings] , set [Delivery Option] to [On] . |
| Search Destination | Specify the default search destination list from the machine's address book or the LDAP server. To search through an LDAP server, under [System Settings] , register the LDAP server, and then set [LDAP Search] to [On] . |
| TWAIN Standby Time | Select the machine's response if a client computer tries to use the TWAIN scanner while scanning is in progress. |
| Destination List Display Priority 1 | Select the default destination list from the machine's destination list or from the Destination List managed by the delivery server. |
| Destination List Display Priority 2 | Select whether to prioritize the e-mail destination list or the folder destination list. |
| Print & Delete Scanner Journal | Specify the machine's response of the maximum number of scanner journals is exceeded. |
| Print Scanner Journal | Allows you to print the scanner journal. The scanner journal is then deleted. |
| Delete Scanner Journal | Allows you to delete the scanner journal without printing it. |

❖ Scan Settings

| Items | Description |
|--|---|
| Wait Time for Next Orig.: Exposure Glass | Set which operation the machine performs while waiting for additional originals after scanning from the exposure glass. |
| Wait Time for Next Original(s): SADF | Sets the operation of this machine on the queue for additional originals after scanning the originals with Automatic Document Feeder (ADF). This function is not available unless ADF is installed. |

❖ Send Settings

| Items | Description |
|-------------------------------------|--|
| Compression (Black & White) | Specify a compression method for files scanned in black and white. |
| Compression (Gray Scale) | specify a compression method for files scanned in gray scale. |
| Max. E-mail Size | Select whether or not to limit the size of e-mail that has attachments. |
| Divide & Send E-mail | Select whether or not to divide files that exceed the size specified in [Max. E-mail Size] and send them as multiple e-mails. |
| E-mail Information Language | Select the language in which document information such as the title, date, and administrator's name is sent. |
| No. of Digits for Single Page Files | Set the number of digits in serial numbers used for single-page file names. |
| Stored File E-mail Method | Sets the default for whether to attach a file or send URL Link when sending stored files by e-mail. |

❖ Initial Settings

| Items | Description |
|--------------|---|
| Menu Protect | Set the default access level for functions whose settings can be changed by users other than the administrator. |

1. Sending Scan Files by E-mail

You can attach scan files to e-mails and send them via connections such as LAN and the Internet.

Before Sending Scan Files by E-mail

This section explains the necessary preparations and the procedure for sending scan files by e-mail.

Outline of Sending Scan Files by E-mail

This section outlines the function for sending scan files by e-mail.

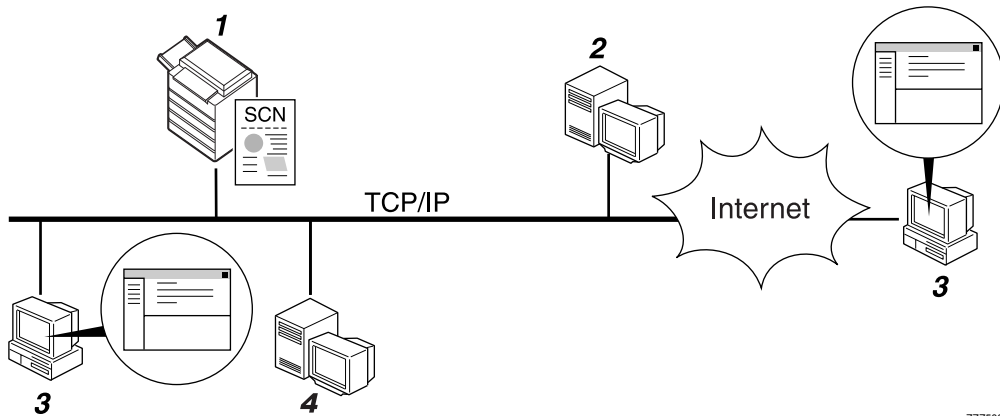

ZZZ508S

1. This machine

A scan file can be attached to an e-mail and sent to a mail server.

2. SMTP server

You need to have an access to an e-mail server that supports SMTP (Simple Mail Transfer Protocol), to send scan files by e-mail. However, it is not essential to have an e-mail server inside the LAN where this machine belongs. It transfers a received e-mail to a specified destination through a LAN or the Internet.

3. Client computer

Use e-mail client software to receive e-mail messages and scan file attachments that are generated by this machine.

4. LDAP Server

Use this server for administering e-mail accounts, searching the network, and authenticating the computers that access the machine. Using the LDAP server, you can search for destinations from the machine.

Preparation for Sending by E-mail

This section explains the preparation and settings for sending scan files by e-mail.

1 Connect the machine to the network.

Connect the machine to the network using an Ethernet cable or wireless LAN (IEEE 802.11b).

2 Make the necessary network setting in [System Settings].

If you have connected the machine to the network using an Ethernet cable, make the following settings. For details, see General Settings Guide.

- Specify the machine's IPv4 address and subnet mask.
- Specify the IPv4 gateway address.
- In [Effective Protocol], enable [IPv4].
- Specify the SMTP server.

3 If necessary, change settings in [Send Settings] under [Scanner Features].

Note

- To connect the machine to the network using a wireless LAN (IEEE 802.11b), an extended wireless LAN board is required respectively. For details, see Network Guide.
- Items to set up in [System Settings] vary depending on the network environment. For more information about network settings, see General Settings Guide.
- For more information about [Scanner Features], see General Settings Guide.

Registering E-mail Addresses in the Address Book

You can register frequently used e-mail addresses in the address book.

Register e-mail addresses in [Address Book Management] under [Administrator Tools] from [System Settings]. Addresses can also be registered as groups.

Note

- For details about registering e-mail addresses in the address book, see General Settings Guide.
- You can also register e-mail addresses in the address book using Web Image Monitor or SmartDeviceMonitor for Admin. For details about how to install these applications, see Network Guide. For details about registering addresses in the address book, see Help of respective applications.
- Depending on the machine type, you may not be able to use the machine when it is updating the address book using CSV files (retrieved using SmartDeviceMonitor for Admin) that contain user codes.

E-mail Screen

This section explains the screen layout when sending scan files by e-mail.

The function items displayed serve as selector keys. You can select or specify an item by pressing it.

When you select or specify an item on the display panel, it is highlighted like [TFF]. Keys that cannot be selected appear like [OK].

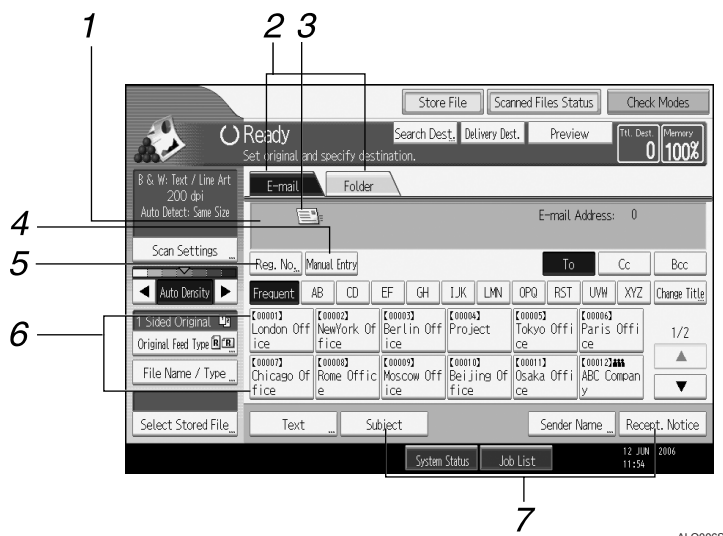

1. Destination field

The specified destination appears. If more than one destination has been specified, press [▲] or [▼] to scroll through the destinations.

2. E-mail / Folder

Press these tabs to switch between the E-mail screen and Scan to Folder screen.

Switch the screen also when sending the same files by both e-mail and Scan to Folder.

3. E-mail icon

Indicates that the E-mail screen is displayed.

4. [Manual Entry]

To specify destinations not registered in the address book, press this key, and then enter the e-mail addresses using the soft keyboard that appears.

5. [Reg. No.]

Press this key to specify the destination using a 5-digit registration number.

6. Destination List

The list of destinations registered in the machine appears. If all of the destinations cannot be displayed, press [▲] or [▼] to switch the screen.

Group destinations are denoted by this symbol (###).

7. [Text][Subject][Sender Name][Recept. Notice]

Enter the message and specify the subject, sender, and whether or not to use Message Disposition Notification.

Basic Operation for Sending Scan Files by E-mail

1

This section describes the basic operation for sending scan files by e-mail.

1 Make sure that no previous settings remain.

If a previous setting remains, press the **[Clear Modes]** key.

2 If the network delivery scanner screen or Scan to Folder screen appears, switch to the E-mail screen.

For details, see “Switching to the E-mail Screen”.

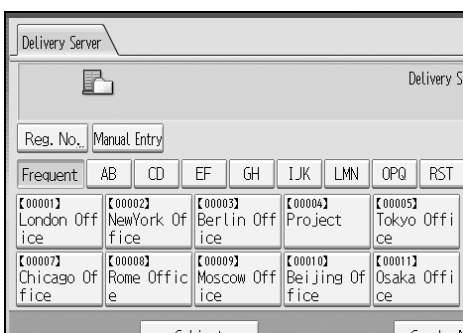

3 Place originals.

4 If necessary, press **[Scan Settings]** to specify scanner settings such as resolution and scan size.

For details, see “Various Scan Settings”.

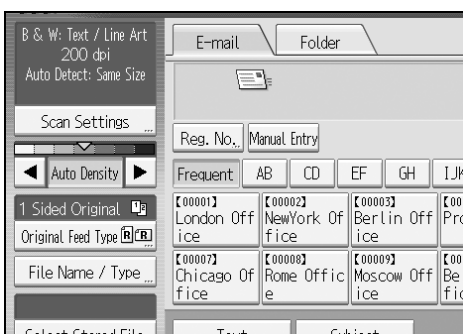

5 If necessary, specify the scanning density.

For details, see “Adjusting Image Density”.

6 If necessary, press **[Original Feed Type]** to specify settings such as original orientation.

For details, see “Setting of Original Feed Type”.

7 If necessary, press **[File Name / Type]** to specify settings such as file name and file format.

For details, see “Setting File Type and File Name”.

8 Specify the destination.

You can specify multiple destinations.

For details, see “Specifying E-mail Destinations”.

9 If necessary, press **[Text]** to enter the e-mail message.

For details, see “Specifying the E-mail Message”.

10 If necessary, press **[Subject]** to specify the e-mail subject.

For details, see “Specifying the E-mail Subject”.

11 To specify the e-mail sender, press **[Sender Name]**.

For details, see “Specifying the E-mail Sender”.

12 To use Message Disposition Notification, press **[Recept. Notice]**.

If you select **[Recept. Notice]**, the selected e-mail sender will receive e-mail notification when the e-mail recipient has opened the e-mail.

13 Press the **[Start]** key.

If you are scanning batches, place the next originals.

Note

- If you have selected two or more destinations, the destinations can be made to appear one by one by pressing **[▲]** or **[▼]** next to the destination field.
- To cancel a selected destination, display the destination in the destination field, and then press the **[Clear / Stop]** key. You can cancel a destination selected from the address book by pressing the selected destination again.
- In **[System Settings]**, you can specify the administrator’s e-mail address as the default sender name. This lets you send e-mail without entering anything for **[Sender Name]**. For details, see General Settings Guide.
- Depending on the security setting, the logged-on user may be specified as **[Sender Name]**.
- To use Message Disposition Notification, log on to the machine as a user and specify the sender. Note, however, that the **[Recept. Notice]** notification e-mail may not be transmitted if the e-mail software of the recipient does not support Message Disposition Notification.
- By pressing the **[Check Modes]** key, you can switch from the initial scanner screen to the Check Modes screen so you can check the settings. For details, see “Check Modes”.
- If you press **[Preview]**, and then scan a document, the Preview screen appears. For details, see “Preview”.
- To cancel scanning, press the **[Clear / Stop]** key.
- You can also store a scan file and simultaneously send it by e-mail. For details, see “Simultaneous Storage and Sending by E-mail”.

 **Reference**

- p.17 "Switching to the E-mail Screen"
- p.109 "Various Scan Settings"
- p.120 "Adjusting Image Density"
- p.121 "Setting of Original Feed Type"
- p.131 "Setting File Type and File Name"
- p.18 "Specifying E-mail Destinations"
- p.32 "Specifying the E-mail Message"
- p.31 "Specifying the E-mail Subject"
- p.27 "Specifying the E-mail Sender"
- p.4 "Check Modes"
- p.5 "Preview"
- p.34 "Simultaneous Storage and Sending by E-mail"

Switching to the E-mail Screen

This section explains how to switch the screen to the E-mail screen.

If the Scan to Folder screen is being displayed, press **[E-mail]** to switch to the E-mail screen.

If the network delivery scanner screen is being displayed, switch to the E-mail screen as follows:

1 Press **[Delivery Dest.]**.

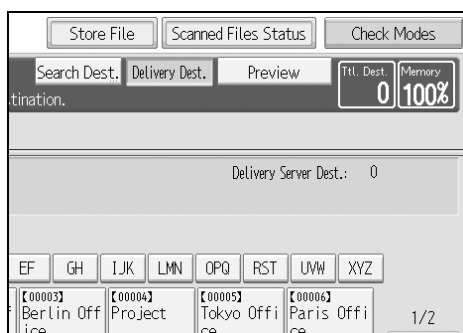

The E-mail screen or Scan to Folder screen appears.

2 If the Scan to Folder screen appears, press **[E-mail]**.

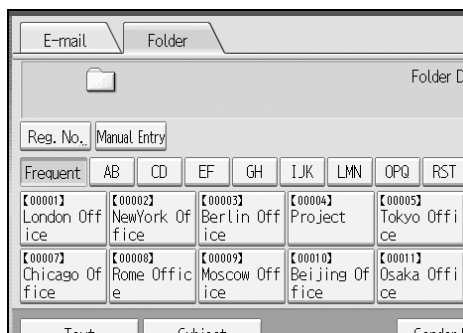

The E-mail screen appears.

Note

- You cannot switch from the network delivery scanner screen while delivery destinations are being specified. To clear the specified destination, display the destination in the destination field of the network delivery scanner screen, and then press the **[Clear / Stop]** key.

Specifying E-mail Destinations

1

This section explains how to specify e-mail destinations.

You can specify e-mail destinations by any of the following methods:

- Select the destination from the machine's address book
- Enter the e-mail address directly
- Search the LDAP server for the destination and select it

Before you select destinations, make sure you have selected **[To]**. If necessary, press **[Cc]** or **[Bcc]**, and then select destinations.

Selecting the Destination from the Machine's Address Book

This section explains how to select the destination from the machine's address book.

Important

- To use this function, you must register the destinations in **[System Settings]** in advance. For details, see General Settings Guide.

You can use the following methods to select destinations registered in the machine's address book:

- Select a destination from the list
- Select a destination by entering the registration number
- Select a destination by searching the machine's address book

Selecting a destination from the list

Select the destination from the destination list.

1 In the destination list, press the key including the destination name.

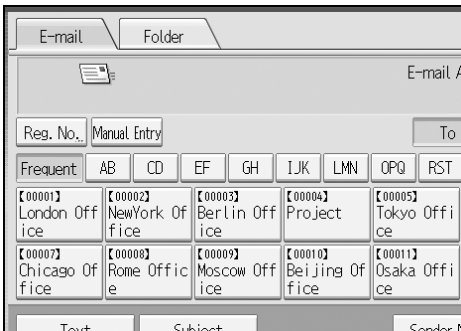

The key of the selected destination is highlighted, and the destination appears in the destination field at the top of the screen.

If the target destination does not appear, take one of the following steps:

- Display the destination by selecting its initial letter from the title
- Display the destination by pressing [▲] or [▼]

 **Note**

- Depending on the security setting, some destinations may not appear in the destination list.

1

Selecting destinations by entering the registration numbers

Select the destination from the machine's address book using its registration number.

1 Press [Reg. No.].

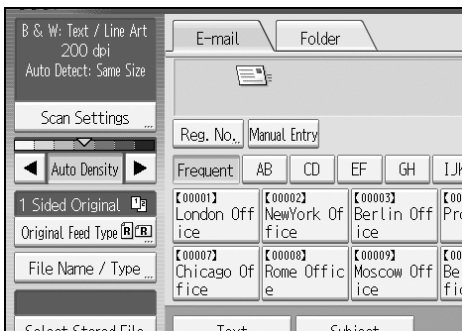

2 Using the number keys, enter the five-digit registration number assigned to the required destination folder.

If the entered number is less than five digits, press the [#] key after the last number. Example: To enter 00003 Press the [3] key, and then press the [#] key.

3 Press [OK].

By pressing [Change], you can change the selected destination.

Searching the machine's address book for the destination and selecting it

This section explains how to search the machine's address book for the destination and select it.

1 Press **[Search Dest.]**.

2 To search by destination name, press **[Name]**.

To search by e-mail address, press **[E-mail Address]**.

The soft keyboard appears.

You can also search by combining **[Name]** and **[E-mail Address]**.

3 Enter the beginning of the destination name.

To search by e-mail address, enter the beginning of the address.

4 Press **[OK]**.

5 If necessary, press **[Advanced Search]**, and then specify the detailed search criteria.

By pressing **[Advanced Search]**, you can search using criteria such as **[Name]**, **[E-mail Address]**, and **[Folder Name]**. You can also search by combining the **[Beginning Word]** or **[End Word]** criteria with the other criteria.

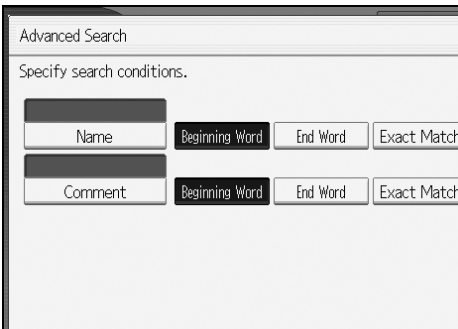

The illustrated screen is an example. The items that actually appear on the screen may differ.

6 Press **[Start Search]**.

Destinations that match the search criteria are displayed.

7 Select a destination.

8 Select **[To]**, **[Cc]**, or **[Bcc]**.

9 Press **[OK]**.

 **Note**

- If **[LDAP Search]** is set to **[On]** in **[System Settings]**, check that **[Address Book]** in the upper part on the screen has been selected before executing the search.
- Search criteria that appear in **[Advanced Search]**, such as **[Name]**, **[E-mail Address]**, and **[Folder Name]**, are registered in the machine's address book. For details, see General Setting Guide.
- By pressing **[Details]**, you can view details about the selected destinations.
- Up to 100 destinations can be displayed as search results.
- By pressing **[Advanced Search]**, the following criteria appear:
 - **[Beginning Word]**: The names which start with the entered character or characters are targeted.
For example, to search for "ABC", enter "A".
 - **[End Word]**: The names which end with the entered character or characters are targeted.
For example, to search for "ABC", enter "C".
 - **[Exact Match]**: The names which correspond to an entered character or characters are targeted.
For example, to search for "ABC", enter "ABC".
 - **[Include one Word]**: The names which contain an entered character or characters are targeted.
For example, to search for "ABC", enter "A", "B", or "C".
 - **[Exclude Words]**: The names which do not contain an entered character or characters are targeted.
For example, to search for "ABC", enter "D".

Entering an E-mail Address Manually

This section explains how to enter an e-mail address manually.

1

1 Press [Manual Entry].

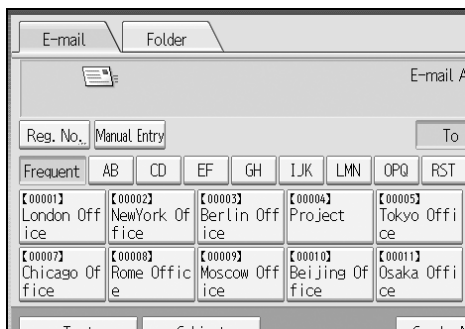

The soft keyboard appears so you can enter the e-mail address.

2 Enter the e-mail address.

3 Press [OK].

Note

- Depending on the security settings, **[Manual Entry]** may not be displayed.
- To change a registered destination e-mail address, press **[Edit]** to the left of the destination field to display the soft keyboard, use the soft keyboard to enter the new address, and then click **[OK]**.
- The e-mail address that is entered directly can be registered in the machine's address book. For details, see "Registering a Directly-Entered Destination in the Address Book".

Reference

p.26 "Registering a Directly-Entered Destination in the Address Book"

Selecting Destinations by Searching an LDAP Server

By accessing an LDAP server, you can search for destinations and select them.

Important

- To use this function, an LDAP server must be connected to the network. In addition, under **[System Settings]**, the server must be registered and **[LDAP Search]** must be set to **[On]**. For details, see General Settings Guide.

1 Press **[Search Dest.]**.



2 Select the LDAP server that appears next to **[Address Book]**.

Register the LDAP server in advance in **[System Settings]**.

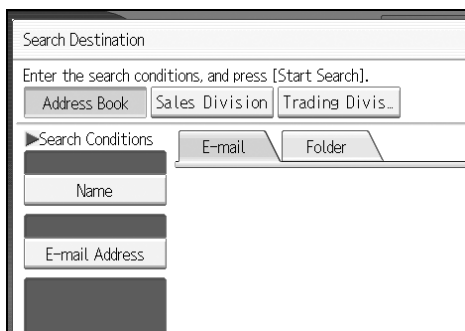

If authentication is required to access the selected server, the authentication screen appears. To authenticate, enter the user name and password.

3 To search by name, press **[Name]**.

To search by e-mail address, press **[E-mail Address]**.

The soft keyboard appears so you can enter the name or e-mail address.

You can also search by combining **[Name]** and **[E-mail Address]**. If you search by **[Name]**, whether the search is based on surname or first name depends on how the administrator has configured searching.

4 Enter part of the destination name.

To search by e-mail address, enter part of the destination address.

5 Press **[OK]**.

6 If necessary, press **[Advanced Search]**, and then specify the detailed search criteria.

By pressing **[Advanced Search]**, you can search using criteria such as **[Name]**, **[E-mail Address]**, **[Company Name]**, **[Department Name]**, and **[Search Options]**. You can also search by combining the **[Beginning Word]** or **[End Word]** criteria with the other criteria.

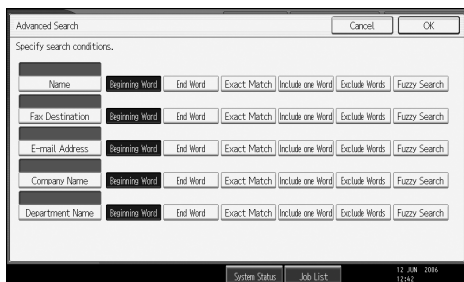

The illustrated screen is an example. The items that actually appear on the screen may differ.

7 Press **[Start Search]**.

Destinations that match the search criteria are displayed.

8 Select the destination.

9 Select **[To]**, **[Cc]**, or **[Bcc]**.

10 Press **[OK]**.

Note

- The **[Fax Destination]**, **[Company Name]**, **[Department Name]**, and **[Search Options]** search criteria that appear in **[Advanced Search]** are registered in the LDAP server. **[Search Options]** can be registered in **[System Settings]**. For details, see General Settings Guide.
- By pressing **[Details]**, you can view details about the selected destinations.
- Up to 100 destinations can be displayed as search results.
- If an e-mail address returned by the LDAP server is too long, it will be impossible to specify it as the destination. For details about the number of characters that can be specified, see "Sending E-mail".
- It is possible for more than one e-mail address to be registered for a destination. However, only one e-mail address per destination will appear in the search results. It depends on the LDAP server which e-mail address will be displayed. Usually, it is the e-mail address registered first.

- ☐ By pressing **[Advanced Search]**, the following criteria appear:
- **[Beginning Word]**: The names which start with the entered character or characters are targeted.
For example, to search for “ABC”, enter “A”.
 - **[End Word]**: The names which end with the entered character or characters are targeted.
For example, to search for “ABC”, enter “C”.
 - **[Exact Match]**: The names which correspond to an entered character or characters are targeted.
For example, to search for “ABC”, enter “ABC”.
 - **[Include one Word]**: The names which contain an entered character or characters are targeted.
For example, to search for “ABC”, enter “A”, “B”, or “C”.
 - **[Exclude Words]**: The names which do not contain an entered character or characters are targeted.
For example, to search for “ABC”, enter “D”.
 - **[Fuzzy Search]**: a vague search (The function of this vague search depends on the system supported by the LDAP server.)

 **Reference**

p.156 “Sending E-mail”

Registering a Directly-Entered Destination in the Address Book

This section explains how to register a directly-entered destination in the machine's address book. You can also register a destination selected from the LDAP server.

1 In the destination field, display the destination you want to register.

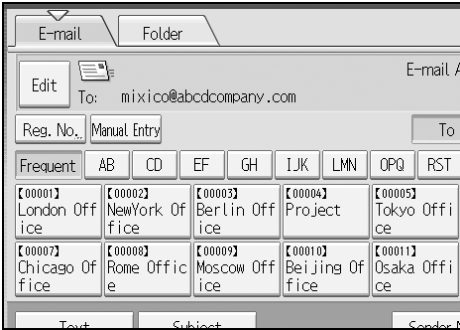

2 Press [Prg. Dest.].

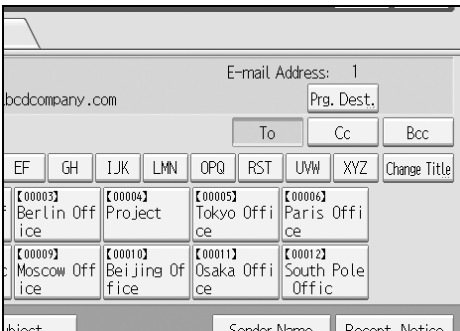

3 Press [Names], and then specify the name and other information to be registered.

For details about specifying the information to be registered, see General Settings Guide.

4 Press [OK].

 **Note**

- Depending on the security setting, [Prg. Dest.] may not appear. In such case, you cannot complete the registration.
- To register in the machine's address book a destination searched for and selected from the LDAP server, display the destination, and then press [Prg. Dest.].

Specifying the E-mail Sender

This section explains how to specify the e-mail sender.

To send e-mail, you must specify the name of the sender.

You can specify the e-mail sender by any of the following methods:

- Select the sender from the machine's sender list
- Select the sender by entering the registration number
- Select the sender by searching the machine's address book

Note

- ❑ Senders must be registered in advance under **[System Settings]**. For details, see General Settings Guide.
- ❑ In **[System Settings]**, you can specify the administrator's e-mail address as the default sender name. This lets you send e-mail without entering anything for **[Sender Name]**. For detail, see General Settings Guide.
- ❑ Depending on the security setting, the logged-on user may be specified as **[Sender Name]**.
- ❑ When a protection code has been set, a screen for entering the protection code appears after selecting the sender. Enter the protection code, and then press **[OK]**. If the protection code you entered is correct, the sender name is displayed.

Selecting a Sender from the List

This section explains how to select the sender from the machine's sender list.

1 Press **[Sender Name]**.

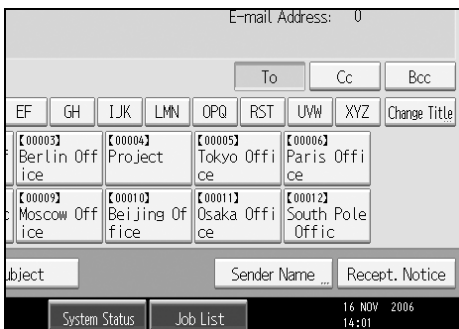

2 Select the sender.

3 Press **[OK]**.

Using a Registration Number to Specify a Sender Name

Select the sender from the destination list according to the registration number.

1

1 Press **[Sender Name]**.

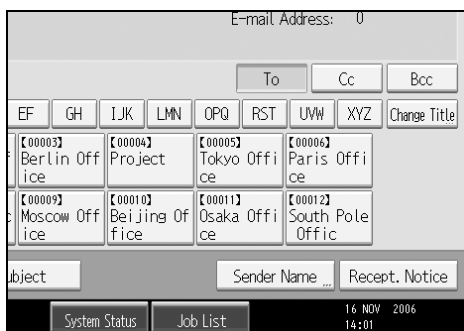

2 Press **[Registration No.]**.

3 Using the number keys, enter the five-digit registration number assigned to the required destination folder.

If the entered number is less than five digits, press the **[#]** key after the last number.

Example: To enter 00006

Press the **[6]** key, and then press the **[#]** key.

4 Press **[OK]** twice.

By pressing **[Change]**, you can change the selected destination.

Selecting the Sender by Searching the Machine's Address Book

This section explains how to select the sender by searching the machine's address book.

1 Press **[Sender Name]**.

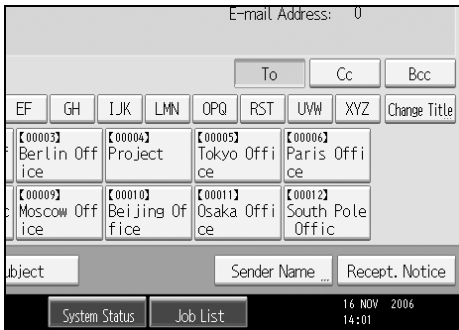

2 Press **[Search]**.

3 To search by user name, press **[Name]**.

To search by e-mail address, press **[E-mail Address]**.

The soft keyboard appears.

You can also search by combining **[Name]** and **[E-mail Address]**.

4 Enter the beginning of the sender's name you want to search for.

To search by e-mail address, enter the beginning of the address.

5 Press **[OK]**.

6 If necessary, press **[Advanced Search]**, and then specify the detailed search criteria.

By pressing **[Advanced Search]**, you can search using criteria such as **[Name]**, **[E-mail Address]**, and **[Folder Name]**.

You can also search by combining the **[Beginning Word]** or **[End Word]** criteria with the other criteria.

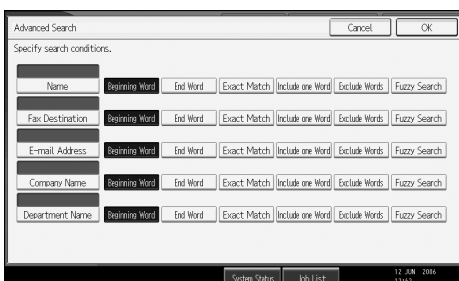

The illustrated screen is an example. The items that actually appear on the screen may differ.

7 Press **[Start Search]**.

Destinations that match the search criteria are displayed.

8 Select the sender.**9** Press **[OK]**. **Note**

- If **[LDAP Search]** is set to **[On]** in **[System Settings]**, check that **[Address Book]** in the upper part on the screen has been selected before executing the search.
- Search criteria that appear in **[Advanced Search]**, such as **[Name]**, **[E-mail Address]**, and **[Folder Name]**, are registered in the machine's address book. For details, see General Setting Guide.
- By pressing **[Details]**, you can view details about the selected sender.
- By pressing **[Advanced Search]**, the following criteria appear:
 - **[Beginning Word]**: The names which start with the entered character or characters are targeted.
For example, to search for "ABC", enter "A".
 - **[End Word]**: The names which end with the entered character or characters are targeted.
For example, to search for "ABC", enter "C".
 - **[Exact Match]**: The names which correspond to an entered character or characters are targeted.
For example, to search for "ABC", enter "ABC".
 - **[Include one Word]**: The names which contain an entered character or characters are targeted.
For example, to search for "ABC", enter "A", "B", or "C".
 - **[Exclude Words]**: The names which do not contain an entered character or characters are targeted.
For example, to search for "ABC", enter "D".

Specifying the E-mail Subject

This section explains how to specify the e-mail subject.

1 Press [Subject].

The screenshot shows a software interface for specifying an e-mail subject. At the top right, it says 'E-mail A'. Below that is a 'Reg. No.' field with a 'Manual Entry' button and a 'To' field. A 'Frequent' button is on the left. Below these are several columns of buttons labeled AB, CD, EF, GH, IJK, LMN, OPQ, and RST. The main area contains a grid of buttons with codes and office names: [00001] London Office, [00002] NewYork Office, [00003] Berlin Office, [00004] Project, [00005] Tokyo Office, [00007] Chicago Office, [00008] Rome Office, [00009] Moscow Office, [00010] Beijing Office, and [00011] Osaka Office. At the bottom, there are fields for 'Text', 'Subject', and 'Sender Name', along with 'System Status' and 'Job List' buttons.

The soft keyboard appears.

2 Enter the subject.

3 Press [OK].

Specifying the E-mail Message

1

This section explains how to specify the e-mail message.

The message can be created in the following ways:

- Select the e-mail message from the list
- Enter the message directly

Selecting a Message from the List

You can select a message from the list.

Important

- The messages that can be selected from the list must be registered in [System Settings] in advance.

1 Press [Text].

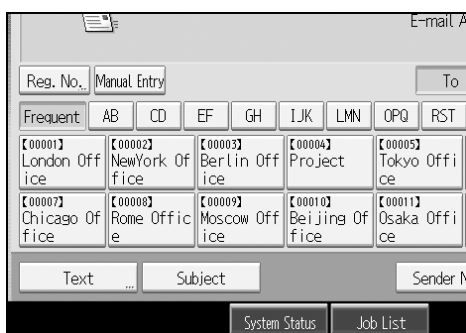

2 Select a message.

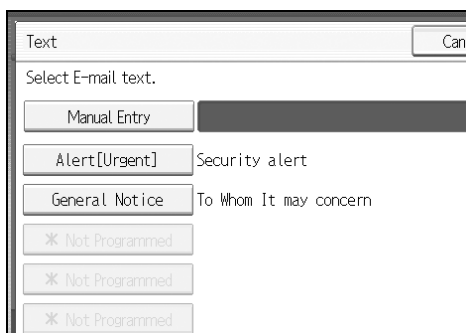

3 Press [OK].

Manual Entry of a Message

You can enter the message manually.

1 Press [Text].

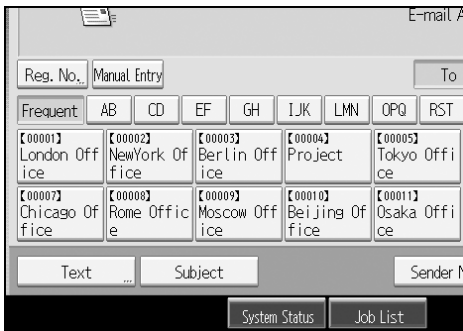

2 Press [Manual Entry].

The soft keyboard appears so you can enter the message.

3 Enter the message.

4 Press [OK] twice.

Simultaneous Storage and Sending by E-mail

1

This section explains how to store a file and simultaneously send it by e-mail.

1 Press [Store File].

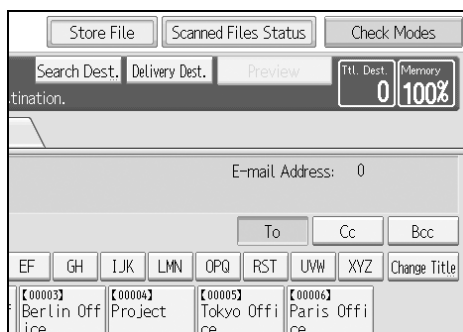

2 Make sure [Send & Store] is selected.

3 If necessary, specify file data, such as [User Name], [File Name], and [Password].

For details, see “Specifying File Information for a Store File”.

4 Press [OK].

5 Specify the setting for sending the file by e-mail, and then send the file.

For details about sending a file by e-mail, see “Basic Operation for Sending Scan Files by E-mail”.

Note

- If you simultaneously store scan files and send them by e-mail, the files cannot be retransmitted from the E-mail screen. To retransmit the files, select the file on the screen for selecting stored files, and then send them. For details, see “Sending a Stored File”.

Reference

p.67 “Specifying File Information for a Stored File”

p.14 “Basic Operation for Sending Scan Files by E-mail”

p.77 “Sending a Stored File”

Sending the URL by E-mail

This section explains how to send the URL of the stored file by e-mail.

Important

- To send the URL of the stored file by e-mail without sending the file itself, you must specify the setting in **[Scanner Features]**. For details, see General Settings Guide.

You can send the URL when you send a stored file by e-mail, and when you store a file and simultaneously send it by e-mail.

With the transmitted URL, the recipient can view, download, or delete the file indicated by the URL over the network using Web Image Monitor. Even if you cannot send a file by e-mail because of network limitations, you can still send the URL of the file.

1 In **[Scanner Features]**, select **[Send URL Link]** under **[Stored File E-mail Method]**.

For details about specifying the setting, see General Settings Guide.

2 Send a stored file by e-mail. Alternatively, store a file and simultaneously send it by e-mail.

For details about sending a stored file by e-mail, see “Sending a Stored File”.

For details about storing a file and simultaneously sending it by e-mail, see “Simultaneous Storage and Sending by E-mail”.

An e-mail such as the one shown below will be sent to the destination.

This E-mail was sent from "InternetFaxG"

Queries to: Paris@abcdcompany.com

Please access following URL.
If you cannot access please contact the sender or machine administrator.

<http://InternetFaxG.ABCD-NET.com/?open=webdocbox/docFile.cgi?ID=c6a>

File Name: SCAND0013
Scan Date:12.06.2006 15:24:25 (-0400)
Document Valid for:15.06.2006 15:24:25 (-0400)

3 In the e-mail destination, click the URL.

Web Image Monitor starts.

4 View, delete, or download the file over the network using Web Image Monitor.

 **Note**

- It is recommended that you use Web Image Monitor on the same network environment. For details about settings for using Web Image Monitor, see Network Guide.
- Depending on the environment, even if you click the URL in the file sent by e-mail, the browser may not start and you may not be able to view the file. If this happens, click the same URL again, or manually enter the URL in the browser's address bar.
- For details about the functions for displaying and downloading stored files using Web Image Monitor, see Copy/ Document Server Reference.
- To display details about the functions for managing stored files using Web Image Monitor, click **[Help]** on the upper right of each Web browser's window.
- You can send the URL by e-mail and simultaneously send it by Scan to Folder. In this case, the file is sent to the Scan to Folder destination, not the URL.

2. Sending Scan Files to Folders

Using the Scan to Folder function, you can send scan files over the network to shared folders, FTP server folders, or NetWare folders.

Before Sending Files by Scan to Folder

This section describes the preparations and procedure for sending files by Scan to Folder.

Outline of Sending Scan Files by Scan to Folder

This section outlines the function for sending scan files by Scan to Folder.

Sending files to shared folders

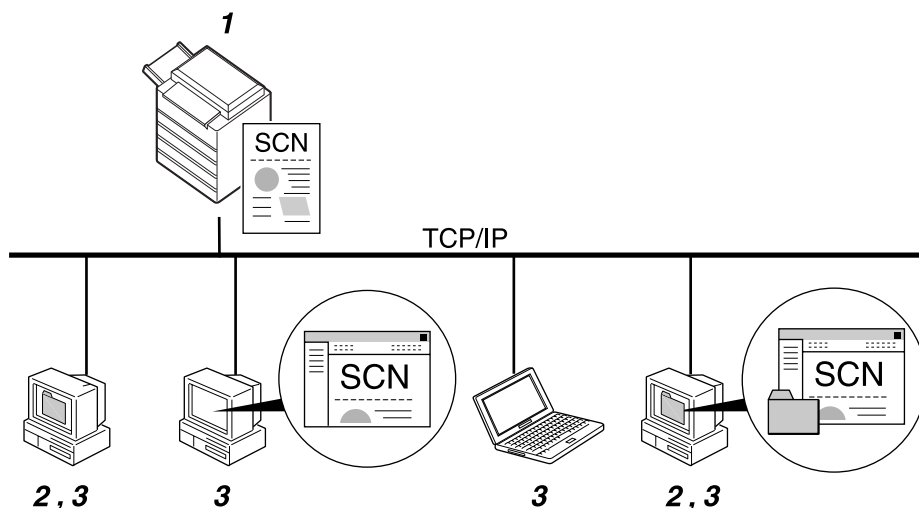

ZZZ509S

1. This machine

You can send scan files to shared network folders. To send scan files to shared network folders, use the SMB protocol.

2. Computer with a shared folder

To use this function, it is necessary to create a shared folder in advance. You can specify a shared folder to save scan files.

3. Client computer

You can also browse scanned files saved to a shared folder from a client computer.

Sending files to an FTP server

2

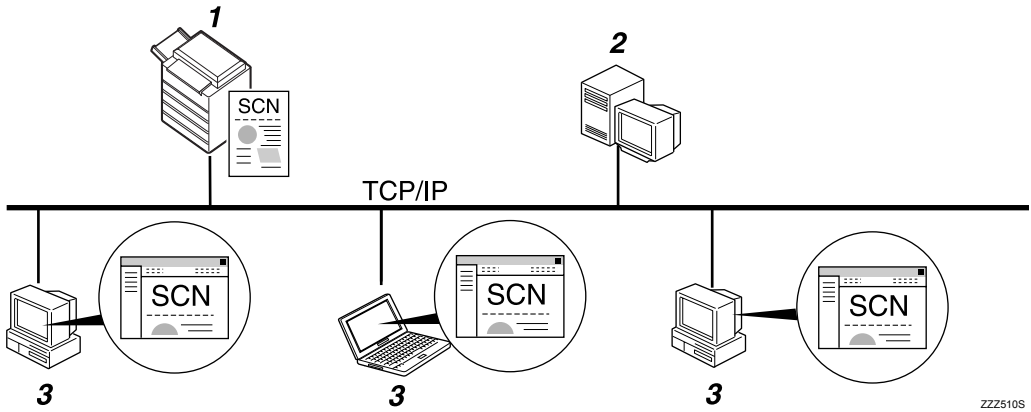

ZZZ510S

1. This machine

You can send scan files to FTP server folders. To send scan files to FTP server folders, use the FTP protocol.

2. FTP server

The FTP server is a server that provides file transfer services among computers on the same network. Transferred files are stored on this server. It is essential to have the FTP server inside the LAN/WAN where this machine belongs. It is not possible to access an FTP server via a proxy server.

3. Client computer

You can browse scanned files saved to an FTP server from a client computer. You need to have an FTP client program on the computer to connect to an FTP server.

Sending files to a NetWare server

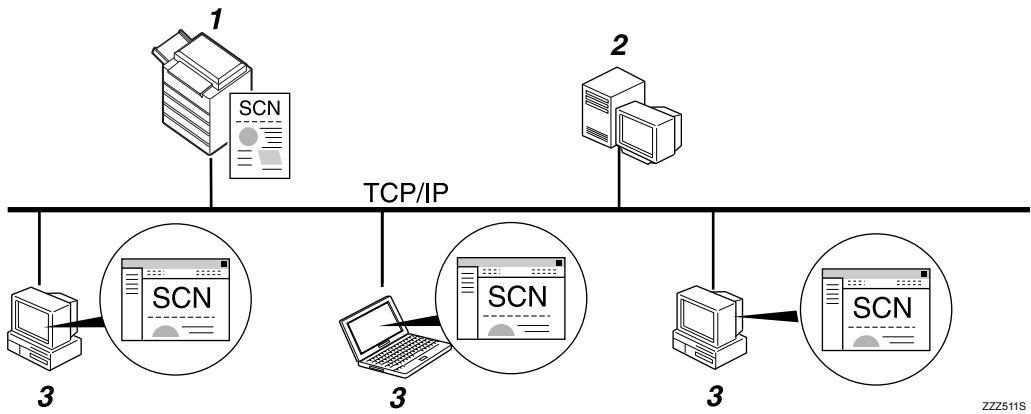

ZZZ511S

1. This machine

You can send scan files to NetWare folders. To send scan files to NetWare folders, use the NCP protocol.

2. NetWare Server

You can use this server to share files over the network via NetWare. By sending image data to the server, files can be stored on the server.

3. Client computer

To download files, a computer must be running the NetWare client and be logged onto the server.

Preparation for Sending by Scan to Folder

This section describes the preparations and settings for sending scan files by Scan to Folder.

Important

- Files can be sent to shared folders on client computers.
- Files can also be sent to FTP servers if any exist on the network.
- Files can also be sent to NetWare servers if any exist on the network.

1 Connect the machine to the network.

Connect the machine to the network using an Ethernet or wireless LAN (IEEE 802.11b).

2 Make the necessary network settings in [System Settings].

If you have connected the machine to the network using an Ethernet cable, make the following settings. For details, see General Settings Guide.

- Specify the machine's IPv4 address and subnet mask.
- Specify the IPv4 gateway address.
- In [Effective Protocol], enable [IPv4].
- To send files to shared folders, enable [SMB] in [Effective Protocol]. To send files to NetWare folders, enable [NetWare] in [Effective Protocol].

3 If necessary, change settings in [Send Settings] under [Scanner Features].

Note

- To connect the machine to the network using a wireless LAN (IEEE 802.11b), an extended wireless LAN board is required respectively. For details, see Network Guide.
- Items to set up in [System Settings] vary depending on the network environment. For more information about network settings, see General Settings Guide.
- For details about [Scanner Features], see General Settings Guide.
- Sending files using SMB is available only under a NetBIOS over TCP/IP environment. Sending files using SMB is not available under a NetBEUI environment.
- Even when settings made with the control panel, Web Image Monitor, Telnet, or other methods do not permit the use of SMB and FTP, sending files is still possible.

Registering Destination Folders in the Address Book

You can register the addresses of frequently-used destination folders in the address book. Register the folder addresses in **[Address Book Management]** under **[Administrator Tools]** from **[System Settings]**. These addresses can also be registered as groups.

 **Note**

- For details about registering the address of a destination folder in the address book, see General Settings Guide.
- You can register entries in the address book using Web Image Monitor or SmartDeviceMonitor for Admin. For details about installing SmartDeviceMonitor for Admin, see “Monitoring and Configuring the Printer”, Network Guide. For details about registering addresses, see each application’s Help.
- Depending on the machine type, you may not be able to use the machine when it is updating the address book using CSV files (retrieved using SmartDeviceMonitor for Admin) that contain user codes.

Scan to Folder Screen

This section describes the screen layout when sending scan files by Scan to Folder.

The function items displayed serve as selector keys. You can select or specify an item by pressing it. When you select or specify an item on the display panel, it is highlighted like **[TFF]**. Keys that cannot be selected appear like **[OK]**.

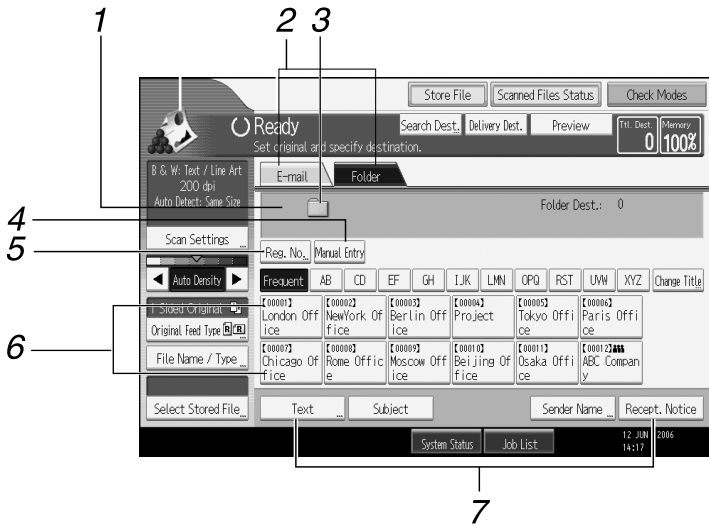

ALQ007S

1. Destination field

The specified destination appears. If more than one destination has been specified, press **[▲]** or **[▼]** to scroll through the destinations.

2. E-mail/ Folder

Press to switch between the Scan to Folder screen and E-mail screen

Also switch the screen when sending a file simultaneously by both Scan to Folder and e-mail.

3. Scan to Folder icon

Shows that the Scan to Folder screen is displayed.

4. [Manual Entry]

To specify destinations not registered in the address book, press this button to display the soft keyboard, and then enter the address of the destination folder.

5. [Reg. No.]

Press to specify a destination using a five-digit registration number.

6. Destination List

The list of destinations registered in the machine appears.

If all of the destinations cannot be displayed, press **[▲]** or **[▼]** to switch the screen.

Group destinations are denoted by this symbol (###).

7. [Text][Subject][Sender Name][Recept. Notice]

You can enter the message and specify the subject, sender, and whether or not to use Message Disposition Notification. The entries will be used for e-mail transmission when sending files simultaneously by Scan to Folder and e-mail. For details, see "Sending Scan Files by E-mail".

Reference

p.11 "Sending Scan Files by E-mail"

Basic Operations When Using Scan to Folder

This section describes the basic operations involved in using Scan to Folder.

1 Make sure that no previous settings remain.

If a previous setting remains, press the **[Clear Modes]** key.

2 If the network delivery scanner screen or E-mail screen appears, switch to the Scan to Folder screen.

For details, see “Switching to the Scan to Folder Screen”.

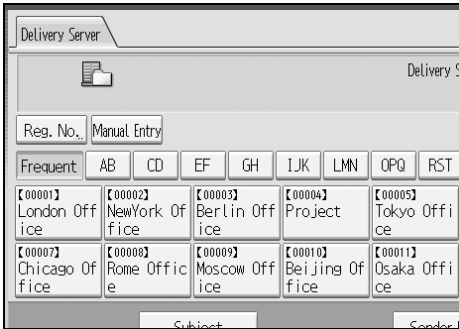

3 Place originals.

4 If necessary, press **[Scan Settings]** to specify scanner settings such as resolution and scan size.

For details, see “Various Scan Settings”.

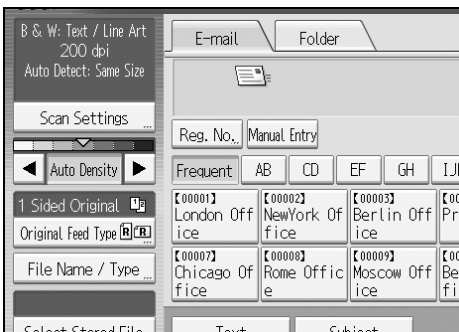

5 If necessary, specify the scanning density.

For details, see “Adjusting Image Density”.

6 If necessary, press **[Original Feed Type]** to specify settings such as original orientation.

For details, see “Setting of Original Feed Type”.

7 If necessary, press **[File Name / Type]** to specify settings such as file name and file format.

For details, see “Setting File Type and File Name”.

8 Specify the destination.

You can specify multiple destinations.

For details, see “Specifying Scan to Folder Destinations”.

9 Press the **[Start]** key.

If you are scanning batches, place the next originals.

 **Note**

- If you have selected more than one destination, you can press **[▲]** or **[▼]** next to the destination field to scroll through the destinations.
- To cancel a selected destination, display the destination in the destination field, and then press the **[Clear / Stop]** key. You can cancel a destination selected from the address book by pressing the selected destination again.
- By pressing the **[Check Modes]** key, you can switch from the initial scanner screen to the Check Modes screen so you can check the settings. For details, see “Check Modes”.
- If you press **[Preview]**, and then scan a document, the Preview screen appears. For details, see “Preview”.
- To cancel scanning, press the **[Clear / Stop]** key.
- You can also store a file and simultaneously send it by Scan to Folder. For details, see “Simultaneous Storage and Sending by Scan to Folder”.

 **Reference**

p.45 “Switching to the Scan to Folder Screen”

p.109 “Various Scan Settings”

p.120 “Adjusting Image Density”

p.121 “Setting of Original Feed Type”

p.131 “Setting File Type and File Name”

p.46 “Specifying Scan to Folder Destinations”

p.4 “Check Modes”

p.5 “Preview”

p.61 “Simultaneous Storage and Sending by Scan to Folder”

Switching to the Scan to Folder Screen

This section explains how to switch to the Scan to Folder screen.

If the E-mail screen is being displayed, press **[Folder]** to switch to the Scan to Folder screen.

If the network delivery scanner screen is being displayed, switch to the Scan to Folder screen as follows:

1 Press **[Delivery Dest.]**.

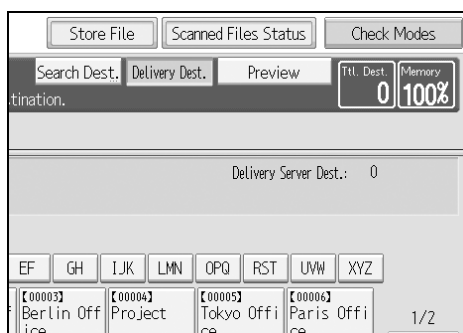

The E-mail screen or Scan to Folder screen appears.

2 If the E-mail screen appears, press **[Folder]**.



The Scan to Folder screen appears.

Note

- ❑ You cannot switch from the network delivery scanner screen while delivery destinations are being specified. To clear the specified destination, display the destination in the destination field of the network delivery scanner screen, and then press the **[Clear / Stop]** key.

Specifying Scan to Folder Destinations

This section explains how to specify Scan to Folder destinations.

You can send a file by Scan to Folder by any of the following methods:

- Select a destination registered in the machine's address book
- Send a file to a shared network folder
- Send a file to an FTP server
- Send a file to an NDS tree or a NetWare server

2

Selecting the Destination from the Machine's Address Book

This section explains how to select the destination from the machine's address book.

Important

- To use this function, you must register the destinations in **[System Settings]** in advance.

You can select a destination registered in the machine's address book by any of the following methods:

- Select the destination from the destination list
- Select the destination by entering its registration number
- Select the destination by searching the machine's address book

Note

- If you have specified the address protection code for accessing the address book, the screen for entering the address protection code appears.
- Depending on the security setting, some destinations may not appear in the destination list.

Selecting a destination registered in the destination list

Select the destination from the destination list.

1 In the destination list, press the key including the destination name.

The key of the selected destination is highlighted, and the destination appears in the destination field at the top of the screen.



If the target destination does not appear, take one of the following steps:

- Display the destination by selecting its initial letter from the title
- Display the destination by pressing [▲] or [▼]

Note

- Depending on the security setting, some destinations may not appear in the destination list.

Selecting destinations by entering the registration numbers

Select the destination from the machine's address book using its registration number.

1 Press [Reg. No.].

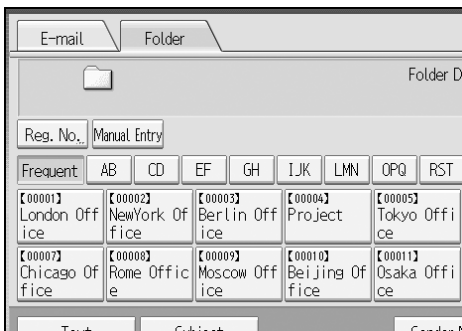

2 Enter the five-digit registration number that has been assigned to a destination folder using the number keys.

If the entered number is less than five digits, press the [#] key after the last number.

Example: To enter 00004

Press the [4] key, and then press the [#] key.

3 Press [OK].

By pressing [Change], you can change the selected destination.

Searching the machine's address book for the destination and selecting it

This section explains how to search the machine's address book for the destination and select it.

1 Press [Search Dest.].

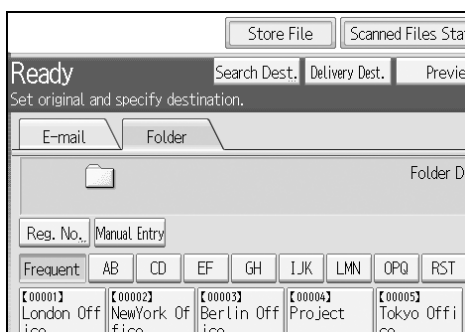

2 To search by destination name, press [Name].

To search by path, press [Folder Name].

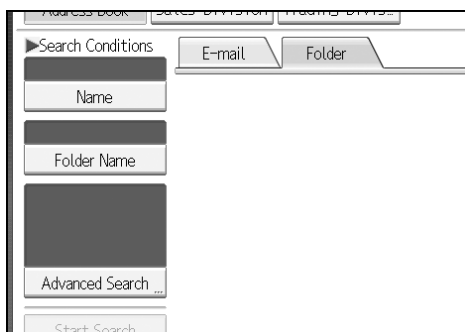

The soft keyboard appears.

You can also search by combining [Name] and [Folder Name].

3 Enter the beginning of the destination name.

To search by path, enter the beginning of the folder path. If the folder path is "\\volume\folder", then enter "\\volume\folder".

4 Press [OK].

5 If necessary, press **[Advanced Search]**, and then specify the detailed search criteria.

By pressing **[Advanced Search]**, you can search using criteria such as **[Name]**, **[E-mail Address]**, and **[Folder Name]**.

You can also search by combining the **[Beginning Word]** or **[End Word]** criteria with the other criteria.

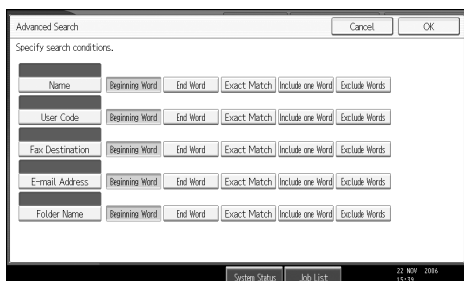

The illustrated screen is an example. The items that actually appear on the screen may differ.

6 Press **[Start Search]**.

Destinations that match the search criterion are displayed.

7 Select the destination folder.

8 Press **[OK]**.

 **Note**

- Search criteria that appear in **[Advanced Search]**, such as **[Name]**, **[E-mail Address]**, and **[Folder]**, are registered in the machine's address book. For details, see General Setting Guide.
- By pressing **[Details]**, you can view details about the selected destinations.
- Up to 100 destinations can be displayed as search results.
- By pressing **[Advanced Search]**, the following criteria appear:
 - **[Beginning Word]**: The names which start with the entered character or characters are targeted.
For example, to search for "ABC", enter "A".
 - **[End Word]**: The names which end with the entered character or characters are targeted.
For example, to search for "ABC", enter "C".
 - **[Exact Match]**: The names which correspond to an entered character or characters are targeted.
For example, to search for "ABC", enter "ABC".
 - **[Include one Word]**: The names which contain an entered character or characters are targeted.
For example, to search for "ABC", enter "A", "B", or "C".
 - **[Exclude Words]**: The names which do not contain an entered character or characters are targeted.
For example, to search for "ABC", enter "D".

Sending Files to a Shared Network Folder

This section explains how to specify the destination when sending files to a shared network folder.

Important

- The shared folder must have been created on the client computer in advance, see Windows Help.
- You can create the shared folder under Windows 2000/XP/Vista, Windows Server 2003/2003 R2, and Mac OS X.
- Depending on the operating system of the client computer, access to the shared folder may require authentication.
- This machine does not support DFS (Distributed File System).

You can send a file to a shared folder over the network by any of the following methods:

- Enter the path to the destination directly
- Specify the path by browsing the network for the destination

Entering the path to the destination manually

You can enter the path to the destination folder manually.

1 Press [Manual Entry].

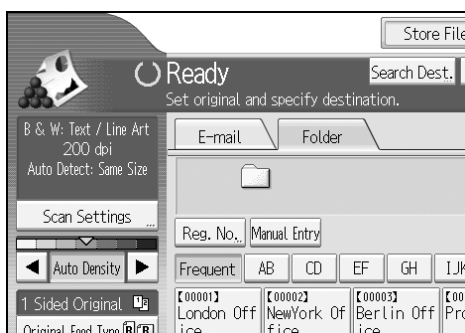

2 Press [SMB].

3 Press [Manual Entry] on the right side of the path field.

The soft keyboard appears.

4 Enter the path for the folder.

The following is an example of a path where the folder name is “user” and the computer name is “desk01”: \\desk01\user.

Instead of specifying the destination using its path, you can also use its IPv4 address.

5 Press **[OK]**.

6 Depending on the destination setting, enter the user name for logging on to the client computer.

Press **[Manual Entry]** to the right of the user name field to display the soft keyboard.

7 Depending on the destination setting, enter the password for logging on to the client computer.

Press **[Manual Entry]** for the password to display the soft keyboard.

8 Press **[Connection Test]**.

A connection test is performed to check whether the specified shared folder exists.

9 Check the connection test result, and then press **[Exit]**.

10 Press **[OK]**.

Note

- If authentication is required to access the folder, the login screen appears. Enter the user name and password.
- If you change the protocol after entering the path name, user name, or password, a confirmation message appears.
- IPv4 address entry is supported by Windows 2000/XP/Vista and Windows Server 2003/2003 R2.
- Computer and shared folder names containing more than 12 characters cannot be displayed.
- To change the path for the folder that has been entered, press **[Change]** on the left side of the destination field. Enter the correct path for the folder, and then press **[OK]**.
- The connection test may take time.
- You may not be able to press **[Connection Test]** right after pressing **[Cancel]** during a connection test.
- Even if the connection test was successful, the machine may fail to transfer the file if you do not have write privileges for the file or there is not enough free hard disk space.
- You can register the path to the destination in the machine's address book. For details, see "Registering the Path to the Selected Destination in the Address Book".

Reference

p.60 "Registering the Path to the Selected Destination in the Address Book"

Specifying the path by browsing the network for destinations

You can browse computers on the network for the destination folder, and then specify the path.

1 Press **[Manual Entry]**.

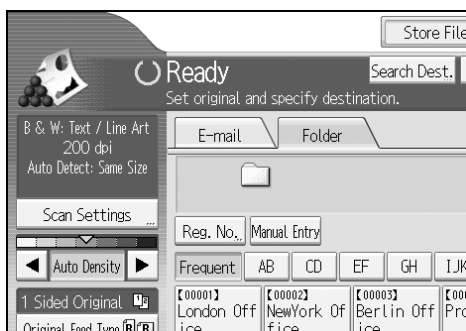

2 Press **[SMB]**.

3 Press **[Browse Network]** under the path name field.

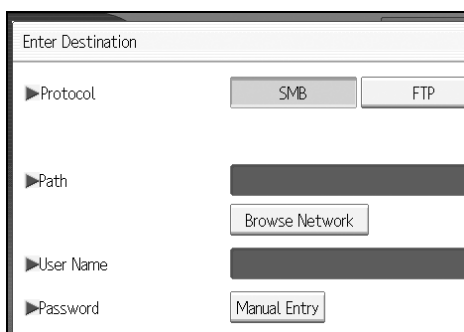

Domains or workgroups on the network appear.

4 Select the domain or workgroup in which the destination folder is located.

5 Select the client computer that has the destination folder.

If you cannot find the computer you are looking for, press **[Up One Level]** and browse that level.

If authentication is required to access the selected computer, the authentication screen appears. To authenticate, enter the user name and password.

6 Select the destination folder.

When the selected folder has sub-folders, the sub-folders list appears.

If you cannot find the destination folder, press **[Up One Level]**, and then search for the folder at that level.

7 Press **[OK]** twice.

 **Note**

- If authentication is required to access the folder, the login screen appears. Enter the user name and password.
- If you change the protocol after entering the path name, user name, or password, a confirmation message appears.
- Computer and shared folder names containing more than 12 characters cannot be displayed.
- Up to 100 computers or shared folders can be displayed.
- The machine may fail to transfer the file if you do not have the write privileges for the shared folder or there is not enough free hard disk space.
- You can register the path to the destination in the machine's address book. For details, see "Registering the Path to the Selected Destination in the Address Book".

 **Reference**

p.60 "Registering the Path to the Selected Destination in the Address Book"

Sending Files to an FTP Server

This section explains how to specify destinations when sending files to an FTP server.

Entering the path to an FTP server manually

2

You can enter the path to an FTP server manually.

1 Press **[Manual Entry]**.

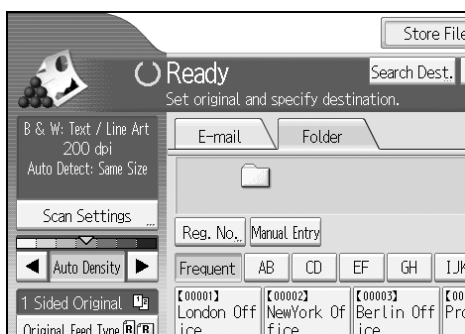

2 Press **[FTP]**.

3 Press **[Manual Entry]** on the right side of the server name field.

The soft keyboard appears.

4 Enter a server name.

Instead of specifying the destination using its path, you can also use its IPv4 address.

5 Press **[Manual Entry]** on the right side of the path field.

6 Enter the path for the folder.

The following is an example of a path where the folder name is “user” and the subfolder name is “lib”: user\lib.

7 Press **[OK]**.

8 Enter the user name according to the setting at the destination.

Press **[Manual Entry]** to the right of the user name field to display the soft keyboard.

9 Enter the password according to the setting at the destination.

Press **[Manual Entry]** next to the password field to make the soft keyboard appear.

10 To change the port number which is set in **[System Settings]**, press **[Change]** on the right side of the port number field. Enter a port number using the number keys, and then press the **[#]** key.

11 Press **[Connection Test]**.

A connection test is performed to check whether the specified folder exists.

12 Check the connection test result, and then press **[Exit]**.

13 Press **[OK]**.

 **Note**

- If you change the protocol after entering the path name, user name, or password, a confirmation message appears.
- The connection test may take time.
- You may not be able to press **[Connection Test]** right after pressing **[Cancel]** during a connection test.
- To change the registered path to a destination folder, press **[Edit]** to the left of the destination field to display the soft keyboard, enter the new path, and then click **[OK]**.
- You can register the path to the destination in the machine's address book. For details, see "Registering the Path to the Selected Destination in the Address Book".
- The machine may fail to transfer the file if you do not have write privileges for the folder or there is not enough free hard disk space.

 **Reference**

p.60 "Registering the Path to the Selected Destination in the Address Book"

Sending Files to an NDS Tree or NetWare Server

This section explains how to specify destinations when sending files to an NDS tree or NetWare server.

You can send a file to an NDS tree or NetWare server by any of the following methods:

- Enter the path to the NDS tree or NetWare server directly
- Specify the path by browsing the NDS tree or NetWare server for the destination

Reference

p.46 “Selecting the Destination from the Machine’s Address Book”

Entering the path to an NDS tree or NetWare server manually

You can enter the path to an NDS tree or NetWare server manually.

1 Press [Manual Entry].

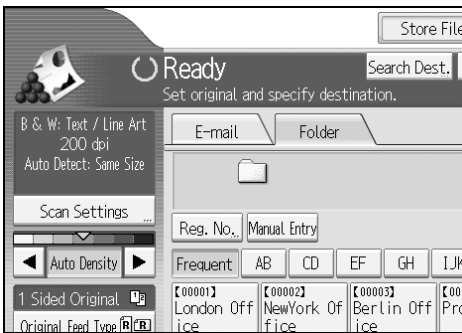

2 Press [NCP].

3 Select the connection type. Press [NDS] to specify the folder in the NDS tree. Press [Bindery] to specify the folder on the NetWare server.

4 Press [Manual Entry] on the right side of the path field.

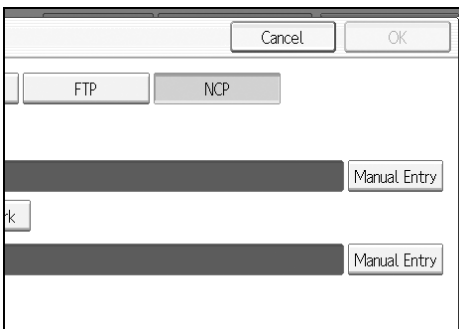

The soft keyboard appears.

5 Enter the path for the folder.

If you set the connection type to **[NDS]**, the NDS tree name is “tree”, the name of the context including the volume is “context”, the volume name is “volume”, and the folder name is “folder”, the path will be “\\tree\volume.context\folder”.

If you set the connection type to **[Bindery]**, the NetWare server name is “server”, the volume name is “volume”, and the folder name is “folder”, the path will be “\\server\volume\folder”.

6 Press **[OK]**.**7** Enter the user name for logging on to the NDS tree or NetWare server.

Press **[Manual Entry]** to the right of the user name field. The soft keyboard appears.

If you press **[NDS]** for **[Connection Type]**, enter the user name, and then enter the name of the context containing the user object. If the user name is “user” and the name of the Context is “context”, the user name will be “user.context”.

8 If a password is specified for the log on user, enter it.

Press **[Manual Entry]** to the right of the password field. The soft keyboard appears.

9 Press **[Connection Test]**.

A connection test is performed to check whether the specified share folder exists.

10 Check the connection test result, and then press **[Exit]**.**11** Press **[OK]**. **Note**

- If you change the protocol after entering the path name, user name, or password, a confirmation message appears.
- To change a registered path to a destination folder, press **[Edit]** to the left of the destination field to display the soft keyboard, enter the correct path to the folder, and then press **[OK]**.
- You can connect only to folders that you have the read privileges for.
- The connection test may take time.
- You may not be able to press **[Connection Test]** right after pressing **[Cancel]** during a connection test.
- Even if the connection test was successful, the machine may fail to transfer the file if you do not have write privileges for the file or there is not enough free hard disk space.
- You can register the path to the destination in the machine’s address book. For details, see “Registering the Path to the Selected Destination in the Address Book”.

 **Reference**

p.60 “Registering the Path to the Selected Destination in the Address Book”

Specifying the path to a destination folder in an NDS tree or on a NetWare server by browsing the network

You can browse the network and specify the path to a destination folder in an NDS tree or on a NetWare server.

- 1 Press **[Manual Entry]**.
- 2 Press **[NCP]**.
- 3 Select the connection type. Press **[NDS]** to browse the NDS tree. Press **[Bindery]** to browse the NetWare server.
- 4 Press **[Browse Network]** under the path name field.

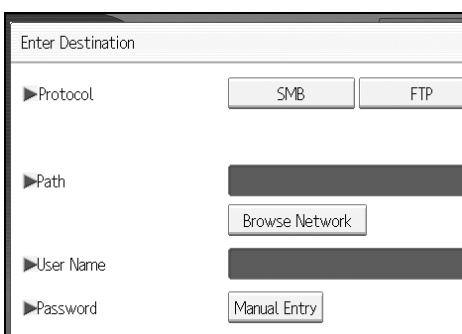

If you selected **[NDS]** under **[Connection Type]**, the NDS tree list appears.

If you selected **[Bindery]** under **[Connection Type]**, the NetWare server list appears.

- 5 Search for the destination folder in the NDS tree or NetWare server.
If you cannot find the destination folder, press **[Up One Level]**, and then search for the folder at that level.
- 6 Select the destination folder.
- 7 Press **[OK]** twice.

 **Note**

- If you change the protocol after entering the path name, user name, or password, a confirmation message appears.
- Only folders that you have the read privileges for are displayed.
- If the language used for the NDS tree or by the NetWare server differs from that used by the machine, file names in the NDS tree or on the NetWare server might appear garbled.
- Up to 100 items can be displayed.

- ❑ If the selected NDS tree or NetWare server requires authentication, a login screen appears. Enter a user name and password for logging on to the NDS tree or NetWare server. If you log on to the NDS tree, enter a user name, and then enter the name of the context containing the user object. If the user name is "user" and the name of the Context is "context", the user name will be "user.context".
- ❑ The machine may fail to transfer the file if you do not have write privileges for the folder or there is not enough free hard disk space.
- ❑ You can register the path to the destination in the machine's address book. For details, see "Registering the Path to the Selected Destination in the Address Book".

Reference

p.60 "Registering the Path to the Selected Destination in the Address Book"

Registering the Path to the Selected Destination in the Address Book

This section explains how to register folder paths you have entered manually or specified by browsing the network to the machine's address book.

1 In the destination field, display the destination you want to register.

2

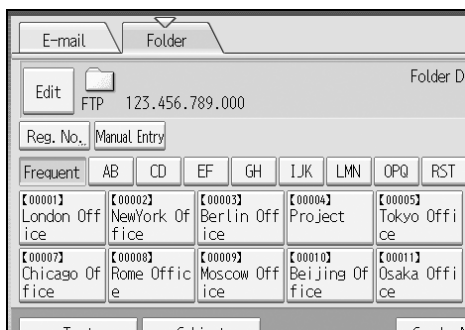

2 Press [Prg. Dest.].



3 Press [Names], and then specify the name and other information to be registered.

For details about specifying the information to be registered, see General Settings Guide.

4 Press [OK].

Note

- Depending on the security setting, [Prg. Dest.] may not appear.

Simultaneous Storage and Sending by Scan to Folder

This section explains how to store a file and simultaneously send it by Scan to Folder.

1 Press [Store File].

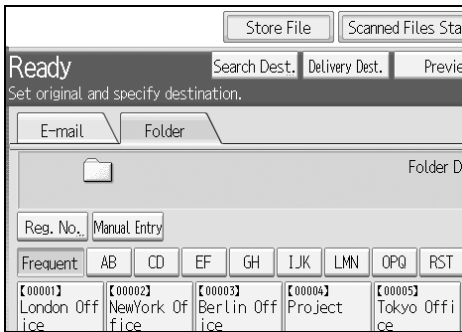

2 Make sure that [Send & Store] is selected.

3 If necessary, specify file data, such as [User Name], [File Name], and [Password].

For details, see “Specifying File Information for a Stored File”.

4 Press [OK].

5 Specify the setting for sending the file by Scan to Folder, and then send the file.

For details about sending a file by Scan to Folder, see “Basic Operations When Using Scan to Folder”.

Note

- Depending on the security setting, [Access Privileges] may appear instead of [User Name]. For details about specifying [Access Privileges], consult the administrator.
- If you simultaneously store scan files and send them by Scan to Folder, the files cannot be retransmitted from the Scan to Folder screen. To retransmit the files, select the files on the Select Stored File screen, and then send them. For details, see “Sending a Stored File”.

Reference

- p.67 “Specifying File Information for a Stored File”
- p.43 “Basic Operations When Using Scan to Folder”
- p.77 “Sending a Stored File”

3. Storing Files Using the Scanner Function

Using the scanner function, you can store scan files in the machine and then send the stored files by e-mail or Scan to Folder.

Before Storing Files

This section outlines file storage under the scanner function and provides related cautions.

Outline of File Storage under the Scanner Function

This section outlines storing files under the scanner function.

Important

- You can specify a password for each stored file. Files that are not password-protected can be accessed by other users on the same local area network using DeskTopBinder. It is recommended that you protect stored files from unauthorized access by specifying passwords.
- Scan file stored in the machine may be lost if some kind of failure occurs. We advise against using the hard disk to store important files. The supplier shall not be responsible for any damage that may result from the loss of files. For long-term storage of files, we recommend the use of DeskTopBinder. For details, contact your local dealer.

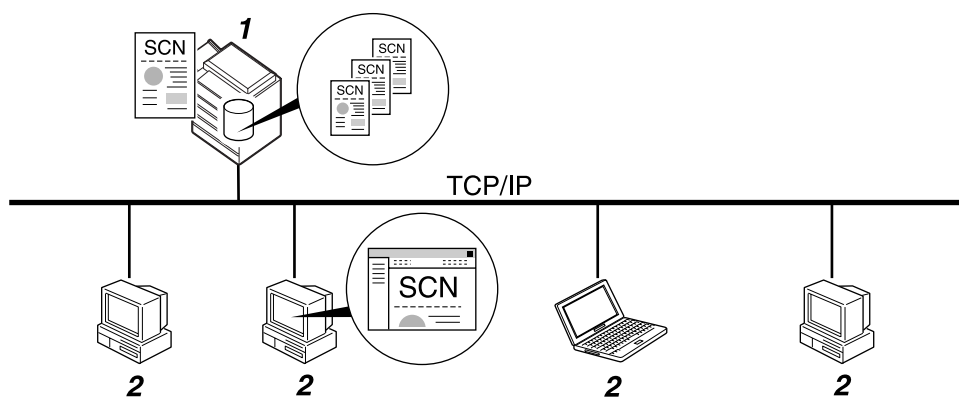

ZZZ512S

1. This Machine

You can store scan files on the machine's hard disk. The stored files can be sent by e-mail, Scan to Folder, or the network delivery scanner.

2. Client Computer

Using DeskTopBinder, you can, over the network, view, copy, or delete files stored in the machine. Using Web Image Monitor, you can, over the network, view, download, send, or delete files stored in the machine. For details about DeskTopBinder Lite, see DeskTopBinder Lite-related manuals. For details about Web Image Monitor, see Web Image Monitor Help.

Note

- Stored files will be deleted after a set period. For details about specifying the period, see General Settings Guide.
- Files stored under the scanner function cannot be printed from the machine's control panel. Print the files from a client computer after receiving them on the computer.
- You can also store a file and simultaneously send it by e-mail or Scan to Folder, or store it and simultaneously deliver it. For details, see "Simultaneous Storage and Sending by E-mail", "Simultaneous Storage and Sending by Scan to Folder", and "Simultaneous Storage and Delivery".

Reference

- p.34 "Simultaneous Storage and Sending by E-mail"
- p.61 "Simultaneous Storage and Sending by Scan to Folder"
- p.102 "Simultaneous Storage and Delivery"

Basic Operation for Storing Scan Files

This section describes the basic operation for storing scan files.

1 Make sure that no previous settings remain.

If a previous setting remains, press the **[Clear Modes]** key.

2 Place originals.

3 If necessary, press **[Scan Settings]** to specify scanner settings such as resolution and scan size.

For details, see “Various Scan Settings”.

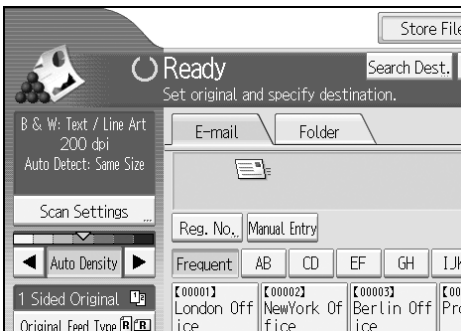

4 If necessary, specify the scanning density.

For details, see “Adjusting Image Density”.

5 If necessary, press **[Original Feed Type]** to specify settings such as original orientation.

For details, see “Setting of Original Feed Type”.

6 Press **[Store File]**.

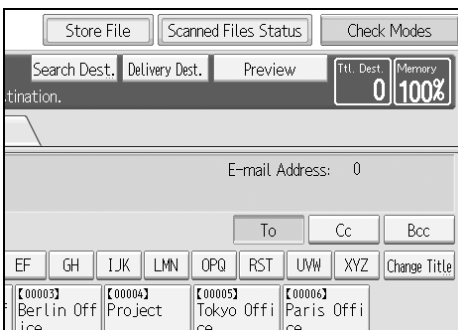

7 Press **[Store Only]**.

8 If necessary, specify file information, such as **[User Name]**, **[File Name]**, and **[Password]**.

For details, see “Specifying File Information for a Stored File”.

9 Press **[OK]**.

10 Press the **[Start]** key.

If you are scanning batches, place the next originals.

 **Note**

- Depending on the security setting, **[Access Privileges]** may appear instead of **[User Name]**. For details about specifying **[Access Privileges]**, consult the administrator.
- By pressing **[Send & Store]**, you can simultaneously store scan files and send them. For details, see “Simultaneous Storage and Sending by E-mail”, “Simultaneous Storage and Sending by Scan to Folder”, and “Simultaneous Storage and Delivery”.
- If a destination or sender has been selected, you cannot press **[Store Only]**.
- To cancel scanning, press the **[Clear / Stop]** key.

 **Reference**

p.109 “Various Scan Settings”

p.120 “Adjusting Image Density”

p.121 “Setting of Original Feed Type”

p.67 “Specifying File Information for a Stored File”

p.34 “Simultaneous Storage and Sending by E-mail”

p.61 “Simultaneous Storage and Sending by Scan to Folder”

p.102 “Simultaneous Storage and Delivery”

Specifying File Information for a Stored File

You can specify data for a stored file, such as user name, file name, and password.

By specifying data for a stored file, you can search for the file by user name or file name, or protect the file with a password to prevent other people from accessing the file.

Specifying a User Name

You can specify a user name for the stored file.

1 Press [Store File].

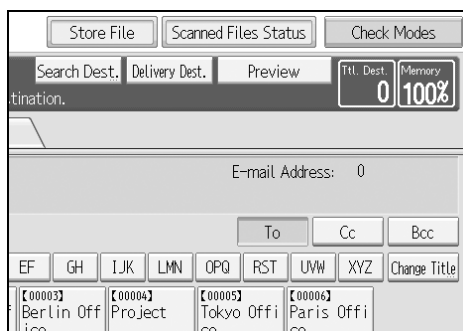

The Store File screen appears.

2 Press [User Name].

A list of user names appears.

3 Press the user name you want to specify.

The user names shown here are names that were registered on the **[Administrator Tools]** tab in **[System Settings]**. To specify a name not shown here, press **[Manual Entry]**, and then enter the user name.

4 Press [OK] twice.

Note

- Depending on the security setting, **[Access Privileges]** may appear instead of **[User Name]**. For details about specifying **[Access Privileges]**, consult the administrator.

Specifying a File Name

This section explains how to change the name of a stored file.

A stored file is allocated a name starting with “SCAN” followed by a 4-digit number.

- Example: SCAN0001

You can change this file name.

1 Press [Store File].

3

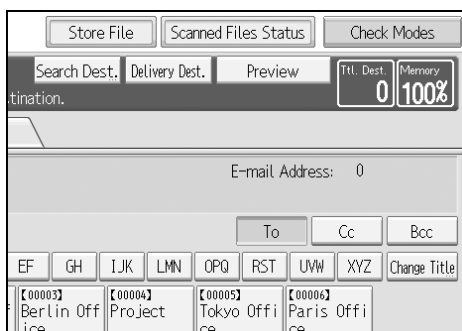

The Store File screen appears.

2 Press [File Name].

The soft keyboard appears.

3 Change the file name.

4 Press [OK] twice.

Note

- For details about entering the text, see About This Machine.

Specifying a Password

You can specify a password for the stored file.

Important

- Do not forget the password. If you forget it, consult the system administrator of the machine.

By specifying a password, you can ensure that only the people who know the password can view the file.

1 Press [Store File].

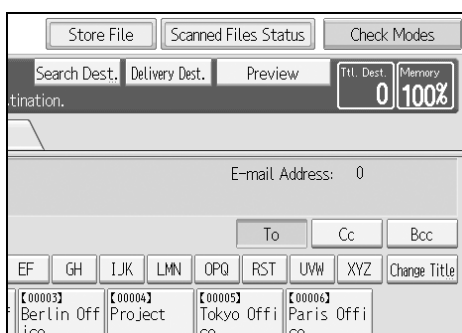

The Store File screen appears.

2 Press [Password].

3 Using the number keys, enter a four to eight-digit number.

4 Press [OK].

5 Enter the same number again using the number keys.

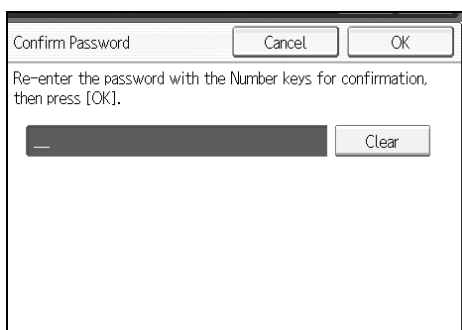

6 Press [OK] twice.

Displaying the List of Stored Files

This section describes the list of stored files.

Using the list of stored files, you can delete stored files or change the file data.

List of Stored Files

This section describes how the list of stored files is displayed.

To display the list of stored files, press **[Select Stored File]** on the initial scanner screen.

The list of stored files appears as follows:

The function items displayed serve as selector keys. You can select or specify an item by pressing it. When you select or specify an item on the display panel, it is highlighted like **[TFF]**. Keys that cannot be selected appear like **[OK]**.

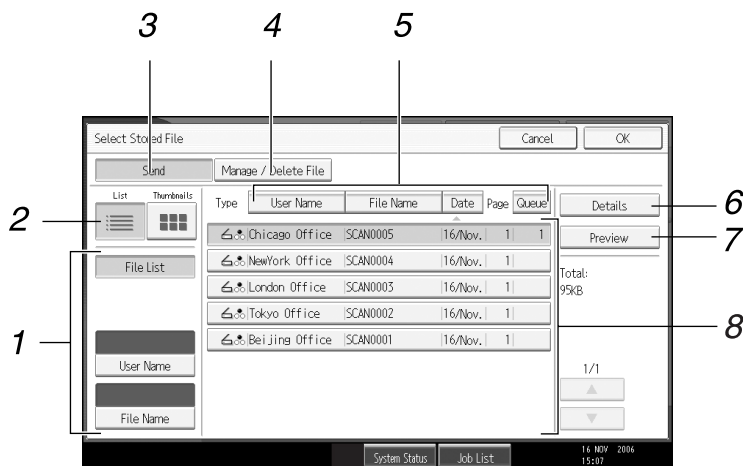

1. Keys for searching for files

Press to switch to the screens for searching for a file by user name or file name, or to the screen for displaying all files.

2. List/ Thumbnails

You can select whether to display stored files as a list or as thumbnails.

3. [Send]

Press this to deliver or send a stored file by e-mail or Scan to Folder.

4. [Manage / Delete File]

Press this to delete stored files or change the file data.

5. Keys for sorting files

Press to sort the files using the selected item. Select the same item once more for a reverse sort. However, the files cannot be sorted in reverse delivery.

6. [Details]

Press this to display details about the selected file.

7. [Preview]

Press this to display a preview of the selected file. For Detail, see "Checking a Stored File Selected from the List".

8. List of stored files

Displays the list of stored files.

If the selected file does not appear, press **[▲]** or **[▼]** to scroll the screen. If a password has been specified for a file, a key icon appears to the left of the user name for the file.

Note

- Depending on the security setting, some files may not appear in the list.
- Files stored under functions other than the scanner function do not appear on this screen.

Reference

p.74 “Checking a Stored File Selected from the List”

Searching the List of Stored Files

You can search for files from the stored files using the user name or file name. You can search the list of stored files by either of the following methods:

- Search by user name
- Search by file name

Searching by user name

You can search for a stored file by its user name.

1 Press **[Select Stored File]**.

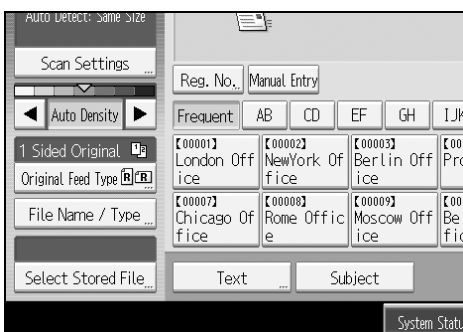

2 Press **[User Name]**.

3 Select the user name to be used for the search.

The user names shown here are names that were registered on the **[Administrator Tools]** tab in **[System Settings]**. To change a user name not shown here, press **[Manual Entry]**, and then enter the user name.

4 Press **[OK]**.

The search begins, and then files belonging to the specified user appear.

Searching by file name

You can search for a stored file by its file name.

- 1 Press **[Select Stored File]**.



- 2 Press **[File Name]**.

The soft keyboard appears.

- 3 Enter the file name.

For information about how to enter characters, see About This Machine.

- 4 Press **[OK]**.

The search starts, and files whose name starts with the entered string appear.

Checking Stored Files

You can display the Preview screen and check a stored file on the machine or from the client computer.

Checking a Stored File Selected from the List

This section explains how to preview a file selected from the list of stored files.

3

1 Press [Select Stored File].



The list of stored files appears.

For details about the list of stored files, see “List of Stored Files”.

2 From the list of stored files, select the file you want to check.

You can select more than one file.

3 Press [Preview].

A preview of the selected stored file appears.

Reference

p.70 “List of Stored Files”

Stored File Preview Screen

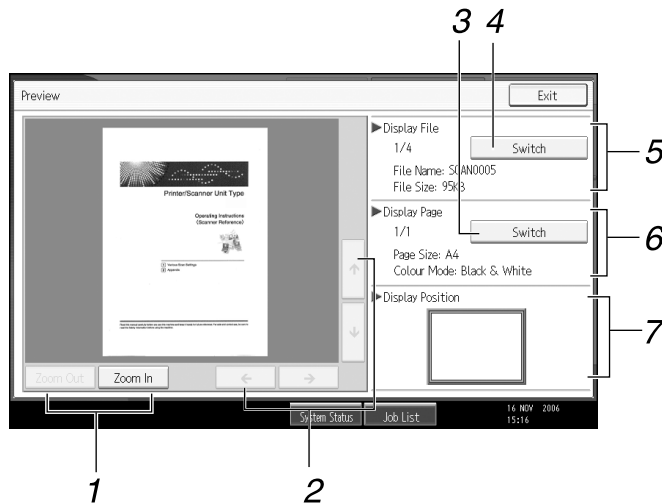

ALQ022S

1. [Zoom Out], [Zoom In]

In previewing, you can reduce or enlarge the file image.

2. [←][→][↑][↓]

You can scroll the preview screen.

3. [Switch]

You can switch to a preview of another page.

4. [Switch]

You can switch to a preview of another file.

5. Display File

The name and size of the selected file appear.

6. Display Page

The page number of the previewed page, total number of pages, page size, and color mode appear.

7. Display Position

When the preview is enlarged, the location of the part of the page displayed on the preview screen is indicated.

Checking Stored Files from a Client Computer

Using DeskTopBinder Lite or Web Image Monitor, you can also display the list of files stored in the machine on a client computer.

Important

- To view stored files from a client computer, you must first make the required IP address settings using DeskTopBinder or Web Image Monitor.

You can also check files stored under the copier, Document Server, and printer functions.

3

Using DeskTopBinder Lite to display stored files

The stored files are displayed and can be checked on a client computer using DeskTopBinder Lite.

Note

- You can also transfer the stored files to the client computer.
- For details about DeskTopBinder, see the DeskTopBinder-related manuals.
- For details about installing DeskTopBinder Lite, see “Installing DeskTopBinder Lite from the Supplied CD-ROM”.

Reference

p.87 “Installing DeskTopBinder Lite from the Supplied CD-ROM”

Using Web Image Monitor to Display Stored Files

The stored files are displayed and can be checked also on a client computer using Web Image Monitor.

When you enter `http:// (machine IPv4 address)/` in the address bar of the Web browser on a client computer, the top page of Web Image Monitor appears.

Note

- You can also download the stored files.
- It is recommended that you use Web Image Monitor only within your local area network.
- For details about displaying or downloading stored files using Web Image Monitor, see Copy/ Document Server Reference.
- For details about making settings for using Web Image Monitor, see Network Guide.
- For details about functions for managing stored files using Web Image Monitor, click **[Help]** on the upper-right corner of the displayed screen.

Sending a Stored File

You can either send the selected file or the URL of the file location.

This section mainly explains how to select the files you want to send by e-mail or Scan to Folder, or deliver using the network delivery scanner. For details about operating procedures for individual functions, see the appropriate chapters.

Sending Stored Files

This section explains how to send a stored file.

1 Press [Select Stored File].

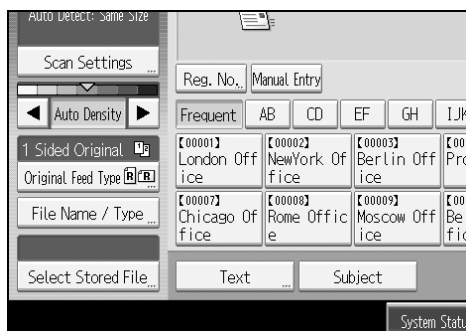

The list of stored files appears.

2 Select the file you want to send.

To select more than one file, repeat this step.

If you select more than one file, the files are sent or delivered in the selected order.

By pressing [Queue], you can send the selected files one by one.

3 Press [OK].

The E-mail screen, Scan to Folder screen, or network delivery scanner screen appears.

4 If necessary, switch the screen.

5 Specify the settings for sending files by e-mail or Scan to Folder, or using the network delivery scanner.

For details about how to send a file by e-mail or Scan to Folder, or how to deliver a file, see “Basic Operation for Sending Files by E-mail”, “Basic Operations When Using Scan to Folder”, or “Basic Operation for Delivering Files”.

6 Press the [Start] key.

The selected files are sent by e-mail or Scan to Folder, or using the network delivery scanner.

 **Note**

- If you choose a file protected by a password, a screen to enter the password appears. To select the file, enter the correct password, and then press **[OK]**.
- When you send a stored file by e-mail, either the file can be attached to the e-mail or the URL of the file location can be sent. This setting must be made in advance in **[Scanner Features]**. For details, see General Settings Guide.

 **Reference**

p.14 "Basic Operation for Sending Scan Files by E-mail"

p.43 "Basic Operations When Using Scan to Folder"

p.89 "Basic Operation for Delivering Files"

Managing Stored Files

This section explains how to delete stored files and how to change the data for stored files.

Deleting a Stored File

This section explains how to delete a stored file.

1 Press [Select Stored File].

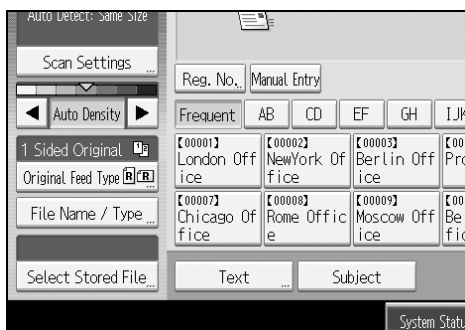

The list of stored files appears.

2 Press [Manage / Delete File].

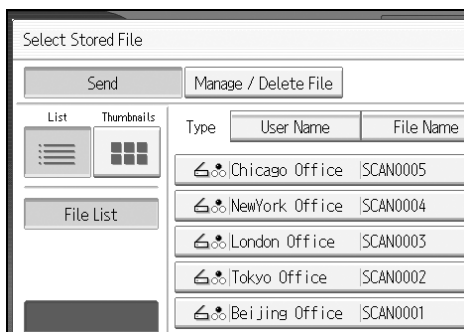

The [Manage / Delete File] screen appears.

3 Select the file you want to delete.

4 Press [Delete File].

A confirmation message about deleting the file appears.

5 Press [Yes].

Note

- Files waiting for delivery cannot be deleted.
- You can also delete files stored in the machine by accessing the machine from a client computer using Web Image Monitor or DeskTopBinder. For detail about Web Image Monitor, see Web Image Monitor Help. For details about DeskTopBinder, see the manuals supplied with DeskTopBinder.

Changing Data for a Stored File

You can change data for a stored file, such as **[User Name]**, **[File Name]**, and **[Password]**.

Note

Information for files waiting for delivery cannot be changed.

Changing a user name

You can change the user name for a stored file.

1 Press **[Select Stored File]**.

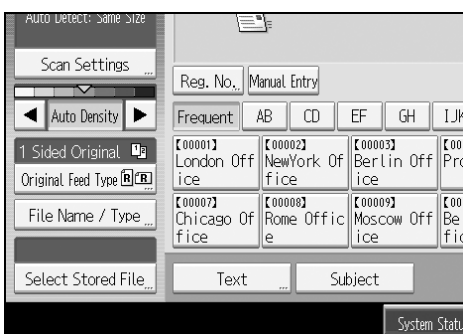

The list of stored files appears.

2 Press **[Manage / Delete File]**.

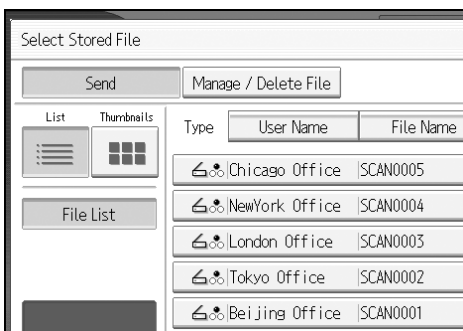

3 Select the file containing the file information you want to change.

If you select a password-protected file, a screen for entering the password appears. Enter the password, and then press **[OK]**.

4 Press **[Change User Name]**.

5 Enter a new user name.

The user names shown here are names that were registered on the **[Administrator Tools]** tab in **[System Settings]**. To change a user name not shown here, press **[Manual Entry]**, and then enter the user name.

6 Press **[OK]**.**7** Make sure that the user name was changed as necessary, and press **[Exit]**. **Note**

- Using Web Image Monitor or DeskTopBinder, you can also change the user name of a file stored in the machine from the client computer. For details about Web Image Monitor, see Web Image Monitor Help. For details about DeskTopBinder, see the manuals supplied with DeskTopBinder.
- Depending on the security setting, **[Change Access Priv.]** may appear instead of **[Change User Name]**. For details about specifying **[Change Access Priv.]**, consult the administrator.

Changing a file name

You can change the file name of a stored file.

1 Press **[Select Stored File]**.

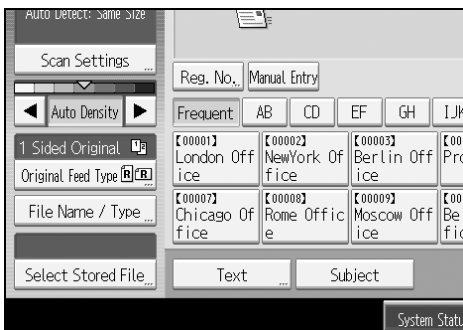

The list of stored files appears.

2 Press **[Manage / Delete File]**.

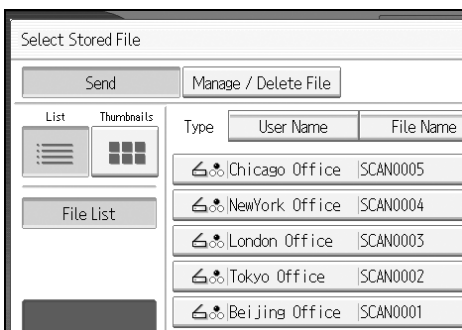

3 Select the file containing the file information you want to change.

If you select a password-protected file, a screen for entering the password appears. Enter the password, and then press **[OK]**.

4 Press **[Change File Name]**.

5 Change the file name.

6 Press **[OK]**.

7 Make sure that the file information was changed as necessary, and press **[Exit]**.

Note

- For information about how to enter characters, see About This Machine.
- Using Web Image Monitor or DeskTopBinder, you can also change the name of a file stored in the machine from the client computer. For details about Web Image Monitor, see Web Image Monitor Help. For details about DeskTopBinder, see the manuals supplied with DeskTopBinder.

Changing a password

Enter the password for accessing the stored file.

Important

- Be sure not to forget the password. If you forget it, consult the system administrator of the machine.

1 Press **[Select Stored File]**.



The list of stored files appears.

2 Press **[Manage / Delete File]**.

3 Select the file containing the file information you want to change.

If you select a password-protected file, a screen for entering the password appears. Enter the password, and then press **[OK]**.

4 Press **[Change Password]**.

5 Using the number keys, enter a new four to eight-digit password.

6 Press **[OK]**.

7 Enter the same number again using the number keys.

8 Press **[OK]**.

Note

- Using Web Image Monitor or DeskTopBinder, you can also change the password of a file stored in the machine from the client computer. For details about Web Image Monitor, see Web Image Monitor Help. For details about DeskTopBinder, see the manuals supplied with DeskTopBinder.

4. Delivering Scan Files

Using the ScanRouter delivery software, you can deliver by various methods scan files produced by the machine.

Before Delivering Files

This section describes the necessary preparations and the procedure for using the network delivery scanner.

Important

- ❑ To use the network delivery scanner function, you need a delivery server on which the optional the ScanRouter delivery software is installed. You also need to register data about destinations and senders in the delivery server.

Outline of Scan File Delivery

This section outlines the function for delivering files using the network delivery scanner.

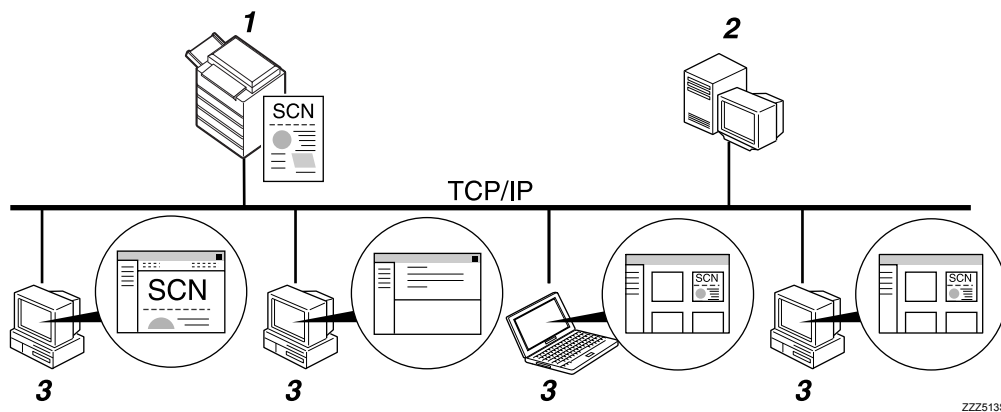

1. This machine

You can send scan files to the delivery server.

2. Delivery server

Install the ScanRouter delivery software on this computer to use it as the delivery server.

After receiving a scan file, the delivery server delivers the file according to the setting specified for the destination. The delivery settings are as follows:

- Storing the file in an in-tray
- Delivering the file by e-mail

- Storing the file in a selected folder
- For details about the ScanRouter delivery software, see the manuals supplied with the ScanRouter delivery software.

3. Client Computer

How to check a file from the client computer depends on the delivery method.

For example, you can check a file by one of the following methods:

- Use DeskTopBinder to view a file delivered to the in-tray
- Use e-mail software to receive e-mail with an attached file
- Browse a folder for a stored file

Preparing to Deliver a File

This section describes the preparations and settings for delivering scan files.

Important

- To use the network delivery scanner, you need a delivery server on which an application such as the optional the ScanRouter delivery software is installed. For details about the ScanRouter delivery software, see the manuals supplied with the ScanRouter delivery software.
- To view files delivered to an in-tray, DeskTopBinder must be installed on the client computer.

1 Connect the machine to the network.

Connect the machine to the network using an Ethernet cable or wireless LAN (IEEE 802.11b).

2 Make the necessary network settings in **[System Settings]**.

If you have connected the machine to the network using an Ethernet cable, make the following settings. For details, see General Settings Guide.

- Specify the machine's IPv4 address and subnet mask
- In **[Effective Protocol]**, enable **[IPv4]**
- Set **[Delivery Option]** to **[On]**

3 If necessary, change settings in **[Send Settings]** under **[Scanner Features]**.

4 Using the ScanRouter delivery software, register this machine as an I/O device. In addition, specify register destinations and specify such settings as the delivery type and sender.

For details, see the manuals supplied with the ScanRouter delivery software.

Note

- To connect the machine to the network using a wireless LAN (IEEE 802.11b), an extended wireless LAN board is required respectively. For details, see Network Guide.
- Items to set up in **[System Settings]** vary depending on the network environment. For details about the network settings, see General Settings Guide.
- For details about installing DeskTopBinder Lite, see "Installing DeskTopBinder Lite from the Supplied CD-ROM".

Reference

p.87 "Installing DeskTopBinder Lite from the Supplied CD-ROM"

Installing DeskTopBinder Lite from the Supplied CD-ROM

This section explains how to install DeskTopBinder Lite on a client computer from the supplied “Scanner/PostScript® Drivers and Utilities” CD-ROM.

To view or receive files delivered to the in-trays, you must install DeskTopBinder Lite on the client computer.

- 1** Make sure Windows is running on the client computer, and then insert the “Scanner/PostScript® Drivers and Utilities” CD-ROM into the CD-ROM drive.

The installer is automatically started and the **[Scanner/PostScript® Drivers and Utilities]** dialog box appears.

- 2** Click **[DeskTopBinder Lite]**.

The **[DeskTopBinder Lite Setup]** dialog box appears.

For the subsequent installation steps, see the Setup Guide displayed from the **[DeskTopBinder Lite Setup]** dialog box.

Note

- Before you start the installation, check the system requirements for DeskTopBinder Lite. For details, see “Software Supplied on CD-ROM”.
- You can install the software using the auto-run program. For details about the auto-run program, see “Quick Install”.

Reference

p.153 “Software Supplied on CD-ROM”

p.153 “Quick Install”

Network Delivery Scanner Screen

This section describes the screen layout when using the network delivery scanner.

The function items displayed serve as selector keys. You can select or specify an item by pressing it. When you select or specify an item on the display panel, it is highlighted like [**TIFF**]. Keys that cannot be selected appear like [**OK**].

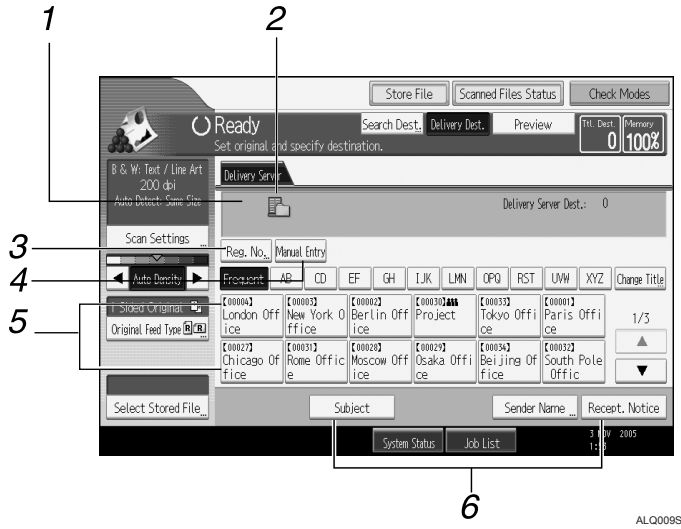

1. Destination Field

The specified destination appears. If more than one destination has been specified, press [▲] or [▼] to scroll through the destinations.

2. Network delivery scanner icon

Indicates that the network delivery scanner screen is displayed.

3. [Reg. No.]

Press this key to specify the destination using a 3-digit registration number.

4. [Manual Entry]

To send a file by e-mail via the delivery server to a destination not registered in the delivery server's Destination List, press this key to display the soft keyboard. Then use the soft keyboard to enter the e-mail address. For details about how to send a file by e-mail via the delivery server, see the ScanRouter delivery software manual.

5. Destination List

The list of destinations registered in the delivery server appears. If all of the destinations cannot be displayed, press [▲] or [▼] to switch the screen. Group destinations are denoted by this symbol (###).

6. [Subject][Sender Name][Recept. Notice]

Specify the subject, sender, and whether or not to enable Message Disposition Notification for the file to be transmitted.

Basic Operation for Delivering Files

This section describes the basic operation for delivering scan files using the network delivery scanner.

Important

- ❑ You must register destinations and senders in advance using the ScanRouter delivery software installed on the delivery server.

1 Make sure that no previous settings remain.

If a previous setting remains, press the **[Clear Modes]** key.

2 If the E-mail screen or Scan to Folder screen appears, switch to the network delivery scanner screen.

For details, see “Switching to the Network Delivery Scanner Screen”.

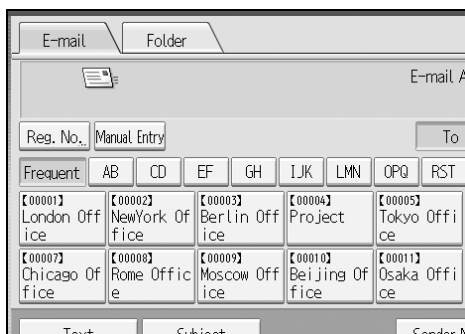

3 Place originals.

4 If necessary, press **[Scan Settings]** to specify scanner settings such as resolution and scan size.

For details, see “Various Scan Settings”.

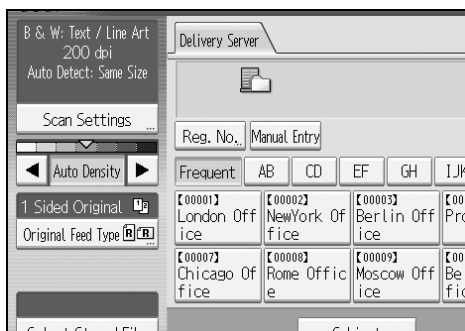

5 If necessary, specify the scanning density.

For details, see “Adjusting Image Density”.

6 If necessary, press **[Original Feed Type]** to specify settings such as original orientation.

For details, see “Setting of Original Feed Type”.

7 Specify the destination.

You can specify multiple destinations.

For details, see “Specifying Delivery Destinations”.

8 If necessary, press **[Subject]** to specify the e-mail subject.

For details, see “Specifying the Subject of the E-mail to Be Transmitted via the Delivery Server”.

9 If necessary, press **[Sender Name]** to specify the sender.

If you specify the sender, data about the sender will be attached to the delivered file. Select the sender from those registered in the delivery server. For details, see “Specifying the Sender”.

10 Press the **[Start]** key.

If you are scanning batches, place the next originals.

 **Note**

- By pressing **[Manual Entry]** on the network delivery scanner screen, you can send a file by e-mail via the delivery server’s network. For details about entering the e-mail address directly, see “Entering an E-mail Address Manually”.
- If you have selected more than one destination, press **[▲]** or **[▼]** next to the destination field to scroll through the destinations.
- To cancel a selected destination, display the destination in the destination field, and then press the **[Clear / Stop]** key. You can cancel a destination selected from the address book by pressing the selected destination again.
- You can use the Message Disposition Notification function when sending e-mail via delivery server. An e-mail is sent to the sender selected in step 9, notifying him/her that the recipient has read his/her e-mail. To specify this setting, press **[Receipt. Notice]**.
- To enable Message Disposition Notification, you must specify the ScanRouter delivery software setting for sending e-mail by SMTP. For details about specifying this setting, see the ScanRouter delivery software manual. Note, however, that if the e-mail software used at the destination does not support Message Disposition Notification, e-mail notification that the e-mail has been opened may not be sent.

- ❑ Register the sender's e-mail address using the ScanRouter delivery software in advance.
- ❑ By pressing the **[Check Modes]** key, you can switch from the initial scanner screen to the Check Modes screen so you can check the settings. For details, see "Check Modes".
- ❑ If you press **[Preview]**, and then scan a document, the Preview screen appears. For details, see "Preview"
- ❑ To cancel scanning, press the **[Clear / Stop]** key.
- ❑ You can also store a scan file and simultaneously deliver it. For details, see "Simultaneous Storage and Delivery".

Reference

p.92 "Switching to the Network Delivery Scanner Screen"

p.109 "Various Scan Settings"

p.120 "Adjusting Image Density"

p.121 "Setting of Original Feed Type"

p.93 "Specifying Delivery Destinations"

p.101 "Specifying the Subject of the E-mail to Be Transmitted via the Delivery Server"

p.97 "Specifying the Sender"

p.22 "Entering an E-mail Address Manually"

p.5 "Preview"

p.4 "Check Modes"

p.102 "Simultaneous Storage and Delivery"

Switching to the Network Delivery Scanner Screen

This section explains how to switch the screen to the network delivery scanner screen.

If the E-mail screen or Scan to Folder screen is being displayed, switch to the network delivery scanner screen.

1 Press **[Delivery Dest.]**.



The network delivery scanner screen appears.

Note

- You cannot switch from the E-mail screen or Scan to Folder screen while destinations or senders are being specified. To clear a specified destination, display the destination in the destination field of the E-mail screen or Scan to Folder screen, and then press the **[Clear / Stop]** key.

Specifying Delivery Destinations

This section explains how to specify delivery destinations.

Selecting Destinations Registered in the Delivery Server's Address Book

This section explains how to select destinations registered in the delivery server's address book

You can select a delivery destination registered in Destination List of the delivery server by any of the following methods:

- Select the destination from the delivery destination list
- Select the destination by entering the registration number
- Select the destination by searching in the delivery server

4

Selecting a destination from the Destination List

From the destination list, select a destination.

1 In the destination list, press the key including the destination name.

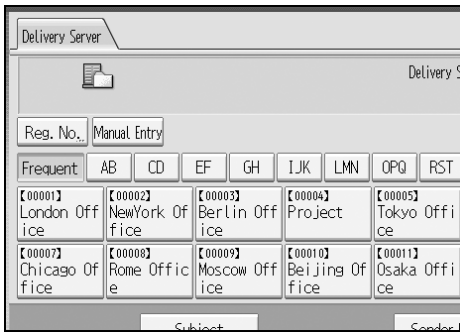

The selected destination is highlighted and also is displayed in the destination field at the top of the screen.

Destinations are registered in the delivery server under captions. The destination list is updated automatically.

Note

- If the target destination does not appear, press [▲] or [▼] to scroll through the destinations until it does.
- Depending on the security setting, some destinations may not appear in the destination list.

Selecting destinations by entering their registration numbers

Select a destination by entering its Short ID number (registered using the ScanRouter delivery software). For details about how to set Short IDs, see the manuals supplied with the ScanRouter delivery software.

1 Press [Reg. No.].

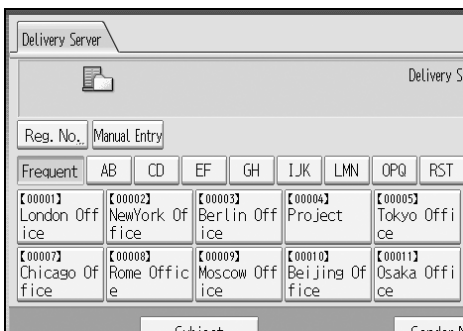

2 Using the number keys, enter the three-digit registration number, and then press the [#] key.

You can also enter a registration number of fewer than three digits.

Example: To enter 009

Press the [9] key, and then press the [#] key.

3 Press [OK].

By pressing [Change], you can change the selected destination.

Note

- To cancel a selected destination, press [▲] or [▼] next to the destination field to scroll through the destinations until the one you want to cancel appears, and then press the [Clear / Stop] key.

Selecting destinations by searching the delivery server's Destination List

In the delivery server's Destination List, you can search for destinations and select them.

1 Press [Search Dest.].

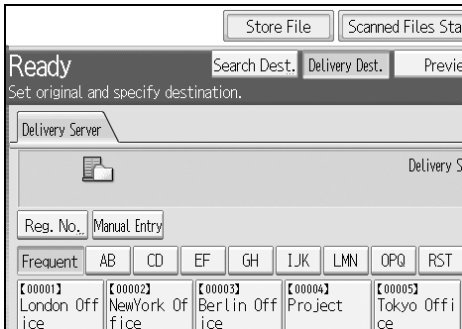

2 To search by destination name, press [Name].

To search by comment, press [Comment].

The soft keyboard appears.

You can also search by combining [Name] and [Comment].

3 Enter the beginning of the destination name.

To search by comment, enter the beginning of the comment.

4 Press [OK].

5 If necessary, press [Advanced Search], and then specify the detailed search criteria.

By pressing [Advanced Search], you can search by [Name] and [Comment]. You can also search by combining the [Beginning Word] or [End Word] criteria with the other criteria.

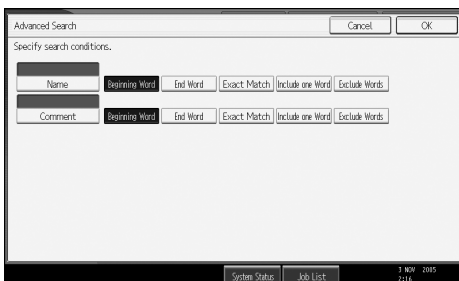

6 Press [Start Search].

Destinations that match the search criteria are displayed.

7 Select the destination.

8 Press [OK].

 **Note**

- The Comment search function searches for destinations by comment information, which is a registration item required by the ScanRouter delivery software.
- By pressing **[Details]**, you can view details about the selected destinations.
- Up to 100 destinations can be displayed as search results.
- By pressing **[Advanced Search]**, the following criteria appear:
 - **[Beginning Word]**: The names which start with the entered character or characters are targeted.
For example, to search for “ABC”, enter “A”.
 - **[End Word]**: The names which end with the entered character or characters are targeted.
For example, to search for “ABC”, enter “C”.
 - **[Exact Match]**: The names which correspond to an entered character or characters are targeted.
For example, to search for “ABC”, enter “ABC”.
 - **[Include one Word]**: The names which contain an entered character or characters are targeted.
For example, to search for “ABC”, enter “A”, “B”, or “C”.
 - **[Exclude Words]**: The names which do not contain an entered character or characters are targeted.
For example, to search for “ABC”, enter “D”.

Specifying the Sender

This section explains how to specify the e-mail sender when sending a file by e-mail via the delivery server.

You can specify the sender by any of the following methods:

- Select the sender from the sender list in the delivery server's Destination List
- Select the sender by entering the registration number
- Select the sender by searching the delivery server's Destination List

Selecting a Sender from the Sender List in the Delivery Server's Destination List

This section explains how to select a sender from the destination list.

1 Press [Sender Name].

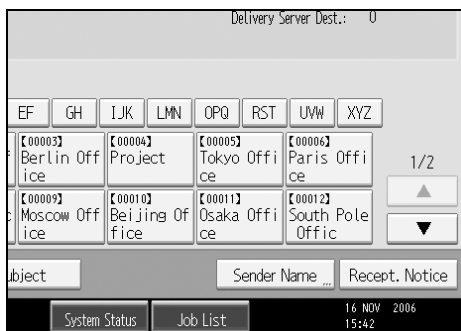

2 Select the sender.

3 Press [OK].

Selecting the Sender by Entering the Registration Number

You can select the sender by entering the registration number.

1 Press [Sender Name].

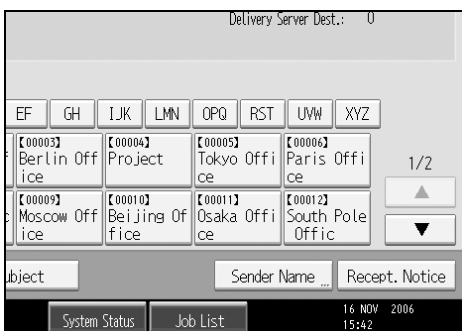

2 Press [Registration No.].

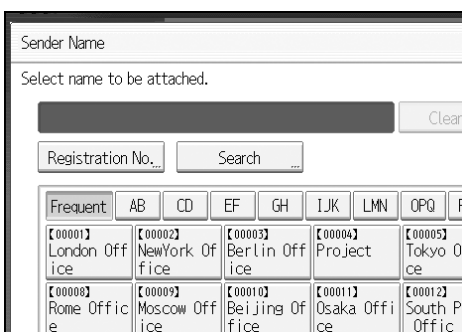

3 Using the number keys, enter the three-digit registration number assigned to the required destination folder.

If the entered number is less than five digits, press the **[#]** key after the last number.

Example: To enter 006

Press the **[6]** key, and then press the **[#]** key.

4 Press [OK].

By pressing **[Change]**, you can change the selected destination.

Note

- For details about specifying **[Short ID]**, see the manuals supplied with the ScanRouter delivery software.

Selecting a Sender by Searching the Delivery Server's Destination List

This section explains how to select a sender by searching the delivery server's Destination List.

1 Press **[Sender Name]**.

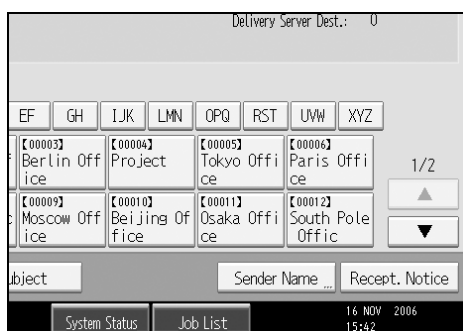

2 Press **[Search]**.

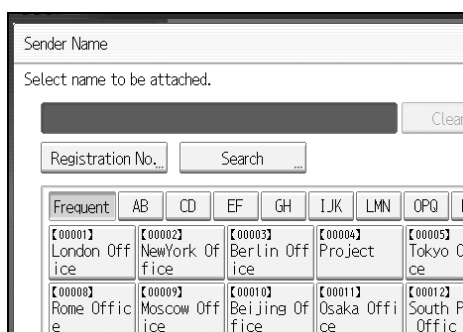

3 To search by destination name, press **[Name]**.

To search by comment, press **[Comment]**.

The soft keyboard appear.

You can also search by combining **[Name]** and **[Comment]**.

4 Enter the beginning of the sender's name.

To search by comment, enter the beginning of the comment.

5 Press **[OK]**.

6 If necessary, press **[Advanced Search]**, and then specify the detailed search criteria.

By pressing **[Advanced Search]**, you can search by **[Name]** and **[Comment]**. You can also search by combining the **[Beginning Word]** or **[End Word]** criteria with the other criteria.



4

7 Press **[Start Search]**.

Destinations that match the search criteria are displayed.

8 Select the sender.

9 Press **[OK]**.

Note

- The Comment search function searches for destinations by comment information, which is a registration item required by the ScanRouter delivery software.
- By pressing **[Details]**, you can view details about the selected destinations.
- Up to 100 items can be displayed as the search results.
- By pressing **[Advanced Search]**, the following criteria appear:
 - **[Beginning Word]**: The names which start with the entered character or characters are targeted.
For example, to search for “ABC”, enter “A”.
 - **[End Word]**: The names which end with the entered character or characters are targeted.
For example, to search for “ABC”, enter “C”.
 - **[Exact Match]**: The names which correspond to an entered character or characters are targeted.
For example, to search for “ABC”, enter “ABC”.
 - **[Include one Word]**: The names which contain an entered character or characters are targeted.
For example, to search for “ABC”, enter “A”, “B”, or “C”.
 - **[Exclude Words]**: The names which do not contain an entered character or characters are targeted.
For example, to search for “ABC”, enter “D”.

Specifying the Subject of the E-mail to Be Transmitted via the Delivery Server

This section explains how to specify the e-mail subject when sending a file by e-mail via the delivery server.

1 Press [Subject].

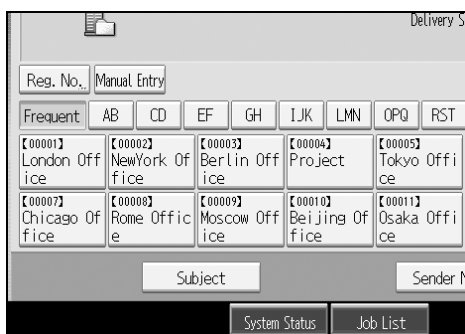

The soft keyboard appears.

2 Enter the subject.

3 Press [OK].

Simultaneous Storage and Delivery

This section explains how to store a file and simultaneously deliver it.

1 Press [Store File].

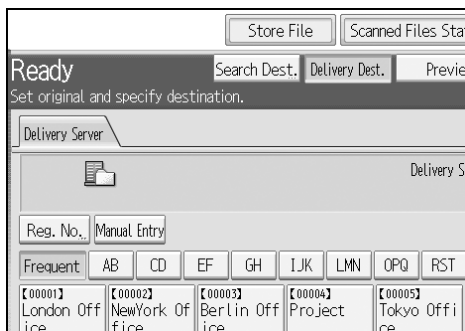

4

2 Make sure that [Send & Store] is selected.

3 If necessary, specify file data, such as [User Name], [File Name], and [Password].

For details, see “Specifying File Information for a Stored File”.

4 Press [OK].

5 Specify the setting for delivering the file, and then send the file.

For details about delivering a file, see “Basic Operation for Delivering Files”.

Note

- A file which is simultaneously stored and delivered cannot be resent from the network delivery scanner screen. To resend the file, select it on the Select Stored File screen, and then send it. For details, see “Sending a Stored File”.

Reference

p.67 “Specifying File Information for a Stored File”

p.89 “Basic Operation for Delivering Files”

p.77 “Sending a Stored File”

5. Scanning Originals with the Network TWAIN Scanner

Using the machine, you can scan originals into a client computer over the network.

Before Using the Network TWAIN Scanner

This section describes the preparations and procedure for using the network TWAIN scanner.

Important

- ❑ To use the network TWAIN scanner, you must install the TWAIN driver, which is on the supplied CD-ROM. For details about installing the TWAIN driver, see “Installing the TWAIN Driver from the Supplied CD-ROM”.
- ❑ To use the network TWAIN scanner, a TWAIN-compliant application, such as DeskTopBinder, must be installed on the client computer. DeskTopBinder Lite is on the supplied CD-ROM. For details about installing DeskTopBinder Lite, see “Installing DeskTopBinder Lite from the Supplied CD-ROM”.

Reference

p.106 “Installing the TWAIN Driver from the Supplied CD-ROM”

p.87 “Installing DeskTopBinder Lite from the Supplied CD-ROM”

Outline of the Network TWAIN Scanner

This section outlines the network TWAIN scanner function.

In the TWAIN scanner mode, you can share this machine among multiple computers. Therefore, you don't have to prepare a special computer for scanner or reconnect the scanner and each computer every time you need to use it.

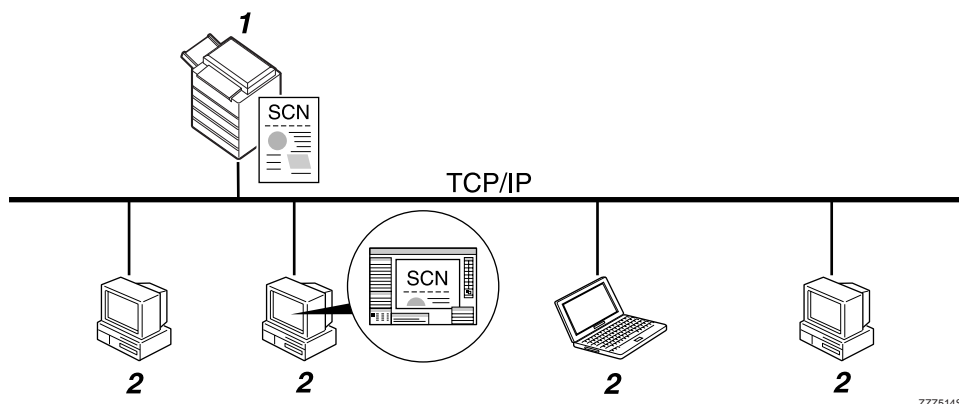

ZZZ514S

1. This Machine

Scans an original after receiving a scan instruction from a client computer, and then sends the scan file over the network to the client computer.

2. Client Computer

Specifies the scanner settings and controls the scanner using an application, such as DeskTopBinder Lite, that supports the network TWAIN scanner. Receives the files scanned by the machine and displays them using an application that supports the network TWAIN scanner.

Note

- When using the machine as a network TWAIN scanner, you do not need to press the **[Scanner]** key on the machine's control panel. The screen switches automatically when you scan an original from a client computer using the TWAIN driver.

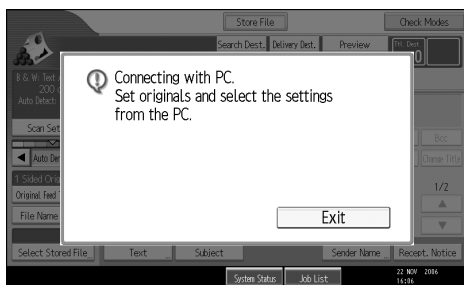

To use functions other than the network TWAIN scanner, press **[Exit]**.

Preparing to Use the Network TWAIN Scanner

This section describes the preparations and settings for using the machine as a network TWAIN scanner.

Important

- To use the network TWAIN scanner, an application that supports the scanner, such as DeskTopBinder Lite, must be installed on the computer. DeskTopBinder Lite is on the supplied CD-ROM. For details about installing DeskTopBinder Lite, see “Installing DeskTopBinder Lite from the Supplied CD-ROM”.

1 Connect the machine to the network.

Connect the machine to the network using an Ethernet cable or Wireless LAN (IEEE 802.11b).

2 Make the necessary network settings in [System Settings].

If you have connected the machine to the network using an Ethernet cable, make the following settings. For details, see General Settings Guide.

- Specify the machine’s IPv4 address and subnet mask
- In [Effective Protocol], enable [IPv4]

3 Install the TWAIN driver on a client computer.

For details about installing the TWAIN driver, see “Installing the TWAIN Driver from the Supplied CD-ROM”.

Note

- To connect the machine to network using a wireless LAN (IEEE 802.11b), an extended wireless LAN board is required respectively. For details, see Network Guide.
- For details about [System Settings], see General Settings Guide.
- Items to set up in [System Settings] vary depending on the network environment. For details about the network settings, see General Settings Guide.

Reference

p.106 “Installing the TWAIN Driver from the Supplied CD-ROM”

p.87 “Installing DeskTopBinder Lite from the Supplied CD-ROM”

Installing the TWAIN Driver from the Supplied CD-ROM

This section explains how to install the TWAIN driver on a client computer from the supplied “Scanner/PostScript® Drivers and Utilities” CD-ROM.

To use the network TWAIN scanner, you must install the TWAIN driver on a client computer.

- 1 Start Windows, and then insert the CD-ROM labeled “Scanner/PostScript® Drivers and Utilities” into the CD-ROM drive of the client computer.**

The installer is automatically started and the **[Scanner/PostScript® Drivers and Utilities]** dialog box appears.

- 2 Click [TWAIN Driver].**

- 3 The installer of the TWAIN Driver starts. Follow the instructions.**

Note

- Before you start the installation, check the system requirements for the TWAIN driver. For details about the system requirements, see “Software Supplied on CD-ROM”.
- You can install the software using the auto-run program. For details about the auto-run program, see “Quick Install”.
- If the installer does not start automatically, see “Quick Install”.
- When the installation is complete, a message about restarting the client computer may appear. In this case, restart the client computer.
- After the installation is complete, a folder with the name of the machine in use is added in **[Program]** on the **[Start]** menu. Help can be displayed from here.
- Notes on using the network TWAIN scanner are provided in “Readme.txt”. Be sure to read them before use.

Reference

p.153 “Software Supplied on CD-ROM”

p.153 “Quick Install”

Basic Network TWAIN Scanner Operation

This section describes the basic operation for scanning with the network TWAIN scanner.

Important

- ❑ To use the network TWAIN scanner, a TWAIN-compliant application, such as DeskTopBinder and the TWAIN driver must be installed on the client computer.

The following procedure uses Windows XP and DeskTopBinder Lite by way of example.

1 On the [Start] menu, point to [Program], point to [DeskTopBinder], and then click [DeskTopBinder].

2 On the [Tools] menu, click [Scanner Settings...].

3 Click [Select Scanner Driver...].

4 Select the name of the machine you want to use in the list, and then click [Select...].

5 Click [OK].

6 Place originals.

7 On the [File] menu, point to [Add Document], and then click [Scan...] to display the Scanner Control dialog box.

The Scanner Control dialog box and DeskTopBinder viewer will appear.

8 Make settings according to such factors as the type of original, type of scanning, and orientation of the original.

For details, see the TWAIN driver Help.

9 In the Scanner Control dialog box, click [Scan...].

Depending on the security setting, if you press [Scan...], a dialog box for entering the user name and password may appear.

If there are more originals to be scanned, place the next original, and then click [Scan...].

If there are no more originals to be scanned, click [Complete].

10 On the [File] menu of the DeskTopBinder viewer, click [Exit].

11 Enter the file name, and then click [OK].

The DeskTopBinder viewer closes and the image is stored in DeskTopBinder Lite.

 **Note**

- If you have already selected a scanner, you do not need to select the scanner unless you want to change it.
- Using DeskTopBinder, you can edit and print scan files. For more information about DeskTopBinder, see DeskTopBinder manuals.
- The model name of the connected scanner appears in the title bar of the Scanner Control dialog box. If there is more than one scanner of the same model on the network, make sure you have selected the correct scanner. If you have not, click **[Select Scanner Driver...]**, and then select the scanner again. If the correct scanner does not appear in the list, check that the scanner is correctly connected to the network and that its IPv4 address has been specified. If the correct scanner still does not appear, consult the network administrator.

6. Various Scan Settings

This section describes various scan settings.

Scan Settings

This section explains how to make Scan settings.

1 Press [Scan Settings].

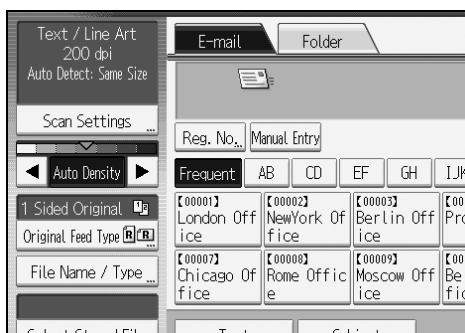

2 Specify resolution, scan size, and other settings, as required.

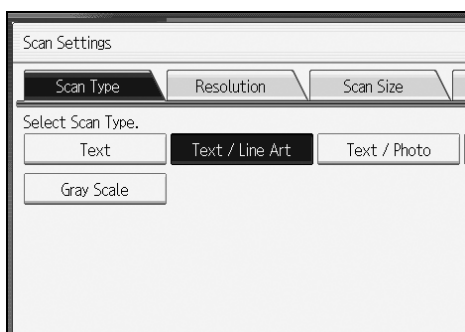

3 Press [OK].

Items for Specifying Scan Settings

This section describes the items for Scan Settings.

Scan Type

Select a scan type that is appropriate for your original.

- ❖ **[Text]**
Appropriate to increase OCR readability using an OCR-compliant application.
- ❖ **[Text / Line Art]**
Standard black and white originals containing mainly characters. Creates scanned images suitable for printing.
- ❖ **[Text / Photo]**
Originals containing a mixture of photographs, pictures and characters (two-value). Creates scanned images suitable for printing.
- ❖ **[Photo]**
Originals containing photographs and other pictures (two-value). Creates scanned images suitable for printing.
- ❖ **[Gray Scale]**
Originals containing photographs and other pictures (multi-value). Creates scanned images suitable for displaying on a computer screen.

Resolution

Select resolution for scanning originals.

Select **[100 dpi]**, **[200 dpi]**, **[300 dpi]**, **[400 dpi]**, or **[600 dpi]** as the scanning resolution.

Scan Size

Select the size of the original to be scanned.

The following items and sizes can be selected:

❖ [Auto Detect]

Scans original sizes using the automatic size detect function.

❖ [Mixed Sizes]

Scans a batch of originals of the same width by different length by detecting the length of each.

❖ Template size

A3 , A4 , A4 , A5 , A5 , 11 × 17 , 8¹/₂ × 14 , 8¹/₂ × 13 , 8¹/₂ × 11 , 8¹/₂ × 11 , 5¹/₂ × 8¹/₂ , 5¹/₂ × 8¹/₂ , B4 JIS , B5 JIS , B5 JIS

❖ [Custom Size]

Scans in a specified size.

You can specify the dimensions (width and height) of the scan area in mm.

Note

- You can specify original sizes of 140 mm (X1 and Y1) or larger in **[Custom Size]**.
- When scanning originals of the same width but different length at the same time, place them correctly by referring to the chart below.

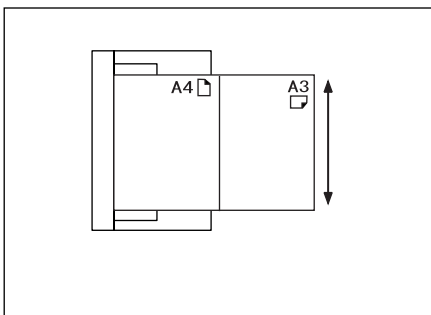

ALQ021S

Relationship of original of mixed sizes and scan size

This section explains differences you need to be aware of when scanning originals of the same width but different length (such as A3 & A4 or B4 & B5) using the original position setting and size.

- If you select **[Mixed Sizes]**, the machine detects the length of same width originals and scans them.
You can place combinations of the following original sizes: A3☐&A4☐, B4☐&B5☐, A4☐&A5☐.
- If a template size is selected, the machine scans originals at the selected size regardless of the actual size of originals. If an original is smaller than the selected size, the machine applies margins to the scan area.
- If **[Auto Detect]** is selected for scanning originals from the exposure glass, the machine detects the size of individual originals and scans accordingly.
- If only **[Auto Detect]** is selected for scanning originals from the ADF, the machine detects the size of the largest original and scans all the other originals based on that size.

6

Setting procedure of custom size when scanning an entire original

This section explains how to set a custom size for scanning an entire original.

To scan the entire area of an original, measure its dimensions and enter them under Original Size (X1 and Y1) and Scan Area (X3 and Y3).

The following example explains how to scan the entire area of an original.

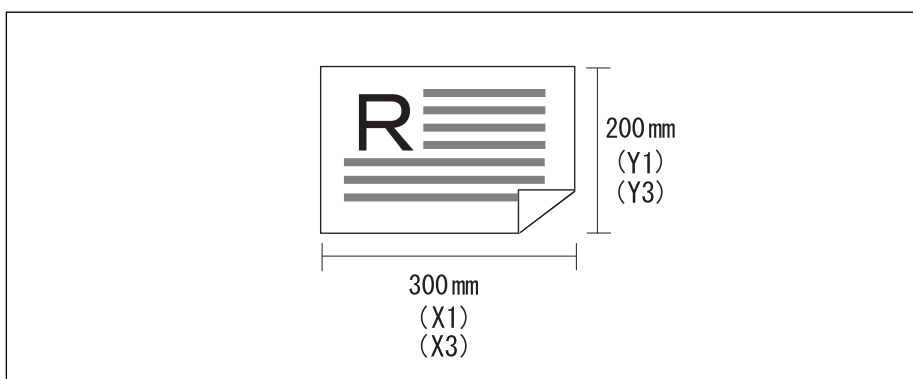

ARE001S

You do not need to specify a Start Position (X2 and Y2). Specify it as 0 mm. For Scan Size, enter the same value as Original Size.

1 Press **[Scan Settings]**.

2 Press **[Scan Size]**.

3 Press **[Custom Size]**.

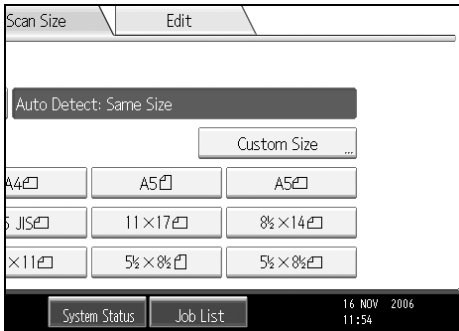

4 Specify Original Size (X1 and Y1) using the number keys, and then press the **[#]** key.

For example, set X1 to 300 mm and Y1 to 200 mm.

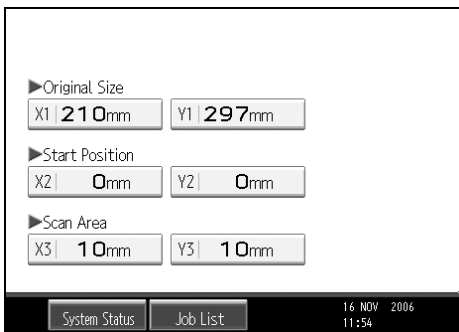

5 Set Start Position (X2 and Y2) to 0 mm, and then press the **[#]** key.

For example, set X2 and Y2 to 0 mm, and press the **[#]** key.

6 Specify Scan Area (X3 and Y3) using the number keys, and then press the **[#]** key.

For example, set X3 to 300 mm and Y3 to 200 mm.

7 Press **[OK]**.

8 Check Scan Area (X3 and Y3) displayed above **[Custom Size]**, and then press **[OK]**.

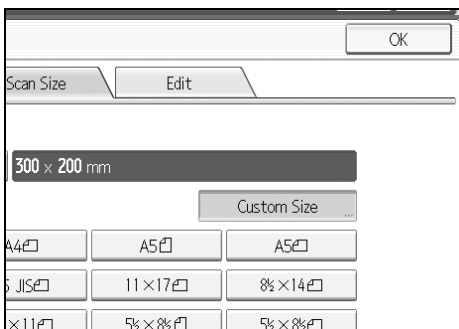

Note

- ❑ You can specify original sizes (X1 and Y1) of 140 mm or larger.
- ❑ To scan an original that is smaller than 140 mm, make settings as though you were scanning a section of an original that is larger than 140 mm. For example, to scan a CD label on the exposure glass, specify a size according to the chart below. For details about scanning procedures, see “Setting procedure of custom size when scanning part of an original”.

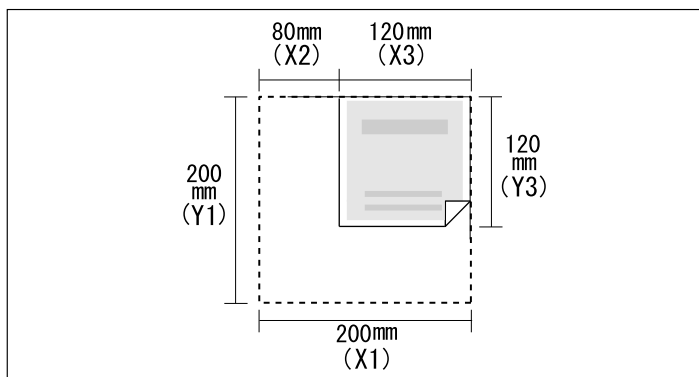

ARE005S

6

Reference

p.115 “Setting procedure of custom size when scanning part of an original”

Setting procedure of custom size when scanning part of an original

This section explains how to set a custom size for scanning an area within an original.

To scan a section of an original, measure Original Size (X1 and Y1), Start Position (X2 and Y2), and Scan Area (X3 and Y3) on the surface of the original, and then enter those values in the same order. Measuring methods differ depending on the original's orientation and the position it is set in. Examples 1 to 3 below show how to measure the size in order to scan the section marked "R". Refer to the following examples to measure each size correctly.

❖ Example 1

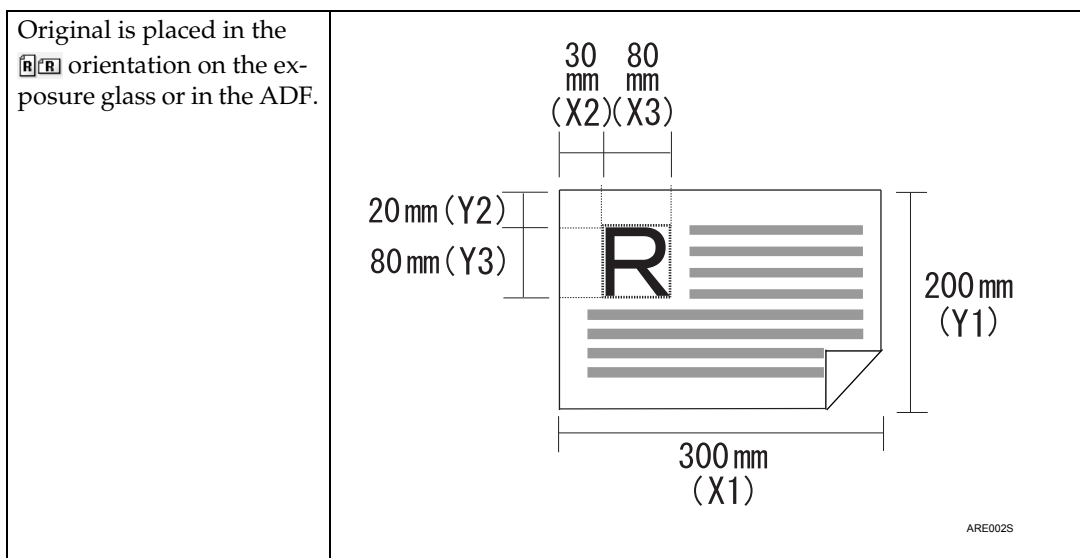

❖ Example 2

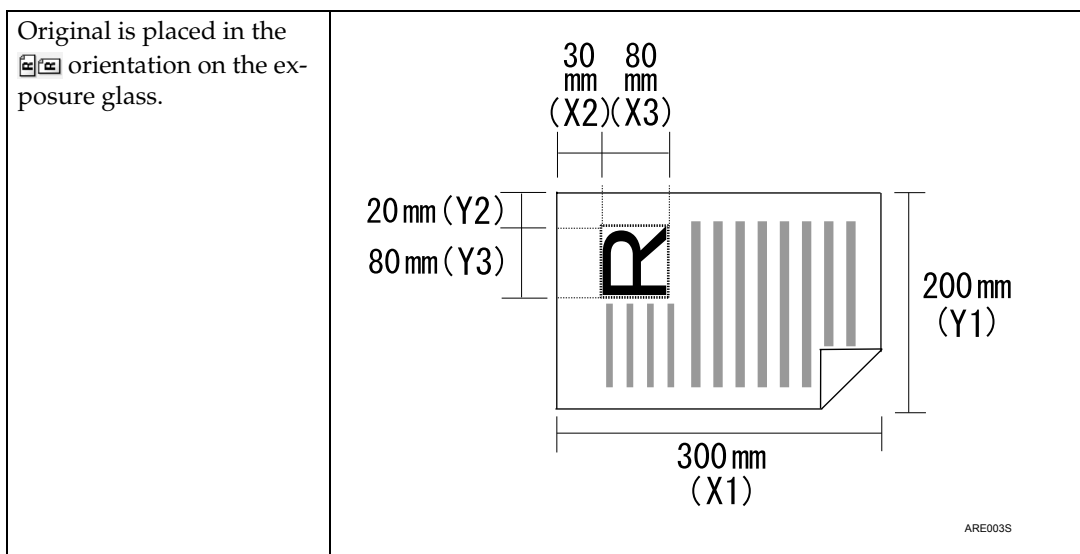

❖ Example 3

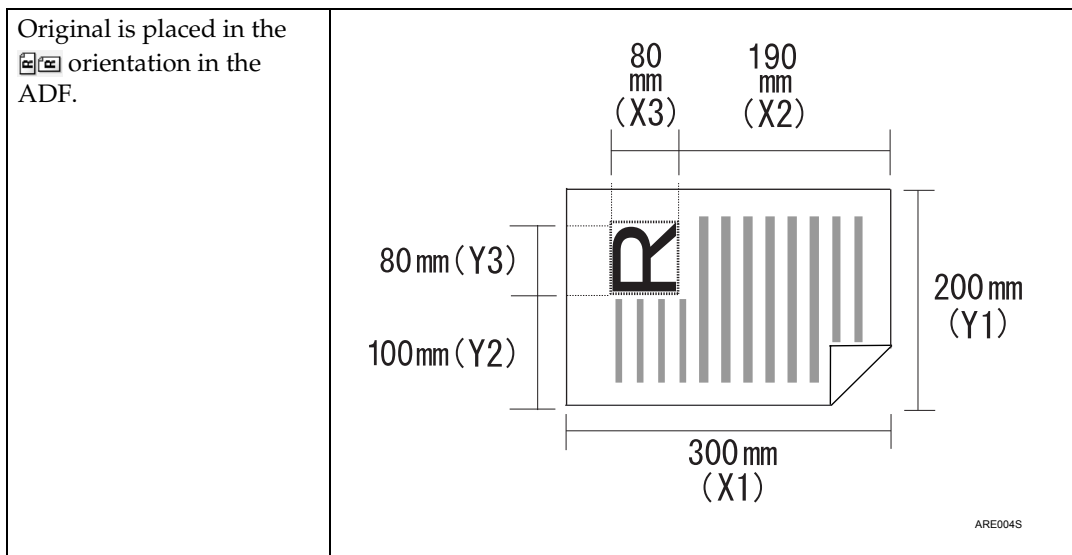

Examples 1 and 2 (above) explain the procedure for scanning the “R” area of the original.

6

1 Press [Scan Settings].

2 Press [Scan Size].

3 Press [Custom Size].

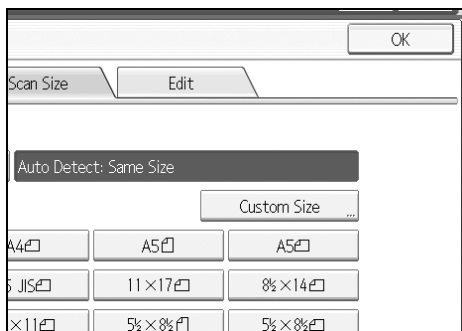

- 4** Specify Original Size (X1 and Y1) using the number keys, and then press the [#] key.

For example, set X1 to 300 mm and Y1 to 200 mm.

The screenshot shows a menu with three sections:

- Original Size:** X1 | 210mm, Y1 | 297mm
- Start Position:** X2 | 0mm, Y2 | 0mm
- Scan Area:** X3 | 10mm, Y3 | 10mm

At the bottom, there are buttons for 'System Status' and 'Job List', and a date/time display: '16 NOV 2006 12:54'.

- 5** Specify Start Position (X2 and Y2) using the number keys, and then press the [#] key.

For example, set X2 to 30 mm and Y2 to 20 mm.

- 6** Specify Scan Area (X3 and Y3) using the number keys, and then press the [#] key.

For example, set X3 and Y3 to 80 mm.

- 7** Press [OK].

- 8** Check Scan Area (X3 and Y3) displayed above [Custom Size], and then press [OK].

The screenshot shows a dialog box titled 'Scan Size' with an 'Edit' tab and an 'OK' button. The main area displays '80 x 80 mm' in a dark box. Below this is a 'Custom Size' button. A grid of size options is shown:

| | | |
|-----|-------|-------|
| A4 | A5 | A5 |
| JIS | 11×17 | 8½×14 |
| ×11 | 5½×8½ | 5½×8½ |

Note

- To scan an original that is smaller than 140 mm, make settings as though you were scanning a section of an original that is larger than 140 mm.

How to set originals to scan them by custom size

This section explains how to place originals you want to scan at Custom size.

❖ Original orientation setting

Under **[Original Orientation]**, select **[R/R]** or **[L/L]** according to the orientation of your original. To display **[Original Orientation]**, on the initial scanner screen, press **[Original Feed Type]**. For details, see “Setting of Original Feed Type”.

❖ Placing an original

Place originals face up in the ADF; face down on the exposure glass.

❖ Original Orientation is **[R/R]**

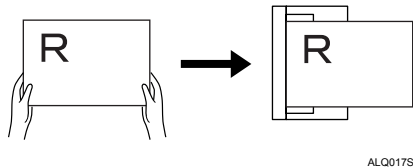
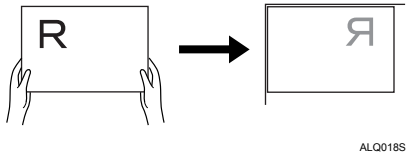
| | |
|--|---|
| <p>Placing an original in the ADF</p> |  |
| <p>Placing an original on the exposure glass Align the original, turn it rightward or leftward, and then place it face down on the exposure glass.</p> |  |

❖ Original Orientation is **[L/L]**

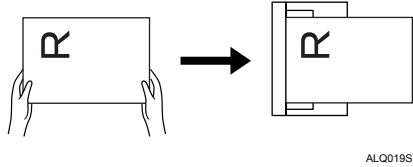
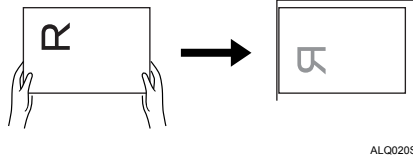
| | |
|--|--|
| <p>Placing an original in the ADF</p> |  |
| <p>Placing an original on the exposure glass Turn the original over, place it face down on the exposure glass, and then align it with the top left corner of the exposure glass.</p> |  |

Reference

p.121 “Setting of Original Feed Type”

Edit

Make editing settings.

❖ **[Erase Border]**

Deletes the borders of the scanned original according to the specified width. If you select **[Same Width]**, you can specify, in mm, a uniform width for deletion all around the original (top, bottom, left, and right sides). If you select **[Different Width]**, you can specify in mm a different width for deletion for each side.

Adjusting Image Density

This section explains how to adjust image density.

To adjust image density, press [**◀**] or [**▶**], at the left and right of [**Auto Density**]. These buttons increase or decrease the image density in single increments up to 7.

Selecting [**Auto Density**] corrects scanning density to improve resolution of paper types such as non-white paper like newspaper or transparent originals. For details, see General Settings Guide.

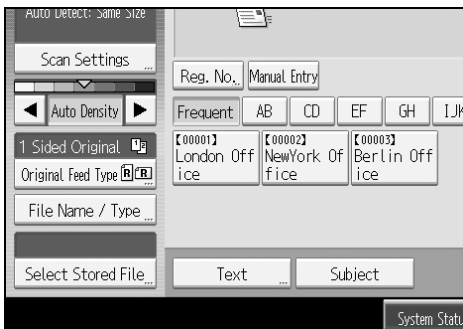

6

Note

- If you select [**Text**], [**Text / Line Art**], or [**Text / Photo**] for [**Scan Type**] under [**Scan Settings**], [**Auto Density**] is automatically selected.

Setting of Original Feed Type

This section explains Original Feed Type settings such as orientation and scan sides of originals.

Original Orientation

This section explains how to correctly display the top/bottom orientation of scanned originals on a client computer screen.

1 Press [Original Feed Type].

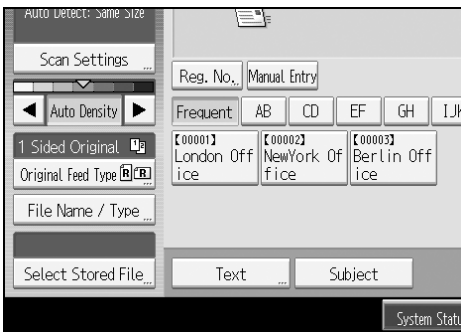

2 Press [R/R] or [B/B] to select the same orientation as that of original.

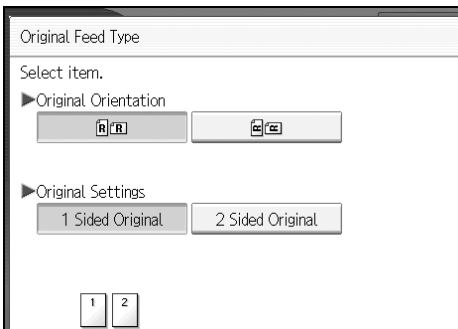





3 Press [OK].

Placing Originals



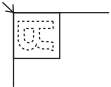

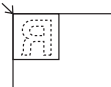
To correctly display the top/bottom orientation of the scanned original on a client computer, the placement of the original and the settings made on the control panel must match.

Place originals correctly by referring to the following table:

❖ **Exposure Glass**



| Original orientation | Control Panel Key |
|---|--|
| top edge touches top left corner of exposure glass  |  |
| top edge touches rear of exposure glass  |  |

❖ **ADF**

| Original orientation | Control Panel Key |
|--|---|
| top edge placed first  |  |
| top edge touches rear of ADF  |  |

 **Note**

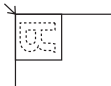
- ❑ Originals are normally rectangular (☐) or horizontally long (▭). However, the table above uses squares to make original orientation easier to understand. Even if the actual shape of the original is different, the combination of original orientation and the orientation specified on the scanner driver does not change.
- ❑ When you specify Gray Scale for Scan Type, and single page TIFF/JPEG or multi-page TIFF is selected as the file type, refer to the table below for how to place originals. Originals placed in orientations that are not recommended in the table might appear incorrectly top/bottom oriented on client computer displays.

| | |
|---|---|
| Placing an Original on the Exposure Glass |  |
| Placing an Original in the ADF |  |

Original Settings

This section explains the settings for the scanning the sides of originals.

One-sided original

This section explains the settings for scanning only one side of originals.

1 Press **[Original Feed Type]**.

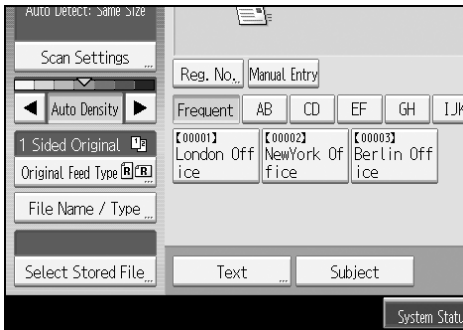

2 In **[Original Settings]**, select **[1 Sided Original]**.

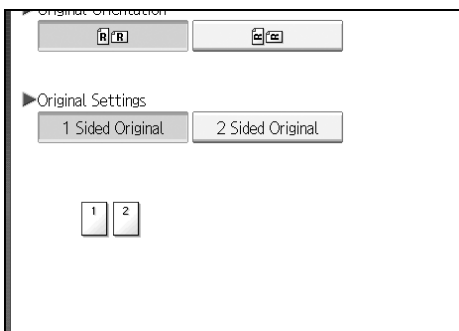

3 Press **[OK]**.

Two-sided original

This section explains the settings for scanning both sides of originals.

1 Press **[Original Feed Type]**.



2 In **[Original Settings]**, select **[2 Sided Original]**.

3 In **[Page Opening Orientation]**, select **[Top to Top]** or **[Top to Bottom]** according to the binding orientation of the originals.

6

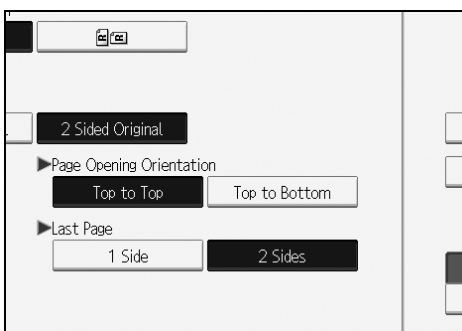

| | |
|---------------|--|
| Top to Top | |
| Top to Bottom | |

4 If the last page of the last original is blank, in **[Last Page]**, select **[1 Side]** or **[2 Sides]**.

To skip the last page, select **[1 Side]**.

To scan the last page as blank page, select **[2 Sides]**.

5 Press **[OK]**.

Note

- If you selected **[Divide]**, the setting made here is applied to the last page of each batch of divided originals.

Batch, SADF

This section explains settings for scanning multiple originals in several batches. To scan the originals as a single file, select **[Batch]**.

To scan the originals individually in the ADF, select **[SADF]**.

- If you select **[Batch]**, scanning starts as soon as you place the additional originals and press the **[Start]** key. When all the originals have been scanned, press the **[#]** key. If you select **[Batch]**, regardless of the default settings, the machine waits until additional originals are placed.
- If **[SADF]** is selected, scanning starts as soon as you place additional originals in the ADF. Select which operation the machine performs while waiting for additional originals in **[Wait Time for Next Original(s): SADF]** under **[Scanner Features]**. For details about **[Wait Time for Next Original(s): SADF]**, see General Settings Guide “Scan Settings”.

1 Press [Original Feed Type].



2 Select [Batch] or [SADF].

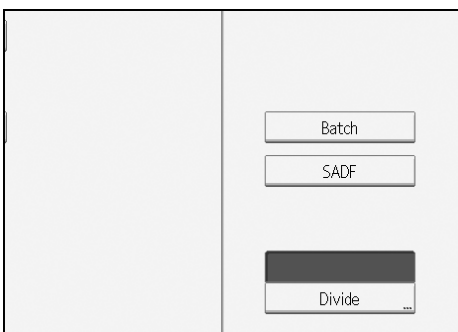

3 Press [OK].

 **Note**

- If **[SADF]** is selected, scanning starts as soon as you place additional originals in the ADF. However, in the following cases you must press the **[Start]** key to start scanning additional originals.
 - After scanning additional originals using the exposure glass
 - After changing settings while waiting for additional originals
 - After opening/closing the ADF

 **Reference**

p.129 “Scanning Multiple Pages of Originals as One File”

Divide

This section explains settings for dividing multiple originals by a specified number of pages and then sending them.

1 Press **[Original Feed Type]**.

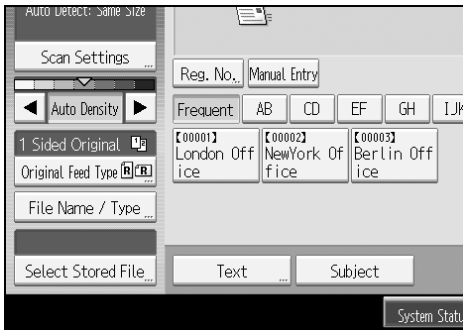

2 Press **[Divide]**.



3 Press **[Change]**, and then use the number keys to enter the number of pages you want to divide the job into sets of.

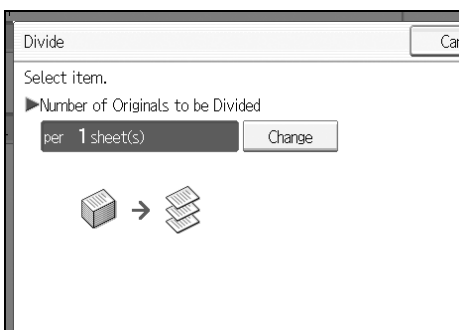

4 Press the **[#]** key.

5 If necessary, press **[Division Check]**.

When you select **[Division Check]**, if the originals were not scanned in order due to a paper jam or multi-sheet feed, a screen for stopping or continuing scanning appears at the end of the scan.

6 Press **[OK]** twice.

The current settings are displayed.

 **Note**

- If the last page of a batch of divided originals is blank, you can skip that page. To skip scanning, in **[Last Page]** under **[2 Sided Original]**, select **[1 Side]**. To scan the last page as a blank page, select **[2 Sides]**. For details, see “Two-sided original”.

 **Reference**

p.124 “Two-sided original”

Scanning Multiple Pages of Originals as One File

This section explains the procedure for sending multiple originals as a multi-page file or storing them as a single stored file.

Important

- To send multiple originals as a multi-page file, in **[File Name / Type]**, select a multi-page file type. For details about file types, see “Setting File Type and File Name”.

1 Press **[Original Feed Type]**.

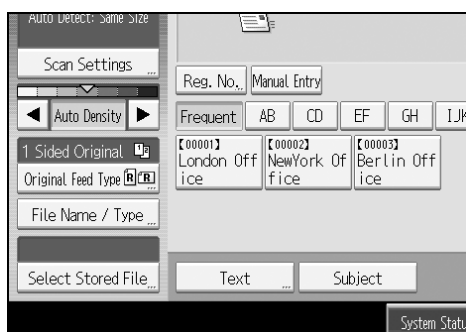

2 Select **[Batch]** or **[SADF]**.

To scan originals using the exposure glass, select **[Batch]**. To scan originals using the ADF, select **[SADF]**. For detail about **[Batch]** and **[SADF]**, see “Batch, SADF”.

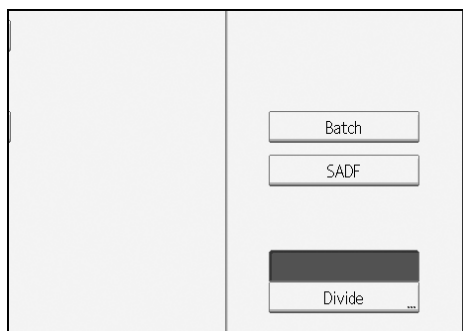

3 Press **[OK]**.

4 Place originals.

5 Make settings for sending by e-mail or Scan to Folder, delivering, or storing.

6 Press the **[Start]** key to scan originals.

If **[Batch]** is selected, place additional originals, and then press the **[Start]** key.

If **[SADF]** is selected, scanning starts automatically when you place additional originals.

Repeat this step until all originals are scanned.

7 After all originals are scanned, press the **[#]** key.

Storing or transmission starts.

 **Note**

- If **[Batch]** is selected, originals can be scanned using the ADF.
- When scanning originals using the exposure glass, depending on the settings for **[Wait Time for Next Orig.: Exposure Glass]** under **[Scanner Features]**, the machine can wait for additional originals even if **[Batch]** is not selected in **[Original Feed Type]**. For details about **[Wait Time for Next Orig.: Exposure Glass]**, see General Settings Guide.
- If, under **[Scanner Features]**, **[Set Wait Time]** is set for **[Wait Time for Next Orig.: Exposure Glass]** or **[Wait Time for Next Original(s): SADF]**, place additional originals within the specified time. When the countdown ends, transmission or storage starts automatically. To start transmission or storage before the countdown is completed, press the **[#]** key. Countdown is canceled if Scan Settings or other settings are changed in the meantime. Place additional originals, and then press the **[Start]** key. The machine scans the originals and the countdown is resumed. For details about **[Wait Time for Next Orig.: Exposure Glass]** and **[Wait Time for Next Original(s): SADF]**, see General Settings Guide.
- If **[SADF]** is selected, scanning from the exposure glass is enabled after scanning from the ADF. If this happens, you must press the **[Start]** key to start scanning.

 **Reference**

p.131 "Setting File Type and File Name"

p.125 "Batch, SADF"

Setting File Type and File Name

This section explains the procedure for setting file type, file name, and security for PDF files.

Setting File Type

This section explains the procedure for setting the file type of a file you want to send. File types can be specified when sending files by e-mail or Scan to Folder, and sending stored files by e-mail or Scan to Folder

Important

- To deliver files, set the file type using the delivery server computer. For details, see the manuals supplied with the ScanRouter delivery software.
- Files are stored in TIFF or JPEG format. If **[Store Only]** is selected for **[Store File]**, file type cannot be specified. If **[Send & Store]** is selected for **[Store File]**, files can be sent by e-mail or Scan to Folder in a specified format. However, files are not stored in the specified file type. Specify the file type for stored files when sending them.

Selectable file types differ depending on scan and other settings. For details, see “Relationship between File Type Specified for Scanning and File Types for Sending E-mail and Folder”.

You can select one of the following file types:

- For Single Page
[TIFF / JPEG] or **[PDF]**
- For Multi-page
[TIFF] or **[PDF]**

1 Press **[File Name / Type]**.

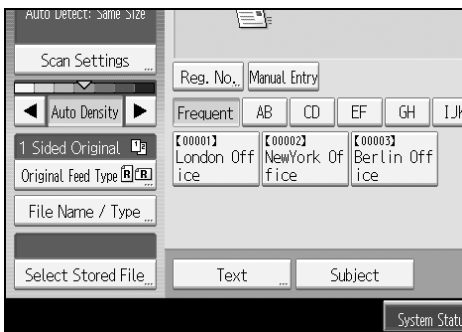

2 Select a file type.

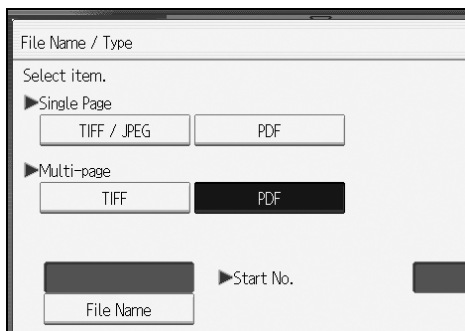

3 Press [OK].

Setting File Name

This section explains the procedure for setting a file name.

Scanned file will be given a file name consisting of the time and date of scanning, 4-digit page number, etc.

- Single-page and divided multi-page files are assigned file names that contain the date and time of scanning and a four-digit page number. An underscore is inserted between the date and time and the four-digit page number.
(Example: For a file scanned in single-page TIFF at 10 ms, 15 sec., 15:30 hours on Dec. 31, 2020, the file name will be 20201231153015010_0001.tif)
- Multi-page files are given file names that contain the time and date of scanning.
(Example: For a file scanned in multi-page TIFF at 10 ms, 15 sec., 15:30 hours on Dec. 31, 2020, the file name will be 20201231153015010.tif)

If necessary, you can change the file name.

1 Press [File Name / Type].

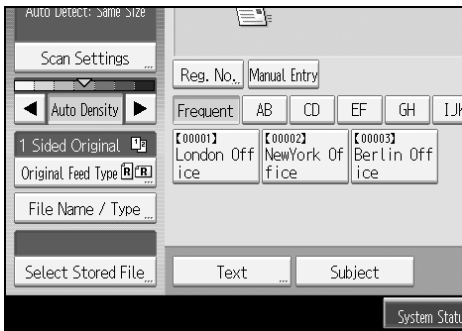

2 Press [File Name].

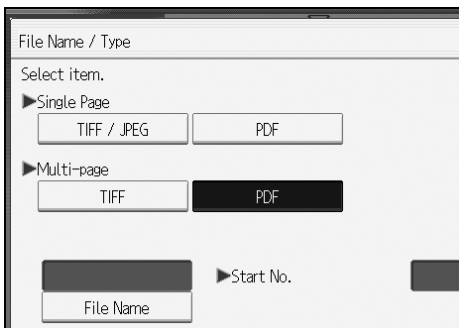

The soft keyboard appears.

3 Enter a file name.

4 Press [OK] twice.

Changing the starting digit of file name serial numbers

A single-page file is assigned a serial number after the file name. The starting number of this serial number can be changed as follows:

1 Press **[File Name / Type]**.



2 Press **[Change]** to the right of the entry box.

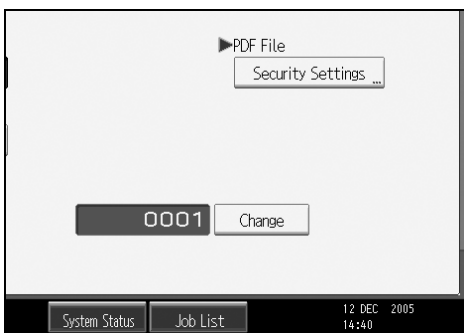

3 Using the number keys, enter the starting digit of the serial number.

4 Press the **[#]** key.

5 Press **[OK]**.

Note

- You can change the starting digit only if other than **[Single Page]** is selected as the file type.
- You can change the number of digits in the serial number. Change the number under **[Scanner Features], [No. of Digits for Single Page Files]**. You can select 4 or 8. For details, see "Send Settings", General Settings Guide.

Security Settings to PDF Files

This section explains security settings for PDF files.

Use security settings to prevent unauthorized access to PDF files.

Important

- Security settings can be made for PDF files only.

Encrypting PDF files

Set a password to protect and encrypt a PDF file. Only users who have the password can open and decrypt the PDF file.

Important

- Encryption is possible only for scan files sent by e-mail or Scan to Folder.
- You cannot open an encrypted file without a password. Make sure you do not forget a file's password.

- 1** Press **[File Name / Type]**.

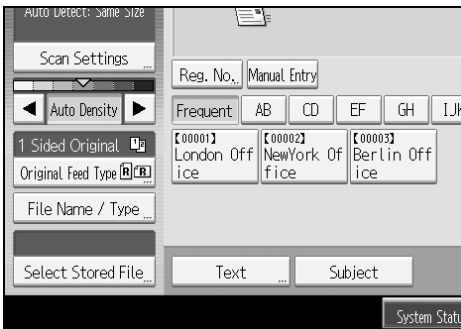

- 2** Check that **[PDF]** is selected.

- 3** Press **[Security Settings]**.

- 4** Select **[Encryption]**.

- 5** In **[Encrypt Document]**, select **[On]**.

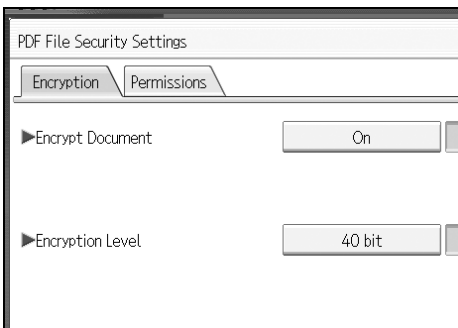

6 In [Password], press [Enter].

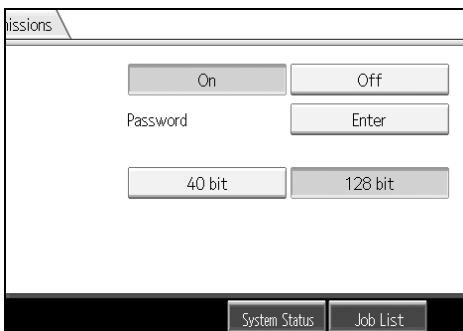

7 Enter a password, and then press [OK].

The password entered here will be required to open the PDF file.

8 Enter the password again, and then press [OK].

9 In [Encryption Level], select [40 bit] or [128 bit].

10 Press [OK] twice.

6

 **Note**

- A document password cannot be the same as the Master password.
- You can enter up to 32 alphanumeric characters for a document password.
- PDF files created under the **[128 bit]** Encryption Level cannot be viewed using Adobe Acrobat Reader 3.0 and 4.0.

Changing security permissions for PDF files

Set a Master Password to restrict unauthorized printing, changing, copying, or extracting of a PDF file's content. Only users who have the Master Password can reset or change these restrictions.

Important

- Encryption is possible only for scan files sent by e-mail or Scan to Folder.
- You cannot reset or change a file's restriction setting without the Master Password. Make a note of the Master Password in a secure place.

1 Press **[File Name / Type]**.

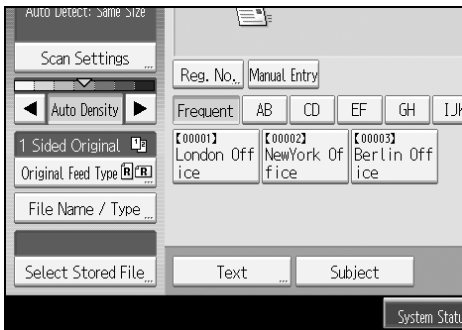

2 Check that **[PDF]** is selected.

3 Press **[Security Settings]**.

4 Select **[Permissions]**.

5 In **[Master Password]**, select **[Set]**.

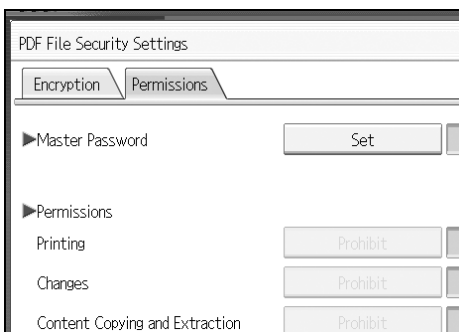

6 In [Password], press [Enter].

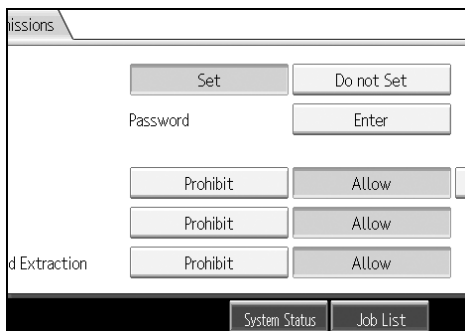

7 Enter a password, and then press [OK].

The password entered here will be required to change the security settings of the PDF file.

8 Enter then password again, and then press [OK].

9 Select the security permission setting.

You can specify the following security settings:

- Print permission: [Prohibit], [Allow], or [Low Resolution Only]
- Editing permission: [Prohibit] or [Allow]
- Copying or extracting content permission: [Prohibit] or [Allow]

6

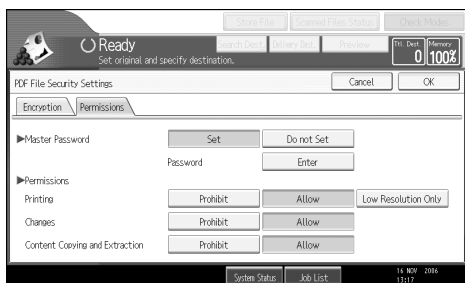

10 Press [OK] twice.

Note

- ❑ The [Password] and [Master Password] cannot be the same.
- ❑ You can enter up to 32 alphanumeric characters for a Master Password.
- ❑ If [40 bit] is selected as the PDF encryption level, you cannot select [Low Resolution Only] as the print permission.

Programs

You can register frequently used settings in the machine memory and recall them for future use.

Note

- You can register up to 10 programs for the scanner mode.
- Programs are not deleted by turning the power off or by pressing the **[Clear Modes]** key unless the content is deleted or newly registered.
- The following settings can be registered to programs: Scan Settings, 1 Sided/2 Sided Original, Top to Top/Top to Bottom, skip scanning back side of the last page, Divide, Original Orientation, File Type, Batch/SADF, Store File, Preview, and Reception Notice.
- Setting made on the simplified display cannot be registered to a program.

Registering Frequently Used Setting

To register frequently used settings in a program:

- 1** On the initial scanner screen, make the settings you want to register in a program.
- 2** Press the **[Program]** key.

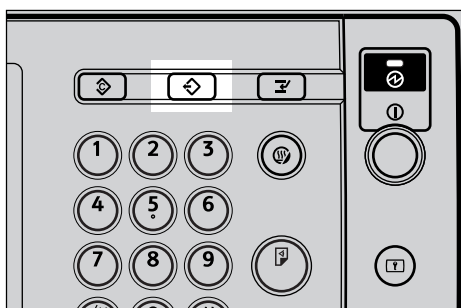

AMG004S

- 3** Press **[Program]**.

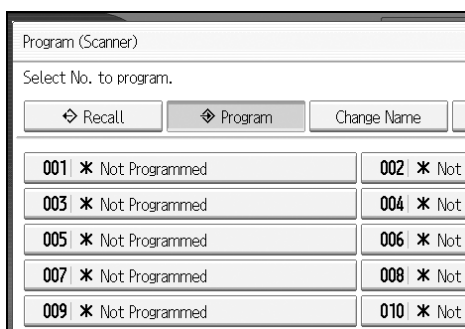

4 Select the number of the program in which you want to register the settings.

Program numbers with ⇨ already have settings in them.

5 Enter the program name.

6 Press [OK].

The Program screen reappears. When the settings are successfully registered, ⇨ appears on the left side of the registered program number and the program name appears on the right side. The initial screen reappears after a moment.

Recalling a Registered Content

To recall settings registered in a program and use them for scanning:

1 Press the [Program] key.

2 Press [Recall].

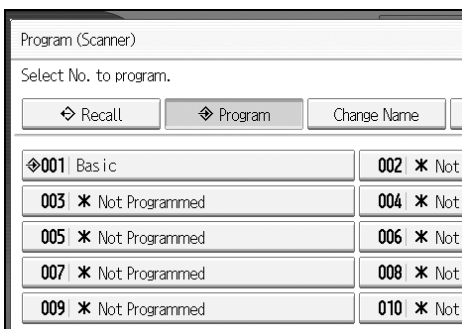

3 Press the number of the program you want to recall.

Settings registered in the program are recalled and the initial scanner screen reappears.

Settings are not registered in numbers that appear without ⇨.

4 Place originals, and then press the [Start] key.

Changing a Registered Program

To change the settings registered to a program:

- 1** Press the **[Program]** key.
- 2** Press **[Recall]**.
- 3** Press the number of the program you want to recall.
- 4** Change settings of the program.
- 5** Press the number of the program you want to recall.
- 6** Press the **[Program]** key.
- 7** Press the number of the program whose settings you changed or the number of a different program in which you want to register the changed settings.
- 8** If you select a program that is already registered, a confirmation message appears. To overwrite the program, press **[Yes]**.
If you select a new program number, you can omit this step. Proceed to the next step.
- 9** Enter a program name.
- 10** Press **[OK]**.

If overwritten, the registered program is deleted.

The new program name appears briefly, and then the initial screen reappears after a moment.

Deleting a Program

To delete a registered program:

- 1** Press the [Program] key.
- 2** Press [Delete].

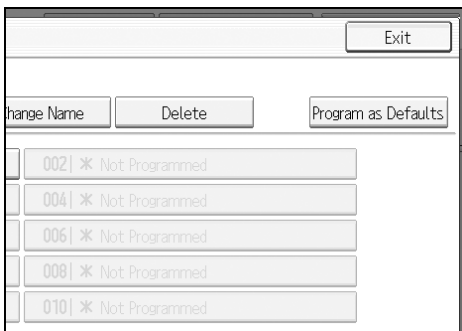

- 3** Press the number of the program you want to delete.

- 4** Press [Yes].

The program is deleted, and the initial screen reappears after a moment.

Changing the Registered Program Name

To change the name of a registered program:

- 1** Press the [Program] key.
- 2** Press [Change Name].

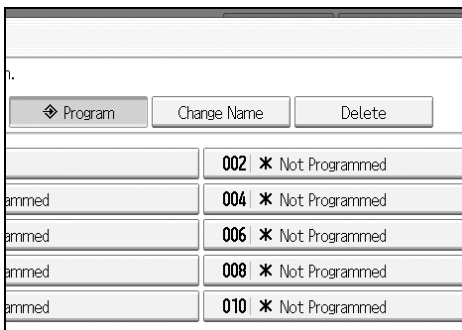

- 3** Press the number of the program whose name you want to change.

- 4** Enter a new program name.

- 5** Press [OK].

The new program name appears briefly, and then the initial screen reappears.

Registering Initial Values for Initial Display

This section explains how to set defaults for the initial screen, which appears when the machine is turned on or when settings are cleared or reset.

The following settings can be registered as defaults: Scan Settings, 1 Sided/2 Sided Original, Top to Top/Top to Bottom, skip scanning back side of the last page, Divide, Original Orientation, File Type, Batch/SADF, Store File, Preview, and Reception Notice.

1 Make the necessary scan settings on the initial screen.

2 Press the **[Program]** key.

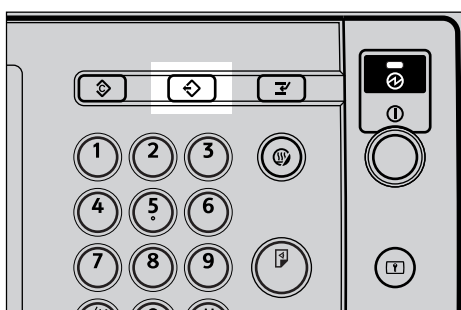

AMG004S

3 Press **[Program as Defaults]**.

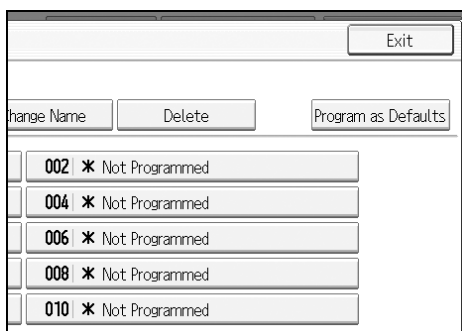

4 Press the **[Program]** key.

5 A confirmation screen appears. Press **[Yes]**.

The current settings are registered as defaults, and then the initial screen reappears.

Note

- To restore the initial screen's original default settings, press **[Restore Factory Defaults]**.
- Default settings for the initial screen can be registered for normal screens and simplified displays respectively.

Scan Settings When Using Twain Scanner

This section explains how to specify original orientation and scan setting for a bundle of mixed size originals when using the TWAIN scanner.

Setting Original Orientation on the TWAIN Scanner

To correctly display the top/bottom orientation of the scanned original on a client computer, the placement of the original and the settings made in the Scanner Control dialog box must match.

1 Open the Scanner Control dialog box.

For details about how to open the Scanner Control dialog box, see “Basic Network TWAIN Scanner Operation”.

2 In the [Original Scan Method:] list, select the place where the original is placed.

3 In the [Orig.Orientn.:] list, select [Long Edge] or [Short Edge].

4 In the [Orientation:] list, select [Right 90 deg / Right 90 deg], [Left 90 deg / Left 90 deg], [Standard 0 deg / Standard 0 deg], or [180 deg / 180 deg].

5 If an original is placed in the ADF, from the drop down menu of [Scan Settings], select [1 Sided], [2 Sided(Top to Top)], or [2 Sided(Top to Bottom)].





Reference

p.107 “Basic Network TWAIN Scanner Operation”



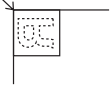

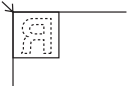
Placing Originals

The following table shows the relationship between the original orientation and the Scanner Properties dialog box settings:

❖ Exposure Glass

| Original Orientation | TWAIN Scanner Control Dialog Box Key |
|--|---|
| top edge touches top left of exposure glass This orientation is the TWAIN driver's standard setting. Place originals in this orientation normally.  |  Left 90 deg. |
| top edge touches rear of exposure glass  |  Standard 0 deg. |

❖ ADF

| Original Orientation | TWAIN Scanner Control Dialog Box Key |
|--|---|
| top edge of original placed first  |  Left 90 deg. |
| top edge touches rear of ADF  |  Standard 0 deg. |

Note

- Originals are normally rectangular (▣) or horizontally long (▭). However, the table above uses squares to make original orientation easier to understand. Even if the actual shape of the original is different, the combination of original orientation and the orientation specified on the scanner driver does not change.
- For details about the Scanner Control dialog box, see the TWAIN driver Help.
- Depending on the settings, originals of different sizes are scanned differently.

When Scanning Originals of Mixed Sizes Using TWAIN Scanner

This section explains the differences between scanning mixed-size originals using the TWAIN scanner and normal scanning.

- If **[Auto detect(Mixed-size)]** is selected in the **[Original Size:]** list, the machine detects the length of each same-width original and then scans them.
- If **[Auto detect(Uni-size)]** is selected in the **[Original Size:]** list, the machine detects the size of the first original of the batch and scans all subsequent originals at that size.

7. Appendix

The appendix details specifications of the scanner function and explains supplementary settings.

Relationship between Resolution and File Size

This section explains the relationship between resolution and original size.

Resolution and original size are inversely related. The higher the resolution (dpi) is set, the smaller the area that can be scanned. Conversely, the larger the scan area, the lower the resolution that can be set.

The relationship between the scanning resolution and the file size is shown below. If the combination is unreadable, "Exceeded max. data capacity. Check the scanning resolution, then press the Start key again." appears on the machine's control panel display. Change the condition until scanning is enabled.

Note

- Image compression level can limit Maximum image size.

When Using E-mail, Folder Sending, Storing or Network Delivery Function

This section explains the relationship between resolution and scan size when using the e-mail, Scan to Folder, storing, or network delivery scanner function.

❖ **If [Text], [Text / Line Art], [Text / Photo], or [Photo] is selected for Scan Type**

All combinations up to A3 and 600 dpi can be scanned.

❖ **If [Gray Scale] is selected for Scan Type**

The originals can be scanned using combinations marked with ○ in the table.

| | 100 dpi | 200 dpi | 300 dpi | 400 dpi | 600 dpi |
|--|---------|---------|---------|---------|---------|
| A3 | ○ | ○ | ○ | ○ | |
| B4 | ○ | ○ | ○ | ○ | |
| A4 | ○ | ○ | ○ | ○ | ○ |
| B5 | ○ | ○ | ○ | ○ | ○ |
| A5 | ○ | ○ | ○ | ○ | ○ |
| B6 | ○ | ○ | ○ | ○ | ○ |
| A6 | ○ | ○ | ○ | ○ | ○ |
| A7 | ○ | ○ | ○ | ○ | ○ |
| 11×17 | ○ | ○ | ○ | ○ | |
| Legal (8 ¹ / ₂ ×14) | ○ | ○ | ○ | ○ | |
| 8 ¹ / ₂ ×13 | ○ | ○ | ○ | ○ | |
| Letter (8 ¹ / ₂ ×11) | ○ | ○ | ○ | ○ | ○ |
| 5 ¹ / ₂ ×8 ¹ / ₂ | ○ | ○ | ○ | ○ | ○ |

 **Note**

Enter B6, A6, and A7 sizes directly.

- B6 → (128 mm × 182 mm)
- A6 → (105 mm × 148 mm)
- A7 → (74 mm × 105 mm)

When Using as a TWAIN Scanner

This section explains the relationship between resolution and scan size when using the machine as a TWAIN scanner.

To specify the scan area or resolution on the machine you are using as a network TWAIN scanner directly, see the TWAIN driver Help.

❖ **If [Binary(Text)] or [Binary(Photo)] is selected in [Col./ Grad.:]**

The originals can be scanned using combinations marked with ○ in the table if Original Orientation is .

| | 100 dpi | 200 dpi | 300 dpi | 400 dpi | 500 dpi | 600 dpi | 700 dpi | 800 dpi | 900 dpi | 1000 dpi | 1100 dpi | 1200 dpi |
|--|------------|------------|------------|------------|------------|------------|------------|------------|------------|-------------|-------------|-------------|
| A3 | ○ | ○ | ○ | ○ | ○ | ○ | | | | | | |
| B4 | ○ | ○ | ○ | ○ | ○ | ○ | | | | | | |
| A4 | ○ | ○ | ○ | ○ | ○ | ○ | ○ | ○ | | | | |
| B5 | ○ | ○ | ○ | ○ | ○ | ○ | ○ | ○ | ○ | | | |
| A5 | ○ | ○ | ○ | ○ | ○ | ○ | ○ | ○ | ○ | ○ | ○ | ○ |
| B6 | ○ | ○ | ○ | ○ | ○ | ○ | ○ | ○ | ○ | ○ | ○ | ○ |
| A6 | ○ | ○ | ○ | ○ | ○ | ○ | ○ | ○ | ○ | ○ | ○ | ○ |
| A7 | ○ | ○ | ○ | ○ | ○ | ○ | ○ | ○ | ○ | ○ | ○ | ○ |
| 11×17 | ○ | ○ | ○ | ○ | ○ | ○ | | | | | | |
| Legal (8 ¹ / ₂ ×14) | ○ | ○ | ○ | ○ | ○ | ○ | ○ | | | | | |
| 8 ¹ / ₂ ×13 | ○ | ○ | ○ | ○ | ○ | ○ | ○ | | | | | |
| Letter (8 ¹ / ₂ ×11) | ○ | ○ | ○ | ○ | ○ | ○ | ○ | ○ | | | | |
| 5 ¹ / ₂ ×8 ¹ / ₂ | ○ | ○ | ○ | ○ | ○ | ○ | ○ | ○ | ○ | ○ | ○ | ○ |

❖ If [Gray Scale] is selected in [Col./ Grad.:]

The originals can be scanned using combinations marked with ○ in the table if Original Orientation is .

| | 100 dpi | 200 dpi | 300 dpi | 400 dpi | 500 dpi | 600 dpi | 700 dpi | 800 dpi | 900 dpi | 1000 dpi | 1100 dpi | 1200 dpi |
|--|------------|------------|------------|------------|------------|------------|------------|------------|------------|-------------|-------------|-------------|
| A3 | ○ | ○ | ○ | ○ | | | | | | | | |
| B4 | ○ | ○ | ○ | ○ | | | | | | | | |
| A4 | ○ | ○ | ○ | ○ | ○ | ○ | | | | | | |
| B5 | ○ | ○ | ○ | ○ | ○ | ○ | | | | | | |
| A5 | ○ | ○ | ○ | ○ | ○ | ○ | ○ | ○ | | | | |
| B6 | ○ | ○ | ○ | ○ | ○ | ○ | ○ | ○ | ○ | | | |
| A6 | ○ | ○ | ○ | ○ | ○ | ○ | ○ | ○ | ○ | ○ | ○ | ○ |
| A7 | ○ | ○ | ○ | ○ | ○ | ○ | ○ | ○ | ○ | ○ | ○ | ○ |
| 11×17 | ○ | ○ | ○ | ○ | | | | | | | | |
| Legal (8 ¹ / ₂ ×14) | ○ | ○ | ○ | ○ | ○ | | | | | | | |
| 8 ¹ / ₂ ×13 | ○ | ○ | ○ | ○ | ○ | | | | | | | |
| Letter (8 ¹ / ₂ ×11) | ○ | ○ | ○ | ○ | ○ | ○ | | | | | | |
| 5 ¹ / ₂ ×8 ¹ / ₂ | ○ | ○ | ○ | ○ | ○ | ○ | ○ | ○ | | | | |

 **Note**

Enter A7 sizes directly.

Relationship between File Type Specified for Scanning and File Types for Sending E-mail and Folder

This section explains the relationship between the file type specified for scanning originals and the file type to which files are converted when sent by e-mail or Scan to Folder.

❖ Single page file type



| Scan Setting | TIFF/JPEG specified | PDF specified |
|-----------------|---|---------------|
| Black and white | TIFF | PDF |
| Gray scale | TIFF (uncompressed) / JPEG (compressed) | PDF |

❖ Multi-page file type

| Scan Setting | TIFF specified | PDF specified |
|-----------------|---------------------|---------------|
| Black and white | TIFF | PDF |
| Gray scale | TIFF (uncompressed) | PDF |

Note

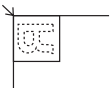
- When you select to convert a scanned original to a single-page TIFF/JPEG file, if gray scale is selected in **[Scan Type]** under **[Scan Settings]**, depending on the **[Compression (Gray Scale)]** setting under **[Scanner Features]**, the file type changes as follows:
 - **[On]...JPEG**
 - **[Off]...TIFF**
- When you set **[Compression (Gray Scale)]** to **[On]** under **[Scanner Features]**, if you specify gray scale in **[Scan Type]** under **[Scan Settings]**, you cannot select multi-page TIFF as the file type.
- Files are stored in single-page format. When sending files by e-mail or Scan to Folder, you can select single-page or multi-page format.
- JPEG format files cannot be sent as a multi-page TIFF file even if you specify to send it as a multi-page TIFF. The file is sent in a default format other than multi-page TIFF.
- When you specify Gray Scale for Scan Type, and single page TIFF/JPEG or multi-page TIFF is selected as the file type, refer to the table below for how to place originals. Originals placed in orientations that are not recommended in the table might appear incorrectly top/bottom oriented on client computer displays.

| | |
|---|---|
| Placing an Original on the Exposure Glass |  |
| Placing an Original in the ADF |  |

Software Supplied on CD-ROM

This section explains the applications on the supplied CD-ROM.

Quick Install

This section explains the auto-run program.

When the CD-ROM is inserted into a client computer running Windows 2000/XP/Vista or Windows Server 2003/2003 R2, the installer starts up automatically (auto run) to install various software.

Note

- When installation under Windows 2000/XP/Vista or Windows Server 2003/2003 R2, log on as an Administrators group member.
- Quick Install may not automatically work with certain operating system settings. If this happens, start "Setup.exe" on the CD-ROM root directory.
- To disable auto-run, set CD-ROM while pressing **Shift** key. Keep the **Shift** key pressed until the computer finishes reading from the CD-ROM.
- If **[Cancel]** is pressed during installation, the installation of all the software thereafter will be stopped. If cancelled, reinstall the remaining software after restarting the client computer.

TWAIN Driver

This section tells you the file path to the TWAIN driver and the TWAIN driver's system requirements.

You must install this driver if you want to scan originals or use the machine as a network TWAIN scanner.

❖ File path

The TWAIN driver is stored in the following folder on the CD-ROM:

`\DRIVERS\TWAIN`

❖ System requirements

- Computer hardware
PC/AT-compatible machines that support the operating system properly
This driver cannot be used in RISC-based processor (MIPS R series, Alpha AXP, or PowerPC) Windows NT environments.
- Operating system
Microsoft Windows 2000/XP/Vista
Microsoft Windows Server 2003
Microsoft Windows Server 2003 R2
- Display resolution
800×600 pixels, 256 colors or higher

DeskTopBinder Lite

This section tells you the file path to DeskTopBinder Lite, the DeskTopBinder Lite system requirements, and the applications that are installed with DeskTopBinder Lite.

DeskTopBinder is installed on the client computers to integrate and manage various kinds of files such as scan files, files created with applications, and existing scan files. This software allows you to use various functions for stored scan files such as viewing stored files. Also, with the ScanRouter delivery software, you can view the files stored in in-trays of the delivery server or use other functions for stored files. For details about DeskTopBinder Lite, see DeskTopBinder Lite manuals or DeskTopBinder Lite Help.

❖ File path

DeskTopBinder Lite is stored in the following folder on the CD-ROM provided with this machine:

`\UTILITY\DESKV2`

❖ System requirements

- Computer hardware
PC/AT-compatible machines that support the following operating system properly
- Operating system
When installing all functions of DeskTopBinder
 - Microsoft Windows 2000 Professional SP1 or later
 - Microsoft Windows 2000 Server SP1 or later
 - Microsoft Windows 2000 Advanced Server SP1 or later
 - Microsoft Windows XP Professional/Home Edition
 - Microsoft Windows Vista Ultimate/Enterprise/Business/Home Premium/Home Basic
 - Microsoft Windows Server 2003 Standard Edition/Enterprise Edition
 - Microsoft Windows Server 2003 R2 Standard Edition/Enterprise EditionWhen installing only SmartDeviceMonitor for Client
 - Microsoft Windows 2000 Professional SP1 or later
 - Microsoft Windows 2000 Server SP1 or later
 - Microsoft Windows XP Professional/Home Edition
 - Microsoft Windows Vista Ultimate/Enterprise/Business/Home Premium/Home Basic
 - Microsoft Windows Server 2003 Standard Edition/Enterprise Edition
 - Microsoft Windows Server 2003 R2 Standard Edition/Enterprise Edition
- Display resolution
800×600 pixels, 64K colors or higher

❖ Software installed with DeskTopBinder Lite

- **Auto Document Link**
Auto Document Link on the client computer monitors in-trays of the delivery server periodically, retrieves files delivered to in-trays, and notifies the user of delivery.
- **RFWriter**
Instead of printing files created with an application, the RFWriter converts those files into TIFF or BMP image files and registers them in a work folder of the DeskTopBinder. For details, see DeskTopBinder Help.
- **Function Palette**
Function Palette allows you to use DeskTopBinder functions such as Scan using TWAIN scanner or Print without starting DeskTopBinder. To use these functions from Function Palette, you must first configure them using DeskTopBinder Extended Features. For details about Function Palette, see DeskTopBinder manuals.
- **SmartDeviceMonitor for Client**
SmartDeviceMonitor for Client provides functions for continuous device status monitoring on the network via TCP/IP or IPX/SPX.

Values of Various Set Items for Transmission/Storage/Delivery Function

This section explains the values of various transmission/storage/delivery function settings.

Note

- Depending on the type or settings of the file or original, you may not be able to specify the destination or enter the maximum number of characters stated below.

Transmission Function

This section explains the values of transmission function settings.

Sending E-mail

The following table tells you the maximum values of the e-mail sending function settings.

| Item | Maximum value | Comments |
|--|-----------------------------|---|
| Number of subject line characters | 128 alphanumeric characters | - |
| Number of e-mail message characters | 80 alphanumeric characters | This is the total number of characters selected from the list and the number of characters entered directly from text. |
| Number of e-mail address characters | 128 alphanumeric characters | E-mail addresses found via LDAP server search cannot be selected if they contain more than 128 characters. |
| Number of addresses you can specify at the same time | 500 addresses | You can specify 100 destinations by direct entry, including LDAP search. Select the remaining 400 destinations from registered addresses. |
| Sendable file size | 725.3 MB per file | - |
| Sendable number of pages | 2,000 pages per file | - |

Folder transmission

The following table tells you the maximum values of the Scan to Folder function settings.

| Item | Maximum value | Comments |
|--|-----------------------------|--|
| Number of path name characters on SMB | 128 alphanumeric characters | - |
| Number of user name characters on SMB | 64 alphanumeric characters | - |
| Number of password characters on SMB | 64 alphanumeric characters | - |
| Number of server name characters on FTP | 64 alphanumeric characters | - |
| Number of path name characters on FTP | 128 alphanumeric characters | - |
| Number of user name characters on FTP | 64 alphanumeric characters | - |
| Number of password characters on FTP | 64 alphanumeric characters | - |
| Number of path name characters on NCP | 128 alphanumeric characters | - |
| Number of user name characters on NCP | 64 alphanumeric characters | - |
| Number of password characters on NCP | 64 alphanumeric characters | - |
| Number of addresses you can specify at the same time | 50 addresses | You can specify a maximum of 50 directly entered destinations. |
| Sendable file size | 2,000 MB per file | - |

Simultaneous Transmission

The following table tells you the maximum values of settings for using the E-mail and Scan to Folder functions simultaneously.

| Item | Maximum value | Comments |
|---|---------------|---|
| Number of destinations you can select for E-mail and Scan to Folder | 550 addresses | - |
| Number of destinations you can select for sending by e-mail | 500 addresses | You can specify a maximum of 100 directly entered destinations, including LDAP search-retrieved destinations. |
| Number of destinations you can set for sending by Scan to Folder | 50 addresses | - |

Storage Function

The following table tells you the maximum values of the storage function settings.

| Item | Maximum value | Comments |
|--|----------------------------|--|
| Number of file name characters | 64 alphanumeric characters | On the control panel, the first 16 characters are displayed. When viewing the stored files from a client computer using DesktopBinder, all the entered characters can be viewed. |
| Number of user name characters | 20 alphanumeric characters | On the control panel, the first 16 characters are displayed. When viewing the stored files from a client computer using DesktopBinder, all the entered characters can be viewed. |
| Number of password characters | 4-8 digit number | - |
| Number of stored files you can select at the same time | 30 files | - |
| Storable number of files | 3,000 files | This is the total number of files stored under the scanner, copier, document server, and printer functions. |
| Storable number of pages | 10,000 pages | This is the total number of files stored under the scanner, copier, document server, and printer functions. |
| Storable number of pages per file | 2,000 pages | - |
| Storable size | 2,000 MB per file | - |

















Network Delivery Function

The following table tells you the values of setting items for the network delivery scanner function.

| Item | Maximum value | Comments |
|--|-----------------------------|---|
| Number of subject line characters | 128 alphanumeric characters | This is the total number of characters selected from the list and the number of characters entered directly from text. |
| Number of e-mail address characters | 128 alphanumeric characters | - |
| Number of addresses you can specify at the same time | 500 addresses | You can specify 65 destinations by direct entry, including LDAP search. Select the remaining 435 destinations from registered addresses The maximum number of destinations you can specify differs depending on which ScanRouter delivery software you are using. For details, see the manuals supplied with the ScanRouter delivery software. |
| Sendable file size | 2,000 MB per file | - |

Specifications

The following table tells you the specifications of the scanner.

| | |
|---|--|
| Scan method | Flatbed scanning |
| Scan speed | When using the E-mail/Scan to Folder/Network Delivery Scanner function: Black and white: 75 page/min (Original size: A4  , Scan Type: Text, Resolution: 200 dpi, Compression (Black & White): On, ITU-T No1 Chart, 1-side scanning) Scanning speed differs depending on the following; operating environment of the machine and computer, scan settings, and the content of originals (denser images require more time). |
| Image sensor type | CCD Image Sensor, CIS Image Sensor |
| Scan type | Sheet, book |
| Interface | Ethernet interface (10BASE-T, 100BASE-TX or 1000BASE-T (optional)), IEEE 802.11b (wireless LAN) (optional) |
| Maximum scan size | DLT (11" × 17") |
| Scan sizes automatically detectable from the exposure glass | 11" × 17"  , 8 1/2" × 14"  , 8 1/2" × 11"  , 8 1/2" × 11"  , 8 1/2" × 5 1/2"  |
| Scan sizes automatically detectable from the ADF | A3  , A4  , A4  , 11" × 17"  , 8 1/2" × 14"  , 8 1/2" × 11"  , 8 1/2" × 11"  , 5 1/2" × 8 1/2"  , 5 1/2" × 8 1/2"  , 10" × 14"  , 7 1/4" × 10 1/2"  |
| Basic scanning resolution | 600 dpi (8-bit gray scale) |
| Selectable scanning resolutions when using the E-mail/Scan to Folder/ Network delivery scanner function | 100 dpi, 200 dpi, 300 dpi, 400 dpi, 600 dpi |
| Selectable scanning resolution when using TWAIN scanner | 100 dpi to 1200 dpi |
| Sendable file formats | TIFF, JPEG, PDF |
| Image compression type for black and white (two-value) | TIFF (MH, MR, MMR) |
| Image compression type for gray scale | JPEG |
| Network protocol | IPv4, IPX |
| Protocol for sending e-mail | SMTP, POP3 |
| Protocol for Scan to Folder | SMB, FTP, NCP |

INDEX

A

Address Book, 12, 41, 48
ADF, 118, 121, 144
Adjusting image density, 120
Advanced search, 20, 23, 29, 48
Auto density, 120
Auto Detect, 111
Auto-run program, 153

B

Batch, 125
Bindery, 56, 58
Black & White, 110

C

CD-ROM, 153
Change, 79, 80
Changing a password, 83
Changing a user name, 80
Checking
 a stored file selected from the list, 70
Check modes, 13
Confirmation displays, 4
 check modes, 4
 Preview, 5
 transmission file status, 6
CSV file, 12, 41
Custom size, 111, 112, 115, 118

D

Delete, 79
Deleting a stored file, 79
Delivery server, 85, 93
DeskTopBinder Lite, 76, 85, 87, 154
Destination list, 18, 47
Display, 3
 confirmation displays, 4
 Simplified Display, 3
Divide, 127

E

Edit, 119
Effective Protocol, 40
E-mail, 148
E-mail address, 12
E-mail destination, 18
 Address Book, 18
 Destination list, 18
 registration numbers, 19
E-mail message, 32
E-mail screen, 13, 17
Entering an e-mail address, 22
Entering registration numbers, 94
Entering the path, 50
Erase border, 119
Ethernet, 12, 40, 105
Exposure glass, 118, 121, 144

F

File information, 67, 68, 69
File name, 67, 68, 82, 131
File type, 131
Folder sending, 148
FTP, 38
FTP server, 54
Functions, 2

G

General settings, 8
Gray Scale, 110

I

Initial settings, 8
Install, 87, 106
I/O device, 85

J

JPEG, 151

L

LDAP, 11
LDAP server, 23
Line Art, 110
List of stored files, 77

M

Managing stored files, 79, 80, 82, 83
Manual entry, 22, 33, 50
Manuals for This Machine, i
Mixed sizes, 111, 112, 146
Multi-pages, 151

N

NCP, 56, 58
NDS, 56, 58
NetWare, 39, 56, 58
Network Delivery, 148

O

One sided original, 123
Operation for delivering files, 89
Original feed type, 121, 123
Original settings, 123

P

Password, 67, 69, 83
PDF, 131, 151
 changing security permissions, 137
 encrypting, 135
Photo, 110
Placing an original, 118
Preparation, 86
 sending by e-mail, 12
Program as Defaults, 143
Programs, 139, 143
 changing registered program, 141
 changing the name, 142
 deleting, 142
 recalling, 140
 registering, 139

Q

Quick install, 153

R

Registering a destination, 26
Registering in the address book, 26
Registering the path, 60
Registration numbers, 19, 28, 47, 94, 98
Resolution, 110
Resolution and file size, 147, 149
Restore Factory Defaults, 143
Result of sending, 6
Return receipt, 89

S

SADF, 125
Scanner Features, 8
Scanning multiple pages, 129
ScanRouter delivery software, 85
Scan settings, 8, 109
Scan Size, 111
Scan to Folder, 37, 43
Scan Type, 110, 148
Screen, 70, 88
 Scan to Folder, 42
Search by comment, 95
Searching by file name, 73, 82
Searching by user name, 72, 99
Searching
 the delivery server's destination list, 95
Searching the list of stored files, 72
Searching the machine's address book, 20
Security settings, 135
Selecting a destination, 23, 93, 95
 machine's address book, 46
Selecting a sender, 27
Sender, 27, 28, 29, 97
Sender name, 27, 28, 29, 97, 98, 99
Sending by Scan to Folder, 40
Sending files
 FTP, 54
 shared network folder, 50
Sending scan files, 37
Sending scan files by e-mail, 11, 14
Sending the URL by e-mail, 35
Send settings, 8
Serial number, 134
Setting file name, 133
Setting file type, 131

Simultaneous storage and delivery, 102
Simultaneous storage
 and sending by e-mail, 34
Simultaneous storage
 and sending by Scan to Folder, 61
Single page, 151
SmartDeviceMonitor for Admin, 12, 41
SMB, 37, 52
SMTP, 11
Specifications, 160
Specifying destinations, 46
Specifying the message, 32
Specifying the path, 52
Specifying the sender, 27, 97
Specifying the subject, 31
Storage, 34, 61, 102
Store only, 65
Storing, 63, 148
Storing scan files, 34, 61, 65, 102
Subject, 101
Subject/Text, 31, 32, 33
Switching screen, 17
 network delivery scanner screen, 92
 Scan to Folder, 45
Symbol, 1

T

Template size, 111
Text, 110
TIFF, 151
TIFF/JPEG, 131
Transmission function
 folder transmission, 157
 sending e-mail, 156
 simultaneous transmission, 157
TWAIN Driver, 106, 107, 153
TWAIN scanner, 103, 104, 107, 144, 146,
 149
 setting original orientation, 144
Two sided original, 124

U

User name, 67, 80
User Tools / Counter, 8

V

Values of various set items, 156
 network delivery function, 159
 storage function, 158
 transmission function, 156

W

Web Image Monitor, 12, 41, 63, 76
Wireless LAN, 12, 40, 105

Note to users in Canada

Note:

This Class B digital apparatus complies with Canadian ICES-003.

Remarque concernant les utilisateurs au Canada

Avertissement:

Cet appareil numérique de la classe B est conforme à la norme NMB-003 du Canada.

Note to users in the United States of America

Note:

This equipment has been tested and found to comply with the limits for a Class B digital device, pursuant to Part 15 of the FCC Rules. These limits are designed to provide reasonable protection against harmful interference in a residential installation. This equipment generates, uses and can radiate radio frequency energy and, if not installed and used in accordance with the instructions, may cause harmful interference to radio communications. However, there is no guarantee that interference will not occur in a particular installation. If this equipment does cause harmful interference to radio or television reception, which can be determined by turning the equipment off and on, the user is encouraged to try to correct the interference by one more of the following measures:

Reorient or relocate the receiving antenna.

Increase the separation between the equipment and receiver.

Connect the equipment into an outlet on a circuit different from that to which the receiver is connected.

Consult the dealer or an experienced radio /TV technician for help.

Caution:

Changes or modifications not expressly approved by the party responsible for compliance could void the user's authority to operate the equipment.

Declaration of Conformity

Product Name: Printer/Scanner Controller

Model Number: Printer/Scanner Unit Type 8000

Responsible party: Ricoh Americas Corporation

Address: 5 Dedrick Place, West Caldwell, NJ 07006

Telephone number: 973-882-2000

This device complies with Part 15 of the FCC Rules.

Operation is subject to the following two conditions:

1. This device may not cause harmful interference, and
2. this device must accept any interference received, including interference that may cause undesired operation.

