

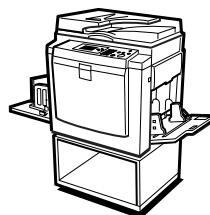

DX 3343
LDD130
DX 3343
3183DNP

Operating Instructions



-
- 1** Before Using the Machine
 - 2** Basics
 - 3** Printing Functions
 - 4** Troubleshooting
 - 5** User Tools
 - 6** Remarks
 - 7** Specifications

Introduction

This manual contains detailed instructions and notes on the operation and use of this machine. For your safety and benefit, read this manual carefully before using the machine. Keep this manual in a handy place for quick reference.

Important

Contents of this manual are subject to change without prior notice. In no event will the company be liable for direct, indirect, special, incidental, or consequential damages as a result of handling or operating the machine.

Do not copy or print any item for which reproduction is prohibited by law.

Copying or printing the following items is generally prohibited by local law:

bank notes, revenue stamps, bonds, stock certificates, bank drafts, checks, passports, driver's licenses.

The preceding list is meant as a guide only and is not inclusive. We assume no responsibility for its completeness or accuracy. If you have any questions concerning the legality of copying or printing certain items, consult with your legal advisor.



Notes:

Some illustrations in this manual might be slightly different from the machine.

Certain options might not be available in some countries. For details, please contact your local dealer.



Two kinds of size notation are employed in this manual. With this machine refer to the inch version.

For good print quality, the supplier recommends that you use genuine master and ink from the supplier.

The supplier shall not be responsible for any damage or expense that might result from the use of parts other than genuine parts from the supplier with your office products.

Power Source

120V, 60Hz, 1.7A or more

Please be sure to connect the power cord to a power source as above. For details about power source, see p.119 "Power Connection".

TABLE OF CONTENTS

- Manuals for This Machine** 1
- What You Can Do with This Machine**..... 2
- How to Read This Manual** 4
- Safety Information** 5
 - Safety During Operation..... 5
- ENERGY STAR Program** 7
- Positions of ⚠WARNING and ⚠CAUTION Labels** 8
- Guide to Components** 9
- Options** 11
 - Option List 11
 - Guide to Major Options 11
- Control Panel**..... 12
 - Panel Display 14

1. Before Using the Machine

- Originals** 17
 - Recommended Sizes and Weights of Originals..... 17
- Print Paper**..... 19
 - Non-recommended Paper..... 20
 - Storing Paper 21
- Printing Size** 22











2. Basics

- Printing Preparations** 23
 - Using the Paper Feed Tray and Delivery Tray..... 23
- After Printing** 26
 - Folding the Paper Feed Tray and Delivery Tray 26
- Placing Originals**..... 28
 - Placing Originals on the Exposure Glass..... 28
 - Placing Originals in the Auto Document Feeder 28
- Basic Procedure**..... 30
 - Energy Saver Mode 32
 - Auto Reset 32
- Printing on Thick or Thin Paper** 33
 - Feed Roller Pressure Lever Position 33
 - Separation Pressure Lever Position..... 34
- Auto Cycle** 35
 - Original Type..... 36
- Sample Print and Adjustment**..... 37
 - Adjusting the Print Image Position 37
- Changing the Printing Speed**..... 40

3. Printing Functions

Printing Functions	41
Master Making Density.....	41
Fine Mode	42
Preset Reduce/Enlarge	42
Erase Border	44
Economy Mode	45
Memory/Class	45
Class Mode (print per class)	47
Memory Mode (print per original)	48
Recall Program	50
Class/Year.....	54
Combine.....	56
Repeat.....	59
Skip Feed/A3 Paper Feed.....	60
Security Mode	61
Online Printing.....	62
Hold Data-in	62
Program	63
Registering Print Settings.....	63
Recalling a Program.....	64
Make Color Prints	65
Changing the Color Drum Unit	65
Making Color Prints.....	66
Printing in Two Colors	67
Combination Chart	68

4. Troubleshooting

If Your Machine Does Not Operate as You Want	69
Printing Problems	70
Printing Problems When Using Combine Mode.....	70
Loading Paper into the Paper Feed Tray	71
Replenishing Paper.....	71
Changing the Paper Size	72
When the Add Ink Indicator () Lights	73
Master Roll Replacement	77
Placing a New Roll of Tape in the Tape Dispenser (Optional)	79
 Clearing Misfeeds	80
“  + P” Original Misfeeds Occur in the Auto Document Feeder	80
“  + A” Paper Misfeeds in the Paper Feed Section.....	83
“  + B” Paper Wrapped around the Drum	83
“  + C” Paper Misfeeds in the Paper Exit Section.....	85
“  + D” Master Misfeeds in the Master Feed Section.....	88
“  + A + B” Paper Misfeeds in the Paper Feed Section	89
“  + B + E” Master Misfeeds in the Master Eject Section.....	91
When the Open Cover/Unit Indicator () Lights and a Message is Displayed	94
Front Cover is Open.....	94
Cover of Optional Auto Document Feeder is Open.....	94
Master Eject Unit is Open	94

- When the Master End Indicator (Ⓜ) Lights and a Message is Displayed 95**
 - Master Feeding Cover is Open 95
 - Master Tray is Not Set Properly 95
- When the Master Eject Indicator (Ⓜ) Lights 96**
- When Other Indicators Light..... 97**
- Poor Printing 98**
 - Dirt on the Back Side of Paper 98
 - Dirt on the Front Side of Paper (Black Line/Stain) 100
 - Blank Prints or Incomplete Prints 101

5. User Tools

- Accessing the User Tools 105**
 - Quitting User Tools 105
- User Tools Menu 106**
 - 1 Counter 106
 - 2 System 106
 - 3 Set Operation Mode 107
 - 4 Initial Settings 108
 - 5 Mode Settings 109
 - 6 Administrator Tools 110
 - 7 Online Settings 111
- User Code 113**
 - Entering the User Code to Use the Machine 113
 - Clearing the Counter 114

6. Remarks

- Operation Notes 115**
 - General Cautions 115
 - Print Paper 117
 - Originals 117
- Where to Put Your Machine 118**
 - Environmental Conditions 118
 - Power Connection 119
 - Access to Machine 119
- Maintaining the Machine 120**
 - Main Frame 120
 - Optional Document Feeder 121

7. Specifications

- Main Frame 123**
- Auto Document Feeder (ADF)..... 127**
- Consumables 128**
- INDEX..... 129**

Manuals for This Machine

The following manuals describe the operational procedures of this machine. For particular functions, see the relevant parts of the manual.

 **Note**

Manuals provided are specific to machine type.

❖ **Easy Operation Guide**

Describes information about the control panel and basic operations.

❖ **Operating Instructions (this manual)**

Describes operations, functions, User Tools (initial setting, mode setting, etc.) and troubleshooting.

What You Can Do with This Machine

Below is a quick summary of this machine's features and where to look in this manual for more information.

- ❖ **Basic Procedure**
See p.30 "Basic Procedure".
- ❖ **Printing on Thick or Thin Paper**
See p.33 "Printing on Thick or Thin Paper".
- ❖ **Selecting Original Type**
See p.36 "Original Type".
- ❖ **Adjusting the Print Image Position**
See p.37 "Adjusting the Print Image Position".
- ❖ **Adjusting the Print Image Density**
See p.41 "Master Making Density".
- ❖ **Changing the Print Speed**
See p.40 "Changing the Printing Speed".
- ❖ **Fine Mode**
See p.42 "Fine Mode".
- ❖ **Reducing and Enlarging Using Preset Ratios**
See p.42 "Preset Reduce/Enlarge".

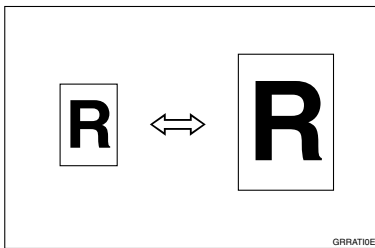

- ❖ **Erasing Edge Margins**
See p.44 "Erase Border".

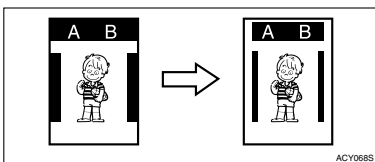

- ❖ **Saving Ink (Economy Mode)**
See p.45 "Economy Mode".
- ❖ **Printing per Class (Class Mode)**
See p.47 "Class Mode (print per class)".

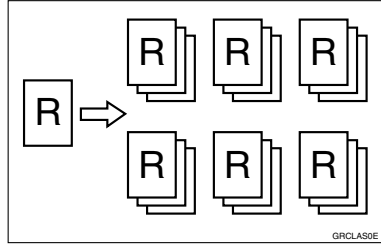

- ❖ **Printing per Original (Memory Mode)**
See p.48 "Memory Mode (print per original)".

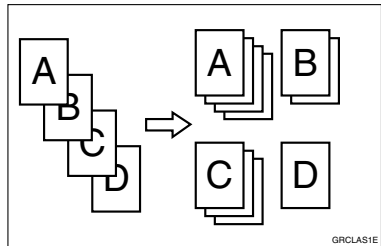

- ❖ **Combining Originals onto One Print**
See p.56 "Combine".

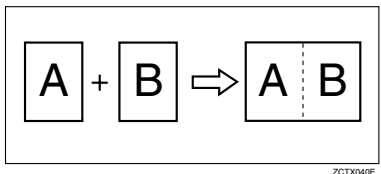

❖ **Repeating Original onto One Print**

See p.59 "Repeat".

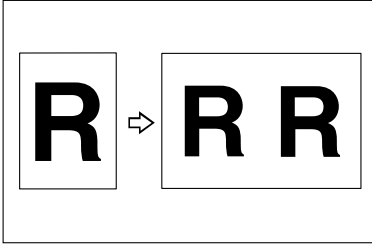

❖ **Skip Feed/A3 Paper Feed Printing**

See p.60 "Skip Feed/A3 Paper Feed".

❖ **Printing Secret Documents (Security Mode)**

See p.61 "Security Mode".

❖ **Making Color Prints**

See p.65 "Make Color Prints".

❖ **Printing in Two Colors**

See p.67 "Printing in Two Colors".

How to Read This Manual

Symbols

This manual uses the following symbols:

 **WARNING:**

Indicates important safety notes.

Ignoring these notes could result in serious injury or death. Be sure to read these notes. They can be found in the "Safety Information" section.

 **CAUTION:**

Indicates important safety notes.

Ignoring these notes could result in moderate or minor injury, or damage to the machine or to property. Be sure to read these notes. They can be found in the "Safety Information" section.

 **Important**

Indicates points to pay attention to when using the machine, and explanations of likely causes of paper misfeeds, damage to originals, or loss of data. Be sure to read these explanations.

 **Note**

Indicates supplementary explanations of the machine's functions, and instructions on resolving user errors.

 **Reference**

This symbol is located at the end of sections. It indicates where you can find further relevant information.

[]

Indicates the names of keys that appear on the machine's display panel.

[]

Indicates the names of keys on the machine's control panel.

Safety Information

When using this machine, the following safety precautions should always be followed.

Safety During Operation

In this manual, the following important symbols are used:

⚠ WARNING:
Indicates a potentially hazardous situation which, if instructions are not followed, could result in death or serious injury.

⚠ CAUTION:
Indicates a potentially hazardous situation which, if instructions are not followed, may result in minor or moderate injury or damage to property.

⚠ WARNING:

- ***Do not damage, break or make any modifications to the power cord. Do not place heavy objects on it. Do not pull it hard nor bend it more than necessary. These actions could cause an electric shock or fire.***
- ***Disconnect the power plug (by pulling the plug, not the cable) if the power cable or plug becomes frayed or otherwise damaged.***
- ***To avoid hazardous electric shock, do not remove any covers or screws other than those specified in this manual.***
- ***Turn off the power and disconnect the power plug (by pulling the plug, not the cable) if any of the following occurs:***
 - ***You spill something into the machine.***
 - ***You suspect that your machine needs service or repair.***
 - ***The external housing of your machine has been damaged.***
- ***Keep the machine away from flammable liquids, gases, and aerosols. A fire or an electric shock might occur.***
- ***Connect the power cord directly into a wall outlet and never use an extension cord.***
- ***Only connect the machine to the power source described in this manual.***
- ***Disposal can take place at our authorized dealer or at appropriate collection sites.***

⚠ CAUTION:

- *After you move the machine, use the caster fixture to fix it in place. Otherwise the machine might move or come down to cause an injury.*
- *If you use the machine in a confined space, make sure there is a continuous air turnover.*
- *Keep the machine away from humidity and dust. Otherwise a fire or an electric shock might occur.*
- *Protect the machine from dampness or wet weather, such as rain and snow.*
- *Do not place the machine on an unstable or tilted surface. If it topples over, an injury might occur.*
- *Unplug the power cord from the wall outlet before you move the machine. While moving the machine, you should take care that the power cord will not be damaged under the machine.*
- *When you disconnect the power plug from the wall outlet, always pull the plug (not the cable).*
- *Do not allow paper clips, staples, or other small metallic objects to fall inside the machine.*
- *For environmental reasons, do not dispose of the machine or expended supply waste at household waste collection points. Disposal can take place at an authorized dealer.*
- *When disposing of a used ink container, reattach the cap to prevent ink from splattering.*
- *Be careful not to get ink on your clothes when replacing an ink container. Ink stains on clothes are hard to remove.*
- *Be careful not to cut yourself on any sharp edges when you reach inside the machine to remove misfed sheets of paper or masters.*
- *If ink comes into contact with your eyes, rinse immediately in running water. For other symptoms, consult a doctor.*
- *Keep the ink or ink container out of reach of children.*
- *If ink is ingested, induce vomiting by drinking a strong saline solution. Consult a doctor immediately.*
- *If your skin comes into contact with ink, wash the affected area thoroughly with soap and water.*
- *While printing, do not touch the belt at the end of the paper delivery tray. Otherwise, an injury might occur.*
- *Our products are engineered to meet the high standards of quality and functionality, and we recommend that you only use the expendable supplies available at an authorized dealer.*

ENERGY STAR Program

❖ ENERGY STAR® Program Requirements for Imaging Equipment



This company is a participant in the ENERGY STAR® Program.

This machine is compliant with the regulations specified by the ENERGY STAR® Program.

The ENERGY STAR® Program Requirements for Imaging Equipment encourage energy conservation by promoting energy efficient computers and other office equipment.

The program backs the development and dissemination of products that feature energy saving functions.

It is an open program in which manufacturers participate voluntarily.

Targeted products are computers, monitors, printers, facsimiles, copiers, scanners, and digital duplicator. Energy Star standards and logos are internationally uniform.

Positions of ⚠️ WARNING and ⚠️ CAUTION Labels

This machine has labels for ⚠️ WARNING and ⚠️ CAUTION at the positions shown below. For safety, please follow the instructions and handle the machine as indicated.

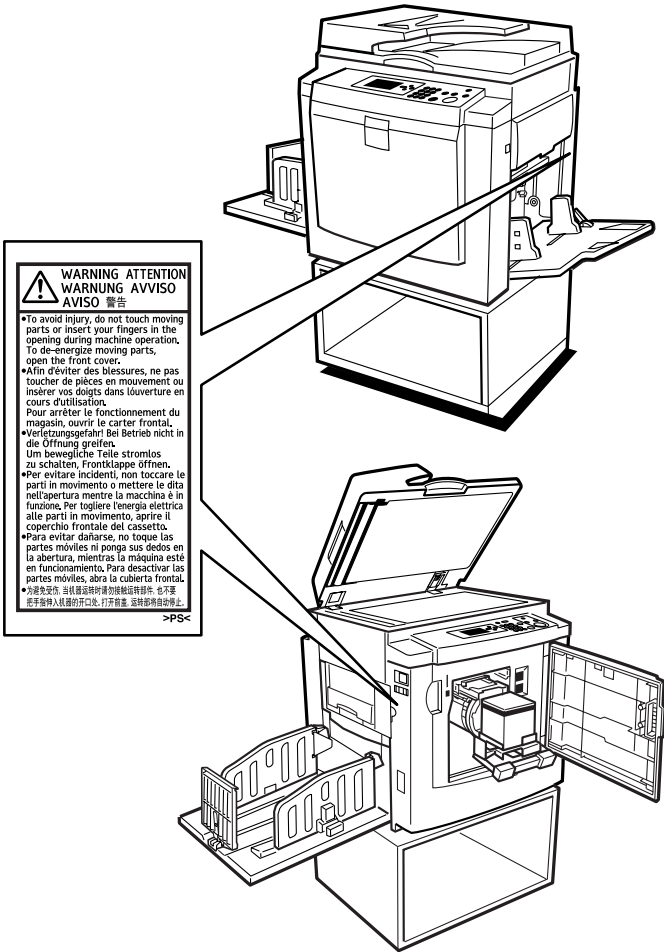

ANT150S

Guide to Components

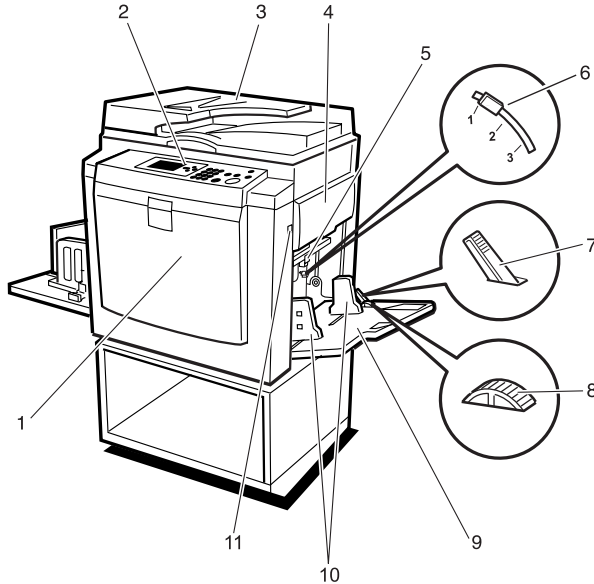

ANT046S

1. Front cover

Open for access to the inside of the machine.

2. Control panel

Operator controls and indicators are located here. See p.12 “Control Panel”.

3. Exposure glass cover (optional) or Auto Document Feeder (optional)

Lower this cover over an original on the exposure glass. If you have the ADF, load a stack of originals here. They will be fed automatically, one by one.

(The illustration shows the ADF.)

4. Master tray

Open this tray when installing the master.

5. Feed roller pressure lever

Use to adjust the contact pressure of the paper feed roller according to paper thickness.

6. Separation pressure lever

Use to prevent double feed.

7. Paper feed side plate lock lever

Use to lock or unlock the paper feed side plates.

8. Side tray fine adjusting dial

Use to shift the paper feed tray sideways.

9. Paper feed tray

Set paper on this tray for printing.

10. Paper feed side plates

Use to prevent paper skew.

11. Paper feed tray down key

Press to lower the paper feed tray.

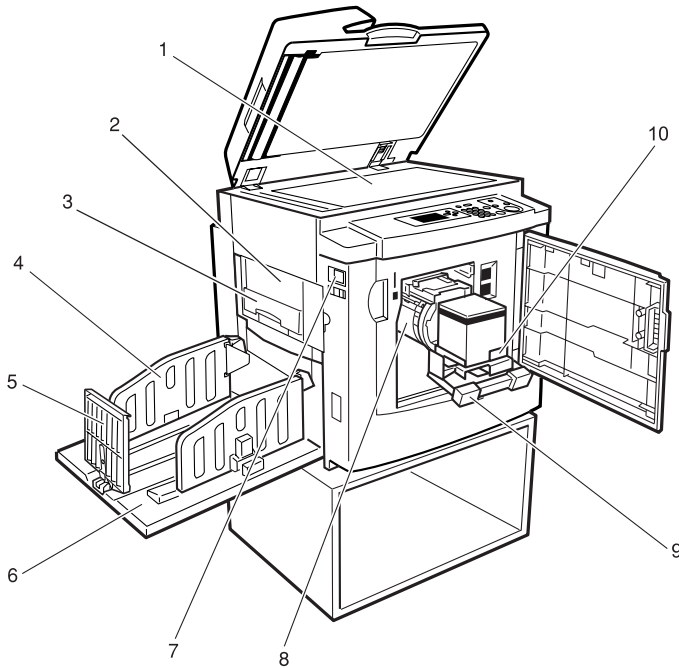

ANT043S

1. Exposure glass

Use to set the original.

2. Master eject unit

Open to remove the misfed master.

3. Master eject box

Used masters are stored here.

4. Paper delivery side plates

Use to align the prints on the paper delivery tray.

5. Paper delivery end plate

Use to align the leading edge of prints.

6. Paper delivery tray

Completed prints are delivered here.

7. Main switch

Use to turn the power on or off.

8. Drum unit

The master is wrapped around this unit.

9. Drum unit lock lever

Lift to unlock and pull out the drum unit.

10. Ink holder

Set the ink cartridge in this holder.

Options

Option List

Options	Model Name
Auto Document Feeder (ADF)	DF Type 20
Exposure Glass Cover	Platen Cover Type 1018
Drum Unit	Color Drum Type 20 LG
Tape Dispenser	Priport Tape Maker Type 20
Printer Controller	Printer Unit VC-20 (Non Network Connectable) Printer Unit Type 4545 (Network Connectable)
Key Counter	-

 **Note**

- Printer Unit VC-20 and Printer Unit Type 4545 cannot be used at the same time.
- Even if both units are connected, by default only Printer Unit Type 4545 can be used.
- Printer Unit VC-20 is not available on the network. If Printer Unit VC-20 is connected to your printer server via USB, it cannot be used as a network printer.

Guide to Major Options

❖ **Auto Document Feeder (ADF)**

Load a stack of originals here. They will be fed automatically, one by one.

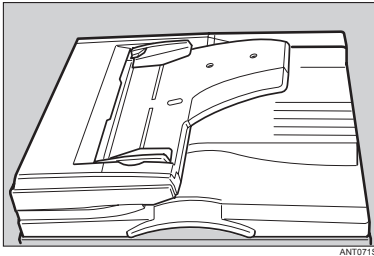

Control Panel

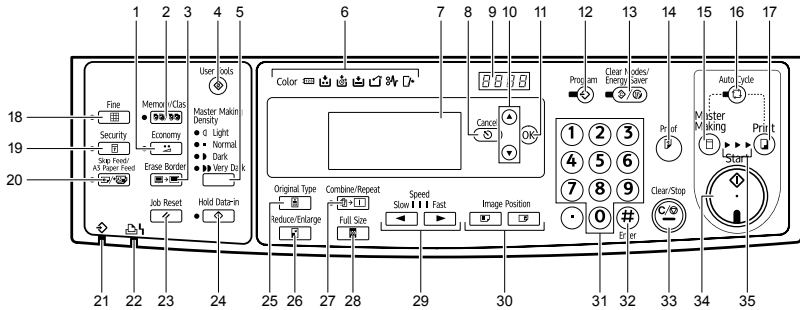

8FU0085

1. [Economy] key

Press to save ink. See p.45 “Economy Mode”.

2. [Memory/Class] key

Press to select Memory or Class mode. See p.47 “Class Mode (print per class)” or p.48 “Memory Mode (print per original)”.

3. [Erase Border] key

Press to select erase margins on the prints. See p.44 “Erase Border”.

4. [User Tools] key

Press to change the default settings to suit your requirements. See p.105 “User Tools”.

5. [Master Making Density] key

Press to make prints darker or lighter. See p.41 “Master Making Density”.

6. Indicators

Show errors and machine status.

Color: Color Drum indicator

: Key Counter indicator

See p.97 “When Other Indicators Light”.

: Add Ink indicator

See p.73 “When the Add Ink Indicator () Lights”.

: Master End indicator

See p.95 “When the Master End Indicator () Lights and a Message is Displayed”.

: Load Paper indicator

See p.71 “Loading Paper into the Paper Feed Tray”.

: Master Eject indicator

See p.96 “When the Master Eject Indicator () Lights”.

: Misfeed indicator

See p.80 “ Clearing Misfeeds”.

: Open Cover/Unit indicator

See p.94 “When the Open Cover/Unit Indicator () Lights and a Message is Displayed”.

7. Panel Display

The panel display shows the machine status, error messages, and function menus.

8. [Cancel] key

Press to cancel a selection or an entry, and to return to the previous display.

9. Counter

Shows the number of prints entered. While printing, it shows the remainder that is to be printed.

10. [▲][▼] keys

Press to select an item on the panel display.

11. [OK] key

Press to confirm a selection or an entry.

12. [Program] key

Press to input or recall user programs. See p.63 “Program”.

13. [Clear Modes/Energy Saver] key

- Clear Modes
Press to clear the previously entered job settings.
- Energy Saver
Press to switch to and from Energy Saver Mode p.32 "Energy Saver Mode".

14. [Proof] key

Press to make proof prints.

15. [Master Making] mode select key

Press to select the master making mode.

16. [Auto Cycle] key

Press to make masters and prints in a single operation. See p.30 "Basic Procedure".

17. Print mode select key

Press to select the print mode.

18. [Fine] key

Press to select the fine image. See p.42 "Fine Mode".

19. [Security] key

Press to make prints of secret documents. See p.61 "Security Mode".

20. [Skip Feed/A3 Paper Feed] key

Press to select skip feed or A3 Paper Feed printing. See p.60 "Skip Feed/A3 Paper Feed".

21. Data In indicator (Green)

- On: Data waiting for Master Making and printing is in the machine.
- Blinking: Data is being received, or Master Making or printing is in progress.
- Off: Master Making and printing are completed.

22. Error indicator (Red)

- On: An error has occurred. Master Making and printing stops.
- Off: Normal status

23. [Job Reset] key

Press to cancel the data from an optional printer controller.

24. [Hold Data-in] key

Press to reject the online print temporarily.

25. [Original Type] key

Press to select Text, Photo, Text/Photo, Pale, or Pencil mode. See p.36 "Original Type".

26. [Reduce/Enlarge] key

Press to reduce or enlarge the image by preset ratios. See p.42 "Preset Reduce/Enlarge".

27. [Combine/Repeat] key

Press to combine two originals onto one print. See p.56 "Combine".

Press to repeat the image of an original on one print. See p.59 "Repeat".

28. [Full Size] key

Press to make full size prints.

29. [◀] and [▶] keys (Speed keys)

Press to adjust the printing speed. See p.40 "Changing the Printing Speed".

30. [Image Position] key

Press to shift the image forwards or backwards. See p.37 "Adjusting the Print Image Position".

31. Number keys

Press to enter the desired number of prints and data for selected modes.

32. [#] (Enter) key

Press to enter data in selected modes.

33. [Clear/Stop] key

Press to cancel a number you have entered or to stop printing.

34. [Start] key

Press to start making masters or printing.

35. Processing indicators

Shows the process of making master to printing.

Panel Display

The panel display shows the machine status, error messages, and function menus.

Important

- Do not subject the panel display to strong impact or a force equivalent to 30N or more, otherwise it could be damaged.

Note

- When you select an item on the panel display, it is highlighted (e.g. **100**).

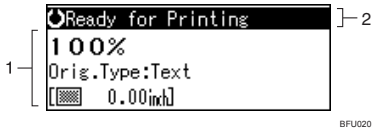

1. Menu for the function selected

2. Machine status or messages

❖ Common keys

[OK] key	Press to confirm a selection or an entry.
[Cancel] key	Press to cancel a selection or entry, and to return to the previous display.
[▲][▼] keys	Press to select items on the panel display.

Panel Display Layout

The basic elements of the panel display are explained below. Understanding their meaning helps you use this machine's features quickly and easily.

❖ Sample display when selecting the **[Reduce/Enlarge]** key

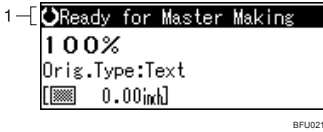

1. Machine status or messages

When the **[Reduce/Enlarge]** key is pressed, the following display is shown.

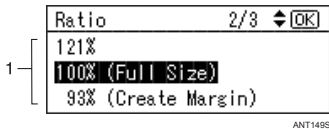

1. Functions and settings available:

- Press the **[▲]****[▼]** keys to select an item.
- Press the **[OK]** key to confirm your settings.
- Press the **[Cancel]** key to return to the previous display.

1. Before Using the Machine

Originals

Recommended Sizes and Weights of Originals

❖ Metric version

Where original is placed	Original size	Original weight
Exposure glass	Up to A3 ^{*1}	--
ADF	Maximum: 297 mm × 432 mm Minimum: 105 mm × 128 mm	52–128 g/m ²

^{*1} When using an A3 size original, be sure to check the printed paper size and print size, and use the Reduce or Combine functions.

❖ Inch version

Where original is placed	Original size	Original weight
Exposure glass	Up to 11" × 17"  ^{*1}	--
ADF	Maximum: 11.7" × 17.0" Minimum: 4.1" × 5.0"	14–28 lb.

^{*1} When using an 11" × 17" size original, be sure to check the printed paper size and print size, and use the Reduce or Combine functions.

Note

- The maximum number of originals that can be placed in the ADF is about 30 (80 g/m², 20 lb.).
- If you do not lift the exposure glass cover more than 30° when you place another original, the machine might not detect the next original correctly.

Non compatible originals for the Auto Document Feeder (ADF)

1

Placing the following types of originals in the ADF can cause paper misfeeds or result in damage to the originals. Place these originals on the exposure glass instead.

- Originals other than those specified on p.17 “Recommended Sizes and Weights of Originals”
- Perforated or torn originals
- Curled, folded, or creased originals
- Pasted originals
- Originals with any kind of coating, such as thermal fax paper, art paper, aluminum foil, carbon paper, or conductive paper
- Originals with indexes, tags, other projecting parts
- Stapled or clipped original
- Sticky originals such as translucent paper
- Thin originals that have low stiffness
- Thick originals such as postcards
- Bound originals such as books
- Transparent originals such as OHP transparencies or translucent paper

Print Paper

The following limitations apply:

	Paper Size		Paper Weight
	Metric	Inch	
Paper feed tray	A3 ^{*1} , B4 JIS, A4, B5 JIS, A5, B6 JIS, A6 Others (Vertical: 90 - 268 mm, Horizontal: 148 - 388 mm)	8 ¹ / ₂ " × 14", 8 ¹ / ₂ " × 11", 5 ¹ / ₂ " × 8 ¹ / ₂ ", 8" × 13" Others (Vertical: 3.6" - 10.5", Horizontal: 5.9" - 15.2")	47.1 - 209.3 g/m ² , 12.5 - 55.6 lb.

^{*1} For details about how to print on A3, see p.60 "A3 Paper Feed".

Note

- Paper with a thickness of 47.1 - 209.3 g/m², 12.5 - 55.7 lb. can be used. Plain paper of 52.5 - 81.5 g/m², 14 - 21.7 lb. is recommended. However, when using a thickness less than 52.5 g/m², 14 lb. or greater than 81.6 g/m², 21.7 lb., it is advised to select printing speed to setting 1.
- About 1,000 sheets of paper with a 64 g/m², 17 lb. thickness is the standard amount that can be set in the paper feed tray. This amount changes depending on the paper thickness. In general, set paper at a height less than 105 mm.
- When using paper that easily curls or waves in humidity, if there is high humidity (more than 80%), set less than 500 sheets in the paper feed tray.
- Paper with a length of 90 - 297 mm, 3.5" - 11.7" and width of 140 - 420 mm, 5.5" - 16.5" can be set in the paper feed tray. However, when using a paper size that exceeds 275 mm length and 395 mm width, specify A3 Paper Feed. Specifying this function sets the printing speed to 80 cpm and the print position to -10 mm, 0.4".
- Do not use curled or waved paper. Use paper with less than 5 mm, 0.2" curl and 3 mm, 0.1" wave.
- When paper feed problems arise, try using a slower print speed.

Non-recommended Paper

The following types of paper are not recommended for this machine:

1

- Roughly cut paper
- Paper of different thickness and types in the same stack
- Envelopes heavier than 85 g/m², 22.6 lb.
- Folded, curled, creased, or damaged paper
- Damp paper
- Torn paper
- Slippery paper
- Rough paper
- Paper with any kind of coating (such as carbon)
- Short grain paper
- Thin paper that has low stiffness
- Paper that is prone to generate a lot of paper dust
- Grained paper loaded with the direction of the grain perpendicular to the feed direction
- Certain types of long thin envelopes.
E.g. international mail envelopes

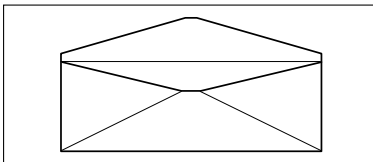

ZFX040E

- The following types of envelopes

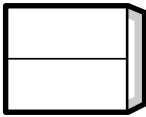
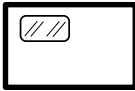
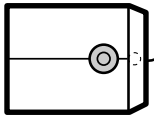
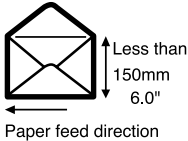

Envelopes with glue or gum	Envelopes with windows	Envelopes with round tags	Open envelopes
			

Note

- Do not use inkjet paper. It does not absorb ink well, print will smudge if rubbed, and the back of paper may be dirtied.
- If you print on rough grained paper, the print image might be blurred.

Important

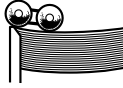
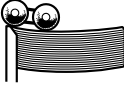
- Correct curls in the paper before placing it in the machine. When you cannot correct the paper curl, stack the paper with the curl face down or face up as shown in the illustration. If the paper is curled, it might wrap around the drum or stains might appear.

	Right	Wrong
Thin Paper		
Thick Paper		

TPEY990E

Storing Paper

Note

- When storing paper, the following precautions should always be taken:
 - Do not store paper where it will be exposed to direct sunlight.
 - Avoid storing paper in humid (greater than 70%) areas.
 - Store on a flat surface.
- Keep open reams of paper in the package and store as you would unopened paper.

Printing Size

1

Maximum print size

210 × 355 mm, 8.3" × 14.0"

At low temperatures, the maximum print size may be somewhat smaller.

Range that cannot be printed

The first 5 mm, 0.2" of the leading edge cannot be printed. When using the optional Auto Document Feeder, the first 5 mm, 0.2", of the leading edge as well as the last 2 mm, 0.08", of the trailing edge cannot be printed.

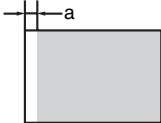
Original	Print
	

a: 5 mm, 0.2"

Printing Preparations

Using the Paper Feed Tray and Delivery Tray

Loading Paper

1 Carefully open the paper feed tray.

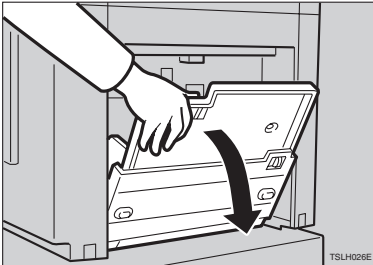

2 Shift the paper feed side plates lock lever forward. Adjust the side plates to match the paper size.

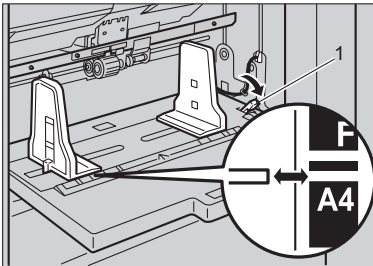

1: Paper Feed Side Plates Lock Lever

3 Load paper into the paper feed tray.

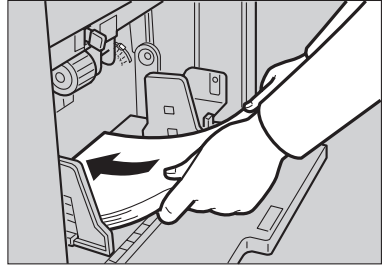

Note

- ❑ Correct the paper curl before setting the paper. If you cannot do so, stack the paper with the curl face down as shown.

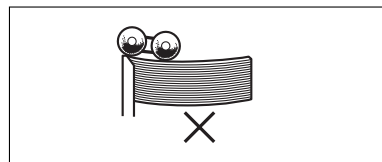
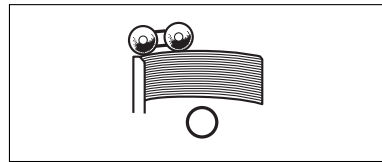

- 4** Make sure that the paper feed side plates touch the paper lightly. Shift the lock lever to its original position.

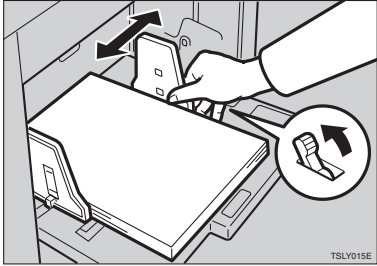

- 3** Lift the paper delivery end plate and move it to match the print paper size.



Setting Up the Paper Delivery Tray

- 1** Open the paper delivery tray.

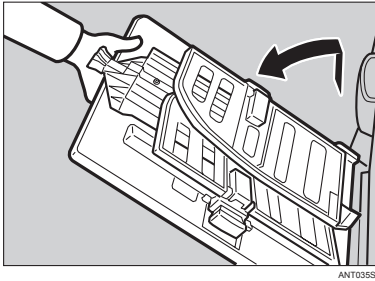

- 4** Lift the paper delivery end plate and adjust it to match the paper size.

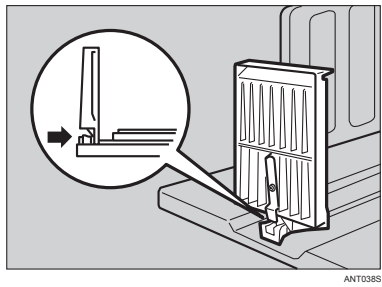

- 2** Lift the paper delivery side plates and adjust them to the paper size.

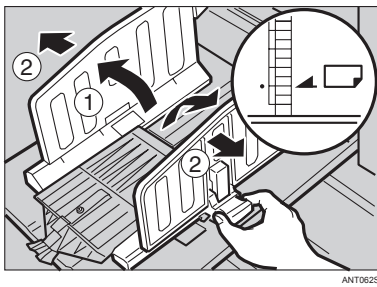

Using the side plate guides

When printing on A4, 8 1/2" x 11", B5 JIS size paper and thin paper, you should attach the side plate guides to the side plates of the Paper Delivery Tray. Using the side plate guides allows you to properly assemble the printed papers on the Paper Delivery Tray.

Side plate guides

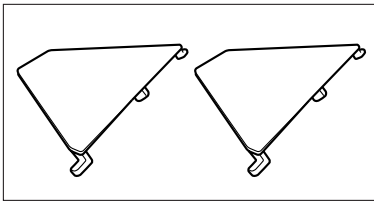

ANT040S

Note

- Side Plate guides come equipped with the machine.

- Insert the protruding portion into the Side Plate holes.

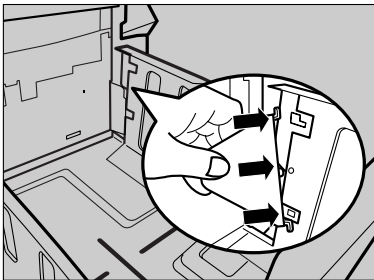

ANT041S

Note

- Insert the middle protruding portion first followed by the upper and lower portions.

- Turn the Side Plate Guide to the direction shown by the arrow, and make sure it is fixed.

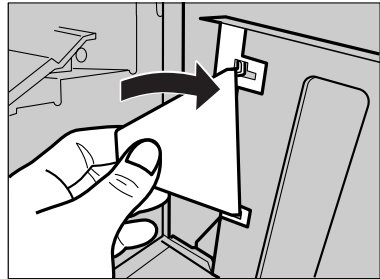

ANT042S

- After attaching the Side Plate Guide on one side, repeat the same process for the other side.

- Turn on the main switch.



ANT076S

After Printing

This section shows you how to return the paper feed tray and paper delivery tray to their original positions.

2

Folding the Paper Feed Tray and Delivery Tray

1 Remove the paper from the paper feed tray.

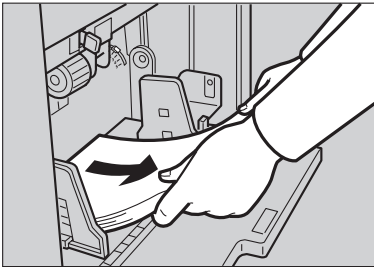

The paper feed tray will move down.

2 Turn off the main switch.



3 Close the paper feed tray.

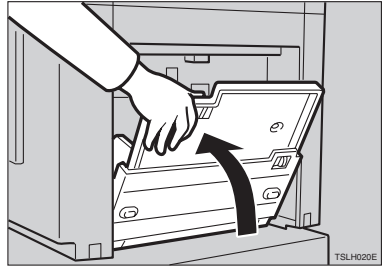

4 Move the end plate until the plate handle is flush with the end of the tray.

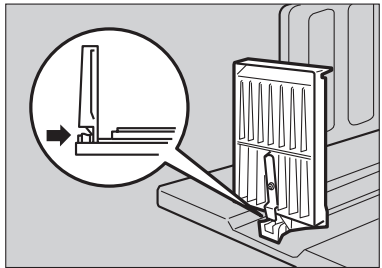

5 Lower the end plate.

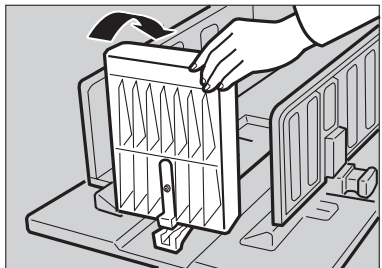

- 6** Move the side plates to the sides, then lower them.

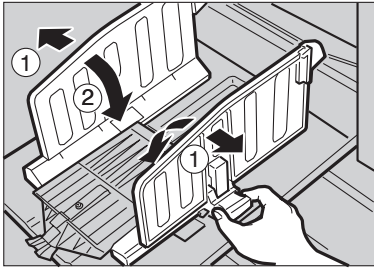

ANT0365

- 7** Close the tray.

Placing Originals

When using the exposure glass, place the originals face down.

When using the ADF, place the originals face up.

2

Placing Originals on the Exposure Glass

- 1 Lift the exposure glass cover.

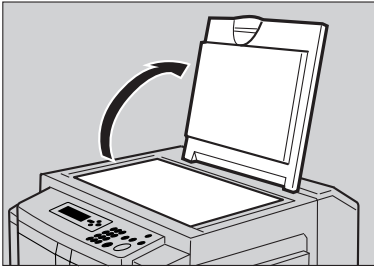

ANT064S

Note

- ❑ Be sure to lift the exposure glass cover more than 30°.

- 2 Place the original face down on the exposure glass. The original should be aligned with the left scale.

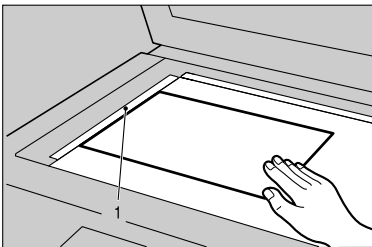

ACY076S

1. Left scale

- 3 Lower the exposure glass cover.
- 4 Adjust print settings as necessary, and then press the [Start] key.

Placing Originals in the Auto Document Feeder

- 1 Adjust the guide to the original size.
- 2 Insert the aligned originals face up into the ADF.

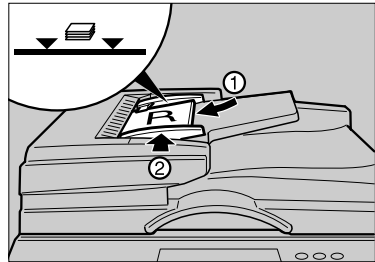

AJK153S

Note

- ❑ To avoid originals misfeeding, fan the originals before placing them in the ADF.

Limitation

- ❑ Approximately 30 originals (80 g/m², 20 lb.) can be inserted at a time in the ADF. The first (top) original will be fed first.

Note

- ❑ To avoid jamming, fan the originals before placing them in the ADF.
- ❑ The guides must fit snugly against both sides of the stack.

3 Adjust print settings as necessary, and then press the **[Start]** key.

 **Note**

- If the next original has been placed in the ADF before the machine stops, that original is fed automatically.

Basic Procedure

When Auto Cycle mode is on, you can process masters and make prints in a single operation.

Note

- ❑ You can process masters and make prints in a single operation. See p.35 "Auto Cycle".
- ❑ If the machine has user codes set, enter your user code using the number keys, and then press the **[OK]** key.

Reference

See p.113 "User Code".

1 Make sure no previous settings remain.

Note

- ❑ If previous settings remain, press the **[Clear Modes/Energy Saver]** key before entering your settings.

2 Place the originals.

Reference

See p.28 "Placing Originals".

3 Make sure the [Master Making] mode select key is lit.

Note

- ❑ If it is not lit, press the **[Master Making]** mode select key.

4 Make the necessary settings.

5 Press the [Start] key.

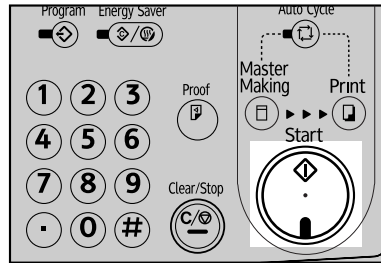

Master making starts.

Note

- ❑ Press the **[Proof]** key to check the image before making prints.

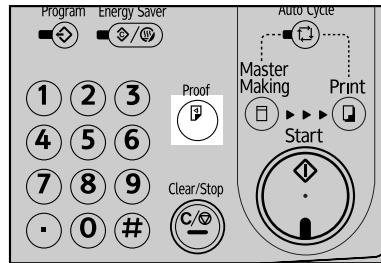

Reference

To change the image position, see p.37 "Adjusting the Print Image Position".

6 Make sure the [Print] mode select key is lit.

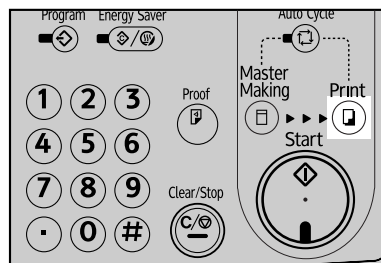

- 7** Enter the required number of prints using the number keys.

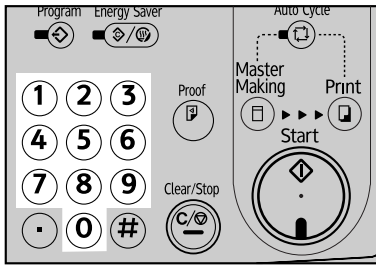

Note

- Set a print quantity between 1 (minimum) and 9999 (maximum).

- 8** Press the **[Start]** key.

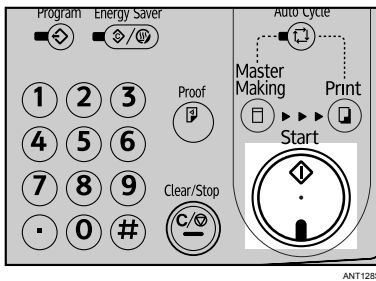

Note

- When the print job finishes, press the **[Clear Modes/Energy Saver]** key. Previously entered job settings are cleared.

How to operate

- ❖ **To stop the machine during a multi-print run**
Press the **[Clear/Stop]** key.
- ❖ **To return the machine to the initial condition after printing**
Press the **[Clear Modes/Energy Saver]** key.
- ❖ **When clearing entered values**
Press the **[Clear/Stop]** key.

Energy Saver Mode

If the machine has not been operated for a certain period of time after printing, or when you press and hold the **[Clear Modes/Energy Saver]** key for 3 seconds, the panel display goes off and the machine enters Energy Saver mode. In Energy Saver mode, the machine consumes less electricity. Press the **[Clear Modes/Energy Saver]** key again, and the machine will return to the ready condition.

Note

- By default, the time taken for the machine to shift to Energy Saver mode is 3 minutes.
- You can change the waiting time within a range of 1 to 120 minutes. See “Energy Saver Timer” on p.106 “2 System”.
- In the following cases, the machine will not shift automatically to Energy Saver mode.
 - If there is no ink
 - If originals or paper are jammed
 - If the machine has not finished making masters or prints
 - If the machine is printing the second page of a Combine print
 - If there is no master
 - If the master eject box is full
 - If there is an original in the optional Auto Document Feeder
 - If the “cover open” indicator is lit
 - If you are in the process of making changes to the user tools
 - If the screen for entering a user code is displayed

Auto Reset

This machine can be set to return automatically to its initial condition if it has not been operated for a certain period of time. This is called “Auto Reset”.

Note

- The Auto Reset time can be set from 1 to 5 minutes, or to “Off”. See “Auto Reset Timer” on p.106 “2 System”.
- The default for Auto Reset is Off.
- In the following cases, Auto Reset will not take place.
 - If there is no ink
 - If originals or paper are jammed
 - If the machine has not finished making masters or prints
 - If the machine is printing the second page of a Combine print
 - If there is no paper
 - If there is no master
 - If the master eject box is full
 - If there is an original in the optional Auto Document Feeder
 - If the “cover open” indicator is lit
 - If you are in the process of making changes to the user tools
 - If you have set Auto Reset to “Off”

Printing on Thick or Thin Paper

When you make prints on thick (127.9 to 209.3 g/m², 34.0 to 55.6 lb.), standard (52.3 to 127.9 g/m², 13.9 to 34.0 lb.) or thin (47.1 to 52.3 g/m², 12.5 to 13.9 lb.) paper, perform the following steps.

 **Note**

- Reduce the print speed when printing on thick or thin paper.

Feed Roller Pressure Lever Position

- 1** Shift the feed roller pressure lever to the **Thick, Standard, or Thin** paper position.

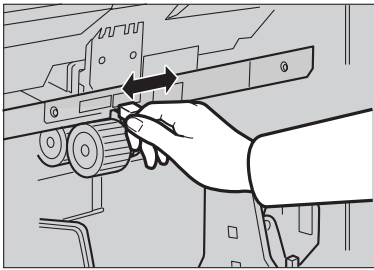

 **Note**

- Shift the lever according to the paper weights as shown in the following table.

	Metric version	Inch version
Thick	127.9–209.3 g/m ²	34.0–55.6 lb.
Standard	52.3–127.9 g/m ²	13.9–34.0 lb.
Thin ^{*1}	47.1–52.3 g/m ²	12.5–13.9 lb.

^{*1} When paper is smaller than B5, 5¹/₂" × 8¹/₂" and heavier than 81.4 g/m² (21.6 lb.), move the feed roller pressure lever to the Thin paper position.

- 2** Shift the paper feed side plates lock lever forward. Adjust the side plates to match the paper size.

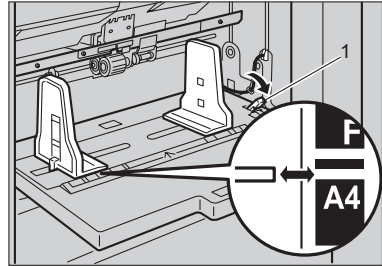

1: Paper Feed Side Plates Lock Lever

- 3** Make sure that the paper feed side plates touch the paper lightly.

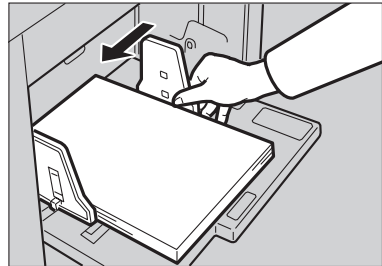

When printing onto thin paper

- 1 Set the side pads to both sides of the paper feed side plates. Make sure that the paper feed side plates touch the paper lightly.

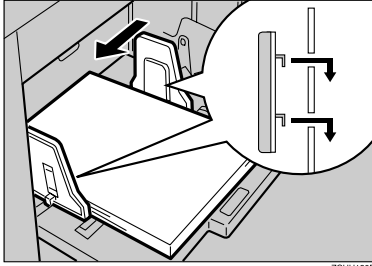

ZCUH180E

- 4 Shift the lock lever to its original position.

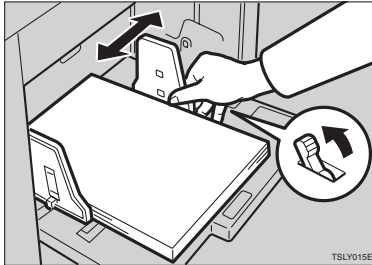

TSLY015E

- 5 When you finish printing, shift the feed roller pressure lever to the Standard paper position.

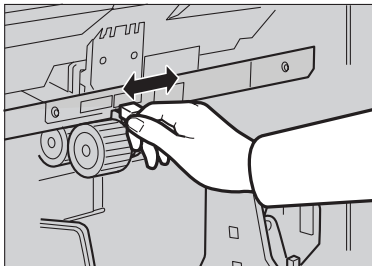

ANT075S

Separation Pressure Lever Position

- 1 To prevent double feed, adjust the paper separation pressure using the separation pressure lever.

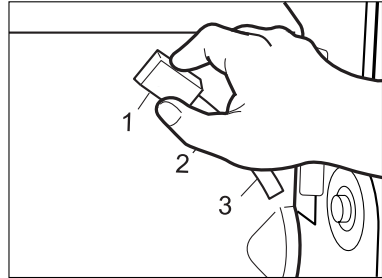

ANT117S

Note

- Paper separation pressure can be adjusted according to the paper weights as shown in the following table.

Position	Metric version	Inch version
1	Use this position if the leading edge of the paper is curled, or when the paper does not feed properly at Position 2.	
2 *1	81.6–209.4 g/m ²	21.7–55.6 lb.
3	47.1–81.5 g/m ²	12.6–21.6 lb.

*1 This position can also be used if the leading edge of the paper is curled, or when the paper does not feed properly.

Auto Cycle

Using the default settings, you can process masters and make prints in a single operation. This is called "Auto Cycle".

- 1 Make sure the **[Auto Cycle]** key is lit.

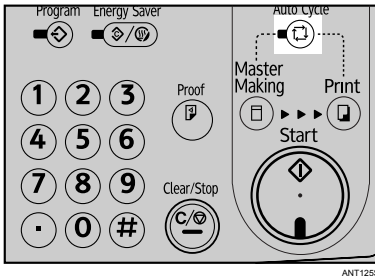

Note

- If it is not lit, press the **[Auto Cycle]** key.

- 2 Place your originals.

Reference

See p.28 "Placing Originals".

- 3 Make sure the **[Master Making]** mode select key is lit.

Note

- If it is not lit, press the **[Master Making]** mode select key.

- 4 Make the necessary settings.

- 5 Enter the required number of prints using the number keys.

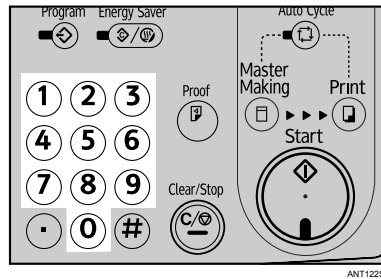

- 6 Press the **[Start]** key.

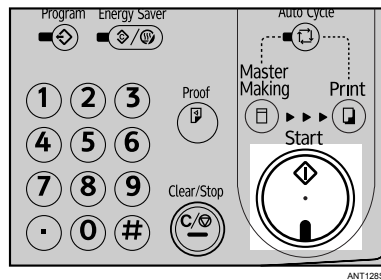

Note

- When the print job finishes, press the **[Clear Modes/Energy Saver]** key. Previously entered job settings are cleared.

Original Type

Select one of the following four types to match your originals:

❖ Text

Specify this if the original document consists primarily of text.

❖ Text/Photo

If the original document contains a combination of text and photographs, it is printed using the optimum image balance.

❖ Photo

Specify this for photographs, pictures, or colored documents.

❖ Pale

When printing pale colors, the master is created using pale color print.

❖ Pencil

Specify this for originals drawn / written in pencil.

Note

- You can specify the original type that is selected by default when the power is turned on. See “Original Type” on p.108 “4 Initial Settings”.
- The default is Text mode.
- Moire patterns may occur when you are printing from screened originals.
- When using Photo mode to print originals with both text and photographs, the text might appear faint. To avoid this, use Text/Photo mode instead.
- When using Pencil mode, set documents drawn / written in pencil on the exposure glass.

1 Press the [Original Type] key.

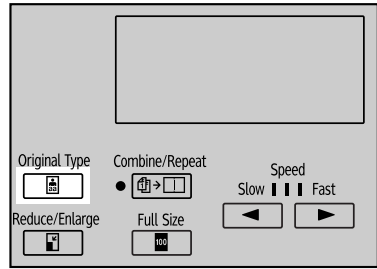

2 Use the [▲][▼] keys to select the type of original, and then press the [OK] key.

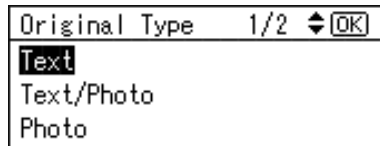

Sample Print and Adjustment

Once the master making has been completed, it is possible to confirm the print finish before pressing the **[Print]** mode select key to start the printing process.

1 Press the **[Proof]** key.

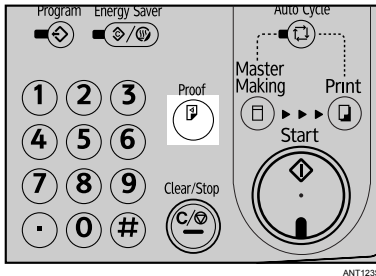

A single printed page is ejected.

Note

- Press the key continuously to eject printed pages in succession.

Adjusting the Print Image Position

After master making, you can adjust the print image position to suit your needs. There are two ways:

- ❖ **Shifting the Image Position Forward or Backward**
Shift the image position using the **[Image Position]** keys.
- ❖ **Shifting the Image Position to the Right or Left**
Shift the image position using the side tray fine adjusting dial.

Shifting the Image Position Forward or Backward

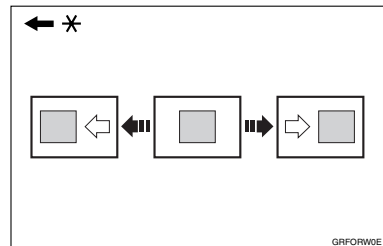

* Paper feed direction

1 Press the left **[Image Position]** key to move the image forwards, the right key to move it backwards.

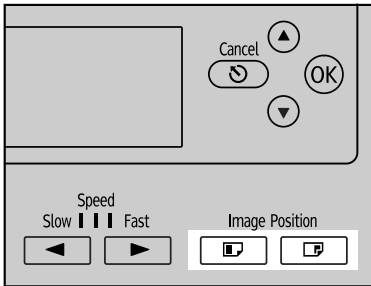

ANT137S

Note

- ❑ When you shift the image forwards, leave a margin (more than 5 mm, 0.2") at the leading edge. If there is no margin, paper might wrap around the drum and cause a misfeed.
- ❑ The right or left **[Image Position]** keys shift the image about 0.5 mm, 0.02" each time they are pressed.
- ❑ The value of the image position that shifted is displayed on the panel display.
- ❑ In A3 Paper Feed mode, the images are fixed at -10 mm, -0.4".

2 Press the **[Proof]** key to check the image position.

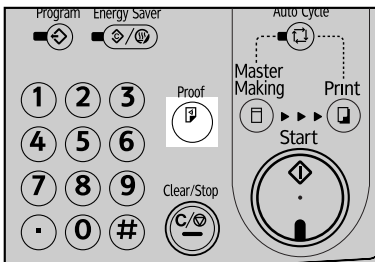

ANT123S

Shifting the Image Position to the Right or Left

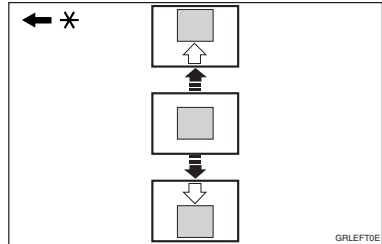

* Paper feed direction

1 Turn the side tray fine adjusting dial as shown in the illustrations.

❖ **Shifting the image to the right**



TSLH02IE

❖ **Shifting the image to the left**



TSLH02JE

Note

- The image position can be shifted up to about 10 mm, 0.4" each way. Each division on the scale is 2 mm, 0.08".
- In A3 Paper Feed Mode, adjust the print position to within ± 1 mm, ± 0.04 " of the center.

2 Adjust the paper delivery side plates to the print paper position.

3 Press the [Proof] key to check the image position.

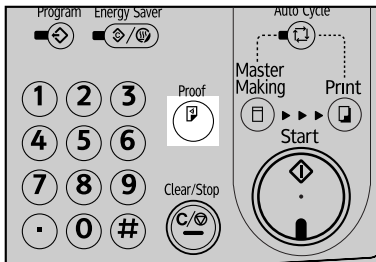

Changing the Printing Speed

Use the [◀] or [▶] key to adjust the speed of the machine with the image density and printing paper.

Adjust the print speed using the Speed Keys for the following instances:

- When the paper type is changed:
 - Reduce the print speed when printing on thick or thin paper.
- When you want to change the print density:
 - Increase the print speed to lighten the print density.
 - Reduce the print speed to darken the print density.

1 Press the [▶] key to increase the speed and press the [◀] key to reduce the speed.

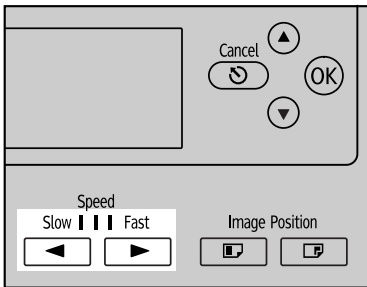

Note

- ❑ The following speeds are available:
 - Setting 1:
80 sheets/minute
 - Setting 2:
100 sheets/minute
 - Setting 3:
130 sheets/minute
- ❑ As a default setting, setting 2 is selected.
- ❑ In A3 Paper Feed mode, the print speed is fixed at setting 1.

3. Printing Functions

Printing Functions

Master Making Density

You can adjust the image density to suit your needs.

Note

- You can specify the image density that is selected by default when the power is turned on. See “Master Making Density” on p.108 “4 Initial Settings”.

- 1** Press the **[Master Making Density]** key to select the density you want to set.

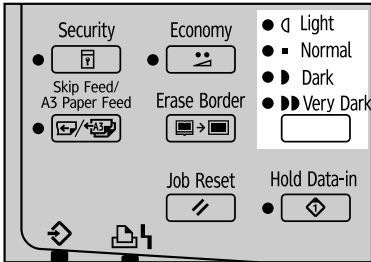

Note

- If your original has a colored background such as red or blue, select a lighter image density to prevent the prints from appearing dirty.

- 2** Make sure the **[Master Making]** mode select key is lit.

Note

- If it is not lit, press the **[Master Making]** mode select key.

- 3** Press the **[Start]** key.

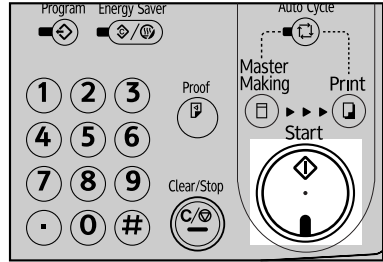

- 4** Press the **[Proof]** key to check the print image density.

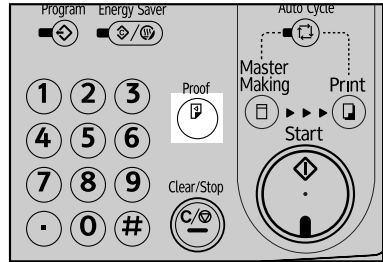

Fine Mode

Use the **[Fine]** key to make clear prints.

- 1 Set your originals.
- 2 Press the **[Fine]** key to select Fine mode.

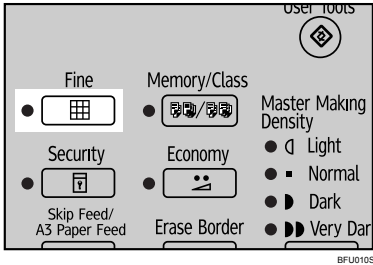

- 3 Enter the number of prints with the number keys.

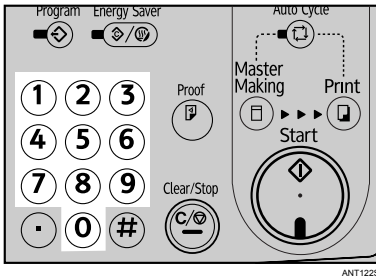

- 4 Press the **[Start]** key.

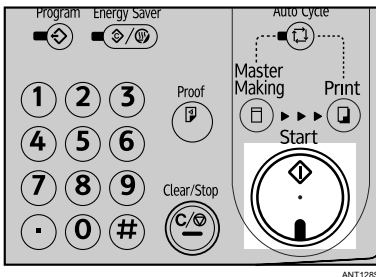

Preset Reduce/Enlarge

Use this function to reduce or enlarge originals by a preset ratio.

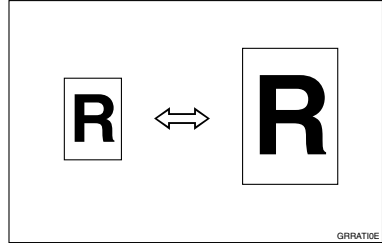

- Note**
- You can select a ratio regardless of the size of the original or the printing paper. However, with some ratios, parts of the image might not be printed or margins will appear on prints.
 - You can choose from 7 preset ratios (3 enlargement ratios and 4 reduction ratios).

❖ Metric version

Ratio (%)	Original → Print paper size
141	A5 → A4, B5 JIS → B4 JIS
122	A4 → B4 JIS, A5 → B5 JIS
115	B5 JIS → A4
93	—
87	A3 → B4 JIS, A4 → B5 JIS
82	B4 JIS → A4, B5 JIS → A5
71	A3 → A4, A4 → A5, B4 JIS → B5 JIS

❖ Inch version

Ratio (%)	Original → Print paper size
155	5 1/2" × 8 1/2" → 8 1/2" × 14"
129	5 1/2" × 8 1/2" → 8 1/2" × 11"
121	8 1/2" × 14" → 11" × 17"
93	—
77	8 1/2" × 14" → 8 1/2" × 11"
74	11" × 15" → 8 1/2" × 11"
65	11" × 17" → 8 1/2" × 11", 8 1/2" × 11" → 5 1/2" × 8 1/2"

- ❑ You can specify the reproduction ratio that is selected by default when the power is turned on. See "Ratio" on p.108 "4 Initial Settings".

1 Set your original.

2 Press the [Reduce/Enlarge] key.

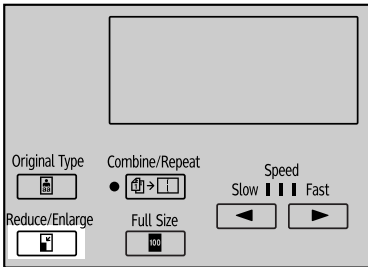

ANT1315

3 Use the [▲][▼] keys to select your desired reproduction ratio, and then press the [OK] key.

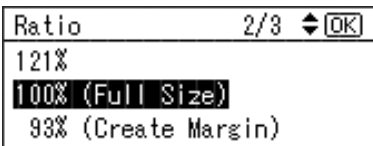

4 Enter the number of prints with the number keys.

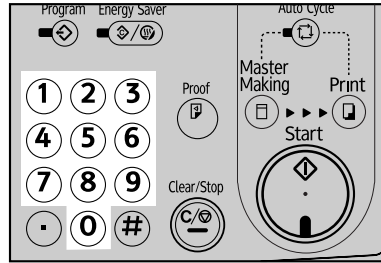

ANT1225

5 Press the [Start] key.

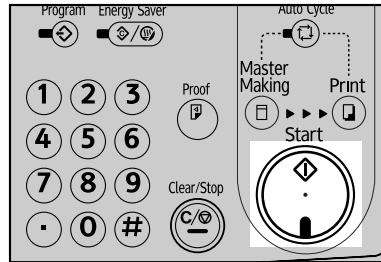

ANT1285

Erase Border

This function erases all four margins of the original or paper.

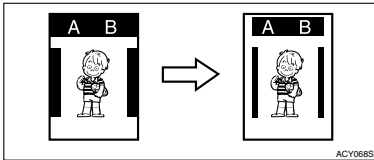

3

Note

- You can specify within a range of 0 to 20mm, 0" to 0.8", the width of the margin to be erased. See "Erase Border Width" on p.108 "4 Initial Settings".
- The default is 5 mm, 0.2".

1 Set your original.

2 Press the [Erase Border] key.

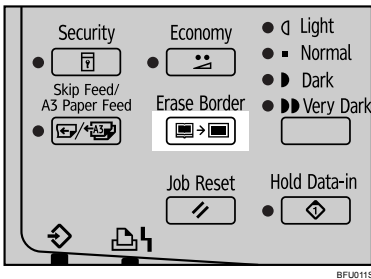

3 Use the [▲][▼]keys to select the original size and orientation, and then press the [OK] key.

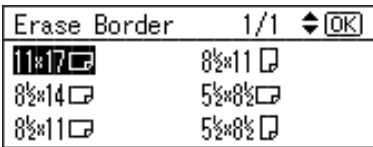

4 Enter the number of prints with the number keys.

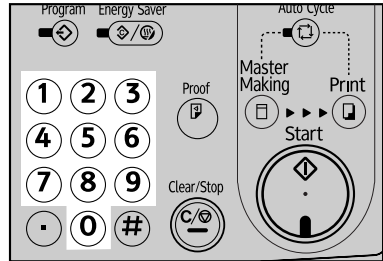

5 Press the [Start] key.

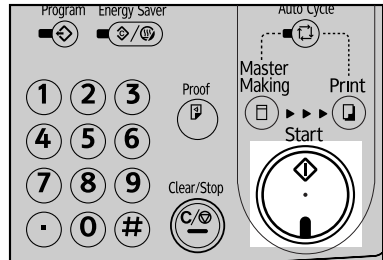

Auto Delete Margin Shadow

If the exposure glass or ADF is open during scanning, and Erase Border is not selected, dark areas surrounding the original might appear as a shadow on the prints.

The Auto Delete Margin Shadow function automatically detects these areas and prevents them appearing on the prints.

Economy Mode

Use this function to save ink.

Note

- ❑ Prints will appear lighter when Economy mode is used.
- ❑ The default is Off. To select either “On” or “Off” for Economy mode, see “Economy Mode” on p.108 “4 Initial Settings”.

1 Set your original.

2 Press the [Economy Mode] key.

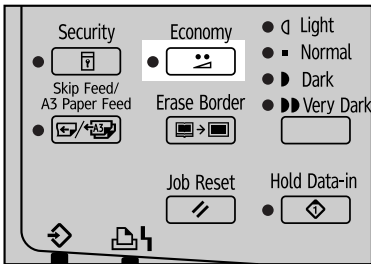

BFU0125

3 Enter the number of prints with the number keys.

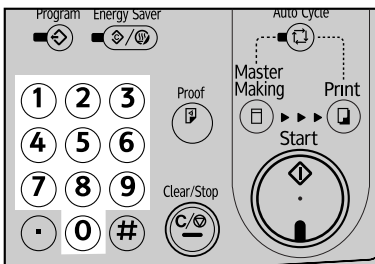

ANT1225

4 Press the [Start] key.

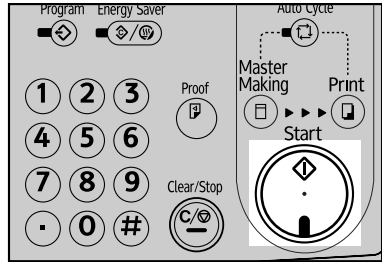

ANT1265

3

Memory/Class

The Memory/Class function is useful especially for people such as teachers, who often have to make different numbers of prints from the same original for different classes or have to make the same number of prints from a number of different originals for the same class.

Under the Memory/Class function, the following modes are available:

❖ Class Mode (print per class)

Use to make prints from one original for multiple classes, with the same number of prints for each class.

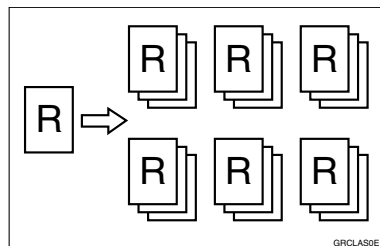

GRCLAS0E

❖ **Memory Mode (print per original)**

You can choose from the following two types of Memory mode:

- **Normal Memory Mode**
Use to make prints from a number of different originals. A different number of prints is made from each original.

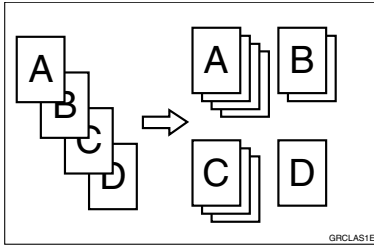

- **Stack Memory Mode**
Use to make prints from one original, with a different number of prints for each class.

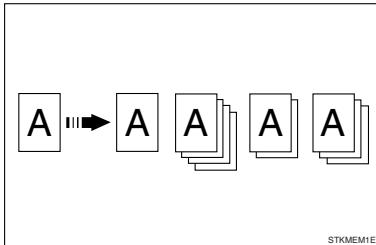

 **Note**

- ❑ You can specify either Normal Memory Mode or Stack Memory Mode as the default. See “Memory Mode Setting” on p.109 “5 Mode Settings”.

❖ **Recall Program**

Use to recall settings that you have stored under the Memory Mode and Class Mode.

❖ **Class/Year Mode**

 **Reference**

If the use of this machine is not limited to school or college, you can choose to have this mode displayed as “Department” instead of “Class/Year”. See “Class Display” on p.107 “3 Set Operation Mode”.

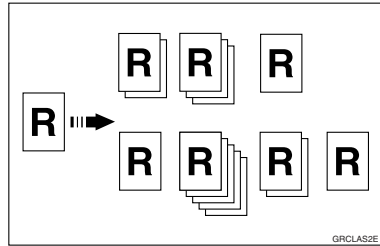

- **All**
Use to make prints from the same original for all the registered classes in all the school years.
- **Class**
Select to make prints from the same original for only the classes selected.
- **Households**
Use to make prints from the same original for all the registered student households in the school.

Class Mode (print per class)

Note

- You can print for up to 24 combinations of number of prints and number of classes.
- The maximum possible number of classes in one combination is 99.

1 Set your original.

2 Press the [Memory/Class] key.

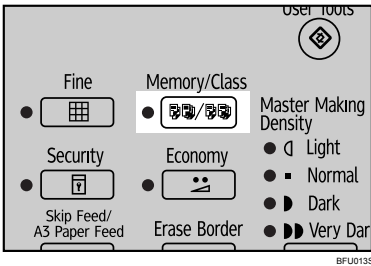

3 Use the [▲][▼] keys to select Class and then press [OK] key.

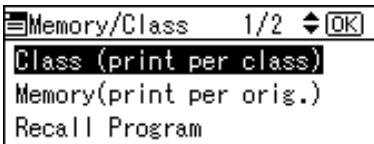

4 With the number keys, enter the desired number of prints, and the press the [#] key.

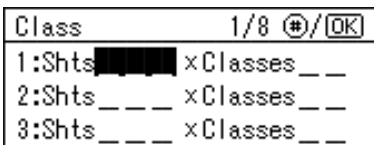

5 With the number keys, enter the desired number of classes, and then press the [#] key.

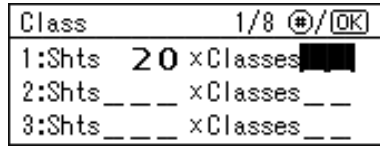

Note

- Repeat Steps 4 to 5 as desired.

6 Press the [OK] key.

7 If you are using the optional tape dispenser, turn on the tape dispenser switch.

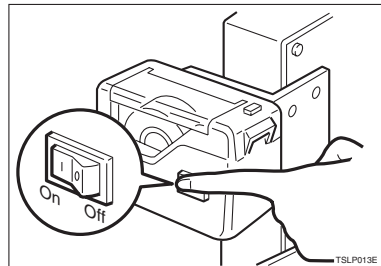

Note

- The optional tape dispenser automatically feeds out strips of paper to separate each group of prints.

8 Press the [Start] key.

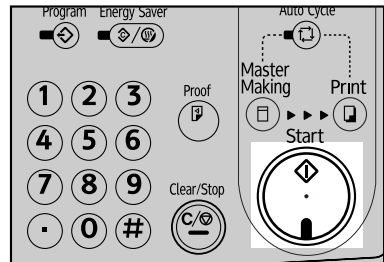

Memory Mode (print per original)

Normal Memory Mode

Note

- You can make prints from up to 30 originals at one time.

1 Set your original.

2 Press the [Memory/Class] key.

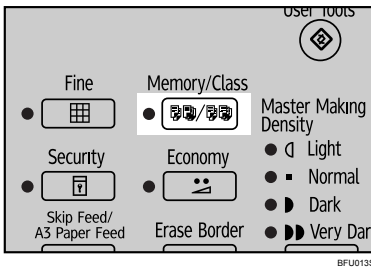

3 Use the [▲][▼] keys to select Memory, and then press the [OK] key.

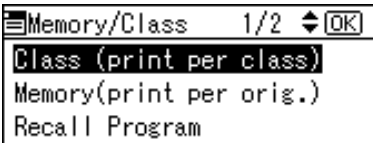

4 With the number keys, enter the desired number of prints for each original, and then press the [#] key.

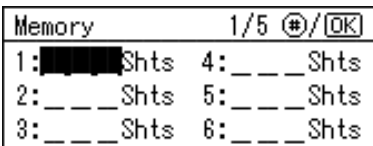

Note

- Repeat this step until you have entered for all the originals.

5 Press the [OK] key.

6 If you are using the optional tape dispenser, turn on the tape dispenser switch.

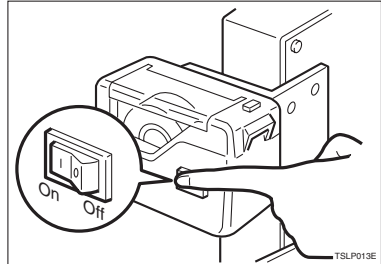

Note

- The optional tape dispenser automatically feeds out strips of paper to separate the prints made from each original.

7 Press the [Start] key.

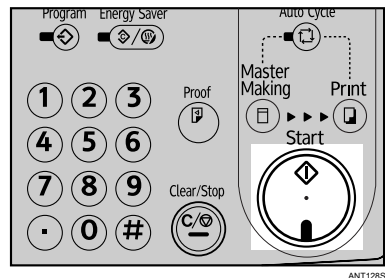

Stack Memory Mode

Limitation

- To use Stack Memory mode, you need to first set Memory Mode to "Stack Mode" using the user tools. See "Memory Mode Setting" on p.109 "5 Mode Settings".

Note

- You can make prints for up to 30 classes at one time.

1 Set your original.

2 Press the [Memory/Class] key.

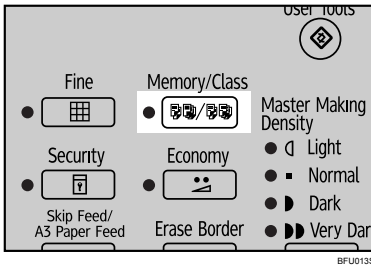

3 Use the [▲][▼] keys to select Memory, and then press the [OK] key.

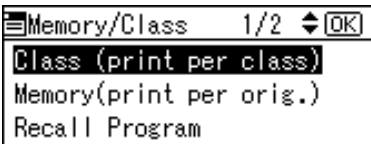

4 With the number keys, enter the desired number of prints for each class, and then press the [#] key.

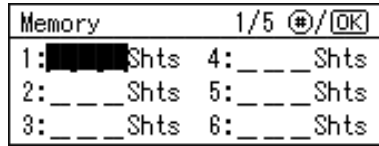

Note

- Repeat this step until you have entered for all of your classes.

5 Press the [OK] key.

6 If you are using the optional tape dispenser, turn on the tape dispenser switch.

7 Press the [Start] key.

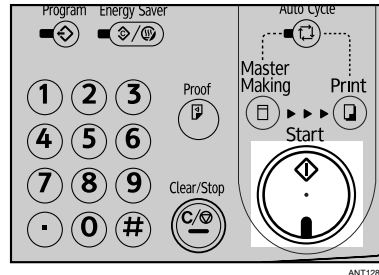

3

Recall Program

Note

- You can store up to 10 entries for Memory mode with each entry containing settings for up to 30 originals (Normal Memory mode), or settings for up to 30 classes (Stack Memory mode).
- You can store up to 10 entries for Class mode with each entry containing settings for up to 24 combinations of classes and numbers of prints.

Storing Normal Memory Mode Settings

1 Press the **[User Tools]** key.

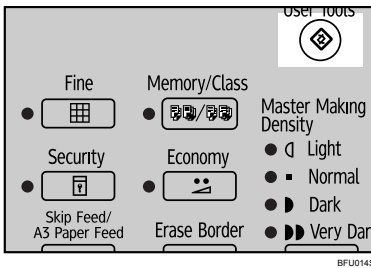

2 Use the **[▲][▼]** keys to select **4 Initial Settings**, and then press the **[OK]** key.

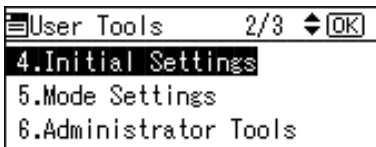

3 Use the **[▲][▼]** keys to select **7 Program/Change Memory**, and then press the **[OK]** key.

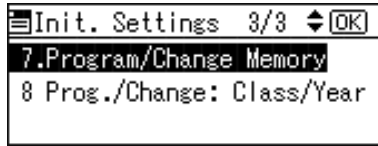

4 Use the **[▲][▼]** keys to select a number, and then press the **[OK]** key.

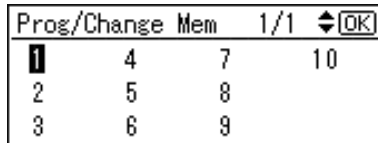

Note

- If the number is already in use, a message will be displayed asking if you wish to overwrite the settings stored. To overwrite, press the **[OK]** key. Otherwise press the **[Cancel]** key to return to the previous display, and then select another number.

5 With the number keys, enter the number of prints for each original, and then press the **[#]** key.

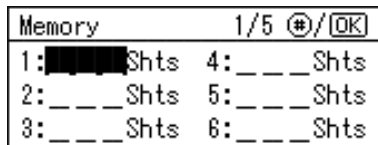

Note

- Repeat Steps **4** and **5** to register all of your originals.

6 Press the **[OK]** key.

7 Press the **[Clear Modes/Energy Saver]** key.

The contents that you have stored are now effective.

Storing Stack Memory Mode Settings

⚠ Limitation

- ❑ To use Stack Memory mode, you need to first set Memory Mode to "Stack" using the user tools. See "Memory Mode Setting" on p.109 "5 Mode Settings".

1 Press the [User Tools] key.

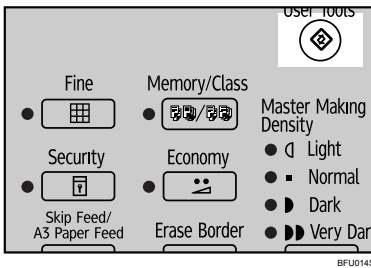

2 Use the [▲][▼] keys to select 4 Initial Settings, and then press the [OK] key.

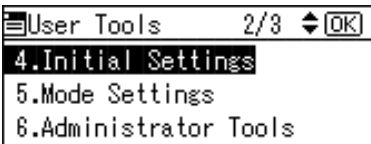

3 Use the [▲][▼] keys to select 7 Program/Change memory, and then press the [OK] key.

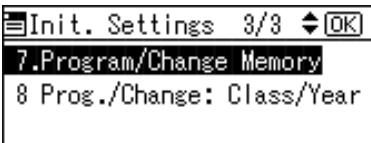

4 Use the [▲][▼] keys to select a number, and then press the [OK] key.

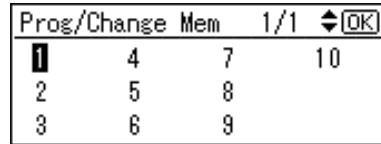

📝 Note

- ❑ If the number is already in use, a message will be displayed asking if you wish to overwrite the settings stored. To overwrite, press the [OK] key. Otherwise press the [Cancel] key to return to the previous display, and then select another number.

5 With the number keys, enter the number of prints for each class, and then press the [#] key.

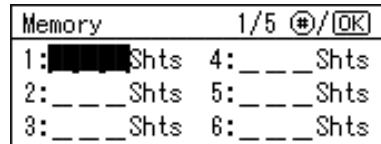

📝 Note

- ❑ Repeat Steps 4 and 5 to register all of your classes.

6 Press the [OK] key.

7 Press the [Clear Modes/Energy Saver] key.

The contents that you have stored are now effective.

Storing Class Mode Settings

1 Press the [User Tools] key.

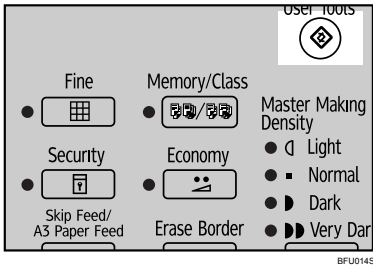

2 Use the [▲][▼] keys to select 4 Initial Settings, and then press the [OK] key.

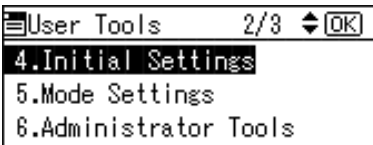

3 Use the [▲][▼] keys to select 6 Program/Change Class, and then press the [OK] key.

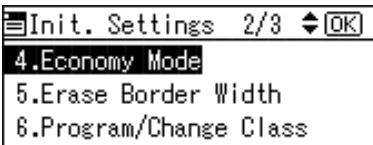

4 Use the [▲][▼] keys to select a number, and then press the [OK] key.

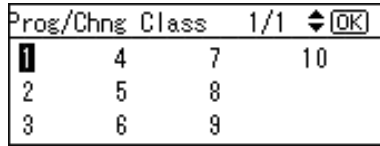

Note

□ If the number is already in use, a message will be displayed asking if you wish to overwrite the settings stored. To overwrite, press the [OK] key. Otherwise press the [Cancel] key to return to the previous display, and then select another number.

5 With the number keys, enter the number of prints, and then press the [#] key.

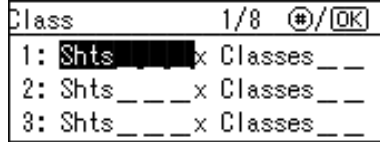

6 With the number keys, enter the number of classes, and then press the [#] key.

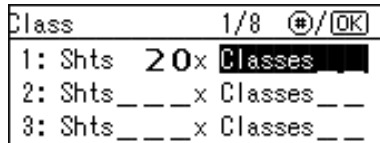

Note

□ Repeat Steps 4 to 6 to register all of your classes.

7 Press the [OK] key.

8 Press the [Clear Modes/Energy Saver] key.

The contents that you have stored are now effective.

Recalling the Stored Settings

- 1 Set your original.
- 2 Press the [Memory/Class] key.

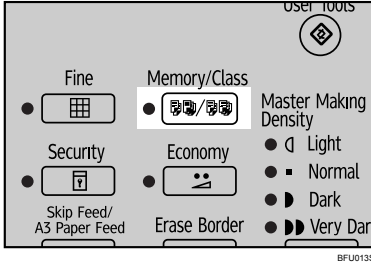

- 3 Use the [▲][▼] keys to select Recall Program, and then press the [OK] key.

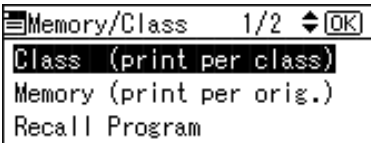

- 4 Use the [▲][▼] keys to select Class or Memory, and then press the [OK] key.

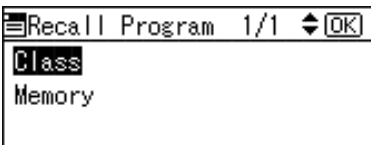

- 5 Use the [▲][▼] keys to select the number to recall, and then press the [OK] key.

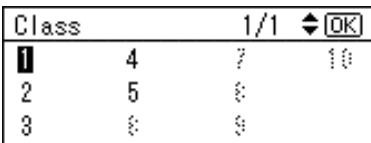

- 6 Confirm that the settings are correct, and then press the [OK] key.

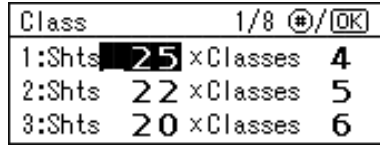

Note

- To change the stored settings, use the [▲][▼] keys to select the item that you wish to change, and then overwrite using the number keys.

- 7 Press the [Start] key.

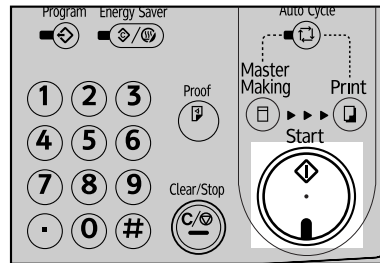

Class/Year

Preparation

To use this mode, you need to first register the number of prints required for each class.

Registering Class/Year

Note

- You can register for up to 108 classes (up to 12 classes per school year for a maximum of 9 school years).

1 Press the [User Tools] key.

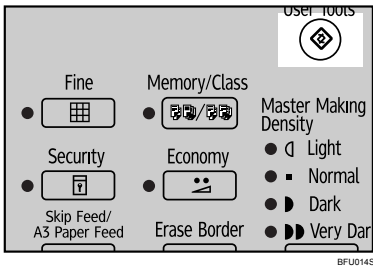

2 Use the [▲][▼] keys to select 4 Initial Settings, and then press the [OK] key.

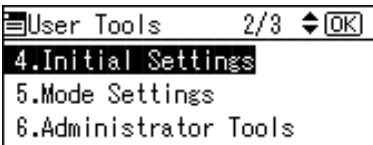

3 Use the [▲][▼] keys to select 8 Prog./Change:Class/Year, and then press the [OK] key.

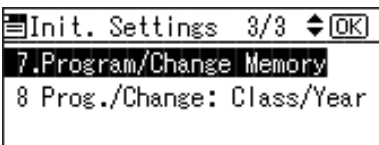

4 Use the [▲][▼] keys to select the desired school year, and then press the [OK] key.

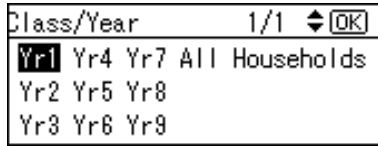

5 With the number keys, enter the number of prints for a class, and then press the [#] key.

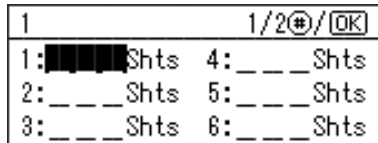

Note

- Repeat Steps 4 and 5 to register all of your classes.

6 Press the [OK] key.

7 Press the [Clear Modes/Energy Saver] key.

The contents that you have registered are now effective.

Printing for All Years

- 1 Set your original.
- 2 Press the [Memory/Class] key.

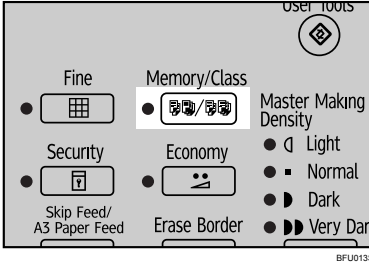

- 3 Use the [▲][▼] keys to select Class/Year, and then press the [OK] key.

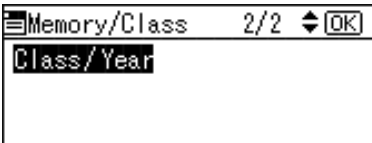

- 4 Use the [▲][▼] keys to select All Years, and then press the [OK] key.

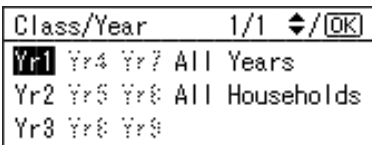

- 5 Press the [Start] key.

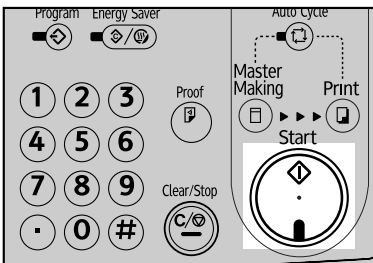

Printing for Selected Classes

- 1 Set your original.
- 2 Press the [Memory/Class] key.

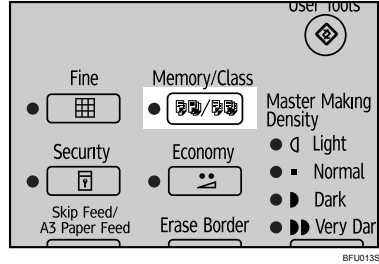

- 3 Use the [▲][▼] keys to select Class/Year, and then press the [OK] key.

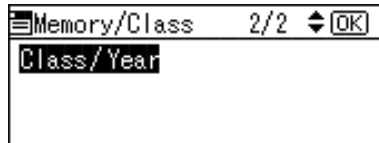

- 4 Use the [▲][▼] keys to select the school year, and then press the [OK] key.

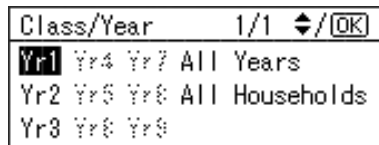

- 5** Use the [▲][▼] keys to select the class that you wish to print for, and then press the [#] key.

Year1		1/1	◆#/[OK]
All	3	6	9
1	4	7	10
2	5	8	11

Note

- Repeat Step 5 to select more classes.
- You can only select classes from the same school year.
- If you have selected the wrong class, highlight it again using the [▲][▼] keys, and then press the [#] key to cancel its selection.

- 6** Press the [OK] key.

- 7** Press the [Start] key.

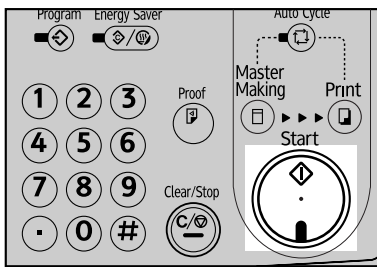

Combine

Use this function to combine two originals onto one sheet of paper.

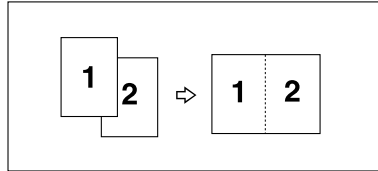

Note

- When the two originals are combined, their sizes would be reduced or enlarged as follows:

❖ Metric version

		Original Size		
		A4	B5	A5
Paper Size	B4	87%	100%	122%
	A4	71%	82%	100%

❖ Inch version

		Original Size	
		8 1/2" × 11"	5 1/2" × 8 1/2"
Paper Size	8 1/2" × 14"	77%	100%
	8 1/2" × 11"	65%	100%

- If the length of the first original is shorter than 91mm, 3.6", Combine mode will be disabled.
- You can set the machine to automatically cancel Combine/Repeat mode once you have finished using it. See "Cancel Combine Setting" on p.109 "5 Mode Settings".

- ❑ Any image closer than 5mm, 0.2" to the leading edge of the first original will not be printed. Also, any image closer than 4mm, 0.16" to the leading edge of the second original will not be printed. When the image is too close to the leading edge, make duplicates of the originals with the image shifted away from the leading edge, and then print from the duplicates.
- ❑ You can select different image settings for the first and second originals.
- ❑ Make sure that the paper feed side plates touch the paper lightly. If they do not, then the two images will not be properly aligned on the prints.

🔍 Reference

For details on how to use the optional Auto Document Feeder when combining originals, see p.58 "Using the Auto Document Feeder when Combining Originals".

1 Place the first original face down on the exposure glass.

📌 Note

- ❑ When combining originals, place the original face down on the exposure glass with its leading edge towards you, as shown above.

2 Press the **[Combine/Repeat]** key.

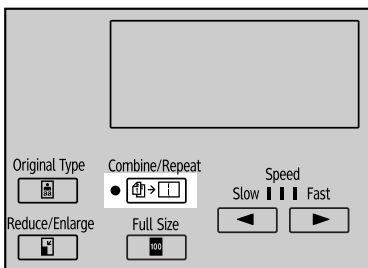

ANT1305

3 Use the **[▲]****[▼]** keys to select **Combine 2**, and then press the **[OK]** key.

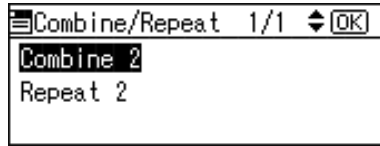

4 Use the **[▲]****[▼]** keys to select **original and paper size**, and then press the **[OK]** key.

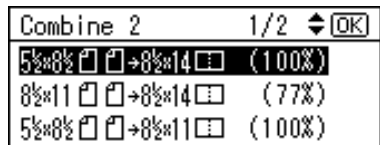

5 Press the **[Start]** key.

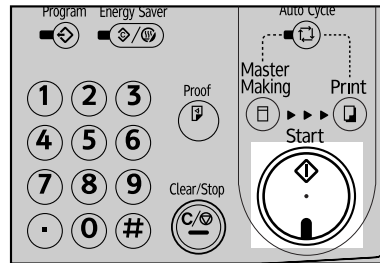

ANT1285

6 After the first original has been scanned, place the second original in the same way.

7 Press the **[Start]** key.

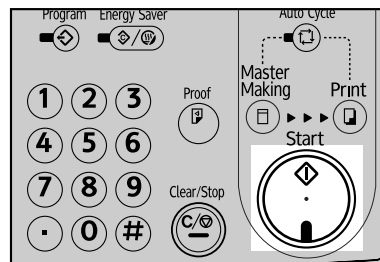

ANT1285

Using the Auto Document Feeder when Combining Originals

1 Place the originals face up in the Auto Document Feeder.

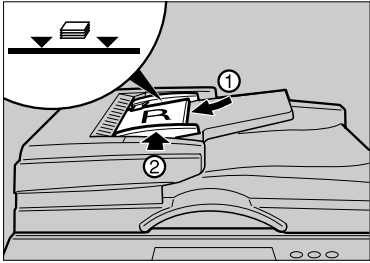

AK1153S

Note

- The first (top) original will be printed on the left side of the print.

2 Press the [Combine/Repeat] key.

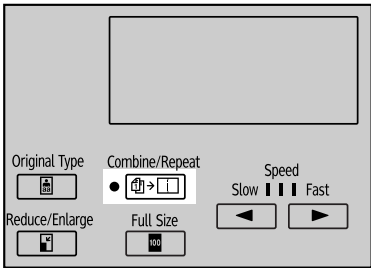

ANT1305S

3 Use the [▲][▼] keys to select Combine 2, and then press the [OK] key.

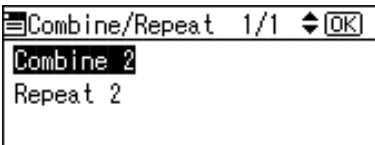

4 Use the [▲][▼] keys to select original and paper size, and then press the [OK] key.

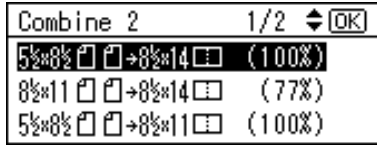

5 Press the [Start] key.

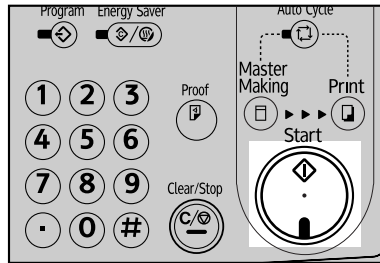

ANT1285S

Note

- After the first original has been stored, the second original is fed.

Repeat

Use this function to repeat the image twice on the same sheet of paper.

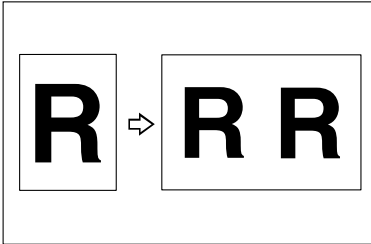

Limitation

- You cannot use the optional Auto Document Feeder with the Repeat function.

Note

- You can choose to have either Combine or Repeat selected by default when the power is turned on. See "Combine/Repeat Priority" on p.109 "5 Mode Settings".

1 Set your original.

2 Press the [Combine/Repeat] key.

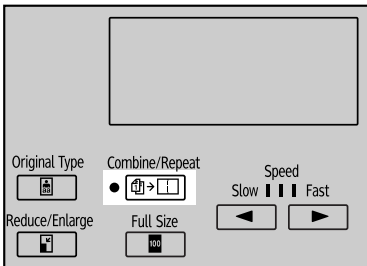

ANT1305

3 Use the [▲][▼] keys to select Repeat 2, and then press the [OK] key.

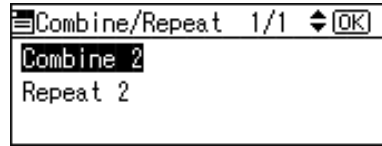

4 Use the [▲][▼] keys to select original and paper size, and then press the [OK] key.

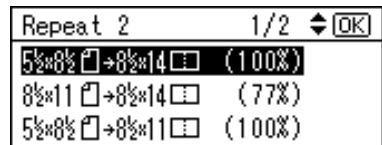

5 Press the [Start] key.

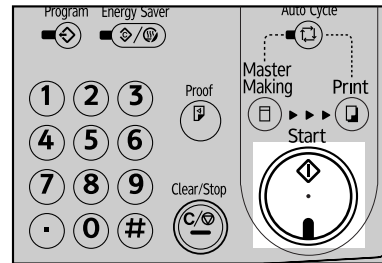

ANT1285

Skip Feed/A3 Paper Feed

Skip Feed

If the backs of prints are dirty, you can use the Skip Feed function to make the drum rotate twice instead of once with every sheet of paper fed. This gives you time to remove prints one by one from the paper delivery tray, or to insert a sheet of paper between two prints.

Note

- You can specify how many times that the drum rotates when the power is turned on. Alternatively, you can also choose whether or not to change the number of rotations temporarily when the **[Skip Feed/A3 Paper Feed]** key is pressed. See "Skip Feed" on p.109 "5 Mode Settings".
- The number of rotations can be set from 2 to 9.
- The default is 2.

1 Press the **[Skip Feed/A3 Paper Feed]** key.

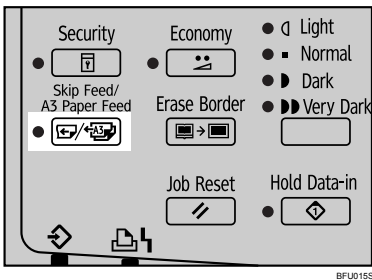

2 Use the **[▲][▼]** keys to select Skip Feed, and then press the **[OK]** key.

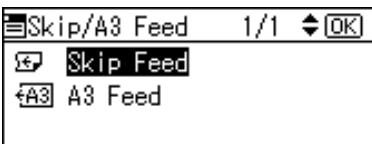

3 Press the **[Start]** key.

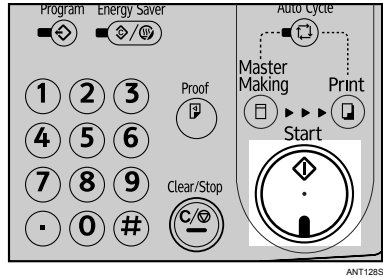

A3 Paper Feed

This machine can print on A3 size paper.

Note

- Although printing on A3 size paper is possible, the maximum possible size of the printed image is 210 × 355 mm. If you print A3 size originals on A3 paper at 100% magnification, areas of the printed image will be missing.
- The horizontal (upper and lower) image position are fixed at -10 mm. The vertical (left and right) print margins can each be adjusted by approximately 1 mm.
- Print speed is limited to 80 cpm.
- A3 Paper Feed is possible for paper between 52.3 g/m², 14 lb. and 157 g/m², 42 lb. in weight.
- The A3 output tray can store up to 500 sheets of 64 g/m², 17 lb. paper.
- To load A3 size paper, the Side pads and Side plate guides must first be removed.
- Skip Feed Printing is not possible when printing on A3 size paper.
- A3 Paper Feed cannot be registered to Memory mode.

- ❑ When the Hold Data-in mode is off, the A3 Paper Feed function cannot be used. When using the A3 Paper Feed function for online printing, set Hold Data-in mode to on after Master Making, and then specify A3 Paper Feed to print.

1 Press the **[Skip Feed/A3 Paper Feed]** key.

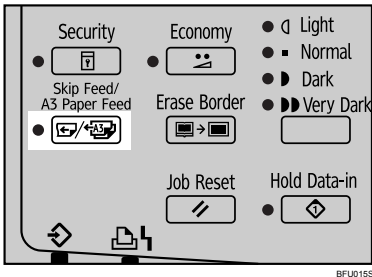

BFU0155

2 Use the **[▲]****[▼]** keys to select A3 Paper Feed, and then press the **[OK]** key.

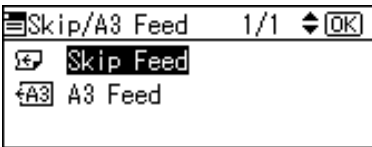

3 Press the **[Start]** key.

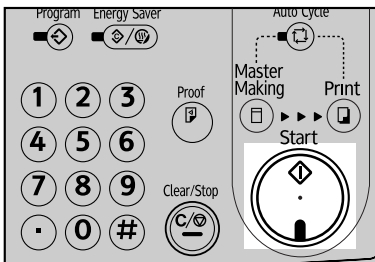

ANT128S

Security Mode

Use this function to prevent others from accessing your masters and making prints of confidential documents after you have done so.

1 After you have made your prints, press the **[Security]** key.

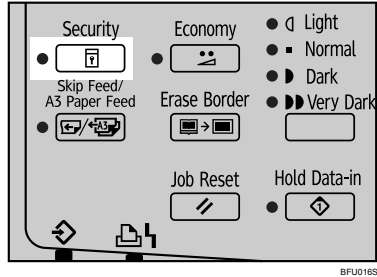

BFU016S

2 Press the **[OK]** key.

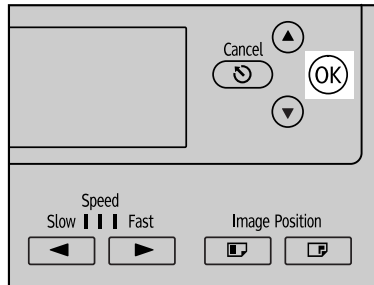

ANT135S

Note

- ❑ Once Security mode is set, you will not be able to press the **[Proof]** key or the **[Start]** key, nor will you be able to pull out the drum unit.
- ❑ Security mode cannot be cleared by turning off the main switch.
- ❑ Security mode will be canceled when you set a new original and press the **[Start]** key.

Online Printing

Online printing allows you to use this machine as a PC printer.

Limitation

- The optional printer controller is required.

Reference

For details about online printing, refer to the manual for the printer controller.

3

Hold Data-in

You can select whether or not the machine automatically switches to Online mode when it receives data from a PC.

Press the **[Hold Data-in]** key to switch it on or off.

When the Hold Data-in mode is off, the machine gives priority to data received from a PC. If you are making prints and do not wish to have your print job interrupted by a PC, press the **[Hold Data-in]** key to turn it on.

Note

- The default is Off.

1 Press the **[Hold Data-in]** key.

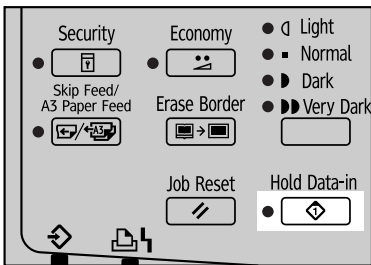

BFU0175

Program

Use this function to store up to nine frequently used print job settings and to recall them for future use.

Note

- The stored contents will not be cleared even when you turn off the main switch.
- The stored contents cannot be deleted. To change the contents of a program, overwrite it with new print settings.
- You can store settings for the following functions:
 - Type of Original
 - Image Density
 - Image Position
 - Printing Speed
 - Fine Mode
 - Preset Reduce/Enlarge
 - Edge Erase
 - Economy Mode
 - Memory/Class
 - Combine/Repeat
 - Skip Feed
 - Hold Data-in
- You cannot store settings for A3 Paper Feed function.
- You cannot store settings for Security mode, nor for the Program function itself.

Registering Print Settings

1 First specify the print settings that you wish to store.

2 Press the **[Program]** key.

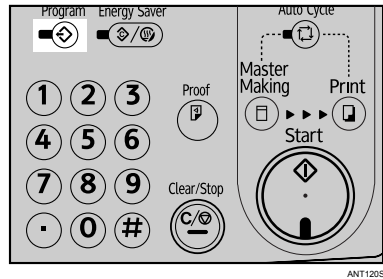

3 Use the **[▲]****[▼]** keys to select Register, and then press the **[OK]** key.

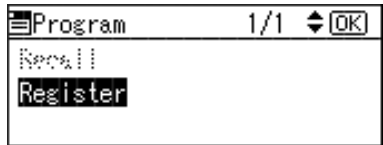

4 Use the **[▲]****[▼]** keys to select a number.

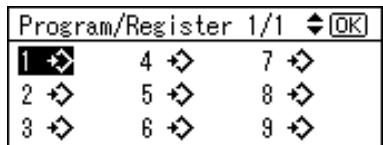

Note

- If the number is already in use, a message will be displayed asking whether you wish to overwrite the settings stored. To overwrite, press the **[OK]** key. Otherwise press the **[Cancel]** key to return to the previous display, and then select another number.

5 Press the **[OK]** key.

Recalling a Program

1 Press the [Program] key.

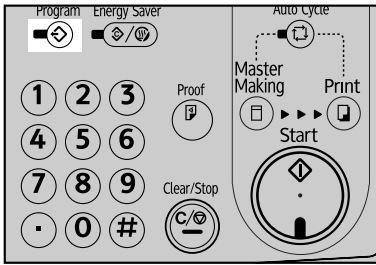

ANT1205

2 Use the [▲][▼] keys to select Recall, and then press the [OK] key.

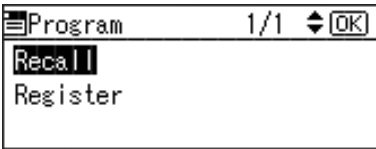

3 Use the [▲][▼] keys to select the number to recall, and then press the [OK] key.

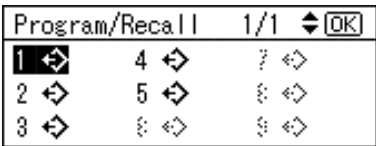

The stored settings are displayed.

4 Confirm that the settings are correct, and then set your original.

5 Press the [Start] key.

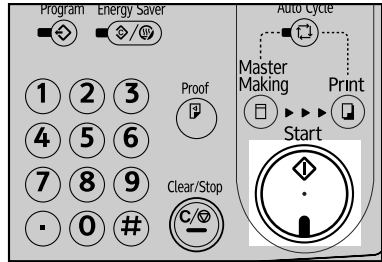

ANT1285

Make Color Prints

Color drum units (red, blue, green, brown, yellow, purple, navy, maroon, orange and teal) are available as options in addition to the standard black unit. For making color prints, a separate drum unit is necessary for each color.

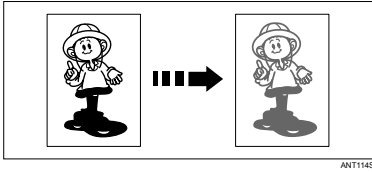

Changing the Color Drum Unit

1 Open the front cover.

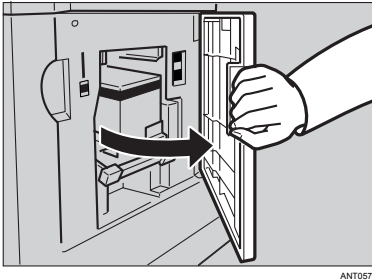

2 Pull out the drum unit handle.

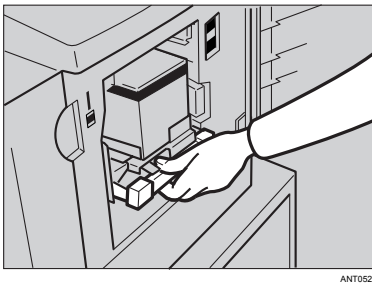

Note

- If you cannot pull out the drum unit, push the drum unit handle, then pull out the drum unit.

3 Hold the rail on the drum and slide out the drum while pulling the release towards you.

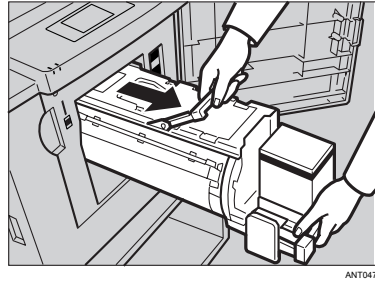

4 Remove the drum unit from the machine while holding the upper drum stay.

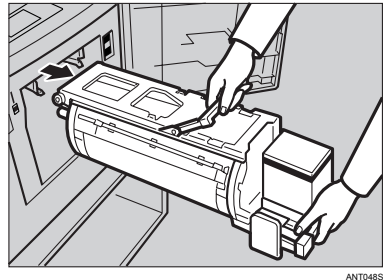

Note

- Be careful not to let the drum unit fall.

- 5** Insert the color drum unit along the guide rail.

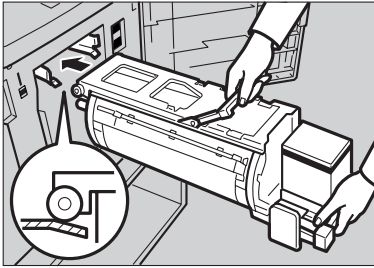

ANT053S

- 6** Slide in the drum unit until it locks into position.

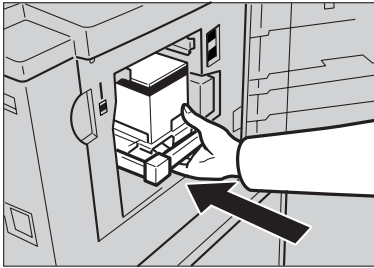

ANT049S

- 7** Lower the drum unit lock lever.

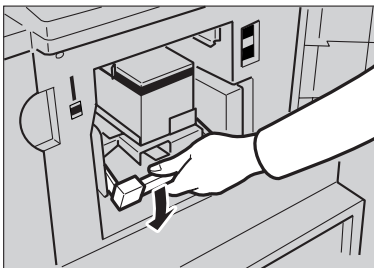

ANT115S

- 8** Close the front cover.



ANT059S

Note

- Make sure that the Cover Open indicator (☐*) turns off, and the Color indicator is lit.

Making Color Prints

- 1** Make sure that the Color indicator is lit.
- 2** Set your original.
- 3** Press the [Start] key.

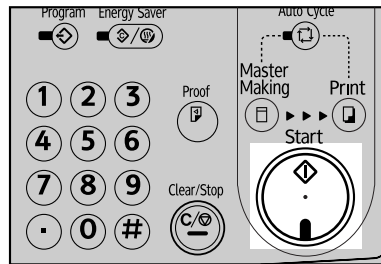

ANT128S

Printing in Two Colors

After printing in one color, you can print in another color on the same side of the print.

Important

- Leave the prints for a while before printing on them again to let the ink dry.
- If the prints are not dry, the paper feed roller might become dirty. In this case, wipe off the roller with a cloth.

Note

- You cannot print in two colors at a time.

- 1** Prepare two originals. Set the first original on the exposure glass.

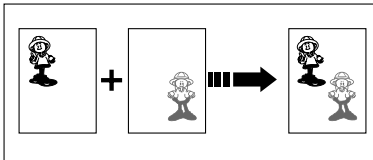

ANT1135

- 2** Enter the number of prints with the number keys.

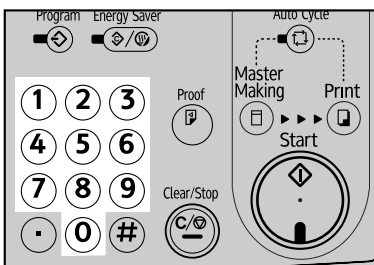

ANT1225

- 3** Press the [Start] key.

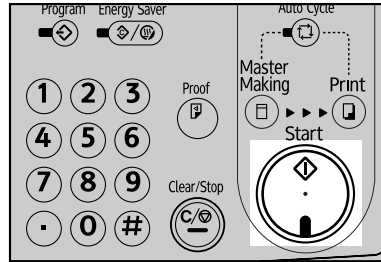

ANT1285

- 4** Remove the prints from the paper delivery tray and set them on the paper feed tray again as shown in the illustration.

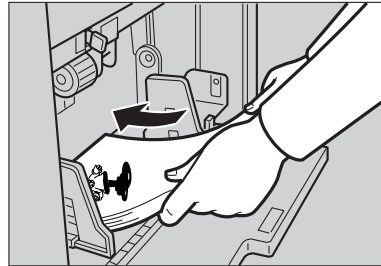

ANT0795

- 5** Exchange the drum unit. See p.65 "Changing the Color Drum Unit".

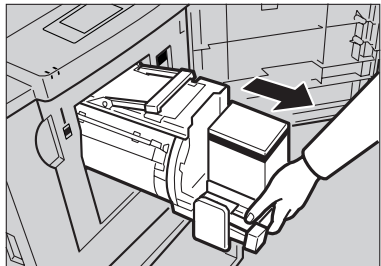

ANT0545

- 6** Set the second original and press the [Start] key.

Combination Chart

This combination chart shows which modes can be used together.

Blank	means that these modes can be used together.
×	means that these modes cannot be used together.

		Function chosen later												
		Master Making Density	Original Type	Fine mode	Economy mode	Auto Cycle	Preset Reduce/Enlarge	Combine/Repeat	Erase Border	Memory/Class	Program	Skip Feed/A3 Paper Feed	On Line	
Function selected first	Master Making Density	--												×
	Original Type		--											×
	Fine mode			--										×
	Economy mode				--									
	Auto Cycle					--								
	Preset Reduce/Enlarge						--							×
	Combine/Repeat							--						×
	Erase Border								--					×
	Memory/Class									--				×
	Program										--			×
	Skip Feed/A3 Paper Feed											--		*1
	On Line	×	×	×			×	×	×	×	×		*1	--

*1 When in On Line mode, the A3 Paper Feed function cannot be used.

4. Troubleshooting

If Your Machine Does Not Operate as You Want

The following chart gives explanations of common problems and messages. If other messages appear, follow the instructions displayed. If a malfunction or a misfeed occurs, the following messages will appear on the display.

❖ When a Message is Displayed

Message	Causes	Solutions
Set the original.	You have not changed the original on the exposure glass before pressing the [Start] key.	Place the next original on the exposure glass or in the ADF.
	An original has not been placed.	Place your originals.
Set the Drum Unit correctly.	The drum unit is not set correctly.	Slide in the drum until it clicks. Make sure that the drum is completely set in position.
Set the Master Eject Box correctly.	The master eject box is not set correctly.	Make sure that the master eject box is completely set in position.
Auto-shutdown occurred due to power problems. Press OK to exit.	A power problem has occurred.	Press [OK] key. If it occurs frequently, contact your customer service.

Printing Problems

4

Problem	Cause	Action
When you try to select several functions at the same time, some of them cannot be selected.	Some functions cannot be used together.	See p.68 "Combination Chart".
Parts of the image are not printed in Edge Erase mode.	The edge erase margin that you set is too wide.	Adjust the edge erase margin with the user tools. See "Erase Border Width" on p.108 "4 Initial Settings".
	The original has very narrow margins.	
Prints are blank, or parts of the image are not printed.	The paper feed side plates are not set correctly.	Make sure that the paper feed side plates touch the paper lightly.
Printing in a second color is unsatisfactory.	The first color is still wet.	Wait until the first color becomes dry.
An uneven solid image appears.	Large solid image wrinkles the master.	Increase the printing speed or use Photo mode.

Printing Problems When Using Combine Mode

Problem	Cause	Action
Prints are blank or parts of the image are not printed.	Original size and orientation are not correct.	You cannot combine originals of different sizes and orientations.
The image is not printed correctly.	The originals were fed in the wrong order.	When using the optional Auto Document Feeder, place the originals face up. The first original should be on the top.
		When using the exposure glass, place the originals face down on the exposure glass. The first original should be placed first.

Loading Paper into the Paper Feed Tray

The **Load Paper** indicator () lights when the paper feed tray runs out of paper.

Replenishing Paper

1 Press the **[Clear/Stop]** key.

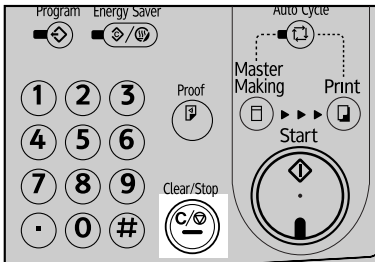

ANT124S

Note

- This step is necessary only if you want to pause a print run to replenish paper.

2 Press the **[Paper Feed Tray Down]** key.

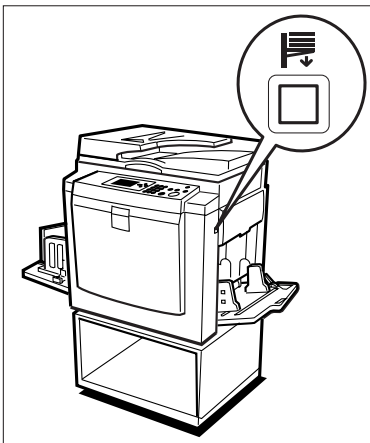

ANT045S

Note

- The paper feed tray will lower without the key being pressed when the printing paper runs out.
- The top sheet might remain between the feed rollers. In this case, remove the top sheet.

3 Load paper into the paper feed tray.

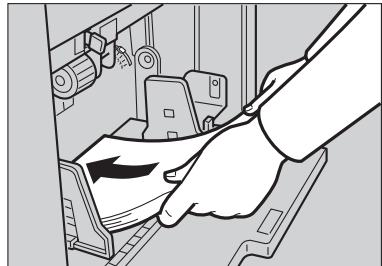

ANT074S

Note

- Correct paper curl before setting the paper.

4 Press the **[Start]** key to resume printing.

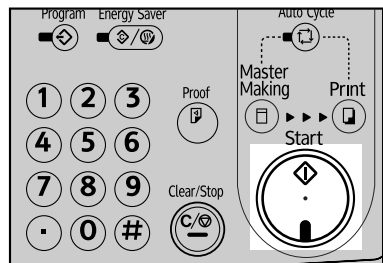

ANT128S

Changing the Paper Size

- 1 Remove the paper from the paper feed tray.

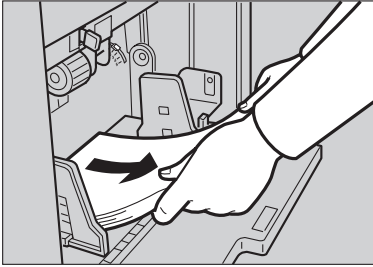

ANT073S

The paper feed tray will lower.

- 2 Shift the paper feed side plates lock lever forward. Adjust the paper feed side plates to match the paper size.

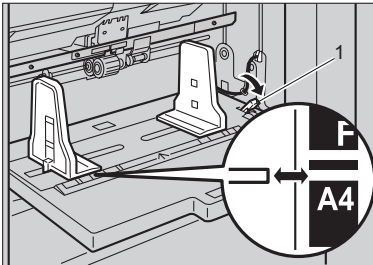

ANT072S

1: Paper Feed Side Plates Lock Lever

- 3 Load paper into the paper feed tray.

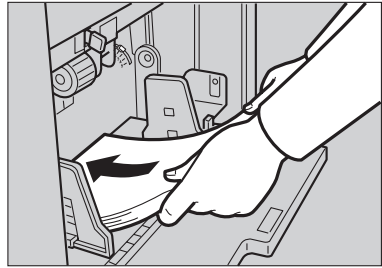

ANT074S

Note

- Correct any paper curl before setting the paper.
- Make sure that the side plates touch the paper lightly.
- Shift the lock lever to its original position.

- 4 Adjust the side plates and the end plate.

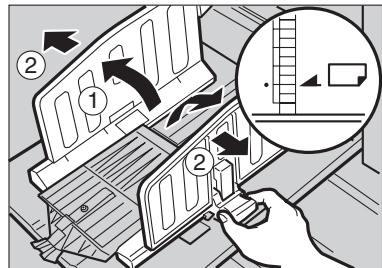

ANT062S

When the Add Ink Indicator (🖨️) Lights

The Add Ink indicator (🖨️) lights when it is time to supply ink.

⚠️ CAUTION:

- *Keep the ink or ink container out of reach of children.*

⚠️ CAUTION:

- *Be careful not to get ink on your clothes when replacing an ink container. Ink stains on clothes are hard to remove.*

⚠️ CAUTION:

- *When disposing of a used ink container, reattach the cap to prevent ink from splattering.*

⚠️ CAUTION:

- *If your skin comes into contact with ink, wash the affected area thoroughly with soap and water.*

⚠️ CAUTION:

- *If ink comes into contact with your eyes, rinse immediately in running water. For other symptoms, consult a doctor.*

⚠️ CAUTION:

- *If ink is ingested, induce vomiting by drinking a strong saline solution. Consult a doctor immediately.*

🔧 Important

- Faults may occur if you use ink other than the recommended type.
- Our products are engineered to meet high standards of quality and functionality, and we recommend that you use only the expendable supplies available at an authorized dealer.

📝 Note

- Be sure to supply ink of the same color as the current drum.
- Store ink in a cool, dry place. Do not store ink where it will be exposed to heat or direct sunlight.
- Store ink on a flat surface.

1 Open the front cover.



2 Push the ink holder lever.

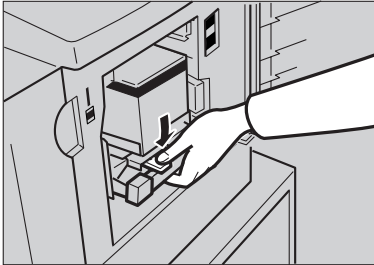

3 Pull out the ink holder.

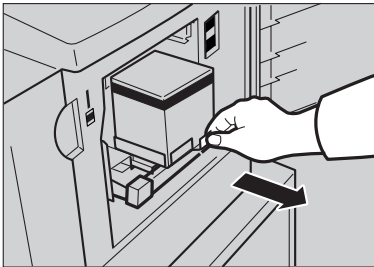

4

4 Remove the used ink cartridge.

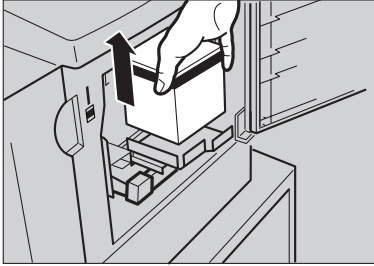

ANT091S

5 Remove the cap of the new ink cartridge.

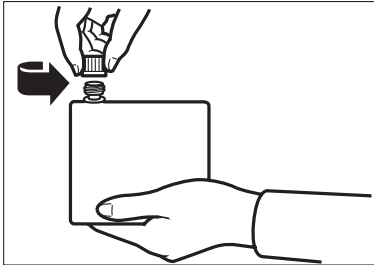

ANT096S

6 Insert the new cartridge into the ink holder.

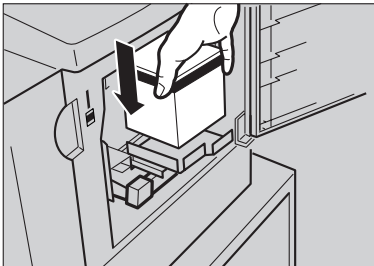

ANT092S

 **Note**

- Always supply ink of the same color.
- Be sure to firmly insert the part indicated by the arrow mark into the guide.

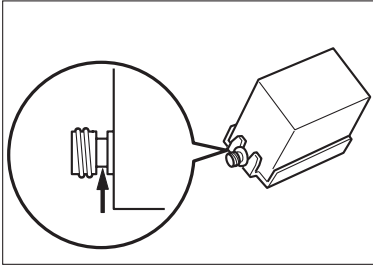

ANT097S

4

7 Return the ink holder to its original position until it clicks.

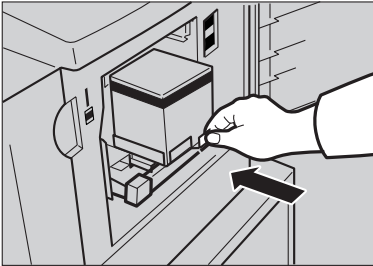

ANT096S

8 Close the front cover.



ANT056S

The machine will start idling to supply ink to the drum.

 **Note**

- It will stop when the correct amount of ink reaches the drum.

Master Roll Replacement

The **Master End** indicator (🔊) is lit when it is time to replace the master roll.

- 1** Pull out the master tray.

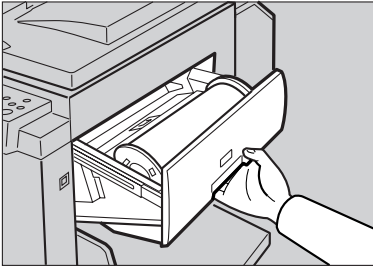

ANT065S

- 2** Press the release button to open the master feeding cover.

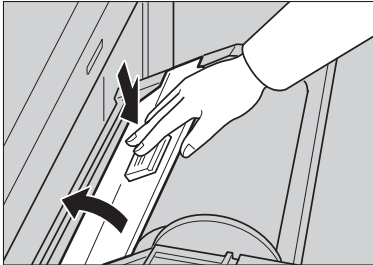

ZJVH070E

- 3** Unwrap the tape from the new master roll.

- 4** Remove the used master roll and pull out both spools. Then, insert both spools into a new master roll.

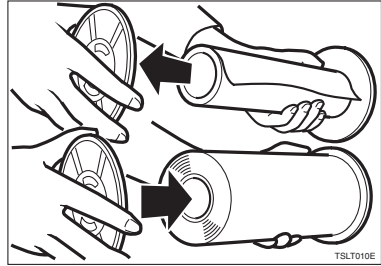

TSLT010E

Note

- It is necessary to replace the master roll even if some master remains on the old roll.

- 5** Set the new master roll in the master tray.

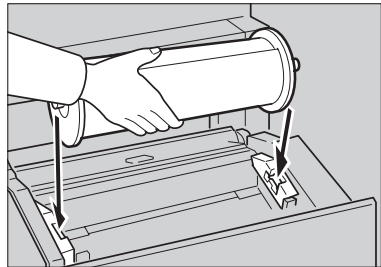

ZFRH260E

- 6** Insert the master and set its leading edge to the position of the marks.

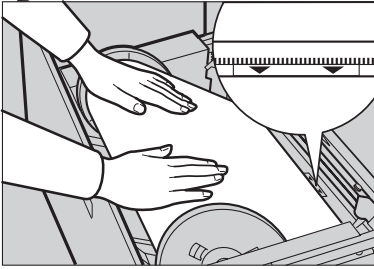

ANT080S

4

- 7** Close the master feeding cover firmly.



ZFRH250E

- 8** Close the master tray.

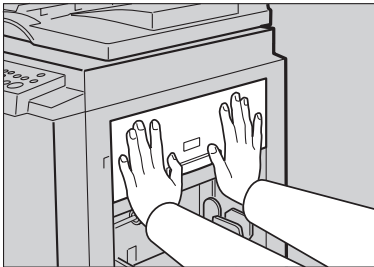

ANT066S

Placing a New Roll of Tape in the Tape Dispenser (Optional)

Note

- Make sure that the main switch is turned on and the power switch of the tape dispenser is off.

- 1** Open the cover of the tape dispenser.

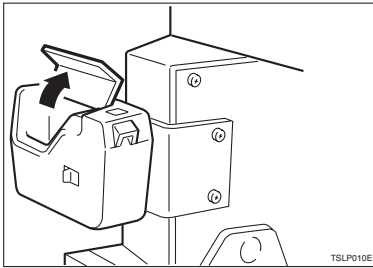

- 2** As shown, put the roll in the dispenser.



Note

- Make sure that the tape is installed in the proper direction. If it is not in the correct direction, the tape dispenser will not work correctly.

- 3** Feed the leading edge of the roll in the dispensing slot until it stops.

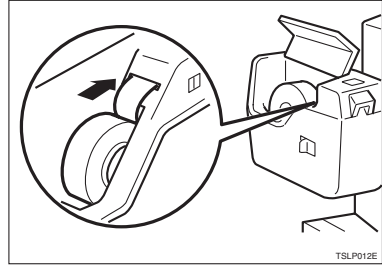

Note

- Push the tape as far as possible through the slot.

- 4** Turn on the power switch of the tape dispenser.

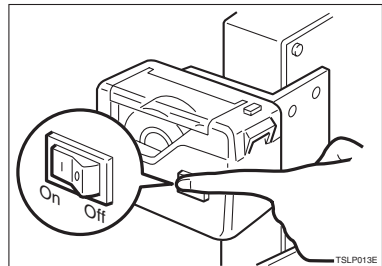

- 5** Press the manual cut button to trim off the leading edge of the tape.

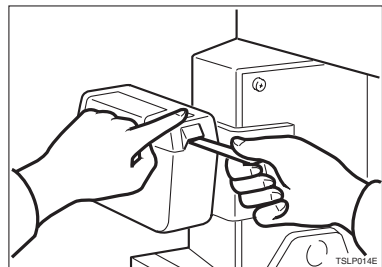

🔧 Clearing Misfeeds

The location indicators show where the jam has occurred.

🚨 Important

- ❑ When clearing misfeeds, do not turn off the main switch. Otherwise, your print settings are cleared.

“🔧 + P” Original Misfeeds Occur in the Auto Document Feeder

An original misfeed has occurred in the optional Auto Document Feeder.

📌 Note

- ❑ This indicator is only displayed when the machine is equipped with the optional Auto Document Feeder.

1 Open the Auto Document Feeder cover.

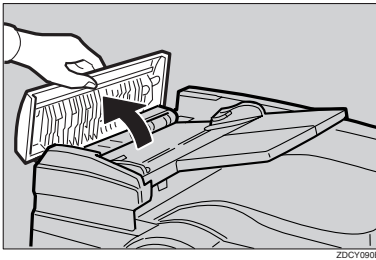

2 Pull out the original gently.

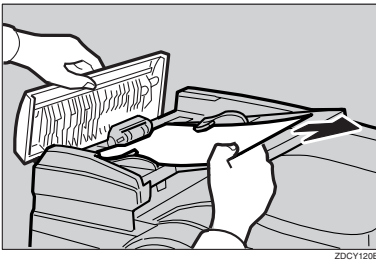

3 If you are unable to remove the misfed original in Step 2, lift the Auto Document Feeder.

- 4** Pull the green knob towards you to remove the original.

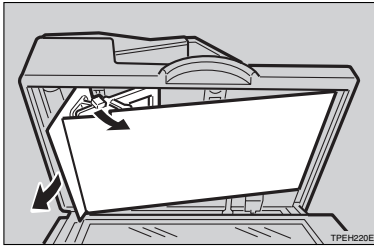

- 5** Return the document feed sheet to its original position.
- 6** Close the Auto Document Feeder cover until it clicks into position.

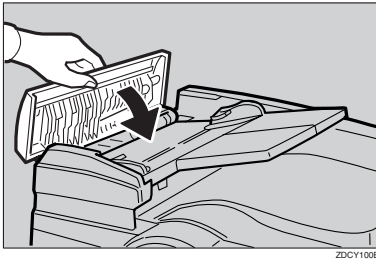

.....

 **To prevent original misfeeds**

Use the exposure glass for the following kinds of originals:

- Originals heavier than 128g/m², 34 lb.
- Originals lighter than 52g/m², 14 lb.
- Originals smaller than 148mm × 210mm, 5.9" × 8.3"
- Originals larger than 297mm × 864mm, 11.6" × 34.0"
- Stapled or clipped originals
- Perforated or torn originals
- Curled, folded, or creased originals
- Originals with any kind of coating, such as thermal fax paper, art paper, aluminum foil, carbon paper, or conductive paper
- Bound originals such as books
- Damaged originals
- Originals with glue on them
- Pasted originals
- Originals written in pencil
- Thin and flimsy originals
- Originals with index tabs
- Transparent originals such as OHP transparencies or translucent paper

 **Note**

- You cannot place originals of different sizes at the same time.
 - Remove staples or clips from the originals, and then fan the originals lightly.
 - Do not stack originals above the limit mark.
-

“A” Paper Misfeeds in the Paper Feed Section

A paper misfeed has occurred in the paper feed section.

CAUTION:

- Be careful not to cut yourself on any sharp edges when you reach inside the machine to remove misfed sheets of paper or masters.

1 Slowly but firmly pull out the paper.

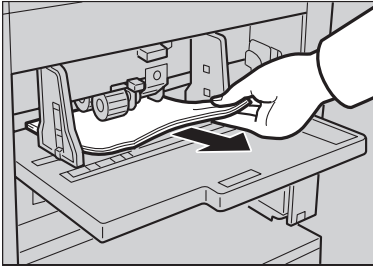

ZFRY010E

2 If the indicators remain lit, open the front cover and close it firmly or press [OK] key.

Reference

See p.86 “To prevent paper misfeeds”.

“B” Paper Wrapped around the Drum

The paper is wrapped around the drum.

1 Pull out the drum unit.

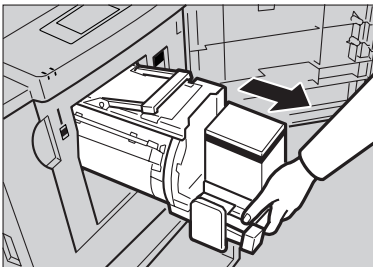

ANT054S

2 Remove the misfed paper.

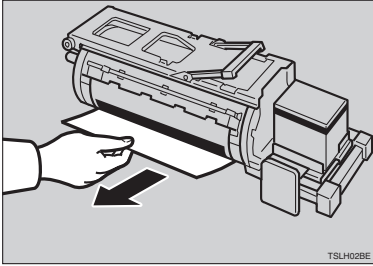

3 Insert the drum unit until it locks into position, and then lower the drum unit lock lever.

4

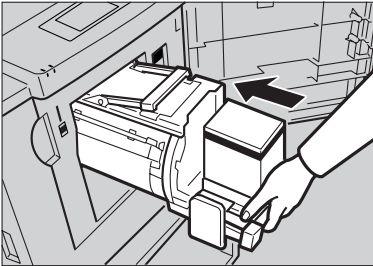

4 Close the front cover.



Reference

See p.86 "To prevent paper misfeeds".

“Ar + C” Paper Misfeeds in the Paper Exit Section

A paper misfeed has occurred in the paper exit section.

⚠ CAUTION:

- *Be careful not to cut yourself on any sharp edges when you reach inside the machine to remove misfed sheets of paper or masters.*

1 Remove the misfed paper.



📌 Note

- Make sure that the paper delivery end plate and side plates are in their correct positions.
- If a jam occurs because the current printing speed is too fast, reduce the speed.

2 If you can not see the misfed paper, push the button and open the master eject unit.

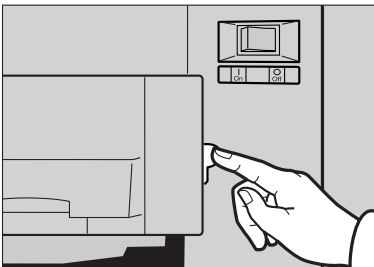

3 Remove the misfed paper.

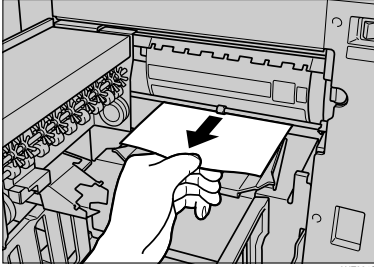

ANT084S

4 Close the master eject unit.

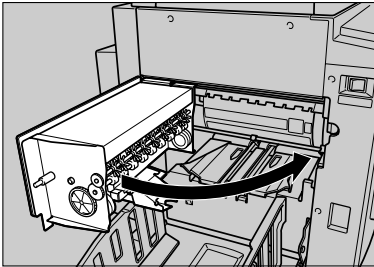

ANT083S

5 If the indicators remain lit, open the front cover and close it firmly or press [OK] key.

To prevent paper misfeeds

If paper is curled or the margin on the leading edge of the original is too narrow, the following action is necessary.

- Before using the paper, correct the curl as shown below.

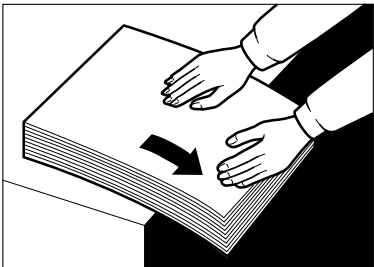

BQA023S

- If you are unable to correct the paper curl, place the paper in the paper feed tray with it curling either upward or downward, as shown in the illustration below.

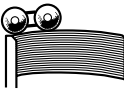
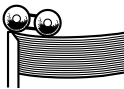
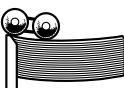
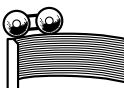
	Right	Wrong
Thin Paper		
Thick Paper		

TPEY990E

- When the leading edge margin of the original is less than 5mm, 0.2" , or when there is a solid image on the leading edge, feed the original from the edge with the widest margin. Alternately, create a leading edge margin on a duplicate of the original, and then print from the duplicate.

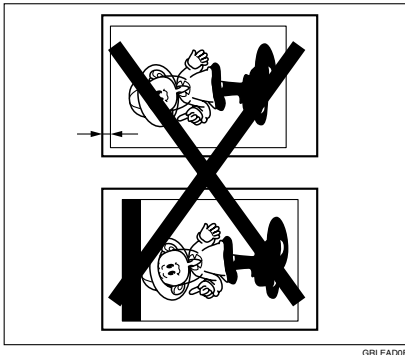

GRLEADE

- Depending on the paper type, paper jams or wrinkling may occur. In such cases, reduce the printing speed and then print. For details about how to change printing speed, see p.40 "Changing the Printing Speed".



“A + D” Master Misfeeds in the Master Feed Section

A master misfeed has occurred in the master feed section.

- 1** Pull out the master tray.

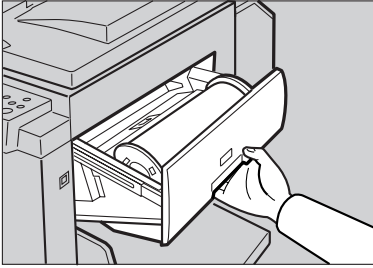

ANT065S

- 2** Open the master feeding cover, and then remove the misfed master inside.

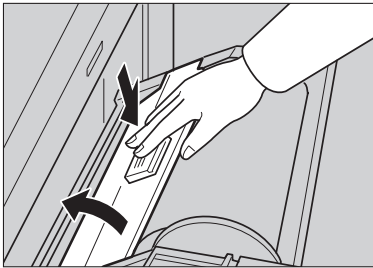

ZJVH070E

- 3** Set the leading edge of the master to the position of the marks.

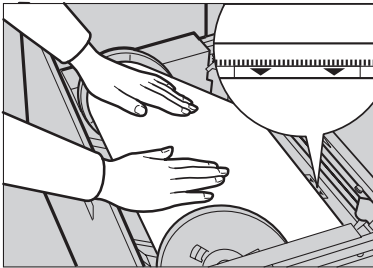

ANT080S

- 4 Close the master feeding cover firmly.



ZFRH250E

- 5 Close the master tray.

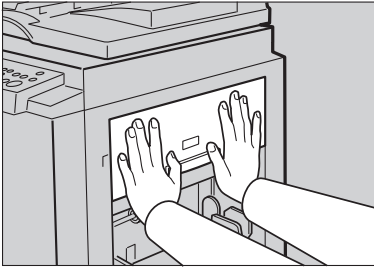

ANT066S

“**A** + **A** + **B**” Paper Misfeeds in the Paper Feed Section

The paper is jammed between the drum and the paper feed section.

- 1 Unlock the lever and then pull out the drum unit.

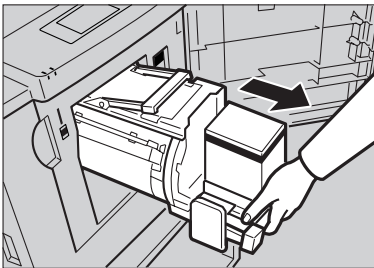

ANT054S

2 Remove the misfed paper from inside.

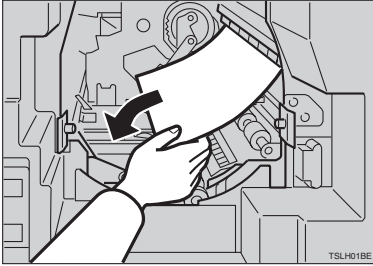

3 Insert the drum until it locks into position, and then lower the lock lever.

4

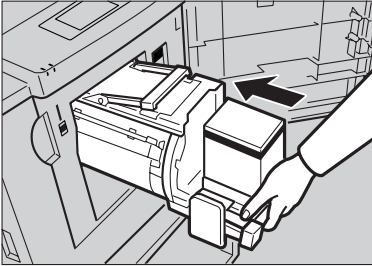

4 Close the front cover.



“A + B + E” Master Misfeeds in the Master Eject Section

Either a master misfeed has occurred in the master eject section, or the master is wrapped around the drum unit.

- 1** Grip the handle and pull out the master eject box.

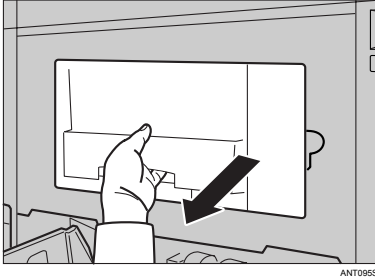

- 2** Remove the misfed master.

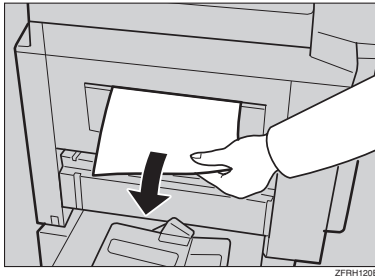

Note

- ❑ Be careful not to stain your hands with ink when you touch used masters.

- 3** Return the master eject box to its original position.

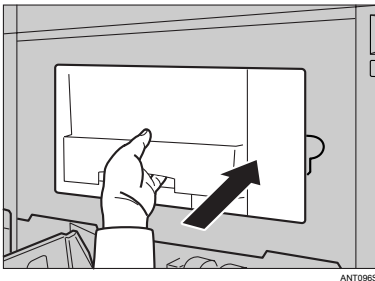

When the master is wrapped around the drum

1 Unlock the lever and then pull out the drum unit.

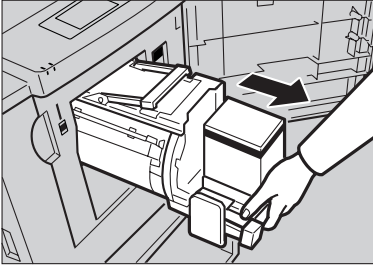

ANT054S

4

2 Unlock the lever to open the clamp of drum unit.

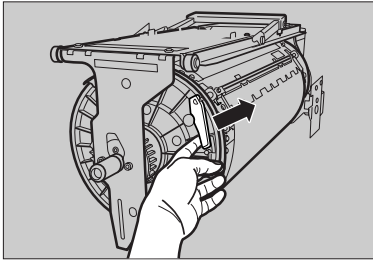

ANT111S

3 Remove the misfed master.

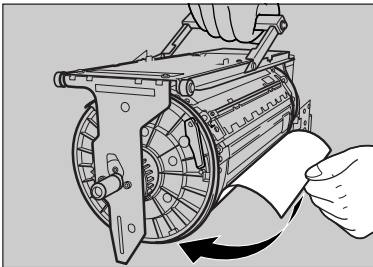

ANT085S

Note

- When the lever is released, the clamp will be set back. Make sure that the clamp is set correctly as shown.

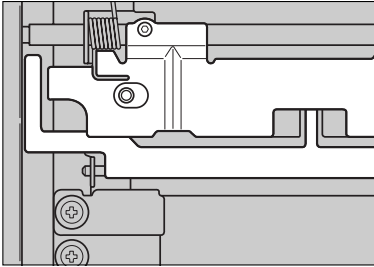

- 4** Insert the drum until it locks into position, and then lower the lock lever.

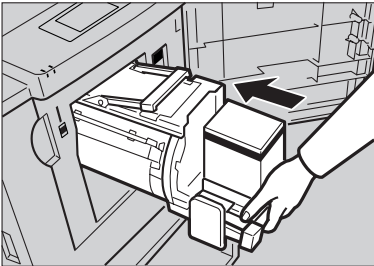

- 5** Close the front cover.



When the Open Cover/Unit Indicator () Lights and a Message is Displayed

A message is displayed explaining the place where the doors/covers are not properly closed.

Front Cover is Open

1 Close the front cover completely.



Master Eject Unit is Open

1 Close the master eject unit.

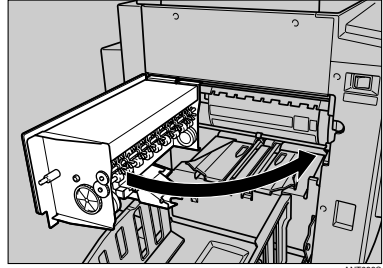

Cover of Optional Auto Document Feeder is Open

1 Close the Auto Document Feeder until it clicks into place.

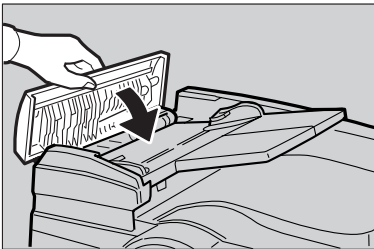

When the Master End Indicator (🔴) Lights and a Message is Displayed

A message is displayed explaining the place in the master feed section that is not properly set.

Master Feeding Cover is Open

- 1 Close the master feeding cover firmly with both hands.



ZFRH250E

Master Tray is Not Set Properly

- 1 Push in the master tray completely.

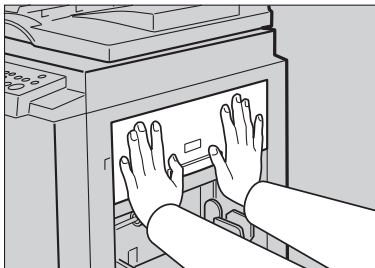

ANT066S

When the Master Eject Indicator (🔌) Lights

The master eject indicator (🔌) lights when it is time to empty master eject box.

1 Grip the handle and pull out the master eject box.

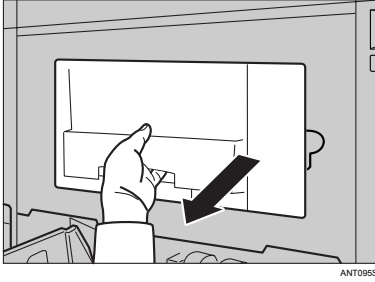

2 Remove the used masters.

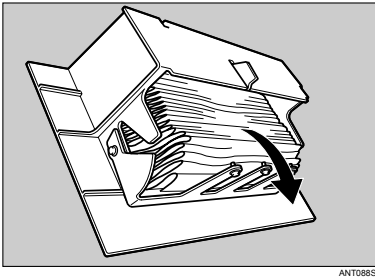

Note

- ❑ Spread out an old newspaper, and then tip the used masters onto the newspaper. Throw away the used masters.

3 Return the master eject box to its original position.

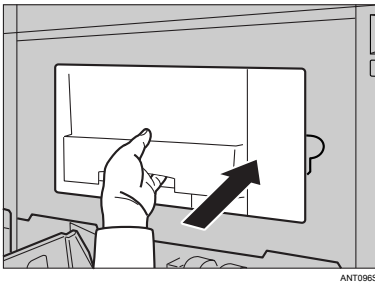

When Other Indicators Light

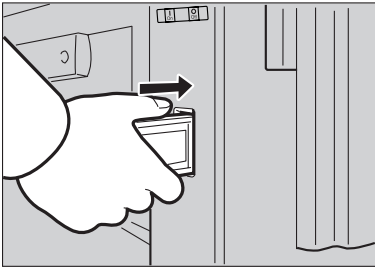
<p>123 Set Key Counter.</p>	<p>The key counter (option) is not set. Insert the key counter into its slot.</p>  <p>ZCTH130E</p>
--	---

Poor Printing

Dirt on the Back Side of Paper



4

Note

- When you use paper that is smaller than the original, select the proper reduction ratio. Otherwise, you might get dirty background prints.
- When you use postcards, the background might be dirty because postcards do not absorb ink well.

1 Turn off the main switch.



2 Open the front cover.

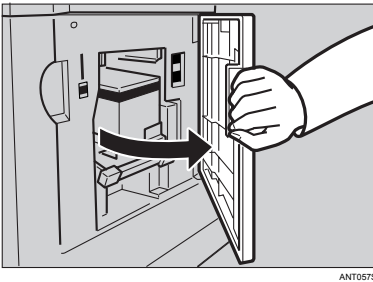

- 3** Unlock the lever, and then pull out the drum unit.

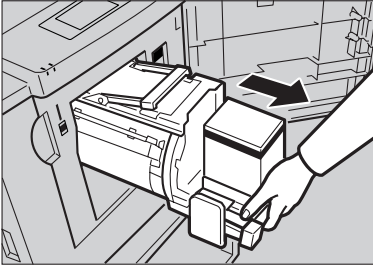

ANT054S

Reference

For details about how to remove the drum unit, see p.65 “Changing the Color Drum Unit”.

4

- 4** Clean the pressure roller with a clean cloth.

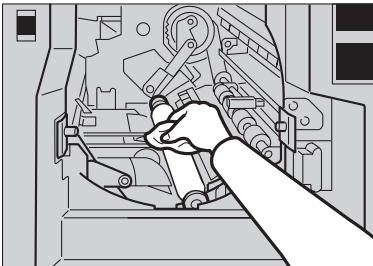

ANT058S

- 5** Insert the drum unit until it locks into position, and then lower the drum unit lock lever.

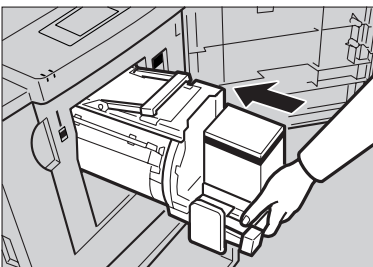

ANT061S

6 Close the front cover.



ANT059S

7 Turn on the main switch.

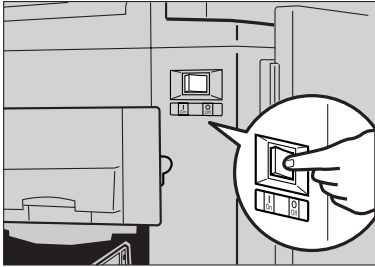

ANT077S

Dirt on the Front Side of Paper (Black Line/Stain)

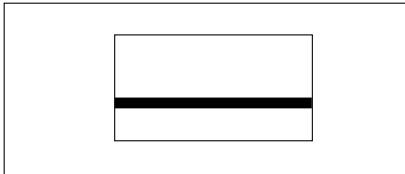

GRBLAC1E

Note

- If there is no margin or if there is a solid image area near the leading edge of the original, make a margin of at least 5mm, 0.2" at the leading edge. Otherwise, the paper exit pawl might become dirty and cause black lines on prints.
- Check the exposure glass cover and clean it if dirty. See p.120 "Maintaining the Machine".
- Check the exposure glass and clean it if dirty. See p.120 "Maintaining the Machine".
- When black lines or stains still appear on prints even if you clean the above, contact your service representative.

Blank Prints or Incomplete Prints

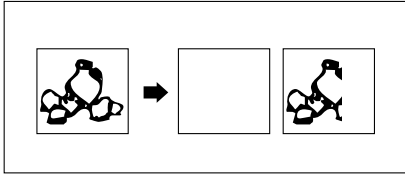

- Make sure that the paper feed side plates touch the paper lightly. Shift the lock lever backward.

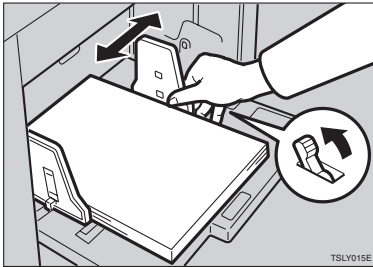

- When you use the optional Auto Document Feeder, make sure that the original guides contact the originals lightly.

When blank or incomplete prints persist even after you have checked the above, perform the following procedure.

1 Open the front cover.



2 Unlock the lever and pull out the drum unit.

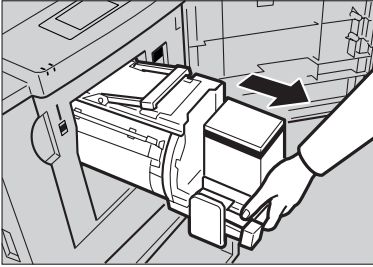

ANT054S

Reference

For details about how to remove the drum unit, see p.120 “Maintaining the Machine”.

3 Remove paper that is stuck to the drum.

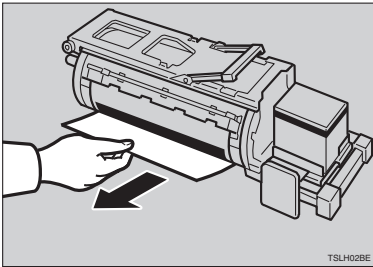

TSLH02BE

4 Insert the drum unit until it locks into position, then lower the drum unit lock lever.

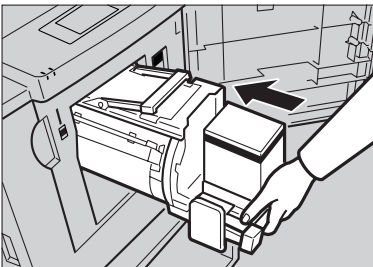

ANT061S

5 Close the front cover.



ANT059S

5. User Tools

Accessing the User Tools

This section is intended for the machine administrator. The user tools allow the administrator to customize the default settings of this machine.

Reference

For the detailed user tool menu, see p.106 “User Tools Menu”.

1 Press the [User Tools] key.

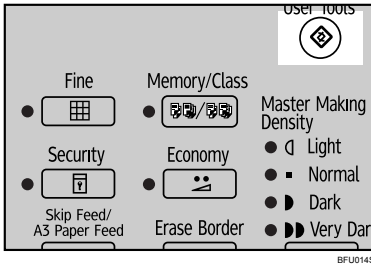

2 Use the [▲][▼] keys to select the desired user tool.

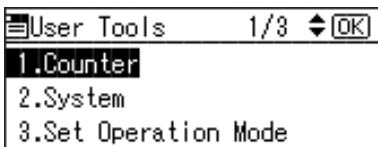

Reference

See p.106 “User Tools Menu”.

3 Enter a number using the number keys or select the desired mode using the [▲][▼] keys.

4 Press the [OK] key.

Quitting User Tools

1 To quit the User Tools menu, press the [User Tools] key.

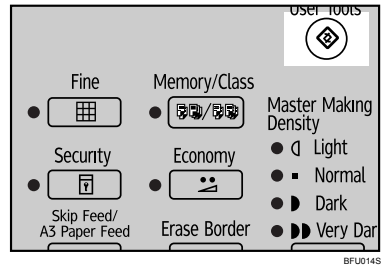

Note







- ☐ Changes made to the following user tools become effective when you press the [Clear Modes/Energy Saver] key.
 - Program/Change Class
 - Program/Change Memory
 - Prog./Change: Class/Year
 - Skip Feed



User Tools Menu

1 Counter





No.	Mode	Description
1	Display Counter	Shows the total number of masters and prints.  Note <input type="checkbox"/> The trial print will not be counted as part of the total.

2 System





No.	Mode	Description
1	Auto Reset Timer	The machine automatically returns to its initial condition if it has not been operated for a certain period of time.  Note <input type="checkbox"/> Default: <i>Off</i>
2	Disp. Resettable Counter	Shows the total number of masters and prints after resetting.  Note <input type="checkbox"/> The trial print will not be counted as part of the total.
3	Reset Resettable Counter	You can select whether or not to clear the number of resettable counter.  Note <input type="checkbox"/> Default: <i>Do not reset</i>
4	mm/inch	You can select the units of measurement used on the panel display.  Note <input type="checkbox"/> Default: <ul style="list-style-type: none"> • Metric version: <i>mm</i> • Inch version: <i>inch</i>
5	Language on LCD	You can select the language for the panel display.  Note <input type="checkbox"/> Default: <i>English</i>
6	Date/Time	You can set the date and time for the machine's internal clock using the number keys.
7	Energy Saver Option	You can select the energy saver mode from Energy Saving or Auto Off.  Note <input type="checkbox"/> Default: <i>Energy Saving</i>

No.	Mode	Description
8	Energy Saver Timer	You can specify the time taken for the machine to enter Energy Saver mode.  Note <input type="checkbox"/> Default: 3 min. (minutes)
9	Auto Off Timer	You can select to use the auto off timer.  Note <input type="checkbox"/> Default: Off
10	Data Print	You can print the log data and the counter list.









3 Set Operation Mode

No.	Mode	Description
1	Minimum Print Quantity	You can set a minimum print quantity between 0 and 9999. Any number below the minimum will not be printed.  Note <input type="checkbox"/> Default: 0
2	Maximum Print Quantity	You can set a maximum print quantity between 0 and 9999.  Note <input type="checkbox"/> Default: 9999
3	Panel Beeper	You can turn the beeper on or off.  Note <input type="checkbox"/> Default: Standard <input type="checkbox"/> Available settings: <ul style="list-style-type: none"> • All On (The beeper sounds either when you press a key or when warning messages are shown on the panel display.) • Standard (The beeper sounds only when warning messages are shown on the panel display and not when you press a key.) • All Off (The beeper does not sound at all.)
4	LCD Contrast	You can adjust the brightness of the panel display.
5	Class Display	Under the Memory/Class function, you can select to have “Select Class/Year” displayed as “Select Department” instead, when the machine is not limited to school or college use.  Note <input type="checkbox"/> Default: School Year

4 Initial Settings

No.	Mode	Description
1	Master Making Density	You can specify the image density that is selected by default when the power is turned on.  Note <input type="checkbox"/> Default: <i>Normal</i>
2	Original Type	You can specify the original type that is selected by default when the power is turned on.  Note <input type="checkbox"/> Default: <i>Text</i>
3	Ratio	You can specify the reproduction ratio that is selected by default when the power is turned on.  Note <input type="checkbox"/> Default: <i>100% (Full Size)</i>
4	Economy Mode	You can select to have Economy mode as either “On” or “Off” when the power is turned on, or after mode settings have been cleared.  Note <input type="checkbox"/> Default: <i>Off</i>
5	Erase Border Width	You can specify the edge erase margin.  Note <input type="checkbox"/> Default: <i>5 mm, 0.2”</i>
6	Pro-gram/Change Class	To store settings of the Class mode, see p.52 “Storing Class Mode Settings”.
7	Pro-gram/Change Memory	To store settings of the Memory mode, see p.50 “Storing Normal Memory Mode Settings” and p.51 “Storing Stack Memory Mode Settings”.
8	Prog./Change: Class/Year	To store settings of the Select Class/Year, see p.54 “Registering Class/Year”.





5 Mode Settings

No.	Mode	Description
1	Auto Cycle	You can select to have Auto Cycle mode as either "On" or "Off" when the power is turned on.  Note <input type="checkbox"/> Default: <i>On</i>
2	Background Correction	When you make prints in Photo, or Text/Photo mode, the background of the prints might appear dirty. In this case, you can select background correction to improve the clarity of your prints.  Note <input type="checkbox"/> Default: <i>Correct text mode only</i>
3	Longer Paper	If you are making prints on paper of custom sizes, you can set "Use".  Note <input type="checkbox"/> Default: <i>Do not Use</i>
4	Combine/Repeat Priority	You can choose to have either Combine or Repeat selected by default when the power is turned on.  Note <input type="checkbox"/> Default: <i>Repeat Priority</i>
5	Cmb/Img Repeat Sep. Line	You can specify the type of separate line of combine and repeat.  Note <input type="checkbox"/> Default: <i>None</i>
6	Cancel Combine Setting	You can specify whether Combine/Repeat mode will be automatically cleared after you have finished your print job.  Note <input type="checkbox"/> Default: <i>Do not Cancel</i>
7	Skip Feed	You can specify the number of times that the drum rotates when in Skip Feed mode.  Note <input type="checkbox"/> Default: <i>2 times</i> <input type="checkbox"/> The time can be set from 2 to 9 times.
8	Memory Mode Setting	You can choose to have either Memory mode or Stack Memory mode as the default.  Note <input type="checkbox"/> Default: <i>Normal (Memory mode)</i>
9	Auto Class	Under the Class mode, the machine stops after it is finished a Class print job. When you select Auto Class, the machine stops for 2 seconds and then goes on to the next Class print job.  Note <input type="checkbox"/> Default: <i>Normal</i>

6 Administrator Tools

❖ User Codes







If user codes are turned on, operators must enter their user codes before they can operate the machine. The machine keeps count of the number of masters and prints made under each user code. See “3 User Code Management” below.



1	Display Counter(s)	You can check the number of masters and copies made under each user code.
2	Clear Counter(s)	You can clear each or all of the user code counters.  Reference To clear the number of masters and copies, see p.114 “Clearing the Counter”.
3	User Code Management	You can select whether or not to use User Code mode.  Note <input type="checkbox"/> Default: <i>Do not Use</i>
4	Key Counter Adjust	Normally, the optional key counter counts the number of prints regardless of the number of masters used. You can, however, add to the key counter a value between 0 and 50 to the key counter each time a new master is used.  Note <input type="checkbox"/> Default: <i>0 time</i> <input type="checkbox"/> Range of adjustment: 0–50
5	User Tools Protect	Prevent the initial (User Tools) menu being accessed by users other than the administrator.  Note <input type="checkbox"/> Default: <i>Off</i>
6	User Tools Protect PW	Specify a four digit password for setting User Tools Protect.

7 Online Settings

Limitation

- The optional printer controller is required for these settings.
- The displayed Online Settings menus depend on the type of printer controller.

No.	Mode	Description
1	Hold Data-in	<p>You can select to have Hold Data-in mode either "On" or "Off" when the power is turned on, or after mode settings have been cleared.</p> <p> Note <input type="checkbox"/> Default: <i>Off</i></p>
2	List/Test Print	Allows you to print the system controller's configuration data.
3	DHCP (Auto-Obtain)	<p>Select either "On" or "Off" for DHCP. If you select "On", the machine obtains its IP address automatically by DHCP. If you select "Off", a static IP address must be manually specified as the machine's IP address.</p> <p> Note <input type="checkbox"/> Default: <i>On</i></p>
4	IP Address	<p>If you have selected "Off" for the DHCP setting, you must specify a static IP address for the machine here.</p> <p> Note <input type="checkbox"/> Default: <i>11.22.33.44</i></p>
5	Subnet Mask	<p>If you have selected "Off" for the DHCP setting, you must specify a subnet mask for the machine here.</p> <p> Note <input type="checkbox"/> Default: <i>0.0.0.0</i></p>
6	Gateway Address	<p>If you have selected "Off" for the DHCP setting, you must specify a gateway address for the machine here. (A gateway is a connection or interchange point between two networks.)</p> <p> Note <input type="checkbox"/> Default: <i>0.0.0.0</i></p>
7	Ethernet Speed	<p>Allows you to specify the network access speed.</p> <p> Note <input type="checkbox"/> Default: <i>Auto Select</i></p>

8	I/O Timeout	<p>Allows you to specify how many seconds the machine waits before it cancels a stalled print job.</p> <p>Note that if job data from other ports often arrives while earlier print jobs are in progress, specifying a longer timeout period will prevent the machine canceling the earlier jobs.</p> <p> Note</p> <p><input type="checkbox"/> Default: 15Sec.</p>
9	I/O Buffer	<p>Allows you to specify the size of the I/O Buffer. Normally it is not necessary to change this setting.</p> <p> Note</p> <p><input type="checkbox"/> Default: 128KB</p>
10	Restore Defaults	<p>Allows you to reset changed settings back to their factory-set default values.</p> <p>Note that the following settings do not change:</p> <ul style="list-style-type: none">• DHCP• IP Address• Subnet Mask• Gateway Address• Ethernet Speed

User Code

In User Code mode, users need to enter a user code before they can use the machine. The machine keeps count of the numbers of masters and prints under each user code.

Note

- To use this feature, User Code mode must be set to "Use". See "3 User Code Management" on p.110 "6 Administrator Tools".
- When the User Code mode is on, the machine will prompt you for your user code when you turn on the main switch, or after the machine has been reset.
- The following user codes are available:
 - 000, 019, 028, 037, 046, 055, 064, 073, 082, 091, 100, 119, 128, 137, 146, 155, 164, 173, 182, 191, 200, 219, 228, 237, 246, 255, 264, 273, 282, 291, 300, 319, 328, 337, 346, 355, 364, 373, 382, 391, 400, 419, 428, 437, 446, 455, 464, 473, 482, 491, 500, 519, 528, 537, 546, 555, 564, 573, 582, 591, 600, 619, 628, 637, 646, 655, 664, 673, 682, 691, 700, 719, 728, 737, 746, 755, 764, 773, 782, 791, 800, 819, 828, 837, 846, 855, 864, 873, 882, 891, 900, 919, 928, 937, 946, 955, 964, 973, 982, 991

Entering the User Code to Use the Machine

- 1** Enter your 3–digit user code with the number keys.

Enter User Code, then
press the OK key.
UserCode: ■■■■

Note

- The user code will not displayed on the panel display.
- If you have made a wrong entry, press the **[Clear/Stop]** key and enter the number again.

- 2** Press the **[OK]** key.

- 3** Make your Prints.

- 4** After printing, press the **[Clear Modes/Energy Saver]** key and the **[Clear/Stop]** key at the same time.

The User Code mode is once again set. Other users will not be able to make prints using your user code.

Clearing the Counter

You can clear each or all of the user code counters.

1 Press the **[User Tools]** key.

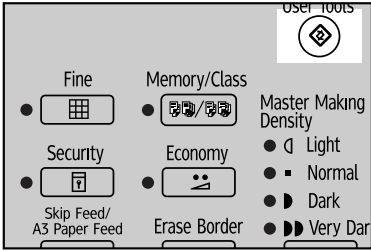

BFU0145

2 Use the **[▲][▼]** keys to select **6 Administrator Tools**, and then press the **[OK]** key.

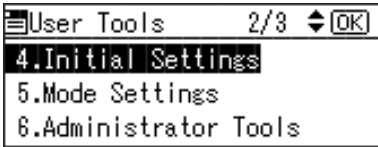

3 Use the **[▲][▼]** keys to select **2 Clear Counter**, and then press the **[OK]** key.

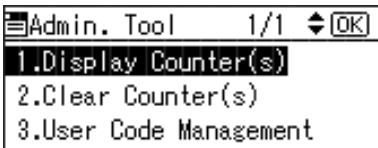

To clear the counter for each user code

1 Use the **[▲][▼]** keys to select **Clear per User**.

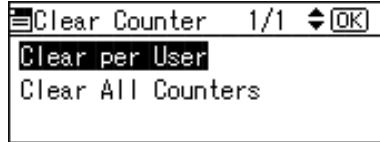

2 Use the **[▲][▼]** keys to select the user code that you wish to clear.

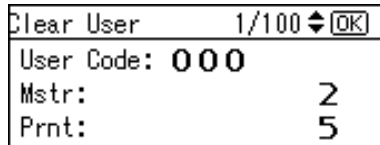

3 Press the **[OK]** key.

Note

- If you have selected the wrong user code, press the **[Cancel]** key to return to the previous display.

4 Press the **[OK]** key.

To clear the counters for all user codes

1 Use the **[▲][▼]** keys to select **Clear All Counters**.

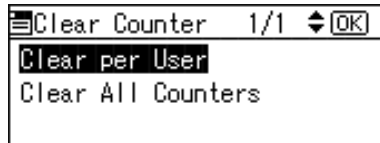

2 Press the **[OK]** key.

Operation Notes

General Cautions

- While printing, do not turn off the main switch.
- While printing, do not open the door or covers.
- While printing, do not unplug the power cord.
- While printing, do not move the machine.
- Keep corrosive liquids, such as acid, off the machine.
- Open and close the door and covers softly.
- Do not put anything except originals on the machine.
- Do not spill liquid on the machine.
- When opening or closing the door or covers, keep hold of them so they don't fall.
- When removing the drum unit from the machine, be careful not to let the drum unit fall.
- Do not modify or replace any parts other than the ones specified in this manual.
- Do not operate the machine without covers. You might get your fingers caught in the machine, or the machine might be damaged because, for example, dust or the like might get inside.
- Since some parts of the machine are sharp and might cause injury, touch only the parts specified in this manual.
- If you clean rubber parts with water, wipe them with a dry cloth afterwards.
- Always turn the machine off when you have finished printing for the day.
- If the machine must be transported by vehicle, please contact your service representative.
- Be sure to make a few trial prints to check the image position because the image position of the trial print might not correspond with that of the original.
- If the image registration is not consistent, slow the printing speed down to Setting 1.
- When performing duplex or multicolored printing, leave the printed paper for a while before the next printing in order to let the ink dry on the printed paper. If this is not done, feed roller marks will appear on the print image.
- If the machine is not used for a long period, the image density might decrease because the ink on the drum might dry. Make extra prints until the image density recovers.
- When the machine is used in low temperature conditions, the image density might decrease. In this case, slow the printing speed down to step 1 or 2.

- When making duplex prints, misdetection of paper wrapping might occur if the paper delivery sensor detects a black area at the leading edge of the back side. Keep at least 5 mm, 0.2" margin at the leading edge of the back side of the printing paper.
- Press the **[Proof]** key to perform a test print as the first few prints might be light.
- When making duplex prints or when using non-white printing paper, the paper end sensor might malfunction and fail to detect the paper. In this case, place a blank sheet under the printing paper on the paper feed tray.
- The outer portion of the image might not be printed under low temperature. In this case, slow the printing speed down to step 1 or 2, or increase the room temperature.
- The paper exit pawl might contact the printing paper and cause black lines on the prints. In this case, increase the printing speed or make a new master with lighter image density mode.
- If you cannot pull out the drum, close the front cover again to rotate the drum. Pull out the drum after it stopped at the correct position.
- The leading edge of the prints might become stained if the edge touches the image of prints on the paper delivery tray.
- The ink of the print on the paper delivery tray might stick to the back side of the next print.
- When the machine is on and the power source is less than 90% of the specified amount, printing quality will decrease. Therefore, make sure the supply from your electrical outlet is at least 90% of the required amount.
- As various kinds and qualities of paper exist, some paper might be wrapped around the drum or cause misfeeds.
- If your hands are stained with ink:
 - Avoid prolonged or repeated contact with skin.
 - Cleanse skin thoroughly after contact, before breaks and meals, and at the end of the work period.
 - Ink is readily removed from skin by waterless hand cleaners followed by washing with soap and water.
- Also, be careful not to get any ink on your clothing while emptying the master eject box or while loading a new ink cartridge.
- The image density varies according to the printing speed and the room temperature. So, adjust the printing speed or increase the room temperature.
- When you make a lot of prints from a small image, ink might ooze out from the edges of the master, especially under high temperature and when printing in two or more colors. In this case, make a new master.
- Use ink made within one year. Ink stored for a long period tends to dry slowly and yield lower image density.
- While making a master, do not leave the exposure glass cover or optional Auto Document Feeder open.

- In Text/Photo mode, moire patterns might occur when screened originals are printed. In this case, make prints in Text or Photo mode.
- When you use originals with light lettering, edges of the letters might be printed clearly and the inside of the letters might be light. In this case, increase the image density.
- When marks on the printing paper occur, clean the paper feed roller. See p.120 "Maintaining the Machine".
- If you make a second print before the ink from the first print dries, the ink may adhere to the paper feed roller and soil the print. Before printing on the reverse side of a printed sheet or overprinting on a printed sheet, be sure that the ink on the first print is adequately dry.

Print Paper

- When the paper is curled, stack the paper with the curl face down, otherwise the paper might wrap around the drum or stains might appear.
- Postcards and the like do not absorb ink well. Offset images might appear on the rear side of subsequent prints. Solid image originals will cause offset image prints.

Originals

- If there is no margin or if there is a solid image area near the leading edge of the original, leave a margin of at least 5 mm, 0.2", at the leading edge; otherwise, the paper might wrap around the drum or the paper exit pawl might become dirty and cause black lines on prints.
- If you use originals that have bold letters or solid images at the leading edges, you might get prints with dirty edges. In this case, insert the widest margin first, or raise the printing speed.
- Under the following conditions, the machine might not detect the original on the exposure glass. If you press the **[Master Making]** mode select key again, the machine will start making a master anyway:
 - When you set a dark original on the exposure glass.
 - When the original is not centered according to the size marks on the right scale.
 - If you do not open the exposure glass cover at an angle of more than 30° with the exposure glass when you replace originals.
 - If the machine is installed under a strong light.

Where to Put Your Machine

Your machine's location should be carefully chosen because environmental conditions greatly affect its performance.

Environmental Conditions

Optimum environmental conditions

⚠ CAUTION:

- *Keep the machine away from humidity and dust. Otherwise a fire or an electric shock might occur.*
- *Do not place the machine on an unstable or tilted surface. If it topples over, an injury might occur.*

⚠ CAUTION:

- *Make sure the room where you are using the machine is well ventilated and spacious. Good ventilation is especially important when the machine is used heavily.*

⚠ CAUTION:

- *After you move the machine, use the caster fixture to fix it in place. Otherwise the machine might move or come down to cause an injury.*

- Temperature: 10 – 30°C, 50 – 86°F
- Humidity:
 - Main Frame: 20 – 90%RH
 - Auto Document Feeder (option): 20 – 70%RH
- A strong and level base (a sturdy desk and cabinet etc.).
- The machine must be level within 5 mm, 0.2" both front to rear and left to right.
- Make sure to locate this machine in a large well ventilated room that has an air turnover of more than 30 m³/hr/person.

Environments to avoid

- Locations exposed to direct sunlight or strong light (more than 1500 lux).
- Locations directly exposed to cool air from an air conditioner or heated air from a heater. (Sudden temperature changes might cause condensation within the machine.)
- Places where the machine might be subjected to frequent strong vibration.
- Dusty areas.
- Areas with corrosive gases.

Power Connection

⚠ **WARNING:**

- **Connect the power cord directly into a wall outlet and never use an extension cord.**
- **Only connect the machine to the power source describe in the manual.**
- **Do not damage, break or make any modifications to the power cord. Do not place heavy objects on it. Do not pull it hard nor bend it more than necessary. These actions could cause an electric shock or fire.**

⚠ **CAUTION:**

- **Unplug the power cord from the wall outlet before you move the machine. While moving the machine, you should take care that the power cord will not be damaged under the machine.**

⚠ **CAUTION:**

- **When you disconnect the power plug from the wall outlet, always pull the plug (not the cable).**

- The socket-outlet shall be installed near the machine and shall be easily accessible.
- Voltage must not fluctuate more than 10%.

6

Access to Machine

Place the machine near the power source, providing clearance as shown.

❖ Main Frame

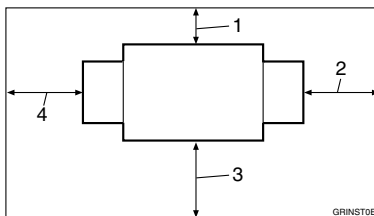

1. More than 10 cm, 4.0"
2. More than 60 cm, 23.7"
3. More than 60 cm, 23.7"
4. More than 60 cm, 23.7"

Maintaining the Machine

To maintain high print quality, clean the following parts and units regularly.

Main Frame

Exposure Glass

1 Lift the exposure glass cover or optional Auto Document Feeder.

2 Clean ① and ②.

 **Note**

- When using the exposure glass, clean ② only.

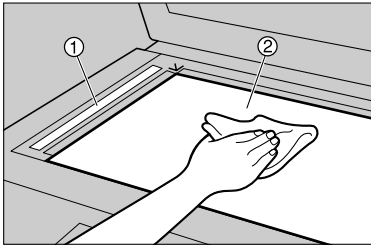

ZDCH130E

Exposure Glass Cover

1 Lift the exposure glass cover.

2 Clean the exposure glass cover with a damp cloth and wipe it with a dry cloth.

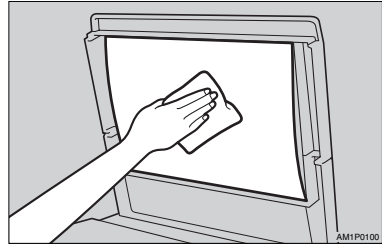

AM1P0100

 **Note**

- If you do not clean the exposure glass cover, marks on the cover will be printed.

Paper Feed Roller (paper feed tray)

1 Wipe off the paper dust on the paper feed roller with a damp cloth, then wipe it with a dry cloth.

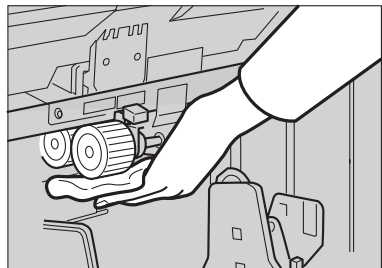

ANT093S

 **Note**

- If you do not clean the paper feed roller, paper misfeeds tend to occur.

Optional Document Feeder

Cleaning the Sheet

- 1** Lift the document feeder.
- 2** Clean the sheet with a damp cloth and wipe it with a dry cloth.

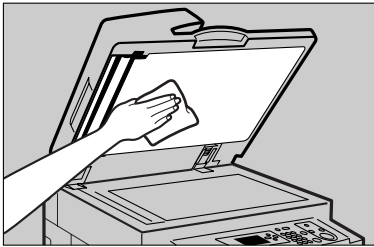

AN10566

 **Note**

- If you do not clean the sheet, marks on the sheet will be printed.

7. Specifications

Main Frame

❖ **Configuration:**

Desktop

❖ **Printing Process:**

Full automatic one drum system

❖ **Original Type:**

Sheet/Book

❖ **Original Size:**

Maximum 297 mm × 432 mm, 11.7" × 17.0"

❖ **Pixel Density:**

300 × 300 dpi (in Fine mode 300 × 400 dpi)

❖ **Image Mode:**

Text mode

Text/Photo mode

Photo mode

Pale mode

Pencil mode

❖ **Reduction Ratios:**

- Inch version:
93%, 77%, 74%, 65%

- Metric version:
93%, 87%, 82%, 71%

❖ **Enlargement Ratios:**

- Inch version:
155%, 129%, 121%

- Metric version:
141%, 122%, 115%

❖ **Printing Area:**

210 mm × 355 mm, 8.3" × 14.0"

❖ **Print Paper Size:**

Maximum 275 mm × 395 mm, 10.9" × 15.6"

Maximum 297 mm × 420 mm, 11.6" × 16.5" (When the A3 Paper Feed function is used)

Minimum 90 mm × 140 mm, 3.5" × 5.5"

❖ **Leading Edge Margin:**

5 mm \pm 3 mm, 0.2" \pm 0.12"

❖ **Print Paper Weight:**

47.1 g/m² to 209.3 g/m², 12.5 lb. to 55.6 lb.

- When the A3 Paper Feed function is used
52.3 g/m² to 157 g/m², 14 lb. to 42 lb.

❖ **Print Speed:**

3 steps

- Setting 1: 80 sheets/minute
- Setting 2: 100 sheets/minute
- Setting 3: 130 sheets/minute

Setting 1 fixed (When the A3 Paper Feed function is used)

❖ **First Copy Time (Master Process Time):**

32.0 seconds (A4☐, 8¹/₂" \times 11"☐)

(When setting an original on the exposure glass)

❖ **Second Copy Time (First Print Time):**

34.0 seconds (A4☐, 8¹/₂" \times 11"☐)

(When setting an original on the exposure glass)

❖ **Color Printing:**

Drum unit replacement system (black, red, blue, green, brown, yellow, purple, navy, maroon, orange and teal)

❖ **Image Position Adjustment:**

- Vertical:

\pm 10 mm, \pm 0.4"

-10 mm, -0.4" fixed (When the A3 Paper Feed function is used)

- Side:

10 mm, 0.4" (for either side)

In A3 paper feed mode, adjust the print position to within \pm 1 mm, \pm 0.04" of the center.

❖ **Paper Feed Tray Capacity:**

1,000 sheets (64 g/m², 17 lb.)

❖ **Paper Delivery Tray Capacity:**

1,000 sheets (64 g/m², 17 lb.)

500 sheets (64 g/m², 17 lb.)(When the A3 Paper Feed function is used)

❖ **Master Eject Box Capacity:**

30 masters

❖ **Dimensions (W × D × H):**

	Width	Depth	Height
Stored	750 mm, 29.5"	681 mm, 26.8"	633 mm, 24.9"
Stored with Auto Document Feeder	750 mm, 29.5"	681 mm, 26.8"	686 mm, 27.0"
Set up	1,244 mm, 49.0"	681 mm, 26.8"	633 mm, 24.9"
Set up with Auto Document Feeder	1,244 mm, 49.0"	681 mm, 26.8"	686 mm, 27.0"

❖ **Weight:**

- Main Frame with Exposure Glass Cover: 70 kg, 154.3 lb.
- Main Frame with optional Auto Document Feeder: 75 kg, 165.3 lb.

❖ **Noise Emission *1:**

Sound Power Level

	Printing Speed	Noise Emission
Ready mode	--	34 dB(A)
During printing	130 cpm	84 dB(A)

Sound Pressure Level*2

	Printing Speed	Noise Emission
Ready mode	--	20 dB(A)
During printing	130 cpm	70 dB(A)

*1 The above measurement made in accordance with ISO 7779 are actual value.

*2 It is measured at the position of the operator.

❖ **Power Source:**

See the inside front cover of this manual.

❖ **Power Consumption:**

Printer Controller	Printer Unit VC-20 *1	Printer Unit Type 4545 *2
Sleep mode	Less than 0.0039 kW	Less than 0.0063 kW
Ready mode	Less than 0.02 kW	Less than 0.023 kW
Master Making	Less than 0.19 kW	Less than 0.19 kW
Printing: Speed 1	Less than 0.135 kW	Less than 0.135 kW
Printing: Speed 2	Less than 0.155 kW	Less than 0.155 kW
Printing: Speed 3	Less than 0.19 kW	Less than 0.19 kW

*1 Non Network Connectable

*2 Network Connectable

❖ **Optional Equipment:**







- Color Drum
 LG Drum
- Key Counter
- Tape Dispenser
- Auto Document Feeder
- Exposure Glass Cover
- Printer Controller
 Printer Unit VC-20
 Printer Unit Type 4545

Auto Document Feeder (ADF)

❖ Mode:

- ADF mode

❖ Original size:

- A3  – A5  
- 11" × 17"  – 5¹/₂" × 8¹/₂"  

❖ Original weight:

- One-sided originals: 52 – 105 g/m² (14 – 28 lb.)

❖ Number of originals to be set:

- 30 sheets (80 g/m², 20 lb.)

❖ Maximum power consumption:

- Less than 25 W (power is supplied from the main unit.)

❖ Dimensions (W × D × H):

- 550 × 470 × 90 mm, 21.7" × 18.6" × 3.6"

❖ Weight:

- 7 kg (15 lb.) or less

 Note

- Specifications are subject to change without notice.

Consumables

Name	Size	Remarks
Master for LG drum	Length: 125 m, 410ft/roll Width: 240 mm, 9.5" 2 Rolls/case	260 masters can be made per roll
Ink-Black	600ml/pack, 5 packs/case	Environmental conditions: - 5 to 40°C, 10 to 95%RH
Ink-Red	600ml/pack, 5 packs/case	
Ink-Blue	600ml/pack, 5 packs/case	
Ink-Green	600ml/pack, 5 packs/case	
Ink-Brown	600ml/pack, 5 packs/case	
Ink-Yellow	600ml/pack, 5 packs/case	
Ink-Purple	600ml/pack, 5 packs/case	
Ink-Navy	600ml/pack, 5 packs/case	
Ink-Maroon	600ml/pack, 5 packs/case	
Ink-Orange	600ml/pack, 5 packs/case	
Ink-Teal	600ml/pack, 5 packs/case	
Tape for Tape dispenser	35 m (114.8 ft)/roll	

7

 **Note**

Specifications are subject to change without notice.

INDEX

A

- A3 Paper Feed, 60
- Access to Machine, 119
- ADF, 11
- Administrator Tools, 110
- Auto Class, 109
- Auto Cycle, 109
- [Auto Cycle]** key, 13
- Auto Delete Margin Shadow, 44
- Auto Document Feeder, 9, 11
 - misfeed*, 80
- Auto Document feeder (ADF), 127
- Auto Reset, 32, 106

B

- Background Correction, 109
- Basic procedure, 30
- Blank Prints, 101

C

- [Cancel]** key, 12
- Changing the Color Drum Unit, 65
- Changing the Paper Size, 72
- Changing the Printing Speed, 40
- Class Display, 107
- Class Mode, 47
- Class/Year, 54
- Class/Year Mode, 46
- Clear Counter(s), 110
- Clearing the Counter, 114
- [Clear Modes/Energy Saver]** key, 13
- [Clear/Stop]** key, 13
- Combination chart, 68
- Combine, 56
- [Combine/Repeat]** key, 13
- Combine/Repeat Priority, 109
- Consumables, 128
- Control panel, 9, 12
- Counter, 12, 106

D

- Data In indicator (Green), 13
- DHCP (Auto-Obtain), 111
- Display Counter, 106
- Display Counter(s), 110
- Display Resettable Counter, 106
- document feeder
 - cleaning*, 121

- Drum unit, 10
- Drum unit lock lever, 10

E

- [Economy]** key, 12
- Economy Mode, 45, 108
- Energy Saver mode, 32
- Energy Saver Timer, 107
- Enlarging, 42
- Enter key, 13
- Environments to avoid, 118
- Erase Border, 44
- [Erase Border]** key, 12
- Erase Border Width, 108
- Error indicator (Red), 13
- Ethernet Speed, 111
- Exposure glass, 10
- exposure glass
 - cleaning*, 120
- Exposure glass cover, 9
- exposure glass cover
 - cleaning*, 120

F

- Feed roller pressure lever, 9
- [Fine]** key, 13
- Fine Mode, 42
- Folding the Paper Feed Tray and Delivery Tray, 26
- Front cover, 9
- [Full Size]** key, 13

G

- Gateway Address, 111
- Guide to Components, 9

H

- Hold Data-in, 62, 111
- [Hold Data-in]** key, 13

I

- Image Position, 37
- [Image Position]** key, 13
- Incomplete Prints, 101
- Indicators, 12
- Initial Settings, 108
- Ink
 - Add ink indicator* (🖨️), 73

Ink holder, 10
I/O Buffer, 112
I/O Timeout, 112
IP Address, 111

J

[Job Reset] key, 13

K

Key Counter Adjust, 110

L

Language on LCD, 106
LCD Contrast, 107
List/Test Print, 111
Loading Paper, 23
Loading Paper into the Paper Feed Tray, 71
location indicator, 80
Longer Paper, 109

M

Main Frame, 123
main frame
 cleaning, 120
Main switch, 10
Maintaining the Machine, 120
Make Color Prints, 65
Making Color Prints, 66
master
 Master eject indicator (⏏), 96
Master eject box, 10, 96
Master eject unit, 10
Master end indicator (⏏)
 When the Master End Indicator (⏏)
 Lights and a Message is Displayed, 95
Master Making Density, 41, 108
[Master Making Density] key, 12
[Master Making] mode select key, 13
Master misfeeds
 in the master eject section, 91
 in the master feed section, 88
Master Roll Replacement, 77
Master tray, 9
Maximum Print Quantity, 107
Memory/Class, 45
 Class Mode, 45, 47
 Class/Year, 54
 Class/Year Mode, 46
 Memory Mode, 46, 48
 Recall Program, 46, 50
[Memory/Class] key, 12
Memory Mode, 48

Minimum Print Quantity, 107
Misfeed, 80
misfeed
 location indicators, 80
mm/inch, 106
Mode Settings, 109

N

Normal Memory Mode, 48
Number keys, 13

O

[OK] key, 12
Online Printing, 62
Online Settings, 111
Open Cover/Unit indicator (⏏*), 94
Open Cover/Unit indicator (⏏*)
 Auto Document Feeder Cover is Open, 94
 Front Cover is Open, 94
 Master Eject Unit is Open, 94
Operation Notes, 115
Optimum environmental conditions, 118
Options, 11
Original misfeeds, 80
Originals, 17
Original Type, 36, 108
[Original Type] key, 13

P

Pale
 Original Type, 36
Panel Beeper, 107
Panel Display, 12, 14
Panel Display Layout, 15
Paper delivery end plate, 10
Paper delivery side plates, 10
Paper delivery tray, 10
paper feed roller
 cleaning, 120
Paper feed side plate lock lever, 9
Paper feed side plates, 9
Paper feed tray, 9
 Misfeed, 83
Paper feed tray down key, 9
Paper misfeeds
 in the paper feed section, 83, 89
Paper misfeeds in the paper exit section, 85
Paper wrapped around the drum, 83
Pencil
 Original Type, 36
Photo
 Original Type, 36

Placing
 originals, 28
 originals in auto document feeder, 28
 originals on exposure glass, 28
Placing a New Roll of Tape in the Tape Dispenser, 79
Placing Originals, 28
Poor Printing, 98
 Dirt on the Back Side of Paper, 98
 Dirt on the Front Side of Paper, 100
Power connection, 119
Preset Reduce/Enlarge, 42
Printer controller, 62
Printing Functions, 41
Printing in Two Colors, 67
Printing Problems, 70
 When Using Combine Mode, 70
Printing Size, 22
Print mode select key, 13
Print paper, 19
Processing indicators, 13
Prog.Change
 Class/Year, 108
Program, 63
 Recalling, 64
 Registering Print Settings, 63
Program/Change Class, 108
Program/Change Memory, 108
 [Program] key, 12
 [Proof] key, 13

R

Ratio, 108
Recall Program, 46, 50
Recommended Sizes and Weights of Originals, 17
 [Reduce/Enlarge] key, 13
Reducing, 42
Repeat, 59
Replenishing Paper, 71
Reset Resettable Counter, 106
Restore Defaults, 112

S

Safety Information, 5
 [Security] key, 13
Security Mode, 61
Separation pressure lever, 9
Set Operation Mode, 107
Setting Up the Paper Delivery Tray, 24
Shifting the Image Position Forward or Backward, 37

Shifting the Image Position to the Right or Left, 38
Side tray fine adjusting dial, 9
Skip Feed, 60
Skip feed/A3 Paper Feed, 60
 [Skip Feed/A3 Paper Feed] key, 13
 [Speed] key, 13
Stack Memory Mode, 49
 [Start] key, 13
Subnet Mask, 111
System, 106

T

tape dispenser, 79
Text
 Original Type, 36
Text/Photo
 Original Type, 36
Troubleshooting, 69

U

user code, 110, 113
User Code Management, 110
user tools
 Accessing the User Tools, 105
 Quitting User Tools, 105
 User Tools Menu, 106
 [User Tools] key, 12
User Tools Protect, 110
User Tools Protect PW, 110

W

Where to Put Your Machine, 118

MEMO

Note to users in the United States of America

Note:

This equipment has been tested and found to comply with the limits for a Class B digital device, pursuant to Part 15 of the FCC Rules. These limits are designed to provide reasonable protection against harmful interference in a residential installation. This equipment generates, uses and can radiate radio frequency energy and, if not installed and used in accordance with the instructions, may cause harmful interference to radio communications. However, there is no guarantee that interference will not occur in a particular installation. If this equipment does cause harmful interference to radio or television reception, which can be determined by turning the equipment off and on, the user is encouraged to try to correct the interference by one more of the following measures:

Reorient or relocate the receiving antenna.

Increase the separation between the equipment and receiver.

Connect the equipment into an outlet on a circuit different from that to which the receiver is connected.

Consult the dealer or an experienced radio /TV technician for help.

Caution:

Changes or modifications not expressly approved by the party responsible for compliance could void the user's authority to operate the equipment.

Note to users in Canada

Note:

This Class B digital apparatus complies with Canadian ICES-003.

Remarque concernant les utilisateurs au Canada

Avertissement:

Cet appareil numérique de la classe B est conforme à la norme NMB-003 du Canada.

In accordance with IEC 60417, this machine uses the following symbols for the main switch:

I means **POWER ON**.

O means **POWER OFF**.

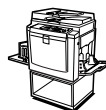
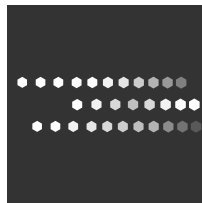

Type for DX 3343/LDD130/3183DNP

Printed in China

EN (USA) C275-8608



C2758608