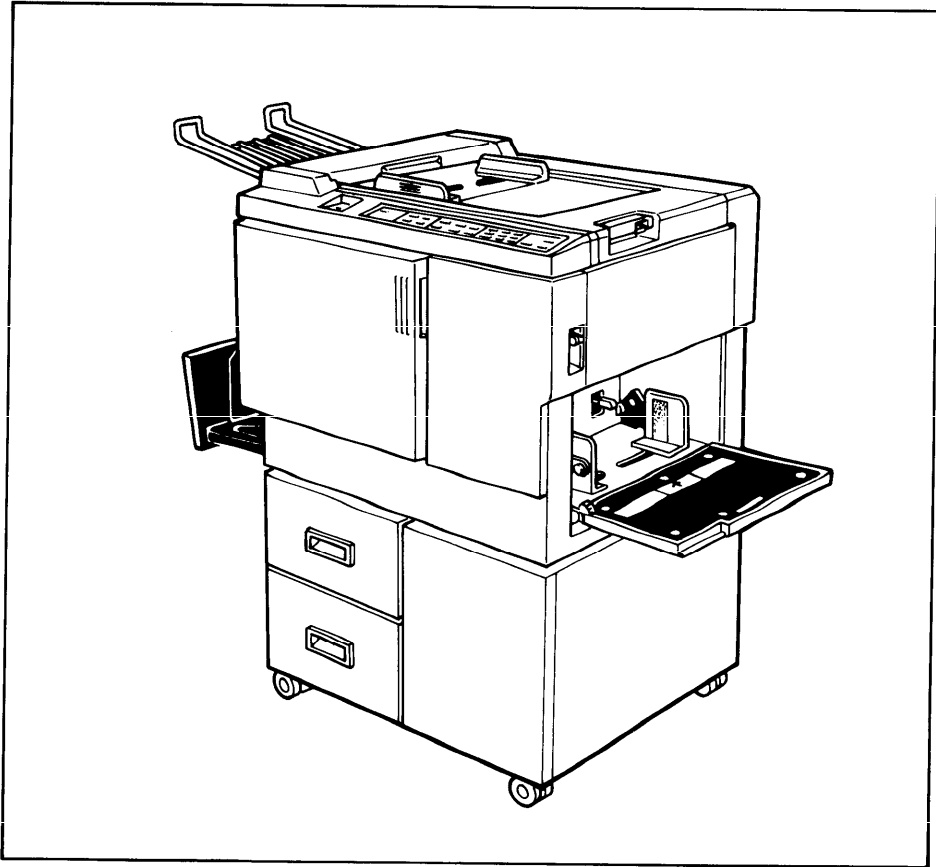


RICOH

PRIPORT VT2130

OPERATING INSTRUCTIONS



RICOH COMPANY, LTD.

Note to users in the United States of America

This equipment has been tested and found to comply with the limits for a Class A digital device, pursuant to Part 15 of the FCC Rules. These limits are designed to provide reasonable protection against harmful interference when the equipment is operated in a commercial environment. This equipment generates, uses, and can radiate radio frequency energy and, if not installed and used in accordance with the instruction manual, may cause harmful interference to radio communications. Operation of this equipment in a residential area is likely to cause harmful interference in which case the user will be required to correct the interference at his own expense.

Note to users in Canada

This digital Apparatus does not exceed the Class A limits for Radio Frequency noise from Digital Apparatus set out in the Radio Interference Regulations of the Canadian Department of Communications.

Remarque concernant les utilisateurs au Canada

Le présent appareil numérique n'émet pas de bruits radioélectriques dépassant les limites applicables aux appareils numériques de la classe A prescrites dans le Règlement sur le brouillage radioélectrique édicté par le ministère des Communications du Canada.

INTRODUCTION

The Ricoh Priport VT2130 is a stencil duplicator which is carefully manufactured to exacting standards of high performance.

This manual contains detailed instructions on the operation and care of the Priport VT2130. To get the maximum versatility from this machine, all operators should read and follow the instructions in this manual. Please keep this manual in a handy place near the machine.

FEATURES

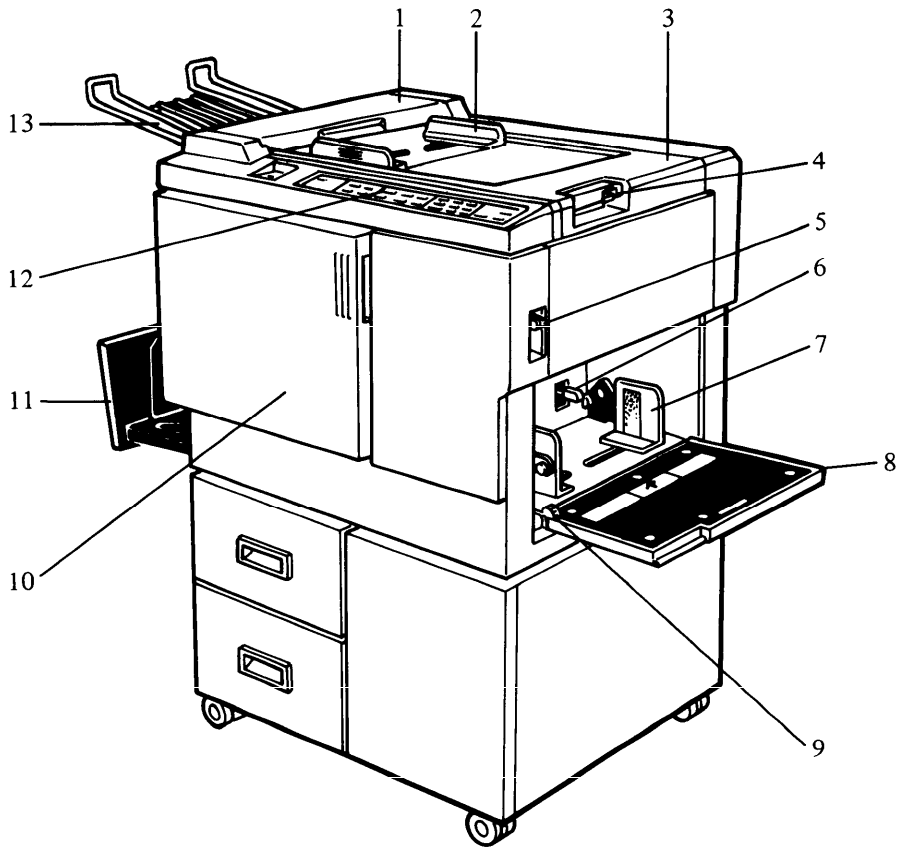
1. **Wide range of reproduction ratios:**
4 fixed reproduction ratios (100% plus 3 reduction ratios).
2. 2 single originals can be printed on one sheet of paper.
3. 5 mono color printing with optional drum units.

TABLE OF CONTENTS

GUIDE TO COMPONENTS	
1. Machine Exterior	2
2. Machine Interior	4
3. Operation Panel	6
INSTALLATION REQUIREMENTS	
1. Machine Environment	8
2. Access to Machine	9
3. Power Connection	9
DO'S AND DON'TS	10
ORIGINALS	11
PRINTING PAPER	13
OPERATION	
1. Preparation for Printing	14
2. Setting the Originals	16
3. Printing	17
4. Restoring Paper Feed and Paper Delivery Tables.....	18
5. Adjusting the Image Position ...	19
6. Changing the Paper Size.....	21
7. Printing on Thick or Thin Paper	22
8. Printing on Postcard Size Paper	23
9. Various Originals	24
10. Changing the Printing Speed ...	25
11. To Stop the Machine During a Printing Run.....	26
12. Changing the Drum Unit for Color Printing.....	27
13. Printing in Two Colors.....	29
SPECIAL FUNCTIONS	
1. Group Printing from the Same Original	30
2. Combine 2 Originals.....	32
3. Various Run Lengths Using the Same Master.....	34
4. Photo Mode Printing.....	35
REPLENISHING SUPPLIES	
1. Loading Paper.....	36
2. Supplying Ink	37
3. Master Roll Replacement.....	38
MAINTENANCE	
1. Thermal Head Cleaning	40
2. Platen Cover/Exposure Glass ..	41
TROUBLESHOOTING	
1. Indicators	42
2. When the Misfeed (S _V) Indicator Lights	43
3. When the Supply/Exchange (L _J) Indicator Lights	49
4. Other Indicators Light.....	51
5. Poor Printing	52
MISCELLANEOUS	54
1. Operating Cautions.....	54
SPECIFICATION	56

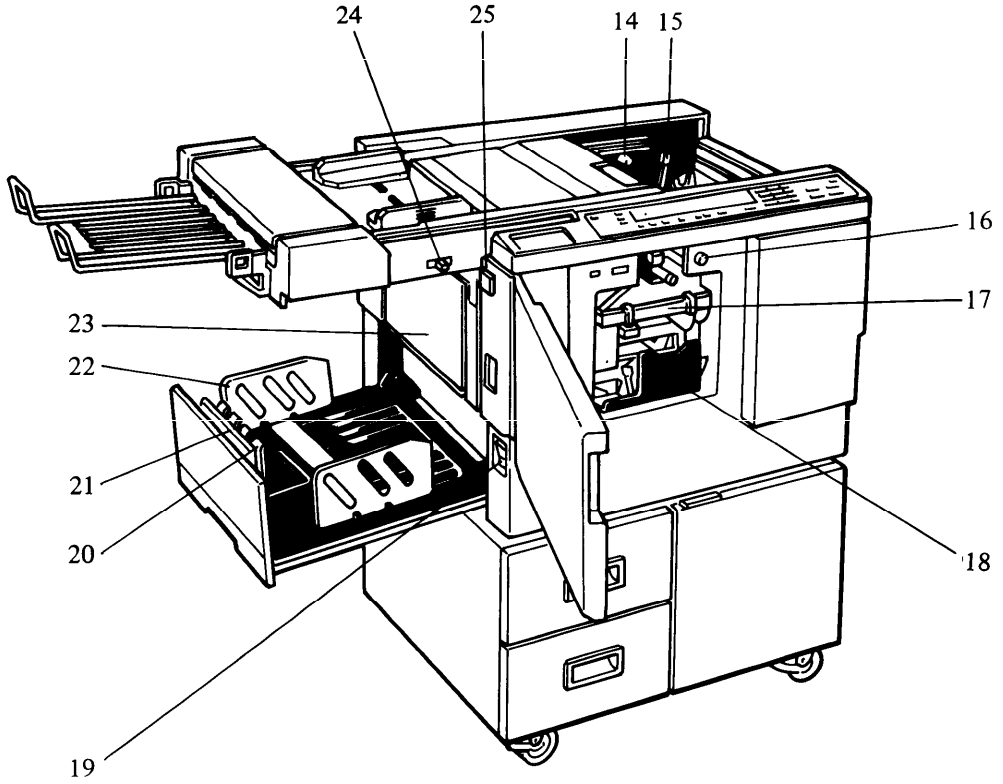
GUIDE TO COMPONENTS

1. Machine Exterior



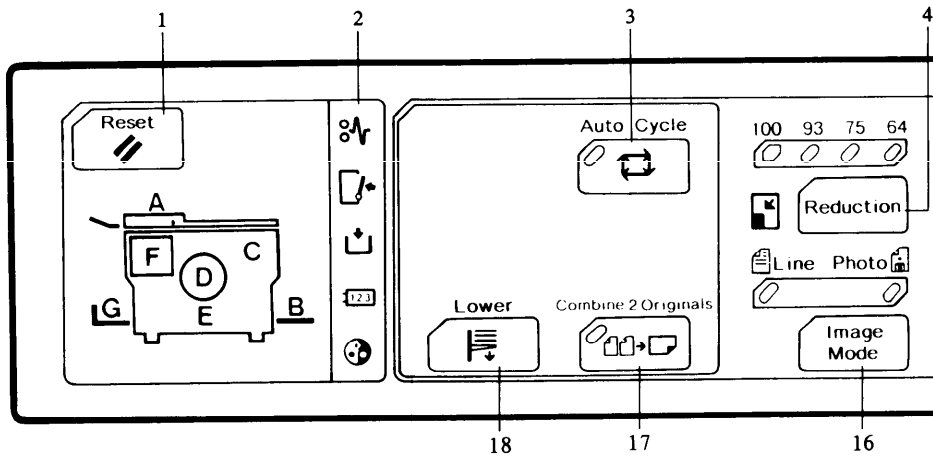
- | | |
|--|---|
| 1. Top Unit | Open to remove the misfed original. |
| 2. Original Guides | Adjust these guides to position the originals correctly. |
| 3. Original Table | Place the originals on this table. |
| 4. Original Table Release Lever | Use to open the original table unit to the left for master installation. |
| 5. Feed Roller Pressure Lever | Use to adjust the contact pressure of the paper feed roller according to paper thickness. |
| 6. Separation Roller Pressure Lever | Use to adjust the separation roller pressure to prevent double feed. |
| 7. Paper Feed Side Plate | Use to prevent paper skew. |
| 8. Paper Feed Table | Set the paper on this table. |
| 9. Side Plate Fine Adjusting Dial | Use to shift the paper feed table sideways. |
| 10. Front Door | Open for access to the inside of the machine. |
| 11. Paper Delivery Table | Completed prints are delivered here. |
| 12. Operation Panel | Operator controls and indicators are located here. |
| 13. Original Tray | Originals used to make a master are delivered to this tray. |

2. Machine Interior

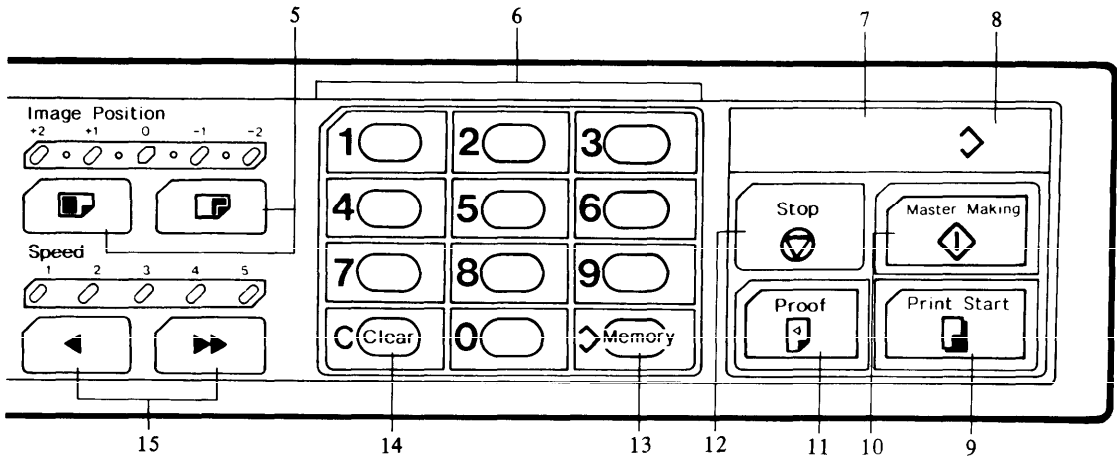


- | | |
|--|--|
| 14. Master Cut Button | Press this button to cut the master paper leading edge after installing a new master roll. |
| 15. Pressure Release Lever | Use to install the master roll, or to clean the thermal head. |
| 16. Drum Rotation Button | Press to replace the drum or to remove misfed paper. |
| 17. Drum Unit | The master paper is wrapped around this unit. |
| 18. Ink Holder | Set the ink cartridge in this holder. |
| 19. Main Switch | Use to turn the power on or off. |
| 20. Small Size Paper Delivery End Plate (for smaller than 8 1/2" x 11") | Use to align the leading edge of small-sized (less than 8 1/2" x 11") prints. |
| 21. Paper Delivery End Plate (for larger than 8 1/2" x 11") | Use to align the leading edge of prints larger than 8 1/2" x 11". |
| 22. Paper Delivery Side Plate | Use to align the prints on the paper delivery table. |
| 23. Master Eject Container Cover | Open when removing the master eject box. |
| 24. Printing Density Select Switch | Use to select the printing density according to the type and quality of the original. |
| 25. Master Eject Unit Open Button | Press to remove misfed paper or a misfed master. |

3. Operation Panel



- | | |
|-------------------------------|---|
| 1. Reset Key | Press to reset error indicators. |
| 2. Indicators | Light or blink when a non-standard condition occurs within the machine. (See page 42.) |
| 3. Auto Cycle Key | Use to automatically process masters and make prints. |
| 4. Reduction Key | Press to reduce the image. |
| 5. Image Position Keys | Press to shift the image forwards or backwards on the print paper. |
| 6. Number Keys | Press to enter the number of prints. |
| 7. Counter | Displays the number of prints entered. While printing, it shows the number of uncompleted prints. |
| 8. Memory Display | Displays the number of the memory location that will be used to store the number of copies. The print number for up to 10 jobs can be stored at once. |
| 9. Print Start Key | Press to start printing. |
| 10. Master Making Key | Press to make a master. |
| 11. Proof Key | Press to make trial prints or extra prints. |



12. Stop Key

Press to stop the machine operation. The machine will continue operation when the Print Start key or Master Making key is pressed.

13. Memory Key

Use to select memory location number. (1 - 10)

14. Clear Key

Press to change the number set in the counter. This key can be used only after the machine stops operation.

15. Speed Keys

Press to adjust the rotation speed of the machine according to the type of image and printing paper.

16. Image Mode Key

Press to select line mode or photo mode according to the type and quality of the original.

17. Combine 2 Originals Key

Press to combine two originals onto one print image.

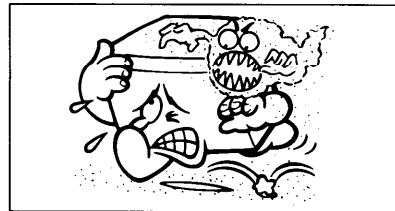
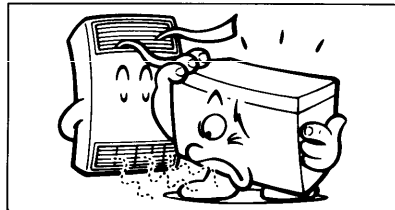
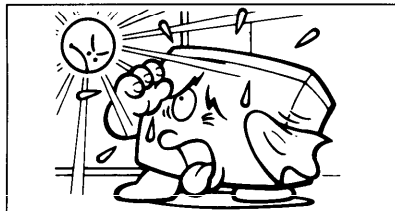
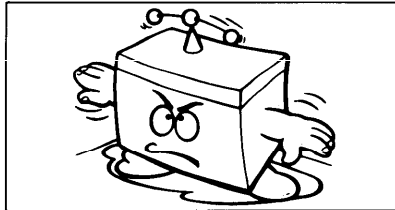
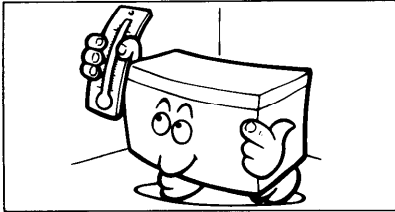
18. Lower Paper Feed Table Key

Press to lower the paper feed table.

INSTALLATION REQUIREMENTS

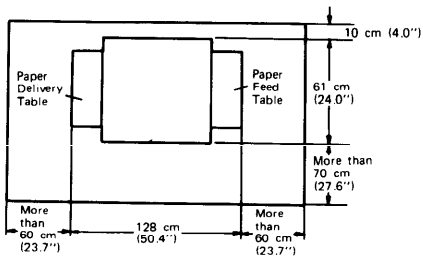
1. Machine Environment

The installation location should be carefully chosen because environmental conditions greatly affect the performance of a machine.



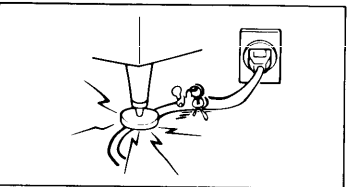
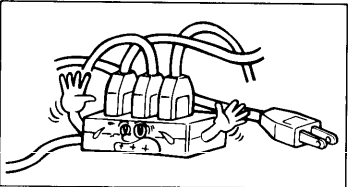
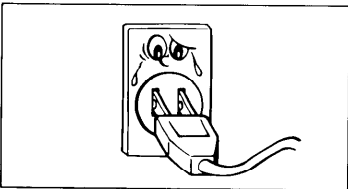
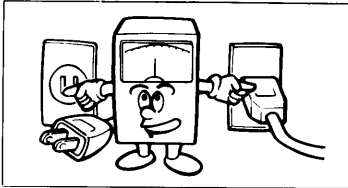
- Optimum environmental conditions -
 - Temperature: 10 – 30°C (50 - 86°F)
 - Humidity: 20 – 90% RH
 - Ventilation: Well-ventilated and wide room.
 - On a strong and level base (a sturdy desk, etc.).
 - The machine must be level within 5 mm (13/64") both front to rear and left to right.
- Environments to avoid -
 - Direct sunlight or strong light
 - Locations directly exposed to the cool air from an air conditioner or reflected heat from a space heater. (Sudden temperature changes low to high or vice versa may cause condensation within the machine.)
 - Dusty areas.

2. Access to Machine



Place the machine near a power source, providing clearance as shown to the left.

3. Power Connection



- Connect the power cord to a power source as follows.

120V, 50/60Hz

more than 5.5 A

- Make sure the plug is firmly inserted in the outlet.
- Avoid multiwiring.
- Do not pinch the power cord.

DO'S AND DON'TS

- Operating Cautions -

1. While Printing :
 - Do not turn off the main switch.
 - Do not unplug the power cord.
 - Do not open the front cover.
 - Do not move the machine.
2. Keep corrosive liquids, such as acid, off the machine.
3. Do not allow paper clips, staples, or other small objects to fall inside the machine.
4. Always turn the machine off when you have finished printing for the day.
5. Do not touch print paper if your fingers are wet or oily; fingerprints may appear on prints.

- General Cautions -

1. Do not modify or replace any parts other than the ones specified in this manual.
2. When the machine will not be used for long periods, disconnect the power cord.
3. If the machine must be transported by vehicle, please contact your dealer.
4. Do not operate the machine with any covers off.

ORIGINALS

You can use the following type of originals.

- Size-

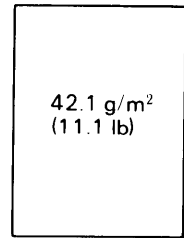
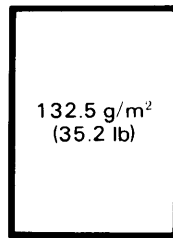
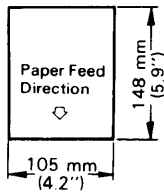
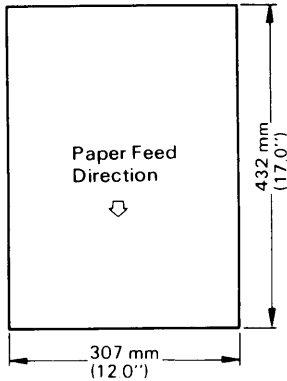
- Thickness -

Max

Min

Max

Min



Cautions for original feeding.

To prevent an original misfeed or a machine malfunction, note the following cautions.

- Remove paper clips or staples from the originals.
- Correct curl or bend of originals before printing.
- Make a copy and use the copy as an original for the following types of originals.

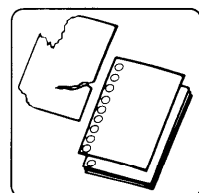
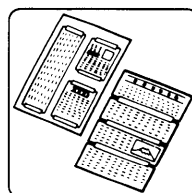
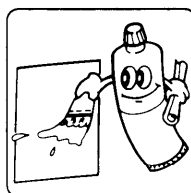
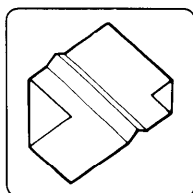
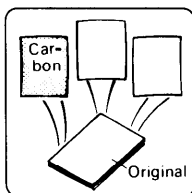
Carbon coating

Bent or Damaged

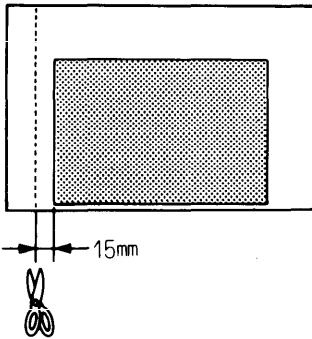
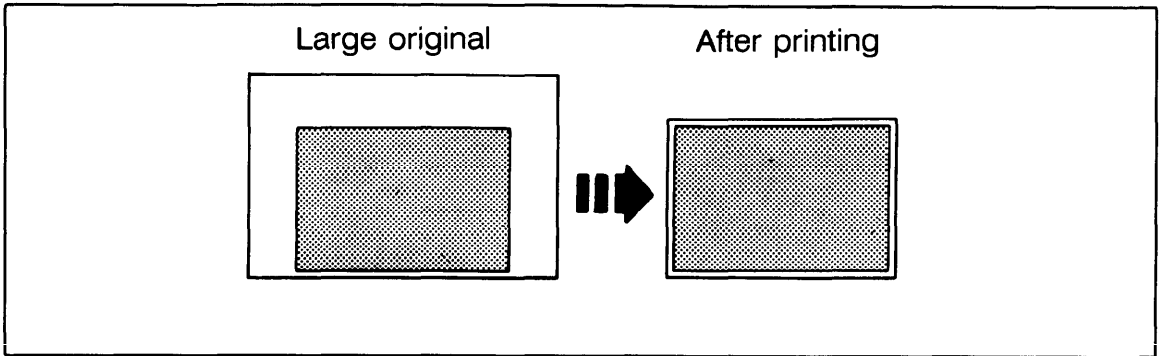
With glue

Paste-up

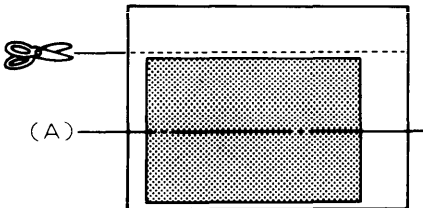
Originals with binding holes



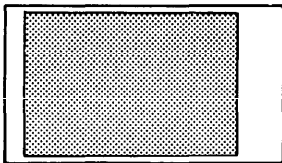
How to make an original when printing a part of a large original



1. Make sure the leading edge margin is at least 15 mm (9/16"). Cut off excess paper if necessary.



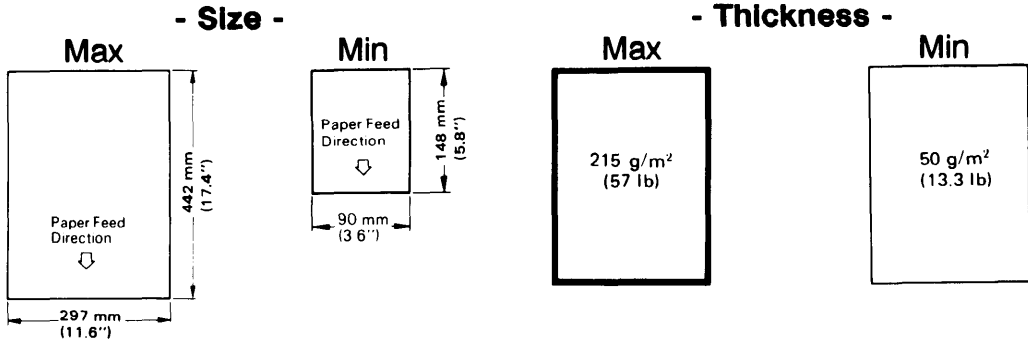
2. Cut the upper edge of the original to make the center line A of the image centered.



3. Suitable original is completed.

PRINTING PAPER

You can use the following types of paper as printing paper:



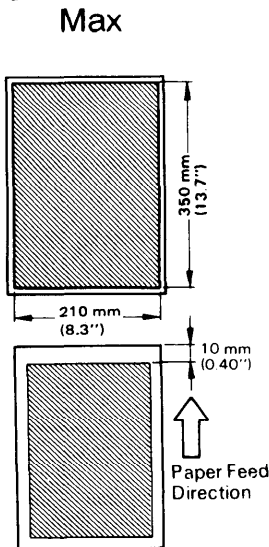
Avoid using the following kinds of paper:

- Roughly-cut paper
- Paper of different thicknesses in the same stack
- Buckled or curled paper
- Short grained paper
- Low stiffness paper

Cautions for postcards printing

- As postcards do not absorb ink well, offset images may appear on the rear side of following prints. To avoid this, place a sheet of paper on top of each printed postcard.

Print Size

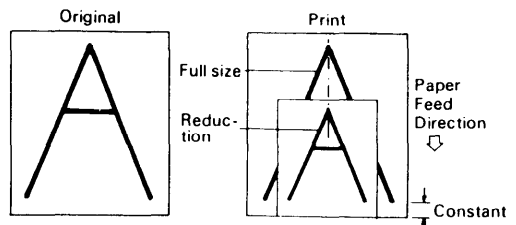


11" x 17" size can be fed as an original or printing paper, but the maximum printing size is 210 x 350 mm (8.3" x 13.7"). Set 64% reduction to print the entire image of 11" x 17" original.

Note:

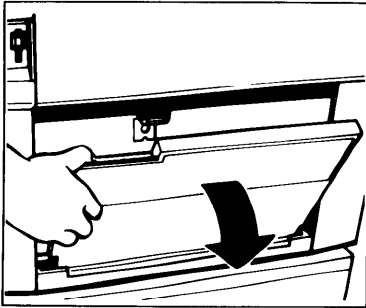
The first 10 mm (7/16") after the leading edge cannot be printed. Make sure the leading edge margin is more than 10 mm (7/16").

The position of center and the leading edge of the image do not change in any reduction mode.

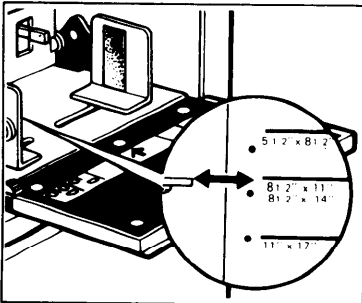


OPERATION

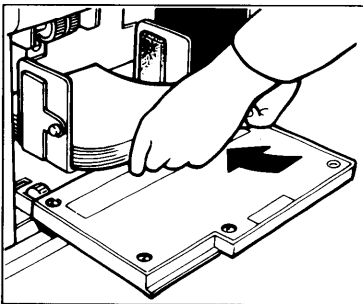
1. Preparation for Printing



1. Open the paper feed table carefully.

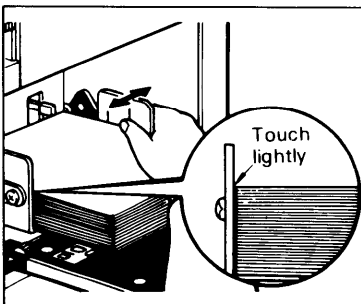
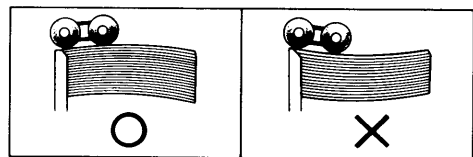


2. Adjust the paper feed side plates to match the paper size.

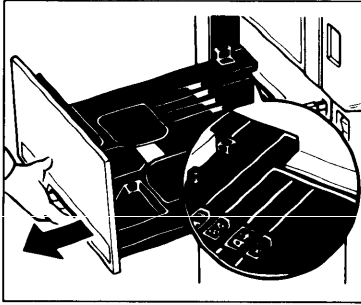


3. Place the paper on the paper feed table.

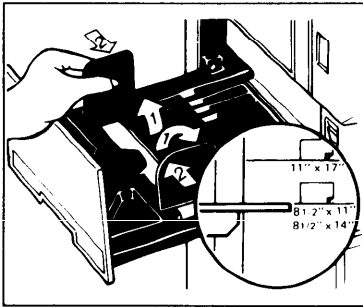
- Correct the paper curl before setting the paper.



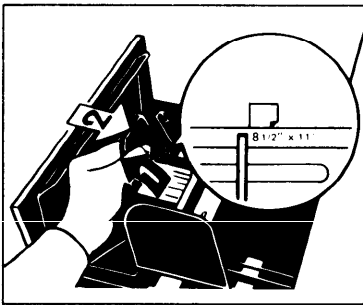
4. Make sure that the paper feed side plates contact the paper lightly.



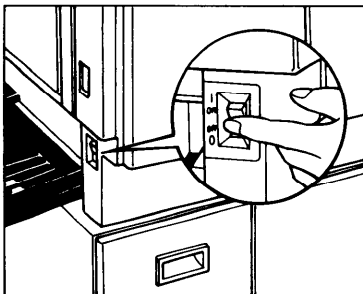
5. Open the paper delivery table.
 - Set the paper delivery table for the paper size, using the size scale on the table.



6. Lift the paper delivery side plates and adjust them to the paper size.

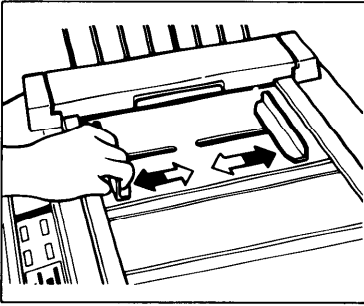


7. If you want to use paper smaller than 8 1/2" x 11", lift the small size paper delivery end plate.
 - When you use 11" x 17" and 8 1/2" x 14" size paper, you do not need to lift the end plate.

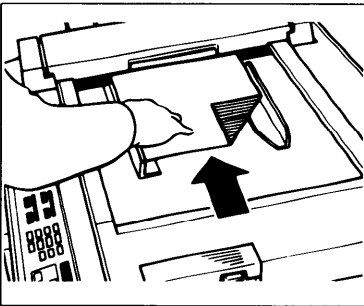


8. Turn on the main switch.

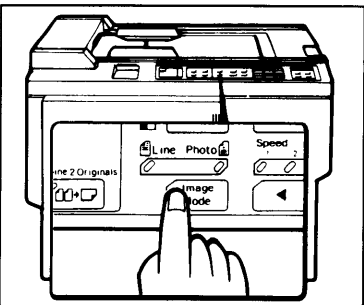
2. Setting the Originals



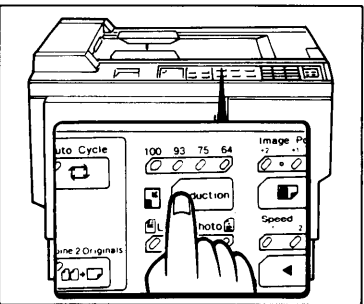
1. Adjust the original guides to the size of the original.



2. Insert the original face down on the original table until it stops.
 - Only one original can be set at a time.

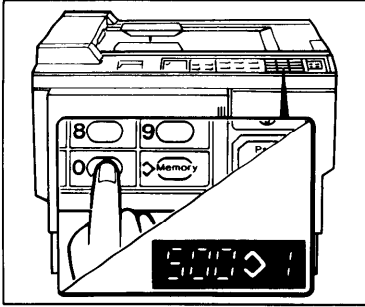


3. Select the image mode using the **Image Mode** keys.
 - Use the line mode when the original is printed matter.
 - Use the photo mode when the original contains photos or colored images.
 - The line mode is automatically selected when the main switch is turned on.



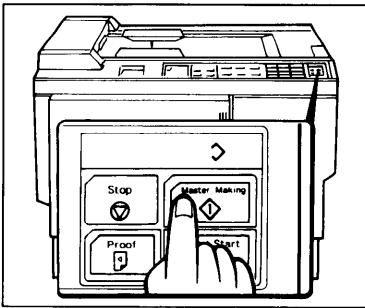
4. If reduced prints are desired, set the reproduction ratio using the **Reduction** key.
 - The reduction ratio will change as follows:
93% → 75% → 64%
 - 11" x 17" original cannot be printed in 100% mode. Select 64%.
 - 100% mode is automatically selected when the main switch is turned on.

3. Printing



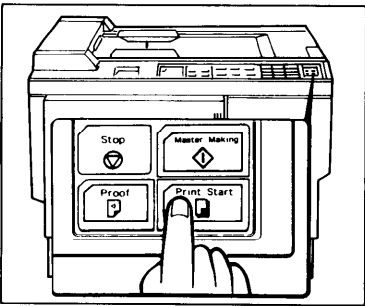
1. Enter the number of prints required using the **Number** keys.

- Up to 9999 prints can be entered at one time.
- To change the number entered, press the **Clear** key and then enter the new number.



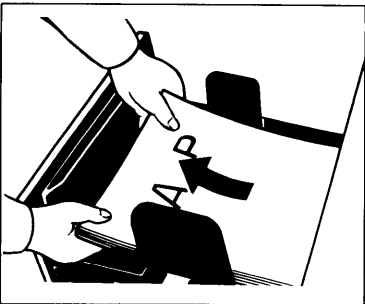
2. Press the **Master Making** key.

- The original is fed, and the trial print is delivered to the paper delivery table. Check the image position. (See page 19 to 20.)



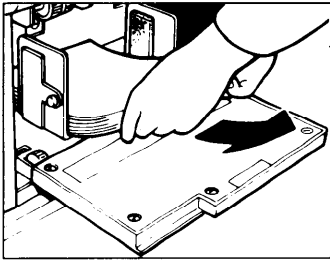
3. Press the **Print Start** key.

- The number of prints set in the counter are made and the machine stops.
- The same number of prints are input automatically after printing is completed.
- If the next original has been set in the original table before the machine stops, that original is fed automatically and a trial print is delivered to the paper delivery tray. Check the image position. (See page 19 to 20.)

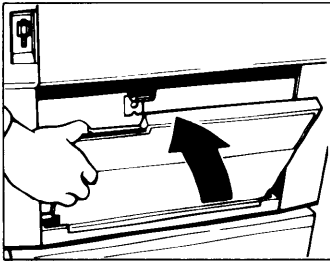


4. Remove the prints from the paper delivery table.

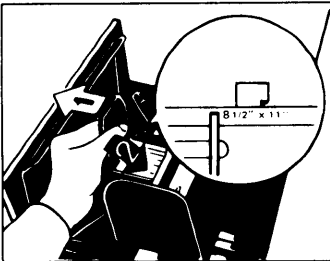
4. Restoring Paper Feed and Paper Delivery Tables



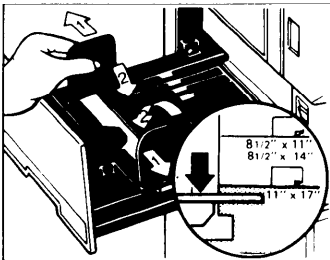
1. Remove the paper from the paper feed table.
 - The paper feed table will lower automatically.



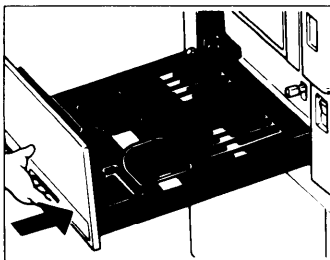
2. Return the paper feed table to its original position.



3. Return the small size paper delivery end plate to its original position



4. Return the paper delivery side plates to their original position.
 - Make sure that the paper delivery side plates do not touch the small size paper delivery end plate.

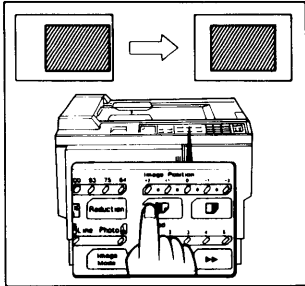


5. Slide in the paper delivery table.
6. Turn off the main switch.

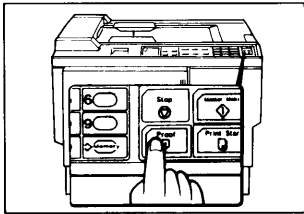
5. Adjusting the Image Position

If the image position is not correct, adjust before you start printing.

- Shifting the image position forward

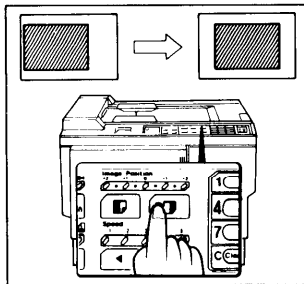


1. Press the left **Image Position** key.
 - When you shift the image forwards, leave a margin (more than 10 mm/0.40") at the leading edge.

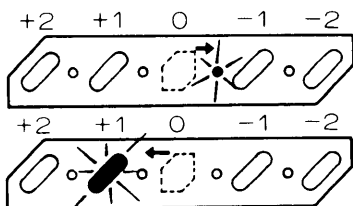
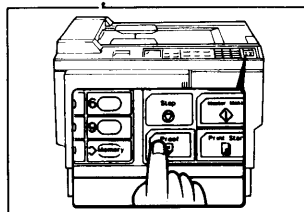


2. Press the **Proof** key. Check the image position again.

- Shifting the image position backward



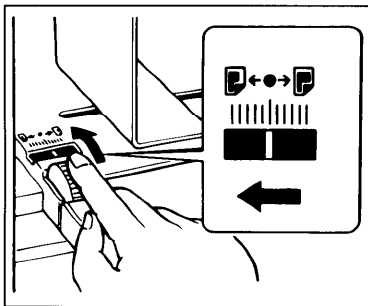
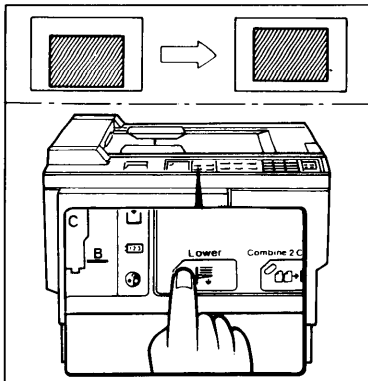
1. Press the right **Image Position** key.
2. Press the **Proof** key. Check the image position again.



Note:

- The left and right **Image Position** keys shift the image about 1mm/0.04" each time they are pressed.
- When the indicator changes from 0 to +1 (-1), the image position shifts about 10mm/0.40" (-10mm/-0.40").

- Shifting the image to the right



1. Press the **Lower Paper Feed Table** key.

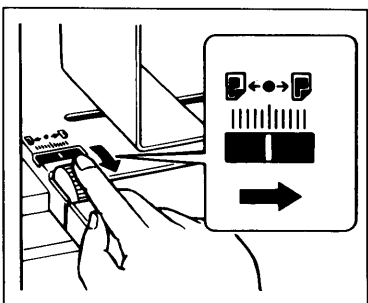
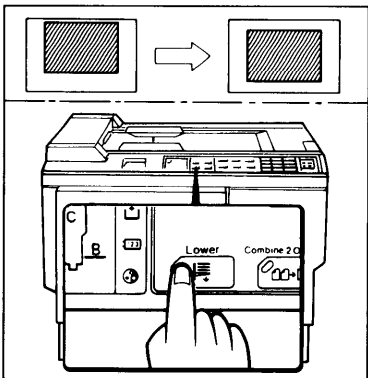
2. Turn the side plate fine adjusting dial as shown in the illustration.

- You can shift the image position up to 10 mm from the center. Each division on the scale is 2 mm.

3. Press the **Proof** key. Check the image position again.

- If the image position is not set correctly, do steps 1 - 3 again.

- Shifting the image to the left



1. Press the **Lower Paper Feed Table** key.

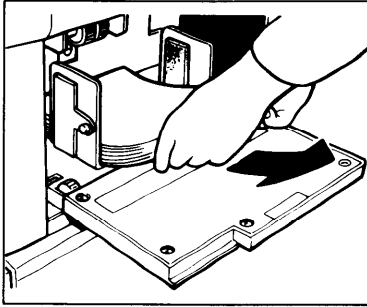
2. Turn the side plate fine adjusting dial as shown in the illustration.

- You can shift the image position up to 10 mm from the center. Each division on the scale is 2 mm.

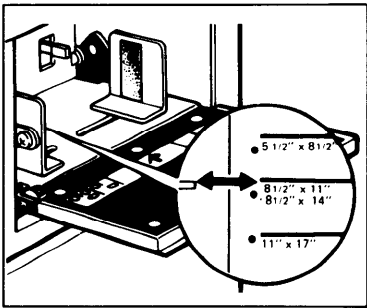
3. Press the **Proof** key. Check the image position again.

- If the image position is not set correctly, do steps 1 - 3 again.

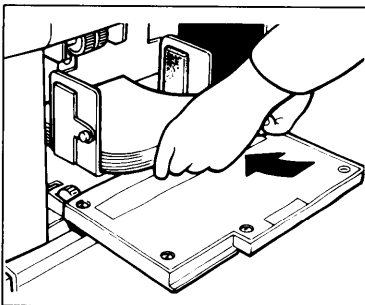
6. Changing the Paper Size



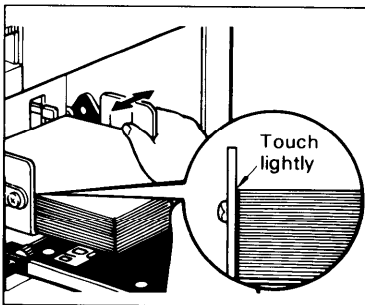
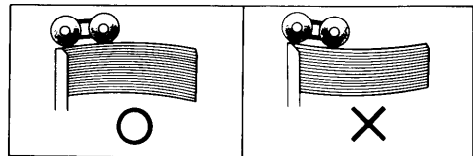
1. Remove the paper from the paper feed table.
 - The paper feed tray will lower automatically.



2. Adjust the paper feed side plates to match the paper size.



3. Place the paper on the paper feed table.
 - Correct the paper curl before setting the paper.

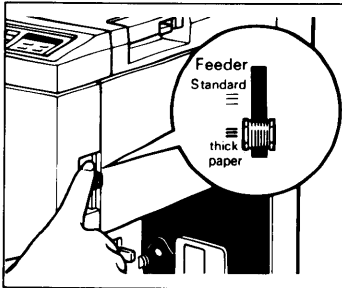


4. Adjust the paper delivery side plates and the paper delivery end plate. (See page 15.)
 - Make sure that the paper feed side plates contact the paper lightly.

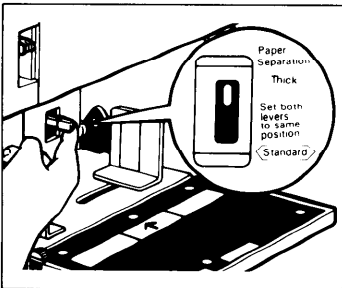
7. Printing on Thick or Thin Paper

When you make prints on thick or thin paper, do the following steps.

- Printing on thick paper

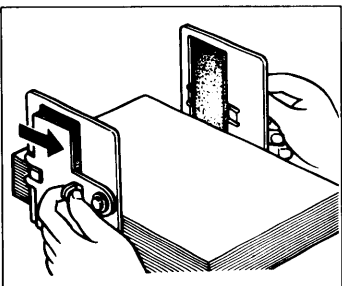


1. Push down the feed roller pressure lever.
 - Thick paper : 132.5 to 215 g/m² (35.2 to 57 lb)
 - In the case of paper smaller than 51/2"x81/2" and heavier than 132.5 g/m² (35.2 lb), move the feed roller pressure lever to the standard position.



2. Push the separation roller pressure levers up to the thick paper position.

- Printing on thin paper

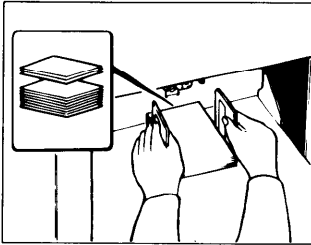


1. Set the side pads (Move the side pad levers to the right).
 - Thin paper : lighter than 51.2 g/m² (13.6lb)
2. Make prints. (See page 14 to 17.)

8. Printing on Postcard Size Paper

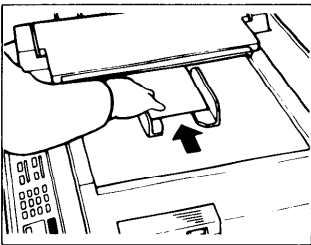
- As postcards do not absorb ink well, offset images may appear on the rear side of following prints. To avoid this, reduce the printing speed and place a sheet of paper on top of each printed postcard.

- Postcard size original



1. Place the postcard sized paper on the paper feed table.

- Make sure that the paper feed side plates contact the paper lightly.

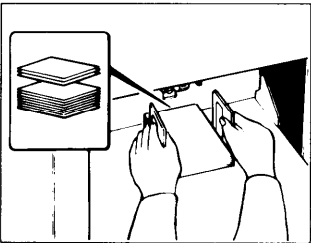


2. Set the original guides to match the postcard size original.

3. Insert the original face down into the original table until it stops.

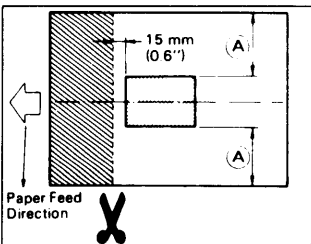
4. Make the prints. (See page 14 to 17.)

The original is larger than postcard and the image is postcard size.

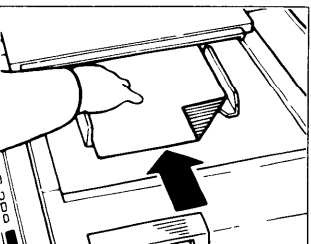


1. Place the postcard size paper on the paper feed table.

- Make sure that the paper feed side plates contact the paper lightly.



2. Cut the leading edge of the original as shown in the illustration. Leave 15 mm/0.6"(9/16") margin when you cut.



3. Insert the original face down into the original table until it stops.

4. Make the prints. (See page 14 to 17.)

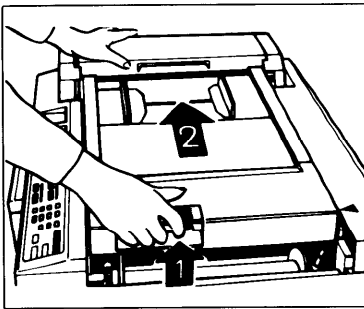
9. Various Originals

If you want to make prints using a light or dark original, change the printing density using the printing density select switch.

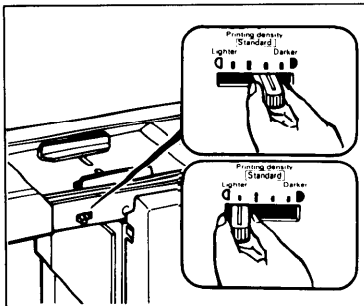
- Light image originals – Change the printing density to a darker setting
- Heavy image originals – Change the printing density to a lighter setting

NOTE:

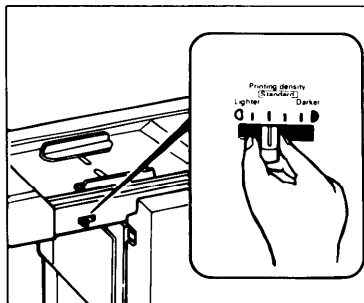
- Make sure that the printing density select switch clicks into position.
- Return the printing density select switch to its original position after printing.



1. Open the original table.
 - Lift the original table release lever and slide the original table to the "▼" mark.



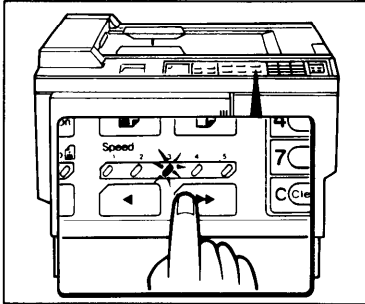
2. Adjust the printing density to match the type and quality of the original using the printing density select switch.
3. Return the original table to its original position.
4. Make the prints. (See page 14 to 17.)



5. After printing, return the printing density select switch to the standard position.

10. Changing the Printing Speed

Use the Speed key to adjust the rotation speed of the machine according to the image density and printing paper.



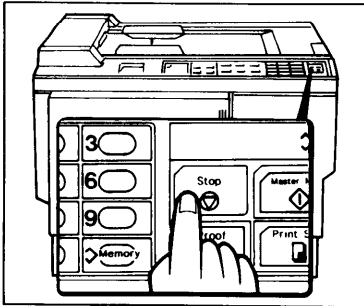
1. Press the **Speed** key. To increase speed, press the "▶▶" key. To reduce speed, press the "◀" key. The printing speed will be changed as follows:

Step 1	60 sheets/min
Step 2	75 sheets/min
Step 3	90 sheets/min
Step 4	105 sheets/min
Step 5	120 sheets/min

- When the main switch is turned on, step 3 (90 sheets/min) is selected automatically.
- The faster the printing speed becomes, the lighter the printing density is. If darker prints are required, set the printing speed lower.

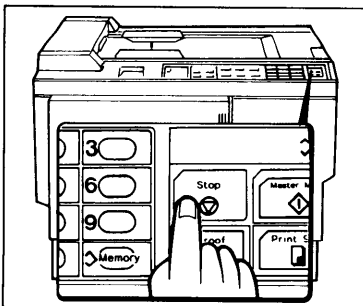
11. To Stop the Machine During a Printing Run

If you want to stop the machine during a print run and print the next original, do the following procedure.



1. Press the **Stop** key.
2. Set the new original.
3. Re-enter the number of prints and press the **Master Making** key.

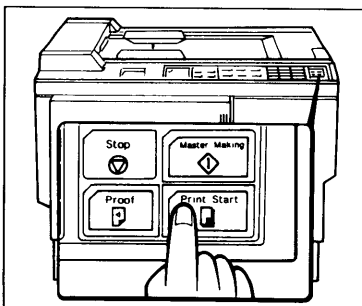
If you want to change the number of prints entered or to check the completed prints.



1. Press the **Stop** key.

Change the number of prints or check the completed prints.

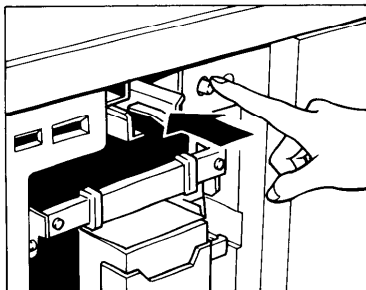
- When you change the number of prints, you can re-enter the number using the **Number** keys after pressing the **Stop** key.



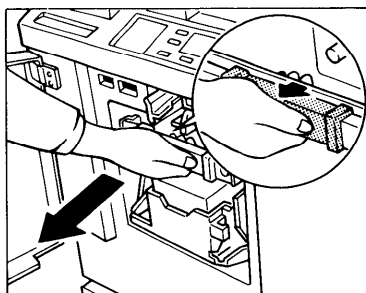
2. Press the **Print Start** key.

12. Changing the Drum Unit for Color Printing

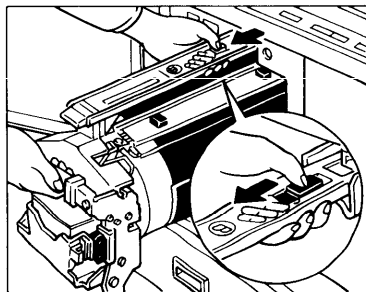
Color drum units Type VT2000-LG (red, blue, green, and brown) are available as options in addition to the standard black. For making color prints, a separate drum unit is necessary for each color.



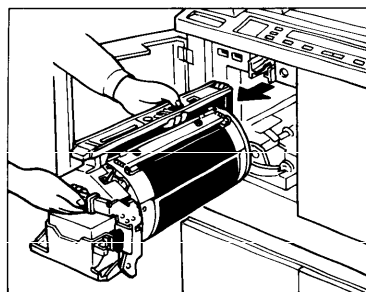
1. Open the front door.
 - Make sure that the lamp of the drum rotation button lights. If this lamp is not lit, press the drum rotation button until the beeper sounds.



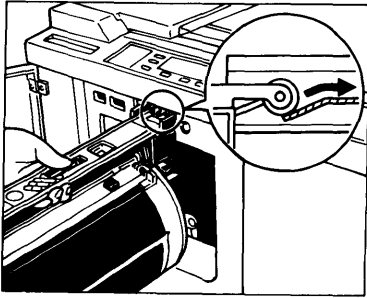
2. Pull out the drum unit handle while pressing the release bar inside the green handle.



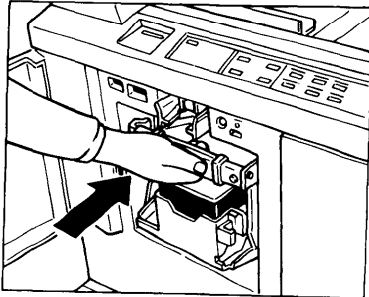
3. Hold the rail on the drum and slide out the drum while pressing the release slide to the front.



4. Remove the drum unit from the machine while holding the upper drum stay.
 - Be careful not to let the drum unit fall.



5. Insert the color drum unit along the guide rail.

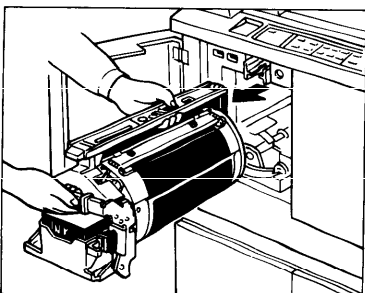
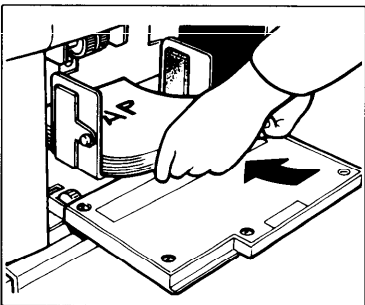
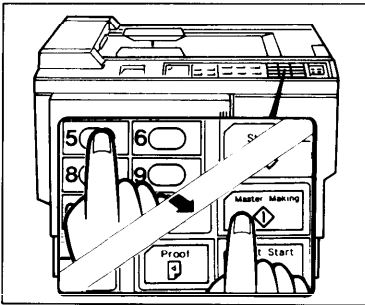
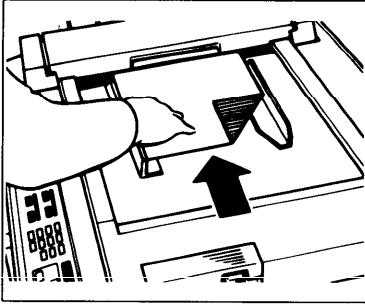


6. Slide in the drum unit until the drum unit locks securely.
7. Close the front door.
 - Make sure that the Cover Open indicator turns off, and the Color Drum indicator lights.
 - If the Cover Open indicator does not turn off, check that the drum unit is set correctly.

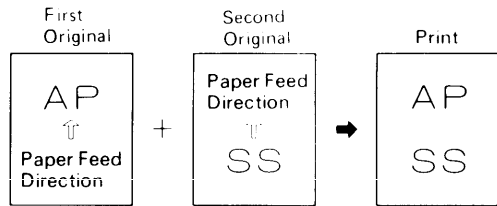
13. Printing in Two Colors

After printing in black, you can print in color on the same side of the print.

- You cannot print in two colors at one time.
- Leave the printed paper for a while before secondary printing, in order to dry the ink on the printed paper.

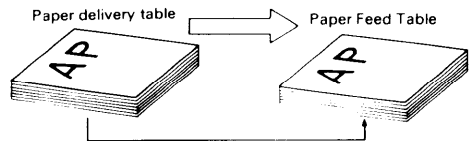


1. Prepare the two originals.
Set the first original on the original table.



2. Enter the number of prints using the **Number** keys.
3. Press the **Master Making** key.
 - The original is fed, and the trial print is delivered to the paper delivery table. Check the image position. (See page 19 to 20).

4. Press the **Print Start** key.
5. Remove the prints from the paper delivery table and set them on the paper feed table again as shown in the illustration.



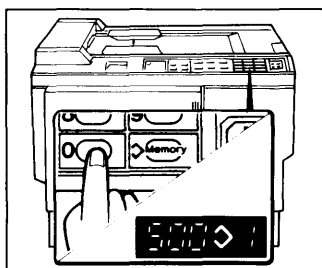
6. Exchange the drum unit. (See page 27 to 28.)
7. Set the second original and press the **Master Making** key. Check the image position. (See page 19 to 20.)
8. Press the **Print Start** key.

SPECIAL FUNCTIONS

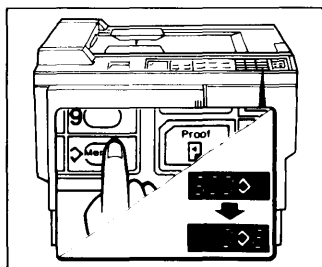
1. Group Printing from the Same Original

Use the **Memory** key to make sets of prints from the same original. A different number of prints can be made for each set.

- The optional tape dispenser automatically feeds out strips of paper which separate the printing groups on the paper delivery table.

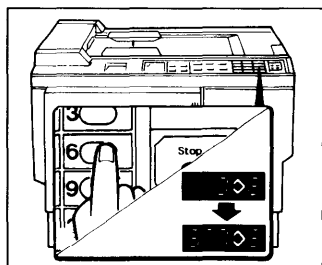


1. Turn on the main switch.
2. Enter the number of prints for the first set using the **Number** keys.

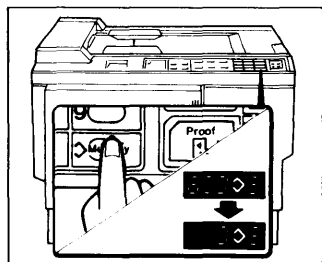


3. Press the **Memory** key.

The number for the first set is stored in Memory 1.

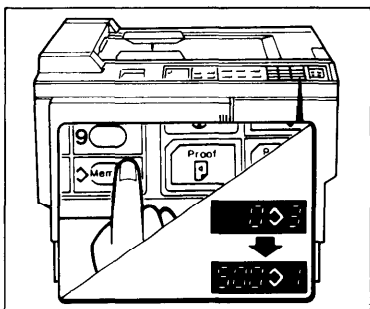


4. Enter the number of prints for the second set using the **Number** keys.



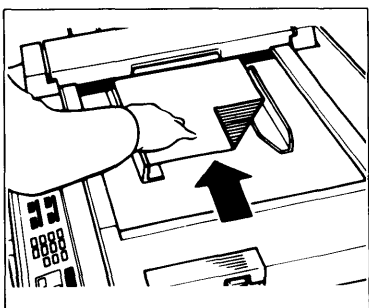
5. Press the **Memory** key. The number for the second set is stored in Memory 2.

Repeat the above procedure until you complete the settings.

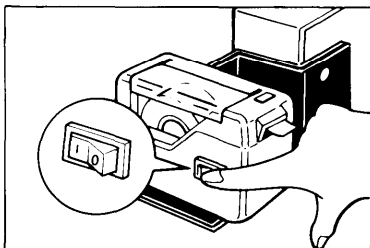


6. Press the **Memory** key again. The Memory returns to Memory 1.

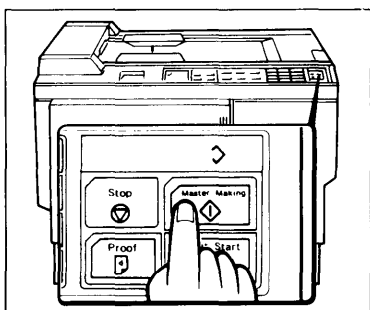
- You only need to press the **Memory** key again if you have stored the print quantity for less than 10 sets. The Memory automatically returns to Memory 1 after the 10th set is stored in Memory.



7. Set the original face down on the original table.



8. Turn on the power switch of the optional tape dispenser.



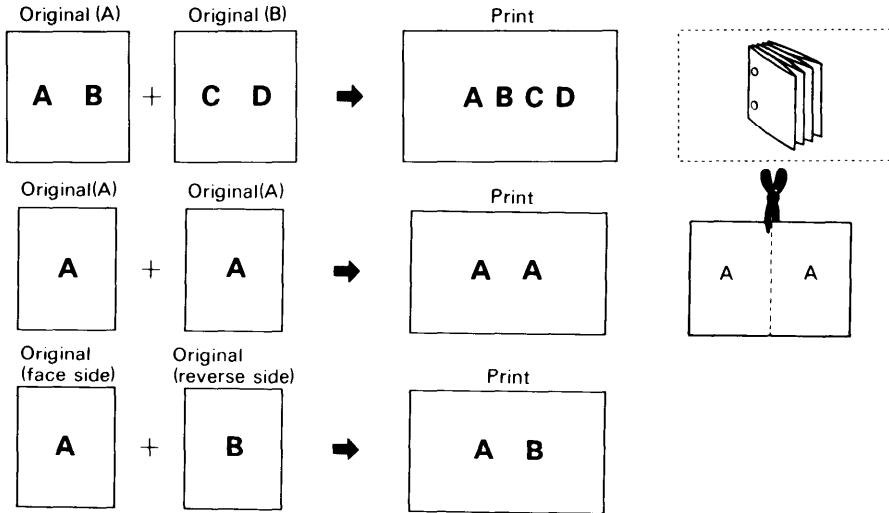
9. Press the **Master Making** key. Check the image position of the trial prints. (See page 19 to 20.)

10. Press the **Print Start** key.

- After the last page of each printing set is fed out to the delivery table, the tape dispenser drops a strip of paper onto the top of the paper stack. This marks the end of each printing set.

2. Combine 2 Originals

You can print 2 separate originals on a single sheet of paper.



Note:

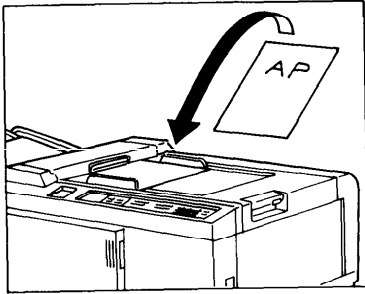
- If you print 8 1/2" x 11" originals on one sheet of paper, set the reduction ratio to 75% or 64%. When using 8 1/2" x 11" originals, you cannot use this mode with 93% or 100%.
- Use paper larger than the combined image area of the 2 originals.

For Example:

Original \ Ratio		Ratio				
		100%	93%	75%	64%	
HLT	+	HLT	LT	LT	LT	HLT
LT	+	LT	—	—	Legal	LT

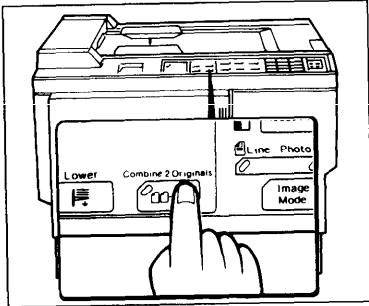
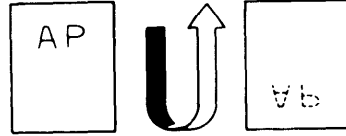
- If you set an original larger than as shown in the following table, the Combine 2 Originals mode is canceled automatically.

100%	→	5 1/2" x 8 1/2"
93%	→	5 1/2" x 8 1/2"
75%	→	8 1/2" x 11"
64%	→	8 1/2" x 11"



1. Set the first original face down and with the top toward the operating side.

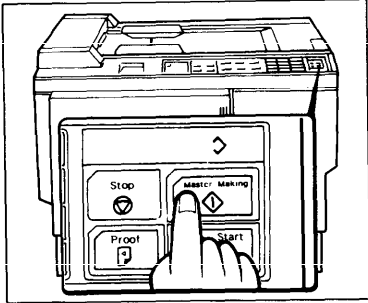
- The first original fed will be printed on the leading part of print.



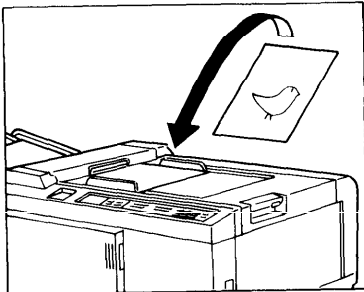
2. Enter the number of prints using the **Number** keys.

3. Check the print paper size.

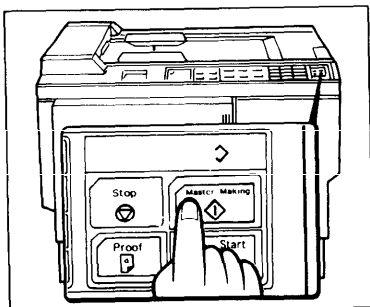
4. Press the **Combine 2 Originals** key.
 - The indicator of the **Combine 2 Originals** key will light.



5. Press the **Master Making** key.



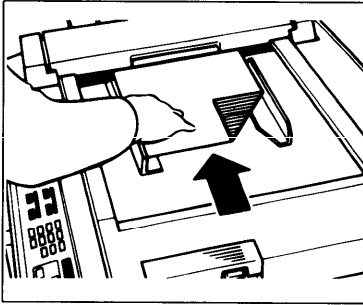
6. Set the second original face down after master making for the first original is finished and the beeper sounds.



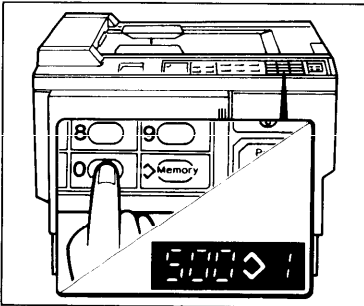
7. Press the **Master Making** key.

8. Check the image position of trial prints and press the **Print Start** key.

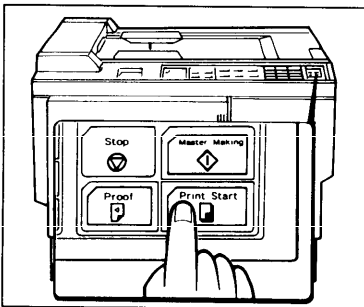
3. Various Run Lengths Using the Same Master



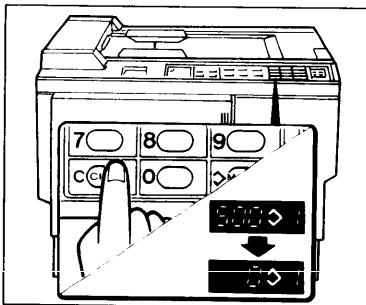
1. Set one original on the original table.



2. Enter the number of prints for the first run using the **Number** keys.
3. Press the **Master making** key. Check the image position of trial prints. (See page 19 to 20.)



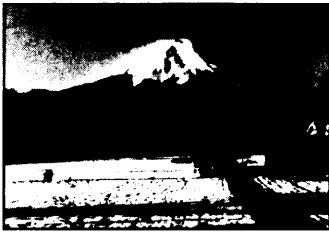
4. Press the **Print Start** key.
5. Remove the prints from the paper delivery table.



6. Press the **Clear** key to return the counter to "0".
7. Enter the number of prints for the second run using the **Number** keys.
8. Press the **Print Start** key.
9. Remove the prints from the paper delivery table.
10. Repeat steps 6-9 until printing is completed.

4. Photo Mode Printing

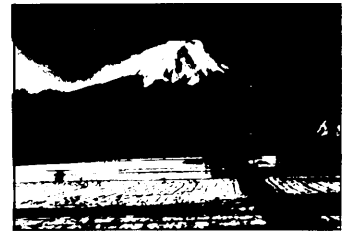
When printing a photograph or a color original, select Photo Mode.



Original

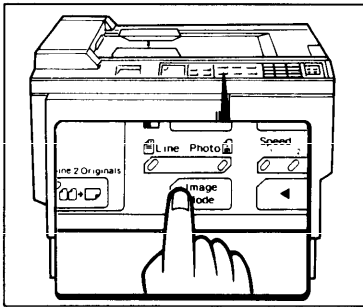


Photo mode

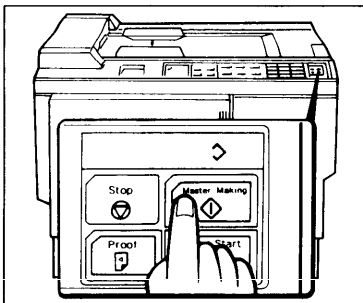


Line mode

- Striped patterns may occur when meshed originals are printed.
- When using originals with letters and photos, the image of the letters will be light.



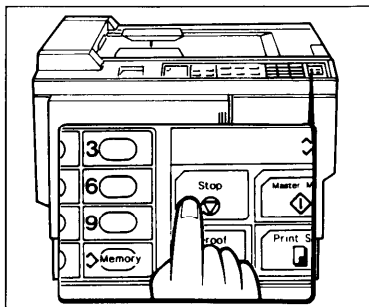
1. Press the **Image Mode** key to select Photo mode.



2. Press the **Master Making** key.

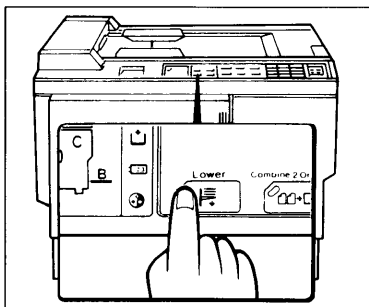
REPLENISHING SUPPLIES

1. Loading Paper



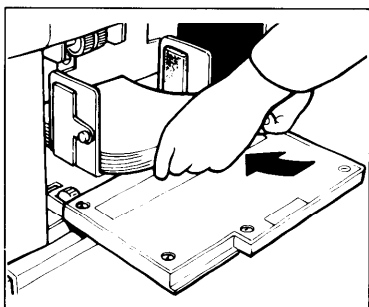
1. Press the **Stop** key.

- This step is necessary only if you want to pause a print run to replenish paper.



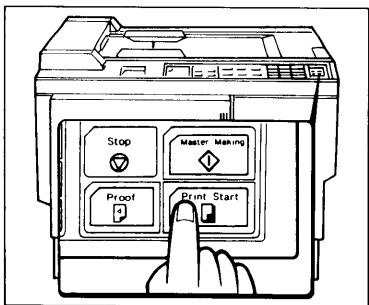
2. Press the **Lower Paper Feed Table** key.

- The paper feed table will lower automatically when the printing paper runs out.
- When the paper feed table lowers, the top sheet may remain between the feed rollers. In this case, remove the top sheet by hand.



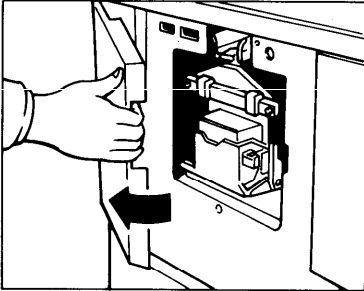
3. Load paper on the paper feed table.

- Release the pads of the feed side plates before loading paper. Reset the pads after paper is set.

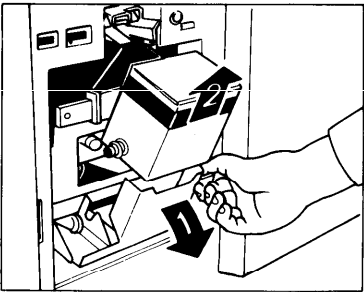


4. Press the **Print Start** key to resume printing.

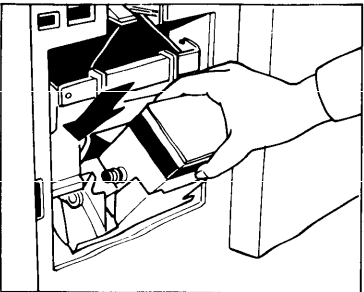
2. Supplying Ink



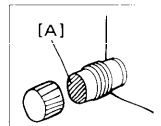
1. Open the front door.



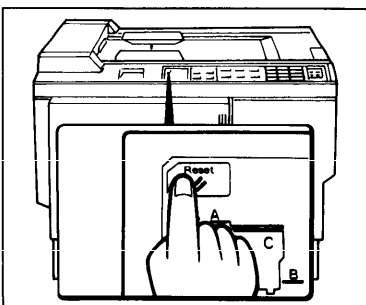
2. Lower the ink holder and remove the used ink cartridge.



3. Remove the cap of the new ink cartridge and insert the new cartridge into the ink holder. Return the ink holder to its original position.



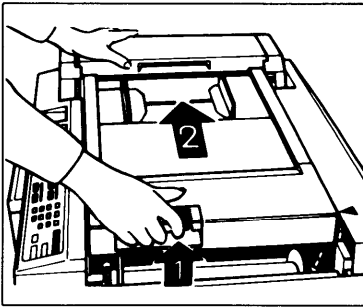
- Do not remove the seal [A].
- Supply the same color ink.



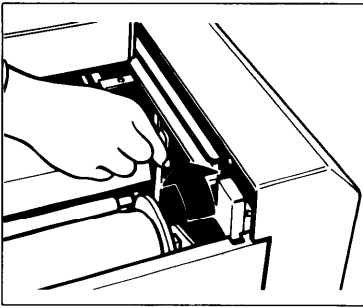
4. Close the front door.
5. Press the **Reset** key.

Ink will be supplied and the machine will stop automatically.

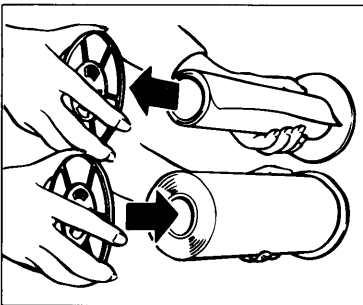
3. Master Roll Replacement



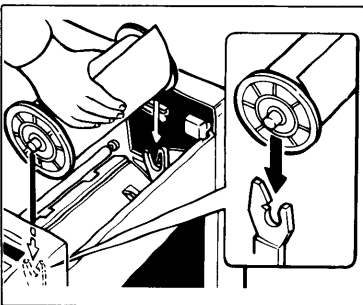
1. Open the original table.
 - Lift the original table release lever and slide the original table to the "▼" mark.



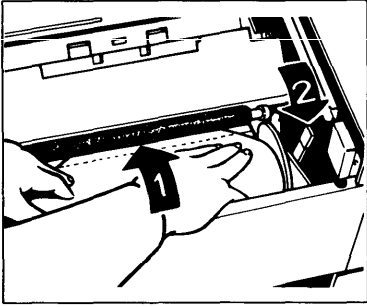
2. Lift the pressure release lever in the direction of the arrow to release the feed roller pressure.



3. Remove the used master roll and pull out both spools. Then, insert both spools into a new master roll (Type VT-S).
 - When the Master End indicator lights, it is necessary to replace the master roll even if some paper remains on the old roll.

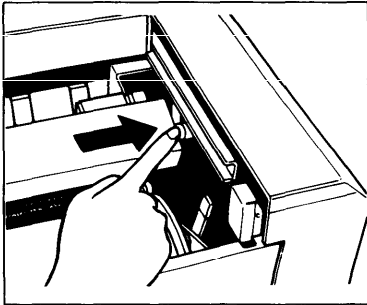


4. The new master roll must be positioned as shown in the illustration.



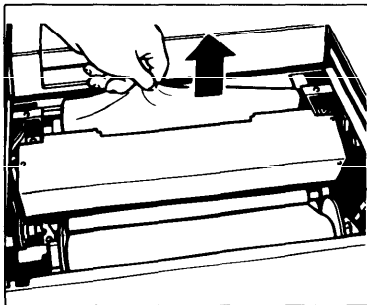
5. Insert the leading edge of the master roll under the pressure roller.(1)
6. Return the pressure release lever to its original position.(2)

- Rotate the spools backward to take up all slack in the master paper.

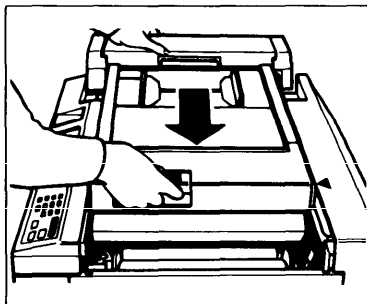


7. Press the master cut button to cut the leading edge of the master roll.

Warning: When the master cut button is pressed, the master roll will rotate. Do not touch the master roll.



8. After the beeper sounds, remove the cut-off portion of the master roll.
 - Remove the cut-off master paper completely to prevent master misfeed.

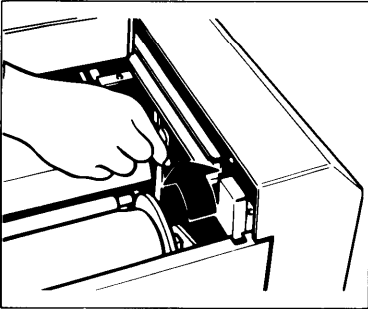


9. Return the original table to its original position until it stops.

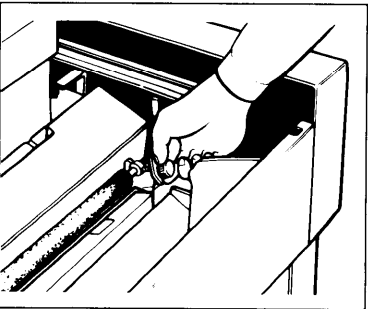
MAINTENANCE

1. Thermal Head Cleaning

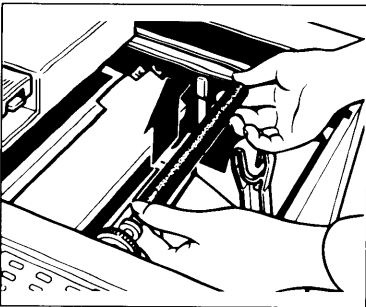
Clean the thermal head when 2 master rolls have been used.



1. Turn off the main switch.
2. Open the original table. (See page 38.)
3. Move the pressure release lever in the direction of the arrow. (See page 38.)

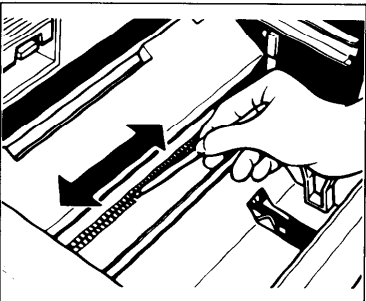


4. Loosen the screw knobs located on both sides of the feed roller.



5. Grip both ends of the feed roller and lift it straight up.
6. Clean the thermal head as follows.
 - 1) Wipe the surface of the thermal head with a damp cloth.
 - 2) Clean the surface of thermal head several times using the cleaner pen with cleaning solution. (The cleaner pen is stored in the carton box as an accessory.)
 - 3) Dry the surface of thermal head with a clean dry cloth.

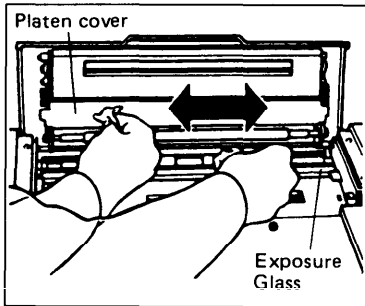
Warning: Make sure to replace the cap of cleaner after using it.



- Replace the felt of the cleaner pen if it becomes dirty.
7. Install the feed roller by reversing the above procedure.
 - Make sure to tighten the screw knobs on both sides of the feed roller.

2. Platen Cover / Exposure Glass

To maintain a high copy quality, clean the following sections regularly.



1. Platen Cover / Exposure Glass
















- Clean the platen cover and the exposure glass with a soft cloth and a commercial glass cleaner.
- Be careful not to touch the detect switch (white).

TROUBLESHOOTING

1. Indicators

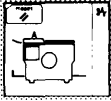
If a malfunction or a misfeed occurs within the machine, the following indicators will light.

- Check the misfeed or malfunction location.

-  + **A** Open the top unit cover, remove original and reset. (See page 43.)
-  + **B** Remove the jammed paper and press the Reset key. (See page 44.)
-  + **C** Remove the jammed master and press the Reset key. (See page 45.)
-  + **E** Open the master eject unit and remove any jammed paper, then press the Reset key. If the paper is stuck to the drum, pull out the drum unit until the drum unit hits the drum stopper, and remove the jammed paper from the drum. (See page 46.)
-  + **E + B**
1. If the paper is stuck to the drum, pull out the drum unit until the drum unit hits the drum stopper, and remove the jammed paper from the drum.
 2. If the jam is in the paper feed section, the jammed paper may be cleared at either the paper entrance or the paper exit side. (See page 47.)
-  + **F** Open the master eject unit and remove the jammed master. Press Reset key. If the jammed master is stuck to the drum, pull out the drum unit and remove the misfed master. (See page 48.)
-  + **G** Open the master eject unit and remove the jammed paper. Press Reset key. (See page 48.)
-  + **A** Check that the original is correctly placed and that the counter is set for the required number of copies. (See page 49.)
-  + **B** Load paper. (See page 49.)
-  + **C** Load new master roll. (See page 49.)
-  + **D** Load new ink cartridge. (See page 50.)
-  + **F**
1. Remove the used masters inside the master eject box.
 2. Make sure the master eject box is replaced correctly. (See page 50.)
-  Check the setting of the original table, the front cover, the master eject unit, the drum, the paper feed table, and the top unit. (See page 51.)
-  Color drum is installed. (See page 51.)
-  **123** Set the key counter. (See page 51.)

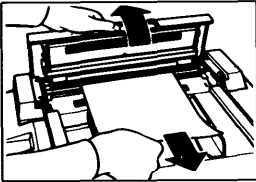
If a service code (E01 – E08) is displayed in the counter, please contact your service representative.

2. When the Misfeed (⚠) Indicator Lights

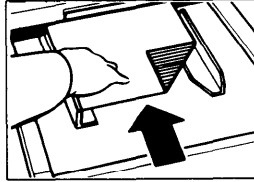


⚠ + A

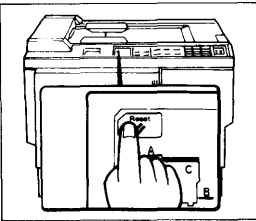
Original misfeed



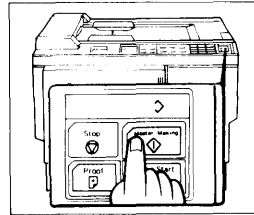
1. Open the top unit and pull out the original.



3. Reset the original.



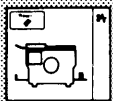
2. Close the top unit. Press the Reset key.



4. Press the Master Making key.

To prevent original misfeeds:

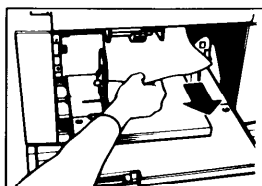
- | | | |
|-----------------------------------|---|---------------------|
| ● Thin original | → | Make a copy |
| ● Thick original | → | Make a copy |
| ● Paste-up original | → | Make a copy |
| ● Folded or damaged originals | → | Make a copy |
| ● Originals larger than 11" x 17" | → | Make a reduced copy |



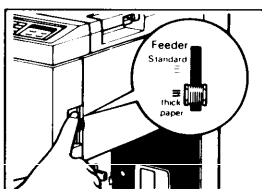
A + B

Paper misfeed in paper feed section.

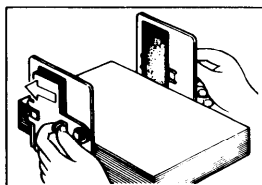
When a sheet of paper is misfed:



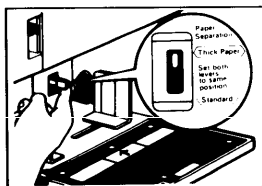
1. Remove the misfed paper.



2. If the feed roller pressure lever is in the standard position, set it in the thick paper position.



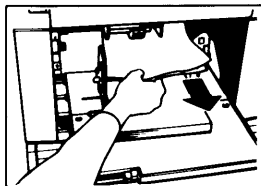
3. Release the side plate pads.



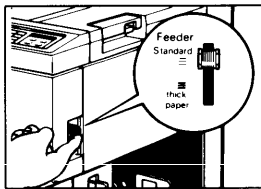
4. If the separation roller pressure lever is in the standard position, move it to the thick paper position.

5. Press the Reset key.
6. Press the Print Start key.

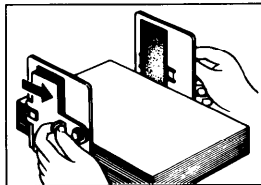
When two or more sheets are misfed:



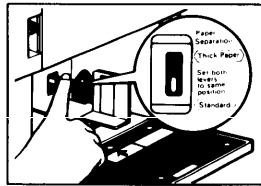
1. Remove the misfed sheets.



2. If the feed roller pressure lever is in the thick paper position set it in the standard position.



3. If the pad levers are positioned to the left, move them to the right.

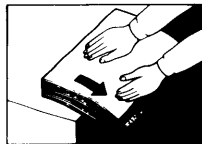


4. If the separation roller pressure lever is in the thick paper position, move it to the standard position.

5. Press the Reset key.
6. Press the Print Start key.

To prevent paper feed jams:

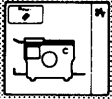
- Curled paper. → Correct the curl.



- Post card and thick paper. → Set the printing speed slower than step 3. (See page 25.)

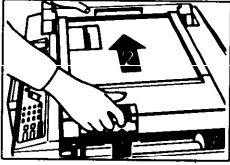
- Paper edges stuck together → Shuffle the paper



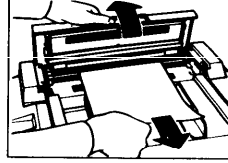


A + C

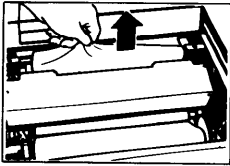
Master misfeed in master feed section.



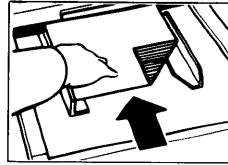
1. Slide the original table to the left while pulling up original table release lever.



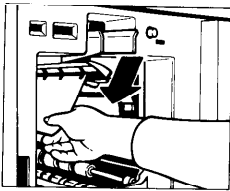
5. Open the top unit and slowly but firmly pull out the original.



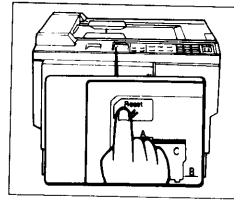
2. Remove the misfed master.
3. Slide the original table to the original position.



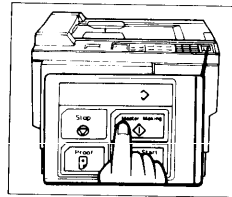
6. Re-insert the original after closing the top unit.



4. If you could not remove the misfed master in step 2, take out the drum and remove the misfed master from inside. (See page 27 and 28.)

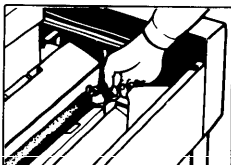


7. Press the Reset key.

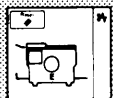


8. Press the Master Making key.

Check whether the master feed roller is installed properly when there is a master misfeed.



Check that the installation screws on both sides of the master feed roller are secured.

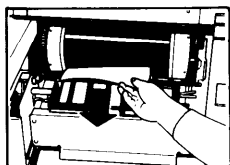


⌘ + E

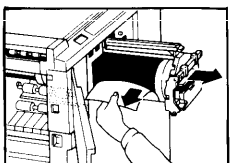
Paper wrapping around the drum.



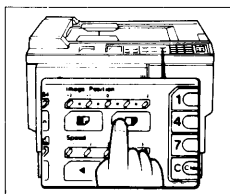
1. Push the master eject unit open button and open the master eject unit.



2. Remove the misfed paper.

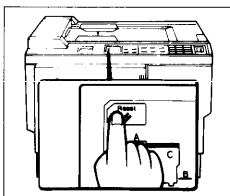


3. When paper is completely wrapped around the drum, pull out the drum unit until the drum hits the drum stopper, and remove the misfed paper from the drum.

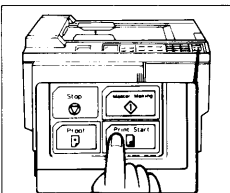


4. Close the front cover and the master eject unit.

5. Prints which have an image on the leading edge tend to wrap around the drum easily. Shift the image toward to the trailing edge.


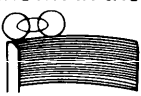
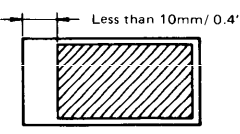


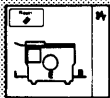
6. Press the Reset key.



7. Press the Print Start key. Use the Proof key if necessary.

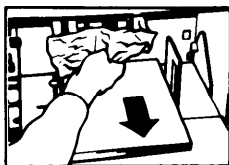
If the paper is curled or the original has narrow leading edge margin, the following action is necessary.

Curled Paper	Narrow Leading Edge Margin Original
<ul style="list-style-type: none"> • Curled paper <p>→ Correct the curl.</p>  <p>→ Load the paper with the face curl down as shown in the figure.</p> 	<ul style="list-style-type: none"> • Leading edge margin less than 10 mm. Solid fill image on the leading edge. <p>→ Insert the original with the widest blank margin first.</p> <p>→ Make a leading edge margin by making a copy.</p> 

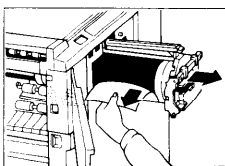


**A + E + B Misfeed in paper feed section.
Paper wrapped around the drum.**

- Misfeed in paper feed section
- Paper is wrapped around the drum.

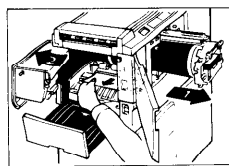


Slowly but firmly pull out the paper.

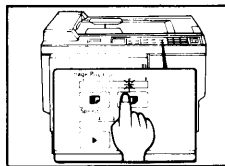


When paper is completely wrapped around the drum, pull out the drum unit until the drum hits the drum stopper, and remove the paper from the drum.

- When the misfed paper is underneath the drum.
(Difficult to remove the paper from the paper feed section.)

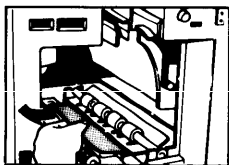


1. Pull out the drum until the drum unit hits the drum stopper and remove the paper from the paper exit side.

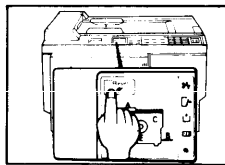


2. When the image is located on the leading edge, shift the image to the trailing edge by pressing the right image position key.

- (Also difficult to remove the paper from the paper exit section.)


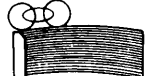
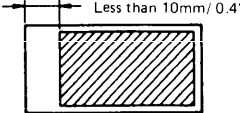


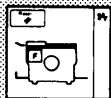
1. Take out the drum unit. Remove the misfed paper. (Refer to page 27 to 28 for the drum removal)



2. Press the Reset key.
3. Press the Print Start key. Use the Proof key if necessary.

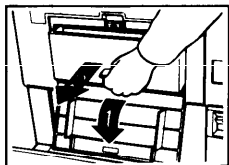
If the paper is curled or the original has narrow leading edge margin, the following action is necessary.

Curled Paper	Narrow Leading Edge Margin Original
<ul style="list-style-type: none"> • Curled Paper <p>Correct the curl.</p>  <p>Load the paper with the face curl down as shown in the figure.</p> 	<ul style="list-style-type: none"> • Leading edge margin less than 10 mm/0.4". Solid fill image on the leading edge. <p>Insert the original with the widest blank margin first.</p> <p>Make a leading edge margin by making a copy.</p> 

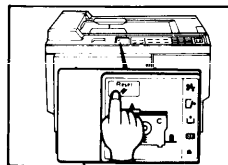


⚠ + F

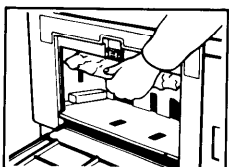
Master misfeed in the master eject section.



1. Open the master eject container cover and remove the master eject box.

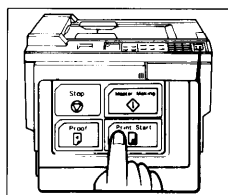


4. Press the Reset key.



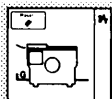
2. Remove the misfed master from master eject section.

3. Reinstall the master eject box and close the master eject container cover.



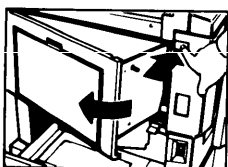
5. Press the Print Start key.

- When the master eject box is full, remove the used masters from the box.

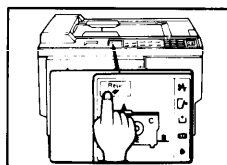


⚠ + G

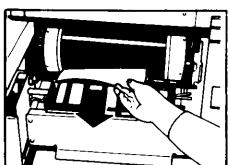
Paper misfeed in the paper exit section.



1. Open the master eject unit by pushing the master eject unit open button.

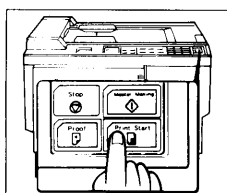


4. Press the Reset key.



2. Remove the misfed paper.

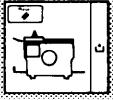
3. Close the master eject unit.



5. Press the Print Start key.

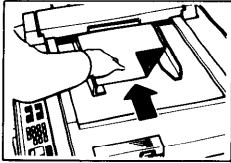
- If misfeeds occur while printing on thick paper, lift the wing guide release lever to the thick paper position. (Refer to page 22 for details.)

3. When the Supply/Exchange (⬇️) Indicator Lights

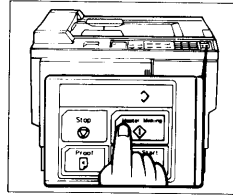


⬇️ + A

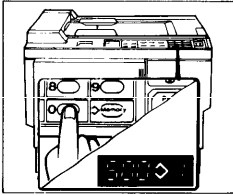
Originals are not properly inserted or the print number has not been input.



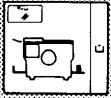
1. Set the original.



3. Press the Master Making key.

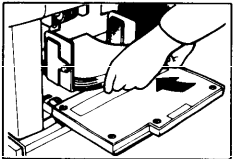


2. Input the number of prints using the Number keys.

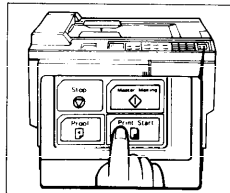


⬇️ + B

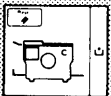
Paper End



1. Load paper on the paper feed table. (See page 36.)

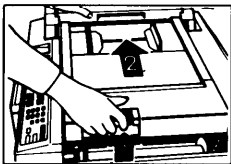


2. When the paper end occurs during a printing run, press the Print Start key again to resume printing.

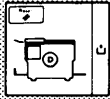


⬇️ + C

Master Paper End

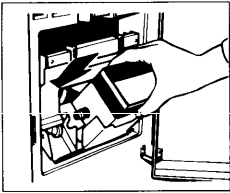


1. Slide the original table to the left by pulling up the original table release lever. Exchange the master roll. (Refer to page 38 for details.) Reset the original table after replacing the master roll.

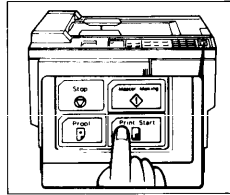


+ D

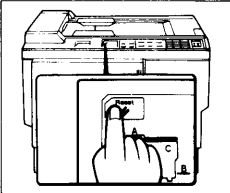
Add Ink



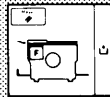
1. Open the front cover and replace the ink cartridge. (Refer to page 37 for the details.)



3. When the add ink indicator blinks during repeat printing, press the Print Start key again to resume printing.



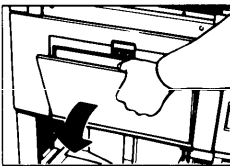
2. Press the Reset key.
 - Ink is supplied to the drum.
 - Press the Reset key again if the add ink indicator does not turn off.



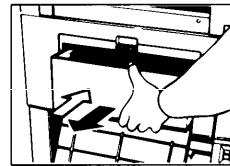
+ F

Master eject box full. Incomplete master eject box installation. No master eject box.

- When the master eject box is full, do the following:



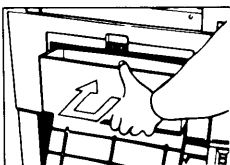
1. Open the master eject container cover.



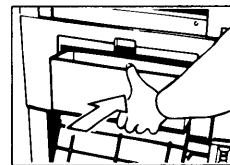
2. Take out the master eject box and remove the used masters.
3. Install the master eject box and close the master eject container cover.

4. Press the Reset key.

- Incomplete master eject box installation.



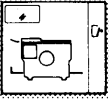
1. Open the master eject container cover.
2. Reinstall the master eject box.
 - Push the box so that it is in contact with the inside bracket.
3. Close the master eject container cover.



1. Open the master eject container cover.
2. Install the master eject box.

- No master eject box.

4. Other Indicators Light

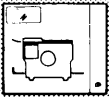
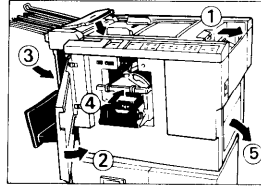


Cover Open / Unit Open

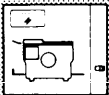
Make sure that the following covers/units are closed.

1. Original Table
2. Front Cover
3. Master Eject Unit
4. Drum Unit
5. Paper Feed Table

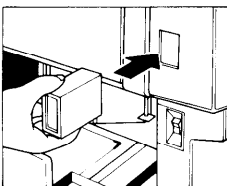
(Make sure that the paper feed table should be open.)



Color drum unit is installed.



Key Counter: The key counter is not set.



Insert the key counter.

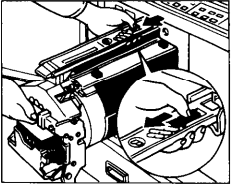
When an error code (E-01 – E-08) is displayed, contact your service representative.

5. Poor Printing

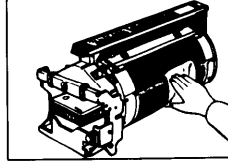


Dirty background of prints

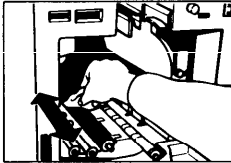
← Feed Direction



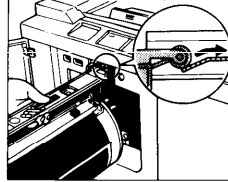
1. Remove the drum unit. (Refer to page 27 to 28 for details.)



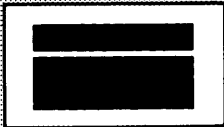
3. Clean the drum with a clean cloth.



2. Clean the pressure roller with a clean cloth.



4. Install the drum unit. (See page 27 to 28 for details.)

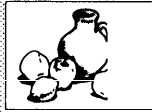


White Lines / Black Lines

← Feed Direction

Check following parts and clean them if necessary.

- 1) Platen cover (See page 41.)
- 2) Exposure glass (See page 41.)
- 3) Thermal head (See page 40.)

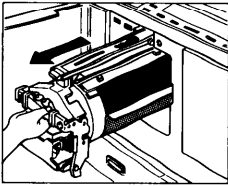


**White prints
Incomplete prints**

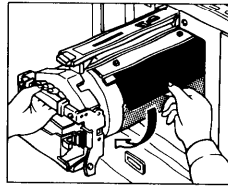
Original

White print

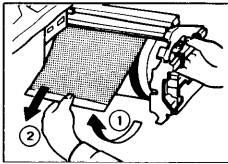
Incomplete print



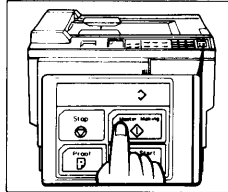
1. Pull out the drum unit.



3. Remove the paper that is adhered to the drum.



2. Remove the master from the drum.

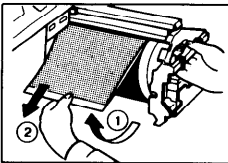


4. Set the original and press the Master Making key.

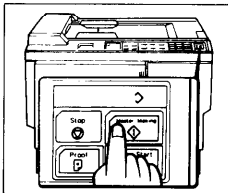


Light prints

Original



1. Pull out the drum and remove two masters.



2. Set the original and press the Master Making key.

MISCELLANEOUS

1. Operating Cautions

1. If there is no blank area or a solid image area on the leading edge of the original, create a blank area because the paper may wrap around the drum or the paper eject pawl may become dirty and cause black line on prints.
2. When the paper is curled, stack the paper with the curl face down, otherwise the paper may wrap around the drum or stains may appear.
3. Make sure to make a few trial prints to check the image position because the image position of the trial print may not correspond with that of the original.
4. If the image registration is not consistent, set the printing speed slower than step 3.
5. The leading edge of the prints may become stained if the edge touches the image of prints on the paper delivery table.
6. In case of duplex or multicolor printing, leave the printed paper for a while before the next printing in order to dry the ink on the printed paper. If this is not done, feed roller marks will appear on the print image.
7. If the machine is not used for a long period, the image density may decrease because the ink on the drum may dry. Make extra prints until the image density recovers.
8. When the machine is used in low temperature conditions, the image density may decrease. In this case, decrease the printing speed (1 or 2 steps).
9. The ink of the print on the paper delivery table may stick to the back side of the next print.

10. When making duplex prints, misdetection of paper wrapping may occur because the paper delivery sensor detects the black area at the leading edge of the back side. Keep more than 10mm/0.4" blank area at the leading edge of the back side of the printing paper.
11. Do not use the thermal head cleaner for anything but cleaning the thermal head. Also, be sure to read the cautions about the thermal head cleaner, and be careful as this cleaner is an alcohol.
Take note of the following regarding the cleaner:
 - Do not take internally.
 - Do not breathe it.
 - Keep out of the reach of children.
 - If it comes in contact with skin, wash well with water.
 - Keep away from eyes. If it comes in contact with your eyes, wash well. If irritation occurs, contact your doctor.
 - Never place it where it will be exposed to heat.
12. When feeding 5 1/2"x8 1/2" paper in the sideways direction, the prints may not stack correctly on the paper delivery table. In this case, push up the wing guide release lever.
13. Perform a test print using the Proof key as the first few prints may be light.
14. When the machine is on and the power source is less than 90% of the specified amount, printing quality will decrease. Therefore, make sure the mains supply is at least 90% of the required amount.
15. Such paper as postcards do not absorb ink well. Therefore, offset images may appear on the rear side of following prints. Solid image originals will make offset image prints.
16. As various kinds and qualities of paper exist, some paper may be wrapped around the drum and/or cause jams.

SPECIFICATION

Configuration:	Desk top
Master Processing:	Digital
Printing Process:	Full automatic one drum stencil system
Original Type:	Sheet
Image Mode:	Line/Photo
Color Printing:	Drum unit replacement system (red, blue, green, and brown) (option)
Master Feed/Eject:	Roll master automatic feed/eject
Original Size:	Maximum 307 mm x 432 mm (12.0" x 17.0")
Paper Size:	Maximum 297 mm x 442 mm (11.6" x 17.4") Minimum 90 mm x 148 mm (3.6" x 5.8")
Paper Weight:	50 to 215 g/m ² (13.3 to 57 lb)
Printing Area:	Maximum 210 mm x 350 mm (8.3" x 13.7") (at 20°C/65%RH)
Reproduction Ratio:	100% → 93% → 75% → 64%
Printing Speed:	5 steps: 60, 75, 90, 105, 120 sheets/minute
Paper Feed Table Capacity:	1,000 sheets (66.3 g/m ² /17.6 lb)
Paper Delivery Table Capacity:	500 sheets (66.3 g/m ² /17.6 lb)
Power Source:	120V, 50/60Hz, 5.5A
Power Consumption:	120V version: 430W
Dimensions (W x D x H):	Printing: 1279 x 607 x 656 mm (50.4 x 23.9 x 25.9 inches) Storing: 735 x 607 x 569 mm (28.9 x 23.9 x 22.4 inches)

Weight: 120V version: 100 kg (220.4 lb)

Optional Equipment: Color drum unit type VT2000-LG (red, blue, green, and brown)
Key counter
Tape marker type 20

Consumables:

Name	Size	Remarks
Priport Master VT-S	125m(410 ft)/roll 2 Rolls/case	250 masters can be made per one roll. Storage: 0 - 40°C, 10 - 95%RH
Priport Ink-Black	500 cc/pack 5 packs/ case	Environmental conditions: 10 - 25°C, 20 - 90%RH Storage: 5 - 40°C, 10 - 95%RH
Priport Ink-Red	500 cc/ pack 5 packs/case	
Priport Ink-Blue	500 cc/pack 5 packs/case	
Priport Ink-Green	500 cc/pack 5 packs/case	
Priport Ink-Brown	500 cc/pack 5 packs/case	
Thermal head Cleaner	Cleaner pen - 1pc Replacement Felt - 10pcs Cleaner Bottle - 1pc	Clean the thermal head using the cleaner when 2 master rolls have been used.

- For good print quality, Ricoh recommends that you use genuine Ricoh ink and master.
- Specifications are subject to change without notice.

Ricoh shall not be responsible for any damage or expense that may result from the use of parts other than genuine Ricoh parts in your Ricoh office product.