

Handbuch

Manual

Manuel



Yakumo

DVD Record Master XL

DVD+RW Recorder/Player

Safety Precautions



The lightning flash with an arrowhead symbol within an equilateral triangle is intended to alert the user to the presence of uninsulated "dangerous voltage" within the product's enclosure that may be of sufficient magnitude to constitute a risk of electric shock to persons.



The exclamation point within an equilateral triangle is intended to alert the user to the presence of important operating and maintenance (servicing) instructions in the literature accompanying the appliance.

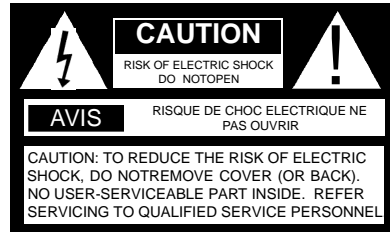

WARNING: DO NOT EXPOSE THIS APPLIANCE TO RAIN OR MOISTURE, DUE TO THE HIGH RISK OF FIRE OR ELECTRIC SHOCK, DO NOT OPEN THE CABINET DANGEROUS HIGH VOLTAGES ARE PRESENT INSIDE THE ENCLOSURE. ONLY QUALIFIED SERVICE PERSONNEL SHOULD ATTEMPT THIS.

CAUTION: TO PREVENT ELECTRIC SHOCK, MATCH WIDE BLADE OF PLUG TO WIDE SLOT, AND FULLY INSERT.

ATTENTION: POUR EVITER LES CHOCS ELECTRIQUE, INTRODUIRE LA LAME LA PLUS LARGE DE LA FICHE DANS LABORNE CORRESPONDANTE DE LAPRISE ET POUSSER JUSQU' AU FOUD.

CAUTION: This Digital Video Disc Player employs a Laser System. To prevent direct exposure to the laser beam, do not try to open the enclosure. Visible laser radiation emits when open and interlocks are defeated. Use of controls or adjustments or performance of procedures other than those specified herein may result in hazardous radiation exposure. **DO NOT STARE INTO BEAM.**

To ensure proper use of this product, please read this owner's manual carefully and retain for future reference. Should the unit require maintenance, contact an authorized service location, or contact us. Only qualified service personnel should remove the cover.

WARNING: Changes or modifications made to this equipment, not expressly approved by us or parties authorized by us will void all the manufacture warranties. **THE REGION CODE FOR THE UNIT IS 2.**



Since it is very usual for DVD movies to be released at different times in different regions of the world, all players have region codes and disks can have an optional region code. If you load a disk of a different region code to your player, you will see the region code notice on the screen. The disk will not play, and should be unloaded.

For Customer Use:

In spaces provided below, record the Model and Serial No. located on the rear panel of your DVD video player.

Model No. _____ Serial No. _____

Retain this information for future reference.

Safety Information

CAUTION: Use of controls or adjustments or performance of procedures other than those specified herein may result in hazardous radiation exposure.

Please carefully study this manual and always keep it available. There are, however, some installation and operation precautions which you should be aware of.

1. Read Instructions - All the safety and operating instructions should be read before the product is operated.
2. Retain Instructions - The safety and operating instructions should be retained for future reference.
3. Heed Warnings - All warnings on the product and in the operating instructions should be adhered to.
4. Follow Instructions - All operating and use instructions should be followed.
5. Cleaning - Unplug this product from the wall outlet before cleaning. Do not use liquid cleaners or aerosol cleaners. Use a damp cloth for cleaning.
6. Attachments - Do not use attachments not recommended by the product manufacturer as they may cause hazards.
7. Water and Moisture - Do not use this product near water - for example, near a bath tub, wash bowl, kitchen sink, or laundry tub; in a wet basement; or near a swimming pool; and the like.
8. Accessories - Do not place this product on an unstable cart, stand, tripod, bracket, or table. The product may fall, causing serious injury to a child or adult, and serious damage to the product. Use only with a cart, stand, tripod, bracket, or table recommended by the manufacturer, or sold with the product. Any mounting of the product should follow the manufacturer's instructions, and should use a mounting accessory recommended by the manufacturer.
9. Product and cart combination should be moved with care. Quick stops, excessive force, and uneven surfaces may cause the product and cart combination to overturn.
10. Ventilation - Slots and openings in the cabinet are provided for ventilation and to ensure reliable operation of the product and to protect it from overheating, and these openings must not be blocked or covered. The openings should never be blocked by placing the product on a bed, sofa, rug, or other similar surface. This product should not be placed in a built-in installation such as a bookcase or rack unless proper ventilation is provided or the manufacturer's instructions have been adhered to.
11. Power Sources - This product should be operated only from the type of power source indicated on the marking label. If you are not sure of the type of power supply to your home, consult your product dealer or local power company. For products intended to operate from battery power, or other sources, refer to the operating instructions.

12. Grounding or Polarization - This product may be equipped with a polarized alternating-current line plug (a plug having one blade wider than the other). This plug will fit into the power outlet only one way. This is a safety feature. If you are unable to insert the plug fully into the outlet, try reversing the plug. If the plug should still fail to fit, contact your electrician to replace your obsolete outlet. Do not defeat the safety purpose of the polarized plug.

Alternate Warnings - This product is equipped with a three-wire grounding-type plug, a plug having a third (grounding) pin. This plug will only fit into a grounding-type power outlet. This is a safety feature. If you are unable to insert the plug into the outlet, contact your electrician to replace your obsolete outlet. Do not defeat the safety purpose of the grounding-type plug.

13. Power-Cord Protection - Power-supply cords should be routed so that they are not likely to be walked on or pinched by items placed upon or against them, paying particular attention to cords at plugs, convenience receptacles, and the point where they exit from the product.

14. Protective Attachment Plug - The product is equipped with an attachment plug having overload protection. This is a safety feature. See Instruction Manual for replacement or resetting of protective device. If replacement of the plug is required, be sure the service technician has used a replacement plug specified by the manufacturer that has the same overload protection as the original plug.

15. Outdoor Antenna Grounding - If an outside antenna or cable system is connected to the product, be sure the antenna or cable system is grounded so as to provide some protection against voltage surges and built-up static charges. Article 810 of the National Electrical Code, ANSI/NFPA 70, provides information with regard to proper grounding of the mast and supporting structure, grounding of the lead-in wire to an antenna discharge unit, size or grounding conductors, location of antenna-discharge unit, connection to grounding electrodes, and requirements for the grounding electrode.

16. Lightning - For added protection for this product during a lightning storm, or when it is left unattended and unused for long periods of time, unplug it from the wall outlet and disconnect the antenna or cable system. This will prevent damage to the product due to lightning and power-line surges.

17. Power Lines - An outside antenna system should not be located in the vicinity of overhead power lines or other electric light or power circuits, or where it can fall into such power lines or circuits. When installing an outside antenna system, extreme care should be taken to keep from touching such power lines or circuits as contact with them might be fatal.

18. Overloading - Do not overload wall outlets, extension cords, or integral convenience receptacles as this can result in a risk of fire or electric shock.

19. Object and Liquid Entry - Never push objects of any kind into this product through openings as they may touch dangerous voltage points or short-out parts that could result in a fire or electric shock. Never spill liquid of any kind on the product.

20. Servicing - Do not attempt to service this product yourself as opening or removing covers may expose you to dangerous voltage or other hazards. Refer all servicing to qualified service personnel.

21. Damage Requiring Service - Unplug this product from the wall outlet and refer servicing to qualified service personnel under the following conditions:

- a. When the power-supply cord or plug is damaged.
- b. If liquid has been spilled, or objects have fallen into the product.
- c. If the product has been exposed to rain or water.
- d. If the product does not operate normally by following the operating instructions. Adjust only those controls that are covered by the operating instructions as an improper adjustment of other controls may result in damage and will often require extensive work by a qualified technician to restore the product to its normal operation.
- e. If the product has been dropped or damaged in any way, and
- f. When the product exhibits a distinct change in performance - this indicates a need for service.

22. Replacement Parts - When replacement parts are required, be sure the service technician has used replacement parts specified by the manufacturer or have the same characteristics as the original part. Unauthorized substitutions may result in fire, electric shock, or other hazards.

23. Safety Check - Upon completion of any service or repairs to this product, ask the service technician to perform safety checks to determine that the product is in proper operating condition.

24. Wall or Ceiling Mounting - The product should be mounted to a wall or ceiling only as recommended by the manufacturer.

25. Heat - The product should be situated away from heat sources such as radiators, heat registers, stoves or other products (including amplifiers) that produce heat.

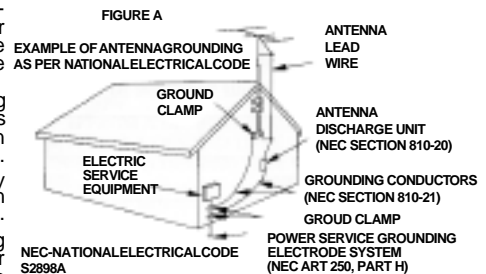

Introduction

Your Yakumo DVD Record Master XL Design combines the functionalities of a DVD player and recorder. As a DVD player, you will be able to enjoy full length movies with true cinema picture quality, and stereo or multichannel sound (depending on the disc and your playback system). A wide of disc formats are readable marked as the opposite. Unique features of this player include component video & S-video outputs, progressive scan for greater picture clarity.

What's more, as a DVD Video Recorder, it has some of the key features that allow you to record programs conveniently such as:

- A complete DVD+RW/DVD+R recorder.
- Preset recording
- Playback of pre-recorded or user-recorded DVDs and CDs
- View, edit and play from a pre-recorded DVD+RW.



UNPACKING

When shipping the player, the original shipping carton and packing comes in handy. For maximum protection, re-pack the unit as it was originally packed at the factory. It is normal for your changer tray to partially open after you have unpacked the unit. This is a feature designed to allow easier access to disc inside the tray during diagnostics.

First check and identify the contents of your player package, as listed below:

- Yakumo DVD Record Master XL
- Remote control
- Audio cable
- Video cable
- Scart cable
- Owner's Manual
- Size AAA batteries (2)

If any item should be damaged or missing, please inform your supplier without delay. Keep the packaging materials as you may need them to transport your player in the future.

WHERE TO PLACE YOUR DVD RECORDER

1. Place the unit on a firm, flat surface.
2. When you place this player near a radio or VCR the playback picture may become poor and/or distorted. In this situation, move the DVD video player away from the other units.
3. Keep away from direct sunlight & domestic heating equipment.
4. If placed in a cabinet, please allow at least 2.5 cm (1 inch) of free space around the player for proper ventilation.

TO OBTAIN A CLEAR PICTURE

This player is a high-tech, precision device. If the optical pick-up lens and disc drive parts are dirty or worn down, the picture quality will become poor. To obtain a clear picture, we recommend regular inspection and maintenance (i.e. cleaning or parts replacement) every 1,000 hours of use depending on the operating environment. For details, please contact your nearest dealer.

Table of Contents

Safety Precautions.....	1	KODAK Picture CD / JPEG / MP3 Playback..	25
Safety Information	2	Using the On-screen Display.....	27
Introduction.....	3	Setting the Parental Lock.....	28
Table of Contents	4	Customizing DVD Function Settings..	29
Identification of Controls.....	5	Recording Options	30
Connection	7	Channel Search	30
MP3, Progressive Scan.....	12	Normal Recording	31
Playing Back a Disc	13	One-Touch Record	32
Playing a Normal Disc	13	Time Record	33
Playing a DVD+RW or DVD+R Disc..	14	Editing	34
General Features	16	Editing a Title of DVD+RW	34
Locating a Specific Title, Chapter or Track.....	18	Editing a Disc of DVD+RW or DVD+R..	37
Playing Repeatedly.....	20	Specifications	39
Playing in Random Order.....	21	Trouble Shooting Guide	40
Selecting Camera Angles, Languages & Audio Settings	22	Attachment	41
Playing in a Favorite Order	23		
Selecting Subtitles	24		

Identification of Controls

FRONT PANEL

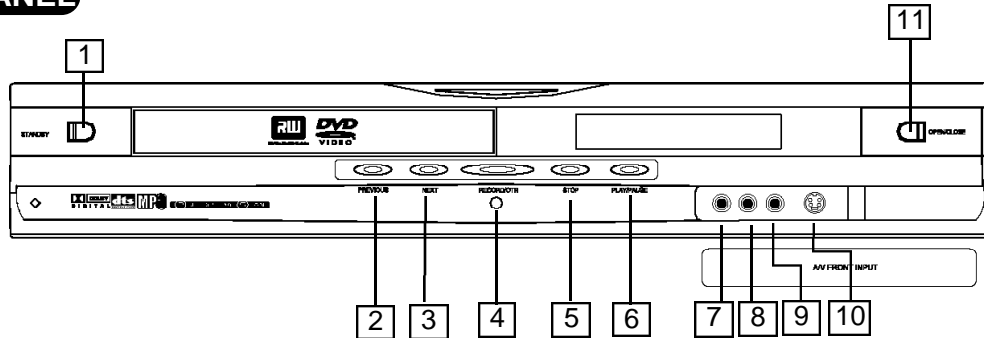

- | | | | |
|---|------------|----|-------------------------------|
| 1 | STANDBY | 7 | AUDIO INPUT (FRONT LEFT) |
| 2 | PREVIOUS | 8 | AUDIO INPUT (FRONT RIGHT) |
| 3 | NEXT | 9 | COMPOSITE VIDEO INPUT (FRONT) |
| 4 | RECORD/OTR | 10 | S-VIDEO INPUT (FRONT) |
| 5 | STOP | 11 | OPEN/CLOSE |
| 6 | PLAY/PAUSE | | |

REAR PANEL

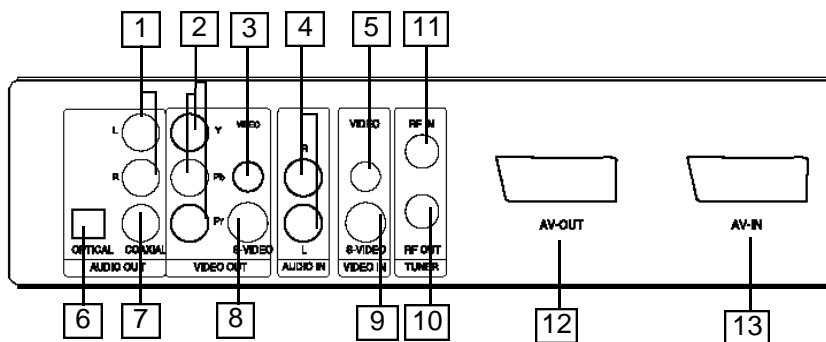

- | | | | |
|---|-------------------------------|----|-----------------------------|
| 1 | AUDIO OUTPUT | 7 | DIGITALAUDIO-COAXIAL OUTPUT |
| 2 | COMPONENT VIDEO OUTPUT | 8 | S-VIDEO OUTPUT |
| 3 | COMPOSITE VIDEO OUTPUT | 9 | S-VIDEO INPUT (REAR) |
| 4 | AUDIO INPUT (REAR LEFT/RIGHT) | 10 | RF SIGNAL OUTPUT |
| 5 | COMPOSITE VIDEO INPUT (REAR) | 11 | RF SIGNAL INPUT |
| 6 | DIGITALAUDIO-OPTICAL OUTPUT | 12 | SCART TERMINAL (AV-OUT) |
| | | 13 | SCART TERMINAL (AV-IN) |

Identification of Controls

REMOTE CONTROL

THE INSTRUCTIONS BELOW DESCRIBE THE FUNCTIONS OF THE REMOTE CONTROL.

- | | |
|--|-----------------|
| 1. STANDBY | 19. FORWARD |
| 2. MUTE | 20. SLOW |
| 3. I/P
(INTERLACE/PROGRESSIVE) | 21. SETUP |
| 4. RANDOM | 22. OPEN/CLOSE |
| 5. REPEAT | 23. NUMBERS |
| 6. ADD/CLEAR | 24. TITLE |
| 7. DIRECTION
(UP/DOWN/LEFT/RIGHT) | 25. GOTO |
| 8. SELECT | 26. RETURN |
| 9. EDIT | 27. PLAY |
| 10. INPUT | 28. STOP |
| 11. REC/OTR
(RECORD/ONE-TOUCH RECORD) | 29. CHANNEL -/+ |
| 12. DISC OPERATION | 30. VOLUME -/+ |
| 13. TIMER | 31. MENU |
| 14. PREVIOUS | 32. SUBTITLE |
| 15. NEXT | 33. PAUSE/STEP |
| 16. ANGLE | 34. DISPLAY |
| 17. AUDIO | 35. NAVIGATION |
| 18. REVERSE | |

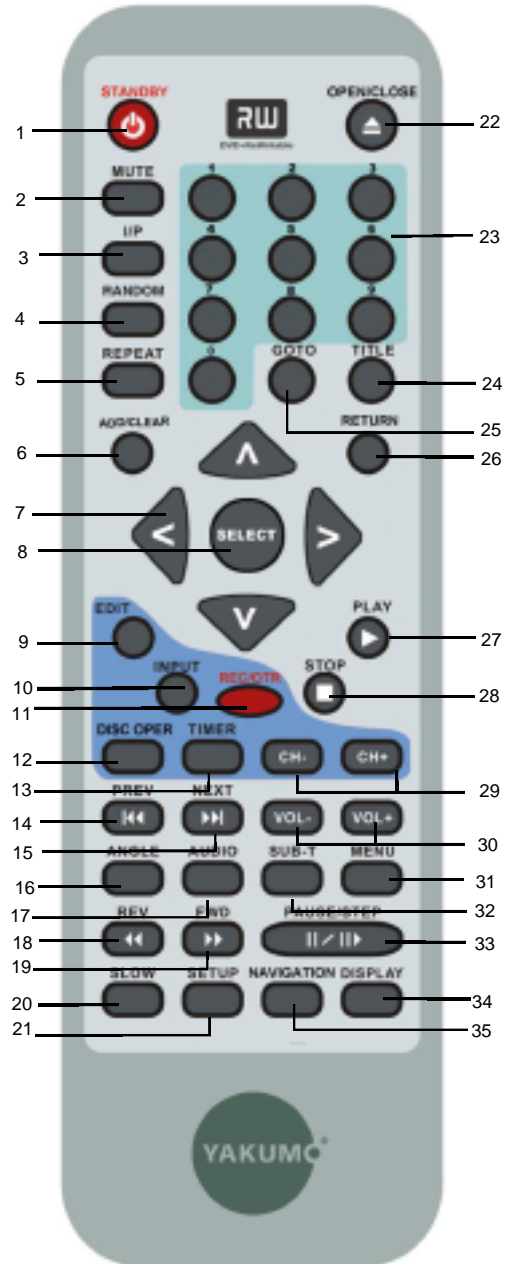

Connection

CONNECTION FOR AUDIO OUTPUT

Dolby Pro Logic Surround Sound (GOOD)

Enjoy Dolby Pro Logic Surround by connecting an amplifier and speaker system (right and left front speakers, a center speaker, and one or two rear speakers).

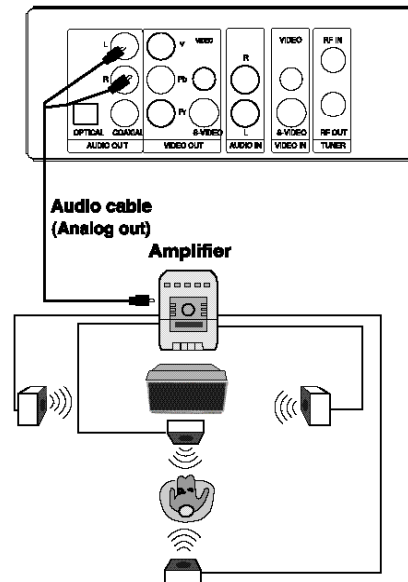

Enjoying Digital Stereo Sound (BETTER)

Enjoy the dynamic sound of Digital Stereo by connecting an amplifier equipped with a digital audio input and speaker system.

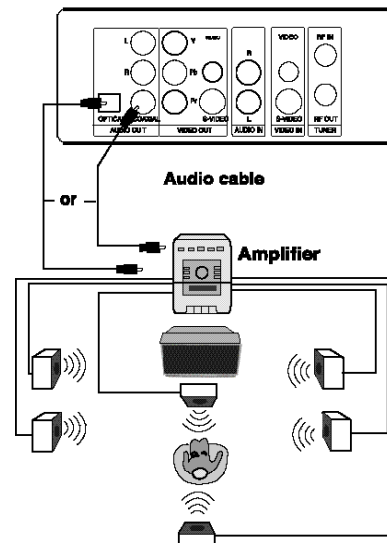

Connection

CONNECTION FOR VIDEO OUTPUT

GOOD

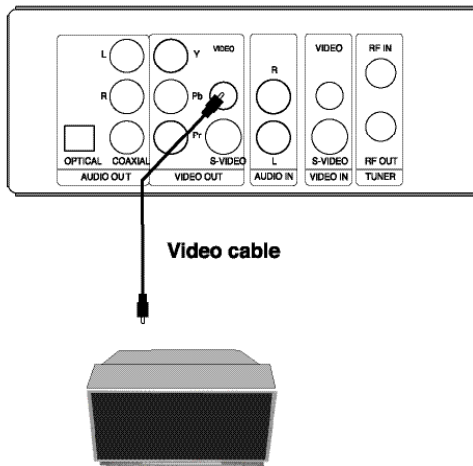

BETTER

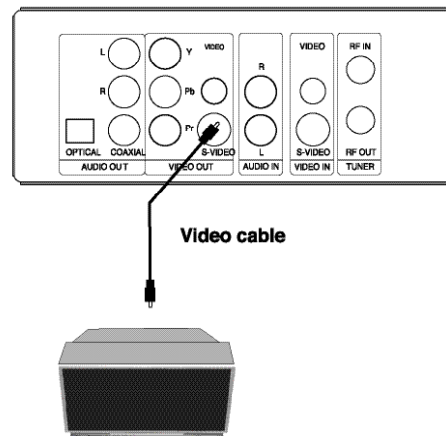

Connect your recorder with the S-Video cable, if the TV has an S-Video input. Do not connect the yellow video cable if using the S-Video cable.

COMPONENT VIDEO OUTPUT (BEST)

The Component Video input allows you to enjoy the best picture quality from a DVD video disc.

Connect your recorder with Y Video, Pr Video and Pb Video, if TV has Progressive Scan or Component Video Input.

During stop status, press I/P button on remote control unit to switch between Progressive Scan or Interlace Scan, or switch these two modes in General Setup from the Setup Menu.

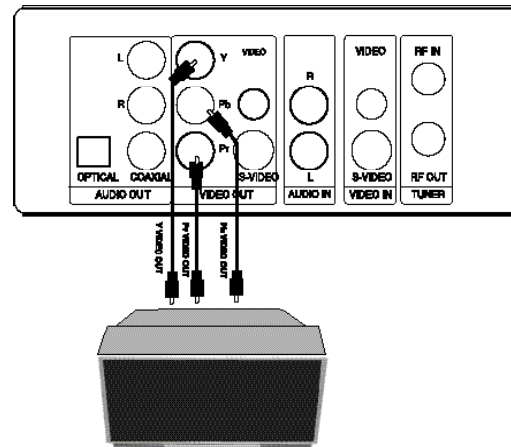

Connection

CONNECTION FOR TV TUNER

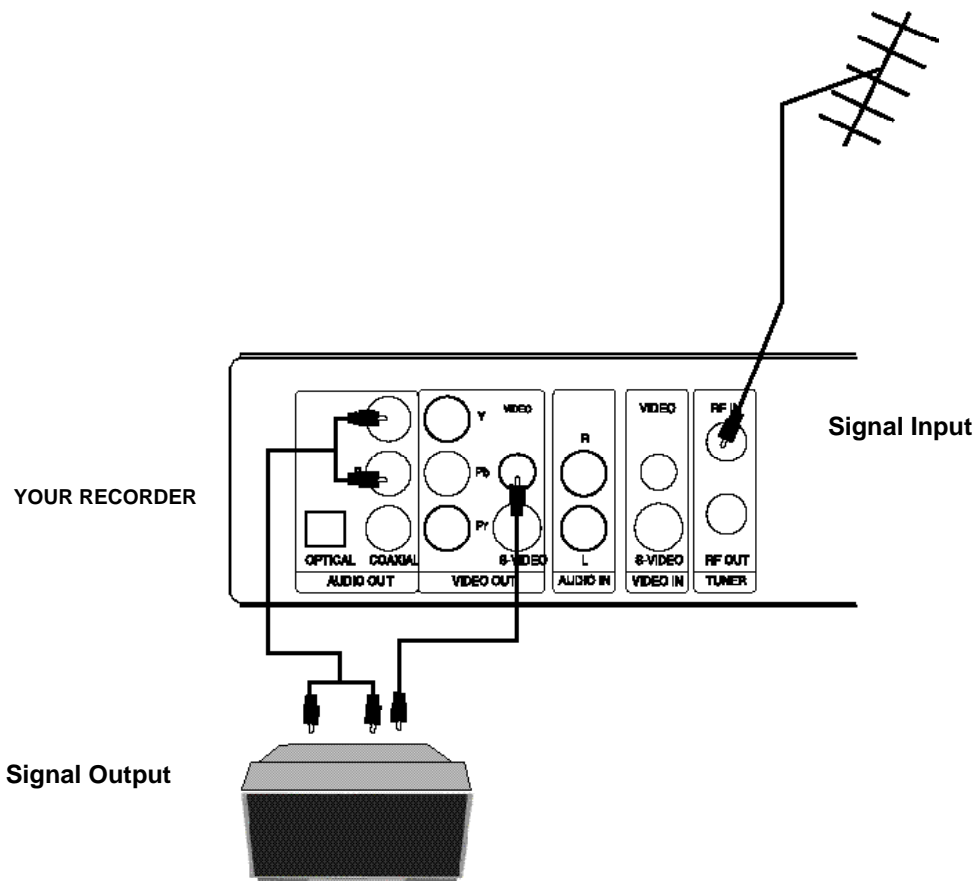

NOTE

- Refer to the manual of the connected TV.
- Turn off the power and unplug both units before setting up any connections.
- RF out is signal pass-thru ONLY. Use A/V, S-Video, or Component outputs for playback. For TV without A/V inputs, an RF Modulator will be required.

Connection

THE YAKUMO DVD RECORD MASTER XLALLOWS YOU TO ENJOY OR RECORD PROGRAMS WITH SIGNAL FROM AV SYSTEMS SUCH AS VCR, DVD PLAYER, ETC.

CONNECTION FOR AV SIGNAL (AV REAR INPUT)

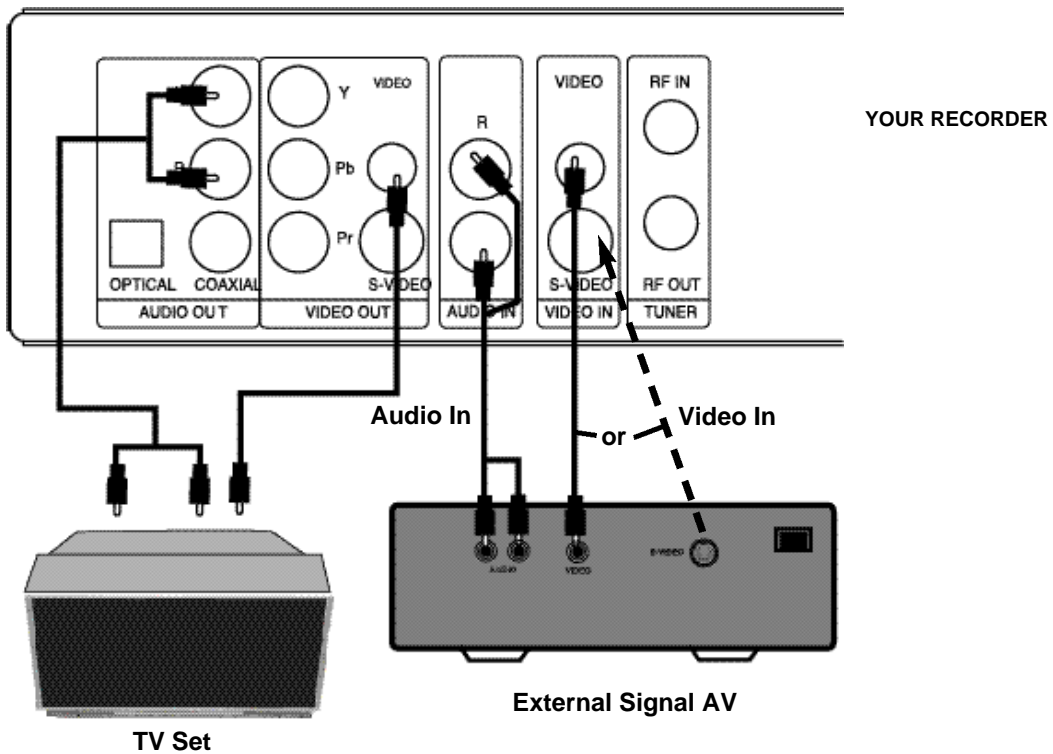

Connect your recorder with the S-Video cable, if the Signal Source has an S-Video input. Do not connect the yellow video cable if using the S-Video cable.

NOTE

- Refer to the manual of the connected system.
- Turn off the power and unplug both units before setting up any connections.

Connection

CONNECTION FOR AV SIGNAL (A/V FRONT INPUT)

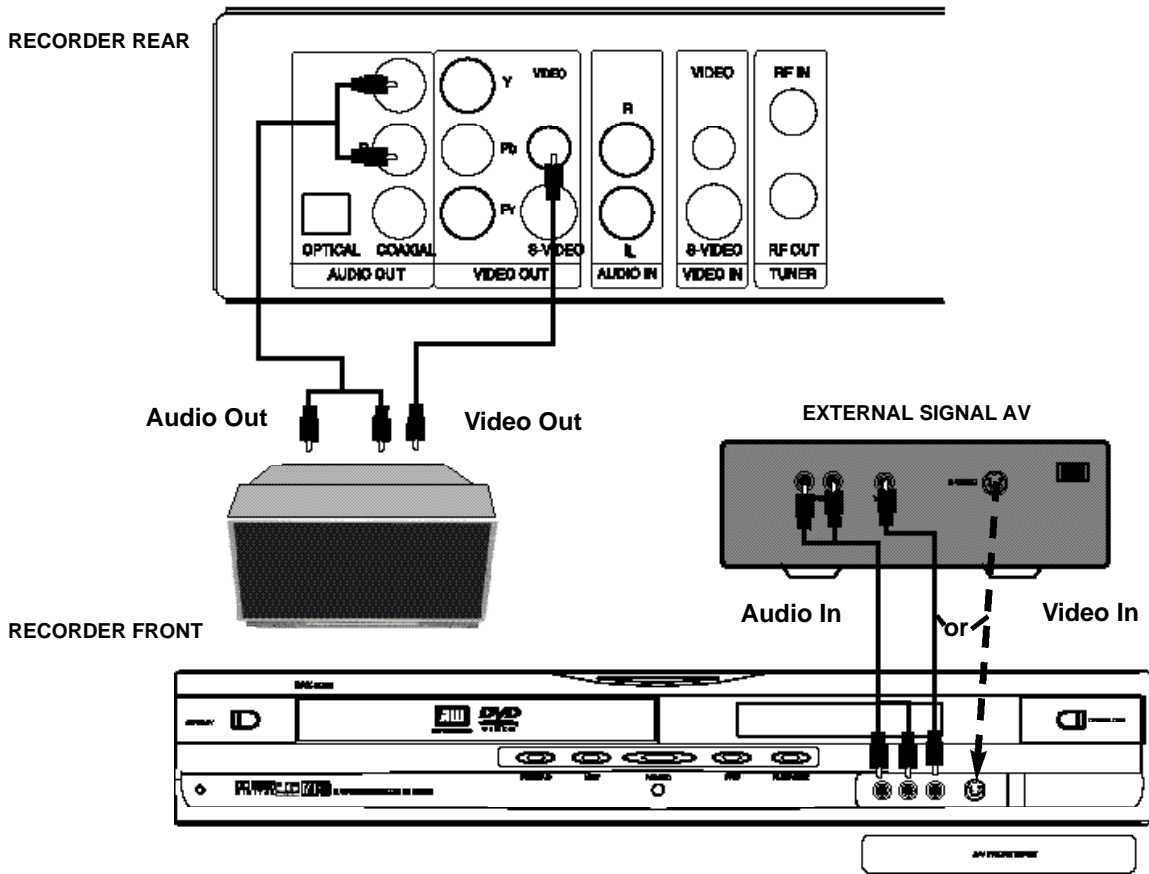

Connect your recorder with the S-Video cable, if the Signal Source has an S-Video input. Do not connect the yellow video cable if using the S-Video cable.

NOTE

- Refer to the manual of the connected system.
- Turn off the power and unplug both units before setting up any connections.

MP3 & Progressive Scan

WHAT IS MP3?

MP3 refers to a new format of music files available for playback over the internet. The popularity of MP3 allows people to download music from MP3 websites onto ones home computer.

WHAT IS PROGRESSIVE SCAN?

Progressive Scan creates a picture with double the scan lines of traditional component video pictures and creates a sharper image. The advantages of progressive scan video output are reduced picture flickering and motion artifacts as well as a sharper image on large screens.

This product incorporates copyright protection technology that is protected by method claims of certain U.S. patents and other intellectual property rights owned by Macrovision Corporation and other rights owners. Use of this copyright protection technology must be authorized by Macrovision Corporation, and is intended for home and other limited viewing uses only unless otherwise authorized by Macrovision Corporation. Reverse engineering or disassembly is prohibited.

"DTS" and "DTS Digital Out" are trademarks of Digital Theater Systems, Inc.

Manufactured under license from Dolby Laboratories. "Dolby" and the double-D symbol are trademarks of Dolby Laboratories. Confidential Unpublished works. © 1992-1997 Dolby Laboratories, Inc. All rights reserved.

It is forbidden by law to copy, broadcast, show, broadcast on cable, play in public, and rent copyrighted material without permission. DVD video discs are copy protected, and any recordings made from these discs will be distorted.

Playing Back a Disc

PLAYING A NORMAL DISC

1. Power on your recorder.
2. Insert a DVD disc.
3. Press direction keys or the number buttons to select the title.

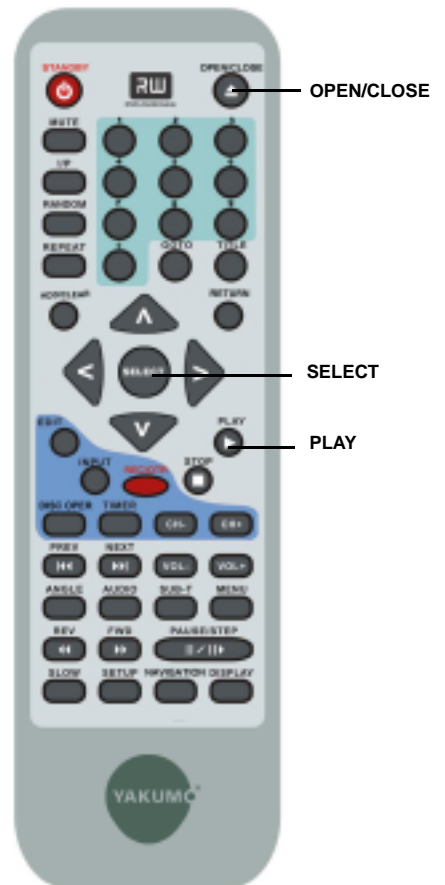
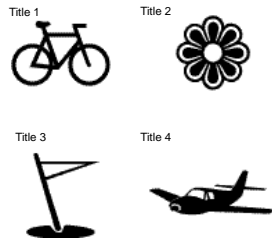

4. Press the **SELECT** or **PLAY** button.
The DVD video player will start playback from the title selected.

5. To remove the disc, press the **OPEN/CLOSE** button.

Playing Back a Disc

PLAYING A DVD+RW OR DVD+R DISC

Index Picture Screen

The Index Picture Screen displays six thumbnails arranged in a 2x3 grid. Each thumbnail is accompanied by its title, date and time, and quality. At the bottom of the screen are two buttons labeled 'PREV' and 'NEXT'.

Thumbnail	Title	Date and Time	Quality
1.	1. TITLE	01/01/00-12:14PM	SP 00:00:20
2.	2. TITLE	01/01/00-12:14PM	HQ 00:00:20
3.	3. TITLE	01/01/00-12:14PM	SLP 00:00:20
4.	4. TITLE	01/01/00-12:14PM	HQ 00:00:20
5.	5. TITLE	01/01/00-12:14PM	SP 00:00:20
6.	6. TITLE	01/01/00-12:14PM	EP 00:00:20



- 1. _____ 1. TITLE
- 2. _____ 01/01/00-12:14PM
- 3. _____ SP 00:00:20
- 4. _____

Description:

- 1. The name of the pre-recorded. The default is TITLE.
- 2. The date and time of the record.
- 3. The quality.
- 4. Length of the record

1. Power on your recorder.

2. Insert a DVD+RW or DVD+R disc.

The index pictures will appear on the screen as above.

Playing Back a Disc

PLAYING A DVD+RW OR DVD+R DISC

3. Press the OPEN/CLOSE button

This will open the disc tray and allow for the placement of a playable disc with the playback side down.

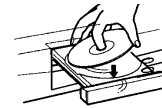

4. Use direction keys (UP/DOWN/RIGHT/LEFT) to highlight the item you desired.

5. Press SELECT or PLAY to start playback of the title you selected.

When **PREV** is highlighted, press **SELECT**, the previous index pictures will display on the screen. When it reaches the first one, if press **PREV** again, the Index Picture Screen can only be updated.

When **NEXT** is highlighted, press **SELECT**, the next index pictures will display on the screen. When it reaches the last one, if press **NEXT** again, the Index Picture Screen can only be updated.

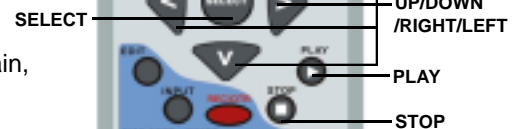

6. Stop playback

Press the **STOP** button once to stop the player; press the **PLAY** button to resume playing.

To playback from the start, press the **STOP** button twice then press the **PLAY** button.

Note:

- After finishing playback of all titles contained on a DVD+RW or DVD+R disc, it will return to the Index Picture Screen.

Playing Back a Disc

GENERAL FEATURES

All playback operation can be realized by the navigation.
During playback, press **NAVIGATION** to access the control bar:

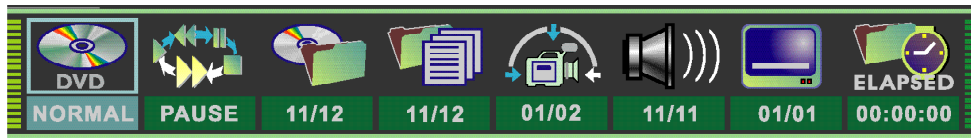

Control bar is a collection of icons. Those icons are presentations of commands or information that needed to finish a function. The details of every functions see below:

Press **RIGHT/LEFT** to highlight one icon and press **SELECT** to enter it, press **UP/DOWN** to select a item, press **SELECT**.

Press **NAVIGATION** again to cancel the control bar.



Playback mode Set your preferable playback mode such as PROGRAM, RANDOM and various repeat mode.

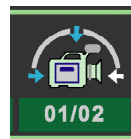

Angle Select your desired camera angle, if available.



Playback control Control playback by various setting such as FAST FORWARD, FAST REVERSE, PAUSE, STOP, etc.



Audio Select your desired audio setting, if available.



Title Select to choose an available title by inputting numbers.



Subtitle Select to choose an available subtitle by inputting numbers.

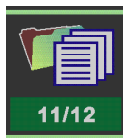

Chapter Select to choose an available chapter by inputting numbers.

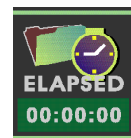

Timer Goto the point you want to start from by inputting the time.

Playing Back a Disc

GENERAL FEATURES

1. Fast forward playback

Press ►► during normal playback.

The speed will cycle with each press as: FF2, FF4, FF16, FF32 or play.

Press **PLAY** to resume normal playback.

2. Fast reverse playback

Press ◀◀ during normal playback.

The speed will cycle with each press as: FR2, FR4, FR16, FR32 or play.

Press **PLAY** to resume normal playback.

3. Pause playback

Press **PAUSE/STEP** during normal playback to pause playback and press **PLAY** to resume normal playback.

4. Frame advance

Press **PAUSE/STEP** during normal playback.

One frame is advanced each time you press **PAUSE/STEP**.

Press **PLAY** to resume normal playback.

5. Slow

Press the **SLOW** button during playback

The playback speed becomes 1/2, 1/4, 1/8 of the normal speed or normal play each time you press the SLOW button.

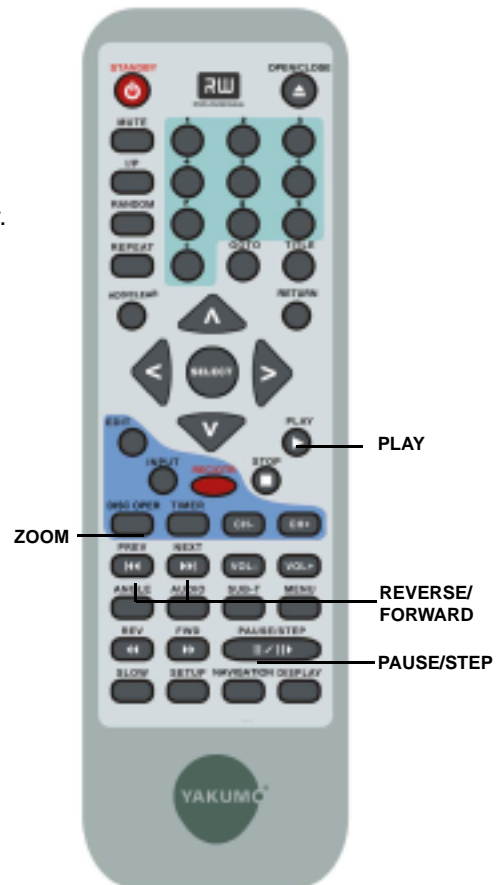

Note:

The above features vary depending on the disc type such as MP3, Audio CD, DVD+RW/DVD+R etc.

Locating a Specific Title, Chapter or Track

DVD VIDEO DISCS ARE NORMALLY DIVIDED INTO TITLES AND SUB-DIVIDED INTO CHAPTERS. SIMILARLY, CD'S (AUDIO, HDCD, and MP3) ARE DIVIDED INTO TRACKS. YOU CAN CONVENIENTLY LOCATE ANY SPECIFIC TITLE, CHAPTER, OR TRACK WITH THIS DVD PLAYER.

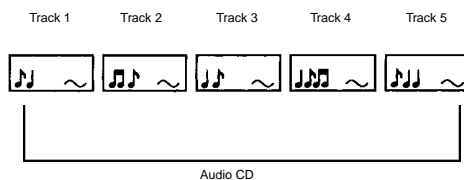
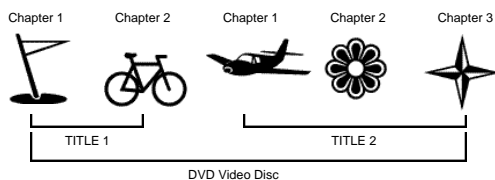

LOCATING A TITLE USING THE TITLE MENU

You can locate a specific title using the title menu function, if a DVD video disc contains a title menu.

1. Press the TITLE button

On the TV screen, the title menu will appear.

2. Press the $\wedge/\vee/\langle/\rangle$ button to select the title you want

3. Press the SELECT button

This will cause the DVD video player to start playback from chapter 1 of the title selected .

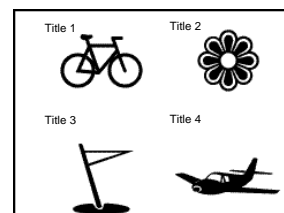

Example of a title menu.

NOTICE

- There are some disc that does not respond to this function.
- If different instructions appear on the TV screen, follow those instructions. The instructions above are describe the basic procedure, but procedures may vary depending on the contents of the DVD video disc.

LOCATING A SPECIFIC CHAPTER OR TRACK

This player allows you to locate consecutive chapters or tracks.

Press the SKIP \lll or \ggg button repeatedly to display the requested chapter or track

The player starts playback from the selected chapter or track.

PREV NEXT



How to locate proceeding chapters or tracks

- When you press the **SKIP \lll** button, the player starts playback from the beginning of the preceding chapter or track.

How to locate succeeding chapters or tracks

- When you press the **SKIP \ggg** button, the player starts playback from the beginning of the succeeding chapter or track.

Notice: On some discs the titles may not display the sub-divided chapters.

Locating a Specific Title, Chapter or Track

LOCATING A TITLE

If a DVD video disc contains title numbers, you can locate a specific title by directly selecting a title number.

1. Press **GOTO** during playback.

The control bar will display on the screen.

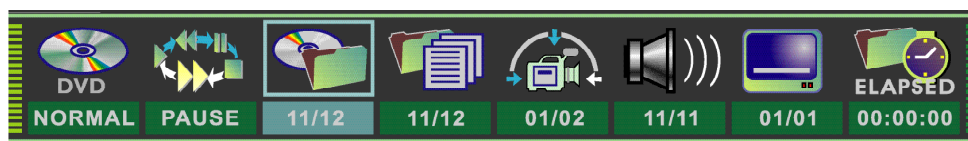

2. With the icon  highlighted, input the number of a available title, then press **SELECT** to confirm it.

e.g. To select title 2

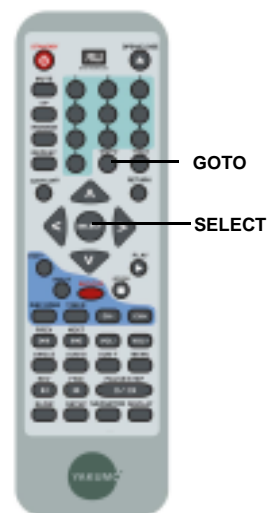
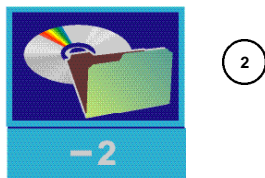

3. To select your desired chapter, press **GOTO** to highlight the icon , and input the number of a available chapter, then press **SELECT**.

4. If you want to start playback from some point, press **GOTO** to highlight the icon , and input the time, then press **SELECT**.

Note:

- The function is invalid on MP3 disc.
- For CD disc, GOTO is used for track/ time selection.
- For DVD+RW/+R, it cannot function by time searching.

Playing Repeatedly

THIS RECORDER ALLOWS YOU TO PLAYBACK A SPECIFIC TITLE, CHAPTER, TRACK, OR SEGMENT REPEATEDLY. (TITLE REPEAT, CHAPTER/TRACK REPEAT, A-B REPEAT)

HOW TO REPEAT A TITLE, CHAPTER, OR TRACK

1. Press the **REPEAT** button during playback.
The repeat mode changes, each time you press the **REPEAT** button.

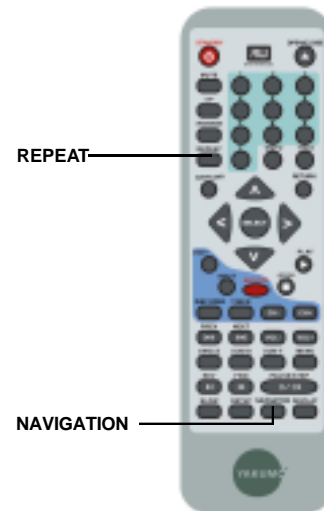
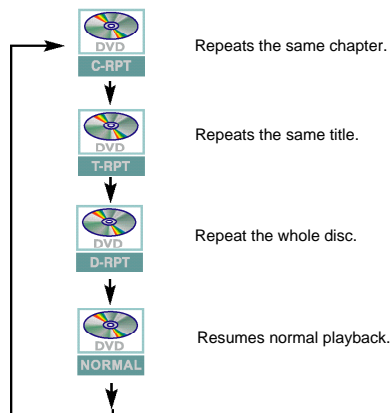

HOW TO REPEAT A SPECIFIC SEGMENT

1. Press **NAVIGATION** to access the control bar.

2. Highlight  by pressing **RIGHT/LEFT**, press **SELECT**.

3. Use **UP/DOWN** to select **A-B** and press **SELECT** at the beginning of the segment in which you want to repeat playback (point A).

2. Press **SELECT** again at the end of the segment (point B)

The player will automatically return to point A and start to repeat playback of the selected segment (A-B).

3. Highlight  by pressing **RIGHT/LEFT**, press **SELECT**.

Use **UP/DOWN** to select **NORMAL** and press **SELECT** to resume normal playback.

Note:

- There are two repeat modes for MP3/CD disc. On CD disc, they are track repeat and disc repeat, and on MP3 disc, they are repeat song and repeat directory.

Playing in Random Order

THIS RECORDER ALLOWS YOU TO PLAYBACK TITLES, CHAPTERS WITHIN A TITLE, OR TRACKS IN RANDOM ORDER.

PLAYING TITLES IN RANDOM ORDER

1. During normal playback press the RANDOM button.

The player will start random playback now.

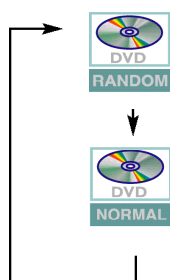

2. Press RANDOM again to resume normal playback.



Note:

- The player will go to another chapter or track and start playback, if you press the **SKIP** button **▶▶** , **◀◀** during random playback.
- When MP3/CD disc is played back, the display icon is different from each other.

Selecting Camera Angles, Languages & Audio Settings

THIS RECORDER ALLOWS YOU TO SELECT FROM SEVERAL DIFFERENT ANGLES AND LANGUAGES.

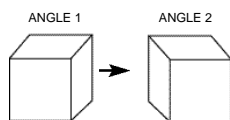

Selecting the camera angle

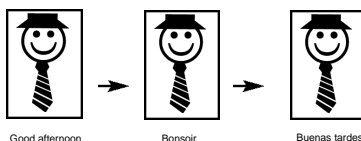

Selecting a language



HOW TO CHANGE THE CAMERA ANGLE

If the video on the DVD was recorded with multiple angles, you have the option to change the camera angle of the scene you are watching.

Press the ANGLE button while playing back a scene recorded with multiple angles.

- You may only press the **ANGLE** button when the angle icon  is shown on the DVD display.
- Each time you press the **ANGLE** button, the angle will change.



Note:

- The angle function will not work on DVD video discs that does not contains recorded multiple angles.
- During still playback, you are able to change the camera angle. When you resume to normal playback, the camera angle changes to the new settings.
- The angle icon indicator will illuminate while playing back a title that contains at least one scene recorded from multiple angles.

HOW TO SELECT A LANGUAGE & PLAYBACK AUDIO SETTING

This player allows you to select a preferred language and sound recording system from those included on the DVD video disc.

1. Press the **AUDIO** button during playback
2. Press the **AUDIO** button repeatedly to cycle through the options



Note:

- The player returns to the initial default settings when you turn on the player or replace a disc.
- The player plays a default sound when unsupported format is selected.
- On MP3/CD disc, AUDIO is used for the selection of LEFT, RIGHT and STEREO.

Playing in a Favorite Order

THIS PLAYER ALLOWS YOU TO PROGRAM UP TO 99 ITEMS INTO MEMORY AND THEN PLAY THEM BACK IN THAT ORDER. (PROGRAM/PLAYBACK)

HOW TO SET TITLES, CHAPTERS, OR TRACKS IN A FAVORITE ORDER

1. Press **NAVIGATION** to access the control bar.
2. Highlight  by pressing **RIGHT/LEFT**, press **SELECT**.
3. Use **UP/DOWN** to select **PROG** and press **SELECT**, two volumes will appear on the screen.

- The left volume displays all titles available on the disc.

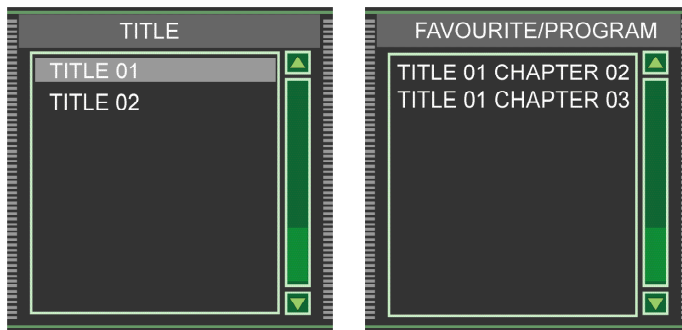

NAVIGATION



- The right volume allows you to edit titles in your favorite order.

2. In the left volume, use **UP/DOWN** to select one title, and press **ADD/CLEAR** to add it to the right volume.

You can also select one chapter by pressing **SELECT** after highlighting the title.

3. To clear one title you have added in the right volume, highlight the one and then press **ADD/CLEAR** to clear it. Use **RIGHT/LEFT** to move the cursor between the volumes.

4. Press **RETURN** to return the control bar.

Select  , use **UP/DOWN** to select **NORMAL** and press **SELECT** to

resume normal playback.

Note:

- On the MP3/CD disc, there are some difference on OSD.

Selecting Subtitles

THIS RECORDER ALLOWS YOU TO DISPLAY THE SUBTITLES FROM THOSE INCLUDED ON THE DISC ON TO YOUR TV SCREEN.

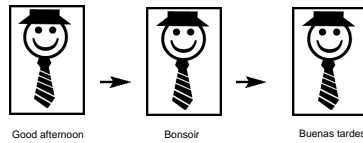

HOW TO DISPLAY SUBTITLES

Press the **SUB-T** button during playback to choose one of the subtitle available on the disc, or turn the subtitle off.

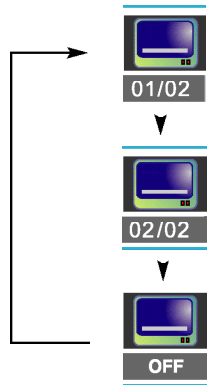

Note:

- Due to the nature of some DVD's, you may not be able to turn off the subtitles as they will appear on screen automatically.
- As you press the SUB-T button, the subtitles may not appear immediately during some scenes.
- If the subtitles continue to show on your TV even after the DVD has been turned off, please check the closed caption settings on your TV.

KODAK Picture CD/JPEG/MP3 Playback

YOU CAN USE YOUR RECORDER TO VIEW PHOTOGRAPHS OR ENJOY SONGS STORED ON A CD-R OR CD-RW DISC. THE PHOTOGRAPHS ON THE DISC NEED TO BE SAVED IN THE JPEG FILE FORMAT. AND THE SONGS SHOULD BE SAVED IN MP3 FORMAT.

JPEG / KODAK Picture CD Playback

1. Press OPEN/CLOSE.

Place the CD on the disc tray, and press it again to close the tray. A menu will soon appear on the screen.

For KODAK picture CD the slide show starts automatically without the menu display.

2. Use direction keys LEFT <, RIGHT > to navigate among the icons and volumes. When the left volume is highlighted, use UP/DOWN to highlight one picture or a folder.

Press PLAY or SELECT to start the slideshow from which picture you highlighted.

Press STOP or PAUSE/STEP on the remote to stop or pause the slideshow.

You can also control the playback by the menu:

Highlight  by press LEFT or RIGHT, press SELECT, then use UP or DOWN to set the three playback modes, PLAY, PAUSE or STOP.



3. To change a slideshow mode, you should first highlight , press SELECT, then use UP or DOWN to select one. There are 17 modes available, such as "From top to down", "From down to top", "From left to right", "From right to left", "Extend from center V", "Extend from Center H", etc.

4. Highlight , press SELECT, use UP or DOWN to select one command:



- NORMAL: Play current list one by one.
- S-RPT: Repeatedly play current item.
- D-RPT: Repeatedly play all the items in current directory.
- PROG: Play the favorite tracks list repeatedly.

Note: You should program in each track first: highlight your desired one in the left volume, press **ADD/CLEAR** to add it to the right volume (FAVORITE/PROGRAM), if you want to remove one in your favorite list, highlight it and press ADD/CLEAR.

- RANDOM: Play items in random mode.

5. To rotate a picture, press the direction buttons UP/DOWN/RIGHT/LEFT, or highlight , press SELECT and then press UP/DOWN to select Rot 0, Rot 90, Rot 180 or Rot 270.



6. To Zoom in/out a picture, press  or , the zoom ranges from 12% to 400%. By the menu, highlight , press SELECT, your can use UP or DOWN to select a zoom rating.



7. For Kodak Picture CD, press MENU/RETURN to access an index thumbnail. Then you can use direction keys to navigate among them.

Note:

In the menu, the icon  shows the played disc belongs to a VIDEO disc.

KODAK Picture CD/JPEG/MP3 Playback

MP3 Playback

1. Press OPEN/CLOSE.

Place the CD on the disc tray, and press it again to close the tray. A menu will soon appear on the screen.

2. Use direction keys LEFT <, RIGHT > to navigate among the icons and volumes. When the left volume is highlighted, use UP/DOWN to highlight one song or a folder.

Press PLAY or SELECT to start the playback from which song file you highlighted.

Press STOP or PAUSE/STEP on the remote to stop or pause the playback.

You can also control the playback by the menu:

Highlight  by press LEFT or RIGHT, press SELECT, then use UP or DOWN to set the three playback modes, PLAY, PAUSE or STOP.

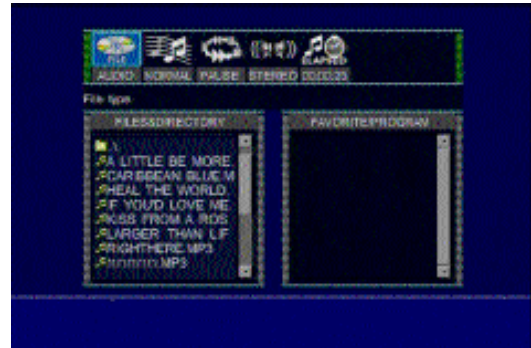

3. To change an audio channel, press AUDIO on the remote, each time you press it, it cycles among LEFT, RIGHT and STEREO.

You can also switch the channel by the menu:

Highlight  by press LEFT or RIGHT, press SELECT, then use UP or DOWN to select it.



4. Highlight , press SELECT, use UP or DOWN to select one command:

- NORMAL: Play current list one by one.
- S-RPT: Repeatedly play current item.
- D-RPT: Repeatedly play all the items in current directory.
- PROG: Play the favorite tracks list repeatedly.

Note: You should program in each track first: highlight your desired one in the left volume, press **ADD/CLEAR** to add it to the right volume (FAVORITE/PROGRAM), if you want to remove one in your favorite list, highlight it and press **ADD/CLEAR**.

- RANDOM: Play items in random mode.

Note:

- In the menu, the icon  shows the played disc belongs to a AUDIO disc.
- And the numbers under the icon  display the elapsed time/remain of the current song. To switch from them, highlight the icon, use UP or DOWN to select the display time.

Using the On-Screen Display

THIS PLAYER ALLOWS YOU TO VIEW STATUS AND DISC INFORMATION ON YOUR TV SCREEN.

CHECKING THE OPERATIONAL STATUS

With this function, you can view on your TV the following information:

- Current title
- Current chapter
- Time elapsed
- Time remain

Press DISPLAY button during DVD playback.



Setting the Parental Lock

YOU CAN USE THE PARENTAL LOCK FUNCTION ONLY WITH DVD'S EQUIPPED WITH THE PARENTAL LOCK FEATURE

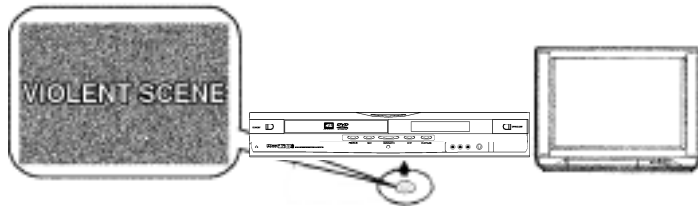

SETTING THE PARENTAL LOCK

DVD equipped with the parental lock function are rated according to their content. The contents allowed by a parental lock level and the way a DVD can be controlled may vary from disc to disc. For example, if the disc allows it, you could edit out violent scenes unsuitable for children and replace them with more suitable scenes, or lock out playback of the disc all together.



1. Press **STOP** button twice during playback.

2. Press **SETUP** during stop status.

3. Highlight the **PLAY** icon by pressing **RIGHT/LEFT**.

The menu appears on the TV screen.

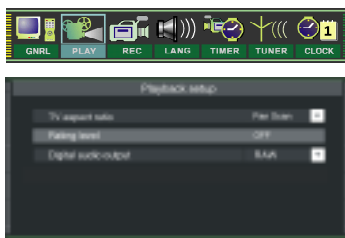

4. Use **UP/DOWN** to select Rating Level, press **SELECT** button.

5. Input your password by numbers, highlight **OK** and press **SELECT**.

The pre-set password is **3308**

6. Press **SELECT**, the sub-menu of Set Rating Level appears, use **UP/DOWN** to select one rating, press **SELECT** to confirm it.

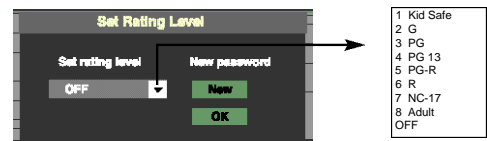

7. Highlight **OK** and press **SELECT** to save your setting.

8. Press **SETUP** button to exit setup, press **PLAY** button to start

TO CHANGE YOUR PASSWORD:

1. Follow step 1-6 to select "New".
2. Enter new password.
3. Re-enter to confirm your new password.
5. Highlight **OK** and press **SELECT** to save it.
6. Press **SETUP** button to exit.

Customizing Function Settings

THIS PLAYER ALLOWS YOU TO CUSTOMIZE THE PERFORMANCE TO YOUR PERSONAL PREFERENCES.

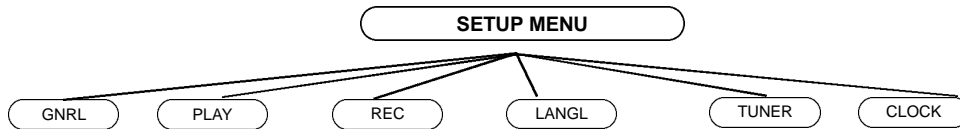

DISPLAYING THE SETUP MENU SCREEN

The SETUP MENU screen asks you to select a setting category from General, Speaker, Audio and Preferences. The selected category will provide you the setting details using the succeeding screen.

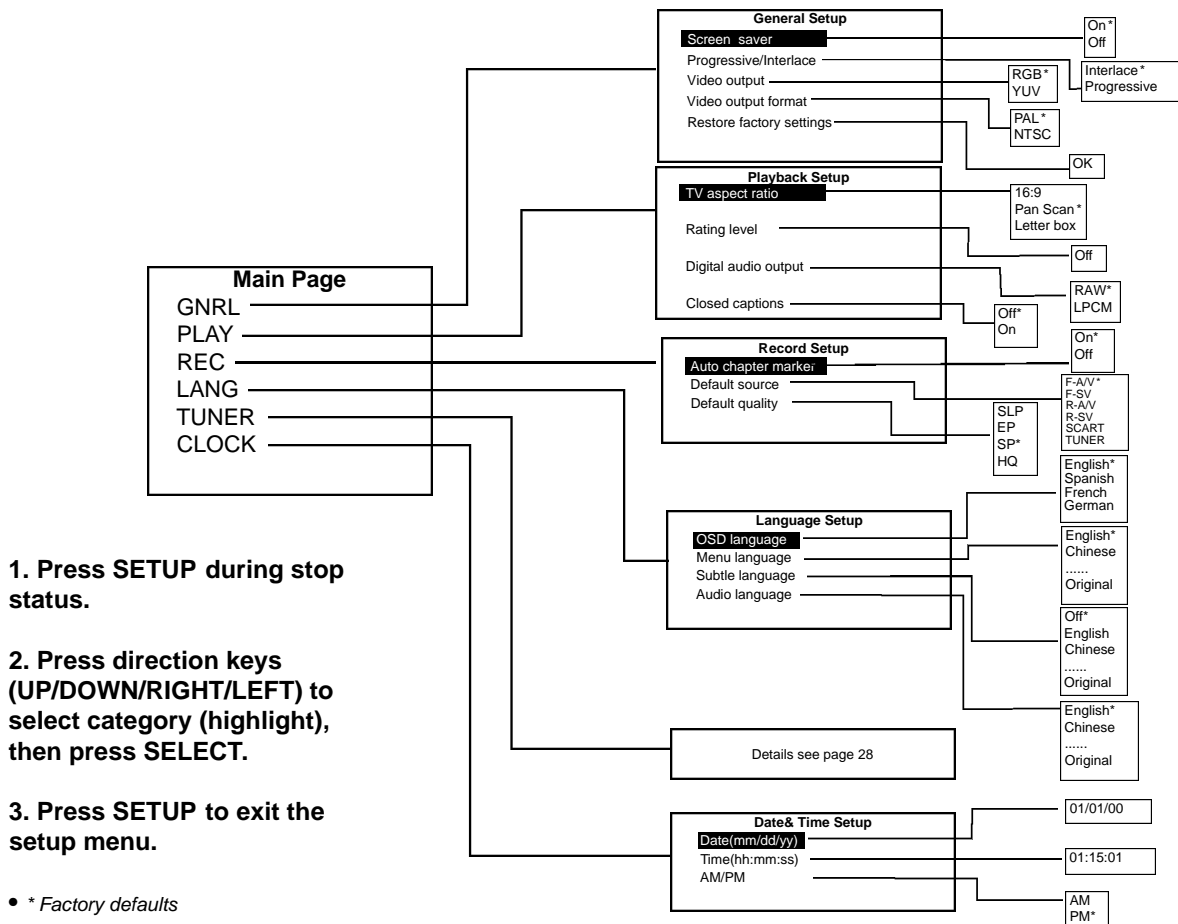

1. Press **SETUP** during stop status.

2. Press direction keys (UP/DOWN/RIGHT/LEFT) to select category (highlight), then press **SELECT**.

3. Press **SETUP** to exit the setup menu.

• * Factory defaults

Recording Options

CHANNEL SEARCH

To record TV programs, you should search TV channels first.

1. Press **SETUP** to access the setup menu.

2. Press **RIGHT/LEFT** to highlight the icon **TUNER** and press **SELECT** to setup it.



3. Press **SELECT** and **UP/DOWN** to choose your desired source: Air or Cable, then press **SELECT** to confirm it.

4. Use the **RIGHT/LEFT** button to highlight **SCAN** and press **SELECT**.

It will search channels automatically.

In the **SKIP** column, The channel cannot be found will be marked.

During auto-searching, press **STOP** to cancel searching.

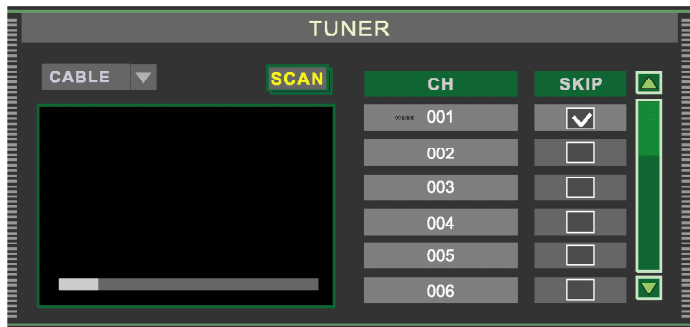

5. To browse the found channels, first press **RIGHT/LEFT** to **CH**, then press **UP/DOWN**, and you can also input numbers and press **SELECT**.

6. If you want to skip one channel, use **UP/DOWN** to highlight the skip space of the corresponding channel, and press **SELECT**.

7. Press **SETUP** again to exit.

CHANNEL EDIT

1. If the picture of the channel scanned is poor, you can use the direction buttons to highlight the channel and press **SELECT**, a sub-menu appears.

2. Use **RIGHT/LEFT** to tune the picture to the best performance.

3. After tune-up, highlight "Confirm" or "Cancel" on the bottom, and press **SELECT** to enter it.

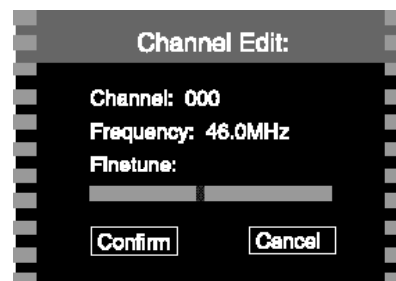

Note:

- Press **RETURN** to return to the main control bar.

Recording Options

NORMAL RECORDING

1. Make connections illustrated as page 9-11.
2. Insert a recordable DVD+RW or DVD+R into the recorder.
3. Select the input source by pressing INPUT, and then press NAVIGATION to display the Control Bar.

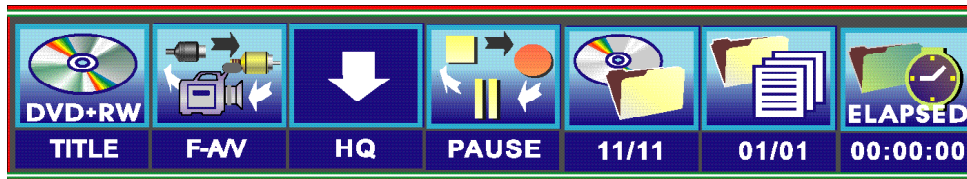

4. Press RIGHT/LEFT to highlight the icon , and press SELECT and UP/DOWN to select the input source which you have connected as step 1.

F-A/V: Front Audio/Video Input (on the front panel)

R-A/V: Rear Audio/Video Input (on the rear panel)

F-SV: Front S-Video Input (on the front panel)

R-SV: Rear S-Video Input (on the rear panel)

AV-IN: Scart Input (on the rear panel)

Each channel (you can select it by pressing CHANNEL+/- or input the assigned number of the channel to select your desired one directly)

5. Press SELECT to confirm your selection.

6. Press RIGHT/LEFT to highlight the icon , and press SELECT and UP/DOWN to select the record quality:

HQ Perfect quality, nearly 64 minutes in a blank disc.

SP Standard Play quality, nearly 130 minutes in a blank disc.

EP Extend Play, nearly 250 minutes in a blank disc.

SLP Standard Long Play, nearly 366 minutes in a blank disc.

After your selection, press SELECT to confirm it.

7. Press RECORD to start recording.

If you want to stop recording, press STOP.

If the DVD+RW or DVD+R is new, it will take about three minutes to stop.

Note:

- It's upto 124 chapters can be recorded on a disc.
- There are 99 chapters in a title at most.

Recording Options

ONE-TOUCH RECORD

1. During normal recording, press **RECORD**, the recorder will auto stop in 30 minutes.
2. The record time will extend for another 30 minutes with each press.
The length of recording time is determined by disc capacity and record quality.
With your setting, if it will exceed the capacity of the disc, OTR will be canceled, and switched to normal record.
3. If you want to stop recording, press **STOP**.

HOW TO SWITCH TO PLAYBAK MODE

When the recording is suspended, you can press **PLAY** to switch to normal playback mode.

CLOCK SETUP

1. During stop status, press **SETUP** to access the Setup Menu.

2. Use **RIGHT/LEFT** to highlight the **CLOCK** icon as the right figure.

3. Use **UP/DOWN** to highlight the Date, Time, and AM/PM respectively.

4. With “Date (mm/dd/yy)” highlighted, press **SELECT**, and input the local date by numbers, press **SELECT** again.

5. With “Time (hh:mm:ss)” highlighted, press **SELECT**, and input the local time by numbers, press **SELECT** again.

6. Highlight **AM/PM**, and press **SELECT**, use **UP/DOWN** to select **AM** or **PM**, press **SELECT** again.

Note:

If you want to cancel input, press **RETURN**.

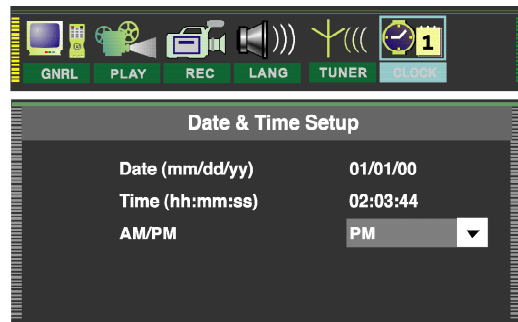

Recording Options

TIMER RECORD

1. First setup the clock of your system as “CLOCK SETUP” on page 30. It is recommended to setup your local date and time.

2. Press **TIMER**, the record scheduler will pop up.

Record scheduler						
NO.	Source	Quality	Date	Start	AM/PM	End
1	R-AV	EP	01/01/00	12:14	PM	12:44
2	F-AV	SP	02/01/00	12:14	PM	12:44
3	R-SV	HQ	03/01/00	12:14	PM	12:44
4						
5						
6						

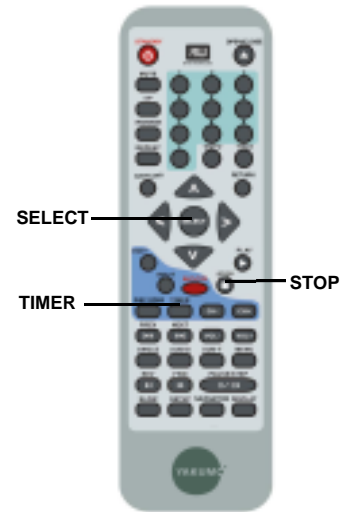

Note:

- If you want to delete a schedule, highlight the one, press **ADD/CLEAR**.

3. Use **UP/DOWN** to select one schedule, and press **SELECT** to access Item Editor as below: In each item you can also use direction keys to highlight and press **SELECT** to choose your desired setting:

- Signal input source, details see page 29, step 4.
- Record quality, details see page 29, step 6.
- Record frequency, once, daily or weekly.
- mm/dd/yy
- Start time for timer recording
- AM/PM selection
- End time for timer recording

Item Editor	
Source	R-AV
Quality	EP
Once	01/01/00
Start	01:44
AM/PM	PM
End	02:14
<div style="display: flex; justify-content: space-around;"> OK Cancel </div>	

4. Select **OK** to save your setting.

5. In five minutes before it is ready to record the scheduled, it appears a Record Prompt dialog, affirm press **OK**, abolish press **CANCEL**, and if without operation for a moment it will record the scheduled automatically.

Note:

- In standby mode, your recorder can wake up in 2 minutes before recording.
- During recording, you can press **STOP** to suspend the recording.
- A DVD+RW/DVD+R can record for upto 366 minutes, upto 48 titles.

Editing

EDITING A TITLE OF DVD+RW

1. Insert a recorded DVD+RW on the disc tray.

The Index Picture Screen pops up.

2. Use the direction keys to highlight the title which you want to edit.

When **PREV** is highlighted, press **SELECT**, the previous index pictures will display on the screen. When it reaches the first one, if press **PREV** again, the Index Picture Screen can only be updated.

When **NEXT** is highlighted, press **SELECT**, the next index pictures will display on the screen. When it reaches the last one, if press **NEXT** again, the Index Picture Screen can only be updated.

On the screen select **PREV/NEXT** to view the previous/next page of titles.

3. Press **EDIT**, the title edit bar appears on the screen while playing back.

Press **RIGHT/LEFT** to highlight one icon and enter it, press **UP/DOWN** to select a sub-item.



View current title / total title



View current chapter / total chapter



Current operation status



Chapter editing Select to add one chapter marker, or delete the current / all chapter markers, details see the next page.



Chapter hide or unhide Select to hide the current chapter,, details see the next page.



Title face or Title name Select to set the current image played back to the face of the title or select to name the current title, details see the next page.



Timer Goto the point you want to start from by inputting the time, details see page 18,24.

4. Press **EDIT** to quit the menu.

Editing

CHAPTER EDITING

From the control bar, select the fourth icon, press UP/DOWN repeatedly, it will cycle as following:



When  is selected by pressing SELECT, a new chapter marker will be added to the current point.

When  is selected by pressing SELECT, the marker of the current chapter will be deleted.

When  is selected by pressing SELECT, all of the chapter markers in the current title will be deleted.

Note:

- From the second icon in the control bar, the above operation can be viewed.
- If only one chapter is available in the current title, there is only  to select.

CHAPTER HIDE OR UNHIDE

From the control bar, select the fifth icon, press SELECT.

When the icon displays C-hide, it shows the current chapter is visible, and you can select it to hide it by pressing SELECT.

When the icon displays C-unhide, it shows the current chapter is invisible, and you can select it to unhide it by pressing SELECT.

Editing

TITLE ICON AND TITLE NAME

From the control bar, select the sixth icon, press UP/DOWN repeatedly, it will cycle as following:



When you want to set the current frame as the icon of the current title which miniature picture will appear in the Index Picture Screen, press SELECT with T-ICON displayed.

You can also rename the current title by selecting , press SELECT with T-NAME displayed. On the screen, there appears a keyboard:



Press the direction keys (UP/DOWN/RIGHT/LEFT) to highlight the one which you want to input, and press SELECT to confirm it.

The control bars of the last line in the keyboard is for edit command.

Select OK to save the name.

Note:

- The maximum length of the title name is up to 9 characters.

Editing

EDITING A DISC OF A DVD+RW

1. Insert a DVD+RW on the disc tray.
2. Press DISC OPER to access the disc editing bar.

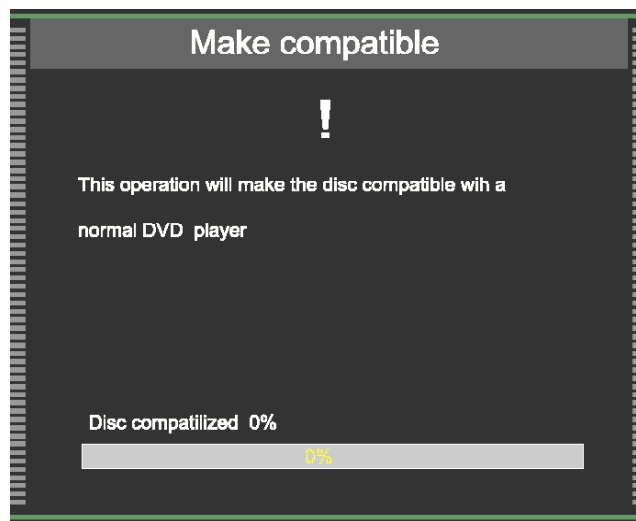

4. With each icon highlighted by pressing RIGHT/LEFT, the corresponding description of each operation will display on the screen, such as Disc Finalization, Delete title, Erase disc, Disc protection, etc.
5. Press SELECT to run the operation.

Editing

EDITING A DISC OF A DVD+RW OR DVD+R



This icon is selected to view the disc information.



FINALIZE DISC (DVD+R only)

Highlight the icon and press **SELECT**. It will take a few minutes to finalize the disc.

Note:

If a DVD+R has been finalized, you can not record or edit the DVD+R any more.

If you want to make your disc compatible with the other DVD player, you should go on FINALIZE operation.



T-DEL (DVD+RW only)

When this icon is selected, it will delete the last title.



ERASE (DVD+RW only)

Press **SELECT** to begin erasing the disc.



LOCK (DVD+RW only)

When the icon display **LOCK**, it shows you can lock your current disc. If you have locked your disc, you can't make any changes any more except play it back, but you can unlock it by **UNLOCK**.



COMPATIBLE

When the icon display **COMP**, it shows you can make your current disc compatible.

If you want to make your disc compatible with the other DVD player, you should go on **COMPATIBLE** operation.

Specifications

DVD VIDEO PLAYER/OUTPUTS/SUPPLIED ACCESSORIES

PERSONAL VIDEO RECORDER

Power supply	220-240V AC 50/60 Hz
Power consumption	30W
Mass	4.14 Kg
External dimensions	430 x 65 x 302 mm (W/H/D)
Signal system	PAL/NTSC
Laser	Semiconductor laser, wavelength 650 nm

SUPPLIED ACCESSORIES

Audio cable (red and white)	1 pair
Remote control	1
Batteries (AAA)	2
Video cable (yellow)	1
Owner's Manual	1
Scart cable	1

Design and specifications are subject to change without notice.

Trouble shooting Guide

Check the following guide for a possible correction to a problem before contacting customer service.

SYMPTOMS AND CORRECTION

Symptom	Correction
No power	<ul style="list-style-type: none"> • Connect the power plug into the wall outlet securely.
No picture	<ul style="list-style-type: none"> • Verify the connection from the DVD video output to the TV video input. Then switch TV to appropriate mode (video 1) • Connect the video cable into the jacks securely. Refer to your television owners manual.
No sound	<ul style="list-style-type: none"> • Connect the audio cables into the jacks securely. • Verify the connection from the DVD audio output to the TV or receiver audio input. Then switch to the appropriate source on the receiver. Refer to your audio amplifier owners manual.
Black & White picture	<ul style="list-style-type: none"> • Damaged S connector (bent pin)
The playback picture has occasional distortion	<ul style="list-style-type: none"> • A small amount of picture distortion may appear because of a poor quality video/sound transfer to disc. This is especially true of some discs manufactured between 1997-1998.. • Scratched disc
Brightness is unstable or noises are produced on playback pictures	<ul style="list-style-type: none"> • Connect the DVD player directly through the TV and not through any other source. What you're viewing is the effect of the copy protection circuitry required on all DVD players.
The DVD video player does not start playback	<ul style="list-style-type: none"> • Place the disc with the graphics side up. • Place the disc on the disc tray correctly inside the guide. • Make sure the disc is free from scratches & fingerprints. • Press the SETUP button to turn off the menu screen. • Cancel the parental lock function or change the parental lock level. (<i>The Pre-set password is 3308.</i>) • Turn the power off then disconnect the power plug and reinsert it back into the wall. Retry again. • Use region 2 discs only.
MP3 won't read disc or it skips	<ul style="list-style-type: none"> • Return disc as the software edition used may not be compatible with the player. Check web site for instruction. • Use new editions of software such as Voyetra Audiostation 4, Adaptec's "Easy CD Creator", NTI or Roxio's Toast Titanium. • Make sure MP3 file are not encoded with a variable bit rate such as provided by Real Networks.
The remote control does not work properly	<ul style="list-style-type: none"> • Replace the batteries with new ones.
The recorder cannot record.	<ul style="list-style-type: none"> • The type of the disc is wrong, it's not a DVD+RW or DVD+R disc. • The disc is recorded full. • The disc (DVD+R, DVD+RW) is locked, it should be unlocked. • The DVD+R has been finalized.
Some keys do not work	<ul style="list-style-type: none"> • The type of the disc is wrong, it's not a DVD+RW or DVD+R disc. • The unit is in record mode or it is recording.
The image is distorted.	<ul style="list-style-type: none"> • The setup of Interlaced or Progressive is wrong. • Press the I/Pbutton to switch from each other.

Attachment

Support Media (DVD+R)

Recommend	Maker	Media speed	Manufacture ID	Media type ID	Product Rev. No	Notes
Max Write Speed: 4x	MITSUBISHI	4x	MCC	002	0	
	YUDEN	4x	YUDEN000	T00	0	
	YUDEN	2.4x	YUDEN000	T01	0	
	Ricoh	4x	RICOHJPN	R00	2	Sample Only
	Ricoh	4x	RICOHJPN	R01	2	
	SONY	4x	SONY	D01	0	Ready Now
	Maxell	4x	MAXELL	001	0	Ready Now
	TDK	4x	TDK	001	0	Ready Now
Max Write Speed: 2.4x	MITSUBISHI	2.4x	MCC	001	0	
	CMC	2.4x	CMC Mag	R01	0	
	DAXON(ACER)	2.4x	DAXON	AZ0	0	
	BeAll	2.4x	BEALL P0	001	0	
	Total (Recommend)	12				

Not Recommend	Maker	Media speed				Notes
Max Write Speed :2.4x	ProDISC	2.4x	PRODISC	R01	0,1	2 types
	Ritek	2.4x	RITEK	R01	1	
	Ricoh	2.4x	RICOHJPN	R00	0	
	HP	2.4x	RICOHJPN	R00	1	Ricoh ID
	Total (Not Recommend)	4				

Support Media (DVD+RW)

Recommend	Maker	Media speed	Manufacture ID	Media type ID	Total	Notes
Max Write Speed :2.4x	MITSUBISHI	2.4x	MCC	A01	1	
	RICOH	2.4x	RICOHJPN	W01	1	
	TDK	2.4x	TDK	t01	1	
	Total (Recommend)	3				

Not Recommend	Maker	Media speed	Manufacture ID	Media type ID	Total	Notes
Max Write Speed :2.4x	RITEK	2.4x	RITEK	001	1	
	CMC	2.4x	CMC"null" MAG	W01	1	
	CMC	2.4x	CMC"space" MAG	W01	1	
	OPTODISC	2.4x	OPTODISC	OP1	1	
	PRODISC	2.4x	PRODISC	W01	1	
	MCC	4x	MKM		1	Sample only
	Ricoh	4x	RICOHJPN	W11	1	Sample only
	Total (Not Recommend)	7				



www.yakumo.com

CE