

# ***JOBCOM***®

**THE LEADER IN JOBSITE RADIOS**

## **J SERIES**

### **User Guide**



Thank you for buying the Ritron J Series business band radio. For almost 30 years, Ritron has been a leader in providing cost-effective, on-site communication equipment for businesses. The **J-Series** radio will provide cost-effective communication for schools, retail stores, manufacturing, warehousing, construction sites, property management, hotel and motel management and many more. Ritron radio communication products improve efficiency and safety in virtually any workplace environment. Ritron is *the wireless connection* for your on-site communication needs.

**NOTE:** Please read all instructions in this manual.

## INCLUDED ITEMS



Two-way Radio



1800mAh Li-Ion  
Battery Pack  
with attached Belt Clip

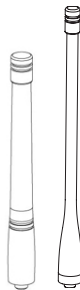

VHF or UHF Antenna



2.5 Hour, Dual Slot Charging  
Stand with Power Supply

User Manual



# CONTENTS

FCC REGULATIONS, LICENSING .....	1	EMERGENCY CALL FEATURE (ORANGE BUTTON) .....	11
SAFETY STANDARDS .....	1	NOAA WEATHER RADIO .....	12
SERVICE .....	1	HOW TO READ-OUT FREQUENCY & TONE CODE SETTINGS .....	13
HOW TO OBTAIN AN FCC RADIO LICENSE .....	1	HOW TO PROGRAM PER-CHANNEL FEATURES .....	14
ABOUT THIS USER GUIDE .....	2	TABLE #1 PROGRAMMABLE FREQUENCY CODES.....	15
RADIO CONTROLS .....	3	TABLE #2 INTERFERENCE ELIMINATOR PROGRAMMABLE CODES.....	16
RADIO BUTTONS & CONTROLS .....	4	TABLE #3 DIGITAL INTERFERENCE ELIMINATOR PROGRAMMABLE CODES.....	16
DISPLAY ICONS .....	5	HOW TO PROGRAM RADIO-WIDE FEATURES.....	17
ATTACHING THE BATTERY .....	6	HOW TO ASSIGN A FUNCTION TO A PKEY PROGRAMMABLE FUNCTION BUTTON .....	18
REMOVING THE BATTERY .....	6	HOW TO DELETE A CHANNEL .....	19
J SERIES AUDIO ACCESSORIES .....	7	RITRON LIMITED WARRANTY .....	20
FAST RATE DUAL SLOT DROP-IN CHARGER .....	9		
ATTACHING THE ANTENNA .....	10		
ON/OFF AND VOLUME CONTROL .....	10		
OPERATING THE RADIO .....	11		
KEYPAD LOCK .....	11		

© 2005 Ritron, Inc. All rights reserved. Ritron, Patriot, Jobcom, OutPost, GateGuard, Quiet Call and Quick Assist are registered trademarks of Ritron, Inc. Quick Talk, Liberty and RadioNexus are trademarks of Ritron, Inc.

## FCC REGULATIONS

**LICENSING** —The FCC requires the owners of **J Series** radios to obtain a station license before using them.

The station licensee is responsible for ensuring that transmitter power, frequency and deviation are within the limits specified by the station license. The station licensee is also responsible for proper operation and maintenance of the radio equipment. This includes checking the transmitter frequency and deviation periodically, using appropriate methods.

To get a FCC license for VHF or UHF frequencies, submit FCC application Form 600 as indicated in the block at right. Your Ritron dealer can help you with this process.

**SAFETY STANDARDS** —The FCC (with its action in General Docket 79-144, March 13, 1985) has adopted a safety standard for human exposure to radio frequency electromagnetic energy emitted by FCC regulated equipment. Ritron observes these guidelines and recommends that you do also:

- DO NOT hold the radio so that the antenna is very close to or touching exposed parts of the body, especially the face or eyes, while transmitting. Keep the radio vertical, four inches away while talking into the front panel.
- DO NOT press the Push-To-Talk except when you intend to transmit.
- DO NOT operate radio equipment near electrical blasting caps or in an explosive atmosphere.
- DO NOT allow children to play with any radio equipment that contains a transmitting device.
- Repair of Ritron products should be performed only by Ritron authorized personnel.

**Service** - Federal law prohibits you from making any internal adjustments to the transmitter, and/ or from changing transmit frequencies unless you are specifically designated by the licensee.

If your radio equipment fails to operate properly, or you wish to have the radio programmed, contact your authorized dealer or Ritron.

**RITRON, INC.**  
**Repair Department**  
**P. O. Box 1998**  
**Carmel, IN 46082-1998**  
**USA**  
**Phone: 317-846-1201**  
**FAX: 317-846-4978**

### HOW TO OBTAIN AN FCC RADIO LICENSE

Federal Communications Commission (FCC)  
Licensing Information

Because your Ritron radio operates on Private Land Mobile frequencies, it is subject to the Rules and Regulations of the FCC, which requires all operators of these frequencies to obtain a station license before operating their equipment. Make application for your FCC license on FCC Forms 600 and 159.

*To have forms and instructions faxed to you by the FCC, call the **FCC Fax-On-Demand** system at **202-418-0177** from your fax machine; request Document 000600 & Form 159.*

*To have Document 000600 & Form 159 mailed to you, call the **FCC Forms Hotline** at **800-418-FORM** (800-418-3676).*

*For **help with questions** concerning the license application, contact the FCC at **888-CALL-FCC** (888-225-5322).*

*You must decide which radio frequency(ies) you can operate on before filling out your application; refer to Table 1 on page 15 of this manual.*

*For **help determining your frequencies**, call Ritron at **800-USA-1-USA** (800-872-1872).*

## About This User Guide

This user guide covers two **J Series** model radios. Your model number is shown on the inside of the radio.

<u>Model</u>	<u>JV-110</u>	<u>JU-410</u>
Frequency Band	VHF	UHF
Transmit Pwr Out Hi/Lo (Watt)	5/2 *	4/2 *
Channel Capacity	up to 10 + WX	up to 10
Selectable Frequency Codes	26	77
Interference Eliminator Codes	158 possible	158 possible
<b>NOAA Weather Channel</b>	7 possible	N/A
<b>Programable Function Buttons</b>	3 assignable PFB's	3 assignable PFB's
Emergency Call Feature	Yes	Yes
Voice Scrambler	Yes	Yes
VOX Capability	Yes	Yes

\* Per FCC regulations certain frequencies (see frequency listing) are pre-set to operate at 2 Watt maximum.

## Radio Controls

The numbers below refer to the illustrations on the next page.

### FIG - 1:

- 1. On-Off / Volume Knob**  
Turn clockwise to turn the radio ON. Turn fully counter clockwise to turn OFF. Rotate to adjust volume.
- 2. Push to Talk Button (PTT)**  
Push and hold to transmit; release to listen.
- 3. Up/ Down Scroll Buttons**
- 4. LED Indicator**  
Lights **RED** while transmitting.  
Lights **Green** while receiving a call.
- 5. LCD Display**
- 6. Keypad Lock/Menu**  
Keypad Lock function is permanently assigned to this button in normal operation. Also serves as Menu Button in programming mode. See additional notes on page 11.
- 7. Microphone**
- 8. Speaker**
- 9. Antenna**

### FIG - 2:

- 10. Accessory Connector**  
Connects headsets, remote speaker/ microphones and other accessories. Replace attached dust cap when not in use.
- 11. Spring Action Belt Clip**
- 12. Battery Release Latches**

### FIG - 3:

**P Keys or Programmable Function Buttons (PFB)**  
These buttons can be re-programmed for one of several functions refer to page 18.

P Key	Location (on radio)	Default Function
P1	P (front)	Scan
P2	Orange (top)	Emergency Call
P3	Side	Monitor (press momentarily)

# Radio Buttons & Controls

FIG-1

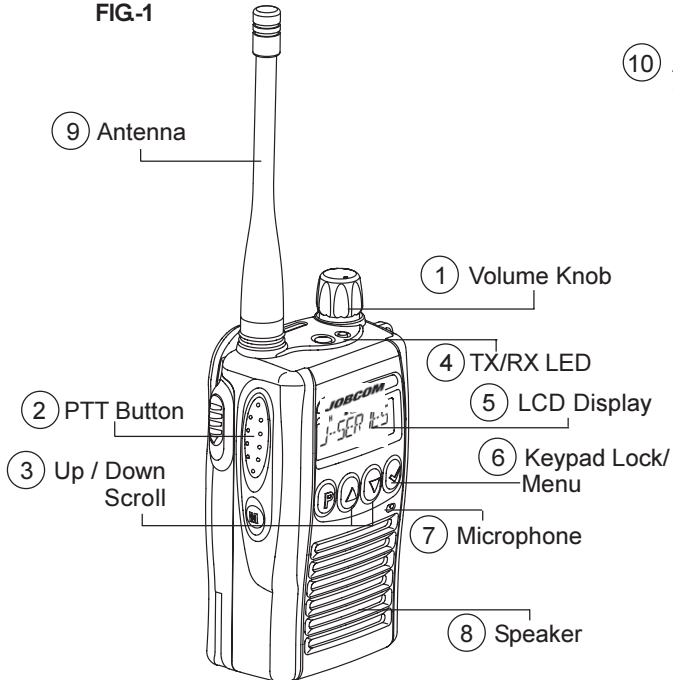

FIG-2

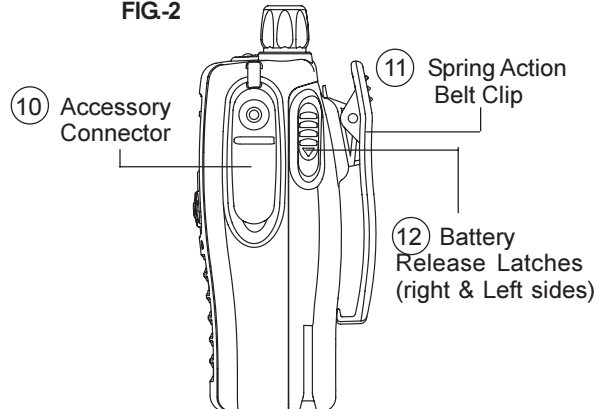
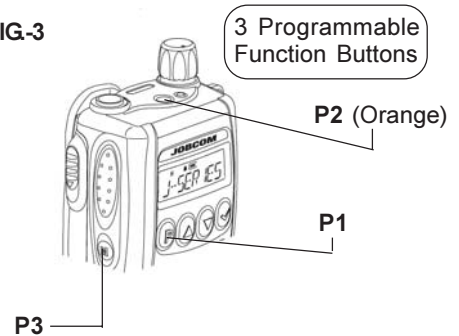

FIG-3



## Display Icons

To provide additional feedback to the radio user, the LED display has several status icons. Some status icons are “radio wide”. Other icons appear only IF the feature is set to **ON** for the current operating channel.



Symbol	Name/Function
	<p>Signal Strength Indicator – shows received signal strength of an incoming call.</p> <p>Full circle = strong signal  <math>\frac{3}{4}</math> circle = moderate signal  <math>\frac{1}{2}</math> circle = acceptable signal  <math>\frac{1}{4}</math> circle = very weak signal</p>
HL	H/L - Indicates power (High or Low) setting of individual channel.
	Keypad Lock – Appears when keypad lock is ON.
	Bell – Appears when keypad tones are ON.

Symbol	Name/Function
	<p>Battery Level Indicator:</p> <p>3 Bars = full charge            2 bars = 66%            1 = bar 33%</p>
	“Hands-Free” VOX Indicator – Appears when Hands-Free feature is ON.
	Scan Indicator – Appears when Channel Scan is ON.
	Scrambler Indicator – Appears when Voice Scrambler is ON.
	Talk Around Indicator – Appears when radio is operating on the Talk Around channel.



## Attaching the Battery

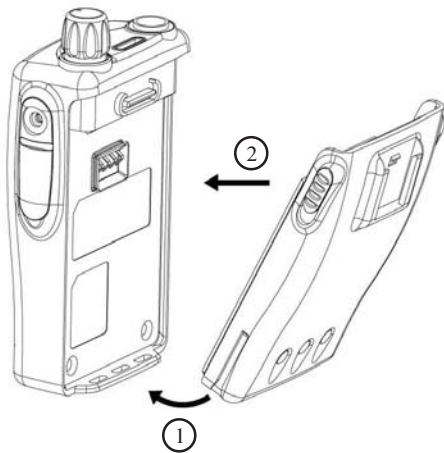

1. Fit the tabs at the bottom of the battery into the slots at the bottom of the radio's body.
2. Press the top part of the battery towards the radio until both latches firmly attach to the radio.

## Removing the Battery

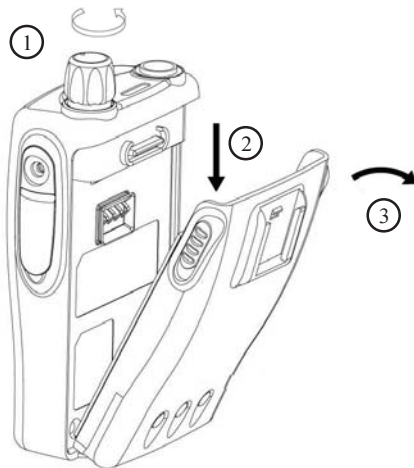

1. Turn off the radio.
2. Slide the latches located on both sides of the battery downwards at the same time.
3. Pull the top part of the battery away from the radio's body, and remove the battery.

## J Series Audio Accessories

Ritron offers a wide range of audio accessories and headsets to help customize your **J Series** radio for your application. All **J Series** audio accessories include a durable, injection molded strain relief. The strain relief keeps the audio accessory firmly attached to the **J Series** radio during use and attaches to the radio using 2 Phillips head screws (provided).

1. To attach audio accessory to the **J Series** radio- first remove the Phillips head screw holding the rubber dust cover in place. (see diagram below).
2. Remove the Phillips head screw on the inside bottom of the dust cover area.
3. Remove inner foam gasket.
4. Place these items in a secure place for future possible use.
5. Attach audio accessory to the **J Series** radio. (see diagram for proper position of strain relief). Cord leading to the headset or speaker mic of the accessory must be directed toward the top of the radio.
6. Do NOT over-tighten or apply excessive force when securing Phillips heads screws. Snug top and bottom screws down to the molded strain relief.

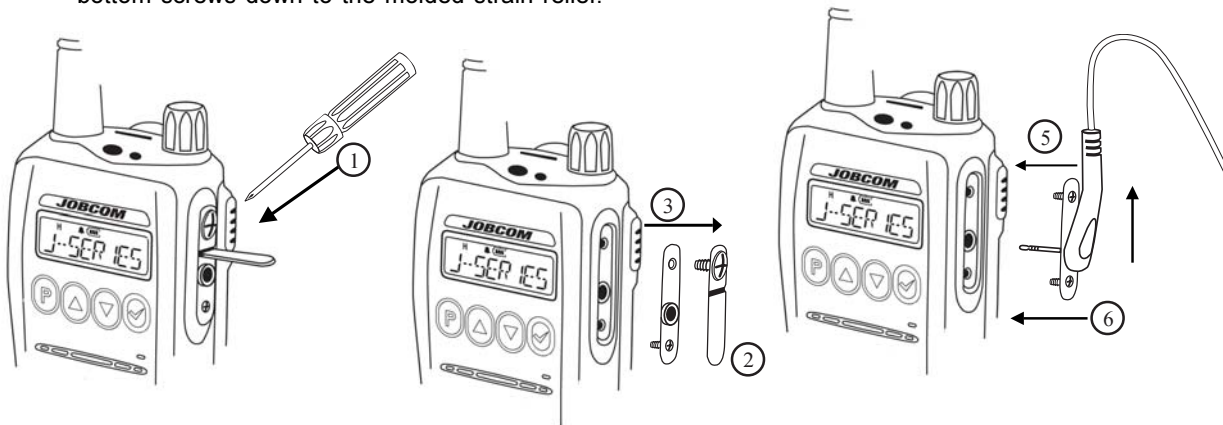

**RSM-5X** Remote Speaker Microphone w/ rotating spring action clip

*Speaker/mic can be attached to clothing close to mouth and ears allowing easier communication without removing radio from belt.*

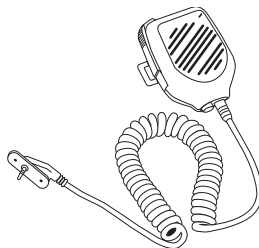

RSM-5X

**RHD-10X** Earbud w/ pendant PTT w/ built-in microphone and clip.

*Enables private listening and great for noisy environments. Mic with PTT can be attached to clothing for easy activation.*

RHD-10X

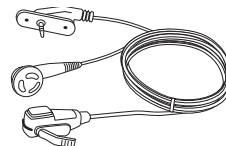

**RHD-11X** Security type earpiece w/ pendant PTT with built-in microphone and clip.

*Allows private listening and remote PTT for applications requiring more discrete communications.*

RHD-11X

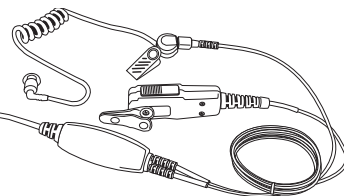

**RHD-12X** Lightweight behind-the-head headset w/ boom mic and pendant PTT.

*Great for noisy environments! Single ear headset with boom mic and in-line PTT.*

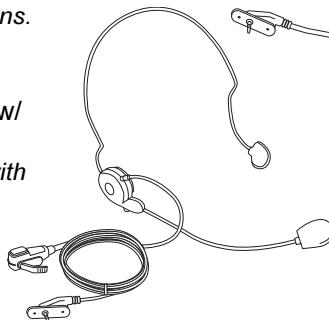

RHD-12X

**Note:** All J Series audio accessories are VOX capable.

## Fast Rate Dual Slot Drop-in Charger (BC-JX)

The enclosed dual slot charger can charge two batteries sequentially. The front slot must be **complete** (green) before it will charge the 2nd slot. **Note: Charge battery completely before use!**

A completely discharged pack will be recharged in approximately 2.5 hours.

Place spare battery pack in slot with label facing forward

Place radio with attached battery pack or battery pack only (see slots for battery only)

<u>LED</u>	<u>Status</u>
Red	Charging
Green	Complete
Amber	Waiting

Front Slot LED Indicator

Rear Slot LED Indicator

Input For Ritron 110 VAC Adapter

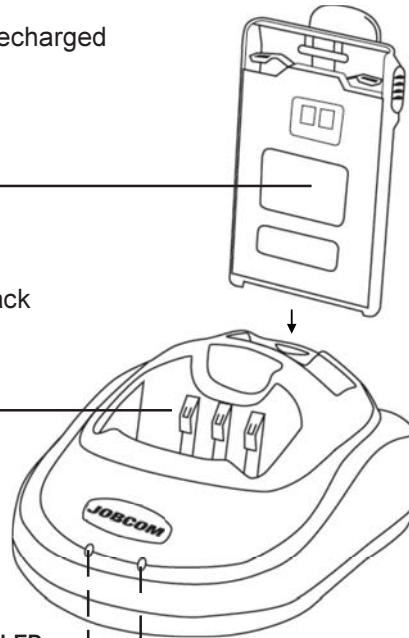

\* Use only a Ritron approved 110 VAC adapter.

\* Do not attempt to repair.

\* Do not attempt to charge any other brand of battery!

\* Do not expose to rain, snow, or moisture.

\* Do not use an extension cord to run power to the charger.

## Attaching the Antenna



1. Align the threaded end of the antenna with the radio's antenna connector.
2. Turn the antenna clockwise to attach to the radio.

## ON/OFF and Volume Control



1. To turn the radio ON, turn the knob clockwise. To turn the radio OFF, turn the knob fully counter clockwise.
2. To adjust volume UP, turn the knob clockwise. To turn the volume DOWN, turn the knob counter clockwise.

**NOTE:** \* Do not use radio or activate transmitter unless antenna is securely fastened to radio.  
\* Do not use any portable radio that has a damaged antenna.

## Operating the Radio



This radio offers up to 10 channels.



- Select the desired channel by using the Up/Down button. When held down, channels change continuously.
- To check channel activity, press the monitor button.
- To talk, press and hold the PTT button and speak into the microphone on the radio. Release to listen.

*Note: For maximum clarity hold the radio 2-3 inches away from your mouth and speak in a normal tone of voice.*

### Keypad Lock

The  button serves as the keypad lock. To turn **ON**, **PRESS AND HOLD** the  button for 3 seconds. Keypad lock icon will be displayed when **ON**. To turn **OFF**, press and **HOLD**  button for 3 seconds, keypad lock icon will disappear. Keypad lock feature prevents accidental activation of the buttons on the front of the radio (the **PTT** button, **P2** and **P3** keys do not lock).

## Emergency Call Feature

### (Default P2 Key-orange button)

The Emergency Call feature allows the radio user to immediately notify all other radios on the same channel. For example, if the radio user should become injured, trapped or is in danger, a simple push of the orange button (factory default) will activate the Emergency Call feature.

#### The Emergency Call feature operates as follows:

1. Press and hold for 2 seconds the P Key programmed to activate the Emergency Call feature (factory default is the P2 Key – orange button on top of the radio).
2. The radio then sends an alert tone to all other radios on the same channel. Alert tone also sounds in the speaker of the radio.
3. Transmitter on sending radio will automatically **key up** and transmit for a number of seconds after the alert tone ends.
4. This allows any audio present at the initiating radio to be transmitted **hands free** to all other radios on the system; e.g. a call for help.

**Default Setting: The Emergency Call will repeat 2 times and can be cancelled at anytime by momentarily pressing the appropriate P KEY (orange button).**



## NOAA Weather Radio (NWR) Feature

As an added benefit, your J Series radio is capable of receiving broadcasts from the National Weather Service. Use this extremely useful feature during times of hazardous weather or simply to better schedule activities that are weather dependent.

The National Weather Service (NWR) broadcasts are transmitted 24 hours a day, 7 days a week. Your area has a specific NOAA weather frequency. To find the frequency for your area go to:

<http://www.nws.noaa.gov/nwr/nwrbro.htm>

Click on your state. Then click on the county closest to you. You will see a frequency listed. Match the frequency for your area with 1 of the 7 listed in the table on this page.

Refer to page 17 [NOAA WX] How To Program Radio-Wide Features for details on how to program your J Series radio to a National Weather Service frequency. When you've programmed the NOAA WX feature into your radio, [NOAA WX] will appear as the last channel programmed in your radio.

You may select from the National Weather Service frequencies listed below:

### NOAA WEATHER BROADCAST FREQUENCY TABLE

Code	Frequency
W1	162.400
W2	162.425
W3	162.450
W4	162.475
W5	162.500
W6	162.525
W7	162.550

## How To Read-Out Frequency and Tone Code Settings

This step allows you to **read-out** on a per-channel-basis what the frequency code and interference eliminator tone code settings are in your radio.

Step 1. With radio **ON**, select the channel # you want to **read-out**.

Step 2. Turn radio **OFF**,

Step 3. **HOLD** the  button and Turn radio **ON**.

Note: Continue to HOLD  button until the following appears on the display:

<u>Ch #</u>	<u>Frequency Code #</u>	<u>Tone Code #</u>	<u>2-Tone* Code #</u>
[CH _ _	F _ _]	then ....	[T _ _ _ 2T _]

Display will read for 3 seconds =

Step 4. Radio will then display [READY] and return to normal operation.

Step 5. To read-out a different channel repeat steps 1-4 for each channel.

Step 6. Turn radio **OFF** then **ON** again to return to normal operation.

**Note:** If no Tone Code is programmed, the display will read: [ T 4 4 2T X ] 44 = No Tone

\* If no 2-Tone Code is programmed, display will read: [ 2T X ]. 2-Tone feature not available in all J Series models.









## How To Program Per-Channel Features

To match other radios, the owner can select from a table of frequency codes and interference eliminator codes. In order to talk to other radios, the channel must be programmed to the same frequency and the same tone code. The following list of features can be programmed on a **Per-Channel** basis.

<u>Options</u>	<u>Description of the feature</u>
[FREQ] Codes	Select a Frequency code for a channel. Choose from 26 VHF frequencies or 77 UHF frequencies.
[TONE] Codes	Select a Tone code for channel. Choose from 158 interference eliminator codes. Tone codes screen-out other users not in your group. All radios must be the same code to talk.
[CH SCAN]	Select <b>ON</b> to <b>mark</b> a channel to be included in the scan list. Select <b>OFF</b> (default) to delete a channel from the scan list. <b>Marked</b> channels will be scanned when Scan feature is activated. You must assign Scan function to a programmable function button (PFB) to activate. See <b>Radio-Wide</b> and <b>PFB Programming</b> .
[SCRAMBLE]	Select <b>ON</b> to activate Voice Scrambling for a specific channel. If <b>ON</b> , icon will be displayed and radio will operate in Scramble mode on this channel. To be heard, <b>all</b> radios must have Scramble <b>ON</b> .
[VOX]	Select <b>ON</b> to activate Hands-Free VOX for a specific channel. No accessory required. If <b>ON</b> , radio will operate "Hands-Free" on this channel and icon will be displayed. To adjust level of audio required to trigger radio transmitter refer to page 17 [VOX LEV] How To Program Radio-Wide Features.

**Important: If a Frequency Code is changed you must also reprogram the Tone Code.**

- Step 1. **HOLD Push-To-Talk** button and turn radio **ON**.
- Step 2. Radio will sound triple beep, then [CH PROG] will be displayed for 3 sec. Then [CH – 1] or the programmed name will be displayed.
- Step 3. Use  to select the desired channel [CH \_\_], pick 1-10.
- Step 4. Press  for **Per Channel** option (see list above).
- Step 5. Use  to go to a specific option; e.g. [FREQ], [TONE], [2-TONE], [CH SCAN], [SCRAMBLE], [VOX].
- Step 6. Press  to select a desired option e.g. [FREQ]. Display will then show current setting of the selected option.
- Step 7. Use  Buttons to scroll option sub-list; e.g. [FREQ] codes or [TONE] code lists.
- Step 8. Press  button to **SAVE** selection. Display will show selected feature. Example: [FREQ].
- Step 9. Use  to select a different **Per-Channel Feature** for the channel; e.g. [TONE] – and Repeat Steps 7 – 8 **or...**
- Step 10. To select a different channel to program, **PRESS** the **Orange** button on top of the radio. Display will show the last channel programmed; e.g. [CH – 1]. Repeat Steps 3 – 8 **or...**
- Step 11. To return to normal operation turn radio **OFF** and then **ON**.

# RADIO PROGRAMMING

## TABLE #1: PROGRAMMABLE FREQUENCY CODES

Code No.	VHF MURS ** MHz	Color Dot	Band Width
—	NONE *		
^01	154.6000	Green Dot	25
^02	154.5700	Blue Dot	25
^19	151.8200	MURS	12.5
^20	151.8800	MURS	12.5
^21	151.9400	MURS	12.5
^22	154.6000	MURS/Green	12.5
^23	154.5700	MURS/Blue	12.5
Code No.	VHF Business Band MHz	Color Dot	Band Width
03	151.6250	Red Dot	25
04	151.9550	Purple Dot	25
05	151.9250		25
06	154.5400		25
07	154.5150		25
08	154.6550		25
09	151.6850		25
10	151.7150		25
11	151.7750		25
12	151.8050		25
13	151.8350		25
14	151.8950		25
15	154.4900		25
16	151.6550		25
17	151.7450		25
18	151.8650		25
24	151.7000		12.5
25	151.7600		12.5
26	152.7000		25

^ By FCC rule these frequencies are limited to 2 Watt maximum power output.

Code No.	UHF Business Band MHz	Color Dot	Band Width
—	NONE *		
^01	467.7625	J	25
^02	467.8125	K	25
03	464.5500	Yellow Dot	25
04	464.5000	Brown Dot	25
^05	467.8500	Silver Star	25
^06	467.8750	Gold Star	25
^07	467.9000	Red Star	25
^08	467.9250	Blue Star	25
09	469.2625		25
10	462.5750	White Dot	25
11	462.6250	Black Dot	25
12	462.6750	Orange Dot	25
13	464.3250		25
14	464.8250		25
15	469.5000		25
16	469.5500		25
17	463.2625		25
18	464.9125		25
19	464.6000		25
20	464.7000		25
21	462.7250		25
22	464.5000	Brown Dot	12.5
23	464.5500	Yellow Dot	12.5
^24	467.7625	J	12.5
^25	467.8125	K	12.5
^26	467.8500	Silver Star	12.5

Per FCC rules and regulations, a given radio must not be programmed to contain a mix of both VHF Business Band and VHF MURS frequencies.

Code No.	UHF Business Band MHz	Color Dot	Band Width
^27	467.8750	Gold Star	12.5
^28	467.9000	Red Star	12.5
^29	467.9250	Blue Star	12.5
30	461.0375		12.5
31	461.0625		12.5
32	461.0875		12.5
33	461.1125		12.5
34	461.1375		12.5
35	461.1625		12.5
36	461.1875		12.5
37	461.2125		12.5
38	461.2375		12.5
39	461.2625		12.5
40	461.2875		12.5
41	461.3125		12.5
42	461.3375		12.5
43	461.3625		12.5
44	462.7625		12.5
45	462.7875		12.5
46	462.8125		12.5
47	462.8375		12.5
48	462.8625		12.5
49	462.8875		12.5
50	462.9125		12.5
51	464.4875		12.5
52	464.5125		12.5

\* 2-digit Frequency placeholder code (Refer to How to Delete a Channel on page 19).

\*\* MURS frequencies - The 5 MURS frequencies **do not require** an FCC license. All other frequencies **require** an FCC license. Refer to page 1 for license information.

# RADIO PROGRAMMING

**TABLE #1: CONT.**

Code No.	UHF Business Band MHz	Color Dot	Band Width
53	464.5375		12.5
54	464.5625		12.5
55	466.0375		12.5
56	466.0625		12.5
57	466.0875		12.5
58	466.1125		12.5
59	466.1375		12.5
60	466.1625		12.5
61	466.1875		12.5
62	466.2125		12.5
63	466.2375		12.5
64	466.2625		12.5
65	466.2875		12.5
66	466.3125		12.5
67	466.3375		12.5
68	466.3625		12.5
<sup>^</sup> 69	467.7875		12.5
<sup>^</sup> 70	467.8375		12.5
<sup>^</sup> 71	467.8625		12.5
<sup>^</sup> 72	467.8875		12.5
<sup>^</sup> 73	467.9125		12.5
74	469.4875		12.5
75	469.5125		12.5
76	469.5375		12.5
77	469.5625		12.5

<sup>^</sup> By FCC rule these frequencies are limited to 2 Watt maximum power output.

**TABLE #2: INTERFERENCE ELIMINATOR PROGRAMMABLE QC TONE CODES**

Code No.	Hz	Code No.	Hz	Code No.	Hz
-	NONE				
01	67.0	18	123.0	35	225.7
02	71.9	19	127.3	36	233.6
03	74.4	20	131.8	37	241.8
04	77.0	21	136.5	38	250.3
05	79.7	22	141.3	39	69.4
06	82.5	23	146.2	40	159.8
07	85.4	24	151.4	41	165.5
08	88.5	25	156.7	42	171.3
09	91.5	26	162.2	43	177.3
10	94.8	27	167.9	44	No Tone
11	97.4	28	173.8	45	183.5
12	100.0	29	179.9	46	189.9
13	103.5	30	186.2	47	196.6
14	107.2	31	192.8	48	199.5
15	110.9	32	203.5	49	206.5
16	114.8	33	210.7	50	229.1
17	118.8	34	218.1	51	254.1

**TABLE #3: DIGITAL INTERFERENCE ELIMINATOR PROGRAMMABLE DQC CODES**







Code Numbers						
023	074	165	261	356	462	631
025	114	172	263	364	464	632
026	115	174	265	365	465	645
031	116	205	266	371	466	654
032	122	212	271	411	503	662
036	125	223	274	412	506	664
043	131	225	306	413	516	703
047	132	226	311	423	523	712
051	134	243	315	431	532	723
053	143	244	325	432	546	731
054	145	245	331	445	565	732
065	152	246	332	446	606	734
071	155	251	343	452	612	743
072	156	252	346	454	624	754
073	162	255	351	455	627	

# How To Program Radio-Wide Features

The following list of features can be programmed on a **Radio-Wide** basis. These settings will uniformly affect radio operation on **all** channels.

<u>Options</u>	<u>Description of the feature</u>
[VOX LEV]	Select VOX Level. 0 to 15, Higher number = Lower level of audio required to <b>key</b> radio transmitter. Ex:15 = whisper trigger. Must also program channel for VOX operation. See page 14.
[SQ LEV]	Select Squelch Level. 0 to15, Higher number = decreases receiver sensitivity. With higher number the radio will <b>hear</b> only the strongest, closest signals.
[EMERGENC]	Factory Default = [ON] and feature is by factory default assigned to P2 Key. Can turn feature <b>OFF</b> or <b>ON</b> . If <b>ON</b> , must also assign this feature to one of the Programmable Function Button. See page 18.
[P1 Key]	Factory Default = [SCAN KEY]. Allows access to one specific feature. See page 18 for list.
[P2 Key]	Factory Default = [EMERGENC]. Allows access to one specific feature. See page 18 for list.
[P3 Key]	Factory Default = [MONITOR]. Allows access to one specific feature. See page 18 for list.
[ALERTS]	Factory Default = [ON]. Select <b>ON</b> for keypad tones when button is pressed. Icon will be displayed when <b>ON</b> . Keypad Tones <b>OFF</b> allows silent operation.
[EAR PTT]	Select <b>ON</b> if earphone only is used. When earphone only is connected to radio, microphone on radio will be active when PTT is pressed.
[WEATHER] VHF models only	Factory Default = [W7]. Select <b>NONE</b> or choose from 7 National Weather Broadcast RX frequencies. If selected, [NOAA WX] will be displayed after last programmed channel. Choose [NONE] to turn feature <b>OFF</b> . Go to <a href="http://www.noaa.nws.gov/nws/nwrbro/htm">www.noaa.nws.gov/nws/nwrbro/htm</a> to find frequency of NOAA Weather Broadcast for your area.

## To Program Radio-Wide Settings:

- Step 1. **HOLD** the MONITOR button and turn radio ON. Radio will sound triple beep, then [PROGRAM] will flash on the display for 3 sec. [VOX LEV] will appear first on display.
- Step 2. Use   buttons to scroll to one of the **Radio-Wide** features. e.g. [VOX LEV], [SQ LEV], [EMERGENC], [P1 KEY], [P2 KEY], [P3 KEY], [ALERTS], [EAR PTT], OR [WEATHER (VHF only)].
- Step 3. Press  for the current setting of the selected **Radio-Wide** feature.
- Step 4. Use   buttons to scroll sub-list setting options such as; [1-15] Level Settings; **ON** or **OFF** Setting; or individual  Key function options.
- Step 5. Press button  to **SAVE** the sub-list setting selection. Display will then return to selected **Radio-Wide** feature,
- Step 6. To program another **Radio-Wide** setting repeat Steps 2 - 5 **or...**
- Step 7. To return to normal operation turn radio **OFF** and then **ON**.

## How To Assign A Function To A P KEY (Programmable Function Button)

There are 3 Programmable Function Buttons on the J Series radio (P1, P2 and P3). See FIG 3 below for their location on the radio. You can assign each of these buttons or P keys to perform 1 specific function when pressed. The functions you may choose from are listed below:

### Options

[NONE]

[SCAN KEY]

[EMERGENC]

[CALL KEY]

[MONITOR]

[TX PWR KEY]

### Description of the feature

**P KEY** will perform no function when pressed.

When **P KEY** pressed, radio will scan **marked** channels. Icon will display when ON. See CH SCAN on page 14.

When **P KEY** pressed, radio sends Emergency signal to other radios on same frequency.

Press **and hold** the **P KEY** to send a unique Call Tone to let others know you are about to talk.

When **P KEY** pressed, radio will monitor traffic on the channel without tone.

When **P KEY** pressed, will toggle\* transmit power of selected channel frequency, between **HI** and **LOW** power. Icon H or L will be displayed.

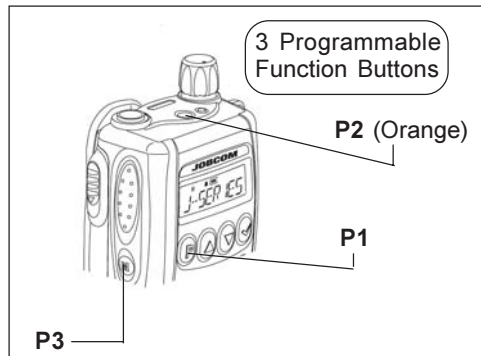

### To Program P KEY's :

- Step 1. **HOLD** the MONITOR button and turn radio **ON**. Radio will sound triple beep, then [**PROGRAM**] will flash on the display for 3 sec. [**VOX LEV**] will appear first on display.
- Step 2. Use (▲) (▼) buttons to scroll to the PFB you wish to program: [**P1 KEY**], [**P2 KEY**] or [**P3 KEY**].
- Step 3. Press (⊙) to see current setting of the specific **P KEY** you have selected.







- Step 4. Use (▲) (▼) buttons to scroll sub-list setting options listed above.
- Step 5. Press the button (Ⓟ) to **SAVE** your sub-listing option. Display will then show the last **P KEY** programmed; e.g. [**P\_ KEY**].
- Step 6. To program another [**P\_ KEY**] repeat Steps 2 - 5 **or...**
- Step 7. To return to normal operation turn radio **OFF** and then **ON**.

\* **NOTE:** Certain frequencies are limited by the FCC to 2 Watt maximum output. See pages 16 & 16.

## How To Delete A Channel

To delete a channel from your channel list, follow these instructions. Deleting a channel will remove that channel number from the display. It is not necessary to delete a channel if you merely wish to change the frequency and/or tone settings. To change frequency or tone settings see How To Program Per-Channel Features on page 14.

### To Program Channel Delete:

- Step 1. **HOLD** Push-To-Talk button and turn radio **ON**.
- Step 2. Radio will sound triple beep, then [**CH PROG**] will flash on display for 3 sec. Then [**CH – 1**] or a programmed name will appear on the display.
- Step 3. Use   to select the channel you want to delete [**CH \_\_**], 1-10.
- Step 4. Press  for **Per-Channel Feature** list
- Step 5. Display will show [**FREQ**].
- Step 6. Press  to select [**FREQ**]. Display will then show current frequency code for the channel; e.g. [**F C \_\_**].
- Step 7. Use   buttons to scroll to [**NONE**]
- Step 8. Press  button to **SAVE [NONE]** selection. Display will show selected feature; e.g. [**FREQ**].
- Step 9. To select a different channel, **PRESS** the **P2 Key** (orange button) on the top of radio. Display will show the last channel deleted; e.g. [**CH – 1**]. Repeat Steps 3 – 8 **or...**
- Step 10. To return to normal operation turn radio **OFF** and then **ON**.
- Step 11. The channel(s) you deleted will **not** appear on the display in normal operation.

# RITRON, INC. LIMITED WARRANTY

**WHAT THIS WARRANTY COVERS:** RITRON, INC. ("RITRON") provides the following warranty against defects in materials and/or workmanship in **RITRON JV-110 AND JU-410 PORTABLE RADIOS** under normal use and service during the applicable warranty period, as stated below. "Accessories" means antennas, holsters, chargers, ear-phones, speaker/microphones, and items contained in the programming and programming/service kits. Rechargeable batteries will be replaced during the applicable warranty period only if leakage occurs or the batteries drop below 75% of rated capacity.

## WHAT IS COVERED FOR HOW LONG

J Series 1 year \*

Portable Radio

Ritron Rechargeable 1 year \*

Batteries

Accessories 90 days \*

## WHAT RITRON WILL DO

During the first year after date of purchase, RITRON will repair or replace the defective product, at RITRON's option, parts and labor included at no charge.

Ritron will replace the defective battery

\*After date of purchase

## **WHAT THIS WARRANTY DOES NOT COVER:**

- Any technical information provided with the covered product or any other products;
- Installation, maintenance or service of the product, unless this is covered by a separate written agreement with RITRON;
- Any products not furnished by RITRON which are attached or used with the covered product, or defects or damage from the use of the covered product with equipment that is not covered;
- Defects or damage, including broken antennas, resulting from:
  - misuse, abuse, improper maintenance, alteration, modification, neglect, accident or act of God, or,
  - the use of covered products other than in normal and customary manner, or,
  - improper testing or installation;
- Defects or damages from unauthorized disassembly, repair or modification, or where unauthorized disassembly, repair or modification prevents inspection and testing necessary to validate warranty claims;
- Defects or damages in which the serial number has been removed, altered or defaced.

**IMPORTANT:** This warranty sets forth the full extent of RITRON's express responsibilities regarding the covered products, and is given in lieu of all other express warranties. What RITRON has agreed to do

above is your sole and exclusive remedy. No person is authorized to make any other warranty to you on behalf of RITRON. Warranties implied by state law, such as implied warranties of merchantability and fitness for a particular purpose, are limited to the duration of this limited warranty as it applies to the covered product. Incidental and consequential damages are not recoverable under this warranty (this includes loss of use or time, inconvenience, business interruption, commercial loss, lost profits or savings). **Some states do not allow the exclusion or limitation of incidental or consequential damages, or limitation on how long an implied warranty lasts, so the above limitations or exclusions may not apply to you.** Because each covered product system is unique, RITRON disclaims liability for range, coverage, or operation of the system as a whole under this warranty.

**WHO IS COVERED BY THIS WARRANTY:** This warranty is given only to the purchaser or lessee of covered products when acquired for use, not resale. This warranty is not assignable or transferable.

**HOW TO GET WARRANTY SERVICE:** To receive warranty service, you must deliver or send the defective product, delivery costs and insurance prepaid, within the applicable warranty period, to RITRON, INC., 505 West Carmel Drive, Carmel, Indiana 46032, Attention: Warranty Department. Please point out the nature of the defect in as much detail as you can. **You MUST retain your sales or lease receipt (or other written evidence of the date of purchase) and deliver it along with the product.** If RITRON chooses to repair or replace a defective product, RITRON may replace the product or any part or component with reconditioned product, parts or components. Replacements are covered for the balance of the original applicable warranty period. All replaced covered products, parts or components become RITRON's property.

**RIGHTS TO SOFTWARE RETAINED:** Title and all rights or licenses to patents, copyrights, trademarks and trade secrets in any RITRON software contained in covered products are and shall remain in RITRON. RITRON nevertheless grants you a limited non-exclusive, transferable right to use the RITRON software only in conjunction with covered products. No other license or right to the RITRON software is granted or permitted.

**YOUR RIGHTS UNDER STATE LAW:** This warranty gives you specific legal rights, and you may also have other rights which vary from state to state.

**WHERE THIS WARRANTY IS VALID:** This warranty is valid only within the United States, the District of Columbia and Puerto Rico.



Base Station



JMX Series Portables



XT Callbox

Go Beyond Normal Limits...<sup>SM</sup>



505 West Carmel Drive • Carmel, IN 46032 • USA

P. O. Box 1998 • Carmel, IN 46082-1998 • USA

Ph: 317-846-1201 • Fax: 317-846-4978 • Email: [ritron@ritron.com](mailto:ritron@ritron.com) • Website: [www.ritron.com](http://www.ritron.com)