

# Table of Contents

Introduction	1
Getting started	2
Map settings	3
Navigation	4
Other settings	5
General system information	6
Troubleshooting guide	7
Index	8

 **REVIEW COPY—2014 Low Cost Navi 2 Kai (12k)**  
**Navigation System OM—USA\_English (nna)**  
**06/11/13—tbrooks** 

# 1 Introduction



How to use this manual .....	1-2	Safety information .....	1-2
For safe operation .....	1-2	Laser product .....	1-4
Reference symbols .....	1-2		

 **REVIEW COPY—2014 Low Cost Navi 2 Kai (I2k)**  
**Navigation System OM—USA\_English (nna)**  
**06/11/13—tbrooks** 

## HOW TO USE THIS MANUAL

This manual uses special words, symbols and icons that are organized by function.

Please refer to the following items to understand how to use this manual properly.

### FOR SAFE OPERATION

#### **WARNING**

**Indicates the presence of a hazard that could cause death or serious personal injury. To avoid or reduce the risk, the procedures must be followed precisely.**

#### **CAUTION**

**Indicates the presence of a hazard that could cause minor or moderate personal injury or damage to your vehicle. To avoid or reduce the risk, the procedures must be followed carefully.**

#### **NOTE:**

Indicates items that help you understand and maximize the performance of your vehicle. If ignored, they may lead to a malfunction or poor performance.

### 1-2 Introduction

## REFERENCE SYMBOLS



### INFO:

Indicates information that is necessary for efficient use of your vehicle or accessories.



Reference page:

Indicates the title and page that you should refer to.

NAV:

This is an example of how a button on the control panel will be shown.

“Route”:

This is an example of a key/item displayed on the screen.

## SAFETY INFORMATION

This system is primarily designed to help you reach your destination, and it also performs other functions as outlined in this manual. However, you, the driver, must use the system safely and properly. Information concerning road conditions, traffic signs and the availability of services may not always be up-to-date. The system is not a substitute for safe, proper and legal driving.

Before using the navigation system, please read the following safety information. Always use the system as outlined in this manual.

#### **WARNING**

- **To operate the navigation system, first park the vehicle in a safe location and set the parking brake. Operating the system while driving can distract the driver and may result in a serious accident.**
- **Do not rely on route guidance alone. Always be sure that all driving maneuvers are legal and safe in order to avoid accidents.**
- **Do not disassemble or modify this system. If you do, it may result in accidents, fire or electrical shock.**

- If you notice any foreign objects in the system hardware, spill liquid on the system or notice smoke or a smell coming from it, stop using the system immediately and contact a NISSAN dealer. Ignoring such conditions may lead to accidents, fire or electrical shock.

 **CAUTION**

- Do not use this system if you notice any malfunctions such as a frozen screen or the lack of sound. Continued use of the system may result in accidents, fire or electrical shock.
- Some states/provinces may have laws limiting the use of video screens while driving. Use this system only where it is legal to do so.
- Extreme temperature conditions [below -4 °F (-20 °C) and above 158 °F (70 °C)] could affect the performance of the system.



**NOTE:**

Do not keep the navigation system running with the engine stopped. Doing so may discharge the vehicle battery. When you use the navigation system, always keep the engine running.

## LASER PRODUCT

### **WARNING**

- Do not disassemble or modify this system. There are no user serviceable parts in this navigation system.

- If maintenance, adjustments and operations other than those specified in this manual are attempted, injury due to laser radiation and exposure could occur.



SiriusXM services require a subscription after a trial period and are sold separately or as a package. Our satellite service is available only in the 48 contiguous USA and DC. For more information visit [www.siriusxm.com](http://www.siriusxm.com).



“Made for iPod” and “Made for iPhone” mean that an electronic accessory has been designed to connect specifically to iPod or iPhone, respectively, and has been certified by the developer to meet Apple performance standards. Apple is not responsible for the operation of this device or its compliance with safety and regulatory standards. Please note that the use of this accessory with iPod or iPhone may affect wireless performance.



The Bluetooth® word mark and logos are registered trademarks owned by Bluetooth SIG, Inc. and any use of such marks by DENSO CORPORATION is under license. Other trademarks and trade names are those of their respective owners.



Required SiriusXM Satellite Radio and SiriusXM Traffic monthly subscriptions are sold separately. SiriusXM Traffic are only available in select markets. For more information, see [www.siriusxm.com/siriusxmtraffic](http://www.siriusxm.com/siriusxmtraffic)

## 1-4 Introduction

 **REVIEW COPY—2014 Low Cost Navi 2 Kai (12k)**  
**Navigation System OM—USA\_English (nna)**  
**06/11/13—tbrooks** 



Required SiriusXM Satellite Radio and SiriusXM Travel Link monthly subscriptions are sold separately. SiriusXM Travel Link is only available in select markets. For more information, see [www.siriusxm.com/travellink](http://www.siriusxm.com/travellink)

**App Store**

Apple and the Apple logo are trademarks of Apple Inc., registered in the U.S. and other countries. App Store is a service mark of Apple Inc.

**Google Play™**

Google Play is a trademark of Google Inc.

**Google**

© 2012 Google Inc. All rights reserved.



# MEMO

1-6 Introduction



## 2 Getting started



Control buttons and functions. ....	2-2	Steering wheel switch (Type C) .....	2-5
Control panel (Type A) .....	2-2	Basic operation .....	2-6
Control panel (Type B) .....	2-3	Touch screen operation .....	2-6
Steering wheel switch (Type A) .....	2-4	Menu screen operation.....	2-7
Steering wheel switch (Type B) .....	2-4	How to input characters.....	2-8

## CONTROL BUTTONS AND FUNCTIONS

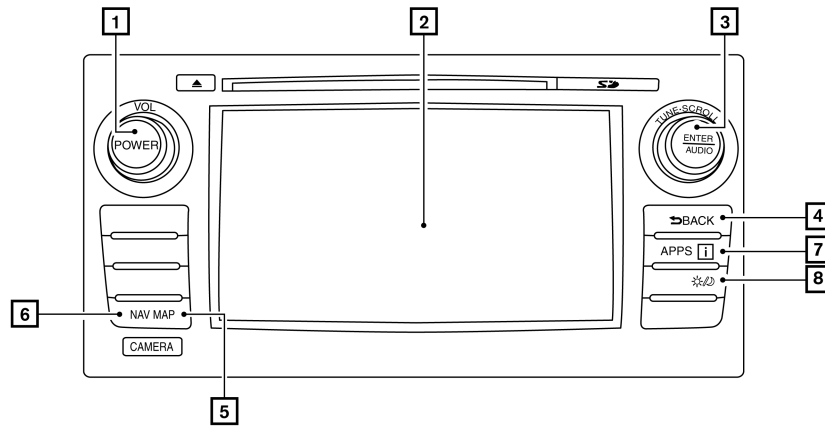

### CONTROL PANEL (Type A)

- 1** VOL (volume) control knob/POWER button:  
 Rotate clockwise to increase the volume or counterclockwise to lower the volume.  
 Press to turn the audio system on or off.
- 2** Touch screen display

- 3** TUNE-SCROLL dial / ENTER/AUDIO button:  
 Turn to scroll through the items in a list. Press to select a menu item. When the screen is not displaying a list or menu, the knob is used to control the audio system.  
 Press the ENTER/AUDIO button to select a highlighted item on the screen.

LNV2446

- 4** BACK button:  
 Press to return to the previous screen or to delete the last inputted letter if a touch keyboard is displayed on the screen.
- 5** MAP button:  
 Press to display the current location map screen.
- 6** NAV button:  
 Press to access the functions of the Navigation system.
- 7** APPS button:  
 Press to access the system settings.
- 8** button:  
 Press to change the display brightness between day and night modes. While the mode is being displayed, the brightness can be adjusted using the TUNE/SCROLL dial.  
 Press and hold for more than two seconds to switch the display to a larger display of the digital clock.  
 "DISPLAY SETTINGS"  
 (page 5-3)

### 2-2 Getting started

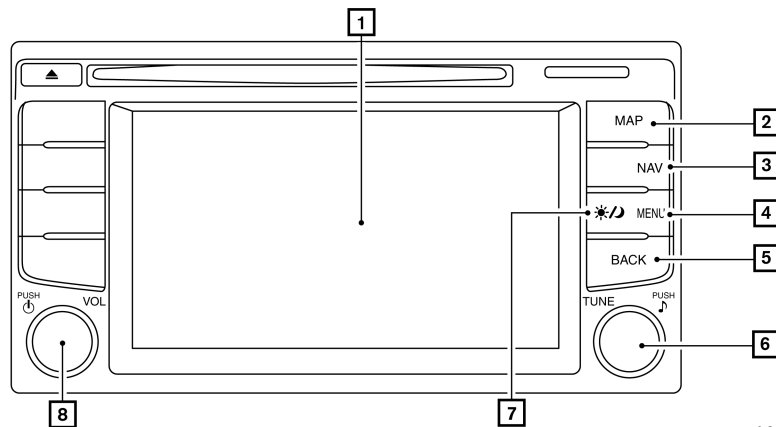

**CONTROL PANEL (Type B)**

- 1** Touch screen display
- 2** MAP button:  
Press to display the current location map screen.
- 3** NAV button:  
Press to access the functions of the Navigation system.
- 4** MENU button:  
Press to access the system settings.
- 5** BACK button:  
Press to return to the previous screen or to delete the last inputted letter if a touch keyboard is displayed on the screen.
- 6** TUNE dial/AUDIO button:  
Turn to scroll through the items in a list. Press to select a menu item. When the screen is not displaying a list or menu, the knob is used to control the audio system.
- 7** Sun/Moon icon button:  
Press to change the display brightness between day and night modes. While the mode is being displayed, the brightness can be adjusted using the TUNE dial.  
Press and hold for more than two seconds to switch the display to a larger display of the digital clock.
- 8** VOL (volume) control knob/ON-OFF button:  
Rotate clockwise to increase the volume or counterclockwise to lower the volume.  
Press to turn the audio system on or off.

LNV2469

**7** Sun/Moon icon button:

Press to change the display brightness between day and night modes. While the mode is being displayed, the brightness can be adjusted using the TUNE dial.

Press and hold for more than two seconds to switch the display to a larger display of the digital clock.

"DISPLAY SETTINGS"  
(page 5-3)

**8** VOL (volume) control knob/ON-OFF button:

Rotate clockwise to increase the volume or counterclockwise to lower the volume.

Press to turn the audio system on or off.

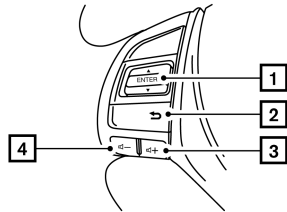

**Altima** LNV2018  
**STEERING WHEEL SWITCH (Type A)**

- 1 ENTER button / tuning switch  
 Scrolls up and down through lists and selects the highlighted item on the screen.
- 2 ↶ (back) button  
 Returns to the previous screen or deletes the last inputted letter if a touch keyboard is displayed on the screen.
- 3 Volume increase button  
 Increases the volume of the voice guidance given by the Navigation System if pressed while the voice guidance is speaking. If the volume increase button is pressed at any other time, only the volume of the active screen (phone, SMS playback, Voice Recognition system [if so equipped], audio system) will be increased.

- 4 Volume decrease button  
 Decreases the volume of the voice guidance given by the Navigation System if pressed while the voice guidance is speaking. If the volume decrease button is pressed at any other time, only the volume of the active screen (phone, SMS playback, Voice Recognition system [if so equipped], audio system) will be decreased.

For more information about the audio system, Bluetooth® Hands-Free Phone System and Voice Recognition system (if so equipped), see the vehicle's Owner's Manual.

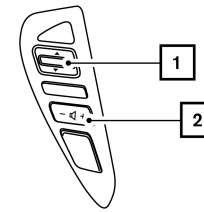

**Sentra** LNV2395  
**STEERING WHEEL SWITCH (Type B)**

- 1 Tuning switch  
 Scrolls up and down through lists and selects the highlighted item on the screen.
- 2 Volume control button  
 Increases or decreases the volume of the voice guidance given by the Navigation System if pressed while the voice guidance is speaking. If the volume button is pressed at any other time, only the volume of the active screen (phone, SMS playback, Voice Recognition system [if so equipped], audio system) will be adjusted.

2-4 **Getting started**

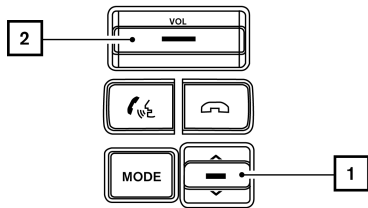

**Xterra and Frontier**

LNV2399

For more information about the audio system, Bluetooth® Hands-Free Phone System and Voice Recognition system (if so equipped), see the vehicle's Owner's Manual.

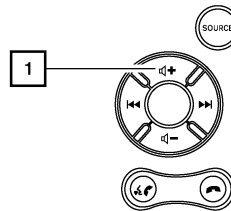

**NV200**

LNV2002

**STEERING WHEEL SWITCH (Type C)**

- 1** Volume control button  
Increases or decreases the volume of the voice guidance given by the Navigation System if pressed while the voice guidance is speaking. If the volume button is pressed at any other time, only the volume of the active screen (phone, SMS playback, Voice Recognition system [if so equipped], audio system) will be adjusted.

For more information about the audio system, Bluetooth® Hands-Free Phone System and Voice Recognition system (if so equipped), see the vehicle's Owner's Manual.



## BASIC OPERATION

### TOUCH SCREEN OPERATION

The same operations described for the scrolling dial are possible using touch screen operation.



LVN2443

Examples of touch screen operation

#### Selecting an item:

When any item is touched, the next screen is displayed.

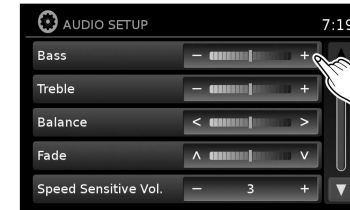

LVN2440

#### Adjusting:

Touch the "+", "-", ">" or "<" key to adjust a setting.

### 2-6 Getting started



LNV0921

**Scrolling through a message or list:**

Turn the TUNE-SCROLL dial to scroll through a message or a list. When scrolling a lengthy list, you can also touch the screen and slide your finger along the scroll bar where shown to scroll more quickly. Touching the up or down arrow will move between pages of the list.

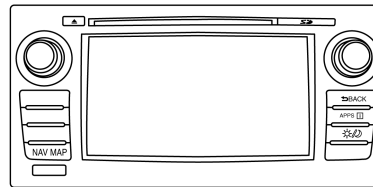

**(Type A)**  
MENU SCREEN OPERATION

LNV2448

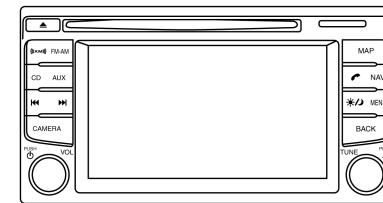

**(Type B)**

LNV2466

Menu screens and their purpose

Press one of the application buttons to activate the corresponding menu screen:

- NAV (Navigation)
- APPS or MENU

How to select a menu item

1. As an alternative to using the touch screen, turn the scrolling dial clockwise or counter-clockwise to scroll through the menu items until the preferred item is highlighted.
2. To select the preferred item, press the scrolling dial.
3. Press the BACK or ↶ BACK button. The previous screen will be displayed and the changes will be saved.

**Getting started 2-7**

## HOW TO INPUT CHARACTERS Character (letter and number) input screen

Alphanumeric characters are used when setting a destination, searching for an address, editing stored locations, etc.



LNV2415

1. Touch characters on the touch keyboard and they will appear in the field at the top of the screen. When the entry is complete, touch the “OK” key.

Alternatively, use the scrolling dial to highlight a character and press the dial to select that character.

### ! NOTE:

- Press the  BACK button to delete the last inputted character or to return to the previous screen if no characters have been inputted.
- On every character entry screen, the touch keyboard will display only the letters that are possible to enter after the current letter.
- Symbol and number keys are available when the “123/ABC” key is touched.

- Touch the “123/ABC” key to toggle the display between the touch keyboard for letters and the touch keyboard for numbers and symbols.
- 2. To delete the last entry, touch the “Delete” key or hold it to delete all entries at once.
- 3. After finalizing the entries, touch the “OK” key or touch the “List” key for the completed list screen.



### NOTE:

- If a phrase is being entered that has been previously entered into the system, the matched text may appear in light gray. Touch “OK” to search for the matched text. Touch “List” to search for both the matched text and entered text.

## 2-8 Getting started



# 3 Map settings

Map types . . . . .	3-2	Looking at information on the map . . . . .	3-7
2-Dimensional (2D) view . . . . .	3-2	Map symbols . . . . .	3-7
2-Dimensional North Up (2DN) view . . . . .	3-2	Map settings for the map screen . . . . .	3-9
3-Dimensional (3D) view . . . . .	3-2	Lane information . . . . .	3-11
Screen information (2D, 2DN or 3D) . . . . .	3-3	Map SD-card . . . . .	3-11
Moving a map . . . . .	3-4	How to handle the SD-card . . . . .	3-12
Returning to the current vehicle location . . . . .	3-5	SD-card replacement . . . . .	3-12
Map options menu screen . . . . .	3-5	How to order map data updates . . . . .	3-12
Changing the map scale . . . . .	3-6	About the map data . . . . .	3-12
Map scale . . . . .	3-6	End-user terms . . . . .	3-14



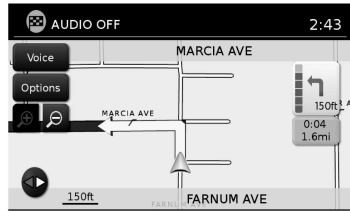

## MAP TYPES



### 2D LNV2455 2-DIMENSIONAL (2D) VIEW

The 2D map is a two-dimensional (flat) representation of the map data, similar to a road map, focused on the vehicle's position (vehicle icon).

-  "SCREEN INFORMATION (2D, 2DN or 3D)" (page 3-3)
-  "MAP SETTINGS FOR THE MAP SCREEN" (page 3-7)

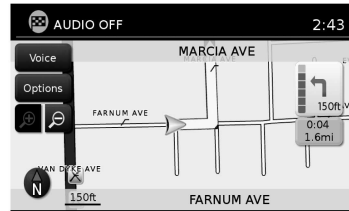

### 2DN LNV2454 2-DIMENSIONAL NORTH UP (2DN) VIEW

The 2DN map is a two-dimensional (flat) representation of the map data, similar to a road map, focused on the vehicle's position (vehicle icon) with the top of the map aligned North.

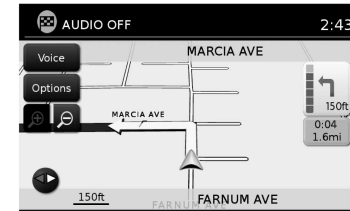

### 3D LNV2456 3-DIMENSIONAL (3D) VIEW

The 3D map displays the map from an elevated perspective, providing a panoramic view over a long distance.

The map in 3D view always appears with the current forward direction facing up (heading up).

## 3-2 Map settings

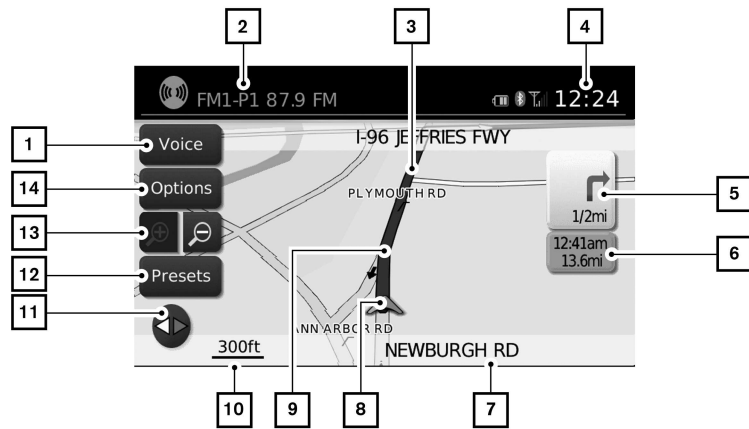

LNV2206

**SCREEN INFORMATION (2D, 2DN or 3D)**

**1** “Voice” key

Touch to repeat the voice guidance while a route is active. Touch and hold for two seconds to toggle the voice guidance on or off (button will be grayed out when voice guidance is turned off). This option is available only when a route is set.

**2** Audio information

Indicates the radio station, CD track number or other audio information currently playing.

**3** Next maneuver road name

Indicates the name of the next road in the route guidance. This is only shown if route guidance is active.

**4** Clock

Indicates the current time.

**5** Direction indicator and distance to next maneuver on the route

When route guidance is active but you have deviated from the route, this area displays a compass icon with an arrow indicating the destination direction.

When route guidance is active and you are on the route, this area indicates the distance (in miles or kilometers) to the next point and the turning direction at that point.

When the “Voice” key is not shown on the screen (such as when an audio screen is displayed on the screen), touch the direction indicator to repeat the voice guidance while a route is active. Touch and hold for two seconds to toggle the voice guidance on or off.

**6** Estimated time of arrival and distance to destination or remaining time of travel and distance to destination.

Touch this button to switch the indicator between estimated arrival time and remaining travel time. This indicator only appears once the destination is set and the route guidance is initiated. The estimated arrival time may not switch to the estimated arrival time for the destination's time zone if a time zone line is crossed as part of the route.

**Map settings 3-3**

- 7 Current road indicator  
The location of where the car is positioned.
- 8 Vehicle icon  
Indicates the current location and direction of the vehicle.
- 9 Suggested route  
Appears as a bold blue line during route guidance.
- 10 Scale indicator  
Indicates the scale of the map.
- 11 Compass icon  
Indicates the direction of the map. Touch this icon to switch the map view between the North Up, Heading Up (or actual direction) and 3D modes.
- 12 "Presets" key  
This option toggles on and off with the "Menu" key and displays a touch menu of the radio presets on the screen. For more information about the audio system, see the vehicle Owner's Manual.
- 13 Zoom in and zoom out keys  
Touch to zoom the map in or out.

3-4 **Map settings**

- 14 "Options" key  
Touch this key to access the map options menu screen.  
 "MAP OPTIONS MENU SCREEN" (page 3-5)

**MOVING A MAP**

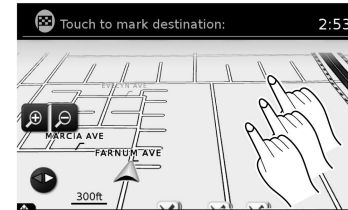

LNV2463

To scroll the map in either direction:

1. Touch and release the screen anywhere on the map.
2. Touch the screen again and move your finger along the screen in the direction you wish to scroll.

After releasing and touching the map again, a marker will be displayed at the point touched and, if possible, the position determined.



**NOTE:**

**When the current location of the vehicle is recognized, the street name will be displayed at the bottom of the screen. When scrolling a map and an area that is not a road, city or POI is touched, coordinates corresponding to the marker's position are displayed at the bottom of the screen.**

## RETURNING TO THE CURRENT VEHICLE LOCATION

The basic map screen displays the current location of the vehicle. The current location can be displayed again even after the map is moved, or after the menu screen is displayed.

Press the MAP button or the BACK or  BACK button and the current location will be displayed on the map.

## MAP OPTIONS MENU SCREEN

The Map Options menu allows you to quickly store the current position, show position information or destination information, and adjust the map settings.

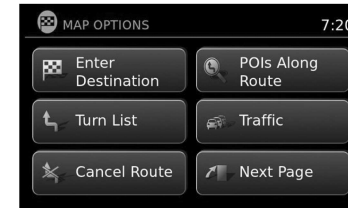

LNV2457

1. Touch the “Options” key while the route guidance map is displayed.
2. The following options are available for selection:
  - Enter Destination  
Select to open the navigation screen for entering an address.
  - Turn List  
Select to display all of the turns and way-points along the route.
  - Cancel Route  
Select to cancel entire route or way-points along route.

**Map settings 3-5**

- **POIs Along Route**  
Select to choose the types of points of interest to display along the active route. Available options are gas stations, restaurants, ATMs, parking, rest areas, hotels, dealerships and airports.

**! NOTE:**

**Some places of interest on divided highways may show the equivalent place of interest on the opposite side of the road (such as a rest area) as being closer than the place in your traveling direction. Confirm location of the place before following the route.**

- **Traffic**  
Select to display all traffic events on route and options to avoid roads along route.
- **Show Route On Map**  
Select to display the entire route on the screen. The view will zoom to the necessary level in order to show both the starting point and destination on the screen.

**3-6 Map settings**

- **Routing Options**  
Select to view options available to customize route. Avoiding specific roads, dynamic guidance, route type and minimizing freeways, types of roads and ferries can all be adjusted.
- **Show Position Information**  
Select to display the latitude, longitude and altitude for the current position of the vehicle. Location can also be stored to the Address Book.
- **Show Waypoints**  
Select to add or show list of waypoints along route.
- **Guidance & Map Settings**  
Select to toggle guidance information and map settings options.



“MAP SETTINGS FOR THE MAP SCREEN” (page 3-7)

**CHANGING THE MAP SCALE**

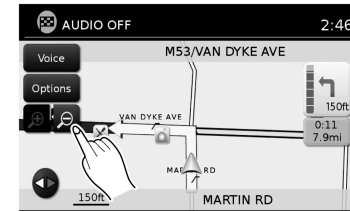

LNV2462

When using the “+” or “-” for zooming in or out, the scale on the bottom left side of the screen changes to indicate the new scale level.

**MAP SCALE**

The following scales are available depending on the map view:

Per approximately 1/2 inch (1 cm)
150 ft (50 m)
300 ft (100 m)
600 ft (200 m)
1/4 mile (500 m)
1/2 mile (1 km)
1 mile (2 km)
2.5 mi (5 km)
5 mi (10 km)

Per approximately 1/2 inch (1 cm)
10 mi (20 km)
25 mi (50 km)
50 mi (100 km)
100 mi (200 km)
250 mi (500 km)

## LOOKING AT INFORMATION ON THE MAP

Icons of various categories of locations can be displayed on the map.

## MAP SYMBOLS

This navigation system uses symbols to display various types of facilities. The following icons (if so equipped) may be used on the map screen.



Map settings 3-7



LNV2467

### 3-8 Map settings

**REVIEW COPY—2014 Low Cost Navi 2 Kai (12k)  
Navigation System OM—USA\_English (nna)  
06/11/13—tbrooks**



## MAP SETTINGS FOR THE MAP SCREEN

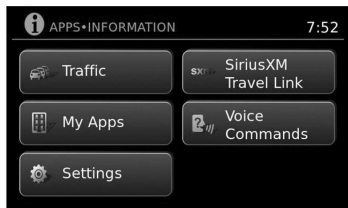

LNV2459

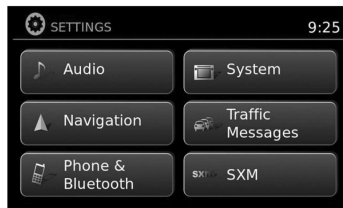

LNV2460

Other settings are available for the map screen, such as switching the map view or changing the map direction.

1. Press the **APPS** or MENU button.
2. Touch the "Settings" key.

3. Touch the "Navigation" key.
4. Touch the "Guidance & Map Settings" key.

When selected, the system will offer the following map setting options:

Menu Item	Options
Voice Guidance	Select to toggle on or off the voice guidance on map screen.
Volume	Select "+" or "-" to increase or decrease voice guidance volume.
Map View	Touch the "Map View" key to toggle between 2D and 3D map view.
2D-North/Heading Up	Touch to toggle display between "Head" and "North" for 2D mode. When "Head" is selected, the screen always shows the map in the driving direction. When "North" is selected, the top of the map is always orientated north. This option can only be selected when the "Map View" is set to 2D.
Auto Zoom	Touch the "Auto Zoom" key to choose a setting for automatic zooming. Available settings are "Never", "Always" and "Only with a route".
Show Points of Interest On Map	Select to toggle various map icons on and off including gas stations, restaurants, banks and parking.

Menu Item	Options
My Points of Interest Alert	Select to control alert options. Choose "Off" to disable the alert. Choose "Show Only" to have the alert displayed on the screen. Choose "Show & Beep" to have an audible beep in addition to the alert displayed on the screen.
Show Presets On Map	Select to toggle on or off the preset radio station buttons on the map screen.
Split Map for Freeway Exit	Select to toggle on or off the split view map when approaching a freeway exit.
Show Lane Information	Select to toggle on or off lane information when available.
Show Speed Limit	Select to toggle on or off the display of speed limit information when available.
Show Estimated Time	Select to control display of estimated time of arrival or trip time remaining.
Customize Travel Speed	Select to customize travel speeds on local roads and freeways along route.
Speed Limit Warning	Select to control the speed limit alert that activates when the vehicle speed is greater than the speed limit information for the current location. Choose "Off" to disable the alert. Choose "Show Only" to have the alert displayed on the screen. Choose "Show & Beep" to have an audible beep in addition to the alert displayed on the screen.
Speed Limit Sensitivity	Select the sensitivity level for the speed limit warning. Choose a value between zero and 30
Speed Warning for Curves	Select to control the alert that activates depending on vehicle speed and a curve in the road ahead. Choose "Off" to disable the alert. Choose "Show Only" to have the alert displayed on the screen. Choose "Show & Beep" to have an audible beep in addition to the alert displayed on the screen.
Distance Units	Select to toggle "US" or "Metric" for the distance units on the map screen.

3-10 Map settings

**REVIEW COPY—2014 Low Cost Navi 2 Kai (12k)**  
**Navigation System OM—USA\_English (nna)**  
**06/11/13—tbrooks**

## LANE INFORMATION

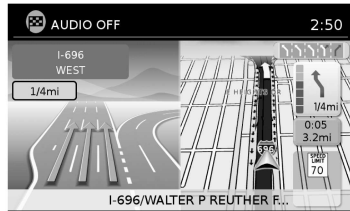

LNV2464

When the vehicle is approaching a junction or interchange, the screen switches to a split view. Lane information is graphically displayed on the left side of the split screen and icons showing the proper lanes for upcoming maneuvers are shown in the upper right corner below the clock.

The highlighted lanes are those from which the next maneuver on the route will be made. Lanes displayed in gray are those that do not follow the route at the upcoming junction or interchange. The icons in the upper right corner also indicate direction and may change as the junction or interchange approaches (for example, straight ahead, to straight and then right).

Once the vehicle passes through the junction or interchange, the screen returns to the previous view.

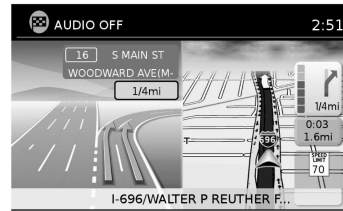

LNV2465

**NOTE:**

**Lane information is not available for all areas. It will only be displayed in areas where the necessary map data is available.**

**NOTE:**

**The number of lane icons in the upper right corner may change as the junction or interchange approaches due to a difference in the number of available lanes.**

## MAP SD-CARD

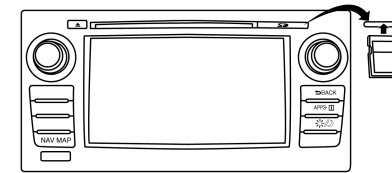

**Type A**

LNV2473

The SD-card slot is located on the front of the unit. When you purchase this system, an SD-card with map data is provided.

Map settings 3-11

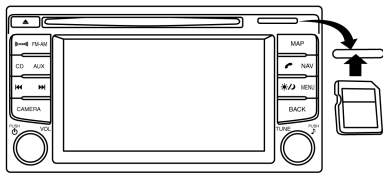

**Type B**

LNV2474

**NOTE:**

- Before inserting the map SD-card confirm that there is no SD-card already in the slot.
- The SD-card slot can only read the SD-card with map data provided specifically for use with the vehicle's navigation system. The system will not read other SD-cards.
- If an SD-card with something other than map data (such as music, pictures or movies) is inserted into the slot, the Navigation System will not function. A message will appear prompting for the map SD-card to be reinserted. This message will not appear if the SD-card is removed while in audio mode. The audio mode is not affected by the SD-card.

**3-12 Map settings**

**HOW TO HANDLE THE SD-CARD**

When handling the SD-card, please be careful and adhere to the following instructions:

**CAUTION**

- **Handle the SD-card with care. Never touch the metal contacts.**
- **Do not use any conventional cleaner, benzine, thinner, or antistatic spray.**
- **If you need to clean the SD-card use a soft cloth.**
- **Never attempt to use an SD-card that has been cracked, deformed or repaired using adhesive. Doing so may damage the equipment.**
- **Do not try to bend the SD-card. Do not use any SD-card that is bent or cracked.**
- **Do not put on any sticker or write anything on the SD card.**
- **Handle the SD-card carefully to avoid contamination or flaws. Otherwise, the data may not be read properly.**

- **Do not store the SD-card in locations exposed to direct sunlight, or in high temperatures or humidity.**
- **Always place the SD-card in its storage case when not in use.**

**SD-CARD REPLACEMENT**

For additional SD-cards with map data, contact the NISSAN Navigation Helpdesk.

**HOW TO ORDER MAP DATA UPDATES**

To order updated map data and voice commands, contact the NISSAN Navigation Helpdesk. See the contact information on the inside front cover of this manual.

**ABOUT THE MAP DATA**

- Bosch has compiled the digitized map data into a usable format. © 2011 Robert Bosch GmbH all rights in compilation software reserved. Due to the production timing of the map data, some new roads may not be included, or some names and roads may be different from those in use at the time this map data is used.

- Traffic control and regulation data used in this map data may be different from those in use at the time this map data is used. When driving, follow the actual traffic control signs and notices on the roads.
- Reproducing or copying this map software is strictly prohibited by law.

**⚠ WARNING**

- **This navigation system should not be used to replace your own judgement. No itinerary suggested by this navigation system should ever override any freeway regulations, your own judgement, or a knowledge of safe driving practices. Do not follow the navigation system's suggested itinerary if it would cause you to perform a dangerous or illegal act, place you in a dangerous situation, or take you into an area you consider unsafe.**

- **The advice provided by the navigation system is to be regarded as a suggestion only. There may be times when the navigation system displays the vehicle's location incorrectly, fails to suggest the shortest route, or fails to direct you to your desired destination. In such instances, rely on your own judgement taking into account the driving conditions at the time.**
- **Do not use the navigation system to locate emergency services. The database does not contain a complete listing of emergency services such as police stations, fire stations, hospitals and walk-in clinics. Please show discretion and ask for directions in such instances.**
- **As the driver, you alone are responsible for your driving safety.**
  - **In order to avoid a traffic accident, do not operate the system while driving.**
  - **In order to avoid a traffic accident, operate the system only when the vehicle is stopped at a safe place and the parking brake is on.**

- **In order to avoid a traffic accident or traffic offence, remember that actual road conditions and traffic regulations take precedence over the information contained on the navigation system.**
- **The software may contain inaccurate or incomplete information due to the passage of time, changing circumstances, and the sources of information used. Please respect current traffic conditions and regulations at all times while driving.**
- **Where actual road conditions and highway regulations differ from the information contained on the navigation system, abide by the highway regulations.**
- **Keep the amount of time spent viewing the screen while driving to a strict minimum.**

The navigation system does not provide, nor represent in any way information on: traffic and highway regulations; technical aspects of the vehicle including weight, height, width, load and speed limits; road conditions including grade, percentage of incline and surface conditions;

**Map settings 3-13**

obstacles such as the height and width of bridges and tunnels; and other current driving or road conditions. Always rely on your own judgement when driving a car, taking into account current driving conditions.

The company trademarks used in this product to identify locations and business offices are the trademarks of their respective owners. Their use does not represent sponsorship, approval or recommendation of this product by these companies.

### END-USER TERMS

The data ("Data") is provided for your personal, internal use only and not for resale. It is protected by copyright, and is subject to the following terms and conditions which are agreed to by you, on the one hand, and NISSAN and its licensors (including their licensors and suppliers) on the other hand.

© 2011 NAVTEQ. All rights reserved.

The Data for areas of Canada includes information taken with permission from Canadian authorities, including: © Her Majesty the Queen in Right of Canada, © Queen's Printer for Ontario, © Canada Post Corporation, GeoBase®, © Department of Natural Resources Canada.

### 3-14 Map settings

NAVTEQ holds a non-exclusive license from the United States Postal Service® to publish and sell ZIP+4® information.

©United States Postal Service® 2009. Prices are not established, controlled or approved by the United States Postal Service®. The following trademarks and registrations are owned by the USPS: United States Postal Service, USPS, and ZIP+4.

The Data may include or reflect data of licensors, including Her Majesty the Queen in the Right of Canada ("Her Majesty"), Canada Post Corporation ("Canada Post") and the Department of Natural Resources Canada ("NRCan"). Such data is licensed on an "as is" basis. The licensors, including Her Majesty, Canada Post and NRCan, make no guarantees, representations or warranties respecting such data, either express or implied, arising by law or otherwise, including but not limited to, effectiveness, completeness, accuracy or fitness for a particular purpose.

The licensors, including Her Majesty, Canada Post and NRCan, shall not be liable in respect of any claim, demand or action, irrespective of the nature of the cause of the claim, demand or action alleging any loss, injury or damages, direct or indirect, which may result from the use or possession of the data or the Data. The licensors, in-

cluding Her Majesty, Canada Post and NRCan, shall not be liable in any way for loss of revenues or contracts, or any other consequential loss of any kind resulting from any defect in the data or the Data.

End User shall indemnify and save harmless the licensors, including Her Majesty, Canada Post and NRCan, and their officers, employees and agents from and against any claim, demand or action, irrespective of the nature of the cause of the claim, demand or action, alleging loss, costs, expenses, damages or injuries (including injuries resulting in death) arising out of the use or possession of the data or the Data.

### Terms and conditions

#### Personal Use Only:

You agree to use this Data together with NISSAN Automotive Products for the solely personal, non-commercial purposes for which you were licensed, and not for service bureau, timesharing or other similar purposes. Accordingly, but subject to the restrictions set forth in the following paragraphs, you may copy this Data only as necessary for your personal use to view it, and save it, provided that you do not remove any copyright notices that appear and do not modify the Data in any way. You agree not to otherwise reproduce, copy, modify, decompile, disassemble or reverse engineer any portion of

this Data, and may not transfer or distribute it in any form, for any purpose, except to the extent such restrictions are expressly prohibited or limited by applicable law.

Restrictions:

Except where you have been specifically licensed to do so by NISSAN and without limiting the preceding paragraph, you may not:

- a. use this Data with any products, systems, or applications installed or otherwise connected to or in communication with vehicles, capable of vehicle navigation positioning, dispatch, real time route guidance, fleet management or similar applications;
- b. use this Data with or in communication with any positioning devices or any mobile or wireless-connected electronic or computer devices, including without limitation mobile phones, palmtop and handheld computers, pagers, and personal digital assistants or PDAs.

Warnings:

The Data may contain inaccurate or incomplete information due to the passage of time, changing circumstances, sources used and the nature of collecting comprehensive geographic data, any of which may lead to incorrect results.

No Warranty:

This Data is provided to you "as is," and you agree to use it at your own risk. NISSAN and its licensors (and their licensors and suppliers) make no guarantees, representations or warranties of any kind, express or implied, arising by law or otherwise, including but not limited to, content, quality, accuracy, completeness, effectiveness, reliability, fitness for a particular purpose, usefulness, use or results to be obtained from this Data, or that the Data or server will be uninterrupted or error-free.

Disclaimer of Warranty:

NISSAN AND ITS LICENSORS (INCLUDING THEIR LICENSORS AND SUPPLIERS) DISCLAIM ANY WARRANTIES, EXPRESS OR IMPLIED, OF QUALITY, PERFORMANCE, MERCHANTABILITY FITNESS FOR A PARTICULAR PURPOSE OR NON-INFRINGEMENT.

Some countries, local laws and territories do not allow certain warranty exclusions, so to that extent the above exclusion may not apply to you.

Disclaimer of Liability:

NISSAN AND ITS LICENSORS (INCLUDING THEIR LICENSORS AND SUPPLIERS) SHALL NOT BE LIABLE TO YOU: IN RESPECT OF ANY CLAIM, DEMAND OR ACTION, IRRE-

SPECTIVE OF THE NATURE OF THE CAUSE OF THE CLAIM, DEMAND OR ACTION ALLEGING ANY LOSS, INJURY OR DAMAGES, DIRECT OR INDIRECT, WHICH MAY RESULT FROM THE USE OR POSSESSION OF THE INFORMATION; OR FOR ANY LOSS OF PROFIT, REVENUE, CONTRACTS OR SAVINGS, OR ANY OTHER DIRECT, INDIRECT, INCIDENTAL, SPECIAL OR CONSEQUENTIAL DAMAGES ARISING OUT OF YOUR USE OF OR INABILITY TO USE THIS INFORMATION, ANY DEFECT IN THE INFORMATION, OR THE BREACH OF THESE TERMS OR CONDITIONS, WHETHER IN AN ACTION IN CONTRACT OR TORT OR BASED ON A WARRANTY, EVEN IF NISSAN OR ITS LICENSORS (OR THEIR LICENSORS OR SUPPLIERS) HAVE BEEN ADVISED OF THE POSSIBILITY OF SUCH DAMAGES.

Some countries or local laws do not allow certain liability exclusions or damages limitations, so to that extent the above may not apply to you.

Export control:

You agree not to export from anywhere any part of the Data provided to you or any direct product thereof except in compliance with, and with all licenses and approvals required under, applicable export laws, rules and regulations.



Entire Agreement:

These terms and conditions constitute the entire agreement between NISSAN (and its licensors, including their licensors and suppliers) and you pertaining to the subject matter hereof, and supersedes in their entirety any and all written or oral agreements previously existing between us with respect to such subject matter.

3-16 **Map settings**



# 4 Navigation

About route guidance . . . . .	4-2	Setting a destination from the address book . . . . .	4-17
Voice guidance during route guidance . . . . .	4-2	Setting a new entry to the address book . . . . .	4-17
Navigation screen . . . . .	4-3	Setting an entry as a destination. . . . .	4-18
Basic operation . . . . .	4-3	Setting a destination from the address book	
Available setting items . . . . .	4-3	using Voice Recognition (if so equipped) . . . . .	4-18
Setting a destination . . . . .	4-5	Setting an intersection as a destination . . . . .	4-19
Available destination setting methods . . . . .	4-5	Setting a city center as a destination. . . . .	4-19
Setting a destination from a street address . . . . .	4-6	Traffic feature . . . . .	4-20
Setting a destination from points of interest. . . . .	4-9	Displaying traffic events along route . . . . .	4-20
Searching for nearby restaurants or		Traffic flow feature . . . . .	4-21
gas stations. . . . .	4-10	Traffic settings . . . . .	4-21
Searching for places near current location. . . . .	4-11	Weather feature . . . . .	4-22
Searching for points of interest in another		Displaying weather information on the	
city . . . . .	4-12	screen . . . . .	4-22
Searching for places using		Fuel prices. . . . .	4-24
Voice Recognition (if so equipped) . . . . .	4-13		
My points of interest/User-defined points of			
interest (POIs) . . . . .	4-13		



## ABOUT ROUTE GUIDANCE

After setting the destination, select “Start” to begin route guidance.

During route guidance, the system navigates you through the guide points using visual and voice guidance.

**CAUTION**

- The navigation system visual and voice guidance is for reference purposes only. The contents of the guidance may be inappropriate depending on the situation.
- When driving along the suggested route, follow all traffic regulations (for example, one-way traffic).

 “Route guidance” (page 6-2)

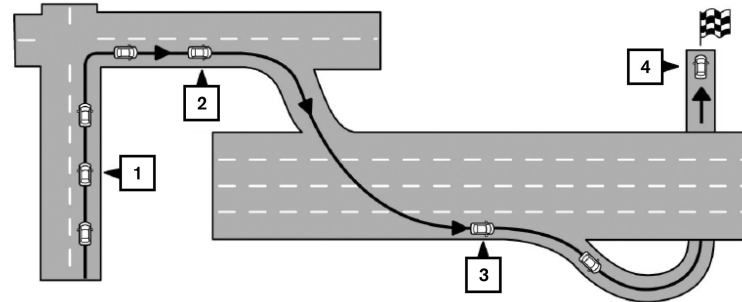

### VOICE GUIDANCE DURING ROUTE GUIDANCE

When approaching a guide point (intersection or corner), destination, etc., during route guidance, voice guidance announces the remaining distance and/or turning direction.

Touch “Voice” on the upper left of the screen to repeat the voice guidance.

Example of voice guidance:

**1** “In about one quarter mile (400 meters), right (or left) turn.” “Right (or left) turn ahead.”

- LNV0943
- 2** “In about one quarter mile (400 meters) freeway entrance on your right onto (road number and direction).” “Freeway entrance on your right onto (road number and direction).”
- 3** “In about one mile (1.6 kilometers), exit on your right.” “Take the second exit on your right.”
- 4** “You have reached your destination. Ending route guidance.”

## 4-2 Navigation

## NAVIGATION SCREEN

Several methods are available to set your destination.



LNV2409

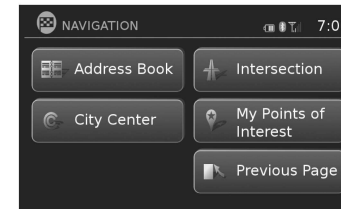

LNV2410

### BASIC OPERATION

1. Press the NAV button.
2. Select the appropriate destination setting method by touching the screen or scrolling with the scrolling dial.

### AVAILABLE SETTING ITEMS

- Street Address:  
Set a destination address.  
Several methods are available to set your destination.  
 "SETTING A DESTINATION"  
(page 4-5)
- Points of Interest:  
The system features a database of places such as restaurants, hotels, banks and more to assist you in navigation. These points of interest can be set as destinations and the system can then calculate a route.

**Navigation 4-3**

- Cancel Route:

Touch “Cancel Route” to cancel the route guidance.



**NOTE:**

**If route guidance is not active, “Cancel Route” cannot be operated.**

- Previous Destinations:



Searches for a destination from the previous destinations in the destination memory.

Up to 50 previous destinations will be automatically stored. If the number of previous destinations exceeds 50, the oldest one will be removed from the list and the newest one will be added.

To manually delete a previous destination entry, select an entry from the list and then touch the “Delete” key.

Touch the “Save” key to add a previous destination to the address book.

Previous destinations can also be selected using the NISSAN Voice Recognition System (if so equipped):

1. Press the  or  button on the steering wheel. The system provides prompts and waits for voice commands.

#### 4-4 Navigation

2. Say “Navigation”.
3. Say “Previous destinations”.
4. Speak the number of an entry on the displayed list to choose that destination or say “Next Page” to view more entries (if available).

If no route is set, route guidance is calculated automatically. If a route is set, say “Replace Destination” to use the chosen previous destination in Step 4 as the new destination. Say “Set as Waypoint” to add the chosen previous destination as a waypoint on the current route. Say “Show on Map” to show the chosen previous destination on the map.

For more information about the NISSAN Voice Recognition System, see the vehicle Owner’s Manual.





**NOTE:**

**It is not possible to retrieve deleted previous destination entries.**

- Home:

Your home address can be entered as a destination.

Home can also be set as a destination using the NISSAN Voice Recognition System (if so equipped):

1. Press the  or  button on the steering wheel. The system provides prompts and waits for voice commands.
2. Say “Navigation”.
3. Say “Home”.

If a home location is set, route guidance to the home location is calculated automatically.

For more information about the NISSAN Voice Recognition System, see the vehicle Owner’s Manual.

- Address Book:

Touch “Address Book” to access stored addresses.

- Intersection:

Select “Intersection” to designate an intersection of two roads as a destination.

- City Center:

Touch “City Center” to designate a city as a destination.

## SETTING A DESTINATION

- My Points of Interest:

My Points of Interest are locations entered into the system via the vehicle's USB port.



"MY POINTS OF INTEREST/USER-DEFINED POINTS OF INTEREST (POIs)" (page 4-13)

Press the NAV button. The methods for setting a destination are shown.

If route guidance is active, you can choose how to use the new destination. Select "Add as Waypoint" to keep the current destination and to add the current destination as a waypoint along the route. Select "Replace" to cancel the current route and replace the current destination with the new destination.

### AVAILABLE DESTINATION SETTING METHODS

- "Street Address"



"SETTING A DESTINATION FROM A STREET ADDRESS" (page 4-6)

- "Points of Interest"



"SETTING A DESTINATION FROM POINTS OF INTEREST" (page 4-9)

- "My Points of Interest"



"MY POINTS OF INTEREST/USER-DEFINED MY POINTS OF INTEREST" (page 4-13)

- "Address Book"



"SETTING A DESTINATION FROM THE ADDRESS BOOK" (page 4-17)

- "Intersection"



"SETTING AN INTERSECTION AS A DESTINATION" (page 4-19)

- "City Center"



"SETTING A CITY CENTER AS A DESTINATION" (page 4-19)

## SETTING A DESTINATION FROM A STREET ADDRESS

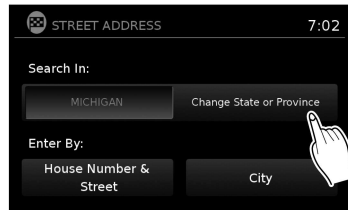

LNV2426

1. Press the NAV button.
2. Touch "Street Address".
3. If the state or province shown on the screen is correct, proceed to step 5. If the state or province shown on the screen is not correct, touch "Change State/Province".



LNV2415

4. Enter the name of the state or province. The display shows the touch keyboard.



"HOW TO INPUT CHARACTERS" (page 2-8)

The keyboard has an intelligent spelling setting, so it excludes non-existing combinations. On the top right of the screen, the number of matches is shown. At any time, touch the "List" key to display a list of possible names based on the letters currently entered. When the number of matches is reduced to six or less, a list will be shown automatically.

5. Touch "City"



### NOTE:

It is possible to choose "House Number & Street" at this step if you want to manually enter the street name. However, the system can automatically narrow down the street in most cases when you enter the city name first. Entering by city can also be useful if you are unsure of the street's correct spelling.

## 4-6 Navigation



LNV2406

6. The display shows a touch keyboard to enter the city of the destination. Enter the name of the city. At any time, touch the "List" key to display a list of possible city names based on the letters currently entered. When the number of matches is reduced to six or less, the city list will be shown automatically.

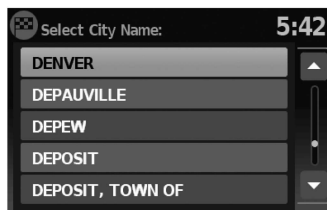

LNV0953

7. Touch the city name on the list.

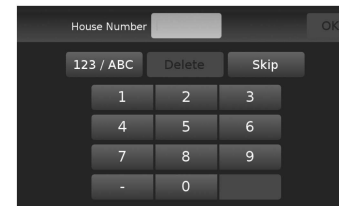

LNV2411

8. The display shows a touch keyboard to enter the house number of the destination. If the house number is not known, touch "Skip" and a default location on the street will be used.



**NOTE:**

**If you choose "Skip", a default location is chosen by the system and you will have a chance to change the position once the map is displayed. See step 12 for more instructions on changed the default location.**



LNV2412

9. The display shows a touch keyboard to enter the street name. Enter the name of the street. At any time, touch the “List” key to display a list of possible street names based on the letters currently entered. When the number of matches is reduced to six or less, the street list will be shown automatically.

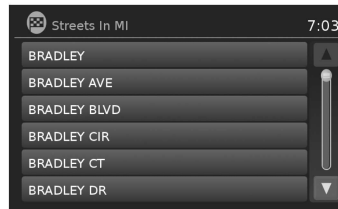

LNV2413

10. Touch the street name on the list.
11. If the house number entered in step 8 does not exist on the street in the chosen city, “The house number is not available” will be displayed. Select “Show Map” or “Change Number”.



**NOTE:**

**You will have a chance to change the position from the default location once the map is displayed. See step 12 for more instructions on changing the default location.**

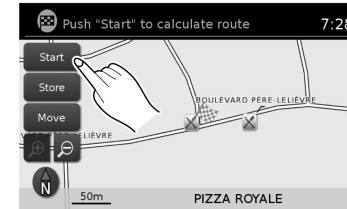

LNV2438

12. A map of the destination is displayed on the screen. Touch “Start” to calculate the route.

The map of the destination is always displayed in 2D North Up. Once the “Start” key is touched, the system returns to the current map settings.



**NOTE:**

**If you did not enter an exact street address earlier in the process, the system will have chosen a default location, either along the street or within a range of addresses on that street. To move the map from that default position, touch the “Move” key. A message will be displayed asking if you want to touch a new location for the destination. Touch “OK” when complete.**



**4-8 Navigation**



Touch “Store” to store the location in the address book.

 “SETTING A NEW ENTRY TO THE ADDRESS BOOK” (page 4-17)

A destination can also be set from a street address using the NISSAN Voice Recognition System (if so equipped):

1. Press the  or  button on the steering wheel. The system provides prompts and waits for voice commands.
2. Say “Navigation”.
3. Say “Enter address in steps”.
4. When prompted, say the name of the state or province. If the system cannot clearly interpret the name of the state or province, a list is provided with possible matches. Speak the number of the state or province displayed on the screen or say “Spell State” to spell the name of the state.
5. When prompted, say the name of the city. If the system cannot clearly interpret the name of the city, a list is provided with possible matches. Speak the number of the city displayed on the screen or say “Spell City” to spell the name of the city.
6. When prompted, say the name of the street. If the system cannot clearly interpret the name of the street, a list is provided with possible matches. Speak the number of the street displayed on the screen or say “Spell Street” to spell the name of the street.
7. When prompted, say the house number or say “No House Number” to display a default location on the chosen street within the chosen city. If the house number spoken is not on the chosen street, the system will notify you that the number is out of range and to restate the number or say “No House Number”.

If a route is active, say “Replace Destination” to replace the current destination with the new street address or say “Set as Waypoint” to set the new street address as a waypoint on the current route.

If a route is not set, say “Set as Destination” to set the new street address as the destination and begin route guidance.

Say “Show on Map” to display the new street address on the map.

For more information about the NISSAN Voice Recognition System, see the vehicle Owner’s Manual.

## SETTING A DESTINATION FROM POINTS OF INTEREST

The system features a database of points of interest such as restaurants, hotels, banks and more to assist you in navigation. These points of interest can be set as destinations and the system can then calculate a route.

 “MY POINTS OF INTEREST/USER-DEFINED POINTS OF INTEREST (POIs)” (page 4-13)



LNV2409

### SEARCHING FOR NEARBY RESTAURANTS OR GAS STATIONS

While a wide variety of places can be searched in the system, shortcut buttons are available for restaurants and gas stations.

1. Press the NAV button.
2. Touch "Points of Interest".



LNV2437

3. Touch "Nearby Restaurants", "Nearby Gas Stations", "Nearby Parking" or "Nearby ATMs".
4. The system searches for destinations within 50 miles (80 km) of the current position.



LNV2407

5. Places are shown based on the straight line distance to the current position. The arrow on the right shows the direction of the destination. Touch the desired destination on the list.



**NOTE:**

**A maximum of 200 destinations will be listed when searching with this method.**

## 4-10 Navigation



LNV2408

6. A detailed description of the destination is provided.
- Press the BACK or BACK button to go back and pick another destination.
  - Touch “Call” to call the destination (if a phone number is available) using the Bluetooth® Hands-Free Phone System. See the vehicle Owner’s Manual for more information about the Bluetooth® Hands-Free Phone System.
  - Touch “Map” to show a map of the destination.
  - Touch “Start” to calculate the route to the destination.



LNV2409

### SEARCHING FOR PLACES NEAR CURRENT LOCATION

1. Press the NAV button.
2. Touch “Points of Interest”.

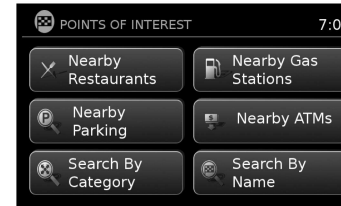

LNV2437

3. Touch “Search by Category”.
4. Touch “Near Current Location”.

When searching by category, you can browse destinations from a variety of categories and subcategories, including:

- Automotive
- Banking & Business
- Emergency
- Hotel/Motel
- Leisure
- Public Places
- Restaurant
- Shopping
- Travel

**Navigation 4-11**

If you choose “By Name”, you can search for places using a specific name. The touch keyboard is shown.

 “HOW TO INPUT CHARACTERS”  
(page 2-8)

 **NOTE:**

- When using “Search By Category”, the system will search for up to 200 matches within 50 miles (80 km) of the current position.
- When using “Search By Name”, the system will search for up to 30 matches within 50 miles (80 km) of the current position.
- If the destination is not found within the 50 mile (80 km) search radius, you can search for places around a specific city name.

 “SEARCHING FOR POINTS OF INTEREST IN ANOTHER CITY”  
(page 4-12)

5. Destinations are shown based on the distance to the selected position. The arrow on the right shows the direction of the destination. The distance shown is a straight line distance.

Touch the desired destination from the list.

**4-12 Navigation**

6. A detailed description of the destination is provided.

Press the BACK or  BACK button to go back and pick another destination or touch “Start” to have the system calculate the route to the destination.

**SEARCHING FOR POINTS OF INTEREST IN ANOTHER CITY**

1. Press the NAV button.
2. Touch “Points of Interest”.
3. Touch “Search By Category” or “Search By Name”.
4. Touch “In Another City”.
5. Touch “Change State/Province” if the state or province shown is not correct.
6. If necessary, enter the name of the state or province.

The display shows the touch keyboard.

 “HOW TO INPUT CHARACTERS” (page 2-8)

The keyboard has an intelligent spelling setting, so it excludes non-existing combinations. On the top right of the screen, the number of matches is shown.

7. Touch “City”.

8. A touch keyboard is displayed. Enter the name of the desired city.

Press “List” at any time to display a list of remaining cities. Touch the desired city.

9. If you chose “Search By Category” in Step 4, you can browse destinations from a list of categories and subcategories.

If you choose “Search By Name” in Step 4, you can search for places using a specific name. The touch keyboard is shown.

 **NOTE:**

- When using “Search By Category”, the system will search for up to 200 matches within 50 miles (80 km) of the chosen city.
- When using “Search By Name”, the system will search for up to 30 matches within 50 miles (80 km) of the chosen city. If no matches are found, touch “Change Name” to search for another name.

10. Destinations are shown based on the distance from the selected position. The arrow on the right shows the direction of the destination. The distance shown is a straight line distance from the city center.



Touch the desired destination from the list.

11. A detailed description of the destination is provided.

Press the BACK or ↶ BACK button to go back and pick another destination or touch "Start" to have the system calculate the route to the destination.

### SEARCHING FOR PLACES USING VOICE RECOGNITION (if so equipped)

Places can be set as destinations using the NISSAN Voice Recognition System:

1. Press the  or  button on the steering wheel. The system provides prompts and waits for voice commands.
2. Say "Navigation".
3. Say "Points of Interest" followed by a brand name.
4. Say number of the point of interest from the available list on the screen.
5. There are up to four options to search for a point of interest:
  - Say "Along Route" to search for the desired places along the current route.

- Say "Nearby" to search for the desired places close to the vehicle's current location.
  - Say "Near Destination" to search for the desired places near the route's destination.
  - Say "In another city" so search for the desired places in another city. Selecting this option will lead to a series of other steps.
6. The system displays a list of results fitting the search criteria. Say the number of the desired entry on the list.

If a route is active, say "Replace Destination" to replace the current destination with the new street address or say "Set as Waypoint" to set the new street address as a waypoint on the current route.

If a route is not set, say "Set as Destination" to set the new street address as the destination and begin route guidance.

Say "Show on Map" to display the new street address on the map.

For more information about the NISSAN Voice Recognition System, see the vehicle Owner's Manual.

### MY POINTS OF INTEREST/USER-DEFINED POINTS OF INTEREST (POIs)

A point of interest (POI) in the My Points of Interest database is a specific location of interest such as a gas station or bank. The POI consists of a longitude value, a latitude value and a name.

Additional POIs can be added to the system using the vehicle's USB port. For more information about using the USB port, see your vehicle's owner's manual.

The POIs can be set as a destination or be setup to activate POI warnings that display a pop-up message when the vehicle approaches certain areas such as hazard spot warnings.



**NOTE:**

- In order to save the user-defined points of interest data, a USB mass storage device is required. The user-defined points of interest data cannot be saved on the SD-card which contains the navigation data.
- User-defined points of interest are not shown in the map representation.



- The system recognizes the user-defined points of interest (POI) data and then asks the user via a pop-up message if the data needs to be downloaded into the system.
- If you confirm the download, the available user Points of Interest in the system internal memory will be deleted and the new ones in the USB mass storage device will be downloaded into the internal memory of the system.
- The progress of the download is shown by a progress-bar. When the download is finished, the user is notified that the USB mass storage device can be removed.

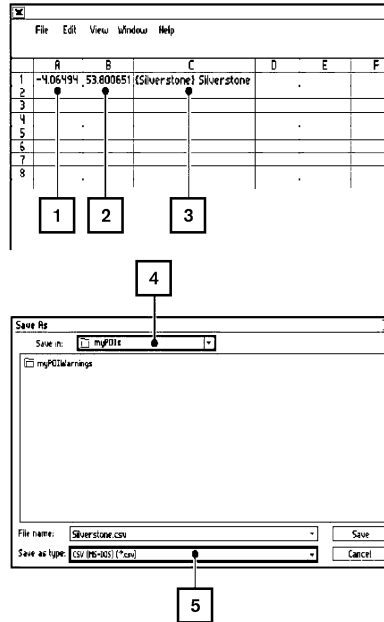

### Creating user-defined points of interest (POIs)

- 1 Longitude
- 2 Latitude
- 3 Name
- 4 Location/Folder to save
- 5 File name

POI data can be downloaded from the Internet or created in a simple text editor in CSV (Comma Separated Values) file format.

There are two kinds of POI data supported by the system:

- User POIs – user-defined points of interest (POI) that can later be set as a destination and found using route guidance.
- POI-warnings – user-supplied areas such as hazard spots that the system displays in a pop-up window when the vehicle is approaching the designated area.

LNV1017

## 4-14 Navigation

Perform the following procedure to create your own User POIs:

1. Connect a USB mass storage device to your personal computer.
2. Use a standard software program to create a list of POIs. Make sure the software can support the CSV file format.
3. In the first column, enter the longitude value of the position of the POI.
4. In the second column, enter the latitude value of the position of the POI.
5. In the third column, enter the name of the POI. Information entered in the fourth column, such as address or phone number, will be appended to the name of the POI.
6. Add more rows if necessary.
7. Save the file with the extension .csv (for example, myplacesfile.csv).

**!** **NOTE:**

**The name of the .CSV file will be used to create a My Points of Interest category in the system. Create separate .CSV files with different names to create other My Points of Interest categories.**

8. Make sure to select the USB mass storage device as the location to save, using the exact folder name “/myPOIs” for User POIs or “/myPOIs/myPOLwarnings”

for POI-warnings. For example, if the USB mass storage device’s root folder is represented by f:/, save the file to the folder “f:/myPOIs” for User POIs or to the folder “f:/myPOIs/myPOLwarnings”

for POI-warnings.

9. Connect the USB mass storage device to the vehicle’s USB port. For more information about the USB port, see your vehicle’s Owner’s Manual.

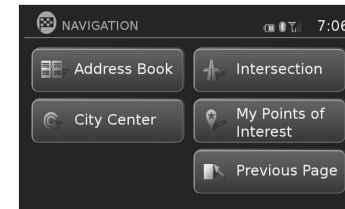

LNV2410

### Adding user-defined points of interest (POIs)

Perform the following procedure to add your User POIs to the system:

1. Press the NAV button.
2. Touch “Next Page”.
3. Touch “My Points of Interest”.
4. If a USB mass storage device with the new POI data is connected, the system will automatically ask if you want to transfer the POI data. Touch “Download” to begin the transfer or “Cancel” to cancel the procedure.

**!** **NOTE:**

**New POI data will overwrite POI data already in the internal memory.**

**Navigation 4-15**

- The POI data on the USB mass storage device is transferred to the vehicle.



**NOTE:**

**A maximum of 8 MB of POI data can be added to the system.**

- Once the download process is complete, the available POIs are displayed in a list on the screen.
- Touch the name of a POI on the list to set it as the destination.
- Touch "Start" to calculate the route.

A user-defined POI in the My Points of Interest database can also be set as the destination by following the procedure below:

- Press the NAV button.
- Touch "Next Page".
- Touch "My Points of Interest"
- Touch the name of the user-defined Point of Interest to set that entry as a destination.

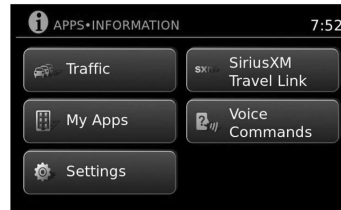

LNV2459

**Deleting user-defined points of interest (POIs)**

Perform the following procedure to delete the user-defined POIs stored in the My Points of Interest memory:

- Press the APPS or MENU button.
- Touch "Settings".

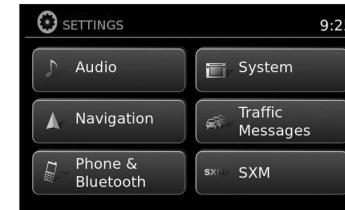

LNV2460

- Touch "Navigation".
- Touch "My Points of Interest Settings"
- Touch "Remove My Points of Interest From System".
- A pop-up is displayed to confirm that you want to delete all User POIs (My Points of Interest) from the system. Touch "Yes" to delete the User POIs or "No" to cancel.

Other options are available on the "My Points of Interest Settings" screen:

- My Points of Interest Alert**  
Select to adjust how alerts are provided when approaching a destination set by My Points of Interest. Choose "OFF" to disable the alert. Choose "Show Only" to display the alert on the screen. Choose "Show & Beep" to display the alert on the screen and play an audible sound.

**4-16 Navigation**



## SETTING A DESTINATION FROM THE ADDRESS BOOK

- Points of Interest Alert Distance  
Select to choose from the available list a distance away from the My Points of Interest destination at which to activate the alert.

This option allows you to set and store the destination in the address book and use the stored destinations to calculate a route.

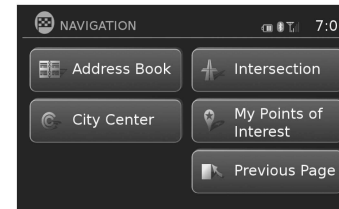

LNV2410

## SETTING A NEW ENTRY TO THE ADDRESS BOOK

1. Press the NAV button.
2. Touch "Next Page".
3. Touch "Address Book".
4. Touch "Add New Entry".

There are four possibilities shown:



### NOTE:

**Up to 50 address book entries can be stored. If the number of address book entries exceeds 50, one must be deleted before the new one can be added.**



"SETTING AN ENTRY AS A DESTINATION" (page 4-18)

**Navigation 4-17**

- “Street Address”

This option allows you to save a new entry by selecting the address.



“SETTING A DESTINATION FROM A STREET ADDRESS” (page 4-6)

- “Previous Destination”

This option allows you to save a destination in the address book from a location stored in the previous destination memory.

Touch the destination you would like to save into the address book.

The touch keyboard gives the option to change the name of the selected destination.

Touch “OK”. The system confirms the entry and adds it to the address book.

- “Current Destination”

This option allows you to store the currently set destination in the address book when a route is active. This option is only available when a route is active.

Touch “Current Destination”.

The touch keyboard gives the option to change the name of the destination.

#### 4-18 Navigation

Touch “OK”. The system confirms the entry and adds it to the address book.

- “Current Position”

This option allows you to set the current position as a destination in the address book.

Touch “Current Position”.

The touch keyboard gives the option to change the name of the destination.

Touch “OK”. The system confirms the entry and adds it to the address book.

#### SETTING AN ENTRY AS A DESTINATION

Instead of touching “Add New Entry”, you can touch any previously saved address.

The detailed description of the entry is shown. If information for the destination is not available, latitude and longitude coordinates will be shown.

You can rename or delete the entry. Touch “OK” to set the entry as a destination.

The system will calculate the route to the address chosen.

#### SETTING A DESTINATION FROM THE ADDRESS BOOK USING VOICE RECOGNITION (if so equipped)

Entries in the address book can be set as destinations using the NISSAN Voice Recognition System:

1. Press the or button on the steering wheel. The system provides prompts and waits for voice commands.
2. Say “Navigation”.
3. Say “Address Book”.
4. Say the number of the entry in the address book displayed on the screen.

If a route is active, say “Replace Destination” to replace the current destination with the address book entry or say “Set as Waypoint” to set address book entry as a waypoint on the current route.

If a route is not set, route guidance is calculated to the address book entry.

Say “Show on Map” to display the location of the address book entry on the map.

For more information about the NISSAN Voice Recognition System, see the vehicle Owner’s Manual.

## SETTING AN INTERSECTION AS A DESTINATION

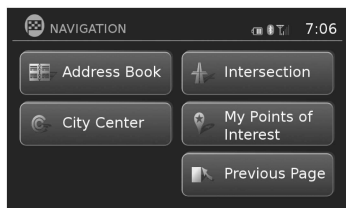

LNV2410

An intersection of two streets can be set as a destination. To set an intersection as the destination:

1. Press the NAV button.
2. Touch "Next Page".
3. Touch "Intersection".
4. Touch "Change State/Province" if the state or province displayed is not correct.
5. If necessary, enter the name of the state or province.

The display shows the touch keyboard.

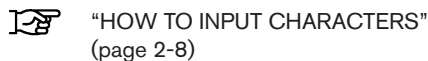

6. Press "List" at any time and a list of remaining cities will be shown. Touch the desired city.

7. Touch "Street".  
The display shows the touch keyboard.
8. Touch the name of the desired street.
9. A list of intersecting streets will be shown if six or less exist. Otherwise, the touch keyboard will be displayed again so that the name of the second street in the intersection can be entered. Enter the second street name.
10. Select the intersecting street.
11. Touch "Start".

The route to the intersection will be calculated.

## SETTING A CITY CENTER AS A DESTINATION

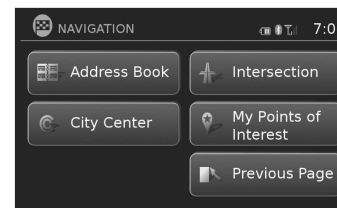

LNV2410

The center of a city can be set as a destination. To set a city center as a destination:

1. Press the NAV button.
2. Touch "Next Page".
3. Touch "City Center".
4. If the state shown is not correct, touch "Change State or Province". Otherwise, proceed to step 7.
5. Enter the name of the state or province. The display shows the touch keyboard.

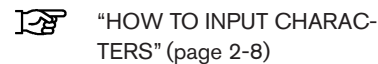

The keyboard has an intelligent spelling setting, so it excludes non-existing combinations. On the top right of the screen, the number of matches is shown.

**Navigation 4-19**

## TRAFFIC FEATURE

6. Touch "City"
7. Enter the name of the first street. The display shows the touch keyboard.
8. Touch "Start" to calculate the route to the city center.

The Navigation System receives traffic information from NavTraffic to inform you of traffic events and guide you to an alternate route. Traffic events include accidents, road construction, heavy traffic and other factors that affect the route ahead.

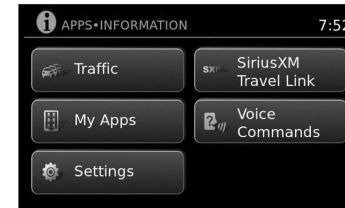



LNV2459

### DISPLAYING TRAFFIC EVENTS ALONG ROUTE

When a route is active, press the APPS  or MENU button and then touch "Traffic" to display the traffic event nearest the current vehicle location. The location and nature of the traffic event is displayed on the screen. Three menu options are available on the screen.



#### NOTE:

**This feature can also be accessed using the NISSAN Voice Recognition System (if so equipped) by pressing the  or  button on the steering wheel and when prompted, saying "Information" then "Traffic".**

- “Avoid Road On Route.”

Touch the “Avoid Road On Route.” key to direct the navigation system to avoid the area impacted by the listed traffic event. The next screen lists multiple options.

Touch the “Detour by Distance” key to avoid the road listed on the traffic event. You can choose the distance over which the system avoids the affected road. Touch the “+” or “-” key to set the distance and then touch “Recalculate Route” to calculate the new route.

Touch the “Avoid Segment of Route List” key to avoid a series of roads on the route list due to the traffic event. The route list is displayed on the screen. Touch the names of two streets on the list to avoid that portion of the route and then touch “Recalculate Route” to calculate the new route.

- “List All Traffic Events”

Touch the “List All Traffic Events” key to display a list of all traffic events in the area, including those which are not directly along the current route. Touch the line of a specific event on the screen to see more details about that item.

## TRAFFIC FLOW FEATURE

Using information received from NavTraffic, the system informs you of traffic levels on certain highways and roads in the area along the route. Press the MAP button to display the map of the current vehicle location. Any roads with traffic flow information will appear colored as follows:

- Green: traffic is light and moving at normal speeds. (>45 mph)
- Yellow: traffic is heavy and moving slowly. (10-45 mph)
- Red: traffic is gridlocked and not moving. (<10 mph)

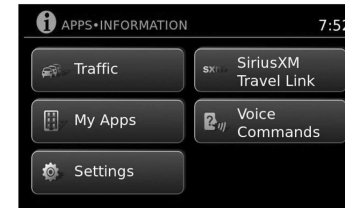

LNV2459

## TRAFFIC SETTINGS

To access the settings for the traffic feature:

1. Press the APPS or MENU button.
2. Touch the “Settings” key.



LNV2460

3. Touch the “Traffic Messages” key.  
 The following settings can be adjusted:
- Dynamic Guidance
  - Show Traffic Incidents
  - Show Traffic Flow
  - Announce Traffic Alerts

4-22 **Navigation**

**WEATHER FEATURE**

NavWeatherXM information is a subscription service offered by SiriusXM Satellite Radio.

This service provides real-time information regarding current weather and forecasts where available. The weather information is broadcast to the vehicle by the SiriusXM satellites.

**⚠ WARNING**

**NavWeatherXM information is not a substitute for attentive driving. Weather conditions change constantly and emergency situations can arise without warning. Relying only on NavWeatherXM information could result in serious personal injury.**

XM NavWeather information is available in limited markets. To subscribe to or check if this service is available in the area, call 1-866-635-2349 or access [www.siriusxm.com/navweather](http://www.siriusxm.com/navweather).

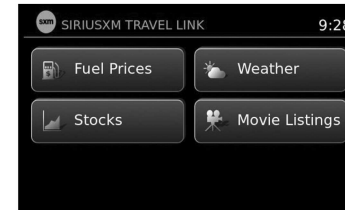

LNV2461

**DISPLAYING WEATHER INFORMATION ON THE SCREEN**

1. Press the APPS or MENU button.
2. Touch “SiriusXM Travel Link”.
3. Touch “Weather”.



LNV2441

The weather conditions for the current location are displayed on the screen.

**! NOTE:**

**In some areas, the location name at the top of the screen may not match the location shown for “Weather Station” due to differences in where weather information is collected.**

Touch “Forecast” to see the weather forecast for the selected area for the next five days.

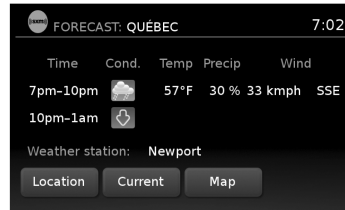

LNV2442



Touch “Location” to view weather information for a different location:

- “Near Current Location”  
Select to view weather information for the current location.
- “Near Destination”  
Select to view weather information near the destination of the current route. Route guidance must be active for this option to be available.
- “In Another City”  
Select to view weather information for a different city. Follow the on screen prompts and character input screens to select the desired location.

**! NOTE:**

**When the weather function is accessed for the first time of the day, the GPS location may not be used. If this occurs, touch the “Location” key to update the location.**

**! NOTE:**

**This feature can also be accessed using the NISSAN Voice Recognition System (if so equipped) by pressing the  or  button on the steering wheel and when prompted, saying “Information” then “Current Weather” or “Weather Forecast”.**



## FUEL PRICES

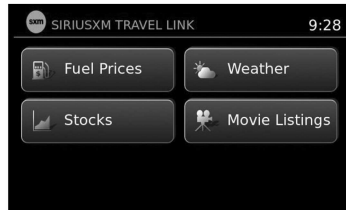



LNV2461

To display fuel prices at gas stations in the surrounding area on the screen:

1. Press the **APPS**  or MENU button.
2. Touch "SiriusXM Travel Link".
3. Touch "Fuel Prices".

**!** **NOTE:**

**This feature can also be accessed using the NISSAN Voice Recognition System (if so equipped) by pressing the  or  button on the steering wheel and when prompted, saying "Information" then "Fuel Prices".**

### 4-24 Navigation

4. A list of gas stations is displayed with the distance and direction to each entry. Touch an entry on the screen to view information about that gas station.
5. The name, address and phone number of the gas station are displayed. If available, the prices for each grade of gasoline are also displayed. Touch "Store" to store the location in the address book. Touch "Call" to call the location using the Bluetooth® Hands-Free Phone System. Touch "Map" to view the location on the map. Touch "Start" to begin route guidance to the location.



## 5 Other settings

System settings .....	5-2	Brightness.....	5-3
Touchscreen click .....	5-3	Rear View Camera Settings .....	5-4
System beeps.....	5-3	Temperature Unit Settings .....	5-4
Return to factory settings.....	5-3	Clock settings.....	5-4
Display settings .....	5-3	Set clock manually.....	5-5
Display .....	5-3	Language settings.....	5-5



## SYSTEM SETTINGS

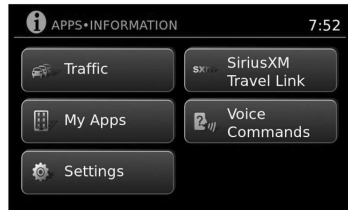

LNV2459

The system can be customized according to your preference.

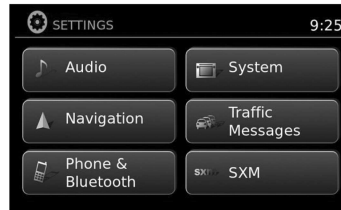

1. Press the **APPS** or MENU button.
2. Touch "Settings".









LNV2460

3. Touch "System".
4. Select the preferred setting item on the screen and the next screen will be shown. You may need to use the scrolling dial or the touch screen to scroll if more than one screen of options is available.

The following settings are available:

- Display  
 "DISPLAY SETTINGS" (page 5-3)
- Clock  
 "CLOCK SETTINGS" (page 5-4)
- Language  
 "LANGUAGE SETTINGS" (page 5-5)

### 5-2 Other settings

- Camera  
 "CAMERA DISPLAY SETTINGS" (page 5-4)
- Temperature Unit  
 "TEMPERATURE UNIT" (page 5-4)
- Touchscreen Click  
 "TOUCHSCREEN CLICK" (page 5-3)
- System Beeps  
 "SYSTEM BEEPS" (page 5-3)
- "Return to Factory Settings/Clear Memory"  
 "RETURN TO FACTORY SETTINGS" (page 5-3)
- 5. Select the button of the preferred item and adjust the setting. Alternatively, use the scrolling dial or steering wheel scrolling switch (if so equipped).
- 6. Press the BACK or  BACK button to return to the previous screen or press the NAV button to return to the current location map screen.

## TOUCHSCREEN CLICK

Use this setting to change the audible confirmation between the on or off position when a screen button is touched.

Select the "Touchscreen Click" key to toggle between On and Off.

## SYSTEM BEEPS

Use this setting to change the audible confirmation when:

- a button on the unit is pressed and held for about two seconds, such as the ☀/🌙 button.
- a pop-up message appears on the screen.

Select the "System Beeps" key to toggle between ON and OFF.

## RETURN TO FACTORY SETTINGS

Use this setting to restore the factory default settings.

Touch the "Return to Factory Settings/Clear Memory" key and then confirm the message. If you choose "Yes", the system will reset the settings to the default settings. If you choose "No", the default settings will not be restored and the display returns to the system settings screen.

## DISPLAY SETTINGS

### DISPLAY

#### Switching the display on or off

This setting allows you to turn the display on or off. When the display is turned off, the clock will still be displayed.

To turn off the display, press and hold the ☀/🌙 button.

The display will switch on when:

- the ☀/🌙 button is pressed.
- any other button is pressed.
- receiving incoming calls or during a phone call. When the call is ended, the display returns to clock display.

Voice guidance (if active) continues even when the display is turned off.

Press and hold the ☀/🌙 button for more than two seconds to switch the display to a larger display of the digital clock.

#### Changing day-night brightness

Press the ☀/🌙 button for less than two seconds to toggle:

- between day and auto (night) when headlights are on.



- between night and auto (day) when headlights are off.

While the display is showing the current brightness mode, turn the TUNE/SCROLL dial to adjust the brightness.

The day or night mode can also be toggled from the Display Settings menu.

### BRIGHTNESS

This menu allows you to adjust the brightness of the screen.

1. Press the APPS  or MENU button.
2. Touch the "Settings" key.
3. Touch the "System" key.
4. Touch the "Display" key.
5. Adjust the brightness using the "+" and "-" keys.
6. To save the setting, press the BACK or  BACK button to return to the previous screen.

Other settings 5-3

## REAR VIEW CAMERA SETTINGS

Use this setting to change the display mode (automatic/day/night) for the rear view camera. Brightness, contrast and color can also be adjusted.

1. Press the **APPS** or MENU button.
2. Touch the “Settings” key.
3. Touch the “System” key.
4. Scroll down and touch the “Camera” key.

Toggle display mode and use the “+” and “-” keys to adjust brightness, contrast and color for rear camera display.

## TEMPERATURE UNIT SETTINGS

Use this setting to change the temperature units (Fahrenheit/Celsius).

1. Press the **APPS** or MENU button.
2. Touch the “Settings” key.
3. Touch the “System” key.
4. Scroll down and touch the “Temperature Unit” key.

## 5-4 Other settings

## CLOCK SETTINGS

This setting allows you to make clock adjustments.

1. Press the **APPS** or MENU button.
2. Touch the “Settings” key.
3. Touch the “System” key.
4. Touch the “Clock” key.
5. Select the preferred setting item and make an adjustment.

- “Time Format”:

Touch the “Time Format” key to change the clock format between 12-hour and 24-hour.

- “Date Format”:

Touch the “Date Format” key to choose one of five available date formats.

- “Clock Mode”:

Select “Manual” to manually set the clock with the “Set Clock Manually” key. Select “Auto” to have the clock automatically adjusted by the GPS system. Select “Time Zone” to have the time set to a specific time zone.

- “Set Clock Manually”:

Allows you to set the clock manually. This feature is only available if “Manual” is selected for “Clock Mode”.

 “SET CLOCK MANUALLY”  
(page 5-5)

- “Daylight Savings Time”:

Touch the “Daylight Savings Time” key to toggle daylight savings time on or off. This feature is unavailable if “Clock Mode” is set to “Auto”.

- “Time Zone”:

Select and touch an appropriate time zone of the current vehicle location to bypass the GPS satellite. This feature is only available if “Time Zone” is selected for “Clock Mode”.



### NOTE:

**If “Daylight Savings Time” is set to “ON” and a time zone is chosen for an area that does not observe Daylight Savings Time, the “Daylight Savings Time” setting remains “On” and must be turned off manually.**

## LANGUAGE SETTINGS

6. After adjusting the desired settings, press the BACK or  BACK button to return to the previous screen. You can also press the MAP button to return to the current location map screen or the FM, AM, CD or AUX button to return to the audio screen.

### SET CLOCK MANUALLY

Adjust the hour, minute, day, month and year using the “+” and “-” keys.

1. Press the  or MENU button.
2. Touch the “Settings” key.
3. Touch the “System” key.
4. Touch the “Clock” key.
5. Toggle “Clock Mode” key to “Manual”.
6. Toggle “MODE” to “AM” or “PM”, then use “+” and “-” keys to adjust hour, minute, day, month and year.

After adjusting the desired settings, press the BACK or  BACK button to return to the previous screen.

This setting allows you to change the language used by the system.

1. Press the  or MENU button.
2. Touch the “Settings” key.
3. Touch the “System” key.
4. Touch the “Language” key.
5. Select the appropriate language. The available languages are:
  - English
  - Français
  - Español



Other settings 5-5

## **MEMO**

5-6 **Other settings**

## 6 General system information

Safety information .....	6-2	When a gray road is displayed on the map .....	6-4
Features of this navigation system .....	6-2	Route calculation .....	6-4
Route guidance .....	6-2	Route guidance .....	6-6
Points of Interest directory .....	6-3	Basics of voice guidance .....	6-6
Address book .....	6-3	Directions provided and the distances to guide points .....	6-6
NavTraffic information .....	6-3	Repeating voice guidance .....	6-6
Voice guidance .....	6-3	Notes on voice guidance .....	6-6
Current vehicle location .....	6-4	How to handle the display .....	6-7
Display of current vehicle location .....	6-4	Characteristics of a liquid crystal display .....	6-7
What is GPS (Global Positioning System)? .....	6-4	Maintenance of the display .....	6-8
Detailed map coverage (MCA) for the navigation system .....	6-4		



## SAFETY INFORMATION

This system is primarily designed to help you reach your destination, and it performs other functions as outlined in this manual. However the driver must use the system safely and properly. Information concerning road conditions, traffic signs and the availability of services may not always be up-to-date. The system is not a substitute for safe, proper and legal driving.

Before using the navigation system, please read the following safety information. Always use the system as outlined in this manual.

### WARNING

- **When the driver wants to operate the navigation system, first park the vehicle in a safe location and set the parking brake. Operating the system while driving can distract the driver and may result in a serious accident.**
- **Do not rely on route guidance alone. Always be sure that all driving maneuvers are legal and safe in order to avoid accidents.**
- **Do not disassemble or modify this system. If you do, it may result in accidents, fire or electrical shock.**

## 6-2 General system information

- **Do not use this system if you notice any malfunctions such as a frozen screen or lack of sound. Continued use of the system may result in accidents, fire or electrical shock.**
- **If you notice any foreign objects in the system hardware, spill liquid on the system or notice smoke or a smell, stop using the system immediately and contact a NISSAN dealer. Ignoring such conditions may lead to accidents, fire or electrical shock.**

### CAUTION

- **Some states or provinces may have laws limiting the use of video screens while driving. Use this system only where it is legal to do so.**

### NOTE:

**Do not keep the navigation system running with the engine stopped. Doing so may discharge the vehicle battery. When you use the navigation system, always keep the engine running.**

## FEATURES OF THIS NAVIGATION SYSTEM

### ROUTE GUIDANCE

The main features of the NISSAN Navigation System are visual guidance and voice guidance in selected map coverage areas. Utilizing a network of GPS (Global Positioning System) satellites, the NISSAN Navigation System tracks the location on the map and navigates to a preferred location.

Once you set the destination in a map coverage area, the NISSAN Navigation System will calculate a route from your current location to your destination. The real-time map display and turn-by-turn voice guidance leads the driver along the route. These features can be especially helpful when driving to unfamiliar locations.

The system may be unable to set a destination and/or calculate a route when the destination is outside the map coverage area. Additionally, voice guidance may not be available if the destination is outside the map coverage area. For more information on how to set a destination, refer to Section 4.



## POINTS OF INTEREST DIRECTORY

The NISSAN Navigation System offers an extensive Points of Interest directory in map coverage areas. This directory includes a wide variety of destinations. By accessing the Points of Interest directory, you can search for addresses for a destination, and just by pushing a button, the NISSAN Navigation System will calculate a route to the destination.

The Points of Interest directory has many uses. For example, the directory can be sorted by the various types of restaurants near your current location. If you need a bank or a gas station, the NISSAN Navigation System can navigate you to the closest preferred location using the Points of Interest entered in the system.

 "SETTING A DESTINATION FROM POINTS OF INTEREST" (page 4-9)

## ADDRESS BOOK

The address book can store up to 50 locations from map coverage areas into a personal directory. This is especially useful for frequently visited locations, such as clients, relatives and friends. The address book function allows easy access to frequently visited locations when setting them as your destination.

 "SETTING A DESTINATION FROM THE ADDRESS BOOK" (page 4-17)

## NAVTRAFFIC INFORMATION

When available, the NavTraffic Information broadcast may help to avoid delays due to traffic incidents. Traffic jams, roadwork, closed roads around the current location, etc. are represented graphically on the map by icons depicting the nature of the event. Incidents on the route are automatically displayed when they are approached.

The NavTraffic Information feature, via the guidance mode, may help to detour around traffic problems. For more information on the NavTraffic Information feature, refer to section 4.

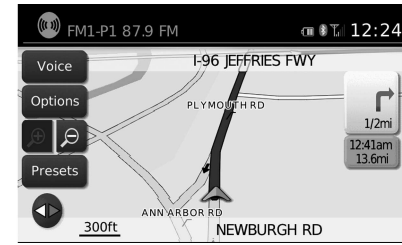

LNV2026

## VOICE GUIDANCE

Route guidance is provided through voice and visual instructions. Voice guidance announces the appropriate directions when approaching an intersection at which you need to turn. To repeat the voice guidance, touch the "Voice" key.

The voice guidance can be alternately enabled or disabled by touching and holding the "Voice" key on the screen for about two seconds. When the voice guidance is disabled, the "Voice" key on the screen will appear grayed out.

**General system information 6-3**

 **REVIEW COPY—2014 Low Cost Navi 2 Kai (12k)  
Navigation System OM—USA\_English (nna)  
06/11/13—tbrooks** 

## CURRENT VEHICLE LOCATION

### DISPLAY OF CURRENT VEHICLE LOCATION

This navigation system combines the data obtained from the vehicle (by gyro sensor) and from GPS (Global Positioning System) satellites to calculate the current location of the vehicle. This position is then displayed throughout route guidance to a destination.

### WHAT IS GPS (Global Positioning System)?

GPS is a position detecting system that uses satellites deployed by the U.S. government. This navigation system receives radio signals from three or more different satellites that orbit 13,049 miles (21,000 km) above the earth in space, and detects the position of the vehicle by utilizing the principle of triangulation.

### DETAILED MAP COVERAGE (MCA) FOR THE NAVIGATION SYSTEM

This system is designed to help you reach your destination, and also performs other functions as outlined in this manual. However, you, the driver, must use the system safely and properly. Information concerning road conditions, traffic signs and the availability of services may not always be up-to-date. The system is not a substitute for safe, proper, and legal driving.

#### 6-4 General system information

Map data is available on the provided SD-card. For information about the map SD-card, contact a NISSAN dealer or call the NISSAN NAVIGATION SYSTEM HELPDESK. See the contact information on the inside front cover of this manual.

Map data includes 2 types of areas: "Detailed coverage areas" providing all detailed road data and other areas showing "Main roads only".



#### NOTE:

**Detailed map data is not available in many areas and is generally limited to select major metropolitan areas.**

### WHEN A GRAY ROAD IS DISPLAYED ON THE MAP

- Route calculation may not be possible when a destination or the current vehicle location is near a gray road.
- Route guidance (enlarged view and voice guidance) may not be available at the intersection where the road your vehicle is driving on and a gray road intersect.
- Places information and street names near gray roads are not contained in the map data.

## ROUTE CALCULATION

- The NISSAN Navigation System may not calculate a route if the current vehicle location is too far away from the destination. In this case, please divide your trip by selecting one or two intermediate destinations.
- To reach your destination, refer to the map screen. Always follow actual roads and regulations and drive safely.
- The suggested route may not be the shortest, nor are other circumstances such as traffic jams considered unless the NavTraffic is active.
- Because of the inevitable difference in road conditions and circumstances between the time you use this system and the time the information was produced for the map data, there may be discrepancies in roads and regulations. In such cases, follow the actual information available.
- During route calculation, the map will not scroll, however the vehicle icon will move with the actual vehicle's movement.
- In some cases, after the calculation is complete, the calculated route may not be immediately displayed.
- If you scroll the map while the suggested route is being drawn, it may take more time to finish drawing.

- If waypoints are set, the system calculates multiple routes between waypoints simultaneously, and the following may result.
  - If one section between waypoints cannot be calculated, none of the route will be displayed.
  - The route may not connect completely at some waypoints.
  - The route may require a U-turn close to some waypoints.
- Route calculation may not be completed in the following cases.
  - If there is no main road within a range of 1.5 miles (2.5 km) from the vehicle, a message will then appear on the screen. Try recalculating when the vehicle is closer to a main road.
  - If the vehicle is too close to the destination or if there are no roads to the destination, a message will then appear on the screen.
  - If it is impossible to reach the destination or waypoints because of traffic regulations, etc.
  - If the only target route to the destination or waypoints is extremely complicated.
- The following may occur when the route is displayed.
  - If you calculate a route on a main road, the starting point of the route may not exactly match the current vehicle location.
  - The endpoint of the route may not exactly match the destination.
  - If you calculate a route on a main road, the system may display a route from another main road. This may be because the position of the vehicle icon is not accurate. In this case, park the vehicle in a safe location and reset the vehicle icon, or continue driving to see if the position of the vehicle icon is automatically adjusted before recalculating the route.  
 “VEHICLE ICON” (page 7-3)
  - In some cases, the system shows an indirect route to the destination or waypoints if you set them from stored or places information. In order to correct, you must be careful about the traffic direction, especially when lanes with different travel directions are shown separately, such as interchanges and service areas.
- Even if the freeway preference is set to OFF, a route that uses the freeway may be suggested.
- Even if the preference is set to OFF, a route that uses a ferry line may be suggested.
- Ferry lines, excluding those that are only for pedestrians, bicycles and motorcycles, are stored in this system. Take into consideration the travel time required and operational condition before deciding whether to use the route.



**General system information 6-5**

## ROUTE GUIDANCE

### BASICS OF VOICE GUIDANCE

The voice guidance announces which direction to follow when approaching an intersection where a turn is required.

After setting the route, select “Start” to begin route guidance.

During route guidance, the system navigates you through the guide points using visual and voice guidance.



#### NOTE:

- The navigation system visual and voice guidance is for reference purposes only. The contents of the guidance may be inappropriate depending on the situation.
- There may be some cases in which voice guidance and actual road conditions do not correspond. This may occur because of discrepancies between the actual road and the information on the map data, or due to the vehicle’s speed.
- In case voice guidance does not correspond to the actual road conditions, follow the information obtained from traffic signs or noticed on the road.

### 6-6 General system information

- Route guidance provided by the navigation system does not take carpool lane driving into consideration, especially when carpool lanes are separated from other road lanes.

### DIRECTIONS PROVIDED AND THE DISTANCES TO GUIDE POINTS

Directions will differ, depending on the road type.



#### INFO:

Distances may vary, depending on the vehicle speed.

### Notification when approaching the destination

Ordinary road:

The voice guidance will warn you when approaching your destination. To reach your destination precisely, refer to the map screen.

### REPEATING VOICE GUIDANCE

This function is available throughout route guidance, from the time after the route calculation is completed until the vehicle arrives at the destination.

Touch the “Voice” key.

Voice guidance will be repeated.



#### INFO:

- If you touch the “Voice” key when you have deviated from the suggested route, voice guidance will announce, “Proceed to the highlighted route.”
- If you touch the “Voice” key when you are going in the wrong direction, voice guidance will announce: “Please make a legal U-turn if possible.”

### NOTES ON VOICE GUIDANCE

- Voice guidance in this system should be regarded as a supplementary function. When driving your vehicle, check the route on the map and follow the actual roads and traffic regulations.
- Voice guidance is activated only for intersections with certain conditions.
- There may be cases where the vehicle has to turn, but voice guidance is not provided.
- Voice guidance contents may vary, depending on the direction of the turn and the type of intersection.
- The voice guidance timing will vary depending on the situation.

- When the vehicle has deviated from the suggested route, voice guidance is not available. The system will not announce this to you. Refer to the map and recalculate the route.
- Voice guidance may not accurately correspond with road numbers and directions at freeway junctions.
- Voice guidance may not accurately correspond to street names at freeway exits.
- The displayed street names may sometimes differ from the actual names, or "UNKNOWN STREET NAME" may be displayed.
- Voice guidance is not available when the feature is disabled in the SETTINGS menu.
- Voice guidance will start when the vehicle enters the suggested route. Refer to the map for directions to the starting point of the route.
- When approaching a waypoint, voice guidance will announce, "You have reached your intermediate destination on the (left/right) side." Voice guidance will switch to the next section of the route. When voice guidance is not available, refer to the map for directions.
- In some cases, voice guidance ends before arrival at the destination. Refer to the destination icon on the map to reach the destination.
- If the system recognizes on which side the destination (waypoint) is located, voice guidance will announce "on the right/left" after announcing the arrival at the destination.
- Voice guidance may be partially operational or inoperative due to the angle of roads at an intersection.
- Because it is not possible to consider data concerning roads that are seasonally available or unavailable, a route may be displayed that does not match the actual traffic restrictions. Be sure to follow the actual traffic restrictions while driving.
- Canada and Alaska contain many roads with incomplete map data. As a result, when searching for a route, the route may include roads with incomplete data. In regions where road data is not complete, voice guidance may stop for long periods of time. Be sure to follow the actual traffic restrictions while driving.

## HOW TO HANDLE THE DISPLAY

The display is a liquid crystal display and should be handled with care.

### WARNING

**Never disassemble the display. Some parts utilize extremely high voltage. Touching them may result in serious personal injury.**

### CHARACTERISTICS OF A LIQUID CRYSTAL DISPLAY

- If the temperature inside the vehicle is especially low, the display will stay relatively dim or the movement of the images may be slow. These conditions are normal. The display will function normally when the interior of the vehicle has warmed up.
- Some pixels in the display are darker or brighter than others. This condition is an inherent characteristic of liquid crystal displays, and it is not a malfunction.
- A remnant of the previous display image may remain on the screen. This screen burn is inherent in displays, and it is not a malfunction.



#### INFO:

The screen may become distorted by strong magnetic fields.

**General system information 6-7**

## MAINTENANCE OF THE DISPLAY



### CAUTION

- **To clean the display, never use a rough cloth, alcohol, benzine, thinner, any kind of solvent, or paper tissues with chemical cleaning agent. They would scratch or deteriorate the panel.**
- **Do not splash any liquid such as water or car fragrance on the display. Contact with liquid will cause the system to malfunction and damage the hardware.**

For cleaning, use a dry soft cloth. If additional cleaning is necessary, use a small amount of neutral detergent with a soft cloth. Never spray the screen with water or detergent. Dampen the cloth first, then wipe the screen.

### 6-8 General system information

# 7 Troubleshooting guide

Basic operations .....	7-2	Map SD-card route calculation and visual guidance ...	7-5
Vehicle icon.....	7-3	Voice guidance.....	7-6



## BASIC OPERATIONS

Symptom	Possible cause	Possible solution
No image is displayed.	The brightness is at the lowest setting.	Adjust the brightness of the display.
	The display is turned off.	Press the  button to turn on the display.
	The system is in overheat mode due to excessive high temperature.	Wait until the system cools down.
No voice guidance is available. or The volume is too high or too low.	The volume is not set correctly, or it is turned off.	Adjust the volume of voice guidance or turn voice guidance on.
No map is displayed on the screen.	The map SD-card is not inserted.	Insert the map SD-card correctly.
	A screen other than map screen is displayed.	Press MAP.
The screen is too dim. The movement is slow.	The temperature in the interior of the vehicle is low.	Wait until the interior of the vehicle has warmed up.
Some pixels in the display are darker or brighter than others.	This condition is an inherent characteristic of liquid crystal displays.	This is not a malfunction.
Some menu items cannot be selected.	Some menu items become unavailable while the vehicle is driven.	Park the vehicle in a safe location, and then operate the navigation system.



### NOTE:

**Locations stored in the Address Book and other memory functions may be lost if the vehicle's battery is disconnected or is discharged. If this occurs, service the vehicle's battery as necessary and re-enter the information in the Address Book.**

## 7-2 Troubleshooting guide

 **REVIEW COPY—2014 Low Cost Navi 2 Kai (12k)**  
**Navigation System OM—USA\_English (nna)**  
**06/11/13—tbrooks** 



## VEHICLE ICON

Symptom	Possible cause	Possible solution
Names of roads and locations differ between 2D and 3D mode.	This is because the quantity of the displayed information is reduced so that the screen does not become difficult to read. There is also a chance that names of the roads or locations may be displayed several times, and the names appearing on the screen may be different because of a processing procedure.	This is not a malfunction.
The vehicle icon is not displayed in the correct position.	The vehicle was transported after the ignition switch was turned off by a ferry or car transporter, for example.	Drive the vehicle for a while on a road where GPS signals can be received.
	The position and direction of the vehicle icon may be incorrect depending on the driving environments and the levels of positioning accuracy of the navigation system.	This is not a malfunction. Drive the vehicle for a while to automatically correct the position and direction of the vehicle icon.  "CURRENT VEHICLE LOCATION" (page 6-4)
When the vehicle is traveling on a new road, the vehicle icon is located on another road nearby.	The system automatically places the vehicle icon on the nearest available road, because the new road is not stored in the map data.	Updated road information will be included in the next version of the map SD-card.
The map does not scroll even when the vehicle is moving.	The current location map screen is not displayed.	Press the MAP button.
The vehicle icon is not displayed.	The current location map screen is not displayed.	Press the MAP button.
The GPS indicator on the screen remains gray.	GPS signals cannot be received under certain conditions, such as in a parking garage, on a road with many tall buildings, etc.	Drive on an open, straight road for a while.
	A sufficient number of GPS satellites is not available.	Wait for the satellites to move to locations available for the navigation system.



Symptom	Possible cause	Possible solution
The location of the vehicle icon is misaligned from the actual position.	When using tire chains or replacing the tires, speed calculations based on the speed sensor may be incorrect.	Drive the vehicle for a while (at approximately 19 MPH [30 km/h] for about 30 minutes) to automatically correct the vehicle icon position. If this does not correct the vehicle icon position, contact a NISSAN dealer.
	The map data has a mistake or is incomplete (the vehicle icon position is always misaligned in the same area).	Updated road information will be included in the next version of the map data.

7-4 Troubleshooting guide

**REVIEW COPY—2014 Low Cost Navi 2 Kai (12k)**  
**Navigation System OM—USA\_English (nna)**  
**06/11/13—tbrooks**

## MAP SD-CARD ROUTE CALCULATION AND VISUAL GUIDANCE

Symptom	Possible cause	Possible solution
The message "Error" appears.	The SD-card is not recognized by the system.	Replace the map SD-card if you see any damage.
In the automatic reroute calculation, the waypoint is not included.	A waypoint that you have already passed is not included in the automatic reroute calculation.	If you want to go to that waypoint again, you need to add it back to the route.
Route information is not displayed.	Route calculation has not yet been performed.	Set the destination and perform route calculation.
	The vehicle is not on the suggested route.	Drive on the suggested route.
	Route guidance is cancelled.	Turn on route guidance.
The automatic reroute calculation (or detour calculation) suggests the same route as the one previously suggested.	Route calculations took priority conditions into consideration, but the same route was calculated.	This is not a malfunction.
The suggested route is not displayed.	Roads near the destination cannot be calculated.	Reset the destination to a main or ordinary road, and recalculate the route.
	The starting point and destination are too close.	Set a more distant destination.
	The starting point and destination are too far away.	Divide the trip by selecting one or two intermediate destinations, and perform route calculations multiple times.
An indirect route is suggested.	If there are restrictions (such as one-way streets) on roads close to the starting point or destination, the system may suggest an indirect route.	Adjust the location of the starting point or destination.
	The system may suggest an indirect route because route calculation does not take into consideration some areas such as narrow streets (gray roads).	Reset the destination to a main or ordinary road, and recalculate the route.
The landmark information does not correspond to the actual information.	This may be caused by insufficient or incorrect data on the map SD-card.	Updated information will be included in the next version of the map SD-card.
The suggested route does not exactly connect to the starting point or destination.	There is no data for route calculation closer to these locations.	Set the starting point and destination on a main road, and perform route calculation.

Troubleshooting guide 7-5

## VOICE GUIDANCE

Symptom	Possible cause	Possible solution
Voice guidance is not available.	In some cases, voice guidance is not available even when the vehicle should make a turn.	This is not a malfunction.
	The vehicle has deviated from the suggested route.	Go back to the suggested route or request route calculation again.
	Voice guidance is set to off.	Turn on voice guidance.
The guidance content does not correspond to the actual condition.	The content of voice guidance may vary, depending on the types of intersections at which turns are made.	Follow all traffic rules and regulations.

### 7-6 Troubleshooting guide

**REVIEW COPY—2014 Low Cost Navi 2 Kai (12k)**  
**Navigation System OM—USA\_English (nna)**  
**06/11/13—tbrooks**

# 8 Index

<p><b>A</b></p> <p>Address book . . . . .6-3</p>	<p><b>H</b></p> <p>How to use this manual . . . . .1-2</p>	<p>Route guidance. . . . .6-2</p>
<p><b>B</b></p> <p>Basic operations . . . . .7-2 Basics of voice guidance . . . . .6-6</p>	<p><b>L</b></p> <p>Language settings . . . . .5-5 Laser product. . . . .1-4</p>	<p><b>S</b></p> <p>Safety information . . . . .1-2 Steering wheel switch. . . . .2-4, 2-5, 2-4</p>
<p><b>C</b></p> <p>Clock settings . . . . .5-4 Control buttons and functions. . . . .2-2 Current vehicle location . . . . .6-4</p>	<p><b>M</b></p> <p>Moving a map. . . . .3-4 My Places . . . . .4-13</p>	<p><b>U</b></p> <p>User-defined points of interest (POIs). . . .4-13</p>
<p><b>D</b></p> <p>Directions provided and the distances to guide points. . . . .6-6 Display of current vehicle location. . . . .6-4 Display settings. . . . .5-3</p>	<p><b>N</b></p> <p>Notes on voice guidance . . . . .6-6</p>	<p><b>V</b></p> <p>Vehicle icon. . . . .7-3 Voice guidance . . . . .6-3, 7-6 Voice recognition . . .4-9, 4-18, 4-21, 4-5, 4-13, 4-24</p>
<p><b>F</b></p> <p>Features of this navigation system . . . . .6-2 For safe operation . . . . .1-2</p>	<p><b>P</b></p> <p>Points Of Interest (POI) directory . . . . .6-3</p>	<p><b>W</b></p> <p>What is GPS (Global Positioning System)? . .6-4 When a gray road is displayed on the map. . .6-4</p>
	<p><b>R</b></p> <p>Reference symbols. . . . .1-2 Repeating voice guidance. . . . .6-6 Returning to the current vehicle location . . .3-5 Route calculation . . . . .6-4 Route calculation and visual guidance . . . .7-5</p>	<p><b>X</b></p> <p>XM NavWeather™ . . . . .4-22, 4-22</p>

