



rmo2015-008-032\_a

**TYPICAL - LIFTING PASSENGER SEAT TO REMOVE IT**

1. Passenger seat

3. Detach seat tether cord from retaining clip.



rmo2015-008-222\_a

**TYPICAL**

1. Tether cord  
2. Retaining clip

**⚠ WARNING**

Part detachment could result in a road hazard. To avoid a potential road hazard, always attach tether cord to the part that covers this compartment.

**Mono Seat Cowl (F3-S Daytona 500 Edition)**

Mounts on passenger seat in seconds to transform your vehicle into a sporty 1-UP configuration.

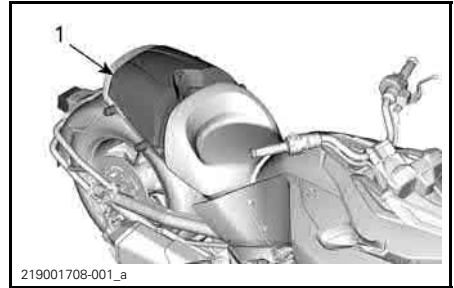

219001708-001\_a

1. Mono seat cowl

**⚠ WARNING**

Part detachment could result in a road hazard. To avoid a potential road hazard, always attach tether cord to the part that covers this compartment.

**Saddlebags (F3 Limited and F3-T Models)**

These models come equipped with two saddlebags to carry convenient items.

**NOTICE** Follow maximum loading capacity. Refer to *SPECIFICATIONS* for details.

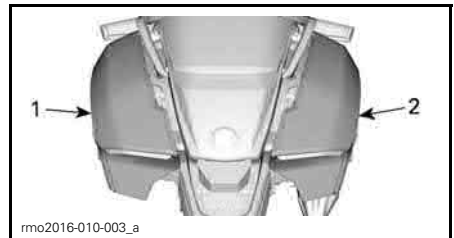

rmo2016-010-003\_a

**TYPICAL**

1. LH saddlebag  
2. RH saddlebag

Unlock saddlebag and pull on handle to open them.

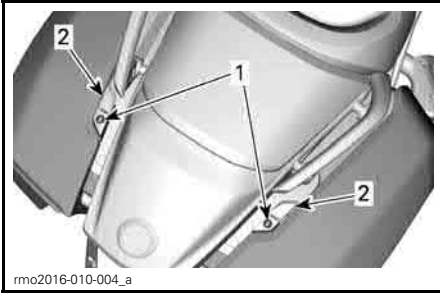

**TYPICAL**

1. Saddlebag lock location
2. Saddlebag handle

**Saddlebag Removal**

**⚠ WARNING**

Always ride with saddlebags installed properly and verify tail-light/turn signal/brake lights are working properly after saddlebag installation.

Open saddlebag.

Remove the three retaining screws inside saddlebag.

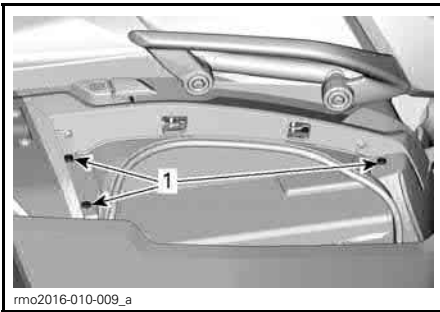

1. Retaining screws to remove

Remove plastic rivet under front of saddlebag.

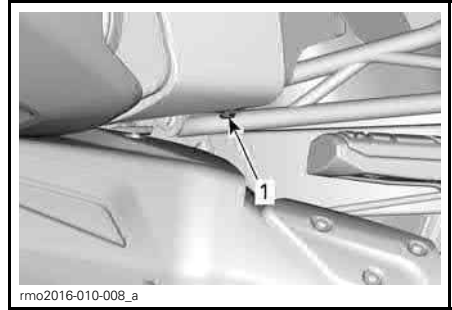

1. Plastic rivet under front of saddlebag

Remove plastic rivet at the rear of saddlebag.



1. Plastic rivet to remove

Slide saddlebag out enough to disconnect taillight/turn signal/brake light connector and remove saddlebag.

**Opening the Top Storage Compartment (F3 Limited Models)**

The top storage compartment latch is located at the rear of vehicle.

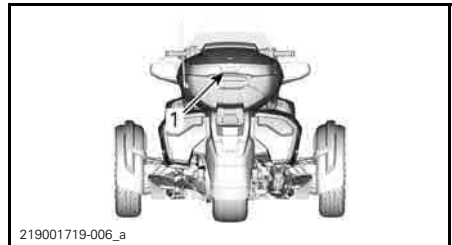

1. Latch for the top storage compartment

If locked, use the ignition key and unlock top storage by turning key counterclockwise.

**FOR APPROVAL ONLY**

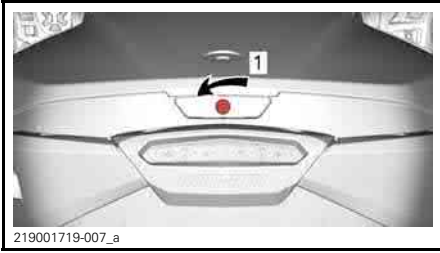

219001719-007\_a  
1. Turn counterclockwise to unlock

Push the latch.



219001719-008\_a  
1. Opening the top cover

Open the storage compartment cover.  
Always latch the cover after usage.

When finished, lock top storage if desired. Turn key clockwise.

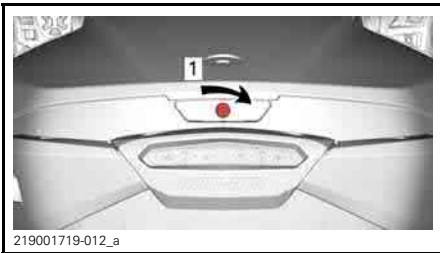

219001719-012\_a  
1. Turn clockwise to lock

**NOTICE** Never ride the vehicle with the cover open.

### Tinted Windshield (F3 Limited and F3-T Models)

These models come equipped with a tinted windshield.

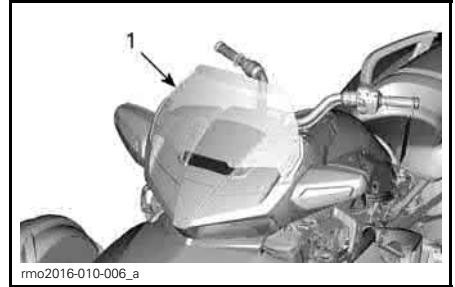

rmo2016-010-006\_a  
1. Tinted windshield

### Glove Box (F3 Limited and F3-T Models)

These models come equipped with a glove box to carry small personal items.

Audio in jack and USB connector are also located here.

Pull on the rear cover tab of glove box to open.

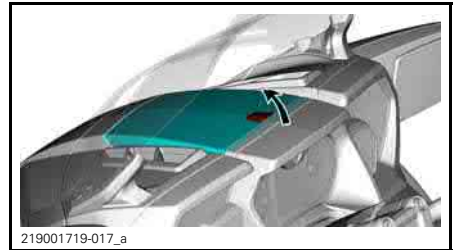

219001719-017\_a  
TYPICAL

### Body Panels

The body panels on the vehicle can be removed for maintenance.

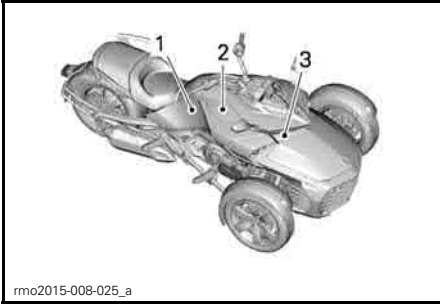

**TYPICAL - RIGHT HAND SIDE PANELS**

1. Side panel
2. Lateral service covers
3. Front service cover

**Lateral Service Cover**

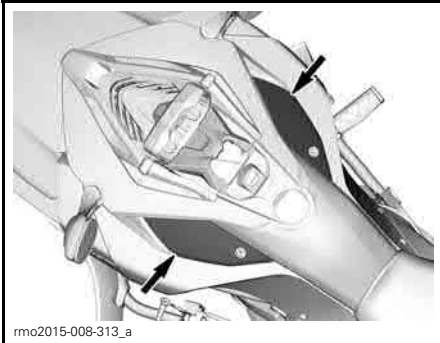

**TYPICAL - LATERAL SERVICE COVERS**

**Removal**

1. Rotate lock counterclockwise (RH service cover) or clockwise (LH service cover).

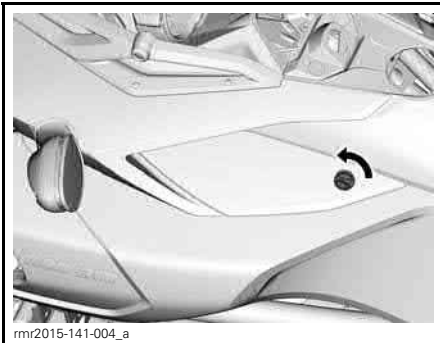

**TYPICAL - LH SERVICE COVER SHOWN**

2. Pull out service cover

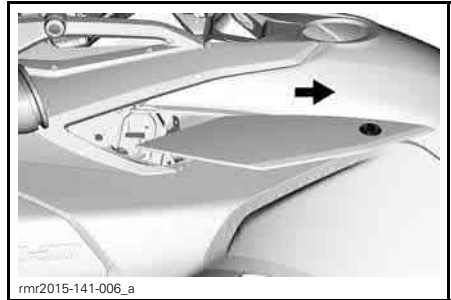

**TYPICAL**

**Installation**

1. Install lateral service cover in place taking care to align tabs properly.

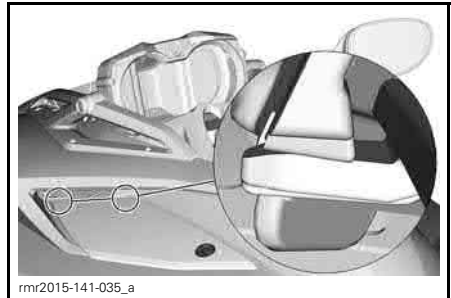

**TYPICAL**

**NOTICE** Make sure lateral service cover does not overlap on side panel.

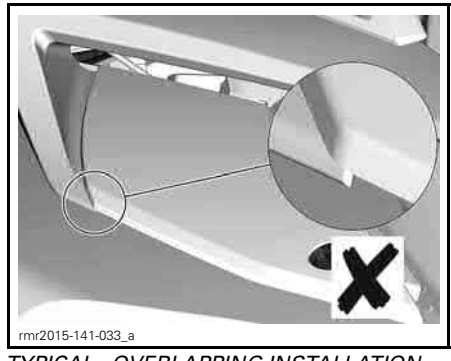

**TYPICAL - OVERLAPPING INSTALLATION**

**FOR APPROVAL ONLY**

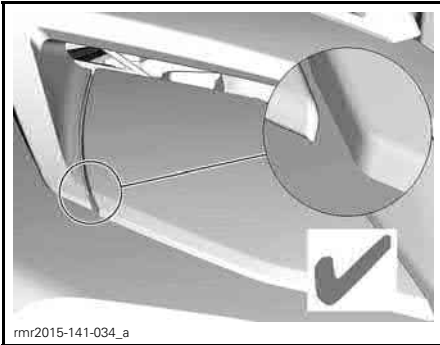

*TYPICAL - CORRECT INSTALLATION*

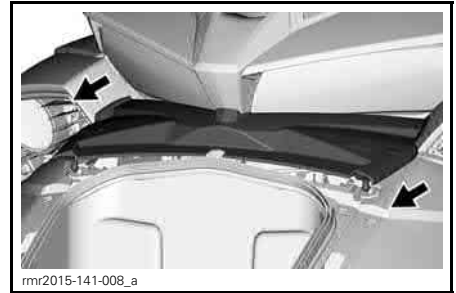

*TYPICAL - REMOVING SERVICE COVER*

### Front Service Cover Installation

1. Slide front service cover back in place.

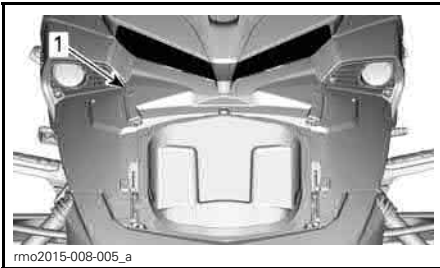

*TYPICAL*

1. Front service cover



*TYPICAL - SLIDING SERVICE COVER IN POSITION*

### Front Service Cover Removal

1. Lift front of service cover to clear grommets

**NOTE:** Make sure front service cover tab are positioned properly on vehicle.

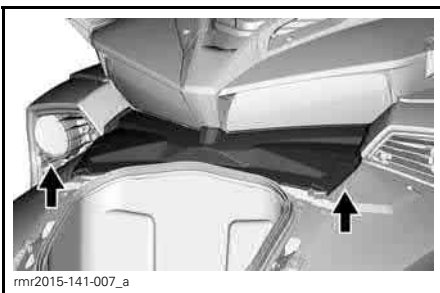

*TYPICAL - LIFTING SERVICE COVER*

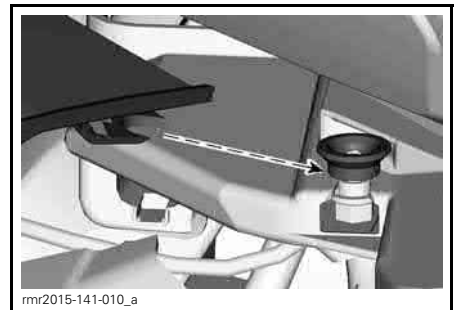

*TYPICAL - ALIGNING TABS IN CORRECT INSTALLATION LOCATION*

2. Remove service cover from vehicle

**FOR APPROVAL ONLY**

## Side Panel



TYPICAL

## Side Panel Removal

1. Remove screws and plastic rivets securing side panel to vehicle.

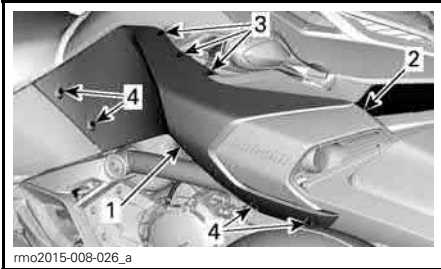

TYPICAL

1. Side panel
2. Clip
3. Plastic rivets
4. Retaining screws

2. Lift side panel to remove it.



TYPICAL

## Side Panel Installation

1. Slide the inner side panel back in position.

**NOTE:** Take care to align side panel retaining screw tab to air scoop retaining screw tab.



TYPICAL - ALIGNING PANELS PROPERLY

2. Install plastic rivets and screw in Torx screw.

**NOTICE** Do not overtorque. Any deformation on the panel around the screw is an indication that it is too tight. You may damage the panel.

FOR APPROVAL ONLY

# BASIC PROCEDURES

## Starting and Stopping the Engine

### Starting the Engine

NOTE: At start-up, engine RPM will slightly increase by itself before running its normal rotation.

#### WARNING

Exhaust gas contains poisonous carbon monoxide that can rapidly accumulate in an enclosed or poorly ventilated area. If inhaled, it can cause serious injury or death. Only run the engine in an unenclosed, well ventilated area. See *AVOID CARBON MONOXIDE POISONING*.

#### *SM6 Model*

1. Push down and hold the brake pedal.
2. Turn the key to ON.

**NOTICE** Do not apply throttle while electrical system is initializing.

3. Refer to the Safety Card as needed to prepare yourself, your passenger and the vehicle, then press the MODE button to enable the starter.
4. Set the engine stop switch to the RUN/ON position.
5. Pull in and hold the clutch lever.
6. Shift into NEUTRAL. Check the multifunction gauge cluster to be sure you are in neutral.
7. Press and hold the engine start button until the engine starts. Do not hold the start button for more than 15 seconds. If it does not start, release the button and wait 30 seconds to let the starter cool down before trying again.

**NOTICE** Do not apply throttle while starting the engine.

8. Check the display for problems and to ensure that the oil light turns off.
9. Release the parking brake. Make sure the parking brake indicator on the multifunction gauge cluster is off.

**NOTICE** If the parking brake is not fully released before operating the vehicle, brake pads will drag while you are moving. This can damage the brake system.

#### *SE6 Model*

NOTE: The SE6 model can be started in any gear with the brake pedal depressed. The transmission automatically shifts to neutral when the engine started.

1. Push down and hold the brake pedal.
2. Turn the key to ON.

**NOTICE** Do not apply throttle while electrical system is initializing.

3. Refer to the Safety Card as needed to prepare yourself, your passenger and the vehicle, then press the MODE button to enable the starter.
4. Set the engine stop switch to the RUN/ON position.
5. Press and hold the engine start button until the engine starts. Do not hold the start button for more than 15 seconds. If it does not start, release the button and wait 30 seconds to let the starter cool down before trying again.

**NOTICE** Do not apply throttle while starting the engine.

6. Check the display for problems and to ensure that the oil light turns off.
7. Release the parking brake. Make sure the parking brake indicator on the multifunction gauge cluster is off.

FOR APPROVAL ONLY

**NOTICE** If the parking brake is not fully released before operating the vehicle, brake pads will drag while you are moving. This can damage the brake system.

## Stopping the Engine

### SM6 Model

1. Shift into first gear.
2. Set the engine stop switch to OFF.
3. Engage the parking brake. The brake locks in the depressed position, and a scrolling message PARK BRAKE will appear on the display.
4. Turn the key to OFF.
5. Before dismounting, check that the parking brake is fully engaged. Hold the clutch and rock the vehicle back and forth.

### WARNING

Always engage the parking brake. The vehicle can roll if the parking brake is not engaged and the transmission is in neutral.

### SE6 Model

1. Shift into neutral.
2. Set the engine stop switch to OFF.
3. Engage the parking brake. The brake locks in the depressed position, and a scrolling message PARK BRAKE will appear on the display.
4. Turn the key to OFF.

**NOTE:** If the parking brake is not engaged while the key is OFF, the park brake indicator light will flash and a beeper will sound.

5. Before dismounting, check that the parking brake is fully engaged. Rock the vehicle back and forth.

### WARNING

Always engage the parking brake. The vehicle can roll if the parking brake is not engaged, regardless of what gear it is in. The clutch is always disengaged when the vehicle is stopped, so the transmission will not hold the vehicle in place.

## Pushing the Vehicle

** CAUTION** Avoid pushing the vehicle on a slope. If you must push the vehicle on a slope, take extra care to stay within reach of the brake pedal in case the vehicle starts to roll.

To move the vehicle a short distance without starting the engine:

1. While seated on the vehicle, push down and hold the brake pedal.
2. Shift the transmission into NEUTRAL (SM6 model).
3. Disengage the parking brake.
4. Dismount on the right side of the vehicle, keeping your foot on the brake pedal.
5. Push the vehicle, using the brake as needed.

** CAUTION** Only push from the right side, so you can reach the brake pedal. Stay clear of the hot exhaust pipe.

When pulling the vehicle backward, be careful that the front wheel does not roll over your feet.

6. Remount the vehicle and park as specified above.

## Operating in Reverse

For safe operation in reverse, refer to *SAFE OPERATING INSTRUCTIONS* section.

FOR APPROVAL ONLY



**Shifting Into Reverse (SM6 Model)**

1. With engine running, shift into first gear.
2. Hold in the clutch lever.
3. Press and hold the reverse button.
4. Step down on the shift lever one stroke.
5. Release the reverse button and check that the letter "R" flashes on the multifunction gauge cluster .

**Shifting Into Reverse (SE6 Model)**

1. With engine running, the roadster stopped, and the brake depressed, shift into first gear or neutral.
2. Press and hold the reverse button.
3. Pull the gearshift selector toward you to downshift to reverse.

**Driving in Reverse**

Check that the area behind you is clear and continue to look backwards while you operate in reverse. Keep your speed low and do not back up for long distances.

**Shifting Out of Reverse*****SM6 Model***

To shift out of reverse, hold in the clutch and lift the shift lever once to shift into first. You do not need to use the reverse button — it resets automatically.

***SE6 Model***

To shift out of reverse, stop vehicle and push on upshift selector quickly to shift into neutral and longer to shift in first gear.

**Operating During Break-In**

A break-in period of 1 000 km (600 mi) is required for the vehicle.

During the first 300 km (200 mi), avoid hard braking.

**⚠ WARNING**

New brakes and tires do not operate at their maximum efficiency until their break-in is completed. Braking, steering and VSS performance may be reduced, so use extra caution.

Brakes and tires take about 300 km (200 mi) of riding with frequent braking and steering to break-in. For riding with infrequent braking and steering, allow extra time to break-in the brakes and tires.

During the first 1 000 km (600 mi):

- Avoid full throttle acceleration.
- Avoid maintaining constant RPM.
- If the cooling fan operates continuously during stop and go traffic, pull over and shut off the engine to let it cool off or speed up to let air cool off the engine.

After the break-in period, your vehicle should be inspected as per the *MAINTENANCE SCHEDULE*.

**Fueling****Fuel Requirements**

**NOTICE** Always use fresh gasoline. Gasoline will oxidize; the result is loss of octane, volatile compounds, and the production of gum and varnish deposits which can damage the fuel system.

Alcohol fuel blending varies by country and region. Your vehicle has been designed to operate using the recommended fuels, however, be aware of the following:

- Use of fuel containing alcohol above the percentage specified by government regulations is not recommended and can result in the following problems in the fuel system components:
  - Starting and operating difficulties.
  - Deterioration of rubber or plastic parts.
  - Corrosion of metal parts.
  - Damage to internal engine parts.
- Inspect frequently for the presence of fuel leaks or other fuel system abnormalities if you suspect the presence of alcohol in gasoline exceeds the current government regulations.
- Alcohol blended fuels attract and hold moisture which may lead to fuel phase separation and can result in engine performance problems or engine damage.

### Recommended Fuel

Use premium unleaded gasoline with an AKI (RON+MON)/2 octane rating of 91, or an RON octane rating of 95.

**NOTICE** Never experiment with other fuels. Engine or fuel system damages may occur with the use of an inadequate fuel.

**NOTICE** Do NOT use fuel from fuel pumps labeled E85.

Use of fuel labeled E15 is prohibited by U.S. EPA Regulations.

### Refueling Procedure

**⚠ WARNING**

Gasoline is extremely flammable and highly explosive. Follow the refueling procedure to reduce the risk of fire or explosion. See ***AVOID GASOLINE FIRES AND OTHER HAZARDS.***

To refuel the vehicle:

1. Park outdoors in a well ventilated area away from flames, sparks, anyone smoking and other sources of ignition.
2. Stop the engine.
3. Lift fuel cap key cover.

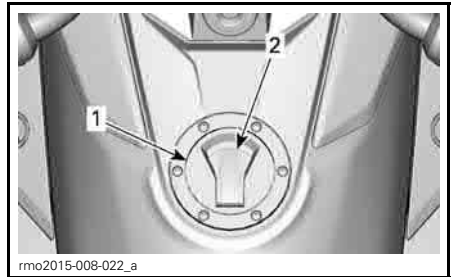

1. Fuel cap
2. Fuel cap key cover

4. Insert key in fuel cap and rotate 1/4 turn clockwise to unlock and remove cap.

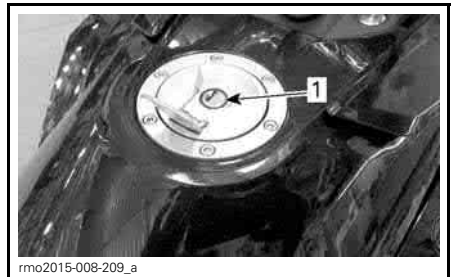

1. Fuel cap keyhole

5. Fill the tank until the fuel level reaches the filler tube.

**FOR APPROVAL ONLY**

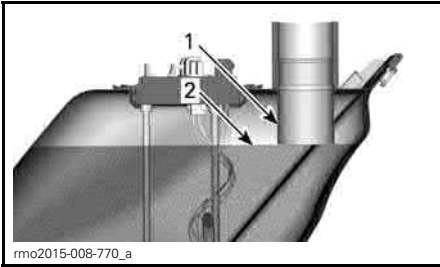

- 1. Filler tube
- 2. Fuel level

**FOR APPROVAL ONLY**

**NOTE:** Do not try to top off the fuel tank. Leave some room for the fuel to expand with temperature changes.

- 6. Wipe up any spilled fuel. If fuel spills on you, wash with soap and water and change your clothes.
- 7. To close fuel cap, push fuel cap into position with the key inserted in the lock. Turn key counterclockwise to the original position to lock fuel cap. Then remove key and close fuel cap lock cover.

**NOTE:** Fuel cap will not close properly with the key out of the lock. The key cannot be removed from fuel cap unless it is locked in position.

**⚠ WARNING**

Always make sure fuel cap is properly closed after refuelling and before operating vehicle.

## Adjusting Suspension

### Front Suspension (All Models Except F3 Base Models)

See a Can-Am dealer for front suspension adjustment.

### Rear Suspension (F3 Limited Models)

The rear suspension level automatically adjusts by deflating or inflating the air spring.

### Rear Suspension (F3-T Models)

The suspension pressure is adjustable by deflating or inflating the air spring. Use a regulated air compressor or hand pump and a pressure gauge.

To soften suspension, reduce air pressure and to harden suspension, increase air pressure.

**NOTE:** The following chart is a guideline only. You may adjust the pressure to your riding preference as long as you do not exceed the maximum allowed pressure.

**⚠ WARNING**

Exceeding maximum specified pressure may lead to reduced VSS performance in some conditions.

**NOTICE** Do not exceed the maximum allowed pressure. This might damage the air suspension.

**⚠ WARNING**

MINIMUM PRESSURE 70 kPa / 10 Psi / 0.7 bar  
DO NOT EXCEED RECOMMENDED PRESSURE BY 70 kPa / 10 Psi / 0.70 bar

LOAD		(PASSENGER + CARGO) Kg / Lb			
		0	45/100	70/150	90/200
DRIVER	Kg/Lb	kPa/Psi/bar			
	70/150	105/15/1.05	240/35/2.40	380/55/3.80	415/60/4.15
	90/200	205/30/2.05	345/50/3.45	415/60/4.15	480/70/4.80
	115/250	275/40/2.75	415/60/4.15	480/70/4.80	

704905966

LOCATED UNDER PASSENGER SEAT

**NOTE:** When adjusting the pressure, do not put your weight on the vehicle and do not load cargo in the storage compartment.

The air spring is connected directly to an air hose with a schrader valve located under the seat.

To change the air pressure, proceed the same way as for setting the pressure in a tire.

When finished, ensure to reinstall cap on the valve.

*This page is  
intentionally blank*

**FOR APPROVAL ONLY**

**FOR APPROVAL ONLY**

# ***SAFE OPERATING INSTRUCTIONS***

---

# WHAT'S DIFFERENT ABOUT THE SPYDER ROADSTER

The Spyder roadster is a different type of road vehicle. This section will help you understand some of the vehicle distinctive features and operating characteristics.

## Stability

The three-wheeled “Y” configuration provides greater low-speed stability than a motorcycle. However, it is not as stable as a four-wheeled vehicle such as an automobile. Driving aid technologies, like the electronic Vehicle Stability System (VSS), help maintain stability during maneuvers, but you can still lose control, tip or roll the vehicle due to extreme maneuvers (such as hard turns), overloading the vehicle or striking uneven surfaces or objects. In addition, the operator or passenger can fall off due to hard turns, acceleration, braking or impacts.

## Response to Road Conditions

The Spyder roadster responds differently than other vehicles to certain road conditions.

- Do not ride off-road or on ice or snow.
- Avoid puddles and running water. The vehicle hydroplanes more easily than a car. If you must go through water, slow down.
- Slow down on gravel, dirt or sand covered roads.
- Driving at temperature lower than 6°C (43°F) will result in reduced adherence.

Refer to *STREET STRATEGIES* for detailed instructions.

## Brake Pedal

One pedal applies brakes on all three wheels. There is no hand-operated brake, and there is no way to brake front and rear wheels separately. The

Spyder roadster is better able to brake and steer at the same time than a motorcycle. The vehicle can stop quickly — be aware of vehicles behind you that may not be able to stop as quickly.

## Anti-lock Braking System (ABS)

The vehicle is equipped with an Anti-lock Braking System (ABS) as part of the Vehicle Stability System (VSS). For hard braking, press and hold the brake pedal. ABS will prevent wheels from locking.

## Parking Brake



The parking brake mechanically brakes the rear wheel only, and it locks in place when engaged. It is not controlled by driving aid technologies (e.g., ABS, Electronic Brake Distribution). Do not use it to slow or stop the vehicle — you could lose control, spin, tip or roll over.

## Steering

### Direct Steering

To steer your Spyder roadster, always steer in the direction of the turn.

Motorcyclists — Do not countersteer as it is done on a motorcycle. Unlike a motorcycle, your Spyder roadster cannot lean while turning. If you are a motorcyclist, you must relearn how to turn. Practice steering in the direction of the turn at all speeds until you are proficient.

### Sideways Forces in Turns

Unlike a motorcycle, the Spyder roadster does not lean in turns. You will feel sideways forces pushing you to the outside of the turn. To maintain balance, the operator and passenger must hold on with both hands and

FOR APPROVAL ONLY

keep both feet firmly planted on the footrests. In hard turns, it may help to lean your upper body forward and toward the inside of the turn.

## Width

Because the Spyder roadster is wider than a typical motorcycle:

- Keep the front wheels in your lane during turns. Be particularly aware of where your front wheels are in curves and when passing. If you take a path that would put a motorcycle front wheel near the edge of the lane, the Spyder roadster front wheel may be out of the lane.
- Do not share lanes or split lanes (ride between two lanes of traffic). Group riding should proceed in a single file, even with motorcycles.
- Be prepared to swerve farther to avoid obstacles.

NOTE: Clearing an obstacle with the front wheels does not guarantee clearing the obstacle with the rear wheel.

## Reverse



The Spyder roadster operates in reverse like a car. However, there are some important differences:

- If necessary, have the passenger dismount if your visibility is limited.
- Remember that the front is wider than the rear. Do not back up too close to objects or you may hit them with the front tires.
- Keep your speed low and do not back up for long distances.
- When possible, park so that you do not have to back out of the parking space.
- SM6 model: Shift back into first gear before shutting off the engine.

**⚠ CAUTION** Always keep both feet on the pegs while operating in reverse. Never put your feet on the ground while backing-up.

## Driver's License and Local Laws

Driver's license requirements for operating the Spyder roadster vary by location. Depending on local laws, you may need a motorcycle endorsement, three-wheeled vehicle endorsement, or just a standard automobile driver's license.

Check with local authorities to make sure you have the proper license before operating the vehicle on public roads.

**FOR APPROVAL ONLY**

---

# DRIVING AID TECHNOLOGIES

## Vehicle Stability System (VSS)

The Spyder roadster is equipped with a Vehicle Stability System (VSS). VSS can help you control the direction of the vehicle and reduce the risk of tipping or rolling over in some situations. VSS consists of:

- An **Antilock Braking System (ABS)** that helps maintain steering control during hard braking by preventing the wheels from locking.
- An **Electronic Brake Distribution (EBD)** system that automatically adjusts the brake balance between all three wheels. With the ABS, EBD helps maintain directional control and maximize the braking force depending on the traction available.
- A **Traction Control System (TCS)** that helps prevent the rear wheel from slipping. The TCS will limit rear wheel spin only if you turn the handlebar (steer out of straight line) or if traction conditions or vehicle stability require engine torque to be reduced.
- A **Stability Control System (SCS)** is designed to limit the power driving the rear tire and to brake individual wheels, which reduces the risk of losing control of the vehicle or rolling over.

### Limitations

VSS cannot help you maintain control in all situations.

### Surfaces with Poor Traction

The grip of tires on the road surface limits the maximum braking. Even with ABS and EBD, your stopping distance will be longer on surfaces with poor traction or if you do not maintain tire pressure and tread condition.

If your tires lose traction with the road surface you may lose control of the vehicle, even with VSS.

If the paved road surface is covered or partially covered with ice, snow or slush, there is not enough traction available to maintain control of the vehicle, even with VSS. Do not operate on snow, ice or slush.

**NOTE:** Roadster tire traction level begins to decrease below 5°C (41°F).

Like other on-road vehicles, this vehicle can hydroplane on water (lose traction on a layer of water). If you ride too fast into a layer of water, such as a large puddle or flowing water on the road, the vehicle can lose traction and spin out, and the VSS cannot keep you in control. Avoid large water puddles or water streams, and slow down or pull off the road during heavy rains. If you must pass through water, slow down as much as possible before you reach it.

Reduce speed on surfaces with poor traction, like mud, sand, gravel or wet pavement. The Spyder roadster is not for off-road operation. Always operate the vehicle on maintained roadways. Do not use the vehicle on any other terrain.

### Tires

The VSS on the vehicle has been calibrated to perform best with a tire of a specific size, material and tread pattern. Replacing your tires with ones not approved by BRP can cause the VSS to be less effective.

Use only BRP recommended tires, which can be ordered only from an authorized Can-Am roadster dealer.

Proper tire inflation pressure and tread condition are important for maintaining traction, especially on loose or wet surfaces. Tire pressure that is too low may result in hydroplaning and excessive tire heat build up, while a tire pressure that is too high can reduce VSS effectiveness.

FOR APPROVAL ONLY



## Hard Turns

The VSS does not control or limit steering input — it cannot keep you from turning too sharply. Large and rapid steering handlebar movements can cause the vehicle to go out of control, spin, tip or roll over.

## Excess Speed

The VSS does not control the vehicle speed, except when SCS intervenes during a turn. VSS does not prevent the vehicle from entering a turn too fast. If you drive too fast for conditions, you can lose control, even with VSS.

## Excess Weight

Never load vehicle above specified values.

TOTAL VEHICLE LOAD ALLOWED	
All models except F3 Limited models	199 kg (438 lb)
F3 Limited models	209 kg (460.8 lb)

## Dynamic Power Steering (DPS)

The DPS (Dynamic Power Steering) provides a computer controlled, variable power assist, achieved by an electric motor to optimize the amount of steering effort required by the rider.

The steering assist level is dependent of the handlebar effort, the steering angle and the vehicle speed.

When vehicle is in the reverse gear, power steering assist will decrease as vehicle speed increases.

FOR APPROVAL ONLY

---

# UNDERSTANDING RISK ON THE ROAD

Before you operate the Spyder roadster read the safety card and, consider your risk of being hurt or killed in a crash, how you can reduce the risk and whether you are willing to take the risk. There are many factors that contribute to the risk that you face. You can control some of these factors, but others, like the behavior of other drivers, are beyond your control. Here are some of the factors that affect your risk:

## Type of Vehicle

Different types of vehicles vary in terms of size, visibility and maneuverability and provide different degrees of protection.

The Spyder roadster is small and maneuverable. Maneuverability can help avoid crashes. However, smaller vehicles are harder to see, which increases the chance that other motorists will cause a crash. In some situations, the Spyder roadster is less likely to be in a crash than a motorcycle. For example, you are less likely to tip over at low speeds while operating the vehicle. However, in other situations, the vehicle is more likely to be in a crash. For example, because the vehicle is wider, it will not fit through as small an opening as many motorcycles.

In cars and trucks, the structure of the vehicle provides protection in crashes and from other road hazards. In addition, passengers can protect themselves by wearing seat belts. You should expect that riding the Spyder roadster is riskier than riding in a car and that the risk of injury is more like riding a motorcycle.

As when riding a motorcycle, you can reduce the risk of injuries by wearing a helmet and riding gear.

## Operator Skills and Judgment

Every driver has some control over their own risk on the road. Drivers who develop good skills will have better control of their vehicle. Do not rely on your experience with motorcycles, automobiles, ATVs, snowmobiles or any other kind of vehicle to prepare you to operate the Spyder roadster. Learn how this vehicle is different. Read this Operator's Guide, watch the *SAFETY VIDEO* located at: <https://can-am.brp.com/spyder/owners/safety/safety-information.html>, and if available, take a training course. Become proficient with the controls and be able to do the practice exercises accurately and with confidence before going on the road.



When you begin riding on the road, start with less challenging situations (e.g., light traffic, lower speeds, good weather, no passenger) and gradually move on to more challenging riding situations as you develop your skills. Plan ahead to avoid situations that are too difficult for your skill level, or that present more risk than you want to take on.

Even skilled drivers cause crashes. For example, if you use your skills to do extreme maneuvers or stunts, you increase your risk. The smart driver uses good judgment along with skills to increase the margin of safety and minimize risk. Learn the defensive driving techniques in *STREET STRATEGIES*.

**FOR APPROVAL ONLY**

## Rider Condition

A driver needs to be alert, sober, and physically ready to ride. Never use this vehicle with drugs or alcohol. Riding when intoxicated, tired or otherwise impaired increases the risk of a crash.

Alcohol, drugs, medications, fatigue, drowsiness and emotions can all inhibit your ability to ride safely. Like riding a motorcycle, riding the Spyder roadster is a challenging activity — being in good physical and mental condition is even more important than for a car. The safest policy is to never operate the vehicle unless you are alert and completely sober. Even if your blood alcohol level is not over the legal limit, your judgment and skills are impaired by any alcohol consumption.

You must be physically able to operate all controls, turn the handlebar through the full range of steering, mount and dismount, and monitor your surroundings to operate the vehicle.

Passengers also need to be alert, sober and physically able to maintain their posture, hold on and react appropriately to curves, bumps, acceleration and stops.

## Vehicle Condition

Keep your vehicle in good condition.

Do pre-operation checks and perform regular maintenance. Watch for any messages on the multifunction gauge cluster when you start the vehicle, and address any problems before you ride.

Always use the multifunction gauge with extreme caution. Prolonged attention to the display while riding significantly increases the risk of a crash.

## Road and Weather Conditions

Roads with heavy traffic, poor visibility or poor traction surfaces increase your risk. Choose routes that are appropriate for your skill level and the level of risk you are willing to accept.

# RIDING GEAR

Riding three-wheeled, open-air vehicles like the Spyder roadster requires the same protective gear as motorcycling. Even though the vehicle is more stable at low speeds than a motorcycle, you can still be thrown off.

This section is based on guidance for motorcyclists given by the Motorcycle Safety Foundation (MSF).

In the event of a crash, protective gear may prevent or reduce injuries. Protective gear also helps you stay comfortable and can help provide protection against the elements.

Recommended basic protective gear for riders and passenger includes sturdy over-the-ankle footwear with non-slip soles, long pants, a jacket, full-fingered gloves and, above all, an approved helmet with proper eye protection.

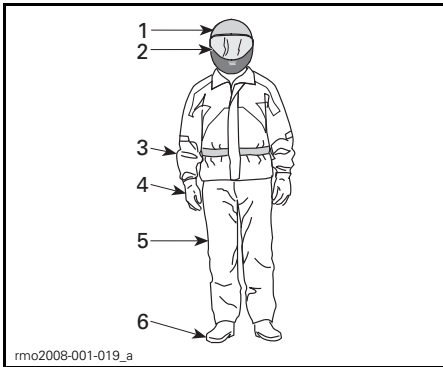

## RIDING GEAR

1. Approved helmet
2. Eye and face protection
3. Jacket with long sleeves
4. Gloves
5. Long pants
6. Over-the-ankle footwear

Proper apparel can reduce the severity of injury in case of a crash for both operators and passengers.

## Helmets

Helmets protect the head and brain from injury. A helmet can also protect the passenger's face from impact

with the back of the operator's helmet. Even the best helmet is no guarantee against injury, but statistics indicate that helmet use significantly reduces the risk of brain injury. So, be safe and always wear a helmet while riding.

## Choosing a Helmet

Helmets should be manufactured to meet the appropriate standard in your state, province or country.

A full-face helmet gives the most protection against impacts since it covers all of the head and face. It can also protect against debris, stones, insects, etc.

A three-quarter or open-face helmet can also offer protection. It is constructed with the same basic components but does not offer the face and chin protection of full-face helmets. If you wear an open-face helmet, you should use a snap-on face shield or a pair of goggles.

**NOTE:** Ordinary glasses or sunglasses are not sufficient eye protection for a motorcyclist. They can shatter or fly off, and they allow wind and airborne objects to reach the eyes.

Use tinted face shields, goggles or glasses in the daytime only; do not use them at night or in poor illumination. Do not use them if they impair your ability to discern color.

## Other Riding Gear

### Footwear

Always wear closed toe footwear. Sturdy over-the-ankle boots protect against a variety of riding hazards, such as stones that get thrown up from the roadway and burns from the hot exhaust pipe.

Avoid long shoelaces that can be tangled in the gearshift lever, brake pedal or other parts. Rubber soles and low heels are a good idea to help keep feet on the footrests.

FOR APPROVAL ONLY

## Gloves

Full-fingered gloves protect hands from the wind, sun, heat, cold and flying objects. Gloves that fit snugly will improve grip on the handlebar and help reduce hand fatigue. Sturdy, reinforced motorcycle gloves help protect hands in the event of a fall. Gloves made specifically for motorcyclists have seams on the outside to prevent irritation, and are curved to provide a natural grip when curled around the handgrips. If gloves are too bulky, it may be difficult to operate the controls. Gauntlets keep cold air from going up sleeves and protect the wrists.

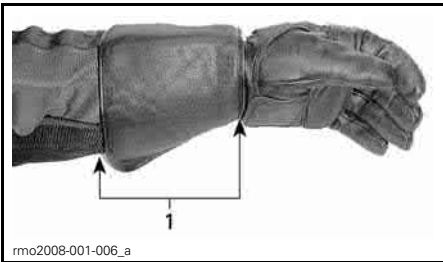

rmo2008-001-006\_a

1. *Glove gauntlet*

## Jackets, Pants and Riding Suits

Wear a jacket and long pants, or a full riding suit. Quality motorcycle-type protective gear will provide comfort, and it can help you avoid being distracted by adverse environmental elements. In case of a crash, good quality protective gear made of sturdy material may prevent or reduce injury. Some gear includes padding or hard armor that may further reduce the risk of injury in a crash. Pants also help protect against burns from hot parts.

Protective gear sold for motorcycling will often provide the best combination of fit and protection. These garments are designed to fit while sitting in a riding position. They are cut longer in the sleeves and legs and are fuller across the shoulders. Riding suits are available in both one-piece and two-piece sets.

Leather is a good choice because it is durable and wind-resistant and provides protection against injury. Other abrasive-resistant protective gear made of synthetic fabrics are good choices, too. Do not wear loose or long clothing or scarves that can become tangled in the moving parts.

Flaps and fasteners seal out the wind. A jacket with a zippered front will be more wind resistant than a jacket with buttons or snaps. A flap of material over the zipper of a jacket gives additional protection against the wind. Jackets with snug cuffs and waist are recommended to keep wind from blowing in. A large, loose collar can flap when riding and may irritate skin or be a distraction.

In cool-weather riding, protect yourself against hypothermia. Hypothermia, a condition of low body temperature, can cause loss of concentration, slowed reactions and loss of smooth, precise muscle movement. In cool conditions, proper protective gear like a windproof jacket and insulated layers of clothing are essential. Even at moderate temperatures, you can feel very cold due to the wind while riding.

Protective gear that is appropriate for cold-weather riding may be too hot when stopped. Dress in layers so that clothing can be removed as desired. Topping the protective gear with a windproof outer layer can prevent cold air from reaching the skin.

Riding gear can also help a rider be more visible. Wearing bright colors is a wise choice. If a dark jacket is worn, an inexpensive reflective vest can be worn over it. It is a good idea to put extra reflective tape on garments worn regularly while riding.

## Rain Gear

If you must ride in wet weather, a rain suit or a waterproof riding suit is recommended. On long rides, it is a good

idea to carry rain gear. A dry rider will be much more comfortable and alert than a rider who is wet and cold.

One or two-piece styles are available, and those designed specifically for motorcycling are best. High-visibility orange or yellow colors are good choices. A feature to look for is elastic in the waist, pant legs and sleeves. The jacket should have a high collar and zip up with wide flaps across the opening. When purchasing a rain suit, consider adding waterproof gloves and footwear.

Remember, if the weather is wet, it is best to avoid riding. If you do ride in wet weather, you may need to stop if water starts to accumulate on the road.

### **Hearing Protection**

Long-term exposure to wind and motor noise when riding can cause permanent hearing loss. Properly worn hearing protective devices such as earplugs can help prevent hearing loss. Check local laws before using any hearing protective devices.

**FOR APPROVAL ONLY**

---

# REQUIRED RIDING SKILLS AND PRACTICE EXERCISES

Before you take the Spyder roadster on the road, you need to develop riding skills and strategies for managing risk on the road. The following exercises will familiarize you with the basic operation of the vehicle. If you have experience with motorcycles or other motor vehicles, pay particular attention to how the Spyder roadster operation and performance are different from vehicles you are used to. Practice each exercise until you can perform it proficiently before moving on to the next. This section includes the following exercises:

## *SM6 Model*

1. Revving the engine and using the engine stop switch
2. Learning the friction zone and basic handling
3. Engine stop while in motion
4. Using the throttle and clutch
5. Basic turns
6. Quick stops
7. Weaves
8. Shifting
9. Swerve
10. Operating in reverse.

## *SE6 Model*

1. Revving the engine and using the engine stop switch
2. Starting, stopping, and basic handling
3. Engine stop while in motion
4. Basic turns
5. Quick stops
6. Weaves
7. Shifting
8. Swerve
9. Operating in reverse.

## Choosing a Practice Area

Perform these exercises in a paved area at least 76 m - 30 m (250 ft - 100 ft) that is not open to traffic. A closed, well marked parking lot without obstacles (light poles, curbs, etc.) makes a good practice area. Be aware of oil left by parked cars. Look for parking lots that are empty during off hours, such as schools, churches, community centers or shopping centers. Do not trespass on private property.

Once you have selected a suitable location, get permission to use it from the owner. If there are obstructions, such as light poles or islands, be sure that they do not interfere with the required open paths shown in the diagram below.

Keep this basic parking lot diagram in mind when setting up the exercises. 3 m (10 ft) wide parking lot spaces are indicated in the diagrams for convenience, but the size of the spaces in the lot you use may be different. If the parking lot you choose does not have lines or if the parking spaces are sized much larger or smaller than the ones in the diagrams, use the dimensions shown below. Mark them using a tape measure and chalk or markers such as cones or milk containers weighted with water or sand.

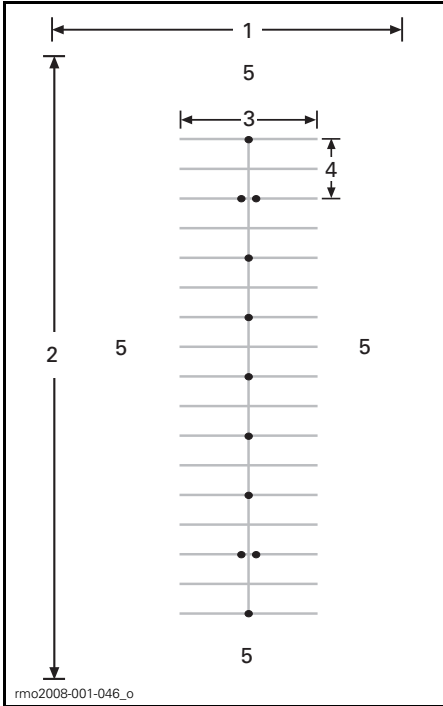

**TYPICAL PARKING LOT**

1. At least 30 m (100 ft)
2. At least 75 m (250 ft)
3. 12 m (40 ft)
4. 6 m (20 ft)
5. Open area

Even in a closed lot, be aware of potential traffic. Check to the front, sides and rear before doing an exercise. Also, watch out for children and animals.

**Preparing to Ride**

Know the location and operation of all the vehicle controls. Refer to *VEHICLE INFORMATION* section.

Perform the pre-ride inspection. Refer to *PRE-RIDE INSPECTION* section.

Always start and stop the engine according to the instructions in *STARTING AND STOPPING THE ENGINE* in *BASIC PROCEDURES*.

**Riding Posture**

Good posture helps you maneuver the vehicle more easily. Always keep both hands and both feet in position so that you can operate the controls easily. The wrist should typically be aligned straight with the arm (this position helps you apply the amount of throttle you want). Arms should be relaxed and bent. Keep your back straight and your head and eyes up. Keep both feet on the pegs near the controls.

Never operate the vehicle, even for a short distance, unless you are in the proper riding posture.



RIDING POSTURE

**Practice Exercises (SM6 Model)**

**1) Revving the Engine and Using the Engine Stop Switch**

**Purpose**

- Become familiar with the sound of the engine revving so you will not be surprised during the exercises.
- Become familiar with using the engine stop switch.

FOR APPROVAL ONLY



**Directions**

- With the vehicle in NEUTRAL, the parking brake engaged, and your right foot pressing the brake pedal, pull in and hold the clutch lever. Watch the tachometer and apply throttle (twist lowering your wrist) a few times to raise the RPM to no more than 4000. As long as the clutch is fully pulled in the power will not transfer to the rear wheel.
- Use the engine stop switch to cut all power to the vehicle. Press the switch with your right thumb while keeping your hand on the handgrip.

**Tips for Additional Practice**

- Practice pressing the engine stop switch without looking at it.

**2) Learning the Friction Zone and Basic Handling**

Pulling in the clutch disengages power to the rear wheel — if you feel like you are losing control while doing these exercises, you can pull in the clutch to stop accelerating and apply the brake as needed to slow down. You can also use the engine stop switch to cut power entirely.

The friction zone is the area in the travel of the clutch lever that begins where the clutch starts to transmit power to the rear wheel and ends just before the clutch becomes fully engaged. While the clutch is partially engaged, it allows you to precisely control engine power transmitted to the rear wheel. Proper use of the friction zone helps you get moving smoothly from a stop.

**Purpose**

- Become familiar with the clutch and operating within the friction zone.
- Become familiar with low speed deceleration and braking.

**Directions**

For this exercise, do **NOT** use any throttle. You will be controlling your movement using only the clutch in the friction zone and brake.

Begin by stopping every 6 m (20 ft) (every marker/every second line).

- Start the engine and release the parking brake.
- With the brake pedal depressed and the clutch lever pulled in, shift the transmission into first gear by firmly pushing down on the shift lever.
- Release the foot brake.
- **Slowly** let out the clutch lever until the vehicle starts to creep forward. Hold the clutch lever at this point. This is the friction zone. If you release the clutch too quickly, the engine may stall or the vehicle may jump forward. **If the vehicle stalls**, restart the engine and try again, releasing the clutch more gradually.
- As you approach the stopping point, pull the clutch lever all the way in and press the brake pedal to stop. Pulling the clutch in does not have to be gradual — you can do this quickly.
- When you reach the end of the straightaway, stop, turn the handlebar all the way to the right, and turn around. Be careful not to apply throttle as you turn. Stop when you are in line with the straightaway in the opposite direction.
- Repeat this exercise until you feel comfortable.

**Tips for Additional Practice**

- As you become more comfortable with the friction zone, try stopping every 12 m (40 ft) (every other cone) so that you can fully release the clutch.

**FOR APPROVAL ONLY**

### 3) Engine Stop while in Motion

#### Purpose

- Become familiar with using the engine stop switch when in motion so you know how the vehicle will react if you need to use it later.

#### Directions

- Partway down the straightaway, while operating in the friction zone, toggle the engine stop switch to OFF position and coast to a stop.
- Restart the engine and repeat the exercise. Try releasing the clutch farther and moving a little faster before using the engine stop switch.

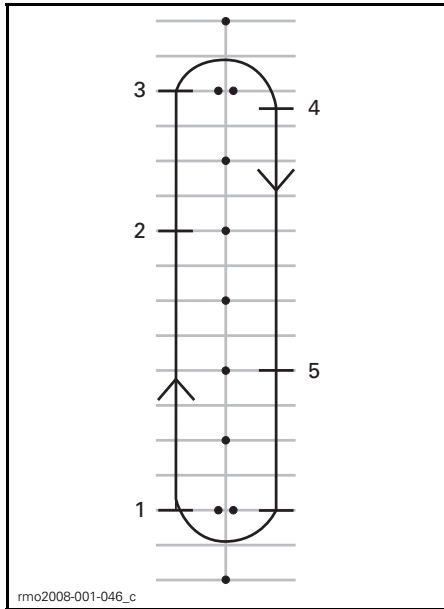

1. Start
2. Press engine stop switch
3. Proceed to end of straightaway, stop and turn as before
4. Stop
5. Press engine stop switch

Restart the engine and proceed to the next exercise.

### 4) Using the Throttle and Clutch

#### Purpose

- Become familiar with operating the throttle.
- Learn to balance throttle and clutch.

#### Directions

This exercise is similar to the friction zone exercise, except this time you will be using some throttle. You will use the entire straightaway, stopping only at the ends.

- Start this exercise stopped in first gear at the beginning of a straightaway.
- With the clutch lever pulled in, gently apply throttle until the tachometer reads between 1500 and 2000 RPM. Practice holding it within this range.
- Hold the throttle at this position while gently releasing the clutch lever as before. Try not to let the RPMs exceed 2500.
- The more quickly you release the clutch lever, the more quickly you will accelerate. If you release the clutch too quickly, the engine may stall or the vehicle may jump forward. Applying too much throttle can cause the rear wheel to spin and can result in rapid acceleration.
- When the clutch lever is fully released, the throttle controls your speed.
- As you approach the end of the straightaway, release the throttle, pull in the clutch lever and apply the brakes to come to a stop.
- Without using throttle, turn around and head down the opposite straightaway.

**FOR APPROVAL ONLY**

**FOR APPROVAL ONLY**

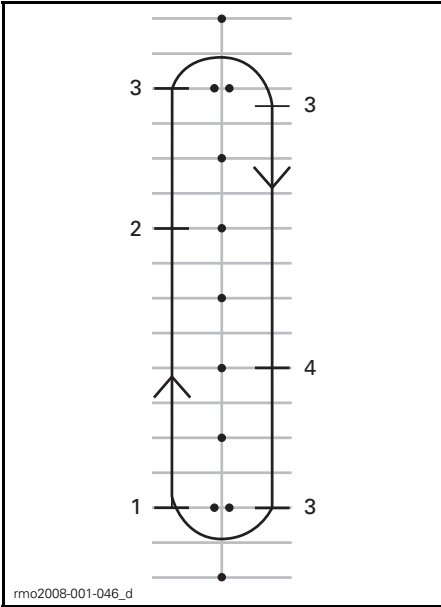

1. Start
2. Release throttle
3. Stop
4. Release throttle

**Tips for Additional Practice**

- Coordinate releasing the clutch lever and applying the throttle to start smoothly and to control your acceleration.

**5) Basic Turns**

**Purpose**

- Get comfortable turning in a controlled manner.

**Directions**

This exercise is similar to what you did before, except that now instead of stopping for each turn, you will make the turn in the friction zone.

- Proceed down the straight away in first gear. Ride a little farther from the cones so you can make a wide arcing turn at the end of the straight-away.

- As you approach the curve, slow down to no more than 8 km/h (5 MPH) by pulling in the clutch lever and applying brake if needed.
- Hold the clutch lever in the friction zone to maintain your low speed.
- Look in the direction of the curve.
- Turn the handlebar in the direction of the curve, pulling on the inside hand-grip and pushing on the outside. Be careful not to change your hand position on the throttle.
- Leaning forward and into the curve may help you turn the handlebar more easily.
- Straighten your handlebar after the turn and proceed down the straight-away.



**RIDING POSTURE WHEN TURNING**

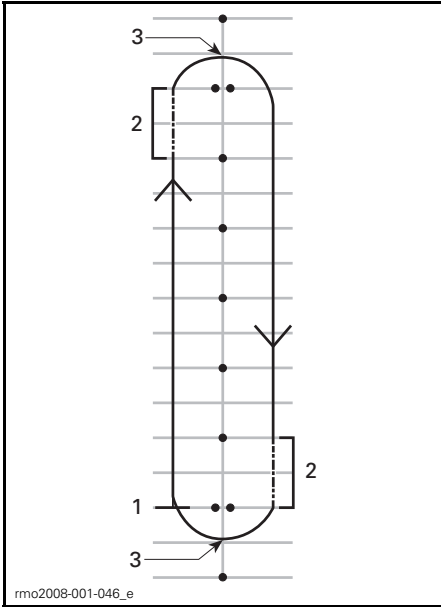

1. Start
2. Friction zone
3. Apex

**NOTE:** Motorcyclists - Riding through turns and curves with your Spyder roadster is different than on a motorcycle. The vehicle does not lean during a turn, so you may need to shift your body weight towards the inside of the turn to keep a comfortable posture on the vehicle. You will need to exert more force to turn the handlebar of your vehicle than is needed to turn a motorcycle. However, it is easier to stop while turning than with a motorcycle.

**Tips for Additional Practice**

- After you are comfortable turning in one direction, try going around the course the other way. Be careful not to apply more throttle than you intend when turning left.
- Stop at the apex of the turn to see what it is like to use your brakes in a curve or turn.

**6) Quick Stops**

**Purpose**

- Become familiar with the vehicle's braking ability.
- Learn to apply brakes with maximum force.

**Directions**

This exercise is similar to what you did before, except you'll be applying the brake more firmly, working up to braking as hard as possible.

- Start at one end of the straight away and accelerate to 8 km/h (5 MPH).
- Partway down the straightaway, release the throttle completely and brake quickly and firmly.
- Keep head and eyes up and keep handlebar straight.
- Repeat, increasing your speed and braking harder.

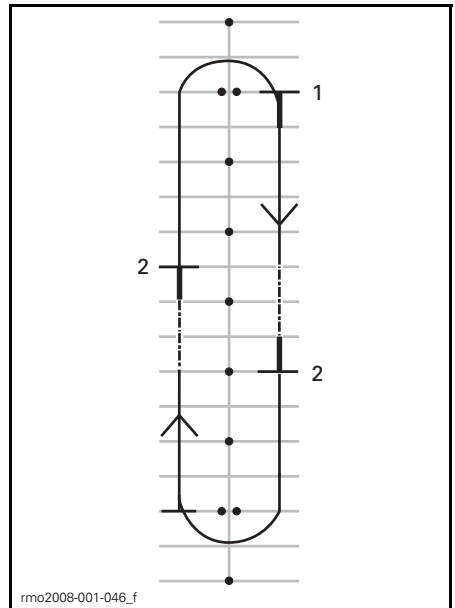

1. Start
2. Stop

**FOR APPROVAL ONLY**

**Tips for Additional Practice**

- Practice checking your mirrors before braking hard.

**7) Weaves**

**Purpose**

- Get more experience with the vehicle handling and rider position.

**Directions**

**6 m (20 ft) Weave**

1. Weave between every marker/intersection of every other parking spot. Do not use throttle — stay in the friction zone.
2. Lean into each turn and turn the handlebar in the direction you want to go by pulling and pushing the grips.

**FOR APPROVAL ONLY**

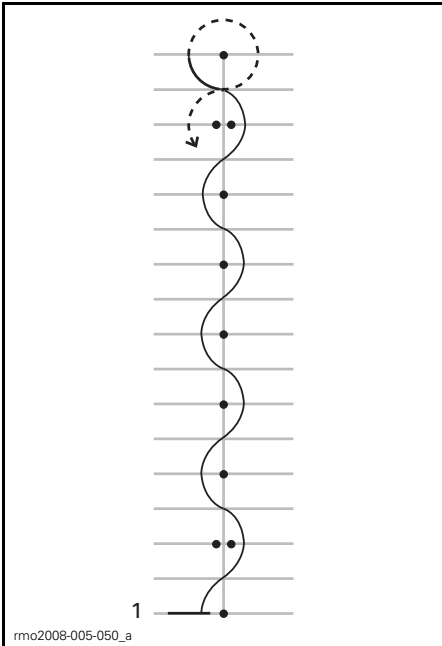

1. Start

**12 m (40 ft) Weave**

Once you're comfortable, try doing 12 m (40 ft) weaves between every other cone/every fourth parking space.

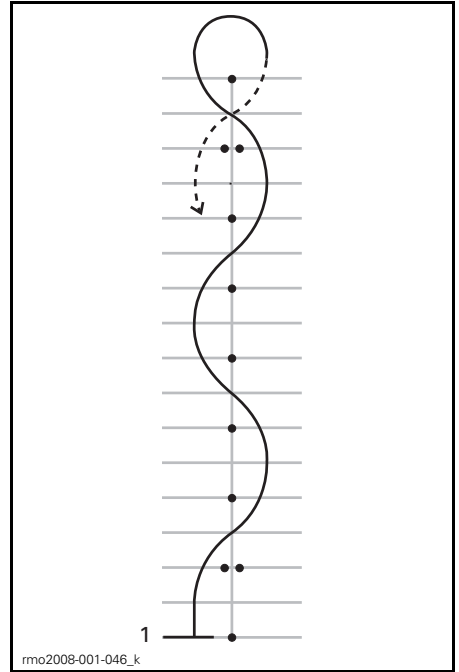

1. Start

**Tips for Additional Practice**

- You can gradually increase speed as you get comfortable to 16 km/h - 19 km/h (10 MPH - 12 MPH) for the weaves, but slow down for the U-turns at the ends.

**8) Shifting**

When riding, you must change gears to match the engine speed with road speed.

**Purpose**

- Become familiar with the foot motions needed to shift gears.
- Learn to upshift and downshift.

**Directions**

This exercise is similar to what you did before, except now you will be upshifting on the straightaways, then coming to a stop at the end of each straight-

away. You may want to use the parking lot aisles for this exercise rather than riding in the spaces.

### 8a) Practice Using the Shift Lever at a Stop

First, while stopped, practice the left foot motion for shifting between first and second gears.

- At a stop in first gear, pull in the clutch lever.
- Slide the tip of your left foot under the shift lever and lift it as far as it will go, one firm stroke up to shift into second gear.
- Step on the shift lever and press it as far as it will go, one firm stroke down to shift into first gear.
- Repeat until you are comfortable with the foot motions required.

### 8b) Upshifting from First into Second Gear

In the straightaway, accelerate to approximately 16 km/h (10 MPH) in first gear.

To upshift:

- Release the throttle.
- Pull in the clutch lever. (If you pull in the clutch before releasing throttle, the engine may rev — just release the throttle if this happens.)
- Slide the tip of your left foot under the shift lever and lift it as far as it will go, one firm stroke up to shift into second gear.
- Smoothly ease out the clutch.
- You do not need to apply throttle, but once you are comfortable, if space allows, you can apply the throttle to increase speed in second gear.

As you approach the end of the straightaway, come to a stop:

- Release the throttle.
- Pull the clutch lever all the way in.

- Apply brake.
- After stopping, downshift into first gear by stepping on the shift lever and pressing it as far as it will go, one firm stroke down. Once you are more comfortable, downshift into first as you come to a stop.

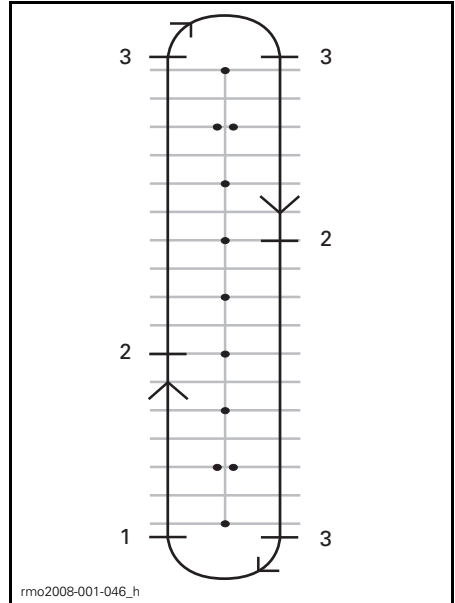

1. Start
2. Shift into second at 16 km/h (10 MPH)
3. Stop

### 8c) Downshifting from Second to First Gear

If space allows, practice downshifting into from second to first gear.

In the straightaway, slow to approximately 16 km/h (10 MPH).

- Release the throttle and pull in the clutch lever.
- Step on the shift lever to shift into first gear.
- Smoothly ease out the clutch.
- Put your foot back on the peg.

FOR APPROVAL ONLY

### 8d) Other Gears

If space allows, you can try shifting into and out of higher gears as well. Follow the same process and shift up or down one gear at a time.

#### Tips for Additional Practice

As you gain more experience, you can refine your shifting skills and use them to better control the vehicle.

- When downshifting, rolling on the throttle slightly while smoothly easing out the clutch can help the engine rev up to match vehicle speed more quickly and make the downshift smoother, preventing skidding of the rear wheel.
- Shifting to a lower gear slows the vehicle if you do not apply throttle. This is known as engine braking. To use engine braking, shift down one gear at a time and ease out the clutch between each downshift. Keep the clutch in the friction zone until the engine speed stabilizes, then ease out the lever fully until ready for the next downshift.
- Usually you shift gears one at a time, but it is possible to shift through more than one gear while the clutch is squeezed by repeating the up or down stroke as many times as you want gear changes.

Remember that VSS does not control engine braking. If you shift into too low a gear when you are at high speed, the rear tire can skid and you can lose control, spin out, tip or roll over, particularly in a curve.

### 9) Swerve

#### Purpose

- Become familiar with the vehicle's handling for quick maneuvers.
- Try different variations of braking and swerving.

#### Directions

Set up your markers as shown in the diagram below. Do not use any fixed or hard, heavy objects as markers for this exercise.

- Enter between the double cones at about 8 km/h (5 MPH) and maintain that speed throughout.
- Steer around the line of cones.
- Exit through the second set of double cones.
- Repeat the exercise multiple times, swerving in both directions.

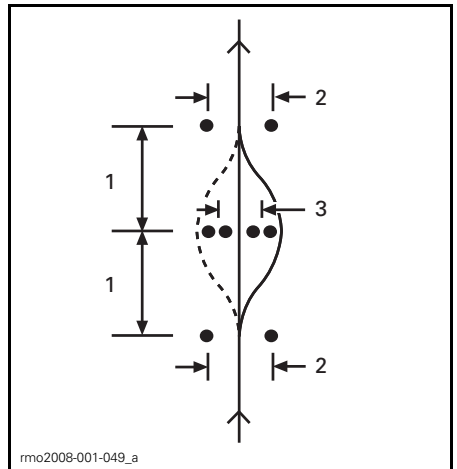

1. 6 m (20 ft)
2. 3 m (10 ft)
3. 2.5 m (8 ft)

#### Tips for Additional Practice

- You can gradually increase your entry speed (to no more than 13 km/h to 19 km/h (8 MPH to 12 MPH) and try some variations. For example, approach faster and slow before entering the exercise, pull in the clutch and apply brakes during the swerve, etc.

FOR APPROVAL ONLY

- A helper can add an element of surprise to the exercise by deciding which direction you should swerve, or if you should come to a stop instead. Have your helper stand at a safe distance (e.g., beyond the end of your practice area). As you reach the first set of cones, the helper can use hand signals to indicate which direction to swerve or for you to stop.
- Practice checking your mirrors and blind spot before you swerve.

## 10) Operating in Reverse

### Purpose

- Become familiar with the vehicle's handling and turning radius in reverse.

### Directions

Shift into reverse. See *OPERATING IN REVERSE* in *BASIC PROCEDURES*.

Check that the area behind you is clear and continue to look backwards while you ease out the clutch. Be careful not to strike anything with your front wheels as you back up. Slow and stop using clutch and brake, just like when operating normally.

Back for a few feet at a time, stopping in between.

Keep your speed low and do not back up for long distances.

After you are comfortable with reverse, back into a parking space as shown in the diagram below.

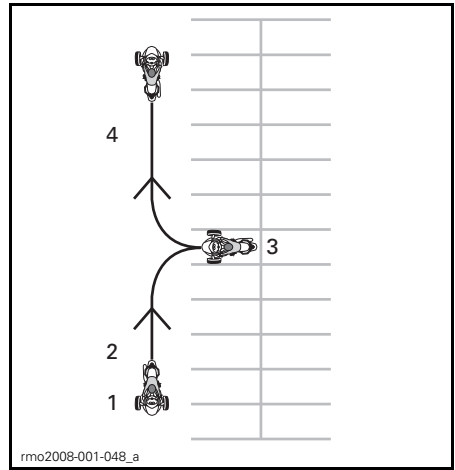

1. Start
2. Reverse
3. Stop
4. Forward

### Additional Practice in Controlled Environments

Once you are comfortable with all of the above exercises, you can try a few other things as space and conditions allow. This might be in the parking lot or at a later time in a place where you have the opportunity without putting yourself at risk.

- **Quick starts:** Try quickly getting up to speed and upshifting through the gears.
- **Quick stop from higher speed:** Similar to the quick stop exercise, but performed from higher speeds to get a feel for emergency stops.
- **Starting up an incline:** To do this, keep holding the brake pedal as you release the clutch lever until you are in the friction zone. This will keep you from rolling backwards.

FOR APPROVAL ONLY



## Practice Exercises (SE6 Model)

### 1) Revving the Engine and Using the Engine Stop Switch

#### Purpose

- Become familiar with the operation of the twist throttle.
- Become familiar with the sound of the engine at different RPMs. This will help you to know when to up-shift and downshift based on the engine sound.
- Become familiar with using the engine stop switch.

#### Directions

- Start with the vehicle in NEUTRAL, the parking brake engaged, and your right foot on the brake pedal. Check the multifunction gauge cluster to be sure you are in NEUTRAL — if you are in first gear, the roadster will try to start moving when you apply the throttle.
- Watch the tachometer and apply throttle (twist by lowering your wrist) a few times to raise the RPM to no more than 4000. Practice applying the throttle gently and smoothly, holding it steady at about 3000 RPM, and releasing it. As long as the transmission is in neutral the power will not transfer to the rear wheel.
- Use the engine stop switch to cut all power to the vehicle. Press the switch with your right thumb while keeping your hand on the handgrip.

#### Tips for Additional Practice

- Practice pressing the engine stop switch without looking at it.

### 2) Starting, Stopping and Basic Handling

#### Purpose

- Learn throttle control and how to get the vehicle moving.
- Become familiar with low speed deceleration and braking.

#### Directions

If you feel like you are losing control while doing these exercises, release the throttle to stop accelerating and apply the brake as needed to slow down. You can also use the engine stop switch to cut power entirely.

#### 2a) Apply and Immediately Release Throttle

#### Directions

At first, you will only use the throttle for a moment at a time, then release it and coast.

- Start the engine and release the parking brake.
- With the brake pedal depressed, shift the transmission into first gear by pressing the gear selector forward.
- Release the brake.
- Slowly apply throttle until the vehicle starts to creep forward. As soon as you start moving release the throttle and coast, then press the brake to stop. Repeat to the end of the straightaway.
- To turn around at the end of the straightaway, stop, turn the handlebar all the way to the right, then briefly apply and release the throttle, and coast through the turn. You may need to briefly apply the throttle more than once to complete the turn. Stop when you are in line with the straightaway in the opposite direction.
- Continue with this part of the exercise until you are comfortable with applying and releasing the throttle.

## 2b) Hold Throttle, Release and Stop Every 12 m (40 ft)

Next, you will be holding the throttle a little longer, then stopping every 12 m (40 ft) (every other marker/every fourth line).

- Again, slowly apply throttle until the vehicle starts to creep forward. This time, hold the throttle at this point.
- As you approach the stopping point, release the throttle and press the brake to stop.
- Turn around at the end of the straightaway as before, except now you do not need to release the throttle during the turn. Pay attention to maintaining a steady throttle position as you turn. Stop when you are in line with the straightaway in the opposite direction.

## 2c) Hold Throttle, Release and Stop at Ends

Next, use the entire straightaway, stopping only at the ends. Keep the throttle moderate.

## 3) Engine Stop while in Motion

### Purpose

- Become familiar with using the engine stop switch when in motion so you know how the vehicle will react if you need to use it later.

### Directions

- Partway down the straightaway, while operating at 8 km/h (5 MPH), toggle the engine stop switch to OFF position and coast to a stop.
- Restart the engine and repeat the exercise. Try increasing your speed (to a maximum of 20 km/h (12 MPH) before using the engine stop switch.

**NOTE:** SE6 model will not start in gear without brake pedal depressed.

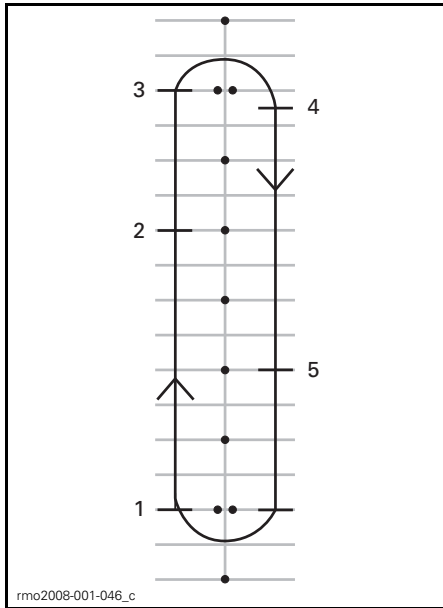

1. Start
2. Press engine stop switch
3. Proceed to end of straightaway, stop and turn as before
4. Stop
5. Press engine stop switch

Restart the engine and proceed to the next exercise.

## 4) Basic Turns

### Purpose

- Get comfortable turning in a controlled manner.

### Directions

This exercise is similar to what you did before, except that now instead of stopping for each turn, you will make the turn at low speed.

- Proceed down the straight away in first gear. Ride a little farther from the cones so you can make a wide arcing turn at the end of the straightaway.
- As you approach the curve, slow down to no more than 8 km/h (5 MPH) by releasing the throttle and apply brake if needed.

**FOR APPROVAL ONLY**

FOR APPROVAL ONLY

- Hold the throttle to maintain your low speed.
- Look in the direction of the curve.
- Turn the handlebar in the direction of the curve, pulling on the inside handgrip and pushing on the outside, being careful not to apply throttle.
- Leaning forward and into the curve may help you turn the handlebar more easily.
- Straighten your handlebar after the turn and proceed down the straightaway.



TYPICAL - RIDING POSTURE WHEN TURNING

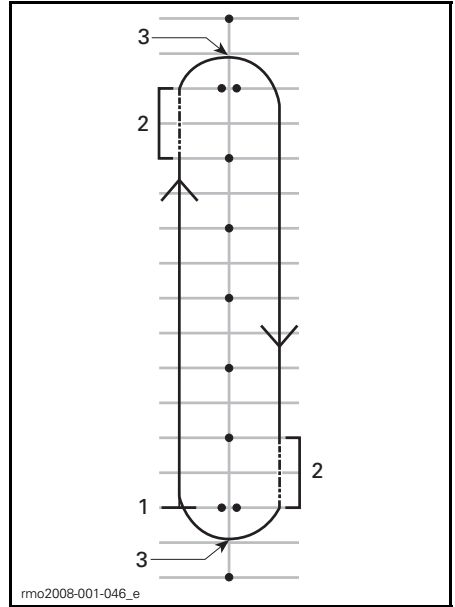

1. Start
2. Friction zone
3. Apex

**NOTE:** Motorcyclists - Riding through turns and curves with your Spyder roadster is different than on a motorcycle. The vehicle does not lean during a turn, so you may need to shift your body weight towards the inside of the turn to keep a comfortable posture on the vehicle. You will need to exert more force to turn the handlebar of your vehicle than is needed to turn a motorcycle. However, it is easier to stop while turning than with a motorcycle.

**Tips for Additional Practice**

- After you are comfortable turning in one direction, try going around the course the other way. Be careful not to apply more throttle than you intend when turning left.
- Stop at the apex of the turn to see what it is like to use your brakes in a curve or turn.

## 5) Quick Stops

### Purpose

- Become familiar with the vehicle braking ability.
- Learn to apply brakes with maximum force.

### Directions

This exercise is similar to what you did before, except you'll be applying the brake more firmly, working up to braking as hard as possible. The Antilock Braking System (ABS) will prevent the wheels from locking and help you maintain steering control while applying maximum braking force. Always release the throttle completely for quick stops with the SE6. If you apply throttle and brake at the same time, your stopping distance will be longer.

- Start at one end of the straightaway and accelerate to 8 km/h (5 MPH). Partway down the straightaway, release the throttle completely and brake quickly. Never pump the brake as the ABS will prevent wheel lock.
- Keep head and eyes up, keep handlebar straight, and do not release the brake until fully stopped.
- Repeat, increasing your speed and braking harder.

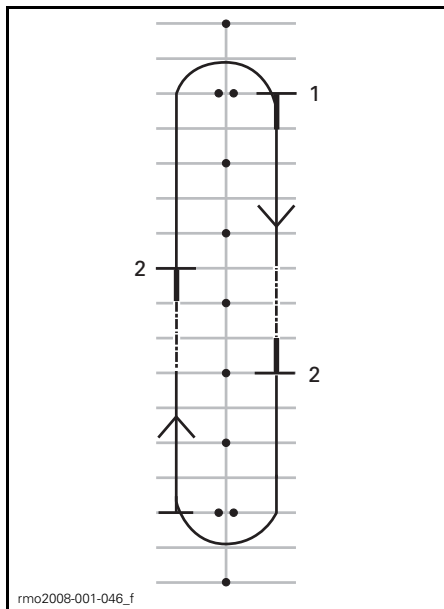

1. Start
2. Stop

### Tips for Additional Practice

- Practice checking your mirrors before braking hard.

## 6) Weaves

### Purpose

- Get more experience with the vehicle handling and rider position.

### Directions

#### 6 m (20 ft) Weave

1. Weave between every marker/intersection of every other parking spot. Keep your speed low initially as you get used to making the changes of direction.
2. Lean into each turn and turn the handlebar in the direction you want to go by pulling and pushing the grips.

FOR APPROVAL ONLY

**FOR APPROVAL ONLY**

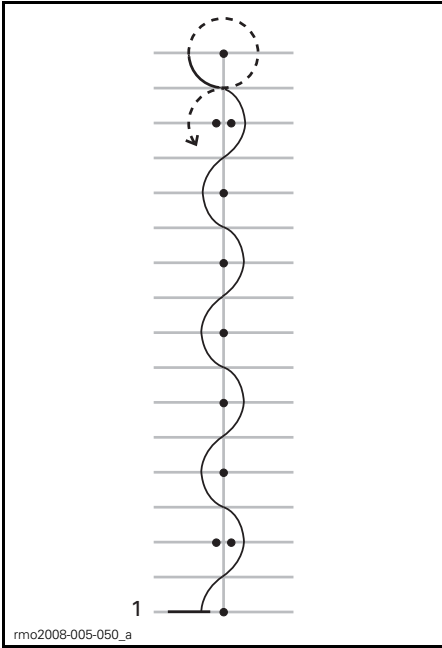

1. Start

**12 m (40 ft) Weave**

Once you're comfortable, try doing 12 m (40 ft) weaves between every other cone/every fourth parking space.

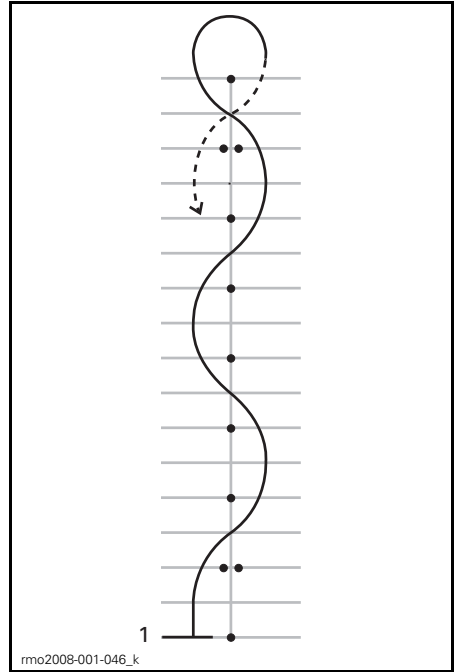

1. Start

**Tips for Additional Practice**

- You can gradually increase speed as you get comfortable to 16 km/h - 19 km/h (10 MPH - 12 MPH) for the weaves, but slow down for the U-turns at the ends.

**7) Shifting**

When riding, you must change gears to match the engine speed with road speed. Lower gears are used for lower speeds and higher gears are used for higher speeds, just like on a manual transmission car or truck.

The SE6 will automatically downshift if the engine speed drops under 1800 RPM.

**Purpose**

- Learn to upshift and downshift.

**Directions**

This exercise is similar to what you did before, except now you will be upshifting on the straightaways, then coming to a stop at the end of each straightaway. You may want to use the parking lot aisles for this exercise rather than riding in the spaces.

**7a) Practice Using the Gear Selector at a Stop**

First, while stopped, practice to single shift between reverse, neutral and first gear. Then practice to:

- Double shift from reverse to first gear
- Double shift from first to reverse gear
- Repeat until you are comfortable.

**7b) Upshifting from First into Second Gear**

- In the straightaway, accelerate until the engine speed reaches 3000 RPM.
- Press the gear selector forward to shift into second gear. You do not have to release the throttle while shifting with the SE6.
- Once you are comfortable, if space allows, you can adjust the throttle to increase speed in second gear.

As you approach the end of the straightaway, come to a stop:

- Release the throttle
- Apply brake
- The SE will downshift automatically as the roadster slows. You can also manually downshift by pulling the gear selector towards you.

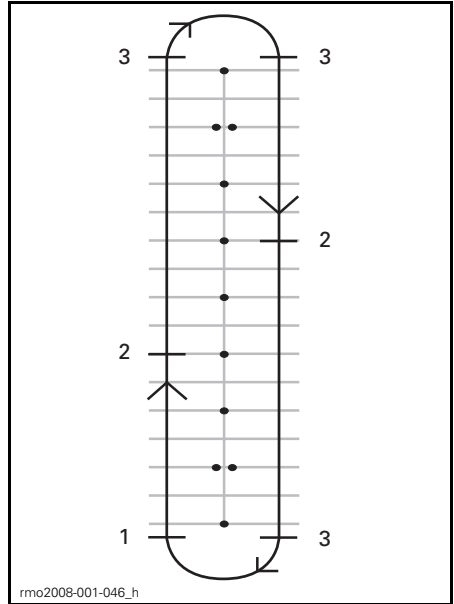

1. Start
2. Shift into second at 25 km/h (16 MPH)
3. Stop

**7c) If Space Allows, Practice Downshifting into First While Moving**

In the straightaway:

- Pull the gear selector toward you without releasing throttle.
- You will feel more engine braking when you downshift without throttle.

**7d) Other Gears**

If space allows, you can try shifting into and out of higher gears as well. Follow the same process and shift up or down one gear at a time.

**FOR APPROVAL ONLY**

**NOTE:** Applying slightly more throttle while downshifting can help the engine rev up to match vehicle speed more quickly and make the downshift smoother. When you do not apply throttle while downshifting, engine braking will slow the vehicle. This can help you decrease speed, but remember that VSS does not control engine braking. If you shift into too low a gear when you are at high speed, the rear tire can skid and you can lose control, spin out, tip or roll over, particularly in a curve.

**FOR APPROVAL ONLY**

**8) Swerve**

**Purpose**

- Become familiar with the vehicle's handling for quick maneuvers.
- Try different variations of braking and swerving.

**Directions**

At this point you will need to change your course. Set up your markers as shown in the diagram below. Do not use any fixed or hard, heavy objects as markers for this exercise.

- Enter between the double cones at about 8 km/h (5 MPH) and maintain that speed throughout.
- Steer around the line of cones.
- Exit through the second set of double cones.
- Repeat the exercise multiple times, swerving in both directions.

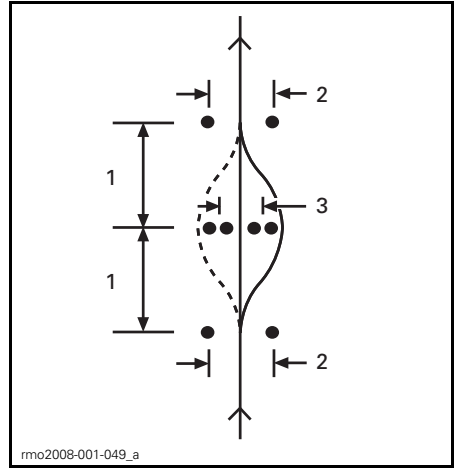

1. 6 m (20 ft)
2. 3 m (10 ft)
3. 2.5 m (8 ft)

**Tips for Additional Practice**

- You can gradually increase your entry speed (to no more than 13 km/h to 19 km/h (8 MPH to 12 MPH) and try some variations. For example, approach faster and slow before entering the exercise, apply brakes during the swerve, etc.
- A helper can add an element of surprise to the exercise by deciding which direction you should swerve, or if you should come to a stop instead. Have your helper stand at a safe distance (e.g., beyond the end of your practice area). As you reach the first set of cones, the helper can use hand signals to indicate which direction to swerve or for you to stop.
- Practice checking your mirrors and blind spot before you swerve.

**9) Operating in Reverse**

**Purpose**

- Become familiar with the vehicle handling and turning radius in reverse.

**Directions**

- Shift into reverse. See *OPERATING IN REVERSE* in *BASIC PROCEDURES*.
- Check that the area behind you is clear. Continue to look backwards. Be careful not to strike anything with your front wheels as you back up. Slow and stop by releasing throttle and using brake, just like when operating normally.
- Back for a few feet at time, stopping in between.
- Keep your speed low and do not back up for long distances.
- After you are comfortable with reverse, back into a parking space as shown in the diagram below.

Start by riding in less challenging situations:

- Short distances
- Good weather
- Low traffic
- Daytime
- Lower speeds
- No passenger.

You can gradually move on to more challenging riding situations as you develop your skills.

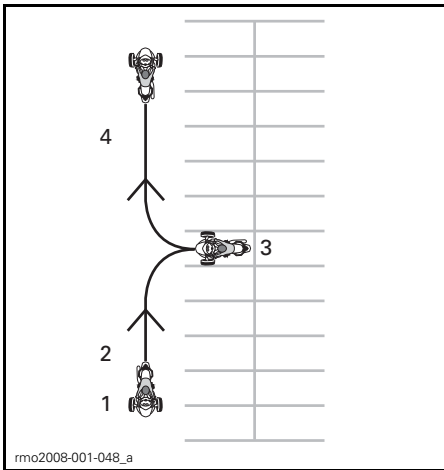

1. Start
2. Reverse
3. Stop
4. Forward

**Developing Advanced Riding Skills**

Once you have mastered basic riding skills, you can begin developing more advanced skills. First, learn the "Street Strategies" covered in the next section. Then you can take the vehicle on the road in relatively low-risk situations.

**FOR APPROVAL ONLY**



# STREET STRATEGIES

This section provides some strategies to reduce your risk on the road. Many of these strategies are similar to those used for motorcycles.

This section is based on guidance for motorcyclists given by the Motorcycle Safety Foundation (MSF). However, even experienced motorcyclists should read this section, as some strategies are different for the Spyder roadster.

## Plan your Trip

Always check weather conditions before riding the vehicle. Take appropriate gear for any weather you might encounter.

Plan a route and ride in conditions that are appropriate for your skill level.

The vehicle has a 25 L (6.6 U.S. gal.) fuel tank. When the low fuel indicator light flashes, fill fuel tank as soon as possible. Plan your refueling stops, particularly in unpopulated areas.

## Defensive Riding

As with a motorcycle, defensive riding can help you avoid crashes. You need to stay alert at all times. Never stop watching your surroundings, including the area behind you. Always scan for potential hazards, plan ahead, and leave space and time to avoid trouble. Do not assume other motorists will see you or follow the rules of the road.

## Following Distance

Always leave at least a two-second following distance between you and the vehicle in front of you when operating under ideal riding conditions. This means that you should pass any fixed point on the road at least two full seconds after the vehicle in front of you.

When conditions make braking distance longer, or visibility is limited, use a longer following distance for a greater margin of safety. For example, braking distance is longer on slippery

road surfaces, down hills, or when carrying more weight, and visibility may be limited in fog, in curves or at night.

## Scanning Ahead

In addition to leaving adequate following distance to the next vehicle, scan ahead and plan your path even farther in advance.

Plan your immediate path at least four seconds ahead. Watch this path for hazards, such as anything in the road or anything entering the road.

Scan ahead 12 seconds along your anticipated path to identify potential hazardous situations before they happen. For example, look for intersections where other vehicles may appear or places where pedestrians might enter the road. Be prepared to respond if a hazardous situation develops.

## Watch Behind and to the Sides

Vehicles and other hazards can approach from all directions. Constantly be aware of your surroundings. Check your mirrors frequently to see directly behind you. Also do frequent head checks (turn your head to look) to monitor your blind spot.

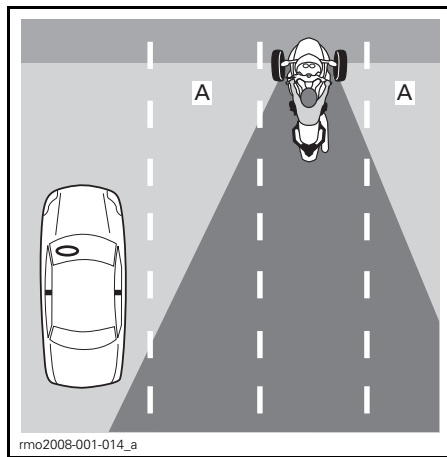

A. Operator's blind spots

FOR APPROVAL ONLY

When braking, be particularly aware of vehicles behind you that may not be able to stop as quickly as the Spyder roadster.

### Keep your Eyes Moving

To stay aware of your surroundings, do not fixate on any one thing. Move your eyes constantly to monitor the road, traffic control markings and devices and other vehicles. Look near and far, in all directions.

### Anticipate Trouble

Whenever you notice a potential hazard, plan a way to avoid it. This might mean adjusting your speed or lane position, or changing lanes. You should be ready for evasive maneuvers such as swerving and/or braking if something enters your path. Always leave time and space to react to trouble.

### Being Visible

Motorists tend not to see smaller vehicles like motorcycles. Therefore you should use strategies to become more visible.

### To Be More Visible to Other Motorists

#### Lighting and Reflectors

Make sure that the headlights, running lights and taillights on your vehicle work properly. Your vehicle is equipped with reflectors on the fenders, sides, and back. Make sure that all reflectors are clean and not broken or missing.

Use your high beams whenever possible, both day and night. Use low beams to avoid blinding other motorists at night or when too much light reflects back, such as in fog.

#### Signals

Use your turn signals to inform others of your intentions. The Spyder roadster has automatic canceling turn

signals, but they may not cancel after shallow turns. Make sure turn signals are off after you have completed your maneuver; leaving them on may confuse other motorists.

When possible, flash your brake lights before slowing and when waiting at intersections, to alert motorists behind you.

Use your emergency flashers to make yourself visible when needed.

You can also use your horn to attempt to alert other motorists of your presence.

Do not assume that other motorists will notice your lights, signals or horn.

### Blind Spots

Avoid riding in the blind spots of other vehicles. Position yourself so that drivers ahead can see you in their mirrors. In some cases, such as when you are following a truck or a bus, you must be farther behind the vehicle in front of you.

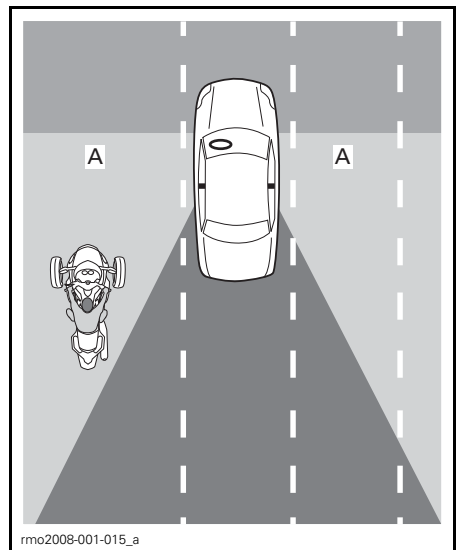

A. Blind spots of other vehicles

## Time of Day and Weather

In dim light, such as at night, at dawn or dusk, or in poor weather such as rain or fog, you may be harder to see. Glare at dawn and dusk or very bright sunlight can also make it harder for other motorists to see you.

## Clothing

Bright colors or reflective clothing can increase your visibility.

## Be Careful Even When Motorists See You

Even when motorists seem to notice you, they may still drive in a way that puts you at risk of a crash. Drive defensively, and do not rely on other motorists to operate their vehicles safely.

## Lane Position

Normally, position the Spyder roadster in the center of the lane. This position keeps the front tires in the lane. It also provides distance from vehicles in other lanes, reducing wind from large vehicles and reducing the risk of being struck by vehicles that leave their lane. This position also keeps your front wheels out of the slippery area in the middle of the lane, helping maintain braking and steering ability. If you are used to driving a car, remember that you are centered on the Spyder roadster, rather than seated to the side, so your perspective is different.

You can move to the left or right part of the lane, to avoid hazards, keep distance from other vehicles, or handle curves. You can also move to the left or right part of the lane to get a better view or to be seen by other vehicles. Because of the Spyder roadster center seat position and width, it may be harder to see around traffic, even when you are near the edge of the lane. You may need a greater following distance behind wide or tall vehicles. Avoid putting your wheel outside of the lane to see around traffic. In order

for drivers ahead to see you, you must be able to see their mirrors. When you are being followed by a large vehicle, passing vehicles may not be able to see you easily if you are not in the left part of the lane.

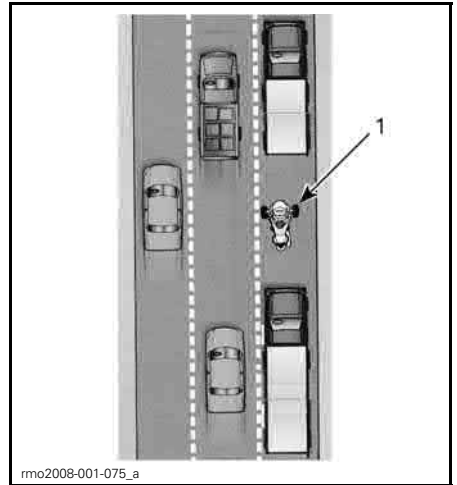

1. Vehicle in left portion of lane

Because the Spyder roadster is wider than a motorcycle, the range of lane positions is smaller. When riding in the left or right part of the lane be sure that the front wheels stay in the lane.

On multilane roads, choose a lane that is appropriate for your speed in the flow of traffic, and also consider your ability to see and be seen, and possible paths for evasive maneuvers (such as swerving into other lanes or onto the shoulder).

## Common Riding Situations

### Intersections

Intersections, including small intersections with alleys and driveways, present an additional risk due to the cross traffic. Always watch for traffic in all directions: behind, in front and to the left and right.

When stopping at an intersection, stop in the middle of the lane, even if you are preparing to turn. This can make you more visible and discourage other motorists from trying to drive around you. Watch for vehicles approaching from behind. Flash your brake lights as they approach. Be in first gear and be prepared to move if necessary to avoid a collision.

### Lane Changes and Passing

Remember that the Spyder roadster is wider than a motorcycle and needs more lateral space to pass another vehicle. Also remember that the vehicle is less visible than a car, so it is particularly important to signal your lane change well in advance and check your mirrors and blind spots. Be sure to turn off your turn signal after changing lanes; a lane change will not turn the handlebar far enough to automatically cancel the signal.

Never drive on the line between two lanes of traffic (split lanes). The vehicle is too wide.

Never drive on the shoulder to pass vehicles. If you put one wheel off the road, you can lose control.

### Turns

Remember to slow, look, and steer through turns.

- **Slow:** Reduce speed as needed before entering a turn by rolling off the throttle, using the brakes, and/or downshifting to a lower gear. Enter the turn at a speed that you can maintain throughout the turn.

Although the Spyder roadster is better able to brake while turning than a motorcycle, it is still important to slow down before you enter a turn or curve rather than braking in the turn. Braking and turning both require traction. The more traction you use for braking, the less there is available for turning at the same time.

When you take a turn or curve too fast, you may notice the inside front wheel lifting off the pavement and feel and hear VSS cutting back engine power. While VSS can help you maintain control, it is still possible to spin or roll over if you turn too hard and fast.

- **Look:** Search through the entire turn and keep your eyes moving. Evaluate the entire turn as soon as possible — surface characteristics, sharpness of the turn, and overall traffic conditions — so you have time to make decisions about speed and position. Sometimes turning your head in the direction of the turn helps to keep a good visual picture.
- **Steer:** Turn the handlebar to steer the vehicle in the direction of the turn. The Spyder roadster is not like a motorcycle, so it does not countersteer, and the vehicle does not lean. Remember, you will experience the lateral force generated by turning, so you may need to shift your body weight to the inside of the turn to keep a comfortable posture on the vehicle. You will need to exert more force to turn the handlebar of your vehicle than is needed to turn a motorcycle.

## SM6 Model

When shifting gears while turning, be careful not to release the clutch lever too fast. Adjust throttle as you release the clutch lever to match engine and vehicle speed in a smooth shift. Releasing the clutch too quickly or using too much throttle may cause the rear wheel to lose traction and start skidding, potentially causing loss of control. The Traction Control System (TCS) will detect the onset of wheel spin and reduce the power transmitted to the rear wheel. This intervention is intended to allow the rear wheel to regain traction and allow you to correct the unwanted oversteering to keep your vehicle on the intended turning radius.

## Curves

Because the Spyder roadster is narrower than a car, you can move from side to side in the lane in curves to straighten your path of travel. But the Spyder roadster is wider than a motorcycle, so less lateral movement is possible, and it is important to make sure that your front tires do not leave the lane.

For typical curves, an outside, inside, outside path is best.

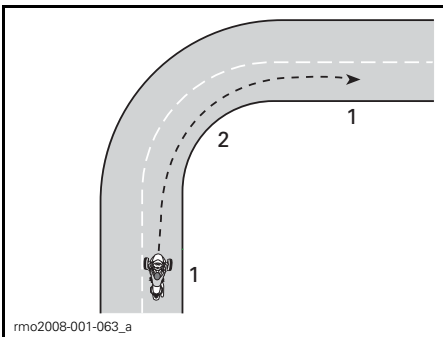

### PATH FOR TYPICAL CURVES

1. Outside
2. Inside (at the apex)

## Hills

Select an appropriate gear for the incline. Going up hills, a lower gear can help maintain enough power. Going down hills, a lower gear can provide engine braking to control your speed.

### SM6 Model

To start while on an incline, hold the vehicle in place with the brake until you move the clutch lever into the friction zone. Then smoothly release the brake as you release the clutch lever and apply throttle.

### SE6 Model

When stopped, the SE6 model can roll regardless of what gear it is in. The SE6 model clutch is always disengaged when the vehicle is stopped, so the transmission will not hold the vehicle in place. Hold the brake pedal when stopped on an incline. To start while on an incline, hold the brake pedal as you increase throttle. Release the brake pedal as you feel the clutch engage (at about 1800 RPM).

## Night Riding

In addition to using your lights and signals to be seen by other motorists, consider your own ability to see at night. Use high beams when appropriate. Avoid overriding your headlight (riding so fast that you can't see as far as your stopping distance). You can also use other vehicles headlights to see the road ahead.

Do not use tinted or colored visors or lenses at night, and be particularly careful that your visor does not have scratches or smudges.

## Group Riding

Ride single file only. Never share lanes, even with a motorcycle.

When riding with motorcycles, maintain proper following distance from the motorcycle in front of you, even if they are riding to one side of the

FOR APPROVAL ONLY

lane. In curves, do not try to follow the path of motorcycles. Motorcycles can move farther to the edges of the lane in curves — if you follow them exactly, your front wheel can leave the lane. Motorcycles may be able to take curves faster than the Spyder roadster. Do not try to match their speed.

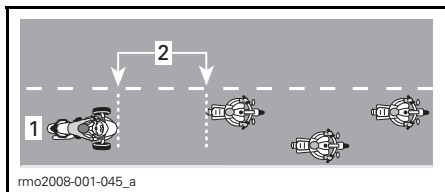

### GROUP RIDING POSITION

1. Center of lane
2. Distance of 2 seconds

Particularly on curvy roads, Spyder roadster riders might become tired sooner than motorcyclists. Do not push yourself to keep up with motorcyclists; stop if you are tired.

## Road Conditions and Hazards

### Ice, Snow and Slush

Do not ride on ice, snow or slush. Even with VSS, there will not be enough traction to maintain control on these slippery surfaces. The Spyder roadster is more likely than a car to spin out of control in slippery surfaces.

### Gravel, Dirt and Sand

On gravel, dirt, or sand-covered roads, use extra caution and reduce your speed, particularly for curves. These surfaces do not provide as much traction as paved surfaces and you can lose control, even with VSS.

### Wet Pavement and Puddles

There is normally enough traction to maintain control on pavement that is moist or wet, as long as there is not a layer of water on top of the pavement (like a puddle or flowing water on

the road). As with other vehicles, the Spyder roadster can hydroplane if you drive too fast over water that has accumulated on the road, but hydroplaning occurs at lower speeds than with most cars or motorcycles. You are more likely to hydroplane in deeper water. Watch for splashing or spraying when other vehicles go through water as an indicator of depth.

When hydroplaning occurs, one or more wheels rise up on a layer of water, losing contact with the road. If this happens to the rear wheel, you may feel it slide sideways. Hydroplaning wheels do not have the traction necessary to control the vehicle. You can lose control and spin out, and the VSS cannot keep you in control.

Avoid large water puddles or water streams, and slow down or pull off the road during heavy rains. If you must pass through water, slow down as much as possible before you reach it.

After passing through water, test your brakes. Apply them several times if necessary to let friction dry the brake pads.

Properly maintained tires reduce the risk of hydroplaning. Always maintain recommended tire pressure:

Refer to *SPECIFICATIONS* section for proper pressure.

**NOTE:** The pressure difference between the left and right side tire should not exceed 3.4 kPa (.5 PSI).

Immediately replace any tire that shows the maximum tread wear indicator to minimize risk of hydroplaning.

The middle of a lane can be particularly slick in the first few minutes of rain, as oil and dirt combine with the water. After more rain, water can accumulate in ruts in worn pavement. Avoid both of these low traction areas. When possible, keep your front tires in areas with the best traction.

## Off-Road Use

Do not use the Spyder roadster off road. The vehicle cannot handle the rough, low-traction, uneven surfaces that you may encounter in off-road riding. You could easily get stuck, lose control or roll over. Also, it may be illegal for off-road use in certain areas.

## Obstacles, Holes and Bumps

Whenever possible, avoid riding over obstacles, holes and bumps. If you must ride over them, slow down as much as possible before you get there, then release the brake as you go over. For wide obstacles or bumps, approach straight on if possible, so that both front tires go over at the same time. When going over an obstacle, bump or hole with both front wheels, riders should stand up slightly on the pegs and use legs to absorb the shock. Be prepared for the rear wheel to strike the obstacle. For narrower obstacles, bumps or holes, it is better to ride over it with the rear tire. If you ride over them with a front tire, maintain a firm grip on the handlebar, take care not to accidentally applying the throttle and be prepared to correct your trajectory if necessary.

If you strike a large enough obstacle, bump or hole, the impact can make the vehicle jump and strike you, eject riders, make you lose control, spin or roll over.

If you can't come to a complete stop in time to avoid an obstacle, you can swerve to avoid it. You can swerve and brake at the same time if necessary.

If you encounter a large animal in the road, like a deer, it is best to stop before reaching it and wait until the animal leaves, or go past slowly. If a dog chases you, a good strategy is to slow down and downshift as the dog approaches, then accelerate away as you get closer to where the dog would intercept you.

## On-Road Emergencies

A vehicle malfunction or an unexpected situation can occur any time during a ride. A well-maintained vehicle can help reduce the risk of malfunction, but you should still be prepared for an emergency.

- Always have the Operator's Guide and tool kit in the vehicle.
- When stopping on the road, follow these precautions:
  - If the road has paved shoulders, signal your intention to pull off the highway, pull off at near traffic speed, then slow down to a complete stop.
  - If the shoulder is unpaved, signal a right turn and slow down to a safe speed before pulling off the paved roadway.
  - To increase your visibility, turn on the hazard warning lights.
- If you have cellular phone or other communication device, fully charge it before long rides.
- If you are involved in an accident, BRP strongly recommends that you have your vehicle transported (see *TRANSPORTING THE VEHICLE*) to the nearest Can-Am roadster dealer to have it thoroughly inspected for safety before riding again.
- Fill in the BRP accident/incident report.

## **Tire Failure**

If a tire failure or a blowout suddenly occurs, firmly grip the handlebar, gradually slow down and carefully steer to a safe place to stop. Avoid hard braking, downshifting, or sharp steering. If a front tire fails, the vehicle may tend to pull in the direction of the failed tire, so you will need to maintain a firm grip on the handlebar to control your direction. Refer to *ROAD SIDE REPAIRS* section for instructions on tire repair.

**FOR APPROVAL ONLY**



# CARRYING A PASSENGER OR CARGO

## Weight Limits

Do not exceed the weight limits for riders and cargo.

WEIGHT LIMITS		
Vehicle load limit (including operator, passenger, cargo and added accessories)	All models except F3 Limited models	199 kg (438 lb)
	F3 Limited models	209 kg (460.8 lb)
Front storage compartment		6.8 kg (15 lb)
Each saddlebag		6.8 kg (15 lb)
Top Storage Compartment		6.8 kg (15 lb)

FOR APPROVAL ONLY

Excess weight will:

- Reduce your ability to accelerate, brake and turn.
- Reduce the effectiveness of the VSS.
- Increase the risk of rolling over if the weight is high or toward the rear.
- Reduce ground clearance, increasing the risk of striking low obstacles or uneven road surfaces.
- Increase the risk of tire failure.

## Operating with Extra Weight

Carrying a passenger or heavy cargo affects the way the vehicle handles because of the greater weight, and because the weight distribution will be different.

1. You will not be able to accelerate as quickly. Allow more time and space for passing.

2. You will not be able to stop as quickly. Use a longer following distance from the vehicle in front of you, at least three seconds. Use an even longer distance if riding conditions are not ideal (e.g., low visibility, poor road surface).
3. You will not be able to turn as sharply or at as high a speed. Slow down more than usual before turning and avoid sharp turns.
4. The Spyder roadster may be less stable. There is a greater risk of tipping or rolling during extreme maneuvers with weight that is higher or farther to the rear (like a passenger).

**NOTE:** VSS effectiveness is decreased when operating above maximum allowed load.

## Carrying a Passenger

The Spyder roadster is designed for only one passenger, seated behind the operator. Never carry multiple passengers.

Do not carry a passenger until you have experience riding alone in a variety of conditions and can proficiently handle the vehicle.

The passenger must be sober, alert, able to reach the passenger footrests and handholds, maintain balance and hold on in sudden maneuvers, and not distract the operator.

### WARNING

**Never carry a passenger if passenger handles are not installed on vehicle.**

Be sure the passenger is wearing appropriate protective gear. The passenger should wear all of the protective gear recommended for the operator, particularly a helmet. A full-face helmet is recommended; in a sudden stop, the passenger's face can strike the back of the operator's helmet.

Keep the brakes applied and the transmission in neutral until the passenger is in riding position.

Instruct the passenger on how to ride before starting out. Have the passenger follow these rules:

1. Maintain proper riding position. Hold the passenger handholds and keep feet on the passenger footrests at all times, even with the accessory backrest. The passenger should not hold on to the operator as the operator may not be able to withstand the lateral force generated by both. Different gripping positions on the handholds may be more comfortable for different maneuvers. (e.g., one hand at the front corner of and one hand at the opposite back corner for turns, both hands further forward or back for other situations).

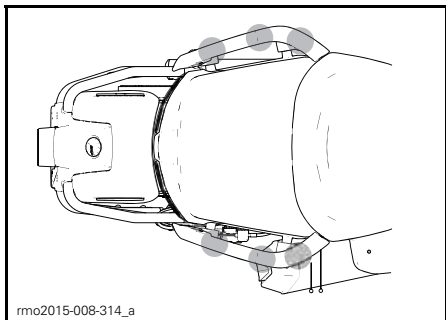

**DIFFERENT GRIPPING POSITIONS ON THE HANDHOLDS**

**NOTICE** Never use handholds to tie down, lift or transport vehicle.

2. Stay clear of the exhaust pipe, the rear wheel and the drive belt.
3. Avoid turning around or leaning except to keep balance in a turn. In an unexpected maneuver, a passenger who is not in the normal riding position is more likely to fall off.
4. Watch the road and respond to upcoming road conditions. Lean into curves as needed to resist any side-

ways force. When crossing an obstacle, hole or bump, rise slightly off the seat without locking your elbows.

Avoid abrupt acceleration, braking and turns, especially with inexperienced passengers. Sudden, unexpected maneuvers can make the passenger fall off.

## Where to Store Cargo

You can carry cargo in the front storage compartment, glove box and rear saddlebags. Do not carry cargo in any other location unless the vehicle is equipped with approved BRP accessories.

**⚠ WARNING**

Never tie down cargo onto passenger seat, as this will depress the PRS (Pillion Rider Switch). This effectively changes the VSS calibration to the 2-up calibration, so the VSS interventions might be more intrusive and stronger than expected if the driver is alone with only cargo on the passenger seat.

## Storage Compartment

The front storage compartment and rear saddlebags have room to store light objects. Do not put more than 6.8 kg (15 lb) in each storage compartment, even if the items fit. Never store flammable items, such as fuel, in the front storage compartment.

Make sure the front storage compartment latch and saddlebags covers are secure before riding.

## No Towing (F3 Base and F3-S Models)

Do not tow anything with the vehicle. The VSS will not be effective, and you will be more likely to lose control.

**FOR APPROVAL ONLY**

## Towing a Trailer (F3 Limited and F3-T Models)

Use only a BRP trailer designed specifically for the F3 series or a BRP approved equivalent. This is important to ensure the trailer and the roadster remain stable during normal operation and it does not interfere with the vehicle stability system.

**NOTICE** The use of a non-recommended wiring harness may lead to vehicle electrical system failure.

### WARNING

The use of any other trailer could damage the vehicle or interfere with the proper operation of the vehicle stability system. It is not recommended to use the cruise control when towing a trailer.

Towing a trailer affects the way the vehicle handles due to the greater weight and the different weight distribution.

- Allow more time and space for passing.
- Allow a greater distance for braking.
- Use a longer following distance from the vehicle in front of you.
- Reduce your speed and slow down more than usual before turning and avoid sharp turns.
- There is a greater risk of tipping or rolling during extreme maneuvers.

Crosswinds and air turbulence caused when crossing or being passed by others can disrupt the steering and make the trailer to sway. To minimize the effect, keep a constant speed and do not make quick steering or braking corrections.

Reduce your speed before entering in a curve.

When cornering, achieve the turn on a larger radius. It takes more space to turn with a trailer.

Try to anticipate the riding ahead to avoid having to backup with a trailer.

Always move slowly when backing up. Ask someone to guide you when possible. Practice in an open area at the first opportunity. Refer to *REQUIRED RIDING SKILLS AND PRACTICE EXERCISES*.

When possible, avoid swerving, twist and turns, sharp and abrupt turns as well as sudden braking. This could cause the trailer to jackknife or to turn over. It is easier to unstabilize an empty trailer. When accelerating, it is normal to shift at a higher RPM to avoid loading excessively the engine.

**NOTICE** Avoid spinning the rear wheel. Rocks or pebbles could be projected on the trailer and damage it.

FOR APPROVAL ONLY

---

# KNOWLEDGE SELF-TEST

The following provides a sample of information that you should have learned by reading this guide. It does not include all of the important information, but should give you an idea of whether you have a general understanding of the vehicle and its operation.

See the *ANSWERS* on the page following the questionnaire.

## Questionnaire

1. If you need to stop quickly, press both the brake pedal and the parking brake.  
True                      False
2. A pre-ride inspection should be performed once a week.  
True                      False
3. VSS allows you to use the vehicle in any kind of weather.  
True                      False
4. You should only replace the tires with those approved by BRP obtained from an authorized Can-Am roadster dealer.  
True                      False
5. It is important for the passenger to be alert and sober.  
True                      False
6. Name six items of protective gear that can reduce your risk of injury.  
1) \_\_\_\_\_  
2) \_\_\_\_\_  
3) \_\_\_\_\_  
4) \_\_\_\_\_  
5) \_\_\_\_\_  
6) \_\_\_\_\_
7. Protective gear is important for preventing and reducing injuries, keeping you comfortable, and providing protection against the elements.  
True                      False
8. Which of the following is not one of the vehicle driving controls?
  - a. Handlebar
  - b. Twist throttle
  - c. Front brake lever
9. You should leave your low beam lights on during the day for added visibility.  
True                      False
10. You should normally position the vehicle in the center of the lane.  
True                      False
11. Unlike a typical motorcycle, you should make it common practice to brake and turn at the same time.  
True                      False

**FOR APPROVAL ONLY**

**FOR APPROVAL ONLY**

12. Under normal conditions, following distance should be at least \_\_\_\_\_.

- a. 1 second
- b. 2 seconds
- c. 3 seconds

13. You should not store flammable liquids such as gasoline in the front storage compartment, even if they are in approved containers.

True False

14. List 5 ways of being more noticeable to other drivers.

- 1) \_\_\_\_\_
- 2) \_\_\_\_\_
- 3) \_\_\_\_\_
- 4) \_\_\_\_\_
- 5) \_\_\_\_\_

15. When braking on surfaces with less than ideal traction, you should pump the brakes to help maintain control of the vehicle.

True False

16. The vehicle's maximum load including riders, cargo and accessories is 199 kg (438 lb).

True False

17. The vehicle can safely tow a trailer as long as the total towed weight does not exceed 200 kg (441 lb).

True False

18. A passenger should hold onto the operator.

True False

19. Riding the Spyder roadster is as safe as riding in a car.

True False

20. ABS allows you to press the brake pedal hard without locking the wheels.

True False

**Answers**

1. **False**  
To stop quickly, press the brake pedal only. Never use the parking brake while the vehicle is moving.
2. **False**  
You should do a pre-ride inspection every time you ride.
3. **False**  
If there is ice, snow, slush or enough water on the road to cause hydroplaning, VSS can not help you maintain control.
4. **True**
5. **True**
6. 1) Helmet  
2) Eye and face protection  
3) Jacket with long sleeves  
4) Gloves  
5) Long pants  
6) Closed-toe footwear, preferably over the ankle.
7. **True**
8. **c. Front brake lever**  
The vehicle does not have a front brake lever.
9. **False**  
You should use your high beams during the day.
10. **True**
11. **False**  
You can brake and turn at the same time if you need to, but generally it is better to brake before the turn.
12. **b. 2 seconds**  
Under normal conditions, following distance should be at least two seconds.
13. **True**
14. 1) Make sure your lights and reflectors are clean.  
2) Use your high beams whenever possible.  
3) Use your turn signals.  
4) Flash your brake lights before slowing.  
5) Use your emergency flashers as needed.  
6) Use your horn to alert others of your presence.  
7) Avoid riding in blind spots.  
8) Wear bright colors and reflective clothing.
15. **False**  
You should press and hold the brake pedal, not pump. The vehicle is equipped with ABS, which keeps the wheels from locking.  
  
F3 Base Models: True  
F3-S Models: True  
F3-T Models: True  
F3 Limited Models: False
16. **False**  
  
F3 Base Models; You should never tow a trailer with the vehicle.  
F3-S Models: You should never tow a trailer with the vehicle.  
F3-T Models: You can tow a trailer with the vehicle as long as all the recommendations are strictly followed.  
F3 Limited Models: You can tow a trailer with the vehicle as long as all the recommendations are strictly followed.
17. **False**  
  
F3 Base Models: True  
F3-S Models: True  
F3-T Models: True  
F3 Limited Models: False

**FOR APPROVAL ONLY**

18. **False**  
The passenger should always hold on to the handholds.
19. **False**  
In cars and trucks, the structure of the vehicle provides protection. In addition, passengers can protect themselves by wearing seat belts. You should expect that riding the Spyder roadster is much riskier than riding in a car and that the risk of injury is more like the risk of injury when riding a motorcycle.
20. **True**

**FOR APPROVAL ONLY**

---

# SAFETY INFORMATION ON THE VEHICLE

This vehicle comes with a hang tag and labels containing important safety information.

Any person who rides this vehicle should read and understand this information on the vehicle before riding.

## Hang Tag

 **WARNING.** Operating, servicing and maintaining a passenger Vehicle can expose you to chemicals including engine exhaust, carbon monoxide, phthalates, and lead, which are known to the State of California to cause cancer and birth defects or other reproductive harm.

To minimize exposure, avoid breathing exhaust, do not idle the engine except as necessary, service your vehicle in a well-ventilated area and wear gloves or wash your hands frequently when servicing your vehicle.

For more information go to [www.P65Warnings.ca.gov/products/passenger-vehicle](http://www.P65Warnings.ca.gov/products/passenger-vehicle)



704906973

EN-704906973-DEC

FOR APPROVAL ONLY



## Safety Card

The Safety Card is found under the LH lateral service cover. Remove LH lateral service cover and make sure to secure service cover back in place before riding.

Use the Safety Card to review key information and when you are teaching new operators and passengers how to ride the vehicle. It also includes frequently referenced information.

**NOTE:** The following illustration used in this Operator's Guide is a general representation only. Your model may differ.

FOR APPROVAL ONLY



EN-704907102-DEC

### SAFETY CARD



TYPICAL - SAFETY CARD UNDER LH LATERAL SERVICE COVER

## Safety Labels

These labels are affixed to the vehicle for the safety of the operator, passenger (2-UP) or bystanders

The following labels are on your vehicle, and they should be considered permanent parts of the vehicle. If missing or damaged, they can be replaced free of charge. See an authorized Can-Am roadster dealer.

**NOTE:** In the event of any discrepancy between this guide and the vehicle, the safety labels on the vehicle have precedence over the labels in this guide.

### Label 1

**TIRE AND LOADING INFORMATION/  
RENSEIGNEMENTS SUR LES PNEUS ET LE CHARGEMENT**

**THIS VEHICLE IS EQUIPPED WITH TUBELESS TIRES/  
CE VÉHICULE EST ÉQUIPÉ DE PNEUS SANS CHAMBRE À AIR**

SEATING CAPACITY / NOMBRE DE PLACES	TOTAL	2	FRONT AVANT	1	REAR ARRIÈRE	1	
THE COMBINED WEIGHT OF OCCUPANTS AND CARGO SHOULD NEVER EXCEED LE POIDS TOTAL DES OCCUPANTS ET DU CHARGEMENT NE DOIT JAMAIS DÉPASSER							
					199 Kg 199 Kg	OR OU	438 lb 438 lb

READ OPERATORS GUIDE/ VOIR GUIDE DU CONDUCTEUR	TIRE/PNEU	SIZE/ DIMENSION	COLD TIRE PRESSURE/ PRESSION DES PNEUS À FROID	TIRE BRAND MARQUE DE PNEU	RIM SIZE/ DIMENSION DE LA JANTE
FRONT/AVANT	MC165/55R15 55H	103 ± 14 kPa / 15 ± 2 psi (1.03± 0.14 bar)	KENDA KR31	381 x 127mm (15 x 5in)	
REAR/ARRIÈRE	MC225/50R15 76H	193 ± 14 kPa / 28 ± 2 psi (1.93± 0.14 bar)	KENDA KR21	381 x 178mm (15 x 7in)	
SPARE/ PNEU DE SECOURS	NONE/AUCUN	NONE/AUCUN	NONE/AUCUN	NONE/AUCUN	

704905092A

704905092

ALL MODELS EXCEPT F3 LIMITED MODELS

**TIRE AND LOADING INFORMATION/  
RENSEIGNEMENTS SUR LES PNEUS ET LE CHARGEMENT**

**THIS VEHICLE IS EQUIPPED WITH TUBELESS TIRES/  
CE VÉHICULE EST ÉQUIPÉ DE PNEUS SANS CHAMBRE À AIR**

SEATING CAPACITY / NOMBRE DE PLACES	TOTAL	2	FRONT AVANT	1	REAR ARRIÈRE	1	
THE COMBINED WEIGHT OF OCCUPANTS AND CARGO SHOULD NEVER EXCEED LE POIDS TOTAL DES OCCUPANTS ET DU CHARGEMENT NE DOIT JAMAIS DÉPASSER							
					209 Kg 209 Kg	OR OU	460 lb 460 lb

READ OPERATORS GUIDE/ VOIR GUIDE DU CONDUCTEUR	TIRE/PNEU	SIZE/ DIMENSION	COLD TIRE PRESSURE/ PRESSION DES PNEUS À FROID	TIRE BRAND MARQUE DE PNEU	RIM SIZE/ DIMENSION DE LA JANTE
FRONT/AVANT	MC165/55R15 55H	103 ± 14 kPa / 15 ± 2 psi (1.03± 0.14 bar)	KENDA KR31	381 x 127mm (15 x 5in)	
REAR/ARRIÈRE	MC225/50R15 76H	193 ± 14 kPa / 28 ± 2 psi (1.93± 0.14 bar)	KENDA KR21	381 x 178mm (15 x 7in)	
SPARE/ PNEU DE SECOURS	NONE/AUCUN	NONE/AUCUN	NONE/AUCUN	NONE/AUCUN	

704906765

en\_704906765\_DEC

F3 LIMITED MODELS

FOR APPROVAL ONLY

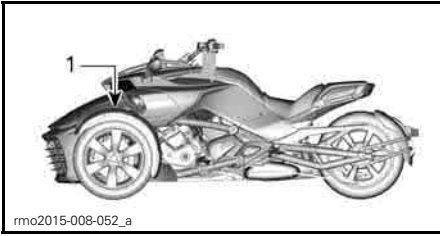
**TYPICAL**

1. Label is located on the LH side front panel under storage cover

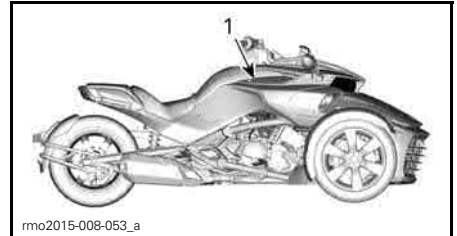
**TYPICAL**

1. Label is located under RH lateral service cover

**Label 2****⚠ WARNING**

To reduce the risks of severe injury or death.

- Never carry a passenger without lateral handgrips fixed on vehicle.
  - Passenger should always hold handholds while riding.
- 6121

EN-704906121-Dec

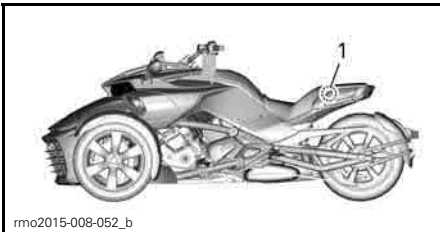
**Label 4****COOLANT RESERVOIR CAP****TYPICAL**

1. Label is located under passenger seat

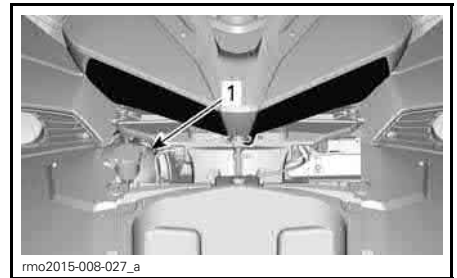

1. Label 5 located underneath front service cover

**Label 3****⚠ CAUTION**

ENGINE OIL AND CERTAIN COMPONENTS IN THE ENGINE COMPARTMENT MAY BE HOT.  
DIRECT CONTACT MAY RESULT IN SKIN BURNS.

**Checking Engine Oil Level:**

- **Make sure engine is at operating temperature.**

- For procedure refer to the operator's guide.
- Ride at least 15 km (9 miles).
- Can-Am Spyder must be on a level surface.
- Let engine idle for 10 minutes.
- Stop engine.
- Take measurement within 2 minutes after the engine stop.
- Dipstick must be screwed in completely before checking oil level.
- Use XPS synthetic blend oil summer grade or equivalent motorcycle oil.

704904924

704904924

**Label 5**

**⚠ WARNING**

Clean filler cap before removing.  
Use only DOT 4 brake fluid from  
a sealed container.

704903119

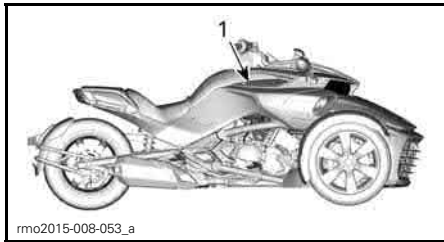

**TYPICAL**

1. Label 6 is located under RH lateral service cover

**Label 6**

**⚠ WARNING**

To reduce the risks of severe injury or death.

- Never carry a passenger without lateral handgrips fixed on vehicle.
- Passenger should always hold handholds while riding.

6121

EN-704906121-Dec



1. Label 7 is attached to tether cord, under passenger seat

**Label 7**

**NOTICE**

- Matt finish paint needs special care to maintain its appearance. See operator's guide
- PVD chrome wheel should be washed with water and a mild soap. Do not polish, use acid based or abrasive chrome cleaner on the PVD chrome wheel.
- Do not clean windshield with alkaline or acid cleaner, gasoline or solvent to avoid windshield damage. See operator's guide.

704904936A

704904936

LOCATED UNDER STORAGE COVER

**FOR APPROVAL ONLY**

Label 8

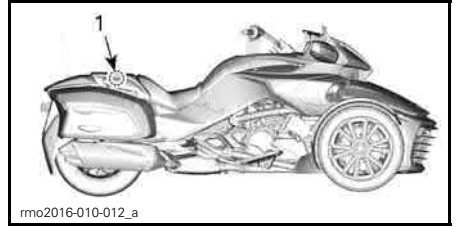

TYPICAL  
1. Label located under passenger seat

Label 10

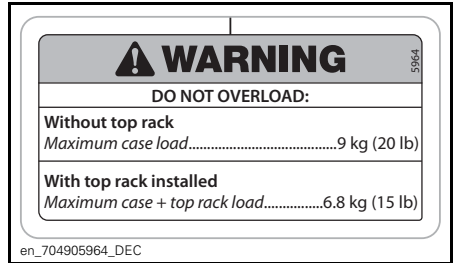

F3 LIMITED MODELS

FOR APPROVAL ONLY

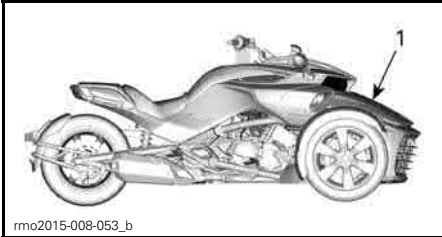

TYPICAL - ALL MODELS EXCEPT F3 LIMITED AND F3-T MODELS

1. Label is located in basket

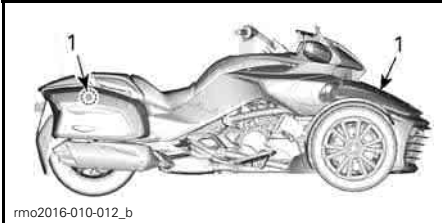

TYPICAL - F3 LIMITED AND F3-T MODELS

1. Label is located in basket and in each saddlebag

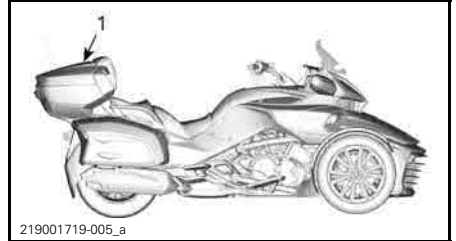

1. Label located under top storage cover

Label 9

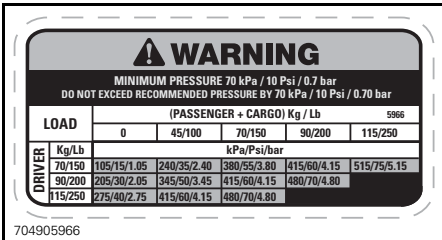

F3 LIMITED AND F3-T MODELS

**Label 11**



**F3 LIMITED MODELS**

**Label 13**

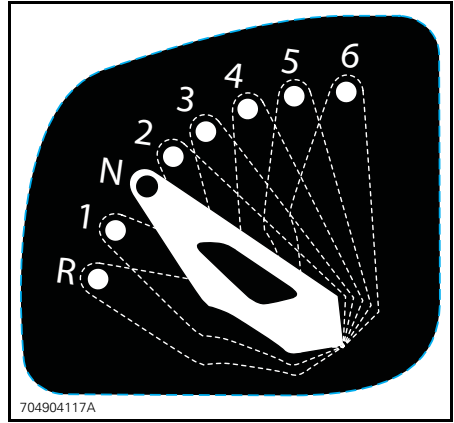

**JAPANESE MODELS - INSTALLED BY DEALER**

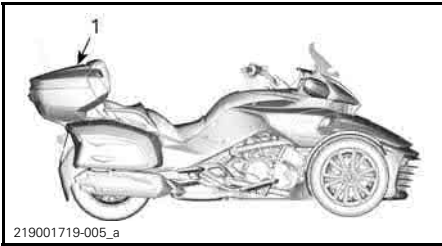

1. Label located in the top storage

**Label 12**

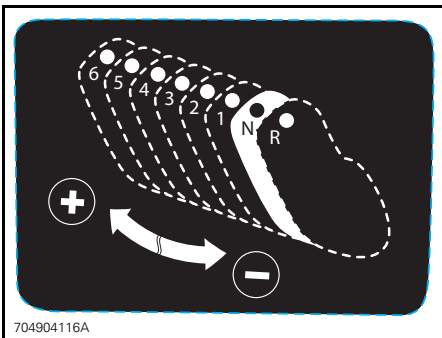

**JAPANESE MODELS - INSTALLED BY DEALER**

**FOR APPROVAL ONLY**

---

## REPORTING SAFETY DEFECTS

Your safety is very important to Bombardier Recreational Products Inc. (BRP). If you have any concerns you should immediately contact BRP customer service.

In the USA, if you believe that your vehicle has a defect which could cause a crash or could cause injury or death, you should immediately inform the National Highway Traffic Safety Administration (NHTSA) in addition to notifying Bombardier Recreational Products Inc.

If NHTSA receives similar complaints, it may open an investigation, and if it finds that a safety defect exists in a group of vehicles, it may order a recall and remedy campaign. However, NHTSA cannot become involved in any individual problems between you, your dealer or Bombardier Recreational Products Inc.

To contact NHTSA you may either call the Vehicle Safety Hotline toll-free at 888-327-4236 (TTY: 1 800-424-9153) or go to our website: [www.safercar.gov](http://www.safercar.gov) or write to:

Administrator  
NHTSA  
400 7<sup>th</sup> Street SW  
Washington, DC 20590

You can also obtain other information about motor vehicle safety from the the website [www.safercar.gov](http://www.safercar.gov).

**FOR APPROVAL ONLY**

*This page is  
intentionally blank*

**FOR APPROVAL ONLY**



***PRE-RIDE  
INSPECTION***

# PRE-RIDE CHECKLIST

We encourage you to have an Annual Safety Inspection of your vehicle. Please contact an authorized BRP dealer for further details. Though not required, it is recommended that an authorized BRP dealer performs the preseason preparation of your vehicle. Each visit to your authorized BRP dealer is a great opportunity for your dealer to verify if your vehicle is included in any safety campaign. We also urge you to visit your authorized BRP dealer in a timely manner if you become aware of any safety related campaigns.

## WARNING

Perform a pre-ride inspection before each ride to detect potential problems during operation. The pre-ride inspection can help you monitor wear and deterioration before they become a problem. Correct any problems that you discover to reduce the risk of a breakdown or crash. See an authorized Can-Am roadster dealer as necessary.

Always lock lateral service covers back in position.

Always lock lateral service covers back in position.

## Before Starting the Vehicle, Inspect the Following:

ITEM	PROCEDURE	
TIRES	Look for damage. Inspect inflation and tread wear. Refer to <i>MAINTENANCE PROCEDURES</i> .	
WHEELS AND LUG NUTS	Look for damage. Twist each front wheel lug nut by hand to be sure it is not loose. Be sure the rear wheel axle nut is in place.	
DRIVE BELT	Look for fraying, cuts, punctures and missing teeth. Verify alignment. For additional information, refer to <i>MAINTENANCE PROCEDURES</i>	
LEAKS	Look under the vehicle for any leaks.	
ALL STORAGE COMPARTMENT COVERS	Pull to check that it is properly latched.	
MIRRORS	Clean and adjust: (see <i>MIRRORS</i> in <i>EQUIPMENT</i> .)	
BRAKE PEDAL	Press and make sure you feel firm resistance. Pedal must fully return when released.	
THROTTLE HANDLE	Twist several times. Be sure it operates freely and returns to idle position when released.	
CLUTCH LEVER (SM6 MODEL)	Adjust to your convenience (see <i>PRIMARY CONTROLS</i> ). Squeeze to be sure it operates normally and fully returns when released.	

FOR APPROVAL ONLY

ITEM	PROCEDURE	
GEARSHIFT SELECTOR (SE6 MODEL)	Be sure gearshift selector operates normally in both directions and returns to center when released.	
WEIGHT	Ensure that total load on the vehicle (including operator, passenger, cargo and added accessories) does not exceed recommended load as indicate in the <i>TECHNICAL SPECIFICATIONS</i> section.	
PNEUMATIC SUSPENSION (F3-T MODELS)	Inspect inflation, refer to <i>BASIC PROCEDURES</i> .	

FOR APPROVAL ONLY

**Turn Ignition Key to the ON Position:**

ITEM	PROCEDURE	
MULTIFUNCTION GAUGE	Check the gauges, indicators, messages and the fuel level	
LIGHTS	Check operation of headlights, taillight, brake light, turn signals and hazard warning lights.	
HORN	Check operation.	
STEERING	Start engine and verify that steering operates freely.	
ENGINE STOP SWITCH	Check that the engine stop switch is working properly.	
PARKING BRAKE	Start engine, release parking brake and ensure brake indicator lamp is off on the multifunction gauge.	
BRAKE	Drive a short distance forward slowly then apply brake to test.	

*This page is  
intentionally blank*

**FOR APPROVAL ONLY**

**FOR APPROVAL ONLY**

# ***MAINTENANCE***

---

## MAINTENANCE SCHEDULE

Maintenance is very important for keeping your vehicle in safe operating condition. **A repair shop or person of the owner's choosing may maintain, replace, or repair** emission control devices and systems. These instructions do not require components or service by BRP or authorized Can-Am roadster dealers. Although an authorized Can-Am roadster dealer has an in-depth technical knowledge and tools to service the Can-Am roadster, the emission-related warranty is not conditioned on the use of an authorized Can-Am roadster dealer or any other establishment with which BRP has a commercial relationship. For emission-related warranty claims, BRP is limiting the diagnosis and repair of emission-related parts to the authorized Can-Am roadster dealers. For more information, please refer to the *US EPA EMISSIONS PERFORMANCE WARRANTY* contained herein. Proper maintenance is the owner's responsibility. A warranty claim may be denied if, among other things, the owner or operator caused the problem through improper maintenance or use.

You must follow the instructions for fuel requirements in the fueling section of this manual. Even if gasoline containing greater than ten volume percent ethanol is readily available, the US EPA issued a prohibition against the use of gasoline containing greater than 10 vol% ethanol that applies to this vehicle. The use of gasoline containing greater than 10 vol% ethanol with this engine may harm the emission control system.

Perform periodic checks and follow the maintenance schedule. **The maintenance schedule does not exempt the pre-ride inspection.**

Verifying fault codes, as first maintenance step, is a good practice and is highly recommended.

### **WARNING**

Failure to properly maintain the vehicle according to the maintenance schedule and procedures can make it unsafe to operate.

**FOR APPROVAL ONLY**

FOR APPROVAL ONLY

**FIRST INSPECTION - 5 000 KM (3,000 MI)**

Perform all items indicated in the *PRE-RIDE INSPECTION*.

Replace engine oil and oil filter.

Check clutch fluid level (**SM6 model only**).

Check brake fluid level.

Check reverse mechanism operation.

Check engine coolant level.

Check operation of control switches.

Check the drive belt condition and its tension.

Check tightening torque of the rear wheel axle nut.

Visually check brake pads and discs condition.

Check passenger handholds looseness.

Check footrests looseness.

Check body panels looseness.

Check operation of storage compartment latches, hinges and key barrels. Clean and lubricate if needed.

Remove front grill and clear all debris from radiator air duct.

**EVERY 1 500 KM (1,000 MI)**

Check oil level.

**EVERY 15 000 KM (9,300 MI) OR 1 YEAR (WHICHEVER COMES FIRST)**

Perform all items indicated in the *PRE-RIDE INSPECTION*.

Replace engine oil and oil filter.

Check clutch fluid level (**SM6 model only**).

Check brake fluid level. Replace every 2 years.

Check brake hoses

Check reverse mechanism operation.

Check radiator, hoses and water pump.

Check engine coolant level.

Perform a pressure test of cooling system.

Check operation of control switches and passenger switches.

**EVERY 15 000 KM (9,300 MI) OR 1 YEAR (WHICHEVER COMES FIRST)**

- Check condition of fuel hoses, fuel evaporation lines and canister.
- Check battery connections tightening.
- Check the drive belt condition and its tension
- Check and retighten exhaust pipe, clamping rings, joints, and gaskets condition.
- Check steering for abnormal play.
- Check tie-rods condition.
- Check shock absorbers for leaks or other damages.
- Check tightening torque of the rear wheel axle nut.
- Check ball joints condition.
- Check front and rear wheel bearings condition.
- Check brake pads and discs condition.
- Check passenger handholds looseness.
- Check footrests looseness.
- Check body panels looseness.
- Lubricate and check operation of storage compartment latches, hinges and key barrels.
- Remove front grill and clear all debris from radiator air duct.
- Lubricate all key barrels with two drops of XPS storage oil.

**FOR APPROVAL ONLY**

**EVERY 30 000 KM (19,000 MI)**

- Replace air filter and clean air filter housing.
- Replace clutch fluid (**SM6 model only**).

**EVERY 45 000 KM (28,000 MI)**

- Replace the fuel filter (or every 5 years).
- Replace the Hydraulic Control Module (HCM) oil filter (**SE6 model only**).
- Replace the canister pre-filter.
- Replace engine coolant (or every 5 years).
- Replace the spark plugs.
- Check front suspension arms rubber bushings.



---

# FIRST INSPECTION

We recommend that after the first 5 000 km (3,000 mi) of operation, your vehicle be inspected by an authorized Can-Am roadster dealer, repair shop, or person of your own choosing. The first maintenance is very important and must not be neglected.

**NOTE:** The first inspection is at the expense of the vehicle owner.

We recommend that this inspection be signed by the authorized Can-Am dealer, repair shop, or person of your own choosing having performed the first inspection.

**FOR APPROVAL ONLY**

---

Date of inspection

---

Signature of the Authorized Can-Am dealer, repair shop, or person

---

Name of the Authorized Can-Am dealer, repair shop, or person

# MAINTENANCE PROCEDURES

This section includes instructions for basic maintenance procedures.

## WARNING

Turn off the engine and follow these maintenance procedures when performing maintenance. If you do not follow proper maintenance procedures you can be injured by hot parts, moving parts, electricity, chemicals or other hazards.

## Wheels and Tires

### WARNING

Tires that are not the recommended type, damaged, worn down below the minimum tread wear limit indicator or improperly inflated can cause loss of control. New tires will not operate at their maximum efficiency until their break-in is completed. Braking, steering and VSS performance may be reduced, so use extra caution. Tires take about 300 km (200 mi) of riding with frequent braking to break-in. For riding with infrequent braking, allow extra time to break-in the tires.

The tires have been specifically designed for the Spyder roadster. Use only the BRP recommended radial tires, which can be ordered only from an authorized Can-Am roadster dealer.

When the rear tire is removed or replaced, perform the following:

- Check and clean the rear sprocket bearing and seal. Replace if damaged or broken.
- Check and clean the rear axle bearings. Replace if damaged or broken.
- Replace and lubricate the bearing seal of the rear axle.

- Replace and lubricate rear axle O-ring.
- Check and clean the rear axle wear sleeves. Replace if damaged or broken.

When the rear wheel is removed or replaced, perform the following:

- Replace rear axle nut.
- Replace and lubricate the bearing seal of the rear axle.
- Replace and lubricate rear axle O-ring.
- Check rubber damper condition. Replace if damaged or broken.

## Tire Pressure

Check pressure when tires are cold before using the vehicle. Tire pressure changes with the air temperature. Recheck pressure if temperature has changed (e.g., significant weather change, driving in the mountains).

COLD TIRE PRESSURE	
Front tires	103 kPa ± 14 kPa (15 PSI ± 2 PSI)
Rear tires	193 kPa ± 14 kPa (28 PSI ± 2 PSI)

NOTE: The pressure difference between the left and right side tire should not exceed 3.4 kPa (.5 PSI).

## Tire Damage

Check all tires for:

- Cuts, slits and cracks in the tires.
- Bumps or bulges in the side of the tire or the tread.
- Nails or other foreign objects in the side of the tire or tread.
- Air leaks (hissing sound) caused by an ill-fitting rim or a faulty tire valve.

If any of the above occurs, have the tire repaired or replaced as soon as possible by an authorized Can-Am roadster dealer.

FOR APPROVAL ONLY

## Tire Tread Wear

Check minimum tread depth by using the tread-wear indicators (hard rubber bars molded at the base of the tread; 1 in figure below). Check in three locations across the tire tread:

- Outer edge
- Center
- Inside edge.

The tread-wear indicators will appear across the treads that have been worn down to the minimum tread depth. When at least one tread-wear indicator appears across the tread, have the tire replaced as soon as possible by an authorized Can-Am roadster dealer.

FOR APPROVAL ONLY

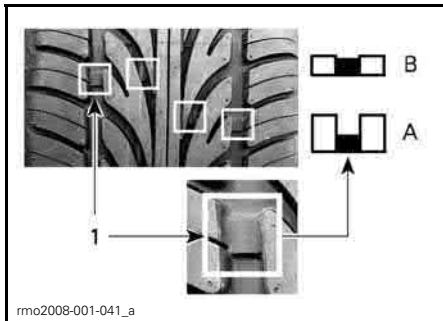

### TIRE TREAD WEAR

1. Tread-wear limit indicator
- A. Appropriate tread depth
- B. Minimum tread depth, replace tire

It is normal to see uneven wear on tires depending on how the vehicle is driven and road conditions. The front tires external or internal edges and the rear tire center tread will wear unevenly depending on if the vehicle is driven smoothly or aggressively.

**⚠ WARNING**

The tires are designed to rotate only in one direction. Do not switch the left and right front wheels. If a tire is mounted on the incorrect side, you will have less traction and could lose control.

**⚠ WARNING**

Do not hold the front wheel spoke while attempting to spin the front wheel as your fingers may be caught between the wheel and the brake caliper.

## Tire Rotation (Front)

Rotate front tires when tread depth reaches 4 mm (5/32 in). This will maximize tire life.

**⚠ WARNING**

The tires are designed to rotate only in one direction. Do not switch the left and right front wheels. The tires must be dismounted from the wheels for tire rotation. If a tire is mounted on the incorrect side, you will have less traction and could lose control.

**⚠ CAUTION** Do not hold the front wheel spoke while attempting to spin the front wheel as your fingers may be caught between the wheel and the brake caliper.

## Tire Registration Form

In the event of a tire recall, we can only contact you if we have your name and address. As a vehicle manufacturer, BRP keeps a record of the Tire Identification Number (T.I.N.) associated with the Vehicle Identification Number (V.I.N.) (see *VEHICLE IDENTIFICATION*) and its current owner information.

If you replace any tire on your vehicle, a "Tire Registration Form" must be completed and sent to the tire manufacturer consumer service group. The "Tire Registration Form" is available at an authorized Can-Am roadster dealer.

## Drive Belt

Visually inspect belt alignment and condition before each ride.

Belt alignment and deflection adjustment should always be performed by an authorized Can-Am roadster dealer according to the *MAINTENANCE SCHEDULE*.

### Drive Belt Alignment

If belt goes beyond the outside edge of sprocket, have the belt properly aligned by an authorized Can-Am roadster dealer as soon as possible.

**NOTE:** Belt must **NOT** be in contact with flange from **FRONT SPROCKET**.

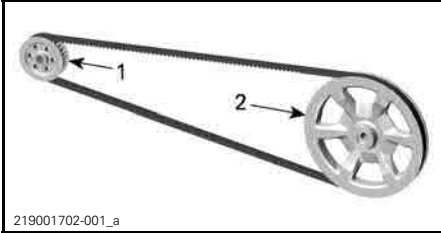

**TYPICAL**

1. Front sprocket
2. Rear sprocket

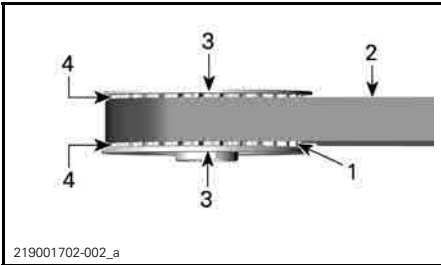

**TYPICAL - FRONT SPROCKET**

1. Front sprocket teeth
2. Belt
3. Sprocket flange
4. Gap between flange and belt

### Drive Belt Wear

Inspect the drive belt with the vehicle in neutral, engine off, on a level surface with plenty of room — you will have to roll the vehicle forward or backward to see the full length of the belt.

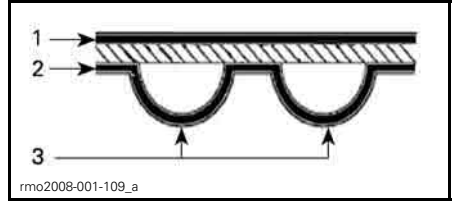

**DRIVE BELT SURFACES**



1. Outer surface
2. Teeth side surface
3. Tooth

Inspect for the following conditions:

WEAR CONDITION	REQUIRED ACTION
Good condition 	None
Hairline cracks 	Monitor condition
Minor chipping 	Monitor condition
Opened cracks 	Replace belt
Hook wear 	Replace belt
Missing teeth 	Replace belt

**FOR APPROVAL ONLY**

FOR APPROVAL ONLY

WEAR CONDITION	REQUIRED ACTION
Belt fabric worn, exposing internal components 	Replace belt
Stone damage 	Replace belt

**NOTE:** Hairline cracks do not require the replacement of the belt, but must be monitored closely — they may lead to opened cracks or missing teeth, requiring belt replacement. Damage to the center of the belt will eventually require belt replacement, but when cracks extend to the edge of the belt, belt failure is imminent.

When a drive belt is replaced, also replace the sprockets to increase the longevity of the new drive belt.

### Drive Belt Tension

While riding, if you feel vibrations in the belt or if the belt is skipping sprocket teeth, have the belt tension adjusted as soon as possible by an authorized Can-Am roadster dealer.

## Engine Oil

### Recommended Engine Oil

The same oil is used for the engine, gearbox, clutch, and the Hydraulic Control Module (HCM) on the SE6 model.

**NOTICE** Do not use engine oil which is not designed specifically for motorcycle application (wet clutch). Automotive application oils contain friction modifiers which can lead to clutch slippage.

Use the XPS 4-STROKE SYNTH. BLEND OIL (P/N 293 600 121) or a 5W40 semi-synthetic or synthetic oil

certified JASO-MA may be used as an alternative to the recommended oil. Always check the API service label on the oil container.

**NOTICE** Do not add any oil additives to the recommended oil. This may lead to gearbox and clutch malfunctions.

### Engine Oil Level Verification

In order to perform the engine oil level verification, the engine must be at normal operating temperature.

1. Take a ride of at least 15 km (9 mi).
2. Park the vehicle on a level surface.
3. Let the engine idle for 10 minutes.

**⚠ WARNING**

Exhaust gas contains poisonous carbon monoxide that can rapidly accumulate in an enclosed or poorly ventilated area. If inhaled, it can cause serious injury or death. Only run the engine in an unenclosed, well ventilated area.

**NOTICE** Adjusting the oil level on a cold engine will result in overfilling.

4. Stop engine.

**NOTE:** Engine oil level verification must be performed within 2 minutes after engine stop.

5. Remove RH lateral service cover. Refer to *BODY PANELS*.
6. Unscrew and remove the oil dipstick.

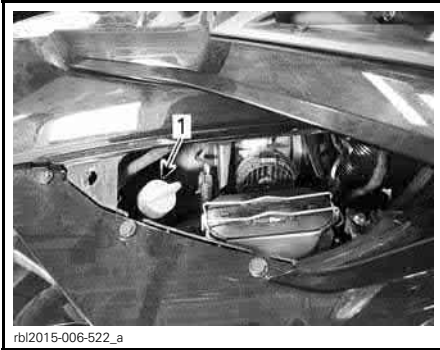

rbl2015-006-522\_a

**TYPICAL**

1. Oil dipstick
7. Wipe off the dipstick.
8. Reinsert and completely screw in the dipstick.
9. Unscrew and remove the dipstick again.
10. Check the oil level on the dipstick.

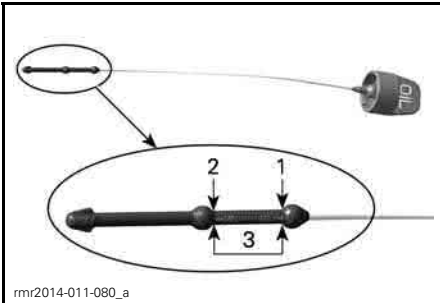

rm2014-011-080\_a

1. MAX
2. MIN
3. Operating range, 0.5 L (.5 qt (U.S. liq.))

**Oil Level between Lower (MIN) and Upper (MAX) Marks:**

1. Do not add oil.
2. Properly insert and tighten dipstick.
3. Install RH lateral service cover.

**Oil Level under MIN Mark Adjustment:**

1. Add approximately 500 ml (17 U.S. oz) of recommended oil.

**NOTE:** The oil quantity between MIN and MAX marks is 500 ml (17 U.S. oz).

2. Restart the engine and let it idle for 10 minutes.

**⚠ WARNING**

Exhaust gas contains poisonous carbon monoxide that can rapidly accumulate in an enclosed or poorly ventilated area. If inhaled, it can cause serious injury or death. Only run the engine in an unenclosed, well ventilated area.

**NOTICE** Adjusting the oil level on a cold engine will result in overfilling.

3. Stop the engine.
- NOTE:** Engine oil level verification must be performed within 2 minutes after engine stop.
4. Recheck oil level.
5. Repeat the above steps until oil level reaches the dipstick between the lower and upper marks. **Do not overfill.**
6. Properly insert and tighten dipstick.
7. Install RH lateral service cover.

**Changing the Engine Oil and Oil Filter**

1. Prior to changing the oil, ensure vehicle is on a level surface.

**NOTICE** The engine oil and the engine oil filter must be replaced at the same time. The oil change should be carried out with a warm engine.

**⚠ CAUTION** Engine oil can be very hot.

2. Remove the following RH body panels, refer to *BODY*:
  - Lateral service cover
  - Side panel

**FOR APPROVAL ONLY**

3. Clean area around drain plug under oil sump cover.
4. Place an appropriate drain pan under oil sump cover.
5. Remove the drain plug and discard the sealing washer and O-rings.

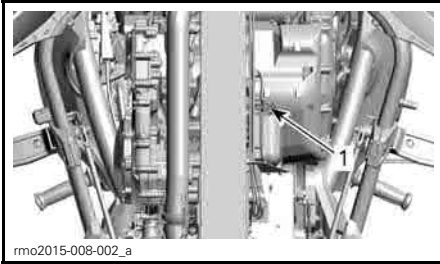

rmo2015-008-002\_a

**TYPICAL**

1. Drain plug

6. Remove the dipstick.
7. Allow sufficient time for oil to completely drain.
8. Clean area around magnetic drain plug in the clutch cover.
9. Place an appropriate drain pan under the clutch cover.
10. Remove the magnetic oil drain plug and discard the sealing ring.

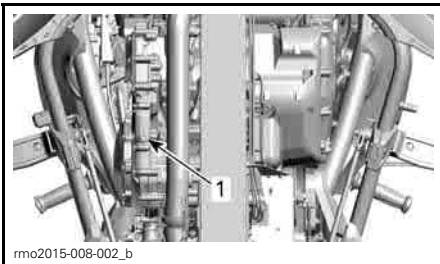

rmo2015-008-002\_b

**TYPICAL**

1. Magnetic drain plug

11. Remove oil filter cover and discard its O-rings.
12. Remove and discard oil filter.

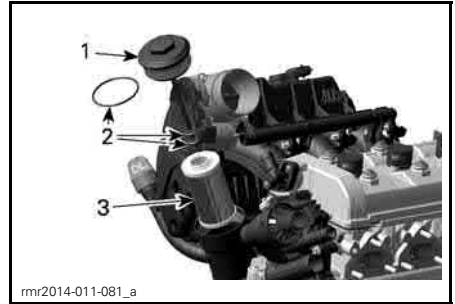

rmo2014-011-081\_a

1. Oil filter cover
2. O-rings
3. Oil filter

13. Allow sufficient time for oil to completely drain from clutch cover.
14. Check and clean oil filter cavity for dirt and contamination.
15. Clean the magnet on the magnetic drain plug.
16. Using **NEW** sealing washers and O-rings and install both drain plugs.

**NOTICE** Never reuse the drain plug sealing washers and O-rings. Always replace it with a new one.

17. Tighten drain plugs as specified.

TIGHTENING TORQUE	
Drain plug (oil sump cover)	28 N•m ± 2 N•m (21 lbf•ft ± 1 lbf•ft)

TIGHTENING TORQUE	
Magnetic drain plug (clutch cover)	20 N•m ± 2 N•m (15 lbf•ft ± 1 lbf•ft)

18. Insert **NEW** engine oil filter.
19. Install **NEW** O-rings on oil filter cover.
20. Install oil filter cover and tighten to specification.

TIGHTENING TORQUE	
Oil filter cover	25 N•m ± 3 N•m (18 lbf•ft ± 2 lbf•ft)

21. Pour following amount of the recommended oil into the oil tank.

**FOR APPROVAL ONLY**

OIL CAPACITY		
MODEL	WHEN DOING...	QUANTITY
SE6	Engine oil and engine oil filter replacement	4.7 L (5 qt (U.S. liq.))
	Engine oil, engine oil filter and HCM surface filter replacement	4.9 L (5.2 qt (U.S. liq.))
SM6	Engine oil and engine oil filter replacement	4.5 L (4.8 qt (U.S. liq.))

22. Reinsert and completely screw in the dipstick.
23. Check engine oil level. Refer to *ENGINE OIL LEVEL VERIFICATION* in this section.

**NOTICE** Ensure oil pressure warning lamp goes out within 5 seconds from engine start. If oil pressure warning lamp stays ON for more than 5 seconds, STOP ENGINE and recheck oil level.

24. Ensure engine oil filter cover, magnetic drain plug (clutch cover) and drain plug (oil sump cover) are not leaking.
25. Reinstall all removed body panels.
26. Dispose of used oil as per your local environmental regulations.

## Air Filter

### Air Filter Removal

Refer to *BODY PANELS* in *EQUIPMENT* if needed.

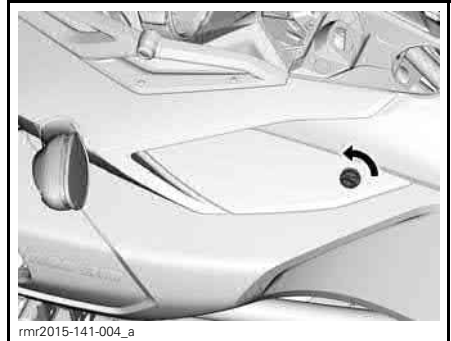

TYPICAL - SERVICE COVERS



TYPICAL

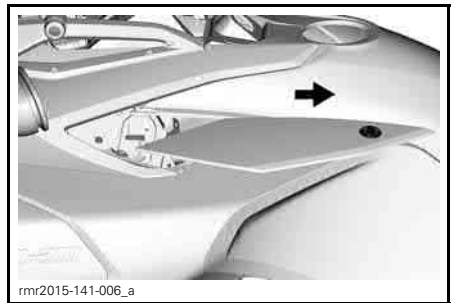

TYPICAL

FOR APPROVAL ONLY



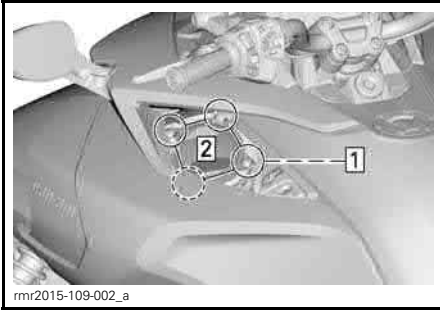

**TYPICAL**  
 Step 1: Remove all four screws  
 Step 2: Remove air filter cover

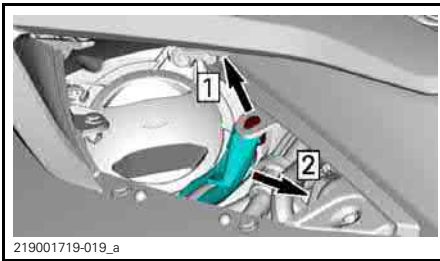

**F3-T AND F3 LIMITED MODELS**  
 1. Remove plastic rivet  
 2. Displace electrical harness

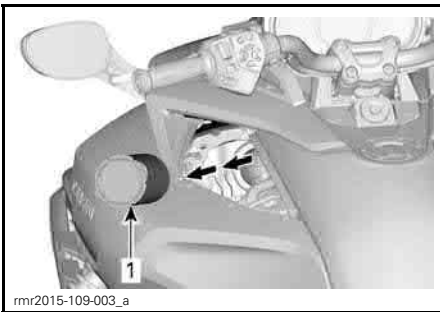

**TYPICAL - REMOVE AIR FILTER FROM AIR INTAKE SILENCER.**  
 1. Air filter

**NOTICE** Remove air filter slowly to keep dust and debris from falling into the clean area of the air intake silencer (passed air filter).

**Air Filter Inspection**

Inspect air filter for cleanliness and damage.

**NOTICE** It is not recommended to blow compressed air on the paper filter. This could damage the paper fibers and reduce its filtration ability when used in dusty environments.

**NOTICE** Do not wash the paper filter with any cleaning solution.

**NOTICE** Inspect air intake silencer and remove any dust or debris taking care not to blow or move anything inside the clean side of the engine air inlet (passed air filter).

**NOTICE** Remove any dust or debris that may have moved or shifted inside the clean side of the air intake silencer (passed air filter). Clean by pulling on the dust and not pushing it inside.

Replace air filter as necessary according to recommended maintenance schedule and particular use (especially in dusty environments).

**Air Filter Installation**

Installation is the reverse of removal however pay attention to the following:

Make sure the ring on which the air filter sits is flat and well positioned before seating the air filter.

Make sure the air filter is positioned in the correct orientation.

**NOTE:** A special area is present on the filter for writing down date and mileage at which new filter was installed.

Position air filter cover onto air intake silencer.

Tighten screws in a star pattern.

TIGHTENING TORQUE	
Air filter cover retaining screws	3 N•m ± 0.5 N•m (27 lbf•in ± 4 lbf•in)

FOR APPROVAL ONLY

## Engine Coolant

### Engine Coolant Level Verification

#### **⚠ WARNING**

When opening the reservoir, the coolant can be very hot and spray out if the engine is hot. In order to avoid getting burned, check the coolant level when the engine is cold.

The cooling system must be filled with distilled water and antifreeze solution (50% distilled water, 50% antifreeze).

For best performance, use LONG LIFE ANTIFREEZE (P/N 219 702 685) or equivalent.

With the engine cold, check the coolant level as follows:

1. Park the vehicle on a firm, level surface.
2. Open the front storage compartment.
3. Remove front service cover. Refer to *BODY*.
4. Check the coolant level on the right hand side. Coolant must be visible slightly above the COLD level mark.

**NOTE:** If engine is hot, coolant must be visible without exceeding the HOT level mark.

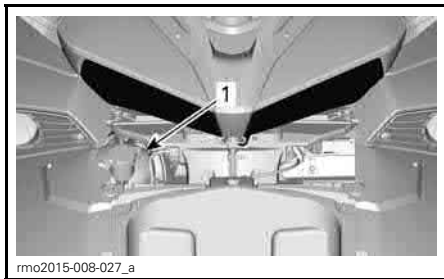

1. Coolant reservoir cap

5. If required, add coolant until it is visible in the reservoir slightly above the COLD level mark. Use a funnel to avoid spillage. Do not overfill.
6. Stop adding coolant once coolant starts to appear in the tube.

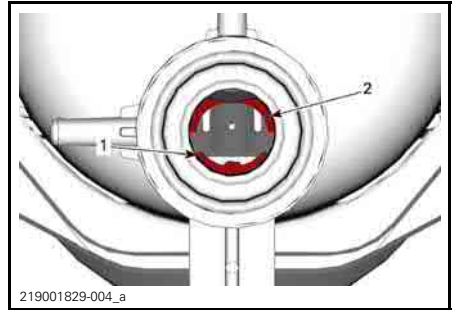

1. COLD coolant level reference line
2. HOT coolant level reference line

7. Reinstall the service cover.

**NOTE:** A coolant system that frequently requires coolant indicates leaks or engine problems. See an authorized Can-Am roadster dealer.

## Brakes

#### **⚠ WARNING**

New brakes will not operate at their maximum efficiency until their break-in is completed. Braking performance may be reduced, so use extra caution. Brakes take about 300 km (200 mi) of riding with frequent braking to break-in. For riding with infrequent braking, allow extra time to break-in the brakes.

### Brake Fluid Level Verification

Use only DOT 4 brake fluid from a sealed container.

Check the brake fluid level as follows:

1. Park the vehicle on a firm, level surface.

**FOR APPROVAL ONLY**

2. Remove RH lateral service cover. Refer to *BODY PANELS*.
3. Remove RH side panel. Refer to *BODY PANELS*.
4. Check the brake fluid level in reservoir. They should both be above the MIN. mark.

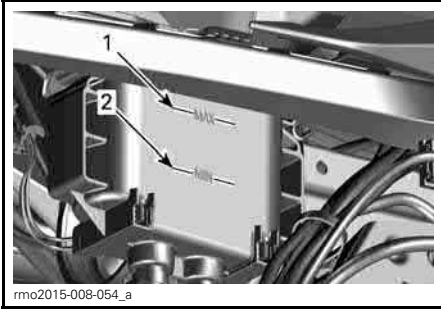

1. Brake fluid MAX. level mark
2. Brake fluid MIN. level mark

5. Add fluid as required. Refer to *ADDING BRAKE FLUID*.

**NOTE:** Low brake fluid may indicate leaks or worn brake pads. See an authorized Can-Am roadster dealer.

### Adding Brake Fluid

1. Remove the filler cap.

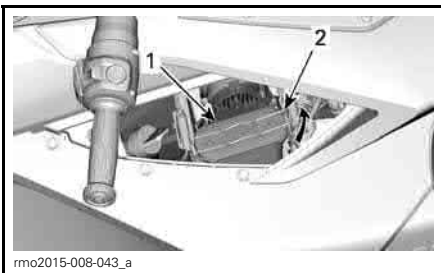

1. Filler cap
2. Filler cap locking mechanism

**⚠ WARNING**

Clean filler cap before removing. Use only DOT 4 brake fluid from a sealed container.

**NOTE:** Replacing brake pads will increase brake fluid level. If replaced when at MAX level, brake fluid spills may occur.

**NOTICE** Brake fluid can damage painted surfaces or plastic parts. Wipe up any spills.

3. Reinstall filler cap and lock in place.
4. Install RH side panel. Refer to *BODY PANELS*.
5. Install RH lateral service cover. Refer to *BODY PANELS*.

### Brake System Verification

The front and rear brakes are hydraulic disc types. These brakes are self-adjusting and do not require adjustment.

The brake pedal also requires no adjustment.

To keep brakes in good condition, check the following as per the *MAINTENANCE SCHEDULE*:

1. Entire brake system for fluid leaks
2. Brake pedal for spongy feel
3. Brake discs for excessive wear and surface condition
4. Brake pads for wear, damage or looseness.

See an authorized Can-Am roadster dealer if there are any problems with the brake system.

### Battery

#### Battery Location

The battery is located in the front storage compartment. To access the battery, open the front storage compartment.

2. Add fluid to MAX level.

**FOR APPROVAL ONLY**

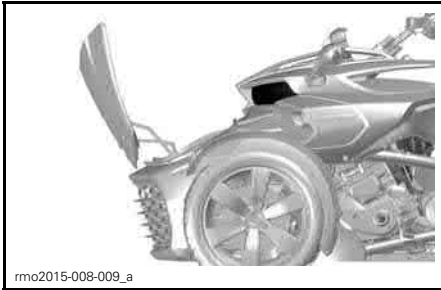

rmo2015-008-009\_a

**TYPICAL - FRONT STORAGE COMPARTMENT OPENED**

Remove basket. Refer to *BODY PANELS*.

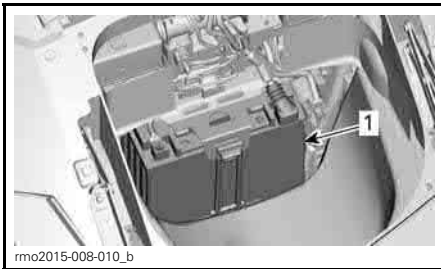

rmo2015-008-010\_b

1. Battery

**Battery Charging**

The vehicle is equipped with a maintenance-free type battery and is completely sealed; there is no need to add water to adjust the electrolyte level. The battery may need to be charged if the vehicle has not been ridden for at least one month.

Always have the battery replaced by an authorized Can-Am roadster dealer.

**⚠ WARNING**

Do not use conventional lead-acid type batteries. Acid may leak out through the battery vent of a conventional lead-acid type battery. Acid may also leak if the battery case is cracked or damaged, which can cause severe burns.

The battery can be charged while it is installed on the vehicle.

**NOTICE** Follow the instructions provided with your battery charger. Improper charging may damage the battery.

To charge the battery, proceed as follows:

1. Open the front storage compartment.
2. Remove basket. Refer to *BODY PANELS*.
3. First connect the RED (+) cable to the corresponding terminal.
4. Connect the BLACK (-) cable to the corresponding terminal.

**NOTICE** Always connect the RED (+) cable first to avoid damaging the electrical system of the vehicle.

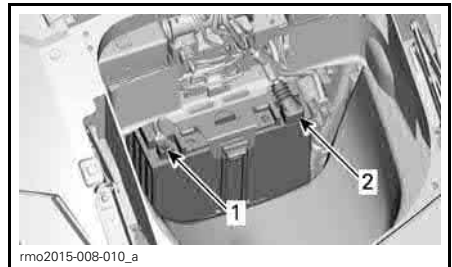

1. BLACK (-) terminal
2. RED (+) terminal

5. Start the battery charger. Charging time will depend on the charging rate.

When the battery is charged:

6. First disconnect the BLACK (-) cable.
7. Disconnect the RED (+) cable.

**NOTICE** Always disconnect the BLACK (-) cable first to avoid damaging the electrical system of the vehicle.

8. Put basket back and close front storage compartment.

**FOR APPROVAL ONLY**

A standard battery charger can be used. The recommended charge rate is 2 A. If the battery is dead, it can be jump started with a car battery (see *ROADSIDE REPAIRS* section).

For home charging, a “trickle” charger can be used to slow charge the battery. This type of charger can be left connected for a long period of time without damaging the battery. Always follow the charging time as recommended in the charger instructions.

**FOR APPROVAL ONLY**

## Clutch Fluid (SM6 Model)

### Clutch Fluid Level Verification

Check the clutch fluid level when the clutch does not operate normally or when it is difficult to shift gears with the gearshift lever.

The clutch fluid reservoir is near the reverse button on the left handlebar.

Check the clutch fluid level as follows:

1. Park the vehicle on a firm, level surface.
2. Set the handlebar straight in order to position the top of clutch fluid reservoir horizontally.
3. Wipe clean the cap area.
4. Unscrew cap retaining screws.

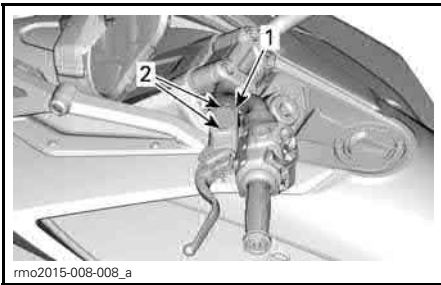

**TYPICAL**

1. Clutch fluid reservoir cap
2. Retaining screws to remove

5. Carefully remove cap. Pay attention not to drop the cap seal.

6. Look inside the reservoir to see the fluid level.

Check clutch fluid level inside the reservoir:

- The fluid must be flush to the fill level line (protuberance on the reservoir wall).



**FLUID REMOVED FOR CLARITY PURPOSE**

1. Minimum
2. Maximum

### Adding Clutch Fluid

1. If the fluid level is lower than specified, add fluid to the reservoir up to the fill level line. Use only DOT 4 brake fluid.
2. Add fluid as required. **Do not over-fill.**

**NOTICE** Immediately wipe up any spills.

3. Push back the seal located inside the cap.
4. Reinstall the cap to the reservoir.
5. Tighten cap screws.

TIGHTENING TORQUE	
Cap screws	1.35 N•m ± 0.15 N•m (12 lbf•in ± 1 lbf•in)

# Headlights

## Headlights Aiming Verification (North American Models)

1. Verify tires are correctly inflated. Refer to *SPECIFICATIONS*.
2. Position vehicle 10 m (33 ft) in front of a test surface as shown. Make sure vehicle is on leveled ground.

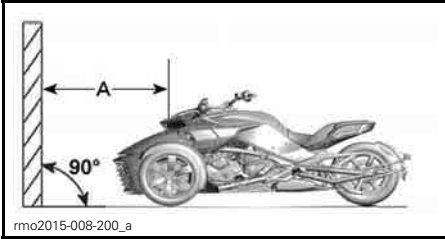

TYPICAL  
A. 10 m (33 ft)

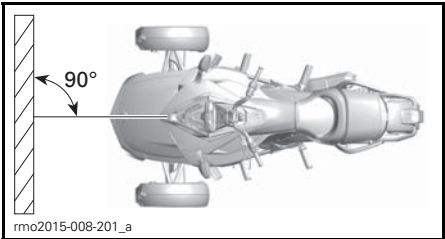

TYPICAL

3. Trace 2 lines parallel to the ground on the test surface as follows:

LINES ON THE TEST SURFACE	
Line A	644 mm (25-23/64 in) above ground
Line B	554 mm (21-13/16 in) above ground

4. Have driver take place on the driver's seat.
5. Select **low** beam.
6. Beam aiming is correct when the top line of the headlight reflection is between the marks.

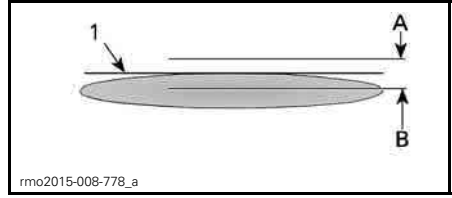

TYPICAL - HEADLIGHT REFLECTION ON TEST SURFACE (SINGLE HEADLAMP)

1. Top line
- A. Mark at 644 mm (25-23/64 in) above ground
- B. Mark at 554 mm (21-13/16 in) above ground

## Headlights Aiming Verification (European, Australian and Japanese Models)

1. Verify tires are correctly inflated. Refer to *SPECIFICATIONS*.
2. Position vehicle 10 m (33 ft) in front of a test surface as shown. Make sure vehicle is on leveled ground.

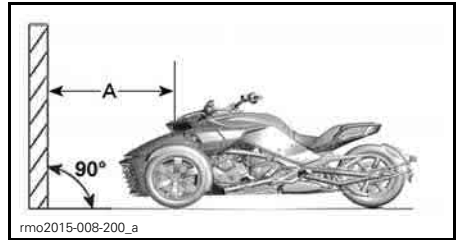

TYPICAL  
A. 10 m (33 ft)

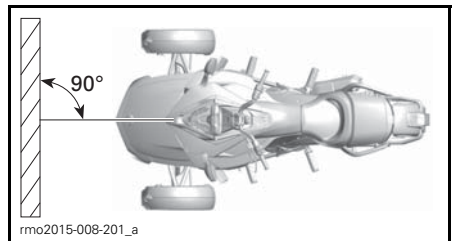

TYPICAL

3. Trace 4 lines parallel to the ground on the test surface as follows:

FOR APPROVAL ONLY

LINES ON THE TEST SURFACE	
Line A	688 mm (27-3/32 in)
Line B	618 mm (24-21/64 in)
Line C	564 mm (22-13/64 in)
Line D	514 mm (20-15/64 in)

- Have driver take place on the driver's seat.
- Select **high** beam.
- Beam aiming is correct when the focus point (brightest spot) of the headlight reflection is between the upper marks.

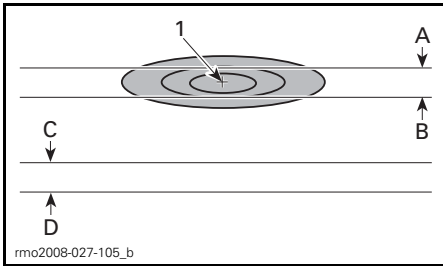

TYPICAL - HEADLIGHT REFLECTION ON TEST SURFACE — HIGH BEAM (SINGLE HEADLAMP)

- Focus point
- 688 mm (27-3/32 in) above ground
- 618 mm (24-21/64 in) above ground
- 564 mm (22-13/64 in) above ground
- 514 mm (20-15/64 in) above ground

- Select low beam.
- Beam aiming is correct when the top line of headlight reflection is between lower marks.

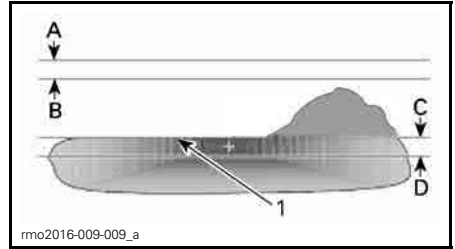

HEADLIGHT REFLECTION ON TEST SURFACE — LOW BEAM (SINGLE HEADLAMP)

- Top line
- 688 mm (27-3/32 in) above ground
- 618 mm (24-21/64 in) above ground
- 564 mm (22-13/64 in) above ground
- 514 mm (20-15/64 in) above ground

**NOTE:** For countries driving on the left, light peak should be on the left of vehicle.

### Headlights Aiming Adjustment (North American Models)

Using a 10mm wrench, adjust each headlight by turning the headlight adjuster located on the headlight housing. Turn clockwise to raise headlight and counterclockwise to lower headlight. Adjust both headlights evenly.

**NOTE:** Do not exceed a torque of 0.8 Nm.

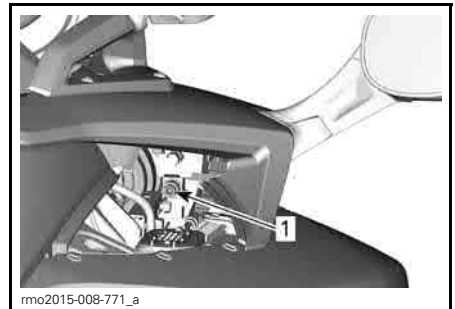

TYPICAL - RH SIDE SHOWN

- Headlight adjuster

FOR APPROVAL ONLY

## Headlights Aiming Adjustment (European, Australian and Japanese Models)

### High Beam

Using a 10mm wrench, adjust each headlight by turning the headlight adjuster located on the headlight housing. Turn clockwise to raise headlight and counterclockwise to lower headlight. Adjust both headlights evenly.

**NOTE:** Do not exceed a torque of 0.8 Nm.

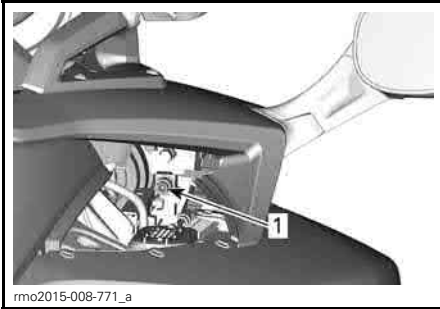

rmo2015-008-771\_a  
TYPICAL - RH SIDE SHOWN  
1. Headlight adjuster

### Low Beam

Refer to *BODY PANELS* section and remove the following.

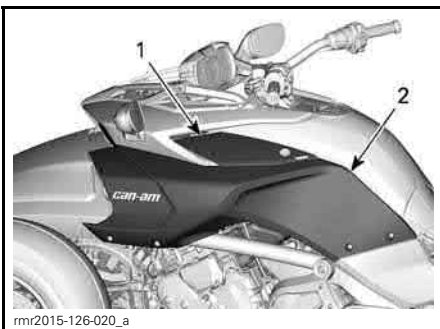

rm2015-126-020\_a  
1. Lateral service cover  
2. Side panel.

Turn adjustment screw to adjust beam height. Adjust both headlights evenly.

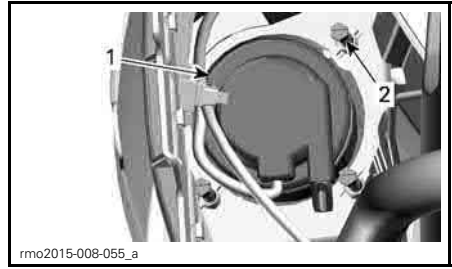

rmo2015-008-055\_a  
1. Low beam headlight  
2. Adjustment screw

### Radiator Fan Cleaning

To access radiators remove front grill from vehicle.

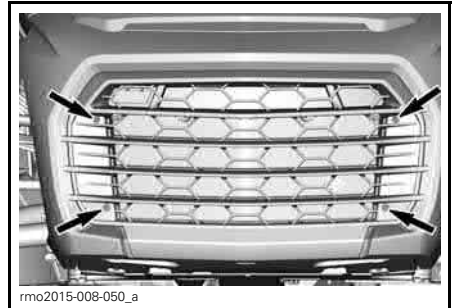

rmo2015-008-050\_a  
RETAINING SCREWS TO REMOVE

On F3-S, F3-T and F3 Limited models, unclip both snaps.

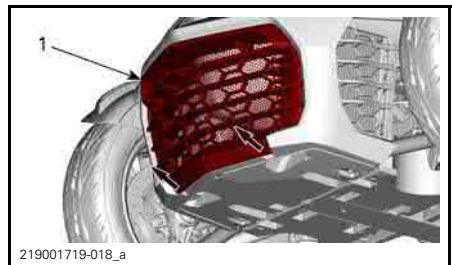

219001719-018\_a  
1. Radiator fan cleaning

Clear debris and dirt.

**NOTICE** Do not use pressure washer.

FOR APPROVAL ONLY



# VEHICLE CARE

## Vehicle Cleaning

To clean the vehicle, do not use high-pressure washers (like the ones found in car washes) as they may damage certain parts of the vehicle.

**NOTICE** PVD chrome wheel should be washed with water and a mild soap. Do not polish, use acid based or abrasive on the PVD chrome wheel.

**NOTICE** Do not clean the windshield with alkaline or acid cleaner, gasoline or solvent to avoid windshield damage.

**NOTICE** For matte finishes, do not use wax, detail spray, or other products used on regular paint. Do not wash with abrasive materials. Do not use mechanical cleaners or polishers, and do not rub the surfaces vigorously.

To clean the vehicle:

1. Rinse the vehicle thoroughly with water to remove loose dirt.
2. Using a soft, clean cloth, wash the vehicle with water mixed with a mild detergent, such as soap specially formulated for motorcycles or automobiles.

**NOTE:** Using warm water works well to remove bugs in the windshield and front panels.

**NOTE:** For matte finishes, hand-wash with a soft wash mitt and a mild cleaning product safe for matte paint. To remove foreign substances such as insects, use a soft applicator and a mild solvent. Saturate and soak area before cleaning. Rub lightly.

3. While washing the vehicle, check for grease or oil. You can use XPS ROADSTER WASH (P/N 219 701 703) or a mild automotive degreaser. Thoroughly follow the manufacturer's instructions.

4. Dry the vehicle with a chamois or a soft towel.

**NOTE:** Vehicles with a matte paint finish may require more frequent cleaning.

## Vehicle Protection

Apply non-abrasive wax to plastic parts.

**NOTICE** Do not wax or polish matte surfaces (including matte paint finishes).

SURFACE	RECOMMENDATION
Glossy paint finishes	Apply only non-abrasive wax, safe for clear coat paints
Matte paint finishes	Do not apply wax
Matte finishes	

Windshield can be polished with a plastic cleaner/polisher.

**NOTICE** Do not use water repellent products on windshield.

### WARNING

Do not apply a vinyl or plastic protector on the seats as the surface will become slippery and the operator or the passenger may slip off the vehicle.

FOR APPROVAL ONLY

---

# STORAGE AND PRESEASON PREPARATION

## Storage

If the vehicle will not be ridden for at least four months, such as during the winter, proper storage is necessary to keep the vehicle in good condition.

BRP recommends you have your authorized Can-Am roadster dealer, repair shop, or person of your own choosing fully prepare your vehicle for storage. Or, at your convenience, you can follow the basic procedures below.

### To Prepare the Vehicle for Storage:

1. Inspect vehicle and have your authorized Can-Am roadster dealer, repair shop, or person of your own choosing for maintenance, repair, or replacement if necessary. Please refer to the US EPA EMISSION PERFORMANCE WARRANTY contained herein for information about warranty claims.
2. Change the engine oil and filter. Seek service from an authorized Can-Am roadster dealer, repair shop, or person of your own choosing for maintenance, repair, or replacement.
3. Check engine coolant, brake fluid and clutch fluid levels.
4. Fill the fuel tank, add fuel stabilizer and run the engine to prevent the tank from rusting and the fuel from deteriorating. Strictly follow instructions on fuel stabilizer container.
5. Inflate all tires to their recommended pressure.
6. Clean the vehicle.
7. Lubricate all control cables, latches, key barrels, and pivoting points of all levers.
8. Close and latch all storage compartments.
9. Cover the vehicle with a permeable materials (e.g., tarpaulin). Avoid using plastic or similar non-breathing, coated materials that restrict air flow and allow heat and moisture to accumulate.

10. Store the vehicle in a dry area, away from sunlight, with a small amount of daily temperature variation.
11. Slow charge the battery once a month at the recommended charging rate of 2 A. It is not necessary to remove the battery.

## Preseason Preparation

After a storage period, vehicle must be prepared and inspected.

### To Remove the Vehicle from Storage:

1. Uncover and clean the vehicle.
2. Charge the battery if needed.
3. Perform a pre-ride inspection, then test-ride the vehicle at low speed.

**FOR APPROVAL ONLY**

***ROAD SIDE  
REPAIRS***

---

# DIAGNOSTIC GUIDELINES

**NOTICE** If the vehicle must be transported, do not have it towed — towing can seriously damage the vehicle. Refer to *TRANSPORTING THE VEHICLE* in this section for detailed instructions.

## Will not Shift into First Gear (SM6 Model)

If the gearbox cannot shift into first gear when vehicle is not moving:

1. Slowly release the clutch lever while maintaining a light pressure down on the shift lever.
2. When you feel the shift lever engaging into first gear, pull in the clutch lever.

## Will not Shift into Neutral (SE6 Model)

If the gearbox cannot shift into neutral when vehicle is not moving:

1. The engine speed will be automatically increased to approximately 1300 RPM then it will be brought back to idle speed.
2. If it does not work, retry pressing downshift button.

## Will not Shift (SE6 Model)

Have your vehicle transported to the nearest Can-Am roadster dealer.

## Engine will not Start

### ENGINE DOES NOT TURN OVER

1. Scrolling safety message on the multifunction gauge cluster not acknowledged.
  - Press the *MODE (M)* to acknowledge the safety message.
2. Engine stop switch in the OFF position.
  - Make sure that the engine stop switch is in the *ON* position.

### ENGINE DOES NOT TURN OVER (cont'd)

3. Clutch lever not engaged (SM6 model).
  - Pull in and hold the clutch lever.
4. Ignition switch in the OFF position.
  - Turn the ignition to the *ON* position.
5. Battery dead or poor battery connections.
  - Check the battery charge. Recharge if necessary (see *MAINTENANCE PROCEDURES*).
  - Check the battery connections in the front storage compartment (see *MAINTENANCE PROCEDURES*).
6. Blown fuse.
  - Check fuse condition (see *HOW TO REPLACE FUSES AND LIGHTS* in this section).
7. Transmission is in gear (SE6 model).
  - Depress brake pedal if transmission is in gear.

**FOR APPROVAL ONLY**

---

**ENGINE DOES NOT TURN OVER**  
 (cont'd)
 

---

**8. The key is not read.**

If the immobilizer system cannot read the key, the engine will not start. The following conditions can lead to the immobilizer system failing to read the key:

- Damaged computer chip
- Large metallic object near the key
- Electronic device near the key
- Second electronic coded key near the main key
- Other strong electromagnetic field in the key area
- *If the engine does not start and a key error message is displayed in the cluster, make sure that none of the above conditions are present. If the problem is still present without these conditions, see an authorized Can-Am roadster dealer.*

---

**ENGINE TURNS OVER, BUT DOES NOT START**

---

**1. Low fuel.**

- *Fill the fuel tank (see BASIC PROCEDURES).*

**2. Weak battery.**

- *Check battery charge. Recharge if necessary (see MAINTENANCE PROCEDURES).*
- *Check the battery connections in the front storage compartment.*







**3. Engine management problem.**

- *Check to see whether the engine indicator lamp is ON while starting. Seek service from an authorized Can-Am roadster dealer, repair shop, or person of your own choosing for maintenance, repair, or replacement. Please refer to the US EPA EMISSIONS PERFORMANCE WARRANTY contained herein for information about warranty claims.*

# MESSAGES IN MULTIFUNCTION GAUGE





Important information about vehicle condition is displayed on the multifunction gauge. When starting the engine, always look at the gauge for any indicator lamps or special messages.

## F3 and F3-S Models

F3 AND F3-S MODELS INDICATOR LAMPS (MALFUNCTIONS)			
INDICATOR LAMP(S)	DIGITAL WARNING	CAUSE	WHAT TO DO
 FLASHING	None	Gearbox position sensor malfunction	<ul style="list-style-type: none"> <li>– Stop vehicle and allow to reach neutral.</li> <li>Have the vehicle transported to the nearest authorized Can-Am roadster dealer.</li> </ul>
None	BAD KEY	Wrong or defective key	Use the right key for the vehicle or contact an authorized Can-Am roadster dealer.
 ON	HIGH ENGINE TEMPERATURE	Engine is overheating	<ul style="list-style-type: none"> <li>– Stop and wait for engine to cool off.</li> <li>– Check for leaks.</li> <li>– Check coolant level and adjust (see <i>MAINTENANCE PROCEDURES</i>).</li> </ul>
 ON	LO BATT VOLT or HI BATT VOLT	Low or high battery voltage	<ul style="list-style-type: none"> <li>– Recharge battery (see <i>MAINTENANCE PROCEDURES</i>).</li> <li>– Check battery connections.</li> <li>Have the vehicle transported to the nearest authorized Can-Am roadster dealer.</li> </ul>
 ON	ABS FAULT	ABS malfunction. No ABS operation	Have the vehicle transported to the nearest authorized Can-Am roadster dealer.
 ON	NONE	VSS malfunction	* Have the vehicle transported to the nearest authorized Can-Am roadster dealer.
NONE		Air controlled suspension malfunction	<ul style="list-style-type: none"> <li>– Check pressure in the air spring</li> <li>– Check rear suspension position sensor</li> <li>– Have the vehicle transported to the nearest authorized Can-Am Roadster Dealer to verify the Air Controlled Suspension Min/Max values calibration.</li> </ul>

**FOR APPROVAL ONLY**







**F3 AND F3-S MODELS INDICATOR LAMPS (MALFUNCTIONS)**

INDICATOR LAMP(S)	DIGITAL WARNING	CAUSE	WHAT TO DO
 ON	EBD FAULT	EBD malfunction	Have the vehicle transported to the nearest authorized Can-Am roadster dealer.
	BRAKE FAILURE	Low brake fluid level or faulty sensor	<ul style="list-style-type: none"> <li>- Check for brake fluid leaks.</li> <li>- Check brake fluid level and adjust (see <i>MAINTENANCE PROCEDURES</i>).</li> </ul>
 ON+BEEPING AT KEY OFF	NONE	Faulty parking brake or component Parking brake not activated at key off	<ul style="list-style-type: none"> <li>- Make sure battery voltage is at least at 11 V.</li> <li>- Check fuse no. 1 on the right fuse box (see <i>MAINTENANCE PROCEDURES</i>).</li> </ul> Have the vehicle transported to the nearest authorized Can-Am roadster dealer.
 ON	CHECK ENGINE	Engine management component malfunction	Remove key, wait 20 seconds, and reinsert key.
	CHECK DPS	Dynamic power steering component malfunction	Have the vehicle repaired by an authorized Can-Am roadster dealer.
	CHECK TRANSMISSION	Transmission Control Module component malfunction	<ul style="list-style-type: none"> <li>- Remove key, wait 20 seconds, and reinsert key.</li> <li>- Have the vehicle repaired by an authorized Can-Am roadster dealer.</li> </ul>
 FLASHING	LIMP HOME MODE	Important engine management component or VSS malfunction	* Have the vehicle transported to the nearest authorized Can-Am roadster dealer.
 ON	NONE	Low oil pressure	<ul style="list-style-type: none"> <li>- Check for oil leaks.</li> <li>- Check oil level and adjust (see <i>MAINTENANCE PROCEDURES</i>).</li> </ul>

Note: A combination of two different warnings can occur.



\* BRP recommends having the vehicle transported when in LIMP HOME. If you operate the vehicle in LIMP HOME, avoid abrupt maneuvers and immediately go to the nearest authorized Can-Am roadster dealer to have your vehicle serviced before riding again. In LIMP HOME, the engine RPM is limited and therefore the vehicle speed.

*F3 Limited and F3-T Models*

INDICATOR LAMPS (MALFUNCTIONS)			
INDICATOR	MESSAGE/ WARNING	CAUSE	WHAT TO DO
	BAD KEY	Defective key	Contact an authorized Can-Am roadster dealer.
	WRONG KEY	Wrong key	Use the right key for the vehicle or contact an authorized Can-Am roadster dealer.
	CHECK KEY	Defective key	Contact an authorized Can-Am roadster dealer.
	HIGH ENGINE TEMPERATURE	Engine is overheating	<ul style="list-style-type: none"> <li>– Stop and wait for engine to cool off.</li> <li>– Check for leaks.</li> <li>– Check coolant level and adjust (see <i>MAINTENANCE PROCEDURES</i>).</li> </ul>
	SUSPENSION FAULT	Air controlled suspension malfunction	<ul style="list-style-type: none"> <li>– Check pressure in the air spring</li> <li>– Check rear suspension position sensor</li> <li>– Have the vehicle transported to the nearest authorized Can-Am Roadster Dealer to verify the Air Controlled Suspension Min/Max values calibration.</li> </ul>
	BRAKE FAILURE	EBD malfunction	Have the vehicle transported to the nearest authorized Can-Am roadster dealer.
	TRANSMISSION SIGNAL FAULT	Transmission Control Module component	<ul style="list-style-type: none"> <li>– Remove key, wait 20 seconds, and reinsert key.</li> <li>– Have the vehicle repaired by an authorized Can-Am roadster dealer.</li> </ul>
	BRAKE FAILURE - LOW BRAKE FLUID	Low brake fluid level or faulty sensor	<ul style="list-style-type: none"> <li>– Check for brake fluid leaks.</li> <li>– Check brake fluid level and adjust (see <i>MAINTENANCE PROCEDURES</i>).</li> </ul>
	CHECK DPS	Dynamic power steering component	Have the vehicle repaired by an authorized Can-Am roadster dealer.

**FOR APPROVAL ONLY**



INDICATOR LAMPS (MALFUNCTIONS)			
INDICATOR	MESSAGE/ WARNING	CAUSE	WHAT TO DO
	LIMP HOME MODE	Important engine management component or VSS malfunction	* Have the vehicle transported to the nearest authorized Can-Am roadster dealer.
	LOW OIL - STOP ENGINE	Low oil pressure	– Check for oil leaks. – Check oil level and adjust (see <i>MAINTENANCE PROCEDURES</i> ).
A combination of two different warnings can occur.			

**FOR APPROVAL ONLY**

\* BRP recommends having the vehicle transported when in LIMP HOME. If you operate the vehicle in LIMP HOME, avoid abrupt maneuvers and immediately go to the nearest authorized Can-Am roadster dealer to have your vehicle serviced before riding again. In LIMP HOME, the engine RPM is limited and therefore the vehicle speed.

Important information messages can also be displayed temporarily to assist indicator lamps.



TYPICAL

When a digital warning appears, it will show the warning for 6 seconds and then the warning will disappear for 60 seconds. During the 60 seconds, the small digital indicator will flash. This sequence will be repeated three times and then will stop for 15 minutes. During the 15 minutes only the indicator lamps will be activated.

# WHAT TO DO IN THE FOLLOWING CIRCUMSTANCES

## Lost Keys

Use your spare key to have another one made by an authorized Can-Am roadster dealer as soon as possible. **If both keys are lost**, the ignition switch and the fuel cap will need to be replaced at the expense of the vehicle owner.

## Flat Tire

If a tire has a **major** puncture or cut in the tread and is completely deflated, have the vehicle transported to the nearest Can-Am Spyder dealer. Refer to *TRANSPORTING THE VEHICLE* in this section for transporting instructions.

If a tire has a **minor** nail or stone puncture and is not completely deflated, the tire can be temporarily repaired. To temporarily repair a tire, a self-inflating tire sealer or tire plug repair kit can be used. Follow the manufacturer's instructions that come with the tire sealer or repair kit and have the tire repaired or replaced by an authorized Can-Am roadster dealer **as soon as possible**.

When a tire is temporarily repaired, ride slowly and carefully, and frequently check tire pressure until it is replaced or permanently repaired.

## Dead Battery

If the battery is dead or too low to crank the engine, it can be jump started.

### WARNING

Connect the jumper cables as specified in the jump start procedure.

Batteries can emit explosive gas that can ignite if jumper cables are not properly connected.

To jump start the battery, proceed as follows:

1. If using another vehicle to jump start the battery, move the other vehicle as close as possible and preferably to the front of the Spyder roadster. Make sure the vehicles are not touching.

2. Shift the Spyder roadster into NEUTRAL (N) and engage the parking brake.

**NOTE:** If battery voltage is below 11 V, parking brake cannot be activated.

3. Turn off the engine of the other vehicle and all electrical accessories.

4. Open the hood of the other vehicle.

5. Open the front storage compartment of the Spyder roadster.

6. Make sure the ignition switch is set to OFF.

7. Remove basket. Refer to *BODY PANELS*.

8. Connect one end of the RED (+) jumper cable to the POSITIVE (+) terminal of the Spyder roadster.

9. Connect the other end of the RED (+) jumper cable to the POSITIVE (+) terminal of the booster battery.

10. Connect one end of the BLACK (-) jumper cable to the NEGATIVE (-) terminal of the booster battery.

11. Connect the other end of the BLACK (-) jumper cable to the NEGATIVE (-) terminal of the Spyder roadster.

FOR APPROVAL ONLY

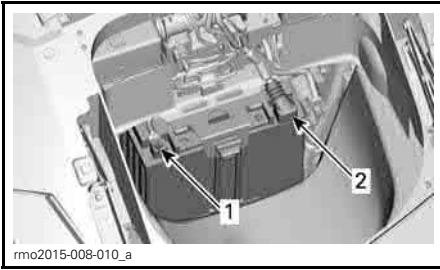

1. BLACK (-) terminal
2. RED (+) terminal

**FOR APPROVAL ONLY**

12. Start the vehicle with the booster battery and run the engine at idle for a couple of minutes.
13. Stand on the right side of the Spyder roadster, apply brakes and start the engine. If it does not crank or it cranks slowly, wiggle the jumper cables to make sure they are making good contact and try again.  
If it still does not start, there might be a problem with the starting system. Have the vehicle transported (see *TRANSPORTING THE VEHICLE* in this section) and repaired by the nearest authorized Can-Am roadster dealer.
14. As soon as the engine starts, disconnect both jumper cables in the reverse connection order, starting with the BLACK (-) cable connected to the Spyder roadster.
15. Have the battery fully recharged with a battery charger (see *MAINTENANCE PROCEDURES*) or by a qualified service station as soon as possible.

If the engine dies shortly after it has been jump started or when the jumper cables are disconnected, there might be a problem with the charging system. Have the vehicle transported (see *TRANSPORTING THE VEHICLE*) and repaired by the nearest authorized Can-Am roadster dealer.

After recharging the battery, have the vehicle inspected by an authorized Can-Am roadster dealer.

# HOW TO REPLACE FUSES AND LIGHTS

## Fuses

If any electrical accessories stop working on the vehicle, check for blown fuses and replace if necessary.

If an electrical failure still occurs, have the vehicle serviced by an authorized Can-Am roadster dealer.

## Fuse Locations

Fuses are located inside the front storage compartment.

To access the fuse boxes, open the front storage compartment.

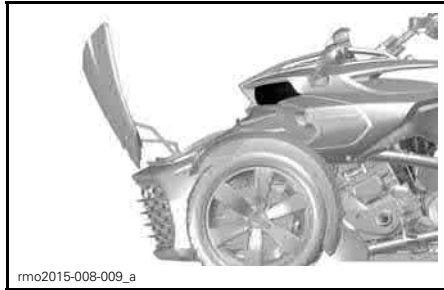

**TYPICAL - FRONT STORAGE COMPARTMENT OPENED**

Remove basket from vehicle. Refer to **BODY PANELS**.

Push down on the tabs and carefully remove the fuse box covers.

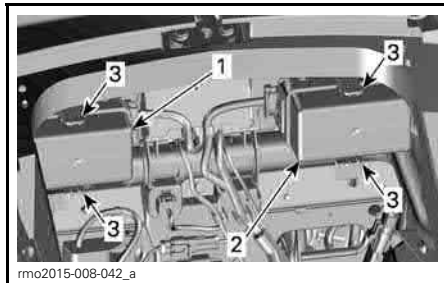

**INSIDE FRONT STORAGE COMPARTMENT**

1. RH fuse service cover
2. LH fuse service cover
3. Tabs

## Fuse Description



**FUSES - LEFT FUSE BOX**

**NOTE:** Refer to decal located between both fuse boxes for correct identification.

## Left Fuse Box

FUSE NO.	DESCRIPTION	RATING
1	Cluster / DLC	15 A
2	Wake-up ECM / VCM / MSR and D.E.S.S. / SAS / YAS / PRS	10 A
3	Alternator	10 A
4	PBM	20 A
5	ECM	5 A
6	Injectors / Coils	15 A
7	Wake-up TCM, DPS / Cluster	10 A
8	H02S / CAPS / Fuel Pump / EVAP / CSV	15 A

**FOR APPROVAL ONLY**

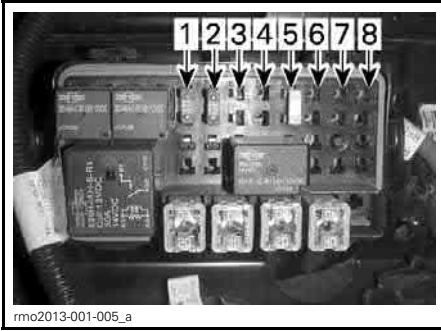

FUSES - RIGHT FUSE BOX

**Right Fuse Box**

FUSE NO.	DESCRIPTION	RATING
1	Days lights / Parking lamps / Plate lights	15 A
2	Brake lights / Hazard	10 A
3	Amplifier (if equipped)	15 A
4	NOT USED	
5	Load shedding relay acc.	25 A
6	Customer acc. circuits	10 A
7	NOT USED	
8	NOT USED	

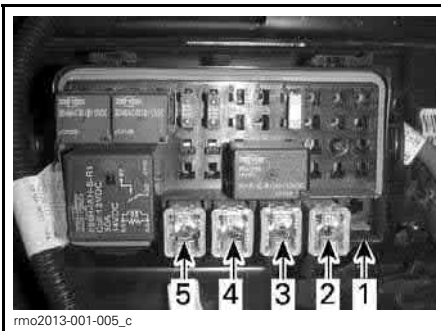

JCASE FUSES - RIGHT FUSE BOX

**Left JCase Fuse Box**

JCASE FUSE NO.	DESCRIPTION	RATING
1	Main control	40 A
2	DPS	25 A
3	VCM pump	40 A
4	VCM pump	40 A
5	Not used	

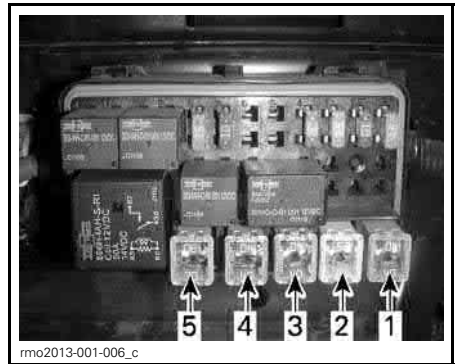

JCASE FUSES - LEFT FUSE BOX

**Right JCase Fuse Box**

JCASE FUSE NO.	DESCRIPTION	RATING
1	Cooling fan	30 A
2	Accessories	40 A
3	TCM solenoids	20 A
4	LO headlamps	30 A
5	HI headlamps	20 A

**Fuse Replacement**

1. Set the ignition switch to OFF.
2. Pull the fuse out.
3. Check whether the filament is melted.

FOR APPROVAL ONLY

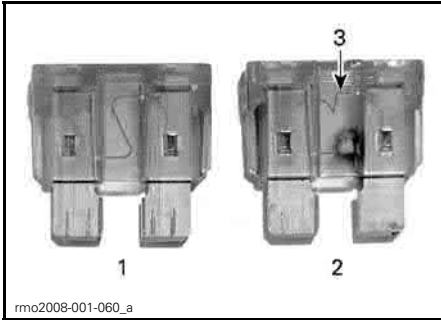

**FUSE**

1. Good fuse
2. Blown fuse
3. Melted filament

4. Replace the fuse with one with the same rating. Spare fuses are located in the fuse box cover.

**⚠ WARNING**  
 Using a higher-rated fuse can cause severe damage and may cause fires.

5. To close the fuse box covers, position covers over fuses and carefully push down until they click.
6. To close the fuse service covers, position covers over fuse boxes and push down carefully until the fuse service covers engage.
7. Install basket and close the front storage compartment.

**Lights**

If any light stops working on the vehicle, replace bulb of defective light.

If the light failure still occurs, have the vehicle serviced by an authorized Can-Am roadster dealer.

**⚠ CAUTION** Always turn the ignition switch to the OFF position before replacing a bulb to avoid electric shock.

Always check light operation after replacement.

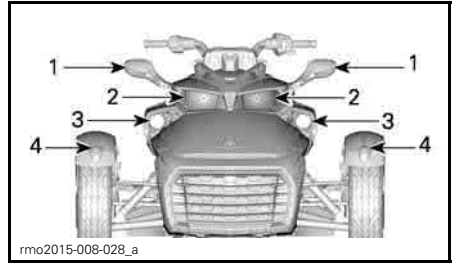

**TYPICAL - LIGHTS LOCATION — FRONT OF VEHICLE - F3 BASE AND F3-S NORTH AMERICAN MODELS**

1. Turn signal light
2. Headlight
3. Fog lights (optional)
4. Position light

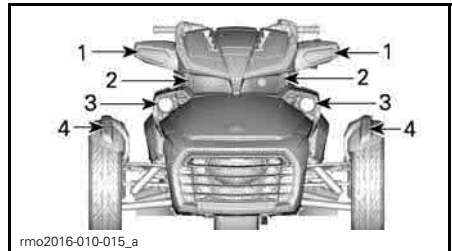

**TYPICAL - LIGHTS LOCATION — FRONT OF VEHICLE — F3-T AND F3 LIMITED NORTH AMERICAN MODELS**

1. Turn signal light
2. Headlights
3. Fog lights (optional)
4. Position light

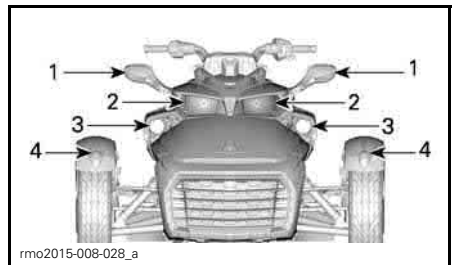

**TYPICAL - LIGHTS LOCATION — FRONT OF VEHICLE — F3 BASE AND F3-S EUROPEAN, AUSTRALIAN AND JAPANESE MODELS**

1. Turn signal light
2. Headlights — high beam
3. Headlights — low beam
4. Position light

**FOR APPROVAL ONLY**

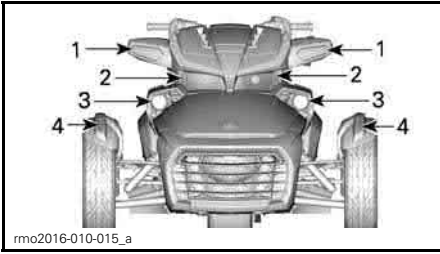

rmo2016-010-015\_a  
**TYPICAL - LIGHTS LOCATION — FRONT OF VEHICLE — F3-T AND F3 LIMITED EUROPEAN, AUSTRALIAN AND JAPANESE MODELS**

1. Turn signal light
2. Headlights — high beam
3. Headlights — low beam
4. Position light

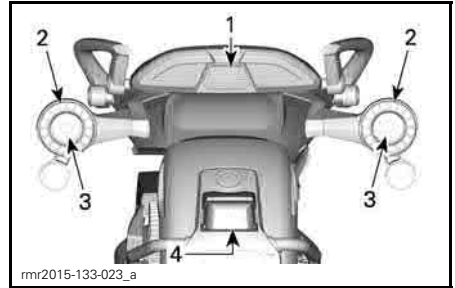

rmr2015-133-023\_a  
**TYPICAL - LIGHTS LOCATION — REAR OF VEHICLE — F3 BASE AND F3-S JAPANESE MODELS**

1. Back-up light
2. Taillight/brake light
3. Turn signal light
4. License plate light

**FOR APPROVAL ONLY**

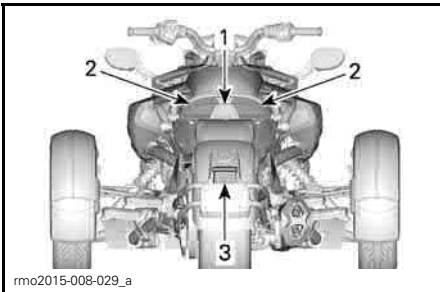

rmo2015-008-029\_a  
**TYPICAL - LIGHTS LOCATION — REAR OF VEHICLE — F3 BASE AND F3-S NORTH AMERICAN MODELS**

1. Back-up light
2. Taillight/brake light/turn signal light
3. License plate light

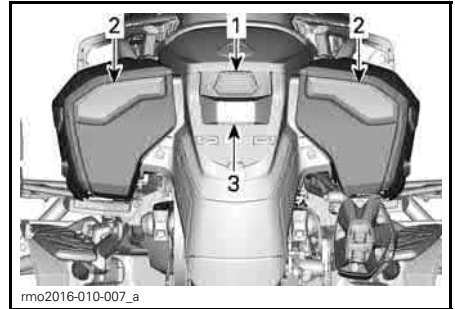

rmo2016-010-007\_a  
**TYPICAL - LIGHTS LOCATION — REAR OF VEHICLE — F3-T MODELS - ALL COUNTRIES**

1. Back-up light
2. Taillight/brake light/turn signal light
3. License plate light

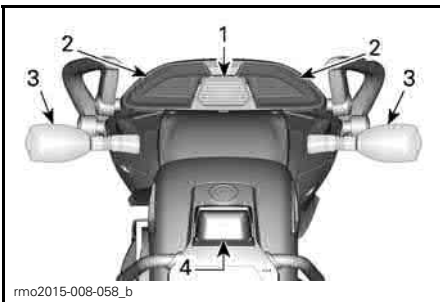

rmo2015-008-058\_b  
**TYPICAL - LIGHTS LOCATION — REAR OF VEHICLE — ALL MODELS EXCEPT F3 LIMITED AND F3-T, NORTH AMERICAN AND JAPANESE MODELS**

1. Back-up light
2. Taillight/brake light
3. Turn signal light
4. License plate light

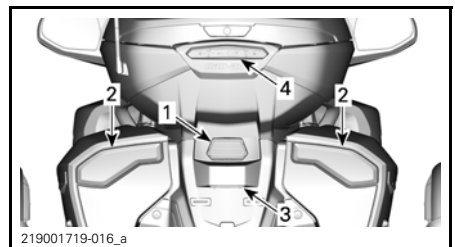

219001719-016\_a  
**TYPICAL - LIGHTS LOCATION — REAR OF VEHICLE — F3 LIMITED MODELS - ALL COUNTRIES**

1. Back-up light
2. Taillight/brake light/turn signal light
3. License plate light
4. Taillight/Brake light (functional on C/U only)

## Headlight — Low Beam

*Australian, European and Japanese Models*

Refer to *BODY PANELS* and remove the following.

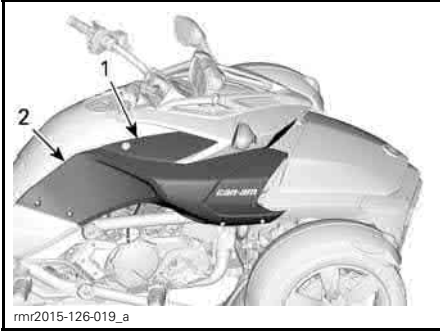

rnr2015-126-019\_a

**TYPICAL - RIGHT SIDE ILLUSTRATED, LEFT SIDE SIMILAR**

1. Lateral service cover
2. Side panel

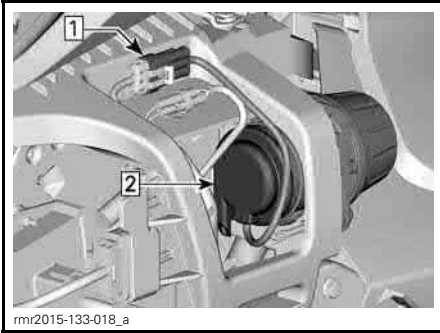

rnr2015-133-018\_a

- Step 1: Disconnect light from vehicle harness
- Step 2: Remove rubber cap

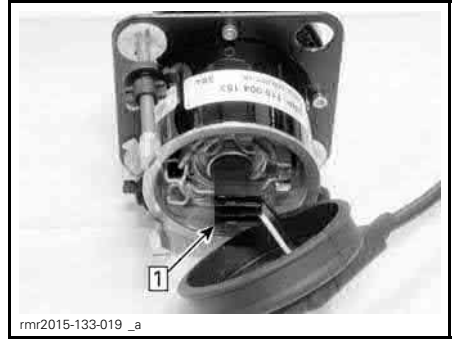

rnr2015-133-019\_a

Step 1: Remove connector from light bulb



rnr2015-133-020\_a

Step 1: Release spring clips

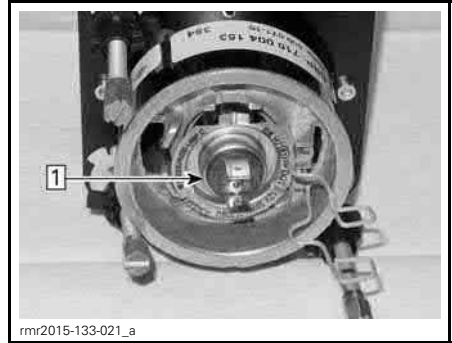

rnr2015-133-021\_a

Step 1: Pull bulb out of light housing

Reinstall removed parts in the reverse order of their removal. However, pay attention to the following.

**FOR APPROVAL ONLY**



**NOTICE** Never touch the glass portion of a halogen bulb with bare fingers, it shortens its operating life. If the glass is touched, clean it with isopropyl alcohol which will not leave a film on the bulb.

FOR APPROVAL ONLY

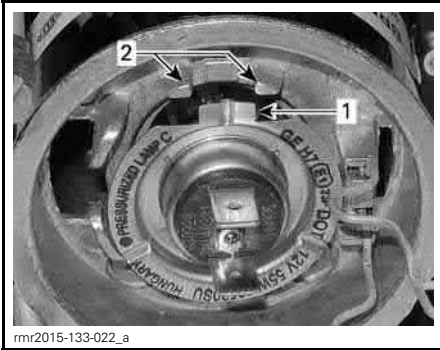

rnr2015-133-022\_a

1. Light bulb alignment tab
2. Alignment tabs on light housing

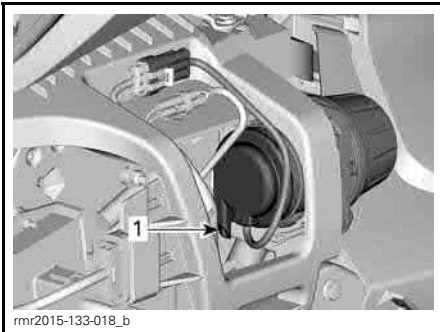

rnr2015-133-018\_b

1. Vent tube oriented downwards

**NOTICE** Do not overtighten panel screws. Any deformation of the panel around a screw is an indication that it is too tight. You may damage the panel.

Confirm that the lights function.

### Headlight — High Beam (F3 base and F3-S Models)

#### F3 Base Models

1. Remove retaining screws securing top rails cover to top rails.

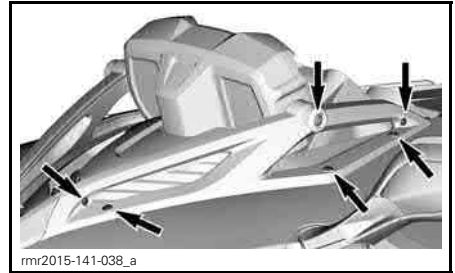

rnr2015-141-038\_a

TYPICAL - RETAINING SCREWS TO REMOVE

2. Remove retaining screws securing top rails to vehicle.

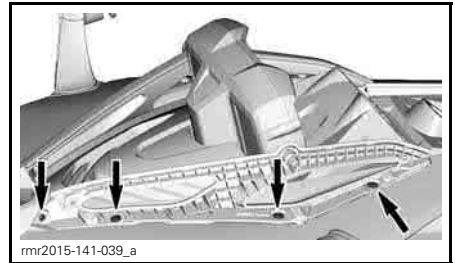

rnr2015-141-039\_a

TYPICAL - RETAINING SCREWS TO REMOVE

#### F3-S Models

3. Remove retaining screws securing top rail to vehicle.

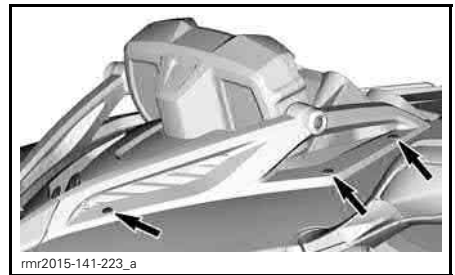

rnr2015-141-223\_a

TYPICAL

#### All Models

4. Loosen console nose lower retaining screw.
5. Unclip upper portion of nose, then pivot forward.

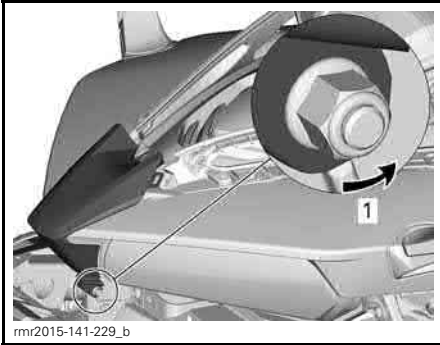

**TYPICAL - CONSOLE NOSE PIVOTING**

1. Loosen retaining screw

6. Remove retaining screws securing gauge trim and disconnect gauge.

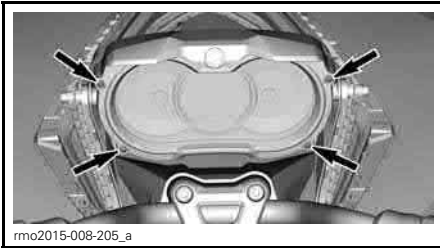

**RETAINING SCREWS TO REMOVE**

7. Remove retaining screws inside gauge support on both sides.

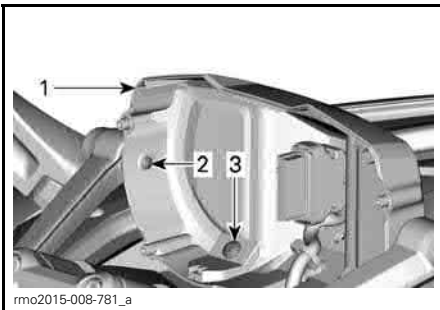

**TYPICAL -**

- 1. Gauge support
- 2. Retaining screw attached to top rail
- 3. Retaining screw attached to console panel

8. Remove key switch cover.

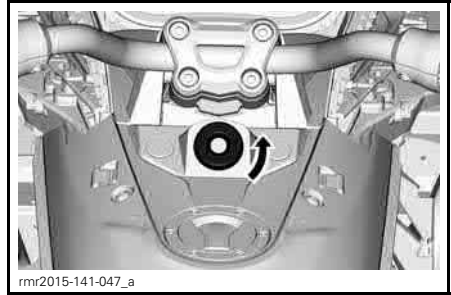

9. Remove switch bezel.

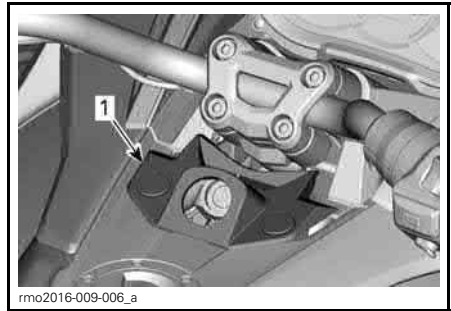

1. Switch bezel

10. Remove console panel.

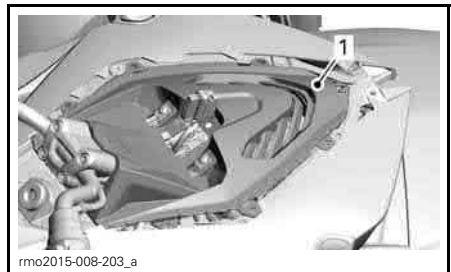

**CONSOLE PANEL REMOVAL**

1. Console panel

11. Disconnect headlamp connector.

**FOR APPROVAL ONLY**

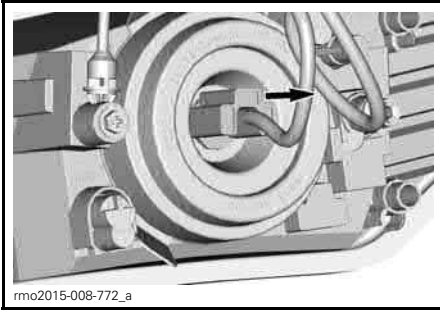

12. Pull out the housing cap.

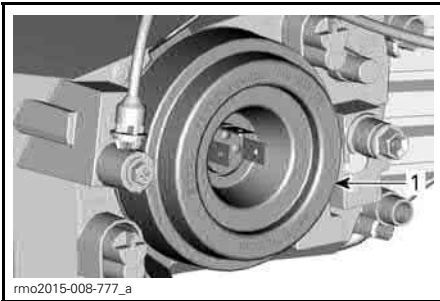

1. Housing cap

13. Unclip light bulb retaining spring.

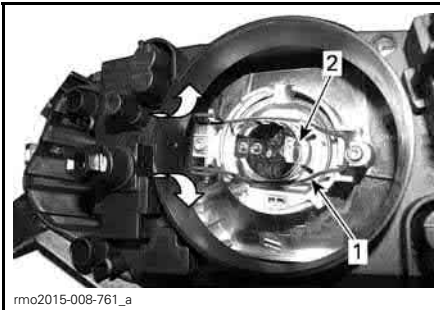

1. Bulb retaining spring  
2. Bulb housing

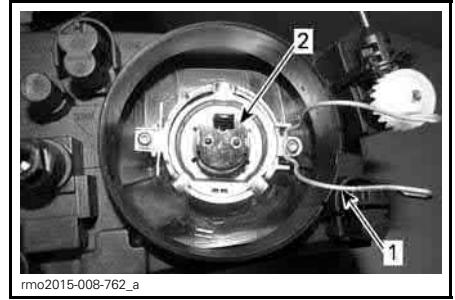

1. Bulb retaining spring  
2. Bulb housing

14. Install the new bulb in place and secure with retaining spring.

**NOTICE** Never touch glass portion of a halogen bulb with bare fingers, it shortens its operating life. If glass is touched, clean it with isopropyl alcohol and a clean cloth.

15. Reinstall housing cap.

16. Install the connector onto light bulb.

17. Properly reinstall the parts in the reverse order of their removal.

**Headlight — High Beam (F3 Limited and F3-T Models)**

1. Remove front service cover.

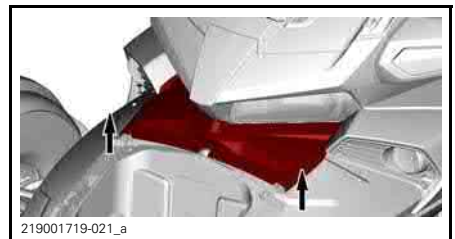

2. Remove lateral service covers.

FOR APPROVAL ONLY

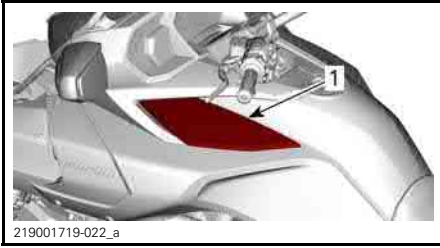

1. Lateral service cover

3. Remove lateral side panels.

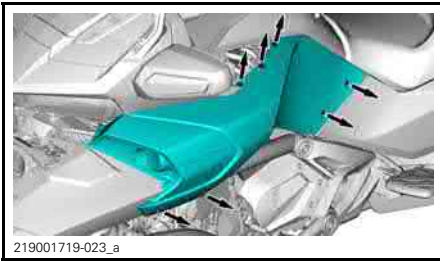

4. Remove mirror trims.

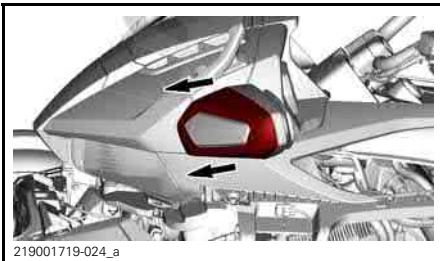

5. Remove console nose.

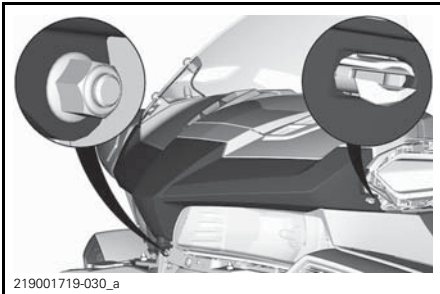

6. Remove speaker trim.

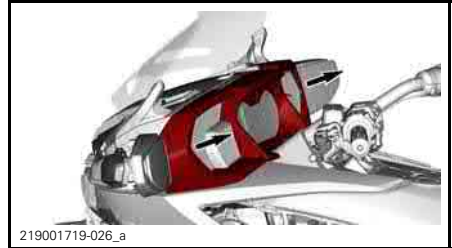

7. Remove lateral console panel.

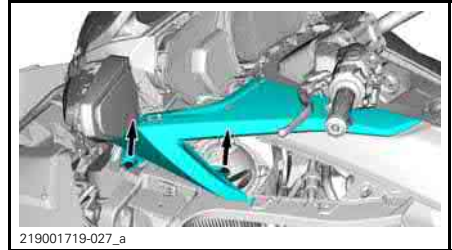

8. Remove headlight.

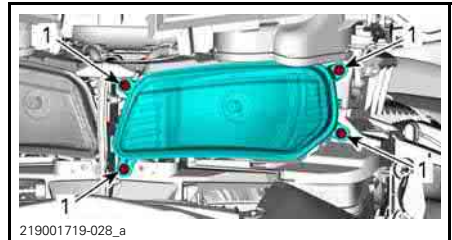

1. Headlight retaining screw

9. Disconnect headlamp connector.

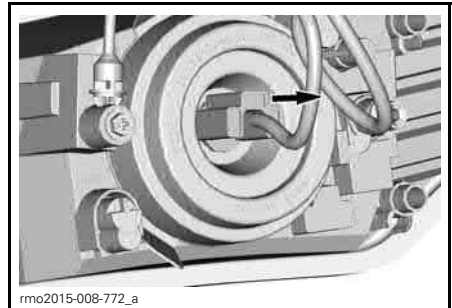

10. Pull out rubber housing cap.

FOR APPROVAL ONLY