

Robertshaw®

INTEGRATED COMFORT SOLUTIONS™

9610 DIGITAL
PROGRAMMABLE
THERMOSTAT



ELECTRIC GAS

7 Day Programmable
1 Heat / 1 Cool

User's Manual Quick Start Installation and Programming



110-655



As an Energy Star partner, Maple Chase has determined that this thermostat product meets the Energy Star guide lines for energy efficiency.

Installation Guide

IMPORTANT SAFETY INFORMATION WARNING:

- Always turn off power at the main power source by unscrewing fuse or switching circuit breaker to the off position before installing, removing, cleaning or servicing thermostat.
- Read all of the information in this manual before installing or programming this thermostat.
- This is a 24V AC low-voltage thermostat. Do not install on voltages higher than 30V AC.
- All wiring must conform to local and national building and electrical codes and ordinances.
- Do not short (jumper) across terminals on the gas valve or at the system control to test installation. This will damage the thermostat and void the warranty.

Features

- Four pre-programmed Energy Star setpoints for each day of the week.
- Two "AA" ENERGIZER brand batteries retain program memory, even during power outages.
- Low battery indicator.
- Fahrenheit/Celsius display option.
- Programmable from 45°F (7°C) to 90°F (32°C).
- Accuracy within ± 1 degree.
- Adjustable temperature differential: 1-3 degrees.
- Maintains summer and winter programming.
- Low temperature freeze protection. While in heat mode, thermostat will mechanically turn on heat if temperature drops to 40°F (4°C) - even if batteries are missing or drained.
- Automatic heating shutdown if temperature exceeds 90°F (32°C).
- Quickset programming for quickly programming all days of the week simultaneously.
- Mercury free, environmentally friendly.

Replacing Existing Thermostat

1. Turn off power to heating and cooling system.
2. Remove cover of old thermostat to expose wires. Do not disconnect wires. (Fig. 1)
3. Label wires per Table 1.

Table 1

Old Label	New Label	Description
M, 4, RH, R5 or R	RH	Heat Transformer, hot side
V or RC	RC	Cooling Transformer, hot side
Y or Y6	Y	Cooling Control
H, W or 4	W	Heating control
F or G	G	Fan control relay
C*	Y or None	Either cooling control or common side of transformer
O	O	Cool active reversing valve
B	B	Heat active reversing valve

***NOTE:** ON SOME OLDER MODELS, THE C TERMINAL CAN BE EITHER THE COOLING CONTROL OR THE COMMON SIDE OF THE TRANSFORMER. CHECK FURNACE WIRING DIAGRAM TO VERIFY C TERMINAL. IF IT IS THE COMMON SIDE OF THE TRANSFORMER, CAP THE WIRE AND TUCK INTO THE WALL. IF IT IS THE COOLING CONTROL, CONNECT TO THE Y TERMINAL.

4. After labeling wires, remove wires from terminals.
5. Remove existing thermostat base from wall.
6. Refer to the following section for instructions on how to install thermostat.

Figure 1

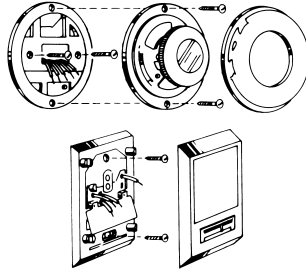

Installing Item 9610 Thermostat

NOTE: FOR NEW INSTALLATIONS, MOUNT THERMOSTAT ON INSIDE WALL, 4-5 FEET ABOVE THE FLOOR. DO NOT INSTALL BEHIND A DOOR, IN A CORNER, NEAR AIR VENTS, IN DIRECT SUNLIGHT, OR NEAR ANY HEAT OR STEAM GENERATING FIXTURES. INSTALLATION AT THESE PLACES WILL AFFECT THERMOSTAT OPERATION.

1. Turn power off to the heating and cooling systems.
2. Place COOL/OFF/HEAT In OFF position.

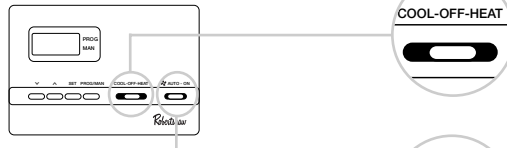

3. Place  AUTO-ON switch Into AUTO position.
4. Remove the cover using a coin or screwdriver.

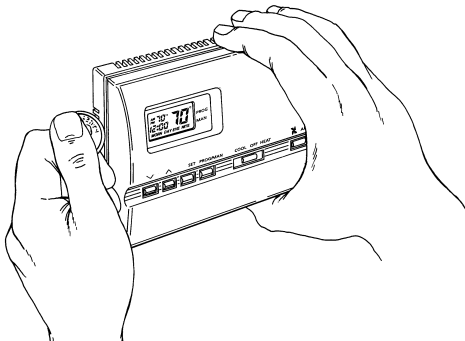
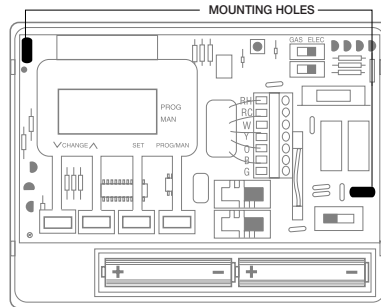

Figure 2

5. Place thermostat against the wall at desired location. Make sure wires will feed through opening on base of thermostat.
6. Mark placement of mounting holes. See Fig. 3. Set base aside.

Figure 3



7. Drill the marked holes using a 3/16" drill bit.
8. Tap plastic anchors into the holes.
9. Align base with plastic anchors and feed wires through opening. See Fig 4.

Figure 4

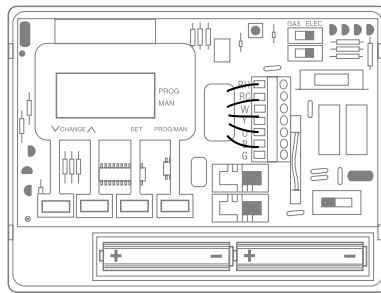

10. Secure base to wall with supplied screws.
11. Connect wires to terminal strip. Refer to wiring diagrams on other side of this sheet. Make sure wire connections are secure.
12. Place fan option switch into either the "ELEC" or "GAS" position depending upon the type of furnace. Refer to Figure 5.

Figure 5

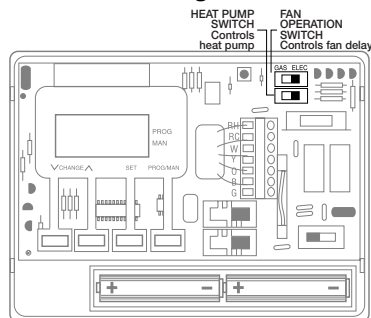

13. Put heat pump option switch into either the "NON HPUMP" or "HPUMP" position, depending on the type of system in the home.

14. Install two "AA" ENERGIZER brand batteries or equivalent into battery compartment. Be sure to place positive (+) ends of batteries toward (+) battery terminals in the battery compartment. The display will show as follows:

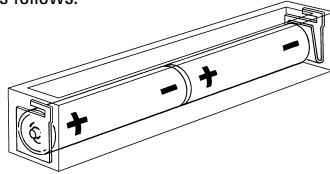

15. Replace cover onto thermostat by snapping into place.
16. Turn on power to system . Test thermostat as described in the following section.

Programming Guide

Set Time of Day, Day of Week, Temperature Differential, Residual Cooling

1. Press & Hold SET. Press PROG/MAN. Release simultaneously.

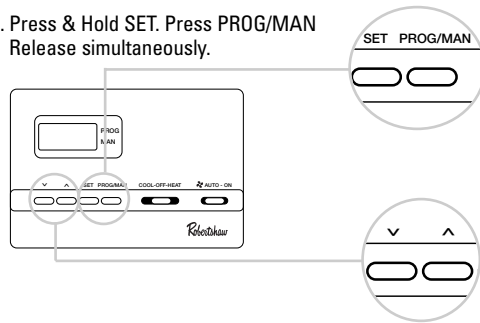

Press c or d to change Time of Day.

2. Press



Press



To Change Day of Week

1=MO
2=TU
3=WE
4=TH
5=FR
6=SA
7=SU

3. Press



Press



To change
Temperature Differential*

*THE TEMPERATURE DIFFERENTIAL IS FACTORY PRESET AT 1°. THIS MEANS THAT WHENEVER THE ROOM TEMPERATURE CHANGES BY ONE FULL DEGREE FROM THE TEMPERATURE SETTING, THE SYSTEM WILL TURN ON. IF THE SYSTEM TURNS ON TOO OFTEN, INCREASE THE TEMPERATURE DIFFERENTIAL.

4. Press



Press



To change
Residual Cooling**

**THE RESIDUAL COOL FEATURE WILL KEEP THE SYSTEM FAN ON FOR AN ADDITIONAL 30, 60 OR 90 SECONDS AFTER THE COMPRESSOR CYCLES OFF. RESIDUAL COOLING CAN ONLY BE PROGRAMMED WHEN SETTING THE COOLING PROGRAM.

Changing Fahrenheit (F) to Celsius (C)

Press and Hold SET



Press



Release both simultaneously.

QuickSet™ Programming Mode*

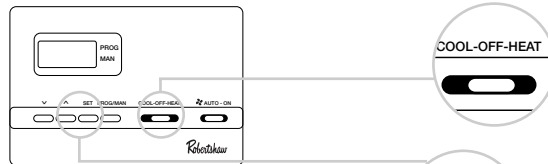

1. Place COOL-OFF-HEAT in HEAT or COOL position.
2. Press & Hold SET. Press the \downarrow button. Release simultaneously.
3. The MORN indicator should be blinking. Program the Time-of-Day and the temperature as outlined in the Setting Daily Program section.

*QuickSet™ will program all 7 days of the week with the same program. Individual days can then be changed or modified.

Setting Daily Programming

Summer (Cool) Settings:

1. Place COOL-OFF-HEAT in COOL position.

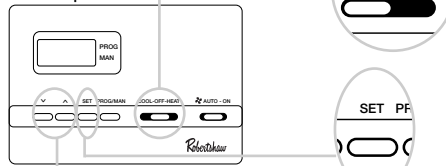

2. Press SET button. The display will show a number from 1 to 7. This number represents the day of the week to be programmed. If programming individual days, press either c or d button to adjust the day of the week to program.

3. Press SET. Press c or d to change MORN time

4. Press SET.

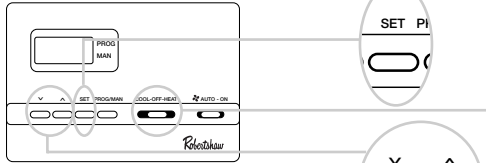

5. Press c or d to change MORN temperature.
6. Repeat Steps 2-5 for DAY, EVE, and NITE.
7. Repeat steps 2-6 above to program any other day of the week.

Winter (Heat) Settings:

1. Shift COOL-OFF-HEAT to HEAT position.
2. Repeat steps 2-6 to program HEAT (winter) settings.

Begin Programmed Operation

1. Place FAN AUTO-ON Into AUTO.

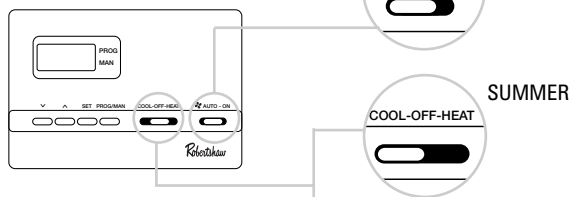

2. Place COOL-OFF-HEAT Into COOL or HEAT Depending upon the season.

3. Press PROG/MAN button until indicator is in PROG position.

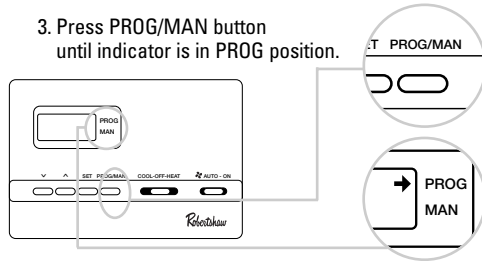

NOTE: WHILE IN THE COOL MODE, (OR HEAT AND COOL FOR SINGLE STAGE HEAT PUMP SYSTEM) ONCE THE THERMOSTAT TURNS THE SYSTEM OFF, A BUILT-IN DELAY KEEPS THE COMPRESSOR FROM TURNING ON FOR ABOUT 5 MINUTES. THIS PROTECTS THE COMPRESSOR. NO ADDITIONAL TIME DELAY RELAY (DELAY ON BREAK) IS NECESSARY. TO OVERRIDE THE 5-MINUTE DELAY FOR INSTALLATION, PRESS RESET. THIS WILL ERASE THE DELAY AND CHANGE PROGRAMMING TO FACTORY PRE-SETS..

Temporary Program Override

To temporarily increase or decrease temperature

Press c or d

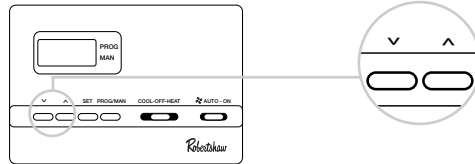

The Thermostat will automatically return to the program at the next scheduled setting change.

Manual Operation

1. Press PROG/MAN until indicator is in MAN position.

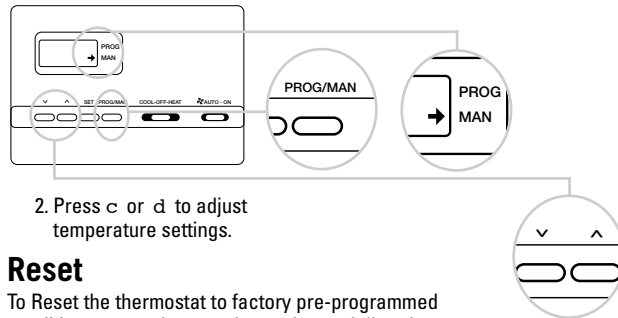

2. Press c or d to adjust temperature settings.

Reset

To Reset the thermostat to factory pre-programmed conditions, press the reset button located directly above the wiring terminal block.

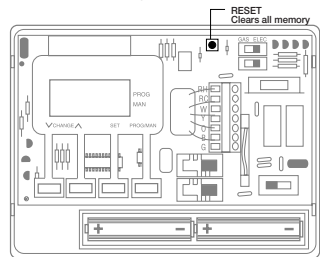

To Test Thermostat

WARNING: DO NOT SHORT (JUMPER) ACROSS TERMINALS OF GAS VALVE OR SYSTEM CONTROL TO TEST OPERATION. THIS WILL DAMAGE THE THERMOSTAT AND VOID YOUR WARRANTY.

CAUTION: DO NOT SWITCH SYSTEM TO COOL IF THE TEMPERATURE IS BELOW 50°F (10°C). THIS CAN DAMAGE THE AIR CONDITIONING SYSTEM AND CAUSE PERSONAL INJURY.

1. Place the COOL/OFF/HEAT switch into the COOL position

COOL-OFF-HEAT



2. Press the c button until the temperature setting is at least 3 degrees below the room temperature. The air conditioning system should turn on within a few seconds.

NOTE: WHILE IN THE COOL MODE, (COOL AND HEAT FOR SINGLE STAGE HEAT PUMP SYSTEM) ONCE THE THERMOSTAT TURNS THE SYSTEM OFF, A BUILT-IN DELAY KEEPS THE COMPRESSOR FROM TURNING ON FOR ABOUT 5 MINUTES. THIS PROTECTS THE COMPRESSOR. NO ADDITIONAL TIME DELAY RELAY (DELAY ON BREAK) IS NECESSARY. TO OVERRIDE THE 5-MINUTE DELAY FOR INSTALLATION, PRESS RESET. THIS WILL ERASE THE DELAY AS WELL AS ALL PROGRAMMING.

3. Put the COOL-OFF-HEAT switch into the OFF position. The air conditioning system should turn off. The fan may continue to run for a short period of time.

COOL-OFF-HEAT



4. Put the COOL-OFF-HEAT switch into the HEAT position.

COOL-OFF-HEAT



5. Press the button until the temperature setting is at least 3 degrees above room temperature. The heating system should turn on. The fan may not turn on immediately, depending upon the fan delay built into the furnace.

6. Put the COOL-OFF-HEAT switch into the OFF position. The heating system should turn off. Once again, the fan may have a delay.

COOL-OFF-HEAT



7. Put the AUTO-ON switch to the ON position. The blower fan should turn on.

AUTO - ON



8. Put the AUTO-ON switch to the AUTO position. The blower fan should turn off.

AUTO - ON



Troubleshooting

SYMPTOM	REMEDY
Thermostat does not turn on system	Check Wiring (See INSTALLATION) Check fuse. Replace with 3 amp fuse if fuse has opened.
Thermostat turns on and off too frequently.	Increase Temperature Differential (See PROGRAMMING).
Display is blank, flashing or constant "LO BAT."	Replace batteries.
System fan does not operate properly.	Move fan option switch to either gas or electric, to match system. (See INSTALLATION).
Time shown on display is not the current time of day.	Change time of day setting. (See PROGRAMMING)
Thermostat does not follow program.	Thermostat in MANUAL mode (See PROGRAMMING) Thermostat may not have been programmed in HEAT or COOL position. Verify program. Check AM/PM indicators at time of day and programmed time changes. (See PROGRAMMING) Verify program and day of week is correct. (See PROGRAMMING).
Thermostat does not advance day of week	To view or change day of week use method on page 5.

If problems with thermostats cannot be solved, call:

Technical Support: (800) 445-8299
Monday-Friday 7:30-5:30 CST
For after hours service, a 24-hour
Automated Help Line is available

For warranty returns, send thermostat, shipping prepaid to:

MAPLE CHASE COMPANY
Warranty Department
2820 Thatcher Road
Downers Grove, IL 60515

Wiring Diagrams

The following is just a sample of the most common types of HVAC systems. Refer to your systems installation manual for wiring information.

**HEAT/COOL
4-WIRE
SINGLE TRANSFORMER**

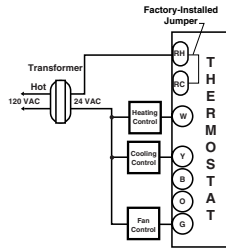

**HEAT ONLY
3-WIRE
SINGLE TRANSFORMER**

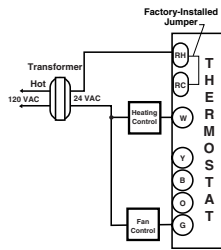

**HEAT ONLY
2-WIRE
SINGLE TRANSFORMER**

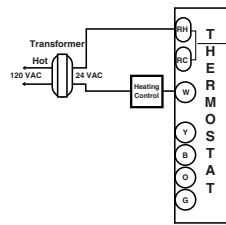

NOTE: Cut center of factory installed jumper and bend back.

**COOL ONLY
3-WIRE
SINGLE TRANSFORMER**

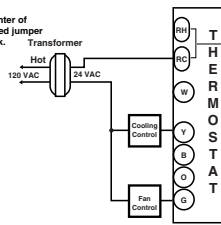

NOTE: Cut center of factory installed jumper and bend back.

**HEAT/COOL
5-WIRE
TWO TRANSFORMER**

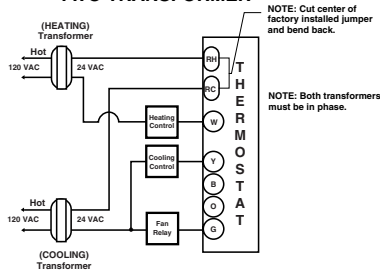

NOTE: Cut center of factory installed jumper and bend back.

NOTE: Both transformers must be in phase.

Wiring Diagrams (cont'd)

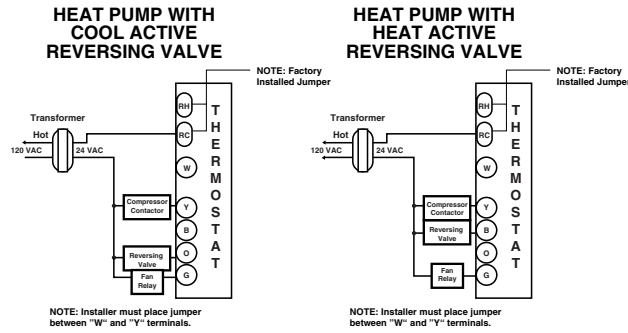

Five Year Limited Warranty

Maple Chase Company warrants to the original contractor installer or to the original consumer user, each new Maple Chase thermostat to be free from defects in materials and workmanship under normal use and service for a period of five (5) years from date of purchase. This warranty does not cover batteries, damage caused by batteries, damage resulting from improper installation, alteration, misuse or abuse of the thermostat occurring after the date of purchase.

Maple Chase Company agrees to repair or replace at its option any thermostat under warranty provided it is returned within the warranty period, postage prepaid, with proof of the date of purchase. Cost of thermostat removal or reinstallation is not the responsibility of Maple Chase Company.

Repair or replacement as provided under this warranty is the exclusive remedy of the consumer. **Maple Chase Company** shall not be liable for any incidental or consequential damages for breach of any express or implied warranty on this product, or under any other theory of liability. Except to the extent prohibited by applicable law, any implied warranty of merchantability or fitness for a particular purpose on this product is limited to the duration of this warranty.

Some states do not allow the exclusion or limitation of incidental or consequential damages, or allow limitations on how long an implied warranty lasts, so the above limitations or exclusions may not apply to you. This warranty gives you specific legal rights, and you may also have other rights which vary from state to state.

Maple Chase Company
 2820 Thatcher Road
 Downers Grove, Illinois 60515
 United States of America

An Invensys company

©1999 Maple Chase Company