

# Architectural Door Accessories

**ASSA ABLOY**

The global leader in  
door opening solutions

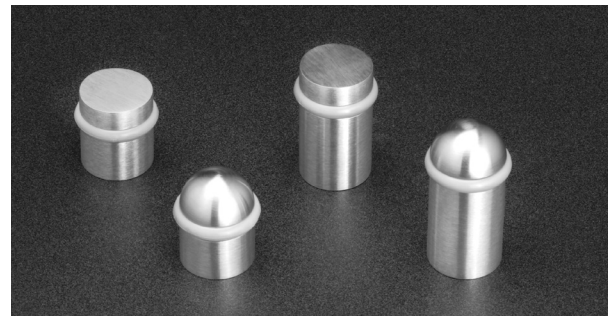
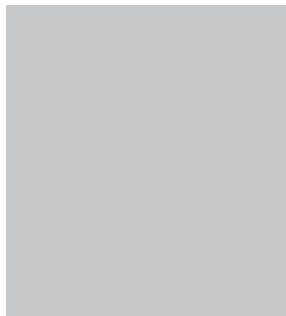

## Rockwood Products Price Book - Architectural Series

USA: Prices Effective May 1, 2018  
Canada: Prices Effective May 7, 2018

## Table of Contents

<b>General Information</b>	<b>2-5</b>	OvalTek (flat oval grip)	15
Numeric Index	3	PlanTek (flat front pulls)	38
Ordering Information	4	RightAngles (w/ or w/o GripZone)	7
Post Mounted Pulls/General Information	5	SculpTrex (shaped cast pulls)	37
<b>Architectural Pulls</b>	<b>6-55</b>	SkewTek (angled end pulls)	35
AccenTek (solid pulls with accents)	37	SoftMet (*Santoprene™ grip)	16
AccenTek Solid Groove Pulls	37	SoftTek (Santoprene™ grip)	16
ArborMet (wood grip pulls)	33	Traditional (decorative pulls & plates)	39
ArborTek (wood grip pulls)	34	Tubular (1 ¼" and 1 ½" diameter pulls)	6
BandWidth (collar mount pulls)	14	<b>Leather Architectural Pulls</b>	<b>40-47</b>
CenTrex (shaped pulls)	36	English Bridle Leather (straight & offset pulls)	40-41
Classic (finial pulls)	39	Flush Leather Pulls	44-46
Edge Pulls (for closet doors)	8	Leather Oval (ergonomic pulls)	44
Flush Pulls	7	Upholstery Leather GeoMetek	46
GeoMetek (diamond & narrow profile pulls)	49	Upholstery Leather (straight & offset pulls)	42-43
Groove (straight & offset pulls)	17	<b>Small Architectural Pulls</b>	<b>7-47</b>
LineaMax (long grooved pulls)	25-28	ArborMet	12
LineaMet (contrasting grooved pulls)	22-23	GripZone	11
LineaTek (fully grooved pulls)	24-25	Groove	11
Locking Door Pull System	50-51	Leather	47
MariTek (tapered pulls)	39	MegaTek	10-11
MegaCurve (long curved pulls)	12	NoirMet	12
MegaTek (straight & offset pulls)	18-20	Wire	7
MezzoTek (necked post pulls)	13	<b>Architectural Accessories</b>	<b>8-9</b>
NeoCylinder (w/ or w/o GripZone)	48	Coat Hooks	8
NeoMax (long pulls w/GripZone)	21-22	Door Stops	8
NeoMetrix (w/GripZone)	17	Push Plates, Pull Plates and Signage	9
NeoMitre (w/ or w/o GripZone)	48	<b>Architectural Finishes</b>	<b>53</b>
NoirMet (black anodized grip)	29-30	<b>Mounting Types</b>	<b>54</b>
NoirTek (black anodized grip)	31-32	<b>Mounting Details</b>	<b>55-56</b>
OvalTek (true oval grip)	15	<b>Fasteners - Spare Parts</b>	<b>57-59</b>
		<b>Mounting Kits</b>	<b>60</b>
		<b>Discontinued Products</b>	<b>61</b>

\*Santoprene™ is a registered trademark of the Exxon Mobil Corporation.

## ASSA ABLOY

The global leader in  
door opening solutions

USA: Prices Effective May 1, 2018 • Canada: Prices Effective May 7, 2018

Copyright © 2018, ASSA ABLOY Accessories and Door Controls Group, Inc. All rights reserved. Reproduction in whole or in part without the express written permission of ASSA ABLOY Accessories and Door Controls Group, Inc. is prohibited.

## Numeric Index

No.	Description	Page
570	Dust Proof Strike.....	52
DP3301	MegaTek Dummy Pull (round).....	52
DP3401	NeoTek Dummy Pull.....	52
DP7901	GeoMetek Dummy Pull (square)....	52
LP3301	Locking Pull PostMount.....	50
LP3401	Locking Pull NeoTek.....	50
LP6061	Locking Pull English Bridle Leather Wrapped.....	51
LP6161	Locking Pull Upholstery Leather Wrapped.....	51
LP6440	Locking Pull Upholstery Leather Wrapped.....	52
LP7901	Locking Pull GeoMetek.....	52
LPS01 - LPS06	Locking Pull Strikes.....	52
RM201 - RM372	Tubular.....	6
RM405 - RM423	RightAngles.....	7
RM710 - RM735	Small Pulls (Wire).....	7
RM751 - RM760	Edge Pulls - for Closet Doors.....	8
RM780 - RM785	Flush Pulls.....	7
RM801 - RM843	Coat Hooks.....	9
RM850 - RM877	Door Stops.....	9
RM1010 - RM1160	Push Plates, Pull Plates, and Signage.....	9
RM1200 - RM1270	Small Pulls (MegaTek, Groove).....	10
RM1300 - RM1370	Small Pulls (GripZone).....	11
RM1410 - RM1470	Small Pulls (NoirMet).....	12
RM1510 - RM1570	Small Pulls (ArborMet).....	12
RM2000 - RM2034	MegaCurve.....	12
RM2110 - RM2150	MezzoTek.....	13
RM2200 - RM2244	BandWidth.....	14
RM2300 - RM2330	OvalTek (true oval).....	15
RM2400 - RM2420	OvalTek (flat oval).....	15
RM2510 - RM2544	SoftMet.....	16
RM2610 - RM2640	SoftTek.....	16

No.	Description	Page
RM3010 - RM3060	NeoMetrix.....	17
RM3100 - RM3154	See RM3300-RM3342	
RM3101 - RM3131	Groove.....	17
RM3300 - RM3342	MegaTek.....	18-20
RM3400 - RM3442	NeoMax.....	21-22
RM3510 - RM3554	LineaMet.....	22-23
RM3610 - RM3654	LineaTek.....	24-25
RM3701 - RM3782	LineaMax.....	25-28
RM3800 - RM3854	NoirMet.....	29-30
RM3900 - RM3954	NoirTek.....	31-32
RM4000 - RM4054	ArborMet.....	33
RM4100 - RM4190	ArborTek.....	34-35
RM4200 - RM4274	SkewTek.....	35
RM4400 - RM4516RH	Centrex.....	36
RM4700 - RM4820	AccenTek.....	37
RM5032-RM5042	SculpTrex.....	37
RM5200 - RM5280	PlanTek.....	38
RM5500 - RM5598	Traditional.....	39
RM5650 - RM5670	Classic.....	39
RM5700 - RM5702	MariTek.....	39
RM6000 - RM6092	English Bridle Leather.....	40-41
RM6100 - RM6192	Upholstery Leather.....	42-43
RM6200 - RM6240	Leather Oval.....	44
RM6300 - RM6354	Flush Leather Pulls.....	44-46
RM6400 - RM6440	Upholstery Leather GeoMetek.....	46
RM6500 - RM6730	Small Pulls (Leather).....	47
RM7210 - RM7240	NeoCylinder.....	48
RM7300 - RM7450	NeoMitre.....	48
RM7800 - RM7815	GeoMetek (Diamond).....	49
RM7900 - RM7960	GeoMetek.....	49
SP1001 - SP1082	Fasteners - Spare Parts.....	57-59
KIT1 - KITRM380G	Mounting Kits.....	60

## Ordering Information

This price list cancels and supersedes all prior listings.

Orders are accepted with the understanding that they will be billed at prices in effect at time of shipment.

Prices are subject to change without notice.

We reserve the right to decline the whole or part of orders in which the price or quantity of goods is not acceptable to us.

## Easy Order Placement

### USA:

By Phone: 1-800-458-2424 Monday through Thursday 8:00 am ET to 7:00 pm ET, Friday 8:00 am ET to 4:30 pm ET

By Fax: Orders may be faxed to 1-800-922-9212

By Email: [orders.rockwood@assaabloy.com](mailto:orders.rockwood@assaabloy.com)

By Internet: <http://extranet.assaabloydss.com/> and select Order Entry under the Customer Service Menu

### Canada:

By Phone: 1-800-461-3007 Monday through Friday 8:00 am ET to 4:30 pm ET

By Fax: Orders may be faxed to 1-800-461-8989

By Email: [cavau-orders@assaabloy.com](mailto:cavau-orders@assaabloy.com)

By Internet: <http://extranet.assaabloydss.ca/> and select Order Entry under the Customer Service Menu

## Terms and Conditions of Sale

Terms: 1% 15 days, net 30 days

Remit Payment To: PNC Bank/Rockwood, PO Box 644489, Pittsburgh, PA 15264-4489

For Terms & Conditions and Warranty information pertaining to product sales in Canada, please visit [www.assaabloy.ca/terms](http://www.assaabloy.ca/terms)

## Freight Policy

Freight Allowance: All prices are F.O.B. Rockwood, Pennsylvania and/or Ventura, California. Full freight will be allowed on shipments of \$1,000 net and over within the continental limits of the United States (excluding Alaska and Hawaii). All shipments are routed most cost effective route of our choice. We reserve the right to designate the carrier.

## Special Order Material

Special items made to your specifications are not returnable. These items are not subject to cancellation without consideration of expense involved at the cancellation date.

## Samples

Salable samples will be charged at regular prices.

## Returned Goods

Return no merchandise without written permission from the factory. Authorization will insure your receiving proper credit. Errors in shipping may occasionally occur. If this is the case immediately notify the factory, and we will gladly make the proper adjustments. If the error is at the customer's end, a minimum charge of 25% plus freight will be incurred for handling. Unauthorized claims for labor or charges will not be allowed. No credit will be allowed beyond six months after invoice date.

## Shortages

Claims for shortages must be made within 30 days of invoice date.

## Templates

Upon request we will furnish templates for any of our standard items of manufacture. Commonly used templates are available on our website at [www.assaabloydooraccessories.us](http://www.assaabloydooraccessories.us).

## Product Weight Information

NOTE: Weights indicated throughout the price list are approximate for brass, bronze or stainless steel base material. Aluminum base materials weigh approximately  $\frac{1}{3}$  the listed weights.

## Engraving

Engraving may be added on many pulls and plates. Call factory for pricing.

**For Terms and Conditions as well as Warranty information pertaining to product sales in Canada, please visit [www.assaabloy.ca/terms](http://www.assaabloy.ca/terms)**

# ASSA ABLOY

The global leader in  
door opening solutions

USA: Prices Effective May 1, 2018 • Canada: Prices Effective May 7, 2018

Copyright © 2018, ASSA ABLOY Accessories and Door Controls Group, Inc. All rights reserved. Reproduction in whole or in part without the express written permission of ASSA ABLOY Accessories and Door Controls Group, Inc. is prohibited.

## Post Mounted Pulls

It is our goal that you get the best possible functional and aesthetic door pull from our wide selection. On long door pulls there will naturally be a small amount of flexing between mounting points that are far apart. We offer the following guidelines to help you determine when a mid-post is required or when you should consider altering the location of the mounting posts (by moving them closer together) in order to minimize the flexing of the grip. Making the grip rigid by adding a mid-post is the ideal condition for long pulls on all doors but is particularly important on all glass doors that have an inherent flexing in the door itself. The combined flexing of the door and the pull can loosen mechanical joints and stress the fasteners.

Our recommendations for adding a mid-post to long door pulls is based on a theoretical pull load of 30 lbs. (foot pounds) maximum to open the door, which is a greater than the typical force required to open an average door. The maximum amount of deflection of the grip you will see at that force is  $\frac{3}{8}$ ". The conditions on your job site can vary due to door weight, wind loading, closer settings, locked doors being aggressively pulled and other circumstances. It is our recommendation that you add a mid-post if there is any question about heavy or hard to open doors; having an extra mounting point always makes for a more stable and durable installation.

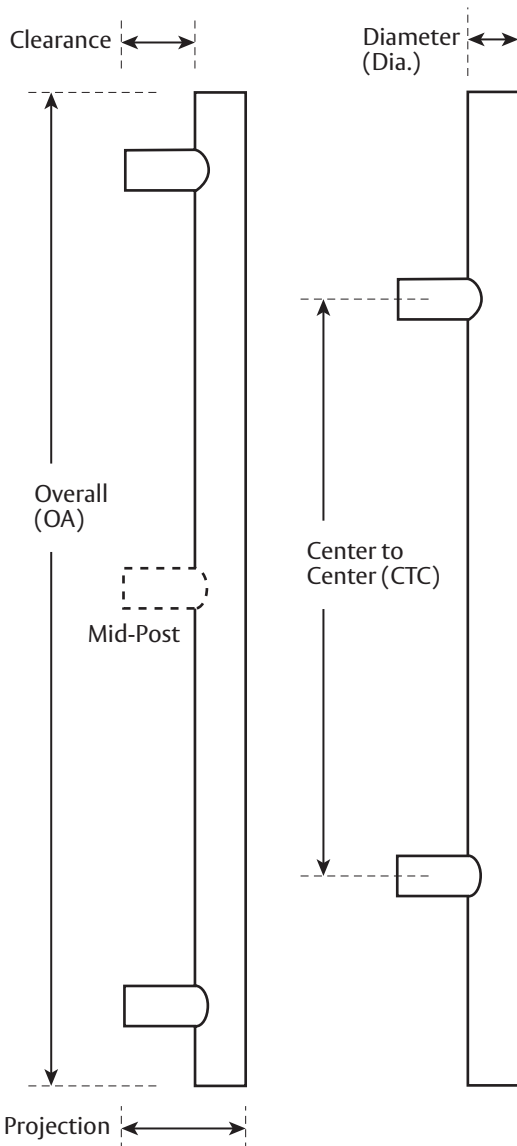

On long pulls, post can be positioned closer to each other and farther away from ends as a strategy to avoid mid-post if door condition permits.

POST MOUNTED PULLS SHAPES AND SIZES			
SHAPE	MATERIAL	MATERIAL Size	MAXIMUM CTC
<b>Round</b>			
	Stainless Steel	1"	70"
		1 1/4"	90"
		1 1/2"	110"
	Brass/Bronze	1"	57"
		1 1/4"	73"
		1 1/2"	87"
Aluminum	1"	66"*	
	1 1/4"	90"*	
	1 1/2"	115"*	
<b>Oval</b>			
	Stainless Steel	1" x 1 1/2"	100"
		1" x 1 7/8"	119"
<b>Flat Oval</b>			
	Stainless Steel	3/4" x 1 1/2"	93"
<b>Square</b>			
	Stainless Steel	3/4" x 3/4"	62"
<b>Rectangular</b>			
	Stainless Steel	1/2" x 1 1/4"	86"
		3/4" x 1 1/2"	110"
	Brass/Bronze	3/4" x 1 1/2"	89"
<b>Rectangular</b>			
	Stainless Steel	1/2" x 1 1/4"	52"
		3/4" x 1 1/2"	75"
	Brass/Bronze	3/4" x 1 1/2"	60"

\*The maximum length of anodized aluminum pulls is 87" due to our tank size. Longer aluminum pulls are available in satin finish and clear coated or powder coat paint.

**ASSA ABLOY**

The global leader in door opening solutions

Tubular - 1 1/4" & 1 1/2" Diameter Pulls

Straight Pulls											
Part	CTC	Dia.	28/628	313/710 315/711	3/605 4/606	10/612 10B/613	Stock PC 10BE	32D/630	32/629	32D316	32316
RM301	12"	1 1/4"	133	147	339	366	187	134	150	180	201
RM302	18"	1 1/4"	149	165	360	388	207	154	173	207	231
RM303	24"	1 1/4"	165	182	380	410	227	174	195	234	262
RM304	36"	1 1/4"	197	217	420	455	298	214	240	287	320
RM321	12"	1 1/2"	149	164	412	445	220	167	187	224	250
RM322	18"	1 1/2"	165	182	432	467	240	187	210	251	280
RM323	24"	1 1/2"	181	199	452	489	259	207	232	277	310
RM324	36"	1 1/2"	213	235	493	532	331	247	276	331	370

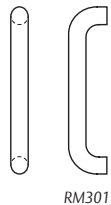

RM301

90° Offset Pulls											
RM201	12"	1 1/4"	152	173	258	272	215	163	200	209	243
RM202	18"	1 1/4"	166	189	287	301	234	182	219	230	264
RM203	24"	1 1/4"	179	204	316	331	252	200	236	257	292
RM204	36"	1 1/4"	210	233	380	395	308	224	262	284	320
RM221	12"	1 1/2"	196	215	309	331	240	187	236	250	279
RM222	18"	1 1/2"	210	225	344	360	296	212	262	284	317
RM223	24"	1 1/2"	225	240	387	401	319	235	288	315	351
RM224	36"	1 1/2"	255	270	457	473	349	265	318	355	395

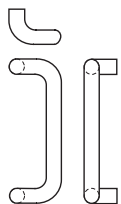

RM201

Push Bars - Add \$6/in. per bar for extra length bars over 36".											
RM350	Up to 36"	1 1/4"	196	219	287	309	240	187	210	251	257
RM370	Up to 36"	1 1/2"	225	247	344	372	313	229	256	307	342

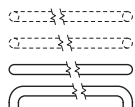

RM350

Straight Push Pull Sets - Specify Push Bar CTC. Add \$6/in. per bar for extra length bars over 36".											
RM351	12"	1 1/4"	310	349	505	544	424	340	382	456	468
RM352	18"	1 1/4"	319	355	534	576	436	352	394	472	481
RM371	12"	1 1/2"	385	422	606	654	484	400	448	535	598
RM372	18"	1 1/2"	407	443	625	675	530	424	475	569	635

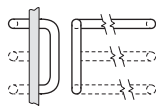

RM352

Offset Push Pull Sets - Specify Push Bar CTC. Add \$6/in. per bar for extra length bars over 36".											
RM251	12"	1 1/4"	364	407	561	606	450	366	410	489	516
RM252	18"	1 1/4"	377	422	590	637	466	382	428	512	535
RM271	12"	1 1/2"	436	473	669	722	536	431	482	576	642
RM272	18"	1 1/2"	454	489	704	761	560	455	508	608	678

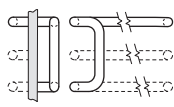

RM251

Heavy Duty 30° Offset Pulls											
Part	CTC	Dia.	28/628	313/710 315/711	3/605 4/606	10/612 10B/613	Stock PC 10BE	32D/630	32316	32/629	32D316
RM257	10"	1 1/4"	159	173	348	376	320	236	264	315	347
RM258	12"	1 1/4"	173	189	372	402	341	257	289	344	368
RM259	18"	1 1/4"	179	196	411	444	368	284	317	380	398

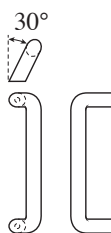

RM257

NOTE: Engraving "Push" or "Pull" add \$103.00 (1/2" letter height).

NOTE: Post location on push bars can be located 1/8" from end for narrow & medium stile doors and 1" from end for flush and wide stile doors.

## RightAngles - with or without GripZone

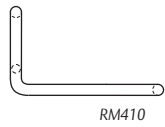

RM410

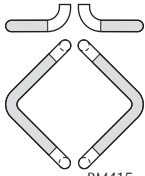

RM415

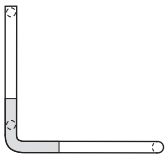

RM422

Without GripZone (RM410-RM413 specify handing and height x width when ordering.)									
Part	28/628	313/710 315/711	3/605 4/606	10/612 10B/613	Stock PC 10BE	32D/630	32/629	32D316	32316
RM405-15	241	272	391	423	333	211	238	281	318
RM410 (leg up)	497	571	837	904	619	436	501	581	668
RM411 (leg down)	497	571	837	904	619	436	501	581	668
RM412 (leg up)	843	964	946	1022	964	739	846	987	1129
RM413 (leg down)	843	964	946	1022	964	739	846	987	1129
With GripZone (RM420-RM423 specify handing and height x width when ordering.)									
Part	3/605	9/611	32/629	32316					
RM415-15	538	621	405	737					
RM420 (leg up)	1058	1213	792	1437					
RM421 (leg down)	1058	1213	792	1437					
RM422 (leg up)	1367	1572	1012	1864					
RM423 (leg down)	1367	1572	1012	1864					

## Small Pulls - for Cabinets, Casework and Closets

Wire Pulls - without base plates								
Part	CTC	Dia.	3/605 4/606	10B/613	Stock PC 10BE	26/625 26D/626	32D/630	32/629
RM710-4	4"	3/8"	34	37	35	34	22	24
RM710-5	5"	3/8"	35	38	36	35	23	25
RM710-6	6"	3/8"	37	40	38	38	24	27
RM720-4	4"	1/2"	41	45	40	41	24	27
RM720-5	5"	1/2"	42	46	42	42	25	30
RM720-6	6"	1/2"	43	47	44	43	27	32
RM730-5	5"	5/8"	48	51	46	48	30	33
RM730-6	6"	5/8"	49	52	47	49	31	34
RM730-7	7"	5/8"	50	55	48	50	32	35
Wire Pulls - with base plates								
RM715-4	4"	3/8"	52	56	55	52	40	45
RM715-5	5"	3/8"	55	59	57	55	43	47
RM715-6	6"	3/8"	56	60	58	58	44	50
RM725-4	4"	1/2"	63	67	61	63	45	51
RM725-5	5"	1/2"	64	68	62	64	46	52
RM725-6	6"	1/2"	65	71	63	65	47	53
RM735-5	5"	5/8"	68	74	63	68	47	53
RM735-6	6"	5/8"	71	76	66	71	49	55
RM735-7	7"	5/8"	72	78	67	72	50	56

## Flush Pulls

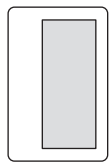

RM782

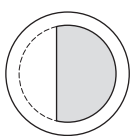

RM785

Flush Pulls					
Part	Size	3/605 4/606	10B/613	Stock PC 10BE	26/625 26D/626
RM780	2 3/16" x 3 1/4"	36	39	39	39
RM782	2 11/16" x 4 3/16"	39	41	41	41
RM785	3 1/2" Dia.	49	52	51	51

Edge Pulls - for Closet Doors

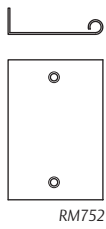

Square Edge Door						
Part	Max OA	3/605 4/606	10/612 10B/613	Stock PC 10BE	32D/630	32/629
RM751	Up to 12"	89	96	87	71	78
RM752	Up to 12"	92	99	89	73	81
Bevel Edge Door						
RM753	Up to 12"	94	102	91	75	84
RM754	Up to 12"	96	104	94	78	88



Double Edge Pull - Square Edge						
Part	Max OA	3/605 4/606	10/612 10B/613	Stock PC 10BE	32D/630	32/629
RM755	Up to 12"	176	190	156	140	157
Concealed Edge Pull						
Part	Max OA	Size	3/605 4/606	10/612 10B/613	Stock PC 10BE	26/625 26D/626
RM760	Up to 12"	1" x 4 1/4"	48	51	49	51

- Specifying Information: 1. Select style pull number; 2. Select standard length [2", 2 1/2", 3", 4", 5", 6", 12" (max)]; 3. Specify door thickness [Example: RM752-4" 32D 1 3/4" door]

Coat Hooks

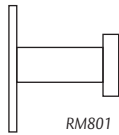

Part	Size	3/605 4/606	10B/613	Stock PC 10BE	26/625 26D/626	32D/630
RM801	1 1/4" x 1 3/4"	62	66	64	65	50
RM802	1 1/4" x 2 3/4"	63	67	65	66	52
RM803	1" x 2"	62	66	64		63
RM804	1" x 3"	63	67	65		64
RM805	1" x 1 3/4"	77	84	81	84	
RM806	1" x 3"	84	92	88	92	
RM807	1 1/4" x 2 3/4"	94	102	98	102	
RM808	1 1/4" x 3 1/2"	102	110	106	108	
RM811	3/4" x 1 1/2"	42	45	43	42	
RM812	1 1/4" x 2 1/4"	44	47	45	44	

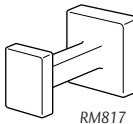

Part	Size	Stock PC 10BE	15/619
RM817	Square 1 3/4", 2 11/16" Projection	48	48

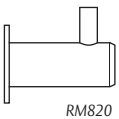

Part	Size	3/605 4/606	10B/613	Stock PC 10BE	26/625 26D/626	32D/630
RM820	1/2" x 1 5/8"			49		38
RM821	5/8" x 2 1/8"			50		39
RM822	1/2" x 1 1/2"			36		26
RM823	5/8" x 2"			37		27

Part	Size	3/605 4/606 10B/613	Stock PC 10BE	26/625 26D/626	32D/630	32/629
RM828	3/4"W x 2 7/8"	73	58		50	68
RM829	3/4"W x 1 7/8"	66	56		62	51

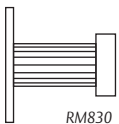

LineaMet Coat Hooks					
Part	Size	Stock PC 10BE	32D/630	32/629	
RM830 (w/base plate)	1 1/4" x 2 1/4"	75	58	62	
RM831	5/8" x 2 1/8"	75	58	62	

ArborMet Coat Hooks					
Part	Size	Stock PC 10BE	32D/630	32/629	
RM835 (w/base plate)	1 1/4" x 2 1/4"	75	58	62	
RM836	5/8" x 2 1/8"	75	58	62	



SoftMet Coat Hooks					
Part	Size	Stock PC 10BE	32D/630	32/629	
RM838 (w/base plate)	1 1/4" x 2 1/4"	75	58	62	
RM839	5/8" x 2 1/8"	75	58	62	

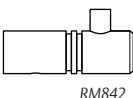

Groove Coat Hooks					
Part	Size	Stock PC 10BE	32D/630	32/629	
RM840 (w/base plate)	1/2" x 1 5/8"	62	45		
RM841 (w/base plate)	5/8" x 2 1/8"	65	49		
RM842	1/2" x 1 1/2"	54	38		
RM843	5/8" x 2"	56	40		



**Door Stops**

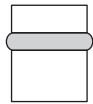

RM850

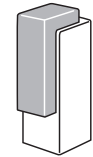

RM857

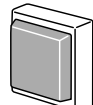

RM867

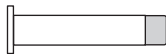

RM876

Floor Mounted						
Part	Height	3/605 4/606	10/612 10B/613	Stock PC 10BE	26/625 26D/626	32D/630
RM850	1 1/2"	41	45	43	38	37
RM851	2 1/2"	52	57	55	52	48
RM855	1 3/4"	46	49	47	42	42
RM856	2 3/4"	56	60	58	56	50
Part	Size			Stock PC 10BE	15/619	
RM857	Square 1" Base, 2 3/4" Projection			58	58	
Wall Mounted						
Part	Projection	3/605 4/606	10/612 10B/613	Stock PC 10BE	26/625 26D/626	32D/630
RM860	1 3/2"	26	29	27	25	22
RM861	1 3/2"	26	29	27	25	22
Part	Size			Stock PC 10BE	15/619	
RM867	Square 1 3/4" Base, 3/4" Projection			46	46	
Base Board Mounted						
Part	Projection	3/605 4/606	10/612 10B/613	Stock PC 10BE	26/625 26D/626	32D/630
RM870	1 1/2"	37	40	38	34	25
RM871	3 1/4"	37	40	38	34	25
RM872	3 3/4"	37	40	38	34	25
RM875	1 1/2"	51	55	52	51	38
RM876	3 1/4"	51	55	52	51	38
RM877	3 3/4"	51	55	52	51	38

**Push Plates, Pull Plates and Signage**



RM1010



RM1030



RM1120H



RM1120L

Square Corner - Adhesive Mount						
Part	Size	3/605 4/606	10/612 10B/613	Stock PC 10BE	32D/630	32/629
RM1010	4" x 22"				55	61
RM1010H	4" x 22"				82	92
RM1010L	4" x 22"				82	92
Square Corner - Screw Mount						
RM1020	4" x 22"	83	90	62	40	46
RM1020H	4" x 22"	116	126	91	69	78
RM1020L	4" x 22"	116	126	91	69	78
Radius End Corner - Adhesive Mount						
RM1030	4" x 22"				69	78
RM1030H	4" x 22"				97	109
RM1030L	4" x 22"				97	109
Radius End Corner - Screw Mount						
RM1040	4" x 22"	100	110	76	55	61
RM1040H	4" x 22"	132	144	104	82	92
RM1040L	4" x 22"	132	144	104	82	92
Indicator Plates - Adhesive Mount						
Part	Size	3/605 4/606	10/612 10B/613	Stock PC 10BE	32D/630	32/629
RM1110H	1" Dia.	68	78	74	58	64
RM1110L	1" Dia.	68	78	74	58	64
RM1120H	2 1/2" Dia.	68	78	74	58	64
RM1120L	2 1/2" Dia.	68	78	74	58	64
RM1150M	2" x 4"	73	84	79	64	73
RM1150W	2" x 5 3/4"	76	87	81	67	75
Indicator Plates - Screw Mount						
RM1160M	2" x 4"	73	84	79	64	73
RM1160W	2" x 5 3/4"	76	87	81	67	75

**ASSA ABLOY**

The global leader in door opening solutions

MegaTek - Small Pulls for Cabinets, Casework & Closet Doors

SMALL PULLS (MEGATEK, GROOVE)

Straight - Flat Ends								
Part	Max OA	Dia.	3/605 4/606	10/612	10B/613	Stock PC 10BE	32D/630	32/629
RM1200-4	5 7/8"	1/2"	55		59	46	24	27
RM1200-5	6 7/8"	1/2"	56		62	47	25	28
RM1200-6	7 7/8"	1/2"	57		63	58	36	42
RM1200-8	9 7/8"	1/2"	60		65	62	40	45
RM1200-10	11 7/8"	1/2"	64		68	66	44	48
RM1200-12	13 7/8"	1/2"	72		79	69	47	53
RM1200-18	19 7/8"	1/2"	96		104	72	50	57
RM1200-24	25 7/8"	1/2"	110		119	83	61	69
RM1200-30	31 7/8"	1/2"	130		140	93	71	79
RM1210-5	6 7/8"	5/8"	73		78	57	35	39
RM1210-6	7 7/8"	5/8"	74		79	61	39	44
RM1210-7	8 7/8"	5/8"	74		80	67	45	50
RM1210-8	9 7/8"	5/8"	76		83	69	47	53
RM1210-10	11 7/8"	5/8"	86		94	70	48	55
RM1210-12	13 7/8"	5/8"	92		99	72	50	57
RM1210-18	19 7/8"	5/8"	127		137	87	66	74
RM1210-24	25 7/8"	5/8"	145		156	97	75	85
RM1210-30	31 7/8"	5/8"	173		188	104	82	91
Offset - Flat Ends								
RM1230-5	6 7/8"	5/8"				96	74	83
RM1230-6	7 7/8"	5/8"				97	75	84
RM1230-7	8 7/8"	5/8"				99	78	86
RM1230-8	9 7/8"	5/8"				103	81	91
RM1230-10	11 7/8"	5/8"				104	82	92
RM1230-12	13 7/8"	5/8"				106	84	94
RM1230-18	19 7/8"	5/8"				128	95	107
RM1230-24	25 7/8"	5/8"				141	108	120
RM1230-30	31 7/8"	5/8"				145	112	126
Straight - Round Ends								
RM1240-4	5 7/8"	1/2"	65	71	71	64	43	48
RM1240-5	6 7/8"	1/2"	66	72	72	66	44	49
RM1240-6	7 7/8"	1/2"	67	73	73	67	45	50
RM1240-8	9 7/8"	1/2"	70	76	76	70	48	53
RM1240-10	11 7/8"	1/2"	72	79	79	74	52	59
RM1240-12	13 7/8"	1/2"	78	83	83	79	57	63
RM1240-18	19 7/8"	1/2"	100	110	110	94	61	68
RM1240-24	25 7/8"	1/2"	118	127	127	100	68	76
RM1240-30	31 7/8"	1/2"	132	144	144	111	79	87
RM1250-5	6 7/8"	5/8"	78		83	74	52	59
RM1250-6	7 7/8"	5/8"	80		86	75	53	60
RM1250-7	8 7/8"	5/8"	82		89	76	55	61
RM1250-8	9 7/8"	5/8"	84		91	78	56	62
RM1250-10	11 7/8"	5/8"	94		100	80	58	64
RM1250-12	13 7/8"	5/8"	98		107	82	60	67
RM1250-18	19 7/8"	5/8"	130		142	93	71	80
RM1250-24	25 7/8"	5/8"	150		161	104	82	93
RM1250-30	31 7/8"	5/8"	176		189	109	87	97
Offset - Round Ends								
RM1270-5	6 7/8"	5/8"				106	85	94
RM1270-6	7 7/8"	5/8"				107	85	95
RM1270-7	8 7/8"	5/8"				108	86	96
RM1270-8	9 7/8"	5/8"				110	88	98
RM1270-10	11 7/8"	5/8"				111	90	100
RM1270-12	13 7/8"	5/8"				114	92	103
RM1270-18	19 7/8"	5/8"				128	106	118
RM1270-24	25 7/8"	5/8"				136	115	128
RM1270-30	31 7/8"	5/8"				141	119	133

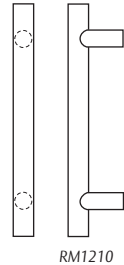

RM1210

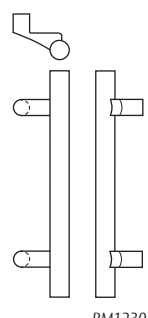

RM1230

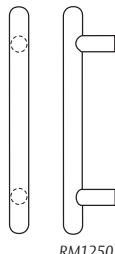

RM1250

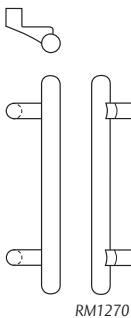

RM1270

RM1200-RM1270

**ASSA ABLOY**

The global leader in door opening solutions

**Groove - Small Pulls**

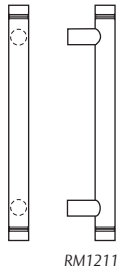

Straight - Flat Ends							
Part	Max OA	Dia.	3/605 4/606	10/612 10B/613	Stock PC 10BE	32D/630	32/629
RM1211-5	6 7/8"	5/8"	81	87	74	52	59
RM1211-6	7 7/8"	5/8"	82	88	75	53	60
RM1211-7	8 7/8"	5/8"	83	89	76	55	61
RM1211-8	9 7/8"	5/8"	84	91	78	56	62
RM1211-10	11 7/8"	5/8"	92	99	79	57	63
RM1211-12	13 7/8"	5/8"	97	106	82	60	67

**GripZone - Small Pulls for Cabinets, Casework & Closet Doors**

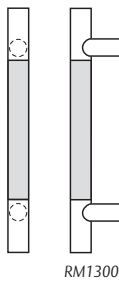

Straight - Flat Ends			
Part	Max OA	Dia.	32/629
RM1300-4	5 7/8"	1/2"	61
RM1300-5	6 7/8"	1/2"	62
RM1300-6	7 7/8"	1/2"	63
RM1300-8	9 7/8"	1/2"	64
RM1300-10	11 7/8"	1/2"	67
RM1300-12	13 7/8"	1/2"	72
RM1300-18	19 7/8"	1/2"	76
RM1300-24	25 7/8"	1/2"	87
RM1300-30	31 7/8"	1/2"	96

Straight - Flat Ends			
RM1310-5	6 7/8"	5/8"	69
RM1310-6	7 7/8"	5/8"	70
RM1310-7	8 7/8"	5/8"	71
RM1310-8	9 7/8"	5/8"	72
RM1310-10	11 7/8"	5/8"	74
RM1310-12	13 7/8"	5/8"	76
RM1310-18	19 7/8"	5/8"	92
RM1310-24	25 7/8"	5/8"	102
RM1310-30	31 7/8"	5/8"	114

Offset - Flat Ends			
RM1330-5	6 7/8"	5/8"	102
RM1330-6	7 7/8"	5/8"	103
RM1330-7	8 7/8"	5/8"	104
RM1330-8	9 7/8"	5/8"	108
RM1330-10	11 7/8"	5/8"	110
RM1330-12	13 7/8"	5/8"	114
RM1330-18	19 7/8"	5/8"	126
RM1330-24	25 7/8"	5/8"	138
RM1330-30	31 7/8"	5/8"	147

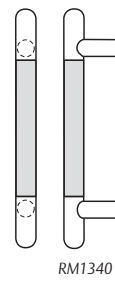

Straight - Round Ends			
Part	Max OA	Dia.	32/629
RM1340-4	5 7/8"	1/2"	70
RM1340-5	6 7/8"	1/2"	71
RM1340-6	7 7/8"	1/2"	72
RM1340-8	9 7/8"	1/2"	74
RM1340-10	11 7/8"	1/2"	76
RM1340-12	13 7/8"	1/2"	84
RM1340-18	19 7/8"	1/2"	90
RM1340-24	25 7/8"	1/2"	96
RM1340-30	31 7/8"	1/2"	108

Straight - Round Ends			
RM1350-5	6 7/8"	5/8"	81
RM1350-6	7 7/8"	5/8"	82
RM1350-7	8 7/8"	5/8"	83
RM1350-8	9 7/8"	5/8"	84
RM1350-10	11 7/8"	5/8"	87
RM1350-12	13 7/8"	5/8"	90
RM1350-18	19 7/8"	5/8"	102
RM1350-24	25 7/8"	5/8"	114
RM1350-30	31 7/8"	5/8"	122

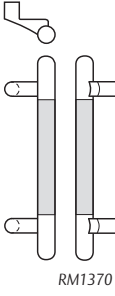

Offset - Round Ends			
RM1370-5	6 7/8"	5/8"	114
RM1370-6	7 7/8"	5/8"	115
RM1370-7	8 7/8"	5/8"	116
RM1370-8	9 7/8"	5/8"	118
RM1370-10	11 7/8"	5/8"	120
RM1370-12	13 7/8"	5/8"	122
RM1370-18	19 7/8"	5/8"	138
RM1370-24	25 7/8"	5/8"	147
RM1370-30	31 7/8"	5/8"	159

SMALL PULLS (w/GRIPZONE)

RM1211-RM1370

**ASSA ABLOY**

The global leader in door opening solutions



NoirMet - Small Pulls

Straight - Flat Ends							
Part	Max OA	Dia.	3/605 4/606	10B/613	Stock PC 10BE	32D/630	32/629
RM1410-5	6 7/8"	5/8"	127	138	93	71	79
RM1410-6	7 7/8"	5/8"	130	142	95	73	82
Offset - Flat Ends							
RM1430-5	6 7/8"	5/8"			134	112	127
RM1430-6	7 7/8"	5/8"			136	115	129
Straight - Round Ends							
RM1450-5	6 7/8"	5/8"	151	163	110	88	98
RM1450-6	7 7/8"	5/8"	154	165	114	92	102
Offset - Round Ends							
RM1470-5	6 7/8"	5/8"			153	131	147
RM1470-6	7 7/8"	5/8"			158	136	153

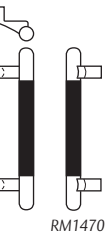

ArborMet - Small Pulls

Straight - Flat Ends							
Part	Max OA	Dia.	3/605 4/606	10B/613	Stock PC 10BE	32D/630	32/629
RM1510-5	6 7/8"	5/8"	134	145	97	75	86
RM1510-6	7 7/8"	5/8"	137	148	100	79	90
Offset - Flat Ends							
RM1530-5	6 7/8"	5/8"			141	119	135
RM1530-6	7 7/8"	5/8"			144	122	141
Straight - Round Ends							
RM1550-5	6 7/8"	5/8"	157	170	118	96	109
RM1550-6	7 7/8"	5/8"	161	173	121	99	114
Offset - Round Ends							
RM1570-5	6 7/8"	5/8"			160	139	158
RM1570-6	7 7/8"	5/8"			163	141	162

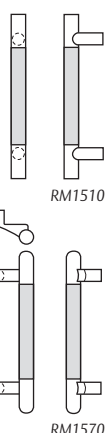

MegaCurve - Long Curved Pulls

Mid Bow								
Part	Max OA	3/605 4/606	10/612 10B/613	Stock PC 10BE	32D/630	32/629	32D316	32316
RM2000	72"	1778	1920	1274	1140	1277	1523	1699
	84"	1837	1984	1329	1196	1339	1598	1782
	96"	1896	2048	1385	1251	1402	1672	1865
RM2004	72"	1889	2040	1368	1235	1383	1650	1840
	84"	1948	2104	1424	1290	1445	1724	1923
	96"	2007	2167	1479	1346	1508	1798	2006
Long Bow Pulls								
RM2010	72"	2330	2516	1748	1614	1763	2103	2346
	84"	2388	2580	1803	1630	1825	2177	2429
	96"	2447	2643	1859	1685	1888	2252	2512
RM2014	72"	2443	2638	1842	1709	1914	2283	2546
	84"	2502	2702	1898	1764	1976	2357	2629
	96"	2560	2765	1953	1820	2038	2432	2712
45° Pulls								
RM2020	72"	1889	2040	1368	1235	1383	1650	1840
	84"	1948	2104	1424	1290	1445	1724	1923
	96"	2007	2167	1479	1346	1508	1798	2006
RM2024	72"	2000	2160	1463	1329	1489	1776	1981
	84"	2059	2223	1518	1385	1551	1850	2064
	96"	2117	2287	1574	1441	1613	1925	2147
Triangle Pulls								
RM2030	72"	1889	2040	1368	1235	1383	1650	1840
	84"	1948	2104	1424	1290	1445	1724	1923
	96"	2007	2167	1479	1346	1508	1798	2006
RM2034	72"	2000	2160	1463	1329	1489	1776	1981
	84"	2059	2223	1518	1385	1551	1850	2064
	96"	2117	2287	1574	1441	1613	1925	2147

• Add \$6.50/in. over 96".

**ASSA ABLOY**

The global leader in door opening solutions

## MezzoTek - Necked Post Pulls

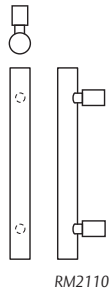

RM2110

Straight Pulls without GripZone									
Part	Max OA	Dia.	3/605 4/606	10/612 10B/613	Stock PC 10BE	32D/630	32/629	32D316	32316
RM2110	12"	1 1/4"	511	553	297	212	238	284	317
	24"	1 1/4"	553	597	350	265	297	355	396
	36"	1 1/4"	594	642	403	318	356	426	475
	48"	1 1/4"	635	686	456	371	416	497	555
	60"	1 1/4"	662	715	491	406	455	544	606
	72"	1 1/4"	689	745	547	441	494	591	658
RM2120	12"	1 1/2"	556	600	309	224	250	300	334
	24"	1 1/2"	597	645	362	277	310	370	413
	36"	1 1/2"	638	689	415	330	369	441	492
	48"	1 1/2"	680	734	468	383	429	512	571
	60"	1 1/2"	707	763	502	417	467	558	622
	72"	1 1/2"	734	793	558	452	506	605	675

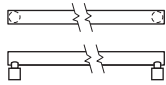

RM2112

Push Bars without GripZone									
RM2112	Up to 36" CTC	1 1/4"	594	642	403	318	356	426	475
RM2122	Up to 36" CTC	1 1/2"	638	689	415	330	369	441	492

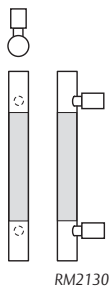

RM2130

Straight Pulls with GripZone									
Part	Max OA	Dia.	3/605	9/611	32/629	32316			
RM2130	12"	1 1/4"	620	701	344	513			
	24"	1 1/4"	661	747	403	602			
	36"	1 1/4"	702	794	463	690			
	48"	1 1/4"	744	840	522	778			
	60"	1 1/4"	771	872	561	837			
	72"	1 1/4"	798	902	600	896			
RM2140	12"	1 1/2"	664	751	356	467			
	24"	1 1/2"	706	798	416	546			
	36"	1 1/2"	747	844	475	625			
	48"	1 1/2"	788	890	535	702			
	60"	1 1/2"	815	922	573	752			
	72"	1 1/2"	842	952	612	804			

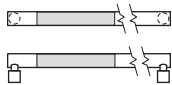

RM2132

Push Bars with GripZone									
RM2132	Up to 36" CTC	1 1/4"	702	794	463	690			
RM2142	Up to 36" CTC	1 1/2"	747	844	475	625			

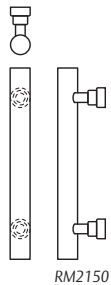

RM2150

Double Stepped Post Pulls									
Part	Max OA	Dia.	3/605 4/606	10/612 10B/613	Stock PC 10BE	32D/630	32/629	32D316	32316
RM2150	12"	1"	396	428	318	233	261	312	348
	24"	1"	459	496	371	286	321	383	427
	36"	1"	522	564	424	339	380	454	507
	48"	1"	585	632	477	393	440	525	586
	60"	1"	648	700	534	428	479	572	638
	72"	1"	711	768	569	463	518	619	690
RM2150	84"	1"	774	836	604	498	557	666	742
	96"	1"	837	904	639	533	596	713	795

- Add \$6.50/in. over 96".
- MP (Mid Post) - Add \$76 each (Recommended for maximum rigidity on long door pulls. See page 5 for guidelines.)
- Pulls with GripZone offer an additional aesthetic look, not a tactile feel. The grip zones are satin, the post and end sections are polished. US10B finish is not available on GripZone pulls.

NOTE: Post location on push bars can be located 1/8" from end for narrow & medium stile doors and 1" from end for flush and wide stile doors.

**ASSA ABLOY**

The global leader in  
door opening solutions

BandWidth - Collar Mount Pulls

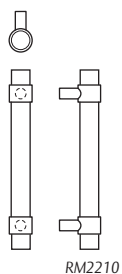

Straight Pulls - Flat Ends							
Part	Max OA	Dia.	3/605 4/606	10/612 10B/613	Stock PC 10BE	32D/630	32/629
<b>RM2200</b>	12"	1"	517	559	458	370	414
	24"	1"	602	649	500	412	462
	36"	1"	687	741	564	454	508
	48"	1"	771	833	606	496	555
	60"	1"	855	923	634	523	586
	72"	1"	939	1015	661	551	617
<b>RM2210</b>	12"	1 1/4"	554	598	471	382	429
	24"	1 1/4"	636	687	512	424	475
	36"	1 1/4"	718	776	576	466	522
	48"	1 1/4"	799	863	617	507	568
	60"	1 1/4"	881	952	645	535	598
	72"	1 1/4"	963	1039	672	562	629
<b>RM2214</b>	12"	1 1/4"	554	598	471	382	429
	24"	1 1/4"	636	687	512	424	475
	36"	1 1/4"	718	776	576	466	522
	48"	1 1/4"	799	863	617	507	568
	60"	1 1/4"	881	952	645	535	598
	72"	1 1/4"	963	1039	672	562	629

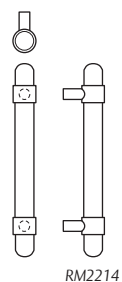

Offset Pulls - Flat Ends							
Part	Max OA	Dia.	3/605 4/606	10/612 10B/613	Stock PC 10BE	32D/630	32/629
<b>RM2230</b>	12"	1"	564	609	496	408	456
	24"	1"	648	701	560	450	504
	36"	1"	733	791	602	492	551
	48"	1"	818	883	644	533	597
	60"	1"	901	974	671	561	628
	72"	1"	986	1065	699	589	659
<b>RM2240</b>	12"	1 1/4"	601	648	508	420	471
	24"	1 1/4"	682	736	572	462	517
	36"	1 1/4"	764	826	614	504	564
	48"	1 1/4"	845	913	655	544	609
	60"	1 1/4"	928	1002	682	572	640
	72"	1 1/4"	1009	1090	710	600	671
<b>RM2244</b>	12"	1 1/4"	601	648	508	420	471
	24"	1 1/4"	682	736	572	462	517
	36"	1 1/4"	764	826	614	504	564
	48"	1 1/4"	845	913	655	544	609
	60"	1 1/4"	928	1002	682	572	640
	72"	1 1/4"	1009	1090	710	600	671

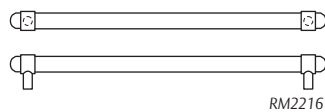
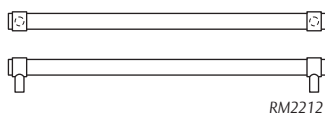
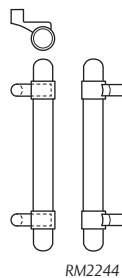
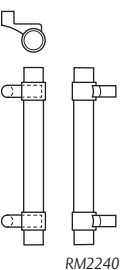

Straight Pulls - Round Ends							
Part	Max OA	Dia.	3/605 4/606	10/612 10B/613	Stock PC 10BE	32D/630	32/629
<b>RM2204</b>	12"	1"	616	665	503	414	464
	24"	1"	701	756	566	456	511
	36"	1"	785	848	608	498	558
	48"	1"	870	939	650	540	605
	60"	1"	953	1030	678	568	636
	72"	1"	1038	1122	705	595	667
<b>RM2214</b>	12"	1 1/4"	653	705	515	427	477
	24"	1 1/4"	734	793	579	468	525
	36"	1 1/4"	816	881	620	510	572
	48"	1 1/4"	898	970	661	551	617
	60"	1 1/4"	980	1059	689	579	648
	72"	1 1/4"	1061	1146	716	606	679
<b>RM2214</b>	12"	1 1/4"	653	705	515	427	477
	24"	1 1/4"	734	793	579	468	525
	36"	1 1/4"	816	881	620	510	572
	48"	1 1/4"	898	970	661	551	617
	60"	1 1/4"	980	1059	689	579	648
	72"	1 1/4"	1061	1146	716	606	679

Offset Pulls - Round Ends							
Part	Max OA	Dia.	3/605 4/606	10/612 10B/613	Stock PC 10BE	32D/630	32/629
<b>RM2234</b>	12"	1"	662	716	562	452	506
	24"	1"	747	806	604	494	553
	36"	1"	832	898	646	536	600
	48"	1"	916	989	688	578	647
	60"	1"	1000	1080	715	605	678
	72"	1"	1084	1171	743	633	709
<b>RM2244</b>	12"	1 1/4"	699	755	574	464	520
	24"	1 1/4"	781	843	616	506	566
	36"	1 1/4"	863	932	658	548	614
	48"	1 1/4"	944	1019	699	589	659
	60"	1 1/4"	1026	1109	726	616	690
	72"	1 1/4"	1108	1196	754	644	721
<b>RM2244</b>	12"	1 1/4"	699	755	574	464	520
	24"	1 1/4"	781	843	616	506	566
	36"	1 1/4"	863	932	658	548	614
	48"	1 1/4"	944	1019	699	589	659
	60"	1 1/4"	1026	1109	726	616	690
	72"	1 1/4"	1108	1196	754	644	721

Push Bars - Flat Ends							
Part	Max OA	Dia.	3/605 4/606	10/612 10B/613	Stock PC 10BE	32D/630	32/629
<b>RM2202</b>	Up to 36" CTC	1"	687	741	564	454	508
<b>RM2212</b>	Up to 36" CTC	1 1/4"	718	776	576	466	522
Push Bars - Round Ends							
<b>RM2206</b>	Up to 36" CTC	1"	785	848	608	498	558
<b>RM2216</b>	Up to 36" CTC	1 1/4"	816	881	620	510	572

- Add \$6.50/in. over 96".
- MP (Mid Post) - Add \$108 each (Recommended for maximum rigidity on long door pulls. See page 5 for guidelines.)
- Specify finish of grip and collar.

NOTE: Post location on push bars can be located 1/8" from end for narrow & medium stile doors and 1" from end for flush and wide stile doors.

### OvalTek - True Oval Grip

Straight Pulls					
Part	Max OA	Size	Stock PC 10BE	32D/630	32/629
<b>RM2300</b>	12"	1" x 1 1/2"	435	347	389
	24"	1" x 1 1/2"	490	403	451
	36"	1" x 1 1/2"	568	459	514
	48"	1" x 1 1/2"	623	514	576
	60"	1" x 1 1/2"	679	570	638
	72"	1" x 1 1/2"	735	626	701
	84"	1" x 1 1/2"	790	681	763
	96"	1" x 1 1/2"	846	737	825

Offset Pulls					
Part	Max OA	Size	Stock PC 10BE	32D/630	32/629
<b>RM2320</b>	12"	1" x 1 1/2"	473	385	432
	24"	1" x 1 1/2"	550	441	494
	36"	1" x 1 1/2"	606	497	556
	48"	1" x 1 1/2"	662	552	619
	60"	1" x 1 1/2"	717	608	681
	72"	1" x 1 1/2"	773	664	743
	84"	1" x 1 1/2"	829	719	806
	96"	1" x 1 1/2"	884	775	868

Straight Pulls					
Part	Max OA	Size	Stock PC 10BE	32D/630	32/629
<b>RM2310</b>	12"	1 1/8" x 1 7/8"	451	364	407
	24"	1 1/8" x 1 7/8"	514	427	478
	36"	1 1/8" x 1 7/8"	599	490	549
	48"	1 1/8" x 1 7/8"	663	554	620
	60"	1 1/8" x 1 7/8"	726	617	691
	72"	1 1/8" x 1 7/8"	789	680	762
	84"	1 1/8" x 1 7/8"	853	744	833
	96"	1 1/8" x 1 7/8"	916	807	904

Offset Pulls					
Part	Max OA	Size	Stock PC 10BE	32D/630	32/629
<b>RM2330</b>	12"	1 1/8" x 1 7/8"	489	402	450
	24"	1 1/8" x 1 7/8"	574	465	521
	36"	1 1/8" x 1 7/8"	638	528	592
	48"	1 1/8" x 1 7/8"	701	592	663
	60"	1 1/8" x 1 7/8"	764	655	734
	72"	1 1/8" x 1 7/8"	828	718	805
	84"	1 1/8" x 1 7/8"	891	782	876
	96"	1 1/8" x 1 7/8"	954	845	946

Push Bars					
Part	Max OA	Size	Stock PC 10BE	32D/630	32/629
<b>RM2302</b>	Up to 36" CTC	1" x 1 1/2"	568	459	514
<b>RM2312</b>	Up to 36" CTC	1 1/8" x 1 7/8"	599	490	549

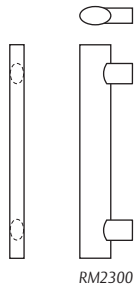

RM2300

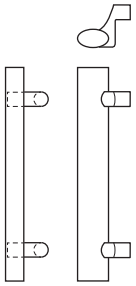

RM2320

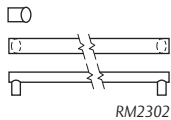

RM2302

### OvalTek - Flat Oval Grip

Straight Pulls - Small Round Posts					
Part	Max OA	Size	Stock PC 10BE	32D/630	32/629
<b>RM2400</b>	12"	3/4" x 1 1/2"	481	394	441
	24"	3/4" x 1 1/2"	579	469	526
	36"	3/4" x 1 1/2"	654	545	610
	48"	3/4" x 1 1/2"	729	620	695
	60"	3/4" x 1 1/2"	805	695	779
	72"	3/4" x 1 1/2"	880	771	863
	84"	3/4" x 1 1/2"	955	846	948
	96"	3/4" x 1 1/2"	1052	921	1032

Straight Pulls - Large Round Posts					
Part	Max OA	Size	Stock PC 10BE	32D/630	32/629
<b>RM2410</b>	12"	3/4" x 1 1/2"	520	432	484
	24"	3/4" x 1 1/2"	617	508	569
	36"	3/4" x 1 1/2"	692	583	653
	48"	3/4" x 1 1/2"	768	658	737
	60"	3/4" x 1 1/2"	843	734	822
	72"	3/4" x 1 1/2"	918	809	906
	84"	3/4" x 1 1/2"	1015	884	990
	96"	3/4" x 1 1/2"	1091	960	1075

Straight Pulls - Oblong Posts					
Part	Max OA	Size	Stock PC 10BE	32D/630	32/629
<b>RM2420</b>	12"	3/4" x 1 1/2"	651	542	607
	24"	3/4" x 1 1/2"	726	617	691
	36"	3/4" x 1 1/2"	801	692	775
	48"	3/4" x 1 1/2"	877	768	860
	60"	3/4" x 1 1/2"	952	843	944
	72"	3/4" x 1 1/2"	1049	918	1028
	84"	3/4" x 1 1/2"	1125	994	1113
	96"	3/4" x 1 1/2"	1200	1069	1197

Push Bar - Large Round Posts					
Part	Max OA	Size	Stock PC 10BE	32D/630	32/629
<b>RM2402</b>	Up to 36" CTC	3/4" x 1 1/2"	692	583	653

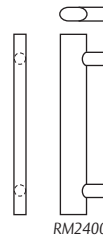

RM2400

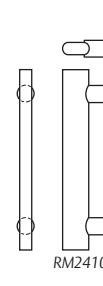

RM2410

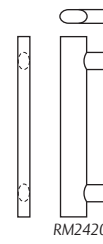

RM2420

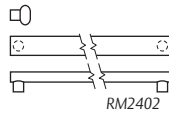

RM2402

- RM2310 & RM2410 pulls add \$7.60/in. over 96".
- MP (Mid Post) - Add \$108 each (Recommended for maximum rigidity on long door pulls. See page 5 for guidelines.)

NOTE: Post location on push bars can be located 1/8" from end for narrow & medium stile doors and 1" from end for flush and wide stile doors.

SoftMet - Santoprene™ Grip



RM2510

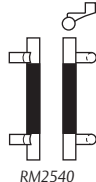

RM2540



RM2514

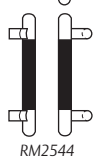

RM2544



RM2512



RM2516

Straight Pulls - Flat Ends							
Part	Max OA	Dia.	3/605 4/606	10/612 10B/613	Stock PC 10BE	32D/630	32/629
RM2510	12"	1 1/4"	425	459	415	326	365
	24"	1 1/4"	550	594	517	428	480
	36"	1 1/4"	675	729	642	531	594
Offset Pulls - Flat Ends							
RM2540	12"	1 1/4"	467	504	454	365	409
	24"	1 1/4"	592	639	578	467	523
	36"	1 1/4"	716	774	681	570	638
Straight Pulls - Round Ends							
RM2514	12"	1 1/4"	520	561	459	370	415
	24"	1 1/4"	645	696	584	473	530
	36"	1 1/4"	769	831	686	575	644
Offset Pulls - Round Ends							
RM2544	12"	1 1/4"	561	606	498	409	458
	24"	1 1/4"	686	741	623	512	573
	36"	1 1/4"	811	876	725	614	688
Push Bars							
RM2512	Up to 36" CTC	Sq. End	675	729	642	531	594
RM2516	Up to 36" CTC	Rd. End	769	831	686	575	644

NOTE: Post location on push bars can be located 1/8" from end for narrow & medium stile doors and 1" from end for flush and wide stile doors.

SoftTek - Santoprene™ Grip

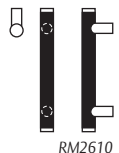

RM2610



RM2640



RM2612

Straight Pulls							
Part	Max OA	Dia.	3/605 4/606	10/612 10B/613	Stock PC 10BE	32D/630	32/629
RM2610	12"	1 1/4"	383	414	403	314	351
	24"	1 1/4"	501	541	501	412	461
	36"	1 1/4"	619	668	621	509	571
Offset Pulls							
RM2640	12"	1 1/4"	424	458	442	353	395
	24"	1 1/4"	542	585	562	451	505
	36"	1 1/4"	660	713	660	548	614
Push Bar							
RM2612	Up to 36" CTC	1 1/4"	619	668	621	509	571

\*Santoprene™ is a registered trademark of the Exxon Mobil Corporation.

**ASSA ABLOY**

The global leader in  
 door opening solutions



### NeoMetrix - with GripZone

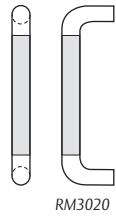

Straight Pulls						
Part	CTC	Dia.	3/605	9/611	32/629	32316
<b>RM3010</b>	12"	1"	353	398	218	326
	24"	1"	436	492	265	395
	36"	1"	518	585	311	465
<b>RM3020</b>	12"	1 1/4"	386	436	231	345
	24"	1 1/4"	466	526	278	415
	36"	1 1/4"	547	618	324	484
<b>RM3030</b>	12"	1 1/2"	452	511	257	384
	24"	1 1/2"	528	596	307	458
	36"	1 1/2"	603	681	358	534

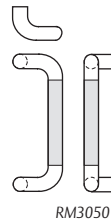

Offset Pulls						
Part	CTC	Dia.	3/605	9/611	32/629	32316
<b>RM3040</b>	12"	1"	394	445	253	377
	24"	1"	477	539	300	447
	36"	1"	559	632	346	516
<b>RM3050</b>	12"	1 1/4"	428	483	266	397
	24"	1 1/4"	507	573	313	466
	36"	1 1/4"	588	665	359	535
<b>RM3060</b>	12"	1 1/2"	494	558	292	436
	24"	1 1/2"	569	643	342	509
	36"	1 1/2"	644	728	393	585

NOTE: Post location on push bars can be located 1/8" from end for narrow & medium stile doors and 1" from end for flush and wide stile doors.

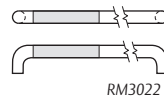

Push Bars - 7" Grip						
Part	CTC	Dia.	3/605	9/611	32/629	32316
<b>RM3012</b>	Up to 36"	1"	518	585	311	465
<b>RM3022</b>	Up to 36"	1 1/4"	547	618	324	484
<b>RM3032</b>	Up to 36"	1 1/2"	603	681	358	534

### Groove - Straight & Offset Pulls

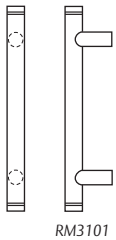

Straight Pulls - Flat Ends							
Part	Max OA	Dia.	3/605 4/606	10/612 10B/613	Stock PC 10BE	32D/630	32/629
<b>RM3101</b>	12"	1"	409	441	238	183	205
	24"	1"	452	488	312	225	252
	36"	1"	495	535	354	266	298
	48"	1"	539	582	395	308	345
	60"	1"	567	613	423	335	375
	72"	1"	596	643	450	362	406
	84"	1"	624	674	477	390	437
	96"	1"	653	705	504	417	467

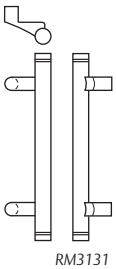

Offset Pulls - Flat Ends							
Part	Max OA	Dia.	3/605 4/606	10/612 10B/613	Stock PC 10BE	32D/630	32/629
<b>RM3131</b>	12"	1"	449	484	276	222	248
	24"	1"	492	531	350	263	295
	36"	1"	535	578	392	305	341
	48"	1"	579	625	433	346	388
	60"	1"	607	656	461	373	418
	72"	1"	636	687	488	401	449
	84"	1"	664	717	515	428	479
	96"	1"	693	748	564	455	510

MegaTek - Straight & Offset PostMount Pulls

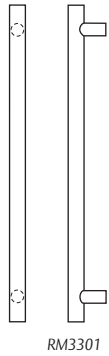

RM3301

Straight Pulls - Flat Ends (87" max overall in aluminum, specify CTC and overall length.)											
Part	Max OA	Dia.	28/628	313/710 315/711	3/605 4/606	10/612 10B/613	Stock PC 10BE	32D/630	32/629	32D316	32316
<b>RM3300</b>	12"	1"	129	143	339	366	187	134	150	180	201
	24"	1"	170	183	380	410	227	174	195	234	262
	36"	1"	210	224	420	455	298	214	240	287	320
	48"	1"	227	270	461	498	338	254	285	341	381
	60"	1"	254	296	488	527	365	281	314	375	421
	72"	1"	280	323	514	556	391	307	344	411	460
	84"	1"	307	350	541	585	417	333	373	446	500
	96"	1"	334	376	568	614	443	359	402	481	539
<b>RM3301</b>	12"	1 1/4"	148	163	354	383	199	146	164	196	220
	24"	1 1/4"	189	204	395	427	238	186	208	249	278
	36"	1 1/4"	229	244	435	471	310	226	253	303	339
	48"	1 1/4"	270	312	476	514	349	265	296	355	397
	60"	1 1/4"	296	339	503	543	375	291	326	389	436
	72"	1 1/4"	323	366	529	572	401	317	355	425	475
	84"	1 1/4"	350	392	556	601	428	344	385	460	515
	96"	1 1/4"	376	419	583	630	454	370	414	495	554
<b>RM3302</b>	12"	1 1/2"	171	232	338	365	211	159	178	212	238
	24"	1 1/2"	211	273	379	409	251	199	223	266	298
	36"	1 1/2"	252	313	419	452	323	238	267	319	357
	48"	1 1/2"	321	354	490	529	360	276	310	370	415
	60"	1 1/2"	348	381	516	558	387	303	339	404	454
	72"	1 1/2"	374	407	543	587	413	329	369	440	493
	84"	1 1/2"	401	434	570	616	439	355	398	475	533
	96"	1 1/2"	427	461	596	645	465	381	428	510	572

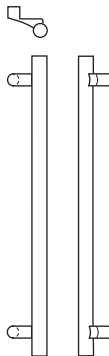

RM3311

Offset Pulls - Flat Ends (Specify CTC and overall length.)											
<b>RM3310</b>	12"	1"	160	174	377	407	216	164	184	211	233
	24"	1"	200	214	417	450	256	204	228	265	293
	36"	1"	241	255	458	494	328	244	273	318	351
	48"	1"	256	298	498	538	366	282	315	370	410
	60"	1"	283	325	525	567	392	308	345	404	450
	72"	1"	309	352	552	595	418	334	374	440	489
	84"	1"	336	378	578	624	444	360	403	475	529
	96"	1"	362	405	605	653	471	387	433	510	568
<b>RM3311</b>	12"	1 1/4"	179	194	391	421	229	177	198	227	251
	24"	1 1/4"	220	235	431	465	300	216	243	280	309
	36"	1 1/4"	260	275	472	509	340	256	287	334	370
	48"	1 1/4"	298	341	512	553	377	293	328	384	426
	60"	1 1/4"	325	368	539	582	403	319	357	419	465
	72"	1 1/4"	352	394	566	610	430	346	387	454	504
	84"	1 1/4"	378	421	592	639	456	372	416	489	544
	96"	1 1/4"	405	448	619	668	482	398	445	525	583
<b>RM3312</b>	12"	1 1/2"	201	263	377	407	241	188	210	243	269
	24"	1 1/2"	242	304	417	450	312	228	255	297	330
	36"	1 1/2"	283	344	458	494	352	268	300	350	388
	48"	1 1/2"	350	383	527	570	388	304	340	399	444
	60"	1 1/2"	376	409	554	599	414	330	370	434	483
	72"	1 1/2"	403	436	580	627	440	356	399	469	522
	84"	1 1/2"	430	463	607	656	466	382	429	504	562
	96"	1 1/2"	456	489	634	685	493	409	458	540	601

- Add \$6.50/in. over 96".
- MP (Mid Post) - Add \$76 each (Recommended for maximum rigidity on long door pulls. See page 5 for guidelines.)

**ASSA ABLOY**

The global leader in door opening solutions

MegaTek - Straight & Offset PostMount Pulls (con't)

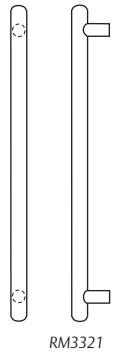

RM3321

Straight Pulls - Round Ends (90" max overall in aluminum, specify CTC and overall length.)											
Part	Max OA	Dia.	28/628	313/710 315/711	3/605 4/606	10/612 10B/613	Stock PC 10BE	32D/630	32/629	32D316	32316
<b>RM3320</b>	12"	1"	163	177	420	455	223	170	190	228	254
	24"	1"	204	217	461	498	294	210	235	281	315
	36"	1"	244	258	502	542	334	250	281	334	375
	48"	1"	262	305	542	586	371	287	321	384	430
	60"	1"	289	332	569	615	397	313	351	419	469
	72"	1"	316	358	595	643	423	339	380	454	509
	84"	1"	342	385	622	672	450	366	410	489	548
	96"	1"	369	411	649	701	476	392	439	525	587
<b>RM3321</b>	12"	1 1/4"	185	198	435	471	235	183	205	244	275
	24"	1 1/4"	226	239	476	514	307	223	249	298	333
	36"	1 1/4"	267	279	516	558	347	263	294	351	394
	48"	1 1/4"	305	349	557	602	382	298	334	399	447
	60"	1 1/4"	332	375	584	631	409	325	364	435	487
	72"	1 1/4"	358	402	610	659	435	351	393	469	526
	84"	1 1/4"	385	429	637	688	461	377	422	505	566
	96"	1 1/4"	411	455	664	717	487	403	452	540	605
<b>RM3322</b>	12"	1 1/2"	205	220	426	460	259	207	232	277	310
	24"	1 1/2"	245	260	466	504	331	247	276	331	370
	36"	1 1/2"	286	301	507	547	371	287	321	384	430
	48"	1 1/2"	321	354	577	623	404	320	359	429	481
	60"	1 1/2"	348	381	604	652	431	347	389	464	520
	72"	1 1/2"	374	407	631	681	457	373	418	500	559
	84"	1 1/2"	401	434	657	710	483	399	448	534	599
	96"	1 1/2"	427	461	684	738	531	425	477	570	638

Offset Pulls - Round Ends (Specify CTC and overall length.)											
<b>RM3330</b>	12"	1"	193	207	456	492	253	201	225	258	284
	24"	1"	233	247	496	536	325	241	269	311	345
	36"	1"	274	288	537	579	365	281	314	364	406
	48"	1"	290	333	577	623	399	315	353	412	459
	60"	1"	317	359	604	652	425	341	382	447	497
	72"	1"	343	386	631	681	452	368	412	482	538
	84"	1"	370	413	657	710	478	394	441	517	576
	96"	1"	397	439	684	738	525	420	471	553	615
<b>RM3331</b>	12"	1 1/4"	215	228	471	508	296	212	237	275	305
	24"	1 1/4"	256	269	511	552	336	252	283	329	363
	36"	1 1/4"	296	309	552	595	376	292	327	382	424
	48"	1 1/4"	333	376	592	639	410	326	365	427	475
	60"	1 1/4"	359	403	619	668	436	352	394	463	515
	72"	1 1/4"	386	430	646	697	462	378	423	497	554
	84"	1 1/4"	413	456	672	726	489	404	453	533	594
	96"	1 1/4"	439	483	699	754	536	431	482	568	633
<b>RM3332</b>	12"	1 1/2"	235	249	464	502	321	237	266	307	341
	24"	1 1/2"	275	290	505	545	361	277	311	361	400
	36"	1 1/2"	316	330	545	589	401	317	355	414	461
	48"	1 1/2"	349	382	614	663	432	348	390	457	509
	60"	1 1/2"	375	408	640	691	458	374	419	492	548
	72"	1 1/2"	402	435	667	720	484	400	449	528	587
	84"	1 1/2"	429	462	694	749	532	427	478	562	627
	96"	1 1/2"	455	488	720	778	558	453	507	598	666

- Add \$6.50/in. over 96".
- MP (Mid Post) - Add \$76 each (Recommended for maximum rigidity on long door pulls. See page 5 for guidelines.)

**ASSA ABLOY**

The global leader in door opening solutions

## MegaTek - Straight &amp; Offset PostMount Pulls (con't)

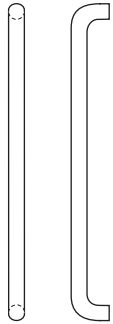

RM3341

Straight Pulls - Bent Ends (86" max CTC in aluminum, specify CTC.)											
Part	CTC	Dia.	28/628	313/710 315/711	3/605 4/606	10/612 108/613	Stock PC 10BE	32D/630	32/629	32D316	32316
RM3340	12"	1"	123	135	283	305	175	123	138	164	184
	24"	1"	155	171	323	349	215	163	183	218	244
	36"	1"	187	206	364	393	255	203	227	271	304
	48"	1"	219	241	404	436	327	243	272	324	364
	60"	1"	251	276	441	476	344	259	291	347	389
	72"	1"	283	311	476	514	360	276	310	370	415
	84"	1"	314	346	562	607	394	310	347	414	464
96"	1"	346	382	649	701	427	342	383	459	514	
RM3341	12"	1 1/4"	133	147	339	366	187	134	150	180	201
	24"	1 1/4"	165	182	380	410	227	174	195	234	262
	36"	1 1/4"	197	217	420	455	298	214	240	287	320
	48"	1 1/4"	229	253	461	498	338	254	285	341	381
	60"	1 1/4"	261	288	497	537	355	271	303	362	404
	72"	1 1/4"	293	323	534	576	371	287	321	384	430
	84"	1 1/4"	325	358	627	678	404	320	358	428	479
96"	1 1/4"	357	393	721	779	437	353	395	473	529	
RM3342	12"	1 1/2"	149	164	412	445	220	167	187	224	250
	24"	1 1/2"	181	199	452	489	259	207	232	277	310
	36"	1 1/2"	213	235	493	532	331	247	276	331	370
	48"	1 1/2"	245	270	534	576	371	287	321	384	430
	60"	1 1/2"	277	305	571	616	382	298	334	399	447
	72"	1 1/2"	309	340	607	656	393	309	346	413	463
	84"	1 1/2"	341	375	694	748	427	342	383	457	514
96"	1 1/2"	373	410	779	841	459	375	420	502	562	

## Push Bars - Flat Ends

	RM3102	Up to 36" CTC	1"	210	224	420	455	298	214	240	287	320
	RM3112	Up to 36" CTC	1 1/4"	229	244	435	471	310	226	253	303	339
	RM3122	Up to 36" CTC	1 1/2"	252	313	419	452	323	238	267	319	357

## Push Bars - Round Ends

	RM3106	Up to 36" CTC	1"	244	258	502	542	334	250	281	334	375
	RM3116	Up to 36" CTC	1 1/4"	267	279	516	558	347	263	294	351	394
	RM3126	Up to 36" CTC	1 1/2"	286	301	507	547	371	287	321	384	430

- Add \$6.50/in. over 96".
- MP (Mid Post) - Add \$76 each (Recommended for maximum rigidity on long door pulls. See page 5 for guidelines.)

NOTE: Post location on push bars can be located 1/8" from end for narrow & medium stile doors and 1" from end for flush and wide stile doors.

## Quick Ship MegaTek - Straight PostMount Pulls

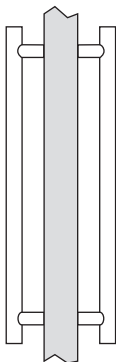

RM3301BTB

## Straight Pulls - Flat Ends - Back-to-Back Mounting

Part	CTC	OA	Dia.	32D/630
RM3301BTB1224.32D	12"	24"	1 1/4"	394
RM3301BTB2436.32D	24"	36"	1 1/4"	474
RM3301BTB3648.32D	36"	48"	1 1/4"	552
RM3301BTB4860.32D	48"	60"	1 1/4"	604
RM3301BTB6072.32D	60"	72"	1 1/4"	657
RM3301BTB7284.32D	72"	84"	1 1/4"	709
RM3301BTB8496.32D	84"	96"	1 1/4"	762

- Mounting included for both 1 3/4" wood or metal doors and 1/2" glass doors.

# ASSA ABLOY

The global leader in  
door opening solutions

USA: Prices Effective May 1, 2018 • Canada: Prices Effective May 7, 2018

Copyright © 2018, ASSA ABLOY Accessories and Door Controls Group, Inc. All rights reserved. Reproduction in whole or in part without the express written permission of ASSA ABLOY Accessories and Door Controls Group, Inc. is prohibited.

NeoMax - Post Mounted GripZone

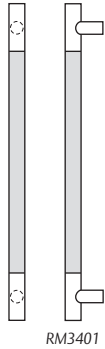

Straight Pulls - Flat Ends							
Part	Max OA	Dia.	3/605	9/611	32/629	32316	
<b>RM3400</b>	12"	1"	319	360	186	244	
	24"	1"	402	454	233	305	
	36"	1"	484	548	279	366	
	48"	1"	567	641	326	427	
	60"	1"	650	734	372	488	
	72"	1"	733	827	419	550	
	84"	1"	815	922	465	611	
	96"	1"	898	1,015	512	672	
	<b>RM3401</b>	12"	1 1/4"	353	399	199	297
		24"	1 1/4"	432	489	246	366
36"		1 1/4"	513	579	292	436	
48"		1 1/4"	593	670	339	505	
60"		1 1/4"	674	761	385	574	
72"		1 1/4"	753	851	432	644	
84"		1 1/4"	834	942	478	713	
96"		1 1/4"	914	1,033	525	782	
<b>RM3402</b>		12"	1 1/2"	419	473	225	295
		24"	1 1/2"	494	558	275	360
	36"	1 1/2"	569	643	326	427	
	48"	1 1/2"	644	729	375	493	
	60"	1 1/2"	720	813	426	560	
	72"	1 1/2"	795	898	476	624	
	84"	1 1/2"	870	983	527	691	
	96"	1 1/2"	945	1,068	576	756	
	<b>Offset Pulls - Flat Ends</b>						
	<b>RM3410</b>	12"	1"	360	408	221	289
24"		1"	443	501	267	350	
36"		1"	525	594	314	412	
48"		1"	609	688	360	473	
60"		1"	692	781	407	534	
72"		1"	775	875	453	595	
84"		1"	857	969	500	656	
96"		1"	940	1,062	546	716	
<b>RM3411</b>		12"	1 1/4"	394	446	234	307
		24"	1 1/4"	474	536	280	367
	36"	1 1/4"	555	626	327	428	
	48"	1 1/4"	634	717	373	489	
	60"	1 1/4"	715	807	420	551	
	72"	1 1/4"	795	898	466	612	
	84"	1 1/4"	876	989	513	673	
	96"	1 1/4"	955	1,080	559	734	
	<b>RM3412</b>	12"	1 1/2"	460	520	260	340
		24"	1 1/2"	536	605	309	406
36"		1 1/2"	611	690	360	473	
48"		1 1/2"	686	775	410	538	
60"		1 1/2"	761	860	461	605	
72"		1 1/2"	836	945	510	670	
84"		1 1/2"	912	1,031	561	736	
96"		1 1/2"	987	1,115	611	802	

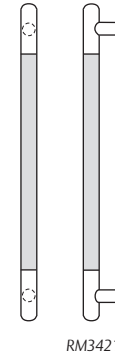
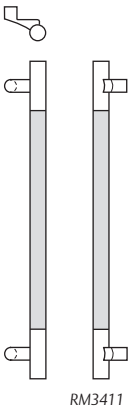

Straight Pulls - Round Ends							
Part	Max OA	Dia.	3/605	9/611	32/629	32316	
<b>RM3420</b>	12"	1"	409	461	223	293	
	24"	1"	492	556	269	354	
	36"	1"	574	649	316	415	
	48"	1"	657	742	362	476	
	60"	1"	740	836	409	536	
	72"	1"	823	930	455	597	
	84"	1"	905	1,023	502	659	
	96"	1"	988	1,116	548	720	
	<b>RM3421</b>	12"	1 1/4"	442	500	236	309
		24"	1 1/4"	522	591	282	370
36"		1 1/4"	603	681	329	432	
48"		1 1/4"	683	771	375	493	
60"		1 1/4"	763	862	422	554	
72"		1 1/4"	843	953	468	615	
84"		1 1/4"	924	1,044	515	675	
96"		1 1/4"	1,004	1,134	561	736	
<b>RM3422</b>		12"	1 1/2"	509	575	262	344
		24"	1 1/2"	584	660	311	408
	36"	1 1/2"	659	744	362	476	
	48"	1 1/2"	734	830	412	541	
	60"	1 1/2"	809	915	463	607	
	72"	1 1/2"	885	999	513	673	
	84"	1 1/2"	960	1,085	563	740	
	96"	1 1/2"	1,035	1,170	613	804	
	<b>Offset Pulls - Round Ends</b>						
	<b>RM3430</b>	12"	1"	450	509	257	338
24"		1"	533	602	304	399	
36"		1"	615	696	350	459	
48"		1"	698	789	397	521	
60"		1"	781	882	443	582	
72"		1"	864	977	490	643	
84"		1"	946	1,070	536	704	
96"		1"	1,030	1,163	583	765	
<b>RM3431</b>		12"	1 1/4"	485	548	270	355
		24"	1 1/4"	565	639	317	416
	36"	1 1/4"	646	730	363	477	
	48"	1 1/4"	725	820	410	538	
	60"	1 1/4"	806	911	456	598	
	72"	1 1/4"	886	1,001	503	660	
	84"	1 1/4"	967	1,091	549	721	
	96"	1 1/4"	1,046	1,182	596	782	
	<b>RM3432</b>	12"	1 1/2"	550	622	296	389
		24"	1 1/2"	625	706	346	454
36"		1 1/2"	701	792	397	521	
48"		1 1/2"	776	877	447	586	
60"		1 1/2"	851	962	497	653	
72"		1 1/2"	926	1,046	547	719	
84"		1 1/2"	1,001	1,132	598	785	
96"		1 1/2"	1,077	1,217	648	850	

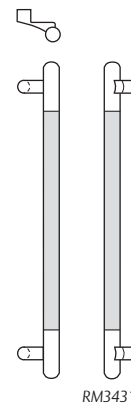

- Add \$6.50/in. over 96".
- MP (Mid Post) - Add \$76 each (Recommended for maximum rigidity on long door pulls. See page 5 for guidelines.)

NeoMax - Post Mounted GripZone (con't)

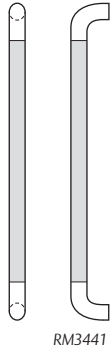

RM3441

Straight Pulls - Bent Ends (Specify CTC.)							
Part	CTC	Dia.	3/605	9/611	32/629	32316	
<b>RM3440</b>	12"	1"	353	399	218	287	
	24"	1"	436	492	265	348	
	36"	1"	518	585	311	408	
	48"	1"	601	679	358	469	
	60"	1"	684	772	404	531	
	72"	1"	767	866	451	592	
	84"	1"	849	960	497	653	
<b>RM3441</b>	12"	1 1/4"	386	437	231	345	
	24"	1 1/4"	466	527	278	415	
	36"	1 1/4"	547	617	324	484	
	48"	1 1/4"	626	708	371	553	
	60"	1 1/4"	707	799	417	623	
	72"	1 1/4"	787	889	464	692	
	84"	1 1/4"	868	980	510	761	
<b>RM3442</b>	12"	1 1/2"	452	511	257	338	
	24"	1 1/2"	528	596	307	403	
	36"	1 1/2"	603	681	358	469	
	48"	1 1/2"	678	767	408	535	
	60"	1 1/2"	753	851	459	602	
	72"	1 1/2"	829	936	508	667	
	84"	1 1/2"	904	1,022	559	734	
96"	1 1/2"	979	1,106	609	799		

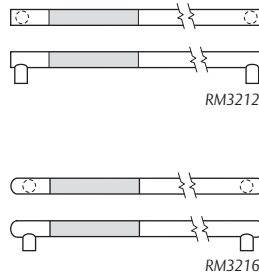

RM3212

RM3216

Push Bars - Flat Ends (7" Grip)							
Part	CTC	Dia.	3/605	9/611	32/629	32316	
<b>RM3202</b>	Up to 36"	1"	484	548	279	366	
<b>RM3212</b>	Up to 36"	1 1/4"	513	579	292	436	
<b>RM3222</b>	Up to 36"	1 1/2"	569	643	326	427	
Push Bars - Round Ends (7" Grip)							
<b>RM3206</b>	Up to 36"	1"	574	649	316	415	
<b>RM3216</b>	Up to 36"	1 1/4"	603	681	329	432	
<b>RM3226</b>	Up to 36"	1 1/2"	659	744	362	475	

LineaMet - Contrasting Grooved Pulls

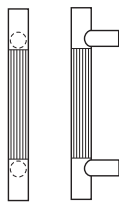

RM3510

Straight Pulls - Flat Ends							
Part	Max OA	Dia.	3/605 4/606	10/612 10B/613	Stock PC 10BE	32D/630	32/629
<b>RM3510</b>	12"	1 1/4"	685	740	468	381	427
	24"	1 1/4"	822	887	574	465	521
	36"	1 1/4"	959	1035	658	549	615
	48"	1 1/4"	1096	1183	742	633	709
	60"	1 1/4"	1233	1331	826	717	803
	72"	1 1/4"	1369	1479	911	801	898
	84"	1 1/4"	1506	1627	1016	885	992
<b>RM3520</b>	12"	1 1/2"	825	891	509	421	472
	24"	1 1/2"	973	1051	622	513	575
	36"	1 1/2"	1122	1212	714	605	677
	48"	1 1/2"	1270	1372	806	697	780
	60"	1 1/2"	1419	1532	897	788	883
	72"	1 1/2"	1567	1692	1011	880	986
	84"	1 1/2"	1715	1853	1103	972	1088
96"	1 1/2"	1864	2013	1194	1063	1191	

LineaMet - Contrasting Grooved Pulls (con't)

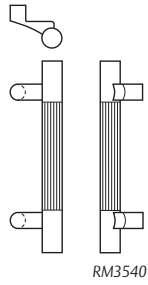

RM3540

Offset Pulls - Flat Ends							
Part	Max OA	Dia.	3/605 4/606	10/612 108/613	Stock PC 10BE	32D/630	32/629
RM3540	12"	1 1/4"	725	783	507	419	470
	24"	1 1/4"	862	931	612	503	564
	36"	1 1/4"	999	1078	697	587	658
	48"	1 1/4"	1136	1226	781	671	752
	60"	1 1/4"	1272	1374	865	756	846
	72"	1 1/4"	1409	1522	949	840	940
	84"	1 1/4"	1546	1670	1055	924	1035
	96"	1 1/4"	1683	1818	1139	1008	1129
RM3550	12"	1 1/2"	865	934	569	460	515
	24"	1 1/2"	1013	1094	661	551	618
	36"	1 1/2"	1162	1255	752	643	720
	48"	1 1/2"	1310	1415	844	735	823
	60"	1 1/2"	1459	1575	936	826	926
	72"	1 1/2"	1607	1735	1049	918	1028
	84"	1 1/2"	1755	1896	1141	1010	1131
	96"	1 1/2"	1904	2056	1233	1102	1234

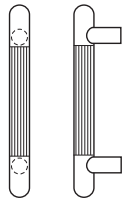

RM3514

Straight Pulls - Round Ends							
RM3514	12"	1 1/4"	776	838	523	436	488
	24"	1 1/4"	913	986	629	520	582
	36"	1 1/4"	1050	1134	713	604	676
	48"	1 1/4"	1187	1282	797	688	770
	60"	1 1/4"	1324	1430	881	772	865
	72"	1 1/4"	1461	1578	965	856	959
	84"	1 1/4"	1598	1726	1071	940	1053
	96"	1 1/4"	1735	1873	1155	1024	1147
RM3524	12"	1 1/2"	916	990	585	476	533
	24"	1 1/2"	1065	1150	677	568	636
	36"	1 1/2"	1213	1310	769	659	739
	48"	1 1/2"	1361	1470	860	751	841
	60"	1 1/2"	1510	1631	952	843	944
	72"	1 1/2"	1658	1791	1066	935	1047
	84"	1 1/2"	1807	1951	1157	1026	1149
	96"	1 1/2"	1955	2111	1249	1118	1252

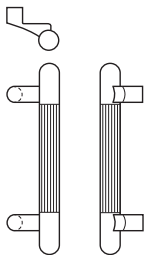

RM3544

Offset Pulls - Round Ends							
RM3544	12"	1 1/4"	816	881	583	474	531
	24"	1 1/4"	953	1029	667	558	625
	36"	1 1/4"	1090	1177	751	642	719
	48"	1 1/4"	1227	1325	835	726	813
	60"	1 1/4"	1364	1473	919	810	907
	72"	1 1/4"	1501	1621	1025	894	1001
	84"	1 1/4"	1638	1769	1109	978	1096
	96"	1 1/4"	1775	1917	1193	1062	1190
RM3554	12"	1 1/2"	956	1033	623	514	576
	24"	1 1/2"	1105	1193	715	606	679
	36"	1 1/2"	1253	1353	807	698	781
	48"	1 1/2"	1401	1514	899	789	884
	60"	1 1/2"	1550	1674	1012	881	987
	72"	1 1/2"	1698	1834	1104	973	1090
	84"	1 1/2"	1847	1994	1196	1065	1192
	96"	1 1/2"	1995	2154	1287	1156	1295



RM3512

Push Bars - Flat Ends							
RM3512	Up to 36" CTC	1 1/4"	959	1035	658	549	615
RM3522	Up to 36" CTC	1 1/2"	1122	1212	714	605	677

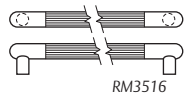

RM3516

Push Bars - Round Ends							
RM3516	Up to 36" CTC	1 1/4"	1050	1134	713	604	676
RM3526	Up to 36" CTC	1 1/2"	1213	1310	769	659	739

NOTE: Post location on push bars can be located 1/8" from end for narrow & medium stile doors and 1" from end for flush and wide stile doors.

**ASSA ABLOY**

The global leader in door opening solutions

LineaTek - Fully Grooved Pulls

Straight Pulls - Flat Ends							
Part	Max OA	Dia.	3/605 4/606	10/612 10B/613	Stock PC 10BE	32D/630	32/629
<b>RM3610</b>	12"	1 1/4"	492	531	367	280	313
	24"	1 1/4"	621	671	447	359	402
	36"	1 1/4"	750	810	548	439	492
	48"	1 1/4"	879	949	628	519	581
	60"	1 1/4"	1008	1088	707	598	670
	72"	1 1/4"	1137	1228	787	678	759
	84"	1 1/4"	1266	1367	867	758	849
	96"	1 1/4"	1395	1506	947	837	938
<b>RM3620</b>	12"	1 1/2"	536	579	406	319	357
	24"	1 1/2"	671	725	491	404	452
	36"	1 1/2"	806	870	598	489	548
	48"	1 1/2"	940	1016	683	574	643
	60"	1 1/2"	1075	1161	769	659	739
	72"	1 1/2"	1210	1306	854	745	834
	84"	1 1/2"	1344	1452	939	830	929
	96"	1 1/2"	1479	1597	1046	915	1025
Offset Pulls - Flat Ends							
<b>RM3640</b>	12"	1 1/4"	532	574	405	318	356
	24"	1 1/4"	661	714	485	397	445
	36"	1 1/4"	790	853	586	477	534
	48"	1 1/4"	919	992	666	557	624
	60"	1 1/4"	1048	1131	746	637	713
	72"	1 1/4"	1177	1271	825	716	802
	84"	1 1/4"	1306	1410	905	796	891
	96"	1 1/4"	1435	1549	1007	876	981
<b>RM3650</b>	12"	1 1/2"	576	622	444	357	400
	24"	1 1/2"	711	768	551	442	495
	36"	1 1/2"	846	913	637	527	591
	48"	1 1/2"	980	1059	722	612	686
	60"	1 1/2"	1115	1204	807	698	781
	72"	1 1/2"	1250	1350	892	783	877
	84"	1 1/2"	1384	1495	977	868	972
	96"	1 1/2"	1519	1641	1084	953	1068
Straight Pulls - Round Ends							
<b>RM3614</b>	12"	1 1/4"	583	630	421	334	374
	24"	1 1/4"	712	769	501	414	463
	36"	1 1/4"	841	908	603	493	553
	48"	1 1/4"	970	1048	682	573	642
	60"	1 1/4"	1099	1187	762	653	731
	72"	1 1/4"	1228	1326	842	733	821
	84"	1 1/4"	1357	1465	921	812	910
	96"	1 1/4"	1486	1605	1023	892	999
<b>RM3624</b>	12"	1 1/2"	628	678	461	373	418
	24"	1 1/2"	762	823	568	459	514
	36"	1 1/2"	897	969	653	544	609
	48"	1 1/2"	1032	1114	738	629	704
	60"	1 1/2"	1166	1260	823	714	800
	72"	1 1/2"	1301	1405	908	799	895
	84"	1 1/2"	1436	1551	1015	884	990
	96"	1 1/2"	1570	1696	1101	970	1086

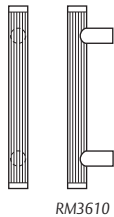

RM3610

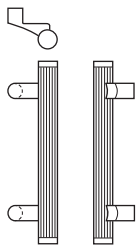

RM3640

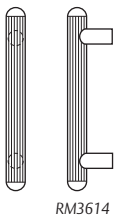

RM3614



### LineaTek - Fully Grooved Pulls (con't)

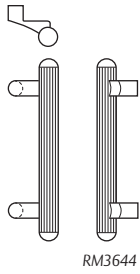

RM3644

Offset Pulls - Round Ends							
Part	Max OA	Dia.	3/605 4/606	10/612 10B/613	Stock PC 10BE	32D/630	32/629
RM3644	12"	1 1/4"	623	673	460	372	417
	24"	1 1/4"	752	812	561	452	506
	36"	1 1/4"	881	952	641	532	596
	48"	1 1/4"	1010	1091	721	611	685
	60"	1 1/4"	1139	1230	800	691	774
	72"	1 1/4"	1268	1369	880	771	863
	84"	1 1/4"	1397	1509	960	851	953
RM3654	12"	1 1/2"	668	721	499	412	461
	24"	1 1/2"	802	866	606	497	556
	36"	1 1/2"	937	1012	691	582	652
	48"	1 1/2"	1072	1157	776	667	747
	60"	1 1/2"	1206	1303	861	752	843
	72"	1 1/2"	1341	1448	947	837	938
	84"	1 1/2"	1476	1594	1054	923	1033
	96"	1 1/2"	1610	1739	1139	1008	1129

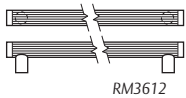

RM3612

Push Bars - Flat Ends							
RM3612	Up to 36" CTC	1 1/4"	750	810	548	439	492
RM3622	Up to 36" CTC	1 1/2"	806	870	598	489	548

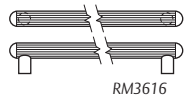

RM3616

Push Bars - Round Ends							
RM3616	Up to 36" CTC	1 1/4"	841	908	603	493	553
RM3626	Up to 36" CTC	1 1/2"	897	969	653	544	609

- Add \$8.10/in. over 36".

NOTE: Post location on push bars can be located 1/8" from end for narrow & medium stile doors and 1" from end for flush and wide stile doors.

### LineaMax - Long Grooved Pulls

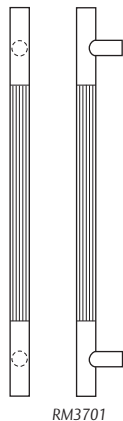

RM3701

Straight Pulls - Solid Flat Ends							
Part	Max OA	Dia.	3/605 4/606	10/612 10B/613	Stock PC 10BE	32D/630	32/629
RM3701	12"	1 1/4"	685	740	468	381	427
	24"	1 1/4"	822	887	574	465	521
	36"	1 1/4"	959	1035	658	549	615
	48"	1 1/4"	1096	1183	742	633	709
	60"	1 1/4"	1233	1331	826	717	803
	72"	1 1/4"	1369	1479	911	801	898
	84"	1 1/4"	1506	1627	1016	885	992
RM3702	12"	1 1/2"	825	891	509	421	472
	24"	1 1/2"	973	1051	622	513	575
	36"	1 1/2"	1122	1212	714	605	677
	48"	1 1/2"	1270	1372	806	697	780
	60"	1 1/2"	1419	1532	897	788	883
	72"	1 1/2"	1567	1692	1011	880	986
	84"	1 1/2"	1715	1853	1103	972	1088
	96"	1 1/2"	1864	2013	1194	1063	1191

- Add \$8.10/in. over 96".
- MP (Mid Post) - Add \$68 each (Recommended for maximum rigidity on long door pulls. See page 5 for guidelines).

**ASSA ABLOY**

The global leader in  
door opening solutions

## LineaMax - Long Grooved Pulls (con't)

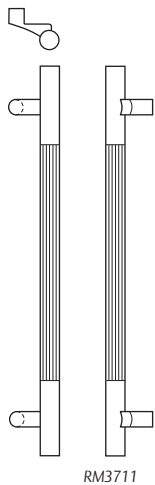

Offset Pulls - Solid Flat Ends							
Part	Max OA	Dia.	3/605 4/606	10/612 10B/613	Stock PC 10BE	32D/630	32/629
<b>RM3711</b>	12"	1 1/4"	725	783	507	419	470
	24"	1 1/4"	862	931	612	503	564
	36"	1 1/4"	999	1078	697	587	658
	48"	1 1/4"	1136	1226	781	671	752
	60"	1 1/4"	1272	1374	865	756	846
	72"	1 1/4"	1409	1522	949	840	940
	84"	1 1/4"	1546	1670	1055	924	1035
<b>RM3712</b>	12"	1 1/2"	865	934	569	460	515
	24"	1 1/2"	1013	1094	661	551	618
	36"	1 1/2"	1162	1255	752	643	720
	48"	1 1/2"	1310	1415	844	735	823
	60"	1 1/2"	1459	1575	936	826	926
	72"	1 1/2"	1607	1735	1049	918	1028
	84"	1 1/2"	1755	1896	1141	1010	1131
	96"	1 1/2"	1904	2056	1233	1102	1234

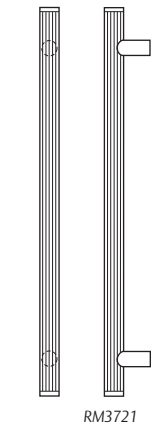

Straight Pulls - Fully Grooved Flat Ends							
<b>RM3721</b>	12"	1 1/4"	492	531	367	280	313
	24"	1 1/4"	621	671	447	359	402
	36"	1 1/4"	750	810	548	439	492
	48"	1 1/4"	879	949	628	519	581
	60"	1 1/4"	1008	1088	707	598	670
	72"	1 1/4"	1137	1228	787	678	759
	84"	1 1/4"	1266	1367	867	758	849
<b>RM3722</b>	12"	1 1/2"	536	579	406	319	357
	24"	1 1/2"	671	725	491	404	452
	36"	1 1/2"	806	870	598	489	548
	48"	1 1/2"	940	1016	683	574	643
	60"	1 1/2"	1075	1161	769	659	739
	72"	1 1/2"	1210	1306	854	745	834
	84"	1 1/2"	1344	1452	939	830	929
	96"	1 1/2"	1479	1597	1046	915	1025

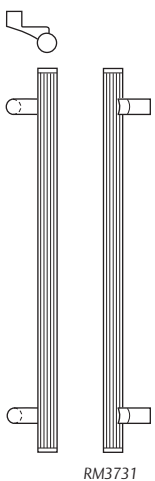

Offset Pulls - Fully Grooved Flat Ends							
<b>RM3731</b>	12"	1 1/4"	532	574	405	318	356
	24"	1 1/4"	661	714	485	397	445
	36"	1 1/4"	790	853	586	477	534
	48"	1 1/4"	919	992	666	557	624
	60"	1 1/4"	1048	1131	746	637	713
	72"	1 1/4"	1177	1271	825	716	802
	84"	1 1/4"	1306	1410	905	796	891
<b>RM3732</b>	12"	1 1/2"	576	622	444	357	400
	24"	1 1/2"	711	768	551	442	495
	36"	1 1/2"	846	913	637	527	591
	48"	1 1/2"	980	1059	722	612	686
	60"	1 1/2"	1115	1204	807	698	781
	72"	1 1/2"	1250	1350	892	783	877
	84"	1 1/2"	1384	1495	977	868	972
	96"	1 1/2"	1519	1641	1084	953	1068

- Add \$8.10/in. over 96".
- MP (Mid Post) - Add \$68 each (Recommended for maximum rigidity on long door pulls. See page 5 for guidelines).

**ASSA ABLOY**The global leader in  
door opening solutions

USA: Prices Effective May 1, 2018 • Canada: Prices Effective May 7, 2018

Copyright © 2018, ASSA ABLOY Accessories and Door Controls Group, Inc. All rights reserved. Reproduction in whole or in part without the express written permission of ASSA ABLOY Accessories and Door Controls Group, Inc. is prohibited.

LineaMax - Long Grooved Pulls (con't)

Straight Pulls - Solid Round Ends							
Part	Max OA	Dia.	3/605 4/606	10/612 10B/613	Stock PC 10BE	32D/630	32/629
<b>RM3751</b>	12"	1 1/4"	776	838	523	436	488
	24"	1 1/4"	913	986	629	520	582
	36"	1 1/4"	1050	1134	713	604	676
	48"	1 1/4"	1187	1282	797	688	770
	60"	1 1/4"	1324	1430	881	772	865
	72"	1 1/4"	1461	1578	965	856	959
	84"	1 1/4"	1598	1726	1071	940	1053
	96"	1 1/4"	1735	1873	1155	1024	1147
	<b>RM3752</b>	12"	1 1/2"	916	990	585	476
24"		1 1/2"	1065	1150	677	568	636
36"		1 1/2"	1213	1310	769	659	739
48"		1 1/2"	1361	1470	860	751	841
60"		1 1/2"	1510	1631	952	843	944
72"		1 1/2"	1658	1791	1066	935	1047
84"		1 1/2"	1807	1951	1157	1026	1149
96"		1 1/2"	1955	2111	1249	1118	1252
<b>Offset Pulls - Solid Round Ends</b>							
<b>RM3761</b>	12"	1 1/4"	816	881	583	474	531
	24"	1 1/4"	953	1029	667	558	625
	36"	1 1/4"	1090	1177	751	642	719
	48"	1 1/4"	1227	1325	835	726	813
	60"	1 1/4"	1364	1473	919	810	907
	72"	1 1/4"	1501	1621	1025	894	1001
	84"	1 1/4"	1638	1769	1109	978	1096
	96"	1 1/4"	1775	1917	1193	1062	1190
	<b>RM3762</b>	12"	1 1/2"	956	1033	623	514
24"		1 1/2"	1105	1193	715	606	679
36"		1 1/2"	1253	1353	807	698	781
48"		1 1/2"	1401	1514	899	789	884
60"		1 1/2"	1550	1674	1012	881	987
72"		1 1/2"	1698	1834	1104	973	1090
84"		1 1/2"	1847	1994	1196	1065	1192
96"		1 1/2"	1995	2154	1287	1156	1295
<b>Straight Pulls - Fully Grooved Round Ends</b>							
<b>RM3771</b>	12"	1 1/4"	583	630	421	334	374
	24"	1 1/4"	712	769	501	414	463
	36"	1 1/4"	841	908	603	493	553
	48"	1 1/4"	970	1048	682	573	642
	60"	1 1/4"	1099	1187	762	653	731
	72"	1 1/4"	1228	1326	842	733	821
	84"	1 1/4"	1357	1465	921	812	910
	96"	1 1/4"	1486	1605	1023	892	999
	<b>RM3772</b>	12"	1 1/2"	628	678	461	373
24"		1 1/2"	762	823	568	459	514
36"		1 1/2"	897	969	653	544	609
48"		1 1/2"	1032	1114	738	629	704
60"		1 1/2"	1166	1260	823	714	800
72"		1 1/2"	1301	1405	908	799	895
84"		1 1/2"	1436	1551	1015	884	990
96"		1 1/2"	1570	1696	1101	970	1086

- Add \$8.10/in. over 96".
- MP (Mid Post) - Add \$68 each (Recommended for maximum rigidity on long door pulls. See page 5 for guidelines).

**ASSA ABLOY**

The global leader in door opening solutions

LineaMax - Long Grooved Pulls (con't)

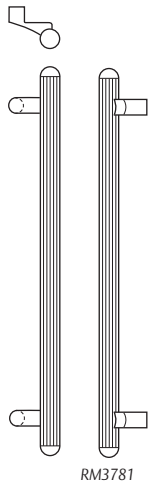

Offset Pulls - Fully Grooved Round Ends							
Part	Max OA	Dia.	3/605 4/606	10/612 10B/613	Stock PC 10BE	32D/630	32/629
<b>RM3781</b>	12"	1 1/4"	623	673	460	372	417
	24"	1 1/4"	752	812	561	452	506
	36"	1 1/4"	881	952	641	532	596
	48"	1 1/4"	1010	1091	721	611	685
	60"	1 1/4"	1139	1230	800	691	774
	72"	1 1/4"	1268	1369	880	771	863
	84"	1 1/4"	1397	1509	960	851	953
<b>RM3782</b>	12"	1 1/2"	668	721	499	412	461
	24"	1 1/2"	802	866	606	497	556
	36"	1 1/2"	937	1012	691	582	652
	48"	1 1/2"	1072	1157	776	667	747
	60"	1 1/2"	1206	1303	861	752	843
	72"	1 1/2"	1341	1448	947	837	938
	84"	1 1/2"	1476	1594	1054	923	1033
	96"	1 1/2"	1610	1739	1139	1008	1129

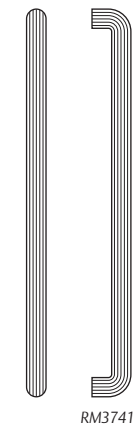

Straight Pulls - Fully Grooved Bent Ends							
<b>RM3741</b>	12"	1 1/4"				312	350
	24"	1 1/4"				392	439
	36"	1 1/4"				472	528
	48"	1 1/4"				551	618
	60"	1 1/4"				631	707
	72"	1 1/4"				711	796
	84"	1 1/4"				790	885
<b>RM3742</b>	12"	1 1/2"				352	394
	24"	1 1/2"				437	489
	36"	1 1/2"				522	585
	48"	1 1/2"				607	680
	60"	1 1/2"				692	775
	72"	1 1/2"				777	871
	84"	1 1/2"				863	966
	96"	1 1/2"				948	1061

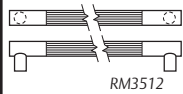

Push Bars Contrasting Grooves Flat Ends							
<b>RM3512</b>	Up to 36" CTC	1 1/4"	959	1035	658	549	615
<b>RM3522</b>	Up to 36" CTC	1 1/2"	1122	1212	714	605	677

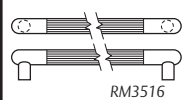

Push Bars Contrasting Grooves Round Ends							
<b>RM3516</b>	Up to 36" CTC	1 1/4"	1050	1134	713	604	676
<b>RM3526</b>	Up to 36" CTC	1 1/2"	1213	1310	769	659	739

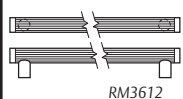

Push Bars Fully Grooved - Flat Ends							
<b>RM3612</b>	Up to 36" CTC	1 1/4"	750	810	548	439	492
<b>RM3622</b>	Up to 36" CTC	1 1/2"	806	870	598	489	548

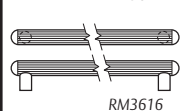

Push Bars Fully Grooved - Round Ends							
<b>RM3616</b>	Up to 36" CTC	1 1/4"	841	908	603	493	553
<b>RM3626</b>	Up to 36" CTC	1 1/2"	897	969	653	544	609

- Add \$8.10/in. over 96".
- MP (Mid Post) - Add \$68 each (Recommended for maximum rigidity on long door pulls. See page 5 for guidelines).

NoirMet - Black Anodized Grip with Contrasting Ends and Posts



RM3810

Straight Pulls - Flat Ends									
Part	Max OA	Dia.	3/605 4/606	10/612 108/613	Stock PC 10BE	32D	32/629	32D316	32316
<b>RM3800</b>	12"	1"	343	396	338	249	274	333	366
	24"	1"	374	425	362	273	300	365	401
	36"	1"	386	438	376	287	316	383	422
	48"	1"	575	628	465	376	414	502	553
	60"	1"	625	668	486	397	437	530	584
	72"	1"	673	708	506	417	459	558	614
	84"	1"	769	813	556	445	489	595	654
	96"	1"	865	917	583	472	518	630	693
	<b>RM3810</b>	12"	1 1/4"	361	412	345	256	281	342
24"		1 1/4"	412	445	376	287	316	383	422
36"		1 1/4"	428	462	390	301	331	402	442
48"		1 1/4"	576	628	481	392	430	524	575
60"		1 1/4"	608	652	496	407	448	544	599
72"		1 1/4"	640	675	512	423	465	565	621
84"		1 1/4"	761	795	585	474	522	633	697
96"		1 1/4"	883	914	635	524	576	700	769
<b>RM3820</b>		12"	1 1/2"	447	480	390	301	331	402
	24"	1 1/2"	497	530	415	326	358	436	479
	36"	1 1/2"	540	574	449	360	396	481	529
	48"	1 1/2"	614	630	513	424	466	566	623
	60"	1 1/2"	670	688	566	455	501	608	669
	72"	1 1/2"	726	745	596	485	534	648	713
	84"	1 1/2"	832	850	647	536	590	717	788
	96"	1 1/2"	937	954	699	587	646	784	863
	Offset Pulls - Flat Ends								
<b>RM3830</b>	12"	1"	386	480	376	287	316	383	422
	24"	1"	458	544	420	331	365	442	487
	36"	1"	541	615	465	376	414	502	553
	48"	1"	622	687	509	420	463	561	619
	60"	1"	672	727	531	442	486	590	649
	72"	1"	720	767	573	462	508	617	679
	84"	1"	817	872	612	501	551	669	736
	96"	1"	912	976	650	538	592	719	791
	<b>RM3840</b>	12"	1 1/4"	403	497	383	294	323	392
24"		1 1/4"	484	557	427	338	372	452	496
36"		1 1/4"	554	622	471	382	419	510	560
48"		1 1/4"	623	687	514	425	467	568	624
60"		1 1/4"	655	711	530	441	485	589	648
72"		1 1/4"	687	734	567	456	502	609	670
84"		1 1/4"	808	854	618	507	558	678	747
96"		1 1/4"	930	973	669	557	613	744	819
<b>RM3850</b>		12"	1 1/2"	488	566	429	340	375	455
	24"	1 1/2"	540	615	449	360	396	481	529
	36"	1 1/2"	601	653	498	409	451	546	603
	48"	1 1/2"	661	689	568	457	503	611	672
	60"	1 1/2"	718	747	600	488	537	653	718
	72"	1 1/2"	773	804	630	518	571	693	763
	84"	1 1/2"	879	908	681	570	626	761	837
	96"	1 1/2"	984	1013	732	621	683	829	912

• Add \$6.50/in. over 36".

NOTE: Post location on push bars can be located 1/8" from end for narrow & medium stile doors and 1" from end for flush and wide stile doors.

NoirMet - Black Anodized Grip with Contrasting Ends and Posts (con't)

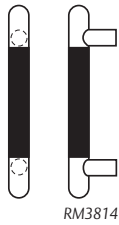

Straight Pulls - Round Ends									
Part	Max OA	Dia.	3/605 4/606	10/612 108/613	Stock PC 10BE	32D	32/629	32D316	32316
<b>RM3804</b>	12"	1"	386	438	376	287	316	383	422
	24"	1"	416	468	403	314	345	420	461
	36"	1"	428	480	415	326	358	436	479
	48"	1"	619	670	509	420	463	561	619
	60"	1"	667	711	531	442	486	590	649
	72"	1"	714	749	574	463	509	619	680
<b>RM3814</b>	84"	1"	810	853	613	502	552	670	737
	96"	1"	904	956	651	540	594	721	793
	12"	1 1/4"	403	455	383	294	323	392	431
	24"	1 1/4"	456	489	414	325	357	434	477
	36"	1 1/4"	473	505	429	340	375	455	501
	48"	1 1/4"	620	672	516	427	469	571	628
<b>RM3824</b>	60"	1 1/4"	652	694	532	443	487	591	651
	72"	1 1/4"	682	716	570	458	504	613	673
	84"	1 1/4"	802	837	621	509	561	680	749
	96"	1 1/4"	923	957	671	560	615	748	822
	12"	1 1/2"	488	523	429	340	375	455	501
	24"	1 1/2"	540	574	449	360	396	481	529
<b>RM3824</b>	36"	1 1/2"	581	615	488	399	439	534	588
	48"	1 1/2"	655	674	570	458	504	613	673
	60"	1 1/2"	712	731	601	489	538	654	719
	72"	1 1/2"	768	786	631	519	572	694	764
	84"	1 1/2"	872	890	680	568	625	759	836
	96"	1 1/2"	976	993	729	617	680	825	908

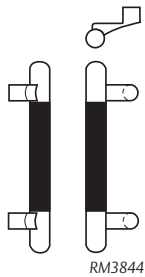

Offset Pulls - Round Ends									
<b>RM3834</b>	12"	1"	428	462	415	326	358	436	479
	24"	1"	502	542	458	369	406	494	543
	36"	1"	584	632	501	412	453	550	605
	48"	1"	666	719	565	454	499	606	668
	60"	1"	714	771	586	475	523	635	699
	72"	1"	761	822	607	496	546	663	729
<b>RM3844</b>	84"	1"	857	925	646	535	588	715	787
	96"	1"	951	1027	684	573	642	766	857
	12"	1 1/4"	447	482	420	331	372	442	496
	24"	1 1/4"	527	569	464	375	419	501	560
	36"	1 1/4"	597	646	507	418	468	559	625
	48"	1 1/4"	667	720	572	461	516	615	689
<b>RM3854</b>	60"	1 1/4"	699	754	587	476	533	636	712
	72"	1 1/4"	729	788	603	492	551	657	736
	84"	1 1/4"	850	918	654	543	608	725	813
	96"	1 1/4"	970	1048	704	593	664	792	887
	12"	1 1/2"	530	573	466	377	423	504	565
	24"	1 1/2"	581	627	488	399	447	534	598
<b>RM3854</b>	36"	1 1/2"	642	694	557	446	499	596	668
	48"	1 1/2"	702	759	603	492	551	657	736
	60"	1 1/2"	759	820	634	523	585	699	782
	72"	1 1/2"	815	880	664	553	620	739	828
	84"	1 1/2"	919	992	714	603	675	806	902
	96"	1 1/2"	1023	1104	764	653	731	872	976

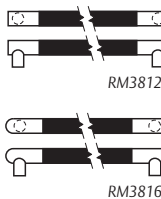

Push Bars - Flat Ends									
<b>RM3802</b>	Up to 36" CTC	1"	386	438	376	287	316	383	422
<b>RM3812</b>	Up to 36" CTC	1 1/4"	428	462	390	301	331	402	442
<b>RM3822</b>	Up to 36" CTC	1 1/2"	540	574	449	360	396	481	529
Push Bars - Round Ends									
<b>RM3806</b>	Up to 36" CTC	1"	428	480	415	326	358	436	479
<b>RM3816</b>	Up to 36" CTC	1 1/4"	473	505	429	340	375	455	501
<b>RM3826</b>	Up to 36" CTC	1 1/2"	581	615	488	399	439	534	588

• Add \$6.50/in. over 36".

NOTE: Post location on push bars can be located 1/8" from end for narrow & medium stile doors and 1" from end for flush and wide stile doors.

**ASSA ABLOY**

The global leader in door opening solutions

NoirTek - Black Anodized Grip with Contrasting Posts

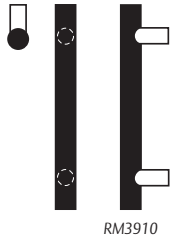

RM3910

Straight Pulls - Flat Ends									
Part	Max OA	Dia.	28/628	313/710 315/711	3/605 4/606	10/612 10B/613	Stock PC 10BE	32D/630	32/629
<b>RM3900</b>	12"	1"	171	189	225	243	221	166	186
	24"	1"	243	267	256	276	245	189	212
	36"	1"	315	346	269	290	259	204	228
	48"	1"	386	425	457	494	382	293	328
	60"	1"	458	504	507	547	403	314	351
	72"	1"	530	583	555	599	423	334	374
<b>RM3910</b>	12"	1 1/4"	188	207	243	262	228	172	193
	24"	1 1/4"	264	291	295	318	259	204	228
	36"	1 1/4"	341	375	310	335	274	218	244
	48"	1 1/4"	417	459	458	495	397	308	345
	60"	1 1/4"	493	542	490	529	413	324	363
	72"	1 1/4"	569	626	522	564	428	339	380
<b>RM3920</b>	12"	1 1/2"	223	245	329	355	274	218	244
	24"	1 1/2"	285	314	379	410	331	243	272
	36"	1 1/2"	348	382	422	456	366	277	310
	48"	1 1/2"	410	451	496	536	429	340	381
	60"	1 1/2"	472	519	553	597	461	372	416
	72"	1 1/2"	534	588	608	657	491	402	450
	84"	1 1/2"	596	656	714	771	564	453	507

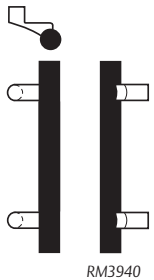

RM3940

Offset Pulls - Flat Ends									
<b>RM3930</b>	12"	1"			266	288	260	205	229
	24"	1"			297	321	317	228	255
	36"	1"			310	335	331	243	272
	48"	1"			498	538	420	331	371
	60"	1"			548	592	442	353	395
	72"	1"			596	644	462	373	417
<b>RM3940</b>	12"	1 1/4"			284	307	267	211	237
	24"	1 1/4"			336	363	331	243	272
	36"	1 1/4"			351	379	346	257	288
	48"	1 1/4"			500	540	436	347	389
	60"	1 1/4"			531	574	452	363	406
	72"	1 1/4"			563	608	467	378	424
<b>RM3950</b>	12"	1 1/2"			370	400	346	257	288
	24"	1 1/2"			421	454	370	281	315
	36"	1 1/2"			463	500	405	316	354
	48"	1 1/2"			537	580	468	379	425
	60"	1 1/2"			594	641	499	410	460
	72"	1 1/2"			649	701	530	441	493
	84"	1 1/2"			755	816	603	492	551

• Add \$6.50/in. over 36".

NOTE: Post location on push bars can be located 1/8" from end for narrow & medium stile doors and 1" from end for flush and wide stile doors.

**ASSA ABLOY**

The global leader in door opening solutions

NoirTek - Black Anodized Grip with Contrasting Posts (con't)

Straight Pulls - Round Ends									
Part	Max OA	Dia.	28/628	313/710 315/711	3/605 4/606	10/612 10B/613	Stock PC 10BE	32D/630	32/629
<b>RM3904</b>	12"	1"	213	234	319	345	266	210	235
	24"	1"	281	309	350	378	323	234	262
	36"	1"	349	384	363	392	337	248	278
	48"	1"	417	459	551	596	426	337	378
	60"	1"	485	533	601	649	447	358	401
	72"	1"	553	608	649	701	467	378	424
	84"	1"	621	683	746	806	495	406	455
<b>RM3914</b>	12"	1 1/4"	229	252	337	364	273	217	243
	24"	1 1/4"	296	325	389	420	337	248	278
	36"	1 1/4"	363	399	404	436	352	263	294
	48"	1 1/4"	430	473	553	597	442	353	395
	60"	1 1/4"	497	546	584	631	457	368	412
	72"	1 1/4"	564	620	616	666	473	384	430
	84"	1 1/4"	631	694	738	797	524	435	487
<b>RM3924</b>	12"	1 1/2"	264	291	423	457	352	263	294
	24"	1 1/2"	337	371	474	512	376	287	321
	36"	1 1/2"	410	451	516	557	410	321	360
	48"	1 1/2"	483	531	590	638	474	385	431
	60"	1 1/2"	555	611	647	699	505	416	466
	72"	1 1/2"	628	691	702	758	557	446	500
	84"	1 1/2"	701	771	808	873	608	497	557
Offset Pulls - Round Ends									
<b>RM3934</b>	12"	1"			361	389	338	249	279
	24"	1"			391	422	362	273	305
	36"	1"			404	436	376	287	321
	48"	1"			593	640	465	376	421
	60"	1"			642	694	486	397	445
	72"	1"			690	746	506	417	467
	84"	1"			787	850	556	445	498
<b>RM3944</b>	12"	1 1/4"			378	408	345	256	287
	24"	1 1/4"			430	464	376	287	321
	36"	1 1/4"			445	481	390	301	338
	48"	1 1/4"			594	641	481	392	439
	60"	1 1/4"			626	676	496	407	456
	72"	1 1/4"			658	710	512	423	473
	84"	1 1/4"			779	841	585	474	531
<b>RM3954</b>	12"	1 1/2"			464	501	390	301	338
	24"	1 1/2"			515	556	415	326	365
	36"	1 1/2"			557	602	449	360	404
	48"	1 1/2"			632	682	513	424	475
	60"	1 1/2"			688	743	566	455	510
	72"	1 1/2"			744	803	596	485	543
	84"	1 1/2"			850	918	647	536	601
Push Bars - Flat Ends									
<b>RM3902</b>	Up to 36" CTC	1"	315	346	269	290	259	204	228
<b>RM3912</b>	Up to 36" CTC	1 1/4"	341	375	310	335	274	218	244
<b>RM3922</b>	Up to 36" CTC	1 1/2"	348	382	422	456	366	277	310
Push Bars - Round Ends									
<b>RM3906</b>	Up to 36" CTC	1"	349	384	363	392	337	248	278
<b>RM3916</b>	Up to 36" CTC	1 1/4"	363	399	404	436	352	263	294
<b>RM3926</b>	Up to 36" CTC	1 1/2"	410	451	516	557	410	321	360

• Add \$6.50/in. over 36".

NOTE: Post location on push bars can be located 1/8" from end for narrow & medium stile doors and 1" from end for flush and wide stile doors.

**ASSA ABLOY**

The global leader in door opening solutions

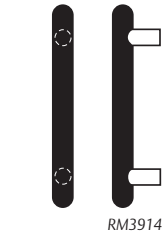

RM3914

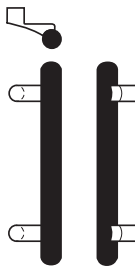

RM3944



RM3912



RM3916



## ArborMet - Wood Grip Pulls

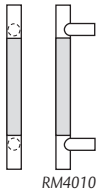

Straight Pulls - Flat Ends							
Part	Max OA	Dia.	3/605 4/606	10/612 10B/613	Stock PC 10BE	32D/630	32/629
RM4000	12"	1"	443	478	431	344	385
	24"	1"	500	540	486	399	446
	36"	1"	557	601	562	453	507
	48"	1"	614	663	617	508	569
RM4010	12"	1 1/4"	462	499	444	357	400
	24"	1 1/4"	519	561	499	412	461
	36"	1 1/4"	576	622	575	466	522
	48"	1 1/4"	633	684	630	521	583
RM4020	12"	1 1/2"	539	582	497	409	459
	24"	1 1/2"	596	643	573	464	520
	36"	1 1/2"	653	705	628	519	581
	48"	1 1/2"	710	767	682	573	642

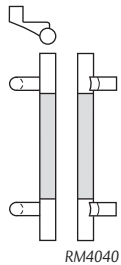

Offset Pulls - Flat Ends							
RM4030	12"	1"	483	521	469	382	428
	24"	1"	540	583	546	437	489
	36"	1"	597	645	600	491	550
	48"	1"	654	706	655	546	611
RM4040	12"	1 1/4"	502	542	483	395	443
	24"	1 1/4"	559	604	559	450	504
	36"	1 1/4"	616	666	614	504	565
	48"	1 1/4"	673	727	668	559	626
RM4050	12"	1 1/2"	579	625	557	448	501
	24"	1 1/2"	636	687	611	502	562
	36"	1 1/2"	693	748	666	557	624
	48"	1 1/2"	750	810	721	611	685

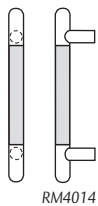

Straight Pulls - Round Ends							
RM4004	12"	1"	534	577	475	388	434
	24"	1"	591	638	551	442	495
	36"	1"	648	700	606	497	556
	48"	1"	705	762	661	551	618
RM4014	12"	1 1/4"	554	598	488	401	449
	24"	1 1/4"	611	659	564	455	510
	36"	1 1/4"	668	721	619	510	571
	48"	1 1/4"	725	783	674	564	632
RM4024	12"	1 1/2"	630	680	562	453	507
	24"	1 1/2"	687	742	617	508	569
	36"	1 1/2"	744	804	671	562	630
	48"	1 1/2"	801	865	726	617	691

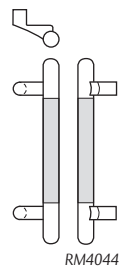

Offset Pulls - Round Ends							
RM4034	12"	1"	574	620	513	426	477
	24"	1"	631	682	590	480	538
	36"	1"	688	743	644	535	599
	48"	1"	745	805	699	590	660
RM4044	12"	1 1/4"	593	641	548	439	492
	24"	1 1/4"	651	703	603	493	553
	36"	1 1/4"	708	764	657	548	614
	48"	1 1/4"	765	826	712	603	675
RM4054	12"	1 1/2"	670	724	600	491	550
	24"	1 1/2"	727	785	655	546	611
	36"	1 1/2"	784	847	710	600	673
	48"	1 1/2"	841	908	764	655	734

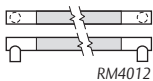

Push Bars - Flat Ends							
RM4002	Up to 36" CTC	1"	557	601	562	453	507
RM4012	Up to 36" CTC	1 1/4"	576	622	575	466	522
RM4022	Up to 36" CTC	1 1/2"	653	705	628	519	581

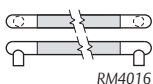

Push Bars - Round Ends							
RM4006	Up to 36" CTC	1"	648	700	606	497	556
RM4016	Up to 36" CTC	1 1/4"	668	721	619	510	571
RM4026	Up to 36" CTC	1 1/2"	744	804	671	562	630

- Long pull lengths available. Call factory for pricing.
- Additional fee may be included on Premium and Super Premium wood species, as well as any additional wood finishing.

NOTE: Post location on push bars can be located 1/8" from end for narrow & medium stile doors and 1" from end for flush and wide stile doors.

**ASSA ABLOY**

The global leader in  
door opening solutions

ArborTek - Wood Grip Pulls

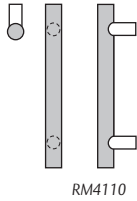

RM4110

Straight Pulls - Flat Ends							
Part	Max OA	Dia.	3/605 4/606	10/612 10B/613	Stock PC 10BE	32D/630	32/629
RM4100	12"	1"	329	355	322	235	263
	24"	1"	386	417	377	289	324
	36"	1"	443	478	431	344	385
	48"	1"	500	540	486	399	446
RM4110	12"	1 1/4"	348	376	345	258	289
	24"	1 1/4"	405	438	400	312	350
	36"	1 1/4"	462	499	454	367	411
	48"	1 1/4"	519	561	509	421	472
RM4120	12"	1 1/2"	425	459	388	300	336
	24"	1 1/2"	482	520	442	355	397
	36"	1 1/2"	539	582	497	409	459
	48"	1 1/2"	596	643	573	464	520

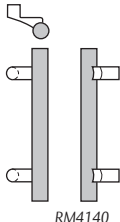

RM4140

Offset Pulls - Flat Ends							
RM4130	12"	1"	369	398	360	273	306
	24"	1"	426	460	415	328	367
	36"	1"	483	521	469	382	428
	48"	1"	540	583	546	437	489
RM4140	12"	1 1/4"	388	419	383	296	331
	24"	1 1/4"	445	481	438	350	393
	36"	1 1/4"	502	542	492	405	454
	48"	1 1/4"	559	604	569	460	515
RM4150	12"	1 1/2"	464	502	426	338	379
	24"	1 1/2"	522	563	480	393	440
	36"	1 1/2"	579	625	557	448	501
	48"	1 1/2"	636	687	611	502	562

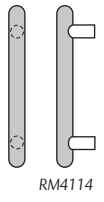

RM4114

Straight Pulls - Round Ends							
RM4104	12"	1"	420	454	366	278	312
	24"	1"	477	515	420	333	373
	36"	1"	534	577	475	388	434
	48"	1"	591	638	551	442	495
RM4114	12"	1 1/4"	439	475	389	301	337
	24"	1 1/4"	496	536	443	356	399
	36"	1 1/4"	554	598	498	411	460
	48"	1 1/4"	611	659	574	465	521
RM4124	12"	1 1/2"	516	557	431	344	385
	24"	1 1/2"	573	619	486	399	446
	36"	1 1/2"	630	680	562	453	507
	48"	1 1/2"	687	742	617	508	569

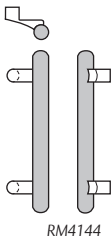

RM4144

Offset Pulls - Round Ends							
RM4134	12"	1"	460	497	404	317	355
	24"	1"	517	558	459	371	416
	36"	1"	574	620	513	426	477
	48"	1"	631	682	590	480	538
RM4144	12"	1 1/4"	479	518	427	340	380
	24"	1 1/4"	536	579	481	394	441
	36"	1 1/4"	593	641	558	449	503
	48"	1 1/4"	651	703	612	503	564
RM4154	12"	1 1/2"	556	600	469	382	428
	24"	1 1/2"	613	662	546	437	489
	36"	1 1/2"	670	724	600	491	550
	48"	1 1/2"	727	785	655	546	611

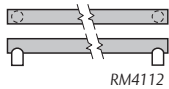

RM4112

Push Bars - Flat Ends							
RM4112	Up to 36" CTC	1 1/4"	462	499	454	367	411
RM4122	Up to 36" CTC	1 1/2"	539	582	497	409	459

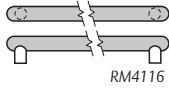

RM4116

Push Bars - Round Ends							
RM4116	Up to 36" CTC	1 1/4"	554	598	498	411	460
RM4126	Up to 36" CTC	1 1/2"	630	680	562	453	507

NOTE: Post location on push bars can be located 1/8" from end for narrow & medium stile doors and 1" from end for flush and wide stile doors. Additional fee may be included on Premium and Super Premium wood species, as well as any additional wood finishing.

**ASSA ABLOY**

The global leader in door opening solutions

### ArborTek - Wood Grip Pulls (con't)

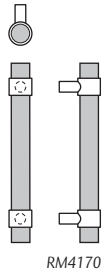

RM4170

Wood Pulls with Collar Mount Posts							
Straight Pulls - Flat Ends							
Part	OA	Dia.	3/605 4/606	10/612 10B/613	Stock PC 10BE	32D/630	32/629
RM4160	12"	1"	483	522	495	407	456
	24"	1"	558	603	567	479	537
	36"	1"	632	682	638	550	616
	48"	1"	710	767	712	625	700
RM4170	12"	1 1/4"	491	530	502	415	465
	24"	1 1/4"	581	628	588	501	561
	36"	1 1/4"	670	724	674	586	656
	48"	1 1/4"	734	792	735	647	725

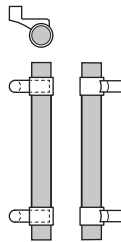

RM4190

Offset Pulls - Flat Ends							
RM4180	12"	1"	535	579	545	457	512
	24"	1"	617	666	623	536	600
	36"	1"	700	756	702	615	689
	48"	1"	756	816	756	668	748
RM4190	12"	1 1/4"	541	584	550	463	519
	24"	1 1/4"	638	689	643	556	622
	36"	1 1/4"	735	794	736	649	726
	48"	1 1/4"	773	834	772	685	766

- Additional fee may be included on Premium and Super Premium wood species, as well as any additional wood finishing.

### SkewTek - Angled End Pulls

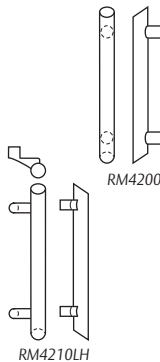

RM4200

RM4210LH

Straight Pull - Forward Segment									
Part	Max OA	Dia.	28/628	313/710 315/711	3/605 4/606	10/612 10B/613	Stock PC 10BE	32D/630	32/629
RM4200-11	16"	1 1/2"	476	524	621	670	518	430	483
Offset Pulls - Forward Segment									
RM4210LH-11	16"	1 1/2"	510	561	660	712	572	463	519
RM4210RH-11	16"	1 1/2"	510	561	660	712	572	463	519
Straight Pulls - Rectangular Posts									
RM4270-12	18"	2"	679	727	1034	1117	787	678	759
RM4270-24	30"	2"	743	793	1130	1220	865	756	847
Offset Pulls - Rectangular Posts									
RM4272-12	18"	2"	840	889	1194	1290	917	808	904
RM4272-24	30"	2"	905	953	1288	1391	1018	887	992
Straight Pulls - Round Posts									
RM4274-12	18"	2"	679	727	1034	1117	787	678	759
RM4274-24	30"	2"	743	793	1130	1220	865	756	847

RM4272

- Add \$6.50/in. over 30".

**CentTrex - Shaped Pulls**

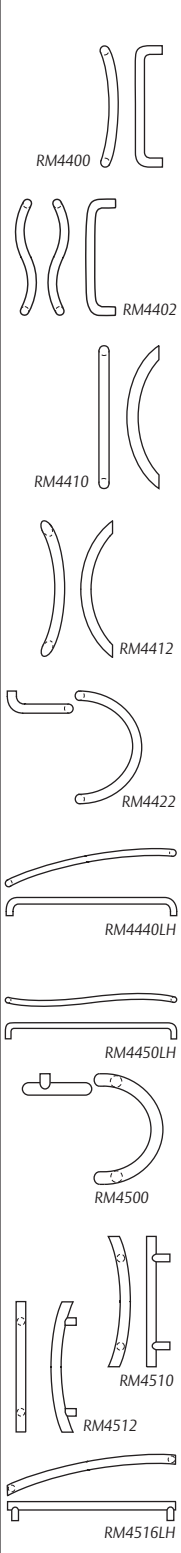

Curved Pulls									
Part	CTC	28/628	313/710 315/711	3/605 4/606	10/612 10B/613	Stock PC 10BE	26/625 26D/626	32D/630	32/629
RM4400-12	12"	357	376	541	585	442	541	356	398
RM4400-20	20"	372	391	600	648	456	600	370	415
Double Curved Pulls									
RM4402LH	12"	427	445	600	648	489	600	402	451
RM4402RH	12"	427	445	600	648	489	600	402	451
Straight Radius Pulls									
RM4410-12	12"	316	334	541	585	393	541	306	343
RM4410-18	18"	334	354	600	648	410	600	323	362
RM4410-24	24"	354	372	655	707	442	655	356	398
Offset Radius Pulls									
RM4412-12	12"	391	409	619	668	456	619	370	415
RM4412-18	18"	409	427	672	726	474	672	387	435
RM4412-24	24"	427	445	729	787	505	729	419	469
Semi-Circular Pulls									
RM4420	9"	243	261		486	330	450	243	271
RM4422	12"	261	280		505	347	468	261	291
Radius Push Bars									
RM4440LH	Up to 36"	464	483	823	889	673	823	565	632
RM4440RH	Up to 36"	464	483	823	889	673	823	565	632
Compound Radius Push Bars									
RM4450LH	Up to 36"	924	981	604	1272	1014	1178	885	992
RM4450RH	Up to 36"	924	981	604	1272	1014	1178	885	992
Semi-Circular Pulls									
RM4500	11"	372	391	749	808	542		434	485
RM4502	11"	372	391	749	808	542		434	485
RM4506	12"			487	527	425		339	379
Side Radius Pull									
RM4510	12"	409	445	561	606	489		402	451
Projecting Radius Pull									
RM4512	12"			823	889	623		515	576
Radius Push Bars									
RM4516LH	Up to 36"	500	537	729	787	574		466	522
RM4516RH	Up to 36"	500	537	729	787	574		466	522

NOTE: Post location on push bars can be located 1/8" from end for narrow & medium stile doors and 1" from end for flush and wide stile doors.

**ASSA ABLOY**

The global leader in door opening solutions

USA: Prices Effective May 1, 2018 • Canada: Prices Effective May 7, 2018

Copyright © 2018, ASSA ABLOY Accessories and Door Controls Group, Inc. All rights reserved. Reproduction in whole or in part without the express written permission of ASSA ABLOY Accessories and Door Controls Group, Inc. is prohibited.

### AccenTek - Solid Pulls with Accents

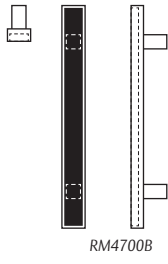

RM4700B

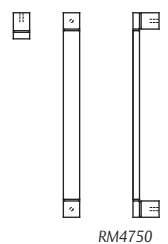

RM4750

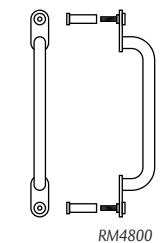

RM4800

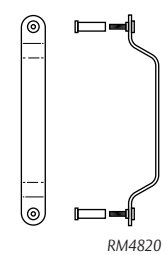

RM4820

Cast Pulls									
Part	Grip	CTC	Stock PC 10BE	3/605 4/606	10/612 10A/722	10B/613 10BL/614	15/619 15A/620	20A/624	26/625 26D/626
RM4720	1 1/2" x 1/2" x 12 1/2"	8"	441	426	461	461	461	461	461
RM4700W	1 1/4" x 5/8" x 14"	10"	512	496	535	535	535	535	535
RM4700B	1 1/4" x 5/8" x 14"	10"	512	496	535	535	535	535	535
Solid Groove Pulls									
Part	Grip	CTC	32D/630	32/629					
RM4750	1/2" x 1 1/4"	12"	324	364					
	1/2" x 1 1/4"	24"	376	420					
	1/2" x 1 1/4"	36"	427	478					
	1/2" x 1 1/4"	48"	477	534					
RM4755	3/4" x 1 1/4"	12"	368	412					
	3/4" x 1 1/4"	24"	419	469					
	3/4" x 1 1/4"	36"	471	527					
	3/4" x 1 1/4"	48"	521	583					
Formed Pulls with Distinguished Fastener Heads									
Part	Grip	CTC	Wrought Black	Stock PC 10BE	Black Suede	32D/630	Industrial Steel		
RM4800	3/4" Dia	12"	371	371	371	344			
		24"	371	371	371	344	416		
		36"	456	456	456	423			
		48"	561	561	561	521			
RM4810	1 1/2" x 1/4"	12"	306	306	306	278			
		24"	306	306	306	278	343		
		36"	376	376	376	343			
		48"	463	463	463	421			
RM4820	1 1/2" x 3/16"	12"	371	371	371	344			
		24"	371	371	371	344	416		
		36"	456	456	456	423			
		48"	561	561	561	521			
RM4800 x RM4810		12"	677	677	677	622			
		24"	677	677	677	622	758		
		36"	833	833	833	765			
		48"	1024	1024	1024	941			
RM4820 x RM4810		12"	677	677	677	622			
		24"	677	677	677	622	758		
		36"	833	833	833	765			
		48"	1024	1024	1024	941			

- RM4700 pulls contain white or black polycarbonate insert.
- RM4750 & RM4755 pulls add \$9.70/in. over 48". CTC up to 60".
- RM4800 series, US32D and US10BE come with Socket Head Screws. Other finishes come with Hex Head Screws.
- RM4800 series longer lengths may be offered, call factory for pricing.
- Specify CTC when ordering.

NOTE: Industrial Steel coming soon!

### SculpTrex - Shaped Cast Pulls

Part	CTC	3/605 4/606	10/612 10B/613	Stock PC 10BE	26/625 26D/626
RM5032	20"	781	844	796	781
RM5042	20"	781	844	796	781

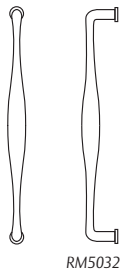

RM5032

**ASSA ABLOY**

The global leader in door opening solutions

PlanTek - Flat Front Pulls

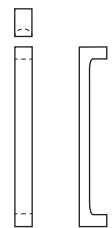

Straight Cast Pulls								
Part	CTC	Grip Size	3/605 4/606	10/612 10B/613	Stock PC 10BE	26/625 26D/626	32D/630	32/629
RM5200-7	7"	1"	257	277	265	257		
RM5200-12	12"	1"	296	320	306	296		
RM5202	12"	1 1/4"	374	404	386	374		

RM5200



Offset Cast Pulls								
Radius End Pulls								
RM5204-8	8"	1"	257	277	265	257		
RM5204-12	12"	1"	296	320	306	296		
RM5210-10	10"	1/2" x 1 1/4"	527	569	412		324	364
RM5210-12	12"	1/2" x 1 1/4"	548	591	428		341	381
RM5220-12	12"	3/4" x 1 1/2"	703	759	459		371	416
RM5220-18	18"	3/4" x 1 1/2"	783	846	508		420	471

RM5210

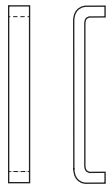

Square End Pulls								
RM5230-10	10"	1/2" x 1 1/4"	488	527	332		245	274
RM5230-12	12"	1/2" x 1 1/4"	510	551	347		260	290
RM5240-12	12"	3/4" x 1 1/2"	646	698	364		276	309
RM5240-18	18"	3/4" x 1 1/2"	722	781	379		292	328

RM5250

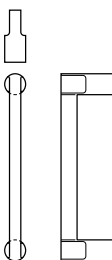

Bent End Pulls								
RM5250-10	10"	1/2" x 1 1/4"	394	425	316		228	255
RM5250-12	12"	1/2" x 1 1/4"	411	444	332		245	274
RM5260-12	12"	3/4" x 1 1/2"	527	569	379		292	328
RM5260-18	18"	3/4" x 1 1/2"	625	674	412		324	364

Radius End Pulls								
RM5270-10	10"	1/2" x 3/4"			396		309	346
RM5270-12	12"	1/2" x 3/4"			408		321	360
RM5270-16	16"	1/2" x 3/4"			438		350	393

Straight Cast Pull								
RM5280	9"	1/2" x 1/2"	120	129	123	120		

Push Bars - Radius Ends								
RM5212	Up to 36"	1/2" x 1 1/4"	722	781	490		403	452
RM5222	Up to 36"	3/4" x 1 1/2"	1092	1180	675		566	633

Push Bars - Flat Ends								
RM5232	Up to 36"	1/2" x 1 1/4"	722	781	428		341	381
RM5242	Up to 36"	3/4" x 1 1/2"	1074	1161	508		420	471

RM5270

- Add \$9.70/in. over 36".
- RM5200, RM5202, RM5204 CTC can not be modified.

NOTE: Post location on push bars can be located 1/8" from end for narrow & medium stile doors and 1" from end for flush and wide stile doors.

## Traditional - Decorative Pulls & Plates

Add pull price to plate price to make pull plate combination.

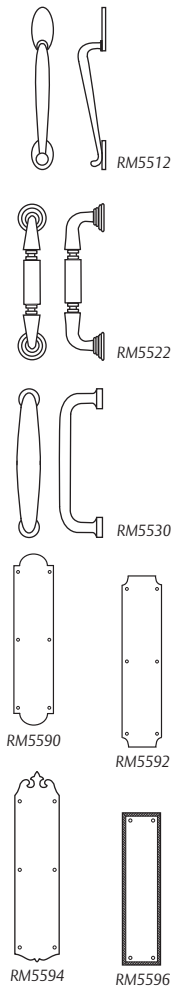

Cast Pulls							
Part	CTC	Base Plate	3/605 4/606	10/612 10B/613	Stock PC 10BE	15/619 15A/620	26/625 26D/626
RM5500	6"	no	100	107	101	112	100
RM5502	6 7/8"	yes	163	174	165	186	179
RM5510	12"	no	163	174	165	209	194
RM5512	12 7/8"	yes	227	246	232	288	259
Cast Pulls							
RM5520	8"	no	146	158	149	161	146
RM5522	8"	yes	179	192	181	192	179
Cast Pulls							
Part	Size		3/605 4/606	10/612 10B/613	Stock PC 10BE	15/619 15A/620	26/625 26D/626
RM5530	5 1/2"		51	55	52	62	51
RM5532	7 1/2"		74	80	76	85	79
RM5534	12"		220	237	224	232	220
Heavy Decorative Plates - .090" Thick							
RM5590A	3" x 12"		86	94	89	104	95
RM5590B	3 1/2" x 15"		95	103	97	110	105
RM5590C	4" x 16"		105	113	107	120	111
Heavy Decorative Plates - .090" Thick							
RM5592A	3" x 12"		86	94	89	104	95
RM5592B	3 1/2" x 15"		95	103	97	110	105
RM5592C	4" x 16"		105	113	107	120	111
Heavy Decorative Plates - .090" Thick							
RM5594B	3 1/2" x 15"		172	186	176	187	179
Rope Border Cast Plates							
RM5596A	3" x 12"		105	113	107	110	105
RM5596B	3 1/2" x 15"		121	131	123	127	121
Plain Cast Plate - 5/16" Thick							
RM5598B	3 1/2" x 15"		138	148	140	143	138

## Classic - Finial Door Pulls

1" Door Pulls								
Part	CTC	Grip	Base Plate	3/605 4/606	10/612 10B/613	Stock PC 10BE	15/619 15A/620	26/625 26D/626
RM5650	10"	Plain	no	357	386	369	420	394
RM5652	10"	Rope	no	357	386	369	420	394
RM5654	10"	Fluted	no	357	386	369	420	394
RM5660	10"	Plain	yes	399	430	412	463	436
RM5662	10"	Rope	yes	399	430	412	463	436
RM5664	10"	Fluted	yes	399	430	412	463	436
1" Offset Door Pull								
RM5670	10"	Plain	no	403	436	417	447	439

- To order suffix finial style number.
- Add \$6.50/in. for longer pulls up to 36".

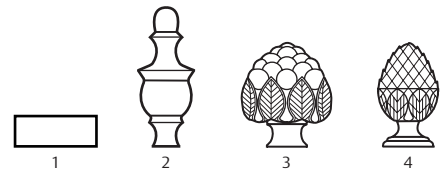

Finial Style Number (example: RM5650-4)

Suffix	Finial Style:
1	Plain
2	Urn
3	Berry
4	Pinecone

## MariTek - Tapered Pulls

Straight Door Pulls						
Part	CTC	3/605 4/606	10B/613	Stock PC 10BE	14/618 15/619	26/625 26D/626
RM5700	6"	264	283	272	270	280
RM5702	12"	280	301	288	286	294

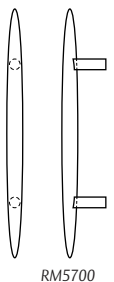

**ASSA ABLOY**

The global leader in door opening solutions

English Bridle Leather Pulls

Straight Pulls - Flat Ends							
Part	Max OA	Dia.	3/605 4/606	10/612 108/613	Stock PC 10BE	32D/630	32/629
RM6000	12"	1"	732	791	658	555	622
	24"	1"	1,085	1,172	961	837	938
	36"	1"	1,438	1,552	1,243	1,120	1,254
	48"	1"	1,790	1,933	1,527	1,404	1,573
	60"	1"	2,157	2,329	1,812	1,688	1,891
	72"	1"	2,522	2,724	2,096	1,972	2,209
	84"	1"	2,726	2,944	2,204	2,081	2,330
	96"	1"	2,929	3,164	2,313	2,190	2,452
RM6010	12"	1 1/4"	816	881	746	643	720
	24"	1 1/4"	1,328	1,434	1,168	1,044	1,170
	36"	1 1/4"	1,840	1,987	1,570	1,446	1,619
	48"	1 1/4"	2,262	2,443	1,920	1,796	2,012
	60"	1 1/4"	2,684	2,898	2,270	2,147	2,404
	72"	1 1/4"	2,820	3,046	2,402	2,278	2,551
	84"	1 1/4"	2,955	3,192	2,533	2,409	2,699
	96"	1 1/4"	3,091	3,338	2,643	2,519	2,822
RM6020	12"	1 1/2"	929	1,003	838	735	824
	24"	1 1/2"	1,482	1,601	1,295	1,171	1,311
	36"	1 1/2"	2,034	2,197	1,730	1,607	1,799
	48"	1 1/2"	2,482	2,680	1,934	1,811	2,028
	60"	1 1/2"	2,929	3,164	2,138	2,015	2,257
	72"	1 1/2"	3,092	3,340	2,343	2,220	2,485
	84"	1 1/2"	3,256	3,516	2,547	2,424	2,714
	96"	1 1/2"	3,419	3,693	2,751	2,628	2,943
Offset Pulls - Flat Ends							
RM6030	12"	1"	768	830	689	586	656
	24"	1"	1,121	1,210	992	868	972
	36"	1"	1,474	1,591	1,274	1,151	1,289
	48"	1"	1,826	1,972	1,558	1,435	1,607
	60"	1"	2,193	2,368	1,843	1,719	1,925
	72"	1"	2,559	2,763	2,127	2,003	2,243
	84"	1"	2,762	2,983	2,235	2,112	2,365
	96"	1"	2,965	3,202	2,344	2,221	2,487
RM6040	12"	1 1/4"	852	920	777	674	754
	24"	1 1/4"	1,364	1,473	1,199	1,075	1,204
	36"	1 1/4"	1,876	2,026	1,601	1,477	1,654
	48"	1 1/4"	2,298	2,481	1,951	1,827	2,047
	60"	1 1/4"	2,720	2,938	2,301	2,177	2,439
	72"	1 1/4"	2,856	3,084	2,433	2,309	2,585
	84"	1 1/4"	2,991	3,231	2,564	2,440	2,733
	96"	1 1/4"	3,127	3,377	2,674	2,550	2,856
RM6050	12"	1 1/2"	965	1,042	869	766	858
	24"	1 1/2"	1,518	1,639	1,326	1,202	1,346
	36"	1 1/2"	2,070	2,236	1,761	1,638	1,834
	48"	1 1/2"	2,518	2,719	1,965	1,842	2,063
	60"	1 1/2"	2,965	3,202	2,169	2,046	2,292
	72"	1 1/2"	3,128	3,378	2,374	2,251	2,520
	84"	1 1/2"	3,292	3,555	2,578	2,454	2,749
	96"	1 1/2"	3,455	3,731	2,782	2,658	2,978

Straight Pulls - Round Ends							
Part	Max OA	Dia.	3/605 4/606	10/612 108/613	Stock PC 10BE	32D/630	32/629
RM6004	12"	1"	811	876	694	591	662
	24"	1"	1,085	1,172	997	873	979
	36"	1"	1,438	1,552	1,279	1,156	1,295
	48"	1"	1,790	1,933	1,564	1,440	1,613
	60"	1"	2,157	2,329	1,848	1,724	1,931
	72"	1"	2,522	2,724	2,132	2,009	2,250
	84"	1"	2,726	2,944	2,240	2,117	2,371
	96"	1"	2,929	3,164	2,349	2,226	2,493
RM6014	12"	1 1/4"	816	881	782	679	760
	24"	1 1/4"	1,328	1,434	1,204	1,080	1,210
	36"	1 1/4"	1,840	1,987	1,606	1,482	1,660
	48"	1 1/4"	2,262	2,443	1,956	1,832	2,052
	60"	1 1/4"	2,684	2,898	2,306	2,183	2,444
	72"	1 1/4"	2,820	3,046	2,438	2,314	2,591
	84"	1 1/4"	2,955	3,192	2,569	2,445	2,739
	96"	1 1/4"	3,091	3,338	2,679	2,555	2,862
RM6024	12"	1 1/2"	929	1,003	874	771	864
	24"	1 1/2"	1,482	1,601	1,331	1,207	1,352
	36"	1 1/2"	2,034	2,197	1,766	1,643	1,840
	48"	1 1/2"	2,482	2,680	1,970	1,847	2,068
	60"	1 1/2"	2,929	3,164	2,174	2,051	2,297
	72"	1 1/2"	3,092	3,340	2,379	2,256	2,526
	84"	1 1/2"	3,256	3,516	2,583	2,460	2,754
	96"	1 1/2"	3,419	3,693	2,787	2,664	2,983
Offset Pulls - Round Ends							
RM6034	12"	1"	846	914	725	622	696
	24"	1"	1,198	1,294	1,028	904	1,012
	36"	1"	1,551	1,675	1,310	1,187	1,329
	48"	1"	1,903	2,056	1,594	1,471	1,647
	60"	1"	2,270	2,451	1,879	1,755	1,965
	72"	1"	2,636	2,847	2,163	2,039	2,285
	84"	1"	2,840	3,066	2,271	2,148	2,405
	96"	1"	3,043	3,286	2,380	2,257	2,528
RM6044	12"	1 1/4"	929	1,003	813	710	795
	24"	1 1/4"	1,441	1,556	1,235	1,111	1,244
	36"	1 1/4"	1,953	2,109	1,637	1,513	1,694
	48"	1 1/4"	2,375	2,565	1,987	1,863	2,087
	60"	1 1/4"	2,797	3,021	2,337	2,213	2,479
	72"	1 1/4"	2,933	3,167	2,469	2,345	2,627
	84"	1 1/4"	3,068	3,315	2,600	2,476	2,773
	96"	1 1/4"	3,204	3,461	2,710	2,586	2,896
RM6054	12"	1 1/2"	1,042	1,126	905	802	898
	24"	1 1/2"	1,595	1,722	1,362	1,238	1,386
	36"	1 1/2"	2,148	2,320	1,797	1,674	1,875
	48"	1 1/2"	2,596	2,803	2,001	1,878	2,103
	60"	1 1/2"	3,043	3,286	2,205	2,082	2,332
	72"	1 1/2"	3,205	3,462	2,410	2,287	2,561
	84"	1 1/2"	3,369	3,638	2,614	2,491	2,789
	96"	1 1/2"	3,532	3,814	2,818	2,694	3,018

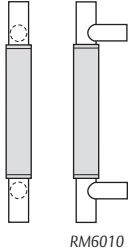

RM6010

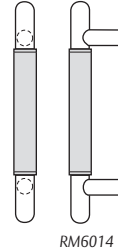

RM6014

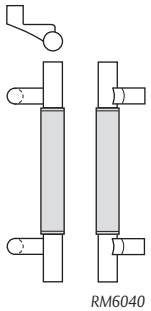

RM6040

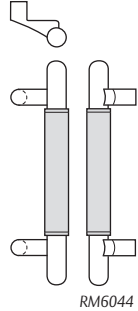

RM6044

- Add \$6.50/in. over 96".
- MP (Mid Post) - Add \$76 each. (Recommended for maximum rigidity on long door pulls. See page 5 for guidelines.)
- FW (Full Wrap) available up to 72" overall length pull - Call for pricing.
- Specify leather color.

NOTE: All long pulls include charge for leather between mounting posts up to a maximum of 72" of leather cover.









Leather Oval - Ergonomic Pulls

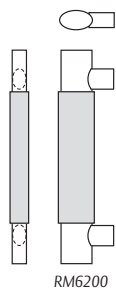

True Oval					
Part	Max OA	Grip Size	Stock PC 10BE	32D/630	32/629
<b>RM6200</b>	12"	1" x 1 1/2"	871	768	861
	24"	1" x 1 1/2"	1220	1096	1227
	36"	1" x 1 1/2"	1547	1423	1594
	48"	1" x 1 1/2"	1875	1751	1961
	60"	1" x 1 1/2"	2202	2079	2328
	72"	1" x 1 1/2"	2530	2406	2695
	84"	1" x 1 1/2"	2857	2734	3062
	96"	1" x 1 1/2"	3185	3061	3428
Flat Oval - 3/4" Diameter Posts					
Part	Max OA	Grip Size	Stock PC 10BE	32D/630	32/629
<b>RM6220</b>	12"	3/4" x 1 1/2"	908	805	902
	24"	3/4" x 1 1/2"	1251	1128	1263
	36"	3/4" x 1 1/2"	1574	1450	1624
	48"	3/4" x 1 1/2"	1896	1773	1985
	60"	3/4" x 1 1/2"	2219	2095	2346
	72"	3/4" x 1 1/2"	2541	2417	2707
	84"	3/4" x 1 1/2"	2863	2740	3069
	96"	3/4" x 1 1/2"	3186	3062	3430

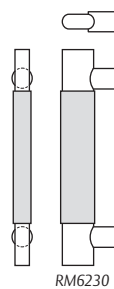

Flat Oval - 1" Diameter Posts					
Part	Max OA	Grip Size	Stock PC 10BE	32D/630	32/629
<b>RM6230</b>	12"	3/4" x 1 1/2"	961	837	938
	24"	3/4" x 1 1/2"	1283	1160	1299
	36"	3/4" x 1 1/2"	1606	1482	1660
	48"	3/4" x 1 1/2"	1928	1805	2021
	60"	3/4" x 1 1/2"	2251	2127	2382
	72"	3/4" x 1 1/2"	2573	2449	2743
	84"	3/4" x 1 1/2"	2895	2772	3104
	96"	3/4" x 1 1/2"	3218	3094	3465
Flat Oval - 3/4" x 1 1/2" Diameter Posts					
Part	Max OA	Grip Size	Stock PC 10BE	32D/630	32/629
<b>RM6240</b>	12"	3/4" x 1 1/2"	1083	959	1074
	24"	3/4" x 1 1/2"	1405	1281	1435
	36"	3/4" x 1 1/2"	1727	1604	1796
	48"	3/4" x 1 1/2"	2050	1926	2157
	60"	3/4" x 1 1/2"	2372	2248	2518
	72"	3/4" x 1 1/2"	2694	2571	2879
	84"	3/4" x 1 1/2"	3017	2893	3240
	96"	3/4" x 1 1/2"	3339	3216	3602

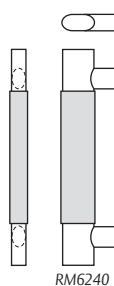
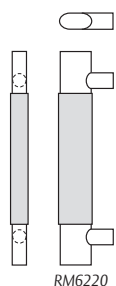

- Add \$6.50/in. over 96".
- MP (Mid Post) - Add \$68 each. (Recommended for maximum rigidity on long door pulls. See page 5 for guidelines.)
- Specify leather color.

NOTE: All long pulls include charge for leather between mounting posts up to a maximum of 72" of leather cover.

Flush Leather Pulls

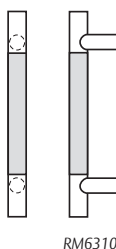

Straight Pulls - Flat Ends							
Part	Max OA	Dia.	3/605 4/606	10/612 10B/613	Stock PC 10BE	32D/630	32/629
<b>RM6300</b>	12"	1"	816	881	750	647	724
	24"	1"	1217	1315	1140	1017	1139
	36"	1"	1619	1749	1510	1386	1553
	48"	1"	2021	2183	1880	1756	1967
	60"	1"	2423	2616	2250	2126	2381
	72"	1"	2824	3050	2619	2496	2795
	84"	1"	3226	3484	2989	2865	3209
	96"	1"	3628	3918	3359	3235	3623
<b>RM6310</b>	12"	1 1/4"	979	1057	871	768	861
	24"	1 1/4"	1397	1508	1264	1140	1277
	36"	1 1/4"	1815	1960	1636	1512	1693
	48"	1 1/4"	2233	2412	2007	1884	2110
	60"	1 1/4"	2651	2863	2379	2256	2526
	72"	1 1/4"	3069	3315	2751	2628	2943
	84"	1 1/4"	3488	3767	3123	2999	3359
	96"	1 1/4"	3906	4218	3495	3371	3776
<b>RM6320</b>	12"	1 1/2"	1059	1144	969	846	947
	24"	1 1/2"	1488	1607	1352	1229	1376
	36"	1 1/2"	1918	2071	1736	1612	1805
	48"	1 1/2"	2347	2535	2119	1995	2235
	60"	1 1/2"	2777	2999	2502	2378	2664
	72"	1 1/2"	3206	3463	2885	2761	3093
	84"	1 1/2"	3636	3927	3268	3145	3522
	96"	1 1/2"	4065	4391	3651	3528	3951

Flush Leather Pulls (cont')

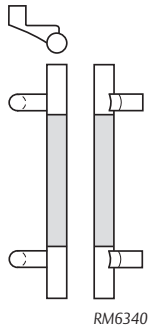

RM6340

Offset Pulls - Flat Ends								
Part	Max OA	Dia.	3/605 4/606	10/612 108/613	Stock PC 10BE	32D/630	32/629	
<b>RM6330</b>	12"	1"	852	920	786	683	765	
	24"	1"	1254	1354	1176	1053	1179	
	36"	1"	1655	1788	1546	1422	1593	
	48"	1"	2057	2221	1916	1792	2007	
	60"	1"	2459	2655	2286	2162	2421	
	72"	1"	2860	3089	2655	2532	2836	
	84"	1"	3262	3523	3025	2902	3250	
	96"	1"	3664	3957	3395	3271	3664	
	<b>RM6340</b>	12"	1 1/4"	1015	1096	907	804	901
		24"	1 1/4"	1433	1547	1300	1176	1317
36"		1 1/4"	1851	1999	1672	1548	1734	
48"		1 1/4"	2269	2451	2044	1920	2150	
60"		1 1/4"	2687	2902	2415	2292	2567	
72"		1 1/4"	3105	3354	2787	2664	2983	
84"		1 1/4"	3524	3806	3159	3035	3400	
96"		1 1/4"	3942	4257	3531	3407	3816	
<b>RM6350</b>		12"	1 1/2"	1095	1182	1005	882	987
		24"	1 1/2"	1524	1646	1388	1265	1417
	36"	1 1/2"	1954	2110	1772	1648	1846	
	48"	1 1/2"	2383	2574	2155	2031	2275	
	60"	1 1/2"	2813	3038	2538	2414	2704	
	72"	1 1/2"	3242	3502	2921	2797	3133	
	84"	1 1/2"	3672	3966	3304	3181	3562	
	96"	1 1/2"	4101	4430	3687	3564	3991	
	Straight Pulls - Round Ends							
	<b>RM6304</b>	12"	1"	898	970	796	693	776
24"		1"	1300	1404	1187	1063	1191	
36"		1"	1702	1838	1556	1433	1605	
48"		1"	2103	2272	1926	1803	2019	
60"		1"	2505	2705	2296	2172	2433	
72"		1"	2907	3139	2666	2542	2847	
84"		1"	3308	3573	3035	2912	3261	
96"		1"	3710	4007	3405	3282	3675	
<b>RM6314</b>		12"	1 1/4"	1061	1146	918	815	912
		24"	1 1/4"	1479	1597	1310	1187	1329
	36"	1 1/4"	1897	2049	1682	1558	1745	
	48"	1 1/4"	2315	2501	2054	1930	2162	
	60"	1 1/4"	2734	2952	2426	2302	2578	
	72"	1 1/4"	3152	3404	2797	2674	2995	
	84"	1 1/4"	3570	3856	3169	3046	3411	
	96"	1 1/4"	3988	4307	3541	3418	3828	
	<b>RM6324</b>	12"	1 1/2"	1141	1233	1016	892	999
		24"	1 1/2"	1571	1696	1399	1275	1428
36"		1 1/2"	2000	2160	1782	1658	1857	
48"		1 1/2"	2430	2624	2165	2041	2286	
60"		1 1/2"	2859	3088	2548	2425	2716	
72"		1 1/2"	3289	3552	2931	2808	3145	
84"		1 1/2"	3718	4016	3315	3191	3574	
96"		1 1/2"	4148	4480	3698	3574	4003	

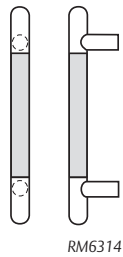

RM6314

- Add \$6.50/in. over 96".
- Up to 96" available with mid-post (Recommended for maximum rigidity on long door pulls. See page 5 for guidelines.)
- Specify leather type and color.

**ASSA ABLOY**

The global leader in door opening solutions

Flush Leather Pulls (cont')

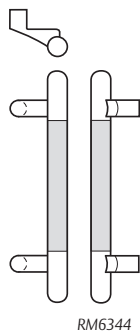

Offset Pulls - Round Ends							
Part	Max OA	Dia.	3/605 4/606	10/612 108/613	Stock PC 10BE	32D/630	32/629
<b>RM6334</b>	12"	1"	934	1009	832	729	817
	24"	1"	1336	1443	1223	1099	1231
	36"	1"	1738	1877	1592	1469	1645
	48"	1"	2139	2310	1962	1839	2059
	60"	1"	2541	2744	2332	2208	2473
	72"	1"	2943	3178	2702	2578	2887
	84"	1"	3344	3612	3071	2948	3302
<b>RM6344</b>	12"	1 1/4"	1097	1185	974	851	953
	24"	1 1/4"	1515	1636	1346	1223	1369
	36"	1 1/4"	1933	2088	1718	1594	1786
	48"	1 1/4"	2351	2540	2090	1966	2202
	60"	1 1/4"	2770	2991	2462	2338	2619
	72"	1 1/4"	3188	3443	2834	2710	3035
	84"	1 1/4"	3606	3895	3205	3082	3452
<b>RM6354</b>	12"	1 1/2"	1177	1271	1052	928	1039
	24"	1 1/2"	1607	1735	1435	1311	1469
	36"	1 1/2"	2036	2199	1818	1694	1898
	48"	1 1/2"	2466	2663	2201	2078	2327
	60"	1 1/2"	2895	3127	2584	2461	2756
	72"	1 1/2"	3325	3591	2967	2844	3185
	84"	1 1/2"	3754	4055	3351	3227	3614
96"	1 1/2"	4184	4519	3734	3610	4043	

- Add \$6.50/in. over 96".
- Up to 96" available with mid-post (Recommended for maximum rigidity on long door pulls. See page 5 for guidelines.)
- Specify leather type and color.

Upholstery Leather GeoMetek - Narrow Profile Pulls

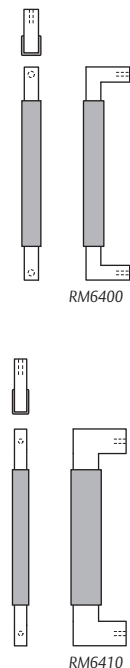

Straight Square End Pulls					
Part	CTC	Grip Size	Stock PC 10BE	32D/630	32/629
<b>RM6400</b>	12"	3/4" x 3/4"	608	502	562
	24"	3/4" x 3/4"	976	849	951
	36"	3/4" x 3/4"	1323	1196	1339
	48"	3/4" x 3/4"	1670	1543	1728
<b>RM6440</b>	12"	1 1/4" x 1 1/4"	705	599	671
	24"	1 1/4" x 1 1/4"	1165	1038	1162
	36"	1 1/4" x 1 1/4"	1603	1476	1653
	48"	1 1/4" x 1 1/4"	2041	1914	2144
Straight Rectangular End Pulls					
<b>RM6410</b>	12"	3/4" x 1 1/2"	711	605	677
	24"	3/4" x 1 1/2"	1024	896	1004
	36"	3/4" x 1 1/2"	1316	1188	1331
	48"	3/4" x 1 1/2"	1607	1480	1658
	60"	3/4" x 1 1/2"	1899	1772	1984
	72"	3/4" x 1 1/2"	2191	2063	2311
	84"	3/4" x 1 1/2"	2483	2355	2638
	96"	3/4" x 1 1/2"	2774	2647	2965

Offset Square End Pulls					
Part	CTC	Grip Size	Stock PC 10BE	32D/630	32/629
<b>RM6420</b>	12"	3/4" x 3/4"	645	539	604
	24"	3/4" x 3/4"	1013	886	992
	36"	3/4" x 3/4"	1360	1233	1381
	48"	3/4" x 3/4"	1707	1580	1769
Offset Rectangular End Pulls					
<b>RM6430</b>	12"	3/4" x 1 1/2"	748	642	719
	24"	3/4" x 1 1/2"	1061	934	1046
	36"	3/4" x 1 1/2"	1353	1225	1372
	48"	3/4" x 1 1/2"	1644	1517	1699
	60"	3/4" x 1 1/2"	1936	1809	2026
	72"	3/4" x 1 1/2"	2228	2101	2353
	84"	3/4" x 1 1/2"	2520	2392	2679
	96"	3/4" x 1 1/2"	2811	2684	3006

Leather - Small Pulls for Cabinets, Casework & Closet Doors

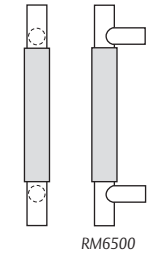

RM6500

Straight Surface Wrapped - Flat Ends							
Part	Max OA	Dia.	3/605 4/606	10/612 108/613	Stock PC 10BE	32D/630	32/629
RM6500-4	5 7/8"	1/2"	179	193	190	138	147
RM6500-5	6 7/8"	1/2"	191	206	200	148	159
RM6510-5	6 7/8"	5/8"	219	237	228	176	190
RM6510-6	7 7/8"	5/8"	246	266	253	202	215

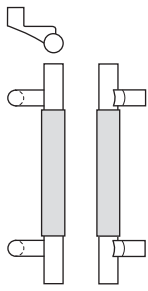

RM6530

Offset Surface Wrapped - Flat Ends							
RM6530-5	7"	5/8"			295	226	242
RM6530-6	8"	5/8"			321	250	268

Straight Surface Wrapped - Round Ends							
RM6540-4	5 7/8"	1/2"	197	213	207	156	166
RM6540-5	6 7/8"	1/2"	211	229	219	168	179
RM6550-5	7"	5/8"	239	259	246	195	208
RM6550-6	8"	5/8"	265	286	286	218	234

Offset Surface Wrapped - Round Ends							
RM6570-5	7"	5/8"			315	244	261
RM6570-6	8"	5/8"			342	269	287

Straight Flush Wrapped - Flat Ends							
RM6610-5	6 7/8"	5/8"	246	266	238	186	199
RM6610-6	7 7/8"	5/8"	277	300	299	216	231

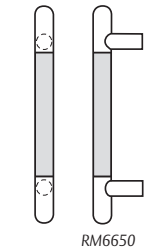

RM6650

Offset Flush Wrapped - Flat Ends							
RM6630-5	6 7/8"	5/8"			308	226	242
RM6630-6	7 7/8"	5/8"			340	258	275

Straight Flush Wrapped - Round Ends							
RM6650-5	6 7/8"	5/8"	260	279	250	199	212
RM6650-6	7 7/8"	5/8"	291	315	311	229	245

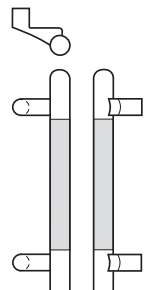

RM6670

Offset Flush Wrapped - Round Ends							
RM6670-5	6 7/8"	5/8"			321	239	255
RM6670-6	7 7/8"	5/8"			351	269	287

Straight Full Wrapped - Flat Ends							
RM6700-4	5 7/8"	1/2"	205	220	220	178	192
RM6700-5	6 7/8"	1/2"	231	248	248	202	215
RM6710-5	6 7/8"	5/8"	251	272	272	221	238
RM6710-6	7 7/8"	5/8"	282	304	304	250	268

Offset Full Wrapped - Flat Ends							
RM6730-5	6 7/8"	5/8"			318	262	279
RM6730-6	7 7/8"	5/8"			349	290	310

- Any size made to order.
- Specify leather type and color.

ASSA ABLOY

The global leader in door opening solutions

NeoCylinder - with or without GripZone

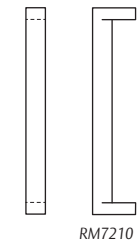

Straight Pulls without GripZone					
Part	CTC	Dia.	Stock PC 10BE	32D/630	32/629
RM7210	12"	1 1/4"	381	294	329
	24"	1 1/4"	431	344	385
	36"	1 1/4"	481	394	441

Offset Pulls without GripZone					
RM7220	12"	1 1/4"	419	332	372
	24"	1 1/4"	469	382	428
	36"	1 1/4"	520	432	484

Straight Pulls with GripZone					
RM7230	12"	1 1/4"			438
	24"	1 1/4"			494
	36"	1 1/4"			551

Offset Pulls with GripZone					
RM7240	12"	1 1/4"			476
	24"	1 1/4"			533
	36"	1 1/4"			589

Push Bar without GripZone

RM7212	Up to 36"	1 1/4"	481	394	441
--------	-----------	--------	-----	-----	-----

Push Bar with GripZone

RM7232	Up to 36"	1 1/4"			551
--------	-----------	--------	--	--	-----

• Add \$6.50/in. over 36".

NeoMitre - with or without GripZone

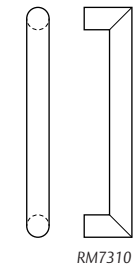

Straight Pulls without GripZone					
Part	CTC	Dia.	Stock PC 10BE	32D/630	32/629
RM7300	12"	1"	403	317	355
	24"	1"	471	386	432
	36"	1"	561	454	509
RM7310	12"	1 1/4"	542	435	487
	24"	1 1/4"	582	475	531
	36"	1 1/4"	621	514	576
RM7320	12"	1 1/2"	623	516	578
	24"	1 1/2"	664	557	624
	36"	1 1/2"	705	598	669

Offset Pulls without GripZone					
RM7330	12"	1"	440	355	397
	24"	1"	509	423	474
	36"	1"	599	492	551

RM7340	12"	1 1/4"	580	472	529
	24"	1 1/4"	619	512	573
	36"	1 1/4"	659	552	618
RM7350	12"	1 1/2"	661	554	620
	24"	1 1/2"	702	595	666
	36"	1 1/2"	742	635	711

Push Bars without GripZone

RM7302	Up to 36"	1"	561	454	509
--------	-----------	----	-----	-----	-----

RM7312	Up to 36"	1 1/4"	621	514	576
--------	-----------	--------	-----	-----	-----

RM7322	Up to 36"	1 1/2"	705	598	669
--------	-----------	--------	-----	-----	-----

• Add \$6.50/in. over 36".

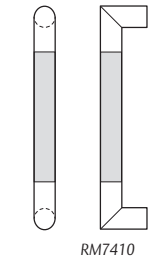

Straight Pulls with GripZone			
Part	CTC	Dia.	32/629
RM7400	12"	1"	462
	24"	1"	539
	36"	1"	616

RM7410	12"	1 1/4"	594
	24"	1 1/4"	639
	36"	1 1/4"	683

RM7420	12"	1 1/2"	685
	24"	1 1/2"	731
	36"	1 1/2"	777

Offset Pulls with GripZone

RM7430	12"	1"	504
	24"	1"	581
	36"	1"	658

RM7440	12"	1 1/4"	636
	24"	1 1/4"	681
	36"	1 1/4"	725

RM7450	12"	1 1/2"	727
	24"	1 1/2"	773
	36"	1 1/2"	819

Push Bars with GripZone

RM7402	Up to 36"	1"	616
--------	-----------	----	-----

RM7412	Up to 36"	1 1/4"	683
--------	-----------	--------	-----

RM7422	Up to 36"	1 1/2"	777
--------	-----------	--------	-----

• Add \$6.50/in. over 36".

NOTE: Post location on push bars can be located 1/8" from end for narrow & medium stile doors and 1" from end for flush and wide stile doors.



GeoMetek - Diamond Pulls

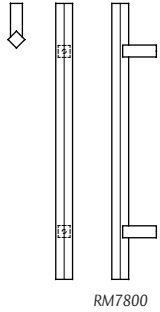

Flat End - Square Post					
Part	Max OA	Grip	Stock PC 10BE	32D/630	32/629
RM7800	12"	3/4" x 3/4"	393	308	345
	24"	3/4" x 3/4"	435	350	393
	36"	3/4" x 3/4"	478	394	441
	48"	3/4" x 3/4"	542	436	488
Flat End - Diamond Post					
RM7805	12"	3/4" x 3/4"	419	334	374
	24"	3/4" x 3/4"	461	377	422
	36"	3/4" x 3/4"	505	420	471
	48"	3/4" x 3/4"	569	463	518

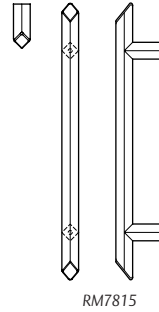

Diamond End - Square Post					
Part	Max OA	Grip	Stock PC 10BE	32D/630	32/629
RM7810	12"	3/4" x 3/4"	546	440	508
	24"	3/4" x 3/4"	589	483	541
	36"	3/4" x 3/4"	632	526	590
	48"	3/4" x 3/4"	675	569	637
Diamond End - Diamond Post					
RM7815	12"	3/4" x 3/4"	573	467	523
	24"	3/4" x 3/4"	615	509	571
	36"	3/4" x 3/4"	659	553	620
	48"	3/4" x 3/4"	701	595	666

• Add \$9.70/in. over 48".

GeoMetek - Narrow Profile Pulls

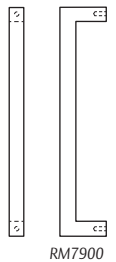

Straight Square End Pulls					
Part	CTC	Grip Size	Stock PC 10BE	32D/630	32/629
RM7900	12"	3/4" x 3/4"	260	207	231
	24"	3/4" x 3/4"	335	250	280
	36"	3/4" x 3/4"	379	294	329
	48"	3/4" x 3/4"	423	338	379
RM7940	12"	1 1/4" x 1 1/4"	347	262	294
	24"	1 1/4" x 1 1/4"	397	312	349
	36"	1 1/4" x 1 1/4"	447	362	405
	48"	1 1/4" x 1 1/4"	495	411	459

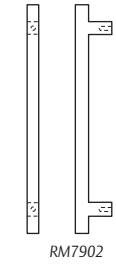

Straight Square Bridge Pulls					
Part	CTC	Grip Size	Stock PC 10BE	32D/630	32/629
RM7902	12"	3/4" x 3/4"	339	255	285
	24"	3/4" x 3/4"	382	297	333
	36"	3/4" x 3/4"	425	341	382
	48"	3/4" x 3/4"	468	383	429

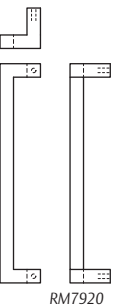

Straight Rectangular End Pulls					
Part	CTC	Grip Size	Stock PC 10BE	32D/630	32/629
RM7910	12"	3/4" x 1 1/2"	324	239	267
	24"	3/4" x 1 1/2"	500	415	465
	36"	3/4" x 1 1/2"	698	592	663
	48"	3/4" x 1 1/2"	871	768	860

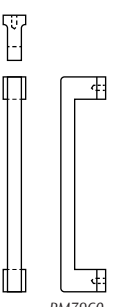

Straight Rectangular Bridge Pulls					
Part	CTC	Grip Size	Stock PC 10BE	32D/630	32/629
RM7912	12"	3/4" x 1 1/2"	369	284	318
	24"	3/4" x 1 1/2"	567	460	516
	36"	3/4" x 1 1/2"	743	637	713
	48"	3/4" x 1 1/2"	919	813	910



Offset Pulls					
Part	CTC	Grip Size	Stock PC 10BE	32D/630	32/629
RM7920	12"	3/4" x 3/4"	326	241	269
	24"	3/4" x 3/4"	366	281	315
	36"	3/4" x 3/4"	407	323	361
	48"	3/4" x 3/4"	448	363	406
RM7930	12"	3/4" x 1 1/2"	367	282	316
	24"	3/4" x 1 1/2"	556	450	504
	36"	3/4" x 1 1/2"	725	619	693
	48"	3/4" x 1 1/2"	892	786	881

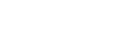

Straight Rectangular End Stepped Post Pull					
Part	CTC	Grip Size	Stock PC 10BE	32D/630	32/629
RM7960	12"	3/4" x 3/4"	369	284	318
	24"	3/4" x 3/4"	418	333	373
	36"	3/4" x 3/4"	466	381	426
	48"	3/4" x 3/4"	536	430	482

Straight Rectangular End Stepped Post Cast Pull					
Part	CTC	Grip Size	Stock PC 10BE	32D/630	32/629
RM7960	12"	3/4" x 3/4"	356	384	409

• Add \$9.70/in. over 48".

ASSA ABLOY

Locking Door Pulls

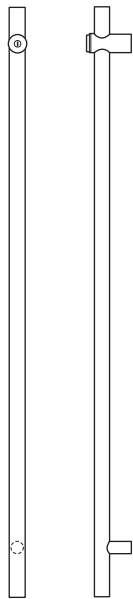

LP3301DBD

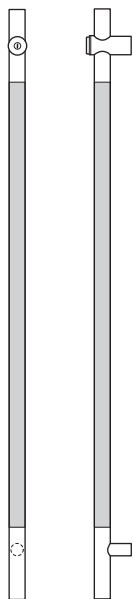

LP3401DBD

PostMount - Round						
Part	Description	3/605 4/606	Stock PC 10BE	10B/613 10BL/614	32/629	32D/630
LP3301DBD	Half Height Pull - Bolts Down	1,822	1,419	1,968	1,172	1,048
LP3301DBU	Half Height Pull - Bolts Up	1,999	1,513	2,160	1,266	1,130
LP3301FHD	Full Height Pull - Bolts Down	2,212	1,604	2,391	1,357	1,211
LP3301FHU	Full Height Pull - Bolts Up	2,427	1,711	2,621	1,464	1,307
LP3301FHB	Full Height Pull - Bolts Up and Down	2,672	1,967	2,885	1,720	1,535
Horizontal Push/Pull Bar Option - Half Height – Bolts Down (DBD)						
LP3301DBDBEPB	Bent End Both Sides	2,424	1,808	2,617	1,560	1,393
LP3301DBDBEPT	Bent End Thumbturn Side - Mating Side Vertical	2,123	1,614	2,293	1,367	1,221
LP3301DBDBEPC	Bent End Cylinder Side - Mating Side Vertical	2,123	1,614	2,293	1,367	1,221
LP3301DBDPMPB	Post Mount Both Sides	2,659	1,930	2,873	1,683	1,502
LP3301DBDPMPT	Post Mount Thumbturn Side - Mating Side Vertical	2,330	1,721	2,515	1,474	1,315
LP3301DBDPMPC	Post Mount Cylinder Side - Mating Side Vertical	2,330	1,721	2,515	1,474	1,315
Horizontal Push/Pull Bar Option - Half Height – Bolts Up (DBU)						
LP3301DBUBEPB	Bent End Both Sides	2,424	1,808	2,617	1,560	1,393
LP3301DBUBEPT	Bent End Thumbturn Side - Mating Side Vertical	2,123	1,614	2,293	1,367	1,221
LP3301DBUBEPC	Bent End Cylinder Side - Mating Side Vertical	2,123	1,614	2,293	1,367	1,221
LP3301DBUPMPB	Post Mount Both Sides	2,659	1,930	2,873	1,683	1,502
LP3301DBUPMPT	Post Mount Thumbturn Side - Mating Side Vertical	2,330	1,721	2,515	1,474	1,315
LP3301DBUPMPC	Post Mount Cylinder Side - Mating Side Vertical	2,330	1,721	2,515	1,474	1,315
NeoTek with GripZone - Round						
Part	Description	3/605	32/629			
LP3401DBD	Half Height Pull - Bolts Down	1,953	1,259			
LP3401DBU	Half Height Pull - Bolts Up	2,142	1,357			
LP3401FHD	Full Height Pull - Bolts Down	2,342	1,452			
LP3401FHU	Full Height Pull - Bolts Up	2,570	1,566			
LP3401FHB	Full Height Pull - Bolts Up and Down	2,816	1,793			
Horizontal Push/Pull Bar Option - Half Height – Bolts Down (DBD)						
LP3401DBDBEPB	Bent End Both Sides	2,597	1,674			
LP3401DBDBEPT	Bent End Thumbturn Side - Mating Side Vertical	2,275	1,466			
LP3401DBDBEPC	Bent End Cylinder Side - Mating Side Vertical	2,275	1,466			
LP3401DBDPMPB	Post Mount Both Sides	2,597	1,674			
LP3401DBDPMPT	Post Mount Thumbturn Side - Mating Side Vertical	2,275	1,466			
LP3401DBDPMPC	Post Mount Cylinder Side - Mating Side Vertical	2,275	1,466			
Horizontal Push/Pull Bar Option - Half Height – Bolts Up (DBU)						
LP3401DBUBEPB	Bent End Both Sides	2,850	1,805			
LP3401DBUBEPT	Bent End Thumbturn Side - Mating Side Vertical	2,496	1,581			
LP3401DBUBEPC	Bent End Cylinder Side - Mating Side Vertical	2,496	1,581			
LP3401DBUPMPB	Post Mount Both Sides	2,850	1,805			
LP3401DBUPMPT	Post Mount Thumbturn Side - Mating Side Vertical	2,496	1,581			
LP3401DBUPMPC	Post Mount Cylinder Side - Mating Side Vertical	2,496	1,581			

- DBD and DBU priced as 51" overall. Add \$13/in. over 96" long for full height or 51" long for half height.
- Horizontal Push/Pull Option, add \$13/in. over 36".

NOTE: New square Locking Pulls only available in US10BE, US32, and US32D.

Locking Door Pulls (con't)

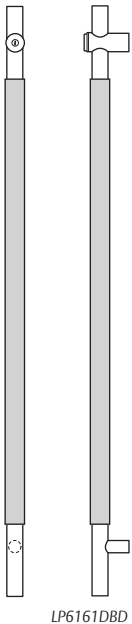
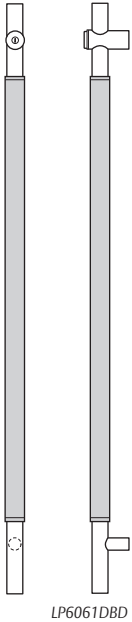

English Bridle Leather Wrapped - Round						
Part	Description	3/605 4/606	Stock PC 10BE	10B/613 10BL/614	32/629	32D/630
LP6061DBD	Half Height Pull - Bolts Down	5,074	4,266	5,480	4,640	4,143
LP6061DBU	Half Height Pull - Bolts Up	5,251	4,360	5,671	4,723	4,236
LP6061FHD	Full Height Pull - Bolts Down	6,461	5,492	6,977	6,012	5,368
LP6061FHU	Full Height Pull - Bolts Up	6,675	5,599	7,208	6,108	5,475
LP6061FHB	Full Height Pull - Bolts Up and Down	6,921	5,856	7,472	6,336	5,732
Horizontal Push/Pull Bar Option - Half Height – Bolts Down (DBD)						
LP6061DBDBEPB*	Bent End Both Sides	6,591	5,086	7,118	5,518	4,963
LP6061DBDBEPT*	Bent End Thumbturn Side - Mating Side Vertical	5,832	4,676	6,299	5,079	4,553
LP6061DBDBEPC*	Bent End Cylinder Side - Mating Side Vertical	5,832	4,676	6,299	5,079	4,553
LP6061DBDPMPT*	Post Mount Both Sides	6,591	5,086	7,118	5,518	4,963
LP6061DBDPMPT*	Post Mount Thumbturn Side - Mating Side Vertical	5,832	4,676	6,299	5,079	4,553
LP6061DBDPMPC*	Post Mount Cylinder Side - Mating Side Vertical	5,832	4,676	6,299	5,079	4,553
Horizontal Push/Pull Bar Option - Half Height – Bolts Up (DBU)						
LP6061DBUBEPB*	Bent End Both Sides	6,768	5,180	7,310	5,600	5,056
LP6061DBUBEPT*	Bent End Thumbturn Side - Mating Side Vertical	6,009	4,770	6,491	5,161	4,646
LP6061DBUBEPC*	Bent End Cylinder Side - Mating Side Vertical	6,009	4,770	6,491	5,161	4,646
LP6061DBUPMPB*	Post Mount Both Sides	6,768	5,180	7,310	5,600	5,056
LP6061DBUPMPT*	Post Mount Thumbturn Side - Mating Side Vertical	6,009	4,770	6,491	5,161	4,646
LP6061DBUPMPC*	Post Mount Cylinder Side - Mating Side Vertical	6,009	4,770	6,491	5,161	4,646
PostMount Upholstery Leather Wrapped - Round						
LP6161DBD	Half Height Pull - Bolts Down	4,975	4,180	5,372	4,543	4,056
LP6161DBU	Half Height Pull - Bolts Up	5,152	4,273	5,564	4,626	4,150
LP6161FHD	Full Height Pull - Bolts Down	6,137	5,169	6,628	5,651	5,045
LP6161FHU	Full Height Pull - Bolts Up	6,351	5,276	6,859	5,746	5,152
LP6161FHB	Full Height Pull - Bolts Up and Down	6,596	5,532	7,122	5,974	5,409
Horizontal Push/Pull Bar Option - Half Height – Bolts Down (DBD)						
LP6161DBDBEPB*	Bent End Both Sides	6,428	4,987	6,942	5,408	4,864
LP6161DBDBEPT*	Bent End Thumbturn Side - Mating Side Vertical	5,701	4,585	6,157	4,948	4,489
LP6161DBDBEPC*	Bent End Cylinder Side - Mating Side Vertical	5,701	4,585	6,157	4,948	4,489
LP6161DBDPMPT*	Post Mount Both Sides	6,428	4,987	6,942	5,408	4,864
LP6161DBDPMPT*	Post Mount Thumbturn Side - Mating Side Vertical	5,701	4,585	6,157	4,948	4,489
LP6161DBDPMPC*	Post Mount Cylinder Side - Mating Side Vertical	5,701	4,585	6,157	4,948	4,489
Horizontal Push/Pull Bar Option - Half Height – Bolts Up (DBU)						
LP6161DBUBEPB*	Bent End Both Sides	6,605	5,081	7,134	5,490	4,957
LP6161DBUBEPT*	Bent End Thumbturn Side - Mating Side Vertical	5,878	4,678	6,349	5,031	4,582
LP6161DBUBEPC*	Bent End Cylinder Side - Mating Side Vertical	5,878	4,678	6,349	5,031	4,582
LP6161DBUPMPB*	Post Mount Both Sides	6,605	5,081	7,134	5,490	4,957
LP6161DBUPMPT*	Post Mount Thumbturn Side - Mating Side Vertical	5,878	4,678	6,349	5,031	4,582
LP6161DBUPMPC*	Post Mount Cylinder Side - Mating Side Vertical	5,878	4,678	6,349	5,031	4,582

- DBD and DBU priced as 51" overall. Add \$13/in. over 96" long for full height or 51" long for half height.
- \* Price includes up to 42" of English Bridle Leather on vertical.
- Other options available upon request.

NOTE: New square Locking Pulls only available in US10BE, US32, and US32D.

**ASSA ABLOY**

The global leader in  
door opening solutions

Locking Door Pulls (con't)

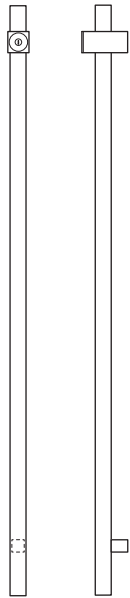

LP7901DBD

GeoMetek Upholstery Leather Wrapped - Square						
Part	Description	3/605 4/606	Stock PC 10BE	10B/613 10BL/614	32/629	32D/630
LP6440DBD	Half Height Pull - Bolts Down		4,392		4,780	4,268
LP6440DBU	Half Height Pull - Bolts Up		4,486		4,863	4,362
LP6440FHD	Full Height Pull - Bolts Down		5,381		5,887	5,257
LP6440FHU	Full Height Pull - Bolts Up		5,488		5,983	5,364
LP6440FHB	Full Height Pull - Bolts Up and Down		5,744		6,211	5,621
GeoMetek - Square						
LP7901DBD	Half Height Pull - Bolts Down		1,504		1,344	1,257
LP7901DBU	Half Height Pull - Bolts Up		1,602		1,449	1,354
LP7901FHD	Full Height Pull - Bolts Down		1,702		1,556	1,454
LP7901FHU	Full Height Pull - Bolts Up		1,815		1,677	1,568
LP7901FHB	Full Height Pull - Bolts Up and Down		2,088		1,969	1,841
MegaTek Dummy Pull - Round						
DP3301DBD	Half Height Pull - Bolts Down	1,430	1,086	1,545	896	838
DP3301DBU	Half Height Pull - Bolts Up	1,569	1,152	1,694	967	904
DP3301FHD	Full Height Pull - Bolts Down	1,953	1,338	2,109	1,167	1,091
DP3301FHU	Full Height Pull - Bolts Up	2,143	1,423	2,314	1,260	1,176
NeoTek with GripZone Dummy Pull - Round						
DP3401DBD	Half Height Pull - Bolts Down	1,532			1,006	
DP3401DBU	Half Height Pull - Bolts Up	1,682			1,086	
DP3401FHD	Full Height Pull - Bolts Down	2,067			1,307	
DP3401FHU	Full Height Pull - Bolts Up	2,269			1,410	
GeoMetek Dummy Pull - Square						
DP7901DBD	Half Height Pull - Bolts Down		1,251		1,074	1,004
DP7901DBU	Half Height Pull - Bolts Up		1,332		1,161	1,085
DP7901FHD	Full Height Pull - Bolts Down		1,556		1,401	1,309
DP7901FHU	Full Height Pull - Bolts Up		1,659		1,511	1,412

- DBD and DBU priced as 51" overall. Add \$13/in. over 96" long for full height or 51" long for half height.
- \* Price includes up to 42" of Upholstry Leather on vertical. Other options available upon request.

NOTE: New Square Locking Pulls only available in US10BE, US32, and US32D.

Locking Door Pull Accessories

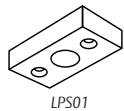

LPS01

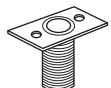

570

Part	Description	Stock PC 10BE	28/628	32/629	32D/630	
LPS01	Top Strike - 3/4" x 1 1/2" x 3"	40	40	77	69	
LPS02	Top Strike - w/Rubber Stop - 3/4" x 2 1/2" x 3"	40	40	77	69	
LPS03	Top Strike - Stainless Steel - .050" x 1 1/8" x 2 1/4"	40		36	32	
LPS04	Transom Strike - 1 1/4"D x 4"H	130		105	94	
LPS05	Transom Strike - 1 1/4"SQ x 4 1/2"H	151		122	109	
LPS06	Mortised Header Strike 2" Dia.	237		193	172	
Part	Description	3/605 4/606	10/612 10BL/614	Stock PC 10BE	26/625 26D/626	15/619
570	Dust Proof Strike	Refer to Accessories Price Book for Pricing				
Part	Description	3/605 4/606	10/612 10BL/614	Stock PC 10BE	26/625 26D/626	32D/630
RM850	Floor Mounted Stop 1 1/2" Projection	41	45	43	38	37
RM851	Floor Mounted Stop 2 1/2" Projection	52	57	55	52	48

NOTE: Thumbturn design differs between the round and square versions.

## Architectural Finishes

Most of Rockwood's products are available in all of the following architectural finishes. The catalog indicates exceptions. This finish list is grouped by base metal.

Base Metal	Description	Price Book Code	Rockwood Code	BHMA Code
Aluminum	Satin	27	US27	627
Aluminum	Clear Anodized	28	US28	628
Aluminum	Light Bronze Anodized	311	311	—
Aluminum	Medium Bronze Anodized	312	312	—
Aluminum	Dark Bronze Anodized	313	313	710
Aluminum	Extra Dark Bronze Anodized	314	314	—
Aluminum	Black Anodized	315	315	711
Aluminum	White Powder Coat	WPC	WPC	—
Aluminum	Red Powder Coat	RPC	RPC	—
Aluminum	Black Powder Coat	BPC	BPC	—
Brass	Polished Clear Coated	3	US3	605
Brass	Polished No Coating	3NL	US3NL	—
Brass	Satin Clear Coated	4	US4	606
Brass	Satin Oxidized Relieved	5	US5	609
Brass	Satin Nickel Plated Clear Coated	15	US15	619
Brass	Satin Nickel Blackened Relieved Clear Coated	15A	US15A	620
Brass	Flat Black Powder Coated	19	US19	622
Brass	Polished Chrome Plated	26	US26	625
Brass	Satin Chrome Plated	26D	US26D	626
Bronze*	Polished Clear Coated	9	US9	611
Bronze*	Satin Clear Coated	10	US10	612
Bronze*	Satin Black Oxidized Oil Rubbed	10A	US10A	—
Bronze*	Satin Oxidized Oil Rubbed	10B	US10B	613
Bronze*	Satin Oxidized Clear Coated	10BL	US10BL	614
Bronze*	Dark Oxidized Statuary Clear Coated	20A	US20A	624
Stainless Steel	Polished	32	US32	629
Stainless Steel	Satin	32D	US32D	630
<b>Special Finishes</b> (see descriptions)				
Stainless Steel	Satin MicroShield® Coated	32DMS***	US32DMS***	—
Stainless Steel	Polished 316 Alloy	32316***	US32316***	—
Stainless Steel	Satin 316 Alloy	32D316***	US32D316***	—
	Dark Oxidized Satin Bronze, Equivalent	10BE	US10BE	(613E)
	Black Suede Powder Coat	BSP	BSP	—
	Wrought Black Powder Coat	WB	WB	—

## Special Finishes Description

**32DMS** (MicroShield®): As part of its promise to provide innovative solutions to their customers, ASSA ABLOY Group companies offer the MicroShield® technology, a silver-based antimicrobial coating designed to inhibit the spread of germs and bacteria.

**32316** and **32D316** are made from alloy 316 stainless steel containing molybdenum and extra nickel giving it substantially higher corrosion resistance than the standard stainless steels typically used in door hardware. This finish is ideal for use in coastal, urban, and industrial areas that have harsh environmental conditions. **32316** (polish) finishes offer the best corrosion resistance and should be used in caustic environments.

**10BE** Dark Oxidized Satin Bronze equivalent: This finish provides the richness and warmth of the 10B/613 "living" finish, but maintains its original color and appearance and will not fade or wear over time. The 10BE finish is offered by Corbin Russwin, McKinney, Norton, Rixson, Rockwood, SARGENT and Yale, providing visual consistency between ASSA ABLOY Group brands.

\* On most bronze finishes we will supply solid bronze material. Where solid bronze material is not available, we will use brass as a base material with a bronze look powder coat in its place.

\*\*\* Available on select items as indicated by the finish icon throughout the catalog.



MicroShield® is a registered trademark of Yale Security Inc., an ASSA ABLOY Group company.

## ASSA ABLOY

The global leader in  
door opening solutions

**Mounting Types**

PULL STYLE	PULL ON ONE SIDE OF DOOR						PULL ON BOTH SIDES OF DOOR (BTB)			
	Thru Bolt	Deco Thru Bolt		Concealed			Conehead/Set Screw		Spanner Collar	
DOOR TYPE	Wood/Metal		Glass	Metal	Metal	Wood	Wood/Metal	Glass	Wood/Metal	Glass
CONEHEADS	NA	NA	NA	Single	Single	Single	Single	Single	NA	NA
MOUNTING TYPE	Type 1	Type 12	Type 15	Type 6	Type 6R	Type 8	Type 5	Type 13	Type 11	Type 14
Standard (STD) Bolt Size	¼"-20	¼"-20	¼"-20	¼"-20	¼"-20	¼"-20	¼"-20	¼"-20		
Price	INCL	*	*	*	*	*	*	*		
Heavy Duty (HD) Bolt Size	5/16"-18	5/16"-18	5/16"-18	5/16"-18	5/16"-18	5/16"-18	5/16"-18	5/16"-18		
Price	*	*	*	*	*	*	*	*		
Extra Heavy Duty (XHD) Bolt Size	3/8"-16	3/8"-16	3/8"-16						3/8"-16	3/8"-16
Price	*	*	*						*	*

Straight Pulls											
Pull Type	Dia.	MAXIMUM BOLT SIZE ALLOWED						MAXIMUM BOLT SIZE ALLOWED			
		Type 1	Type 12	Type 15	Type 6	Type 6R	Type 8	Type 5	Type 13	Type 11	Type 14
Straight	½"	STD	STD	STD			STD		STD	STD	STD
Straight	5/8"	HD	HD	HD	STD		STD	STD	STD		
Straight	1"	HD	HD	HD	HD	HD	HD	HD	HD	HD	HD
Straight	1 ¼"	HD	HD	HD	HD	HD	HD	HD	HD	HD	HD
Straight	1 ½"	HD	HD	HD	HD	HD	HD	HD	HD	HD	HD

Offset Pulls											
Pull Type	Dia.	MAXIMUM BOLT SIZE ALLOWED						MAXIMUM BOLT SIZE ALLOWED			
		Type 1	Type 12	Type 15	Type 6	Type 6R	Type 8	Type 5	Type 13	Type 11	Type 14
Offset	½"	STD	STD	STD						STD	STD
Offset	5/8"	HD	HD	HD						STD	STD
Offset	1"	XHD	XHD	XHD						HD	HD
Offset	1 ¼"	XHD	XHD	XHD						HD	HD
Offset	1 ½"	XHD	XHD	XHD						HD	HD

\*Refer to Accessories Price Book for Pricing.

Door Pull Mounting Details

Free End Thru Bolt

**TYPE 1 - Thru Bolt Wood or Metal Door**

Type	Bolt Size	Drill Size	Price
1	1/4"-20	9/32	Incl.
1HD	5/16"-18	11/32	*
1XHD	3/8"-16	13/32	*

**TYPE 12 - Decorative Thru Bolt Wood or Metal Door**

Type	Bolt Size	Drill Size	Price
12	1/4"-20	9/32	*
12HD	5/16"-18	11/32	*
12XHD	3/8"-16	13/32	*

**TYPE 15 - Decorative Thru Bolt Glass Door**

Type	Bolt Size	Drill Size	Price
15	1/4"-20	5/8	*
15HD	5/16"-18	5/8	*
15XHD	3/8"-16	5/8	*

Free End Concealed

**TYPE 6 - Surface Concealed Metal Door**

Minimum diameter of pull is 5/8"

Type	Bolt Size	Drill Size	Price
6	1/4"-20	1/4"-20 Tap	*
*6HD	5/16"-18	5/16"-18 Tap	*

**TYPE 6R - Surface Concealed Metal Door**

Minimum diameter of pull is 1"

Type	Bolt Size	Drill Size	Price
6	1/4"-20	N/A	*
*6HD	5/16"-18	N/A	*

**TYPE 8 - Surface Concealed Wood Door**

Type	Bolt Size	Drill Size	Price
8	1/4"-20	23/64-9/16 dp.	*
*8HD	5/16"-18	7/16-9/16 dp.	*

Back-to-Back

**TYPE 5 - Back-to-Back Wood or Metal Door**

Minimum diameter of pull is 5/8"

Type	Bolt Size	Drill Size	Price
5	1/4"-20	9/32	*
5HD	5/16"-18	11/32	*

**TYPE 13 - Back-to-Back Glass Door**

Type	Bolt Size	Drill Size	Price
13	1/4"-20	5/8	*
*13HD	5/16"-18	5/8	*

**TYPE 11XHD - Back-to-Back w/Spanner Collar - Wood or Metal Door**

Minimum diameter of pull is 1"

Type	Bolt Size	Drill Size	Price
11XHD	3/8"-16	13/32	*

**TYPE 14XHD - Back-to-Back Glass Door**

Minimum diameter of pull is 1"

Type	Bolt Size	Drill Size	Price
14XHD	3/8"-16	5/8	*

\*HD mountings feature 2 set screws 180° apart.

RM4800 Mounting Only

**RM4800 Series - Thru Bolt Wood or Metal Door**

Bolt Size	Drill Size	Price
3/8"-16	5/8	*

**RM4800 Series - Back-to-Back Wood or Metal Door**

Bolt Size	Drill Size	Price
3/8"-16	5/8	*

\*Refer to Accessories Price Book for Pricing.

**ASSA ABLOY**

The global leader in door opening solutions

## Push and Pull Bar Mounting Details

### Sizing of Push Bars

#### Flush Doors

- Door width:
- minus 5" for bent end bars
  - minus 5" for flat end post mount bars
  - minus 7" for round end post mount bars

#### Stile and Rail Doors or Doors with Lites

- Door width:
- minus width of one stile

**CAUTION:** Always confirm bars will not interfere with jamb or cause pinching hazard.

**CAUTION:** On narrow stile doors, be sure push bar base fits on the stile and bar does not interfere with the stop.

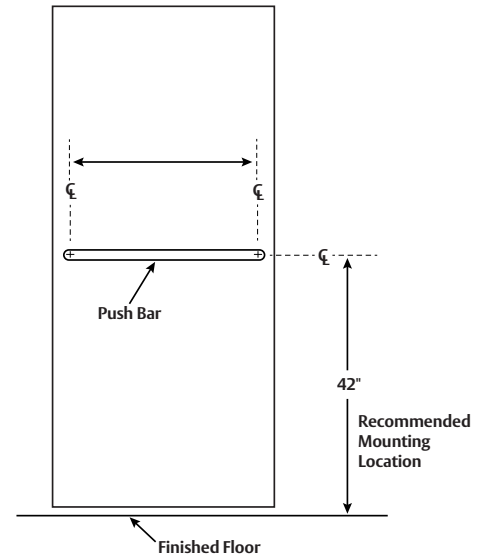

### Handing of Doors

The handing of a door is determined from the outside of the opening.

Standing outside the door:

- If the hinges are on the right, it is a right hand door.
- If the hinges are on the left, it is a left hand door.
- If the door opens away from you, it is a regular bevel door.
- If the door opens toward you, it is a reverse bevel door.

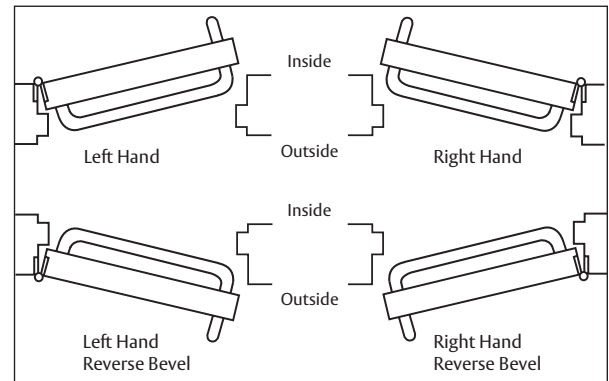

### Typical Mounting

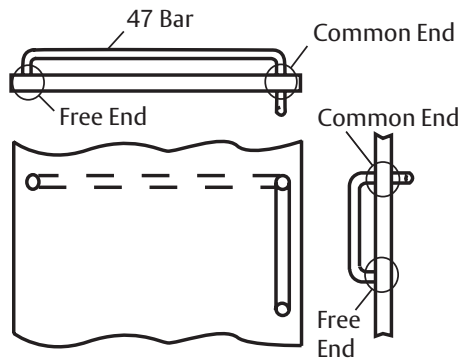

**ASSA ABLOY**

The global leader in door opening solutions



### Thru Bolt Mounting - For 1 3/4" Wood and Metal Doors

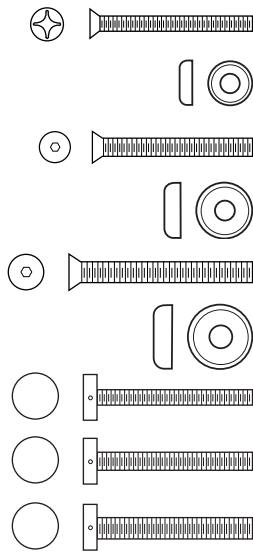

Part	Description	Mounting Type	Price
SP1004	1/4"-20 x 2 1/4" Flat Head Machine Screw Thru Bolt	1	*
SP1005	1/4"-20 Finishing Washer	1	*
SP1053	5/16"-18 x 2 1/2" Socket Flat Head Machine Screw Thru Bolt	1HD	*
SP1054	5/16"-18 Finishing Washer	1HD	*
SP1001	3/8"-16 x 2 1/2" Socket Flat Head Machine Screw Thru Bolt	1XHD	*
SP1002	3/8"-16 Finishing Washer	1XHD	*
SP1003	1" Diameter Decorative Thru Bolt 1/4"-20 x 2 1/4"	12	*
SP1055	1" Diameter Decorative Thru Bolt 5/16"-18 x 2 1/4"	12HD	*
SP1041	1 1/4" Diameter Decorative Thru Bolt 3/8"-16 x 2 1/4"	12XHD	*

### Back to Back Mounting - For 1 3/4" Wood and Metal Doors

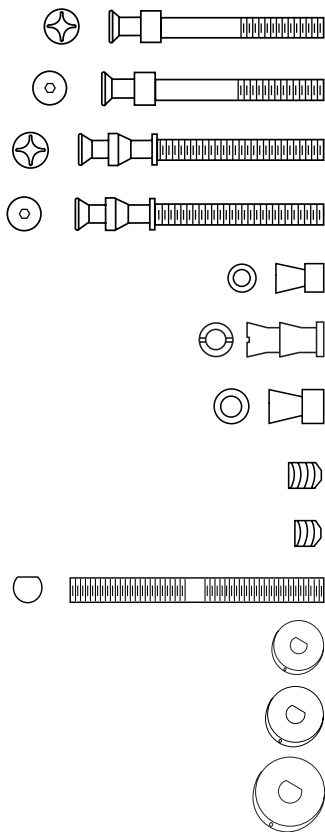

Part	Description	Mounting Type	Price
SP1025	1/4"-20 x 2 1/4" Cone Head Machine Screw	5	*
SP1056	5/16"-18 x 2 1/4" Cone Head Machine Screw	5HD	*
SP1052	1/4"-20 x 2 1/4" Double Cone Head Machine Screw (for use with offset pulls)	16	*
SP1057	5/16"-18 x 2 1/4" Double Cone Head Machine Screw (for use with offset pulls)	16HD	*
SP1027	1/4"-20 Cone Head Union (Used to Convert Cone Head to Thru Bolt Hole)	N/A	*
SP1079	1/4"-20 Double Cone Head Union (Used to Convert Double Cone Head to Thru Bolt Hole)	N/A	*
SP1068	5/16"-18 Cone Head Union (Used to Convert Cone Head to Thru Bolt Hole)	N/A	*
SP1026	1/4"-20 x 5/16" Set Screws (Standard)	N/A	*
SP1065	1/4"-20 x 3/16" Set Screw (Short)	N/A	*
SP1032	3/8"-16 x 2 7/8" LH/RH Bolt	11	*
SP1071	Spanner Collar 1" Diameter for LH/RH Bolt	11	*
SP1033	Spanner Collar 1 1/4" Diameter for LH/RH Bolt	11	*
SP1072	Spanner Collar 1 1/2" Diameter for LH/RH Bolt	11	*

\*Refer to Accessories Price Book for Pricing.

**ASSA ABLOY**

The global leader in door opening solutions

## Concealed Mounting - For 1 3/4" Wood and Metal Doors

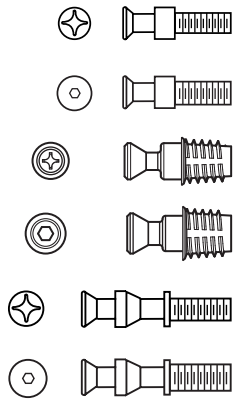

Part	Description	Mounting Type	Price
SP1039	1/4"-20 x 1/2" Cone Head Machine Screw	6 / 6R	*
SP1058	5/16"-18 x 1/2" Cone Head Machine Screw	6HD	*
SP1080	1/4"-20 Cone Head / Knife Thread Insert	8	*
SP1082	5/16"-18 Cone Head / Knife Thread Insert	8HD	*
SP1051	1/4"-20 x 1/2" Double Cone Head Machine Screw	17 / 17R	*
SP1059	5/16"-18 x 1/2" Double Cone Head Machine Screw	17HD	*

## Bushings &amp; Washers - For 1/2" Glass Doors

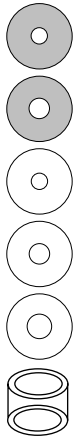

Part	Description	Mounting Type	Price
SP1022	Stainless Steel Washer for 1/4"-20 Cone Head Machine Screw .032" Thick	13	*
SP1060	Stainless Steel Washer for 5/16"-18 Cone Head Machine Screw .060" Thick	13HD	*
SP1023	Plastic Washer for 1/4"-20 Bolt; Specify Size	13	*
SP1061	Plastic Washer for 5/16"-18 Bolt; Specify Size	13HD	*
SP1062	Plastic Washer for 3/8"-16 Bolt; Specify Size	14	*
SP1024	Glass Door Bushing for 5/8" Hole in Glass; Specify Size	13 / 13HD / 14	*

## Thru Bolt Mounting - For 1/2" Glass Doors

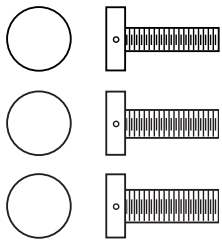

Part	Description	Mounting Type	Price
SP1020	1" Diameter Decorative Thru Bolt; 1/4"-20 x 1 1/8"	15	*
SP1063	1" Diameter Decorative Thru Bolt; 5/16"-18 x 1 1/8"	15HD	*
SP1040	1 1/4" Diameter Decorative Thru Bolt; 3/8"-16 x 1 1/8"	15XHD	*

\*Refer to Accessories Price Book for Pricing.

### Back to Back Mounting - For 1/2" Glass Doors

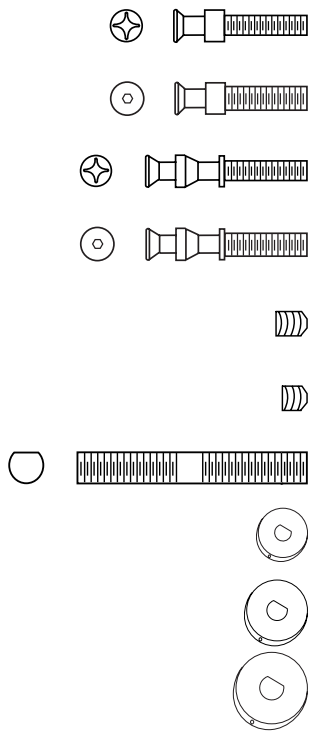

Part	Description	Mounting Type	Price
SP1021	1/4"-20 x 1 1/8" Cone Head Machine Screw	13	*
SP1064	5/16"-18 x 1 1/8" Cone Head Machine Screw	13HD	*
SP1067	1/4"-20 x 1 1/8" Double Cone Head Machine Screw	18	*
SP1066	5/16"-18 x 1 1/8" Double Cone Head Machine Screw	18HD	*
SP1026	1/4"-20 x 5/16" Set Screw (Standard)	N/A	*
SP1065	1/4"-20 x 3/16" Set Screw (Short)	N/A	*
SP1031	3/8"-16 x 1 3/4" LH/RH Bolt	14	*
SP1071	Spanner Collar 1" Diameter for LH/RH Bolt	14	*
SP1033	Spanner Collar 1 1/4" Diameter for LH/RH Bolt	14	*
SP1072	Spanner Collar 1 1/2" Diameter for LH/RH Bolt	14	*

### Y Base Plates

Specify bolt hole size and finish. Standard pulls require two plates.

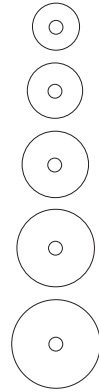

Part	Description	For Use With	Price
SP1073	1/8" Thick x 1 1/16" Diameter	3/4" Diameter Pulls	*
SP1074	1/8" Thick x 1 1/4" Diameter	1" Diameter Pulls and Posts	*
SP1075	1/8" Thick x 1 1/2" Diameter	1" Diameter Pulls and Posts	*
SP1076	1/8" Thick x 1 3/4" Diameter	1" Diameter Pulls and Posts	*
SP1077	1/8" Thick x 2" Diameter	1" Diameter Pulls and Posts	*

### Flush Pull Fasteners

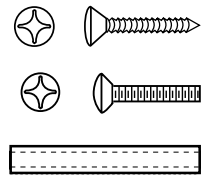

Part	Description	Door Type	Price
SP1006	#8 x 3/4" Oval Head Sheet Metal Screw	Wood or Metal	*
SP1007	#8-32 x 3/4" Oval Head Machine Screw	Metal	*
SP1034	#8-32 x 1 5/8" Brass Sleeve Machine Screw	Wood or Metal	*

\*Refer to Accessories Price Book for Pricing.

**ASSA ABLOY**

The global leader in door opening solutions

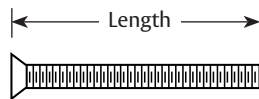

Standard Thru Bolt for Countersunk Holes

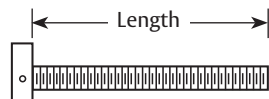

Decorative Thru Bolt for Wood or Metal Doors

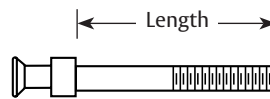

Cone Head Bolt for Back-to-Back Wood or Metal Doors

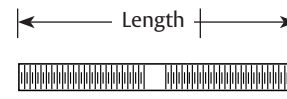

LH/RH Bolt without Heads

## Mounting Kits for Door Pulls

Part	Mounting Type	Description	Price
<b>KIT1</b>	1	2 ea. 1/4"-20 x 2 1/4" Thru Bolts and 2 ea. Finish Washers; Specify Finish	*
<b>KIT1HD</b>	1HD	2 ea. 5/16"-18 x 2 1/2" Thru Bolts and 2 ea. Finish Washers; Specify Finish	*
<b>KIT1XHD</b>	1XHD	2 ea. 3/8"-16 x 2 1/2" Thru Bolts and 2 ea. Finish Washers; Specify Finish	*
<b>KIT5</b>	5	2 ea. 1/4"-20 x 2 1/4" Cone Head Bolts and 2 ea. Set Screws	*
<b>KIT5HD</b>	5HD	2 ea. 5/16"-18 x 2 1/4" Cone Head Bolts and 4 ea. Set Screws	*
<b>KIT6</b>	6	2 ea. 1/4"-20 x 1 1/2" Cone Head Bolts and 2 ea. Set Screws	*
<b>KIT6HD</b>	6HD	2 ea. 5/16"-18 x 1 1/2" Cone Head Bolts and 4 ea. Set Screws	*
<b>KIT11</b>	11	2 ea. 3/8"-16 x 3 1/2" LH/RH Bolt and 2 ea. Spanner Collars for 1 3/4" Doors; Specify Pull Diameter and Finish	*
<b>KIT12-1</b>	12	2 ea. 1/4"-20 x 2 1/4" Decorative Thru Bolts; 1" Dia.; Specify Finish	*
<b>KIT12-1HD</b>	12HD	2 ea. 5/16"-18 x 2 1/4" Decorative Thru Bolts; 1" Dia.; Specify Finish	*
<b>KIT12-1.25XHD</b>	12XHD	2 ea. 3/8"-16 x 2 1/4" Decorative Thru Bolts; 1 1/4" Dia.; Specify Finish	*
<b>KIT12-1.5XHD</b>	12XHD	2 ea. 3/8"-16 x 2 1/4" Decorative Thru Bolts; 1 1/2" Dia.; Specify Finish	*
<b>KIT13</b>	13	2 ea. 1/4"-20 x 1 1/8" Cone Head Bolts; 2 ea. Metal Washers; 4 ea. Plastic Washers; 2 ea. Bushings for 1/2" Glass Doors; 2 ea. Set Screws; Specify if other than 1/2" Glass	*
<b>KIT13HD</b>	13HD	2 ea. 5/16"-18 x 1 1/8" Cone Head Bolts; 2 ea. Metal Washers; 4 ea. Plastic Washers; 2 ea. Bushings for 1/2" Glass Doors; 4 ea. Set Screws; Specify if other than 1/2" Glass	*
<b>KIT14</b>	14	2 ea. 3/8"-16 x 2 1/4" LH/RH Bolt; 2 ea. Spanner Collars; 2 ea. Bushings; 4 ea. Washers for 1/2" Glass Doors; Specify Pull Diameter and Finish	*
<b>KIT15</b>	15	2 ea. 1/4"-20 x 1 1/8" Decorative Thru Bolts; 1" Dia.; 2 ea. Bushings; 4 ea. Plastic Washers; Specify Finish and Glass Thickness/Hole Size	*
<b>KIT15HD</b>	15HD	2 ea. 5/16"-18 x 1 1/8" Decorative Thru Bolts; 1" Dia.; 2 ea. Bushings; 4 ea. Plastic Washers; Specify Finish and Glass Thickness/Hole Size	*
<b>KIT15-1.25XHD</b>	15XHD	2 ea. 3/8"-16 x 1 1/8" Decorative Thru Bolts; 1 1/4" Dia.; 2 ea. Bushings; 4 ea. Plastic Washers; Specify Finish and Glass Thickness/Hole Size	*
<b>KIT15-1.5XHD</b>	15XHD	2 ea. 3/8"-16 x 1 1/8" Decorative Thru Bolts; 1 1/2" Dia.; 2 ea. Bushings; 4 ea. Plastic Washers; Specify Finish and Glass Thickness/Hole Size	*
<b>KIT16</b>	16	2 ea. 1/4"-20 x 2 1/4" Double Cone Head Bolts and 4 ea. Set Screws	*
<b>KIT16HD</b>	16HD	2 ea. 5/16"-18 x 2 1/4" Double Cone Head Bolts and 4 ea. Set Screws	*

Part	Mounting Type	Description	Price
<b>KIT17</b>	17	2 ea. 1/4"-20 x 1 1/2" Double Cone Head Bolts and 4 ea. Set Screws	*
<b>KIT17HD</b>	17HD	2 ea. 5/16"-18 x 1 1/2" Double Cone Head Bolts and 4 ea. Set Screws	*
<b>KIT18</b>	18	2 ea. 1/4"-20 x 1 1/8" Double Cone Head Bolts; 2 ea. Metal Washers; 4 ea. Plastic Washers; 2 ea. Bushings for 1/2" Glass Doors; Specify if other than 1/2" Glass and 4 ea. Set Screws	*
<b>KIT18HD</b>	18HD	2 ea. 5/16"-18 x 1 1/8" Double Cone Head Bolts; 2 ea. Metal Washers; 4 ea. Plastic Washers; 2 ea. Bushings for 1/2" Glass Doors; Specify if other than 1/2" Glass and 4 ea. Set Screws	*
<b>KIT-T1</b>	T1	1 ea. 1/4"-20 X 2 1/4" Cone Head Bolt; 1 ea. 1/4"-20 Cone Head Union; 2 ea. Set Screws; 2 ea. 1/4"-20 x 1 1/4" — 1" Dia. Decorative Thru Bolts; Specify Finish	*
<b>KIT-T2</b>	T2	1 ea. 1/4"-20 X 1 1/8" Cone Head Bolt; 1 ea. 1/4"-20 Cone Head Union; 2 ea. Set Screws; 2 ea. 1/4"-20 x 1 1/8" — 1" Dia. Decorative Thru Bolts; 1 ea. Metal Washer; 6 ea. Plastic Washers; 3 ea. Bushings; Specify Finish	*
<b>KIT-T3</b>	T3	1 ea. 1/4"-20 X 2 1/4" Cone Head Bolt; 1 ea. 1/4"-20 Cone Head Union; 2 ea. Set Screws; 2 ea. 1/4"-20 x 2 1/4" Thru Bolts; 2 ea. Finish Washers; Specify Finish	*
<b>KIT-T4</b>	T4	1 ea. 1/4"-20 X 2 1/4" Cone Head Bolt; 2 ea. 1/4"-20 x 1 1/2" Cone Head Bolts; 3 ea. Set Screws	*
<b>KIT-T5</b>	T5	1 ea. 1/4"-20 X 2 1/4" Cone Head Bolt; 2 ea. 1/4"-20 x 1 1/2" Cone Head Wood Screws; 3 ea. Set Screws	*
<b>KITRM1.25</b>	11x1XHD	2 ea. 3/8"-16 x 2 1/2" Thru-Bolts; 2 ea. Finish Washers; 1 ea. 3/8"-16 x 3 1/2" LH/RH Bolt; 1 ea. 1 1/4" Spanner Collar; Specify Finish	*
<b>KITRM360</b>	11x12XHD	2 ea. 3/8"-16 x 2 1/4" Decorative Thru Bolts 1 1/4" Dia.; 1 ea. 3/8"-16 x 3 1/2" LH/RH Bolt; 1 ea. 1 1/4" Spanner Collar; Specify Finish	*
<b>KITRM360G</b>	14x15XHD	2 ea. 3/8"-16 x 2 1/4" Decorative Thru Bolts 1 1/4" Dia.; 1 ea. 3/8"-16 x 2 1/4" LH/RH Bolt; 1 ea. 1 1/4" Spanner Collar; 3 ea. Bushings; 6 ea. Plastic Washers; Specify Finish	*
<b>KITRM1.5</b>	11x1XHD	2 ea. 3/8"-16 x 2 1/2" Thru Bolts; 2 ea. Finish Washers; 1 ea. 3/8"-16 x 3 1/2" LH/RH Bolt; 1 ea. 1 1/2" Spanner Collar; Specify Finish	*
<b>KITRM380</b>	11x12XHD	2 ea. 3/8"-16 x 2 1/4" Decorative Thru Bolts 1 1/2" Dia.; 1 ea. 3/8"-16 x 3 1/2" LH/RH Bolt; 1 ea. 1 1/2" Spanner Collar; Specify Finish	*
<b>KITRM380G</b>	14x15XHD	2 ea. 3/8"-16 x 2 1/4" Decorative Thru Bolts 1 1/2" Dia.; 1 ea. 3/8"-16 x 1 1/4" LH/RH Bolt; 1 ea. 1 1/2" Spanner Collar; 3 ea. Bushings; 6 ea. Plastic Washers; Specify Finish	*

\*Refer to Accessories Price Book for Pricing.

**ASSA ABLOY**

The global leader in door opening solutions

## Discontinued Products

Coat Hooks
RM809
RM810
RM824
RM825
RM826
RM827

RM3100 MegaTek Series - See RM3300 MegaTek Series on pg. 18 for equivalent pulls.
RM3100
RM3110
RM3120
RM3130
RM3140
RM3150
RM3104
RM3114
RM3124
RM3134
RM3144
RM3154

RM3200 NeoTek Series - See RM3400 NeoMax Series on pg. 21 for equivalent pulls.
RM3200
RM3200
RM3204
RM3210
RM3214
RM3220
RM3224
RM3230
RM3234
RM3240
RM3244
RM3250
RM3254

CenTek - 1" Radius Pulls
RM4300
RM4301
RM4302
RM4303
RM4304
RM4305

CenTrex - Large Radius Pulls
RM4550
RM4552

SculpTrex - Shaped Cast Pulls
RM5000
RM5002
RM5010
RM5012
RM5020LH
RM5020RH
RM5030
RM5040
RM5050LH
RM5050RH

Classic - Finial Door Pulls
RM5600
RM5602
RM5604
RM5610
RM5612
RM5614

Notes

---

## Notes

---

ASSA ABLOY is the global leader in door opening solutions, dedicated to satisfying end-user needs for security, safety and convenience

**ASSA ABLOY**



300 Main Street  
Rockwood, Pennsylvania 15557  
P: 800-458-2424 • F: 800-922-9212  
[www.assaabloydooraccessories.us](http://www.assaabloydooraccessories.us)  
[orders.rockwood@assaabloy.com](mailto:orders.rockwood@assaabloy.com)

(In Canada)  
Door Security Solutions Canada  
160 Four Valley Drive  
Vaughan, ON L4K 4T9  
P: 800-461-3007  
[www.assaabloydss.ca](http://www.assaabloydss.ca)