

RMR-C430

Radar and Laser Detector

Owners Manual

SPECIFICATIONS:

Radar & Laser Detector:

- Frequencies: 10.525 GHz
24.125 GHz
33-36 GHz
904 Nano-meter
- Sensitivity: X-112 Dbm
K-110 Dbm
Ka-wide-102 Dbm
Laser < .5 microwatt
- Alarm: Separate for each Band
Variable alarm for Range
- Controls: Volume, On/Off, Dim, Mute,
City/Highway, Test
- VG-2: Automatic Frequency Shift
- Size: 1.4" x 3.0" x 4.4"

The RMR-C430 detector is a full-featured radar and laser detector.

The radar detector is a dual conversion scanning super-heterodyne receiver with separate alarms for each of the radar bands, dim function, city/highway and mute select. It detects front and rear laser and radar.

Other:

- One-Year Ticket Rebate Program
- Three-Year Warranty

FCCID: QKK-C03

This product has been designed and certified to comply with Part 15 of the FCC Rules. Any changes or modifications not expressly approved by Rocky Mountain Radar may void your authority to use this product. Operation is subject to the following two conditions: (1) this device may not cause harmful interference, and (2) this device must accept any interference received, including interference that may cause undesired operation.

Installation:

- 1) Attach the windshield bracket to the C430 detector. Align the edge on the bracket with the slot opening on the front of the case. Slide the bracket into the case until it locks into place.
- 2) Place the windshield bracket in the upper center portion of the windshield. The ideal position will be right below the rear view mirror. Then press firmly to seat suction cups. Note: Tinted glass will degrade the laser performance.
- 3) Bend the windshield bracket mount to a level position.
- 4) The RMR-C430 will hang from the bottom of the bracket and must have an unobstructed view of the road ahead.
- 5) Insert the small end of the power cord gently into the power jack on the right side of the unit and the large end into the cigarette lighter receptacle.

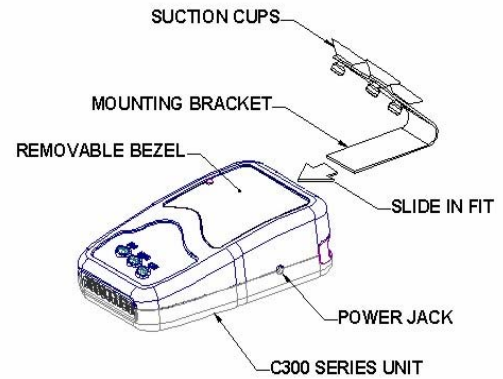

Remote mounting is not recommended.

Hard wire: Remove cigarette lighter plug. Connect the black with white stripe wire to +12 Volts, and then connect the solid black wire to ground.

CONTROLS: There are 3 buttons on top of the C430, Dim, Mute and City

Dim: Press the Dim button for one second to dim the alarm lights. There are 3 levels of brightness.

To brighten the alarm lights press the dim button again.

Mute: Press the Mute button for one second to disable the alarm speaker for quiet operation. To reactivate the alarm speaker press the Mute button again for one second.

City: Press the City button for one second to reduce false alarms in high RF noise areas. The yellow City light will illuminate to show activation.

Reminder! The C430 will memorize the settings of the features above when the unit is powered off. Be sure to readjust the settings to your normal preferences.

Power and Volume: Power is provided through the thumb wheel switch on the left side of the unit. Rotate the wheel forward to turn on and increase the volume for the alarm.

Rocky Mountain Radar does not condone the use of excessive speed on the highways, nor does it endorse breaking the speed limit laws of the United States of America. Please drive safely when using this or any other electronic product in your car.

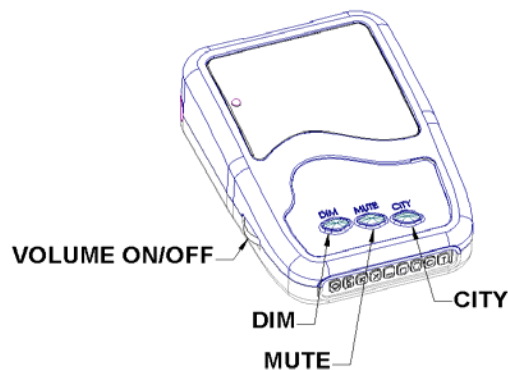

4

Alarms: A separate alert tone will sound for each band of Radar encountered with a different colored light, (Ka-Amber), (K-Yellow), (X-Green) illuminated. Tone frequency will increase as signal strength becomes stronger. (Fig. A)

All alarm lights will flash when Laser is detected. (Fig. B)

Signal Strength: Signal Strength will be first indicated by the illumination of the LED of the band detected, then the three red LED's. When all three are illuminated the signal is strongest. (Fig C)

VG-2: VG-2 detection is indicated with a separate alarm along with the green power light blinking. (Fig. D)

Diagnostics: The RMR-C430 has a full internal automatic diagnostic system. If the power light goes off and remains off, check the 2-amp fuse in the power cord by unscrewing the silver tip and removing the fuse. If the fuse is good (wire inside the fuse unbroken), return the unit for service.

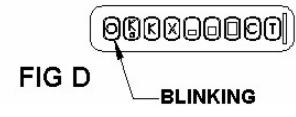
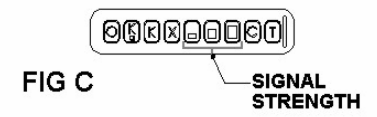
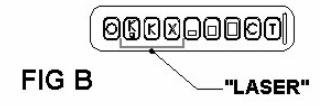
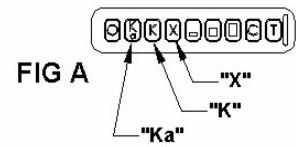

Interchangeable Color Bezel Panels:

The RMR-C430 model has optional removable color panels. To remove the panel use a small screwdriver, insert under front of panel (see diagram) and pry upward gently. To replace, insert rear of panel tabs in slots on unit and press down. Panel should click and fit firmly in place if properly installed.

Colored panels have no effect on the performance of your unit. (Fig A)

Selectable VG-2:

To activate VG-2 detection turn the unit on. After the self-test has completed, press and hold the Mute button down for 3~5 seconds until the unit beeps three times. VG-2 detection is now activated. To deactivate press and hold the Mute button for 3~5 seconds until the unit buzzes once. VG-2 is now off.

Auto Memory: The RMR-C430 has an automatic memory. Any settings enabled when the unit is turned off will still be enabled when the unit is turned back on. **If you have set the unit on Mute or have dimmed the alarm lights be sure to readjust the settings to your normal preference.**

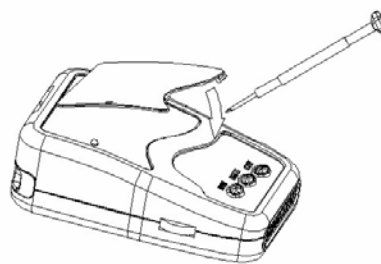

Fig. A

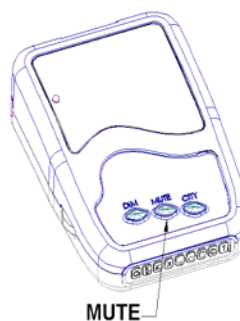

Fig. B

Warranty

The RMR-C430 is guaranteed against defects in workmanship and materials for 36 months from the date of purchase. Should any malfunction occur, the unit would be repaired or replaced by the factory at no charge. You may have your unit checked free of charge at the factory during this warranty period.

Returns should be sent freight prepaid with an explanation of the problem, your physical address (no PO Boxes) and **telephone number**. Send to:

ROCKY MOUNTAIN RADAR
6469 Doniphan Drive
El Paso TX 79932
Phone: 915-587-0307 Fax: 915-587-6408

We do not accept COD shipments
We do not accept freight collect shipments

Accessories

The following accessories and parts are available:

Windshield mount	\$ 5.00
Suction Cups (set of 3)	\$ 2.00
2 amp fuses (two each)	\$ 2.00
Power Cord	\$ 5.00
Replacement Owners Manual	\$ 3.50
Set of Colored Bezel Panels (6)	\$10.00
Set of Da-Glo Bezel Panels (3)	\$10.00

A \$10.00 shipping and handling fee will be added to the total of each order.

VISA/MC and Discover Accepted

Tamper Fee

Tampering with, disassembly, or modification of this product voids the warranty and a tamper fee of **\$150.00** will be charged to repair it.

**Manufactured Exclusively by
Rocky Mountain Radar in the USA**