

1.Introduction

Dear Rocky Mountain Radar Owner,

Congratulations on your purchase of one of the world's most sophisticated radar/laser detectors. The RMR-D550 is a completely integrated radar/laser detector which responds not only to all the radar guns in use today, including "Stalker", but also to the other latest development in speed monitoring devices- the laser gun.

This model provides distinct visual and voice alerts to warn you of the presence of X, K, and all kinds of Ka Band radar guns in the front and rear of you.

It also incorporates a new safety feature – Safety Alert(SA) and Safety Warning System(SWS). This safety feature warns you of the presence of potential road hazards by detecting signals from safety radar transmitting devices.

Note:

Important : The RMR-D550 is not designed to help you disobey the law. A defensive driver always obeys the posted speed limit and legal driving methods.

Federal and Local Regulations

The FCC passed the Communications Act in 1934 to give all citizens the right to receive all types of radio transmissions. The same radio frequencies used by police radar are also used by other devices, such as automatic door openers, burglar alarms, and some amateur radio equipment. Since the RMR-D550 is just a radio receiver tuned to a specific portion of the public radio spectrum, it is protected under this act.

Some local, state, and federal regulations may prohibit the use of this detection device. Please check with authorities regarding the use of this device before operating it.

2. Control and Features

1) Included with your Radar Detector

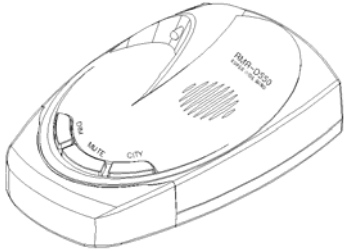

RMR-D550

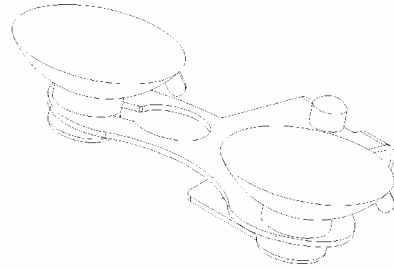

**Windshield Bracket with
Suction Cups**

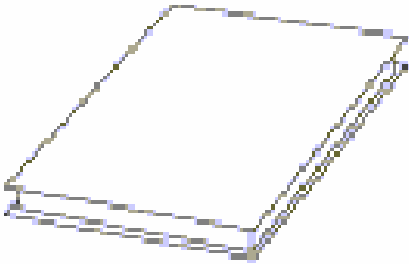

Hook and Loops Fastener Tape

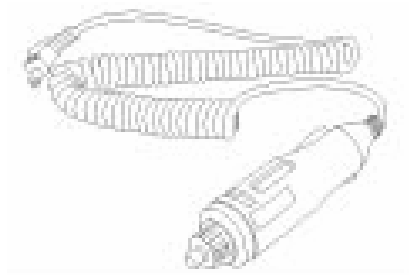

Power Cord

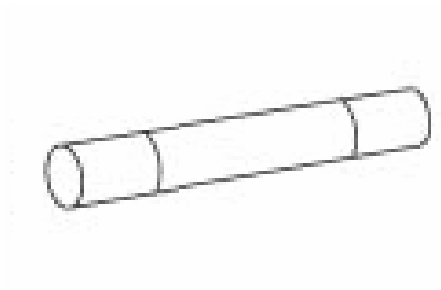

Spare Fuse

2) Controls and Functions

- a. Power On/Off Button
- b. Volume up and down button
- c. DC 12V Power Input Jack
- d. Dim Button
- e. Mute Button
- f. City Button
- g. Rear Laser Detection Lens : Receives incoming laser signals from rear
- h. Front Laser Detection Lens
- i. Radar Antenna
- j. Power-On Indicator
- k. X-Band Indicator
- l. K/Ka Band Indicator
- m. City Indicator
- n. Signal Strength Meter Indicator
- o. Laser Indicator

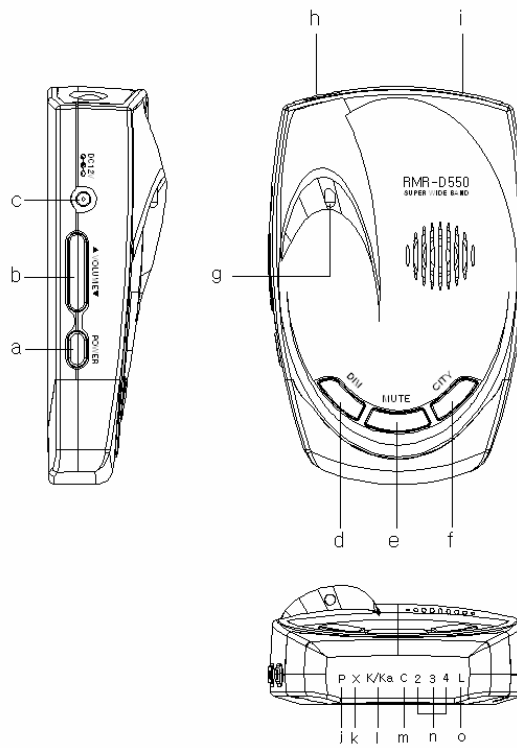

3. Installation

1) Mounting Guidelines

For the best performance, select the proper location for the unit where it has a direct view of the road. The radar antenna is located behind the rear panel of the unit and the laser detection lenses are located behind the rear panel of the unit and the front window. The antenna and sensors should not be obstructed by metal or metallic surfaces and should be pointed at the horizon for accurate long range detection.

- Choose a location that does not block the driver's vision.
- Mount the detector in a level position.
- Do not mount the detector behind metal surfaces, windshield antenna, wiper blades, ornaments, or mirrored glass.
- Heated windshields, currently available as an option on some Ford(Instacklear) or GM(electriclear) vehicles act as an impenetrable barrier to radar signals.
- Do not mount the detector where the driver or passenger might collide in the case of an abrupt halt.

Note : Whichever mounting method you choose, remember to place the radar detector out of view when you leave your vehicle. This keeps the detector out of sight from thieves and prevents exposure to extremely high temperatures.

Note : If necessary, you may adjust the bracket to the proper angle by bending it. To remove your detector, pull up the detector from the front pulling it towards you.

Caution : On some newer model cars, a plastic safety coating has been applied to the windshield. The suction cups may leave permanent marks on the windshield once they are removed. Check your vehicle owner's manual to see if your car has the plastic safety coating.

2) Mounting Types

A. On Windshield

- a. Attach bracket to windshield.



- b. Bend bracket for correct detection angle.
- c. Plug Power cord into detector.
- d. Attach bracket to detector.
- e. Plug power cord into cigarette lighter.

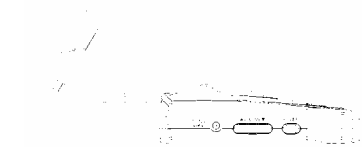

B. On Dashboard

- a. Peel protective paper off one side of hook-loop.
- b. Tape on detector's bottom.



- c. Peel top paper off.
- d. Place detector on dashboard.



- e. Plug power cord into detector and cigarette lighter.

3) Power Connection

The coiled power cord provided with the unit has a cigarette lighter socket plug at one end and a small connector on the other.

1. Insert the small connector into the jack on the side of the unit.
2. Insert the other end into the cigarette lighter socket of your vehicle.

If the detector does not operate when you turn it on, remove the adapter from the cigarette lighter socket and carefully check the socket for debris. Also, check the fuse in the adapter and your vehicle fuse box.

4) Replacing Fuse

- a. To replace the fuse, unscrew the top of the plug.
- b. Remove and check the fuse to see if it has blown, if it has, replace it.

4. Operation

1) Power On and Self - Test

- Press the Power button.
- The RMR-D550 goes through an automatic self-test sequence.

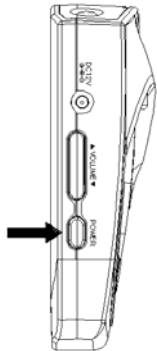

2) Volume Level Adjustment

- Press Volume up button to increase volume level.
- Press Volume down button to decrease volume level.

3) Dim Mode

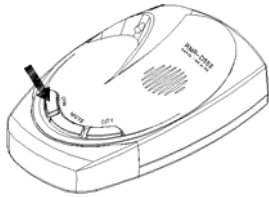

Press Dim Button .

Dim Mode reduces the illumination of the display. You may select from four levels of brightness for your RMR-D550 display.

→ A voice sound will alert you that Dim mode has been activated. Each time you press Dim button, display intensity will change Dim, Dimmer, Dark, Bright.

(Note : The RMR-D550 cannot activate Mute and Dark at same time. If the MUTE is engaged, the DARK cannot activate.)

→ Hold down Dim Button for three(3) seconds to select “Voice On” or “Voice Off”.

4) City / Highway Mode



Two Step City Mode is designed to reduce false alert while you are driving in or near urban areas where there are many sources for conflicting X band signals such as microwave towers and automatic door openers.

Press City Button.

→ “City” LED turns on for “City 1” Mode. In Voice Mode, you will hear “City 1”. In Tone Mode, you will hear 2 beeps.

Press City Button a second time

→ “City” and “2” LED turns on for “City 2” Mode. In Voice Mode, you will hear “City 2”
In Tone Mode, you will hear 3 beeps.

Pressing City Button a third time engages “Highway” Mode.

- Factory default is “Highway” Mode.
- In “City 1” Mode, X band is not detected.
- In “City 2” Mode, X band is not detected and K/Ka band sensitivity is lowered.

CAUTION : Some towns and small cities may still be using X band radar.

5) Mute Mode

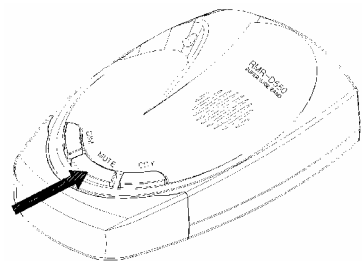

- Press Mute Button.

Mute On→ Silences the tone sound.

Note : Press Mute button again to restore tone sound.

6) Select Tone

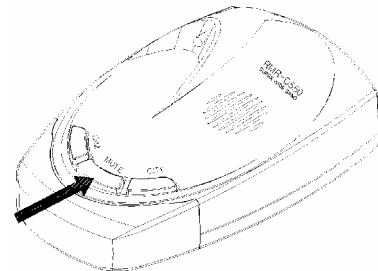

- Hold down the Mute button for three seconds.

The RMR-D550 will change tone sound.

7) Indicator and Visual

a. Power On

□“P” LED turns on.

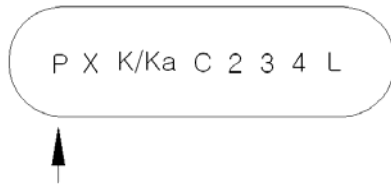

b. X Band Detection

□“X” LED turns on with voice sound.



c. K/Ka Band Detection

□“K/Ka” LED turns on with voice sound.

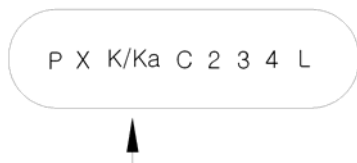

d. Laser Alarm

□“2, 3, 4, L” LEDs flash with voice sound.

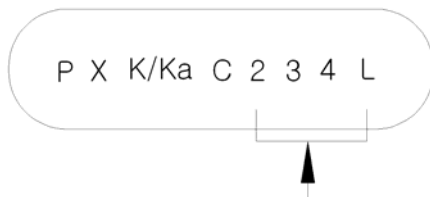

8) Language Selection(English and Spanish Modes)

- Hold down the “City” button for three(3) seconds to select either English or Spanish mode for your voice alert system
- Factory default is “English Mode”.

9) Feature Memory

The RMR-D550 will automatically “Remember” your settings when the unit is turned off or removed from the power. All features selected are retained in memory.

- Bright – Dim – Dimmer - Dark
- Audio Tone
- Highway - City 1 – City 2
- Mute On or Mute Off
- Voice On or Voice Off
- English or Spanish

10) Voice ON/OFF Select

- Hold down the Dim Button for three seconds to select Voice On or Voice Off Mode.
- Factory default is “Voice On” Mode.
- When you drive with Voice Off mode, you will not be alerted by Voice message.

11) Tutorial Mode

The RMR-D550 has a tutorial mode intended to familiarize you with the various visual display and distinct audible alerts the unit performs.

- Hold down Dim and City buttons for three seconds to engage Tutorial Mode.
- Press any button to exit the All-LEDs-On status, that is the end of tutorial mode.

12) Feature Engage Confirmation

Each time a button is pressed two beeps confirm feature “On”, one beep confirms feature “Off”.

ACCESSORIES

Accessories are available as follows:

Windshield mount	\$ 5.00
Power Cord	\$ 5.00
Suction Cups(set of two)	\$ 2.00
2amp fuses(two ea.)	\$ 2.00
Replacement owner's manual	\$ 3.50

Add \$10.00 shipping and handling per shipment

CAUTION

Tampering with unit will result in a \$ 75.00 repair fee!

WE DO NOT ACCEPT COD SHIPMENT

ROCKY MOUNTAIN RADAR 6469 DONIPHAN DRIVE EL PASO, TX 79932 915.587.0307 915.587.6408(FAX)

5. Care and Maintenance

Your Rocky Mountain radar detector is an example of superior design and craftsmanship. The following suggestions will help you care for your detector so you can enjoy it for years.

- Never leave your detector on the windshield or dashboard when your vehicle is left parked. The temperature in the vehicle during the summer can reach levels above what is considered to be safe for this detector.
- To make you less susceptible to break-in and theft, remove the detector from your windshield or dashboard when leaving your vehicle.
- Do not expose the detector to moisture, rain, dew, road splash, or other liquids that can damage the internal components and reduce the sensitivity of the detector.

6. Troubleshooting

If the detector does not turn on:

- Check the power cord. Be sure all power connectors are properly installed.
- Check the fuse that controls the power to the cigarette lighter socket.
(See your vehicle's owner's manual for reference)
- The cigarette lighter socket might be dirty. Clean it with a fine emery cloth to ensure a good, clean connection.
- There might be a problem with the vehicle's electricity.

Caution : Do not place any metal objects other than the cigarette lighter or a cigarette lighter plug in the cigarette lighter socket. Doing so could blow a fuse in your vehicle or cause the metal object to become very hot.

If the detector gives a false alert when the vehicle hits bumps:

- Check the vehicle's electrical system, including main battery cable and alternator connections.
- Install a filter capacitor (470 μ F, 35volts) on the back of the cigarette lighter socket, across the power connection.

If the receiving signal is weak:

- Check the angle of the detector.

- Radar antenna/laser sensor is obstructed.
(Relocate the detector clear of any obstruction outside the windshield, such as a wiper blade.)
- Relocate the detector clear of the window tint.

7. Specification

RADAR

Receiver Type : Triple conversion Superheterodyne

Antenna Type : Linear polarized, Self-Contained Antenna

Detector Type : Scanning Frequency Discriminator

Frequency of Operation : 10.525GHz/± 50MHz(X-Band)

24.150GHz/± 100MHz(K-Band)

34.700GHz/± 1,300MHz(Ka Super Wideband)

LASER

Receiver Type : Pulsed Laser Signal Receiver

Detector Type : Digital Signal Processor Pulse

Width Discriminator

Opto Sensor : Dual Convex Condenser Lens and High Speed Photo Diode Detector

Spectral Response : 800 ~ 1,100nm

GENERAL

Temperature Range : -4 to 158° (-20 to 70°)

Power Requirements : 12~15V DC, 150mA nominal (Negative Ground)

Dimensions(HWD) : 1.4" ×3.1"×4.8"

Specifications are typical : individual units might vary.

Specifications are subject to change without notice.

Warranty

WARRANTY

This unit guaranteed against defects in workmanship and materials for one year. Should you experience any difficulty with the RMR-D550 during this time, the unit will be repaired or replaced at no charge. Should you desire to have your unit checked, there will be no additional charge other than postage and handling. After the warranty period expires, the unit may be returned for service and it will be reconditioned for \$ 25.00

FCC Information

This product has been designed and certified to comply with Part 15 of the FCC Rules. Operation is subject to the following two conditions: (1) this device may not cause harmful interference, and (2) this device must accept any interference received, including interference that may cause undesired operation.

Any changes or modifications not expressly approved by Rocky Mountain Radar may void your authority to use this product.