

Roland®

HPi-7

Roland Digital Piano

HPi-7LE

Roland Digital Piano

Owner's Manual

Congratulations on your choice of the Roland Digital Piano HPi-7/HPi-7LE.

Before using this unit, carefully read the sections entitled: "IMPORTANT SAFETY INSTRUCTIONS" (p. 2), "USING THE UNIT SAFELY" (p. 3), and "IMPORTANT NOTES" (p. 5). These sections provide important information concerning the proper operation of the unit. Additionally, in order to feel assured that you have gained a good grasp of every feature provided by your new unit, owner's manual should be read in its entirety. The manual should be saved and kept on hand as a convenient reference.

Musical Notation Shown In A Large LCD Screen

The musical notation can be displayed not only for the internal songs, but also for commercially available song files. You can split the screen and change the settings as you view the Notation screen. Lyrics and fingering numbers can also be displayed.

* The fingering numbers are displayed only for some of the internal songs.

Authentic Piano Performance

High-quality grand piano tones and true piano feel from the keyboard and pedals let you enjoy authentic -piano performance.

A "Wonderland" Sure To Please Children

"Wonderland" is a world of sound which children can enjoy, with a "Piano," a "SFX" of sounds, and more. A note-guessing game is also included.

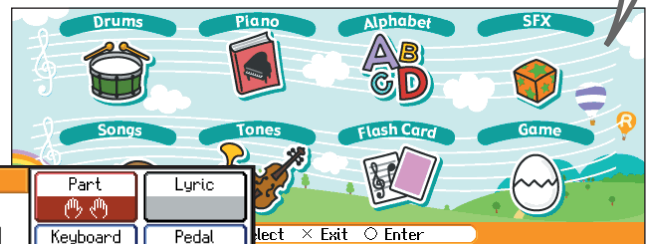
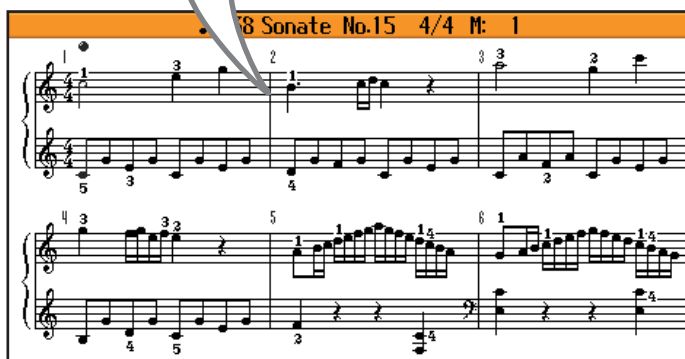

A Wealth Of Onboard Songs

The instrument comes with 170 songs, all carefully selected so almost every genre is represented—whether it be piano etudes, or popular tunes.

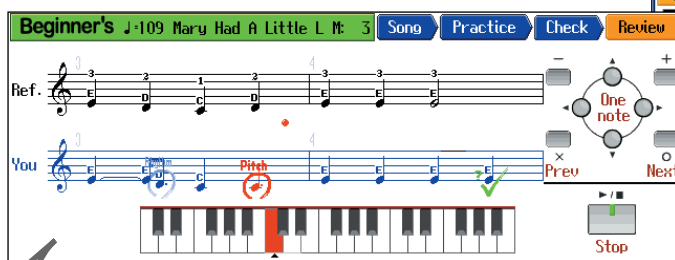

A "Visual Lesson" Convenient Functions For Practicing

Enjoy practicing along with song data. You can also check the results of what you play right in the screen.

Easy Game-like Operation

After pressing the button for the desired function, operation consists basically of pressing the cursor buttons, [O] [X] buttons and [+/-] located in the center of the panel. You can enjoy versatile performance with easy operation.

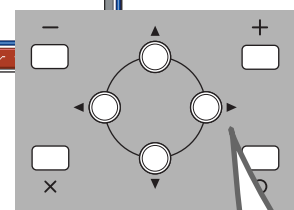

Copyright © 2004 ROLAND CORPORATION

All rights reserved. No part of this publication may be reproduced in any form without the written permission of ROLAND CORPORATION.

WARNING: To reduce the risk of fire or electric shock, do not expose this apparatus to rain or moisture.

 CAUTION RISK OF ELECTRIC SHOCK DO NOT OPEN	
ATTENTION: RISQUE DE CHOC ELECTRIQUE NE PAS OUVRIR	
CAUTION: TO REDUCE THE RISK OF ELECTRIC SHOCK, DO NOT REMOVE COVER (OR BACK). NO USER-SERVICEABLE PARTS INSIDE. REFER SERVICING TO QUALIFIED SERVICE PERSONNEL.	



The lightning flash with arrowhead symbol, within an equilateral triangle, is intended to alert the user to the presence of uninsulated "dangerous voltage" within the product's enclosure that may be of sufficient magnitude to constitute a risk of electric shock to persons.



The exclamation point within an equilateral triangle is intended to alert the user to the presence of important operating and maintenance (servicing) instructions in the literature accompanying the product.

INSTRUCTIONS PERTAINING TO A RISK OF FIRE, ELECTRIC SHOCK, OR INJURY TO PERSONS.

IMPORTANT SAFETY INSTRUCTIONS SAVE THESE INSTRUCTIONS

WARNING - When using electric products, basic precautions should always be followed, including the following:

1. Read these instructions.
2. Keep these instructions.
3. Heed all warnings.
4. Follow all instructions.
5. Do not use this apparatus near water.
6. Clean only with a dry cloth.
7. Do not block any of the ventilation openings. Install in accordance with the manufacturers instructions.
8. Do not install near any heat sources such as radiators, heat registers, stoves, or other apparatus (including amplifiers) that produce heat.
9. Do not defeat the safety purpose of the polarized or grounding-type plug. A polarized plug has two blades with one wider than the other. A grounding type plug has two blades and a third grounding prong. The wide blade or the third prong are provided for your safety. If the provided plug does not fit into your outlet, consult an electrician for replacement of the obsolete outlet.
10. Protect the power cord from being walked on or pinched particularly at plugs, convenience receptacles, and the point where they exit from the apparatus.
11. Only use attachments/accessories specified by the manufacturer.
12. Use only with the cart, stand, tripod, bracket, or table specified by the manufacturer, or sold with the apparatus. When a cart is used, use caution when moving the cart/apparatus combination to avoid injury from tip-over. 
13. Unplug this apparatus during lightning storms or when unused for long periods of time.
14. Refer all servicing to qualified service personnel. Servicing is required when the apparatus has been damaged in any way, such as power-supply cord or plug is damaged, liquid has been spilled or objects have fallen into the apparatus, the apparatus has been exposed to rain or moisture, does not operate normally, or has been dropped.

For the U.K.

IMPORTANT: THE WIRES IN THIS MAINS LEAD ARE COLOURED IN ACCORDANCE WITH THE FOLLOWING CODE.

BLUE: NEUTRAL
BROWN: LIVE

As the colours of the wires in the mains lead of this apparatus may not correspond with the coloured markings identifying the terminals in your plug, proceed as follows:

The wire which is coloured BLUE must be connected to the terminal which is marked with the letter N or coloured BLACK.

The wire which is coloured BROWN must be connected to the terminal which is marked with the letter L or coloured RED.

Under no circumstances must either of the above wires be connected to the earth terminal of a three pin plug.

USING THE UNIT SAFELY

INSTRUCTIONS FOR THE PREVENTION OF FIRE, ELECTRIC SHOCK, OR INJURY TO PERSONS

About ⚠ WARNING and ⚠ CAUTION Notices

⚠ WARNING	Used for instructions intended to alert the user to the risk of death or severe injury should the unit be used improperly.
⚠ CAUTION	Used for instructions intended to alert the user to the risk of injury or material damage should the unit be used improperly. * Material damage refers to damage or other adverse effects caused with respect to the home and all its furnishings, as well to domestic animals or pets.

About the Symbols

	The ⚠ symbol alerts the user to important instructions or warnings. The specific meaning of the symbol is determined by the design contained within the triangle. In the case of the symbol at left, it is used for general cautions, warnings, or alerts to danger.
	The ⓧ symbol alerts the user to items that must never be carried out (are forbidden). The specific thing that must not be done is indicated by the design contained within the circle. In the case of the symbol at left, it means that the unit must never be disassembled.
	The ⓧ symbol alerts the user to things that must be carried out. The specific thing that must be done is indicated by the design contained within the circle. In the case of the symbol at left, it means that the power-cord plug must be unplugged from the outlet.

ALWAYS OBSERVE THE FOLLOWING







⚠ WARNING

- Before using this unit, make sure to read the instructions below, and the Owner's Manual.
- Do not open or perform any internal modifications on the unit.
- Do not attempt to repair the unit, or replace parts within it (except when this manual provides specific instructions directing you to do so). Refer all servicing to your retailer, the nearest Roland Service Center, or an authorized Roland distributor, as listed on the "Information" page.
- Never use or store the unit in places that are:
 - Subject to temperature extremes (e.g., direct sunlight in an enclosed vehicle, near a heating duct, on top of heat-generating equipment); or are
 - Damp (e.g., baths, washrooms, on wet floors); or are
 - Humid; or are
 - Exposed to rain; or are
 - Dusty; or are
 - Subject to high levels of vibration.
- Make sure you always have the unit placed so it is level and sure to remain stable. Never place it on stands that could wobble, or on inclined surfaces.
- The unit should be connected to a power supply only of the type described in the operating instructions, or as marked on the rear side of unit.
- Use only the attached power-supply cord. Also, the supplied power cord must not be used with any other device.





⚠ WARNING

- Do not excessively twist or bend the power cord, nor place heavy objects on it. Doing so can damage the cord, producing severed elements and short circuits. Damaged cords are fire and shock hazards!
- This unit, either alone or in combination with an amplifier and headphones or speakers, may be capable of producing sound levels that could cause permanent hearing loss. Do not operate for a long period of time at a high volume level, or at a level that is uncomfortable. If you experience any hearing loss or ringing in the ears, you should immediately stop using the unit, and consult an audiologist.
- Do not allow any objects (e.g., flammable material, coins, pins); or liquids of any kind (water, soft drinks, etc.) to penetrate the unit.
- Immediately turn the power off, remove the power cord from the outlet, and request servicing by your retailer, the nearest Roland Service Center, or an authorized Roland distributor, as listed on the "Information" page when:
 - The power-supply cord, or the plug has been damaged; or
 - If smoke or unusual odor occurs
 - Objects have fallen into, or liquid has been spilled onto the unit; or
 - The unit has been exposed to rain (or otherwise has become wet); or
 - The unit does not appear to operate normally or exhibits a marked change in performance.







⚠ WARNING

- In households with small children, an adult should provide supervision until the child is capable of following all the rules essential for the safe operation of the unit. 
- Protect the unit from strong impact. (Do not drop it!) 
- Do not force the unit's power-supply cord to share an outlet with an unreasonable number of other devices. Be especially careful when using extension cords—the total power used by all devices you have connected to the extension cord's outlet must never exceed the power rating (watts/amperes) for the extension cord. Excessive loads can cause the insulation on the cord to heat up and eventually melt through. 
- Before using the unit in a foreign country, consult with your retailer, the nearest Roland Service Center, or an authorized Roland distributor, as listed on the "Information" page. 
- DO NOT play a CD-ROM disc on a conventional audio CD player. The resulting sound may be of a level that could cause permanent hearing loss. Damage to speakers or other system components may result. 
- Do not put anything that contains water (e.g., flower vases) on this unit. Also, avoid the use of insecticides, perfumes, alcohol, nail polish, spray cans, etc., near the unit. Swiftly wipe away any liquid that spills on the unit using a dry, soft cloth. 

⚠ CAUTION

- The unit should be located so that its location or position does not interfere with its proper ventilation. 
- Always grasp only the plug on the power-supply cord when plugging into, or unplugging from, an outlet or this unit. 
- At regular intervals, you should unplug the power plug and clean it by using a dry cloth to wipe all dust and other accumulations away from its prongs. Also, disconnect the power plug from the power outlet whenever the unit is to remain unused for an extended period of time. Any accumulation of dust between the power plug and the power outlet can result in poor insulation and lead to fire. 
- Try to prevent cords and cables from becoming entangled. Also, all cords and cables should be placed so they are out of the reach of children. 

⚠ CAUTION

- Never climb on top of, nor place heavy objects on the unit. 
- Never handle the power cord or its plugs with wet hands when plugging into, or unplugging from, an outlet or this unit. 
- If you need to move the instrument, take note of the precautions listed below. At least two persons are required to safely lift and move the unit. It should be handled carefully, all the while keeping it level. Make sure to have a firm grip, to protect yourself from injury and the instrument from damage. 
 - Check to make sure the screw securing the unit to the stand have not become loose. Fasten them again securely whenever you notice any loosening.
 - Disconnect the power cord.
 - Disconnect all cords coming from external devices.
 - Raise the adjusters on the stand (p. 11).
 - Close the lid.
 - Remove the music rest.
- Before cleaning the unit, turn off the power and unplug the power cord from the outlet (p. 9). 
- Whenever you suspect the possibility of lightning in your area, pull the plug on the power cord out of the outlet. 
- Be careful when opening/closing the lid so you do not get your fingers pinched (p. 10). Adult supervision is recommended whenever small children use the unit. 
- Should you remove the screws fastening the stand, and the music rest, and the thumbscrew fastening the headphone hook, make sure to put them in a safe place out of children's reach, so there is no chance of them being swallowed accidentally. 

IMPORTANT NOTES

In addition to the items listed under “IMPORTANT SAFETY INSTRUCTIONS” and “USING THE UNIT SAFELY” on pages 3 and 4, please read and observe the following:

Power Supply

- Do not connect this unit to same electrical outlet that is being used by an electrical appliance that is controlled by an inverter (such as a refrigerator, washing machine, microwave oven, or air conditioner), or that contains a motor. Depending on the way in which the electrical appliance is used, power supply noise may cause this unit to malfunction or may produce audible noise. If it is not practical to use a separate electrical outlet, connect a power supply noise filter between this unit and the electrical outlet.
- Before connecting this unit to other devices, turn off the power to all units. This will help prevent malfunctions and/or damage to speakers or other devices.
- Although the LCD and LEDs are switched off when the POWER switch is switched off, this does not mean that the unit has been completely disconnected from the source of power. If you need to turn off the power completely, first turn off the POWER switch, then unplug the power cord from the power outlet. For this reason, the outlet into which you choose to connect the power cord’s plug should be one that is within easy reach and readily accessible.

Placement

- Using the unit near power amplifiers (or other equipment containing large power transformers) may induce hum. To alleviate the problem, change the orientation of this unit; or move it farther away from the source of interference.
- This device may interfere with radio and television reception. Do not use this device in the vicinity of such receivers.
- Noise may be produced if wireless communications devices, such as cell phones, are operated in the vicinity of this unit. Such noise could occur when receiving or initiating a call, or while conversing. Should you experience such problems, you should relocate such wireless devices so they are at a greater distance from this unit, or switch them off.
- Observe the following when using the unit’s floppy disk drive. For further details, refer to “Before Using Floppy Disks” (p. 40).
 - Do not place the unit near devices that produce a strong magnetic field (e.g., loudspeakers).
 - Install the unit on a solid, level surface.
 - Do not move the unit or subject it to vibration while the drive is operating.
- Do not expose the unit to direct sunlight, place it near devices that radiate heat, leave it inside an enclosed vehicle, or otherwise subject it to temperature extremes. Also, do not allow lighting devices that normally are used while their light source is very close to the unit (such as a piano light), or powerful spotlights to shine upon the same area of the unit for extended periods of time. Excessive heat can deform or discolor the unit.
- When moved from one location to another where the temperature and/or humidity is very different, water droplets (condensation) may form inside the unit. Damage or malfunction may result if you attempt to use the unit in this condition. Therefore, before using the unit, you must allow it to stand for several hours, until the condensation has completely evaporated.
- Do not allow rubber, vinyl, or similar materials to remain on the unit for long periods of time. Such objects can discolor or otherwise harmfully affect the finish.

- Do not allow objects to remain on top of the keyboard. This can be the cause of malfunction, such as keys ceasing to produce sound.
- Do not paste stickers, decals, or the like to this instrument. Peeling such matter off the instrument may damage the exterior finish.

Maintenance

- To clean the unit, use a dry, soft cloth; or one that is slightly dampened. Try to wipe the entire surface using an equal amount of strength, moving the cloth along with the grain of the wood. Rubbing too hard in the same area can damage the finish.
- Never use benzine, thinners, alcohol or solvents of any kind, to avoid the possibility of discoloration and/or deformation.
- The pedals of this unit are made of brass. Brass eventually darkens as the result of the natural oxidization process. If the brass becomes tarnished, polish it using commercially available metal polisher.

Repairs and Data

- Please be aware that all data contained in the unit’s memory may be lost when the unit is sent for repairs. Important data should always be backed up on a floppy disk, or written down on paper (when possible). During repairs, due care is taken to avoid the loss of data. However, in certain cases (such as when circuitry related to memory itself is out of order), we regret that it may not be possible to restore the data, and Roland assumes no liability concerning such loss of data.

Additional Precautions

- Please be aware that the contents of memory can be irretrievably lost as a result of a malfunction, or the improper operation of the unit. To protect yourself against the risk of losing important data, we recommend that you periodically save a backup copy of important data you have stored in the unit’s memory on a floppy disk.
- Unfortunately, it may be impossible to restore the contents of data that was stored on a floppy disk once it has been lost. Roland Corporation assumes no liability concerning such loss of data.
- Use a reasonable amount of care when using the unit’s buttons, sliders, or other controls; and when using its jacks and connectors. Rough handling can lead to malfunctions.
- Never strike or apply strong pressure to the display.
- When connecting / disconnecting all cables, grasp the connector itself—never pull on the cable. This way you will avoid causing shorts, or damage to the cable’s internal elements.
- A small amount of heat will radiate from the unit during normal operation.
- To avoid disturbing your neighbors, try to keep the unit’s volume at reasonable levels. You may prefer to use headphones, so you do not need to be concerned about those around you (especially when it is late at night).
- When you need to transport the unit, pack it in shock-absorbent material. Transporting the unit without doing so can cause it to become scratched or damaged, and could lead to malfunction.

- Do not apply undue force to the music rest while it is in use.
- Use a cable from Roland to make the connection. If using some other make of connection cable, please note the following precautions.
 - Some connection cables contain resistors. Do not use cables that incorporate resistors for connecting to this unit. The use of such cables can cause the sound level to be extremely low, or impossible to hear. For information on cable specifications, contact the manufacturer of the cable.
- Before opening or closing the keyboard lid, always make sure that no pets or other small animals are located on top of the instrument (in particular, they should be kept away from the keyboard and its lid). Otherwise, due to the structural design of this instrument, small pets or other animals could end up getting trapped inside it. If such a situation is encountered, you must immediately switch off the power and disconnect the power cord from the outlet. You should then consult with the retailer from whom the instrument was purchased, or contact the nearest Roland Service Center.
- Howling could be produced depending on the location of microphones relative to speakers. This can be remedied by:
 1. Changing the orientation of the microphone(s).
 2. Relocating microphone(s) at a greater distance from speakers.
 3. Lowering volume levels.

Before Using Floppy Disks

Handling the Floppy Disk Drive

- Install the unit on a solid, level surface in an area free from vibration.
- Avoid using the unit immediately after it has been moved to a location with a level of humidity that is greatly different than its former location. Rapid changes in the environment can cause condensation to form inside the drive, which will adversely affect the operation of the drive and/or damage floppy disks. When the unit has been moved, allow it to become accustomed to the new environment (allow a few hours) before operating it.
- To insert a disk, push it gently but firmly into the drive—it will click into place. To remove a disk, press the EJECT button firmly. Do not use excessive force to remove a disk which is lodged in the drive.
- Never attempt to remove a floppy disk from the drive while the drive is operating (the indicator is lit); damage could result to both the disk and the drive.
- The indicator light for the disk drive lights up at full brightness when reading or writing data, and lights up at half brightness at other times. Don't try to eject the disk while reading or writing is in progress (that is, when the indicator light is lit up at full brightness). Attempting to do so may damage the magnetic surface of the disk, rendering it unusable.
- Remove any disk from the drive before powering up or down.
- To prevent damage to the disk drive's heads, always try to hold the floppy disk in a level position (not tilted in any direction) while inserting it into the drive. Push it in firmly, but gently. Never use excessive force.
- To avoid the risk of malfunction and/or damage, insert only floppy disks into the disk drive. Never insert any other type of disk. Avoid getting paper clips, coins, or any other foreign objects inside the drive.

Handling Floppy Disks

- Floppy disks contain a plastic disk with a thin coating of magnetic storage medium. Microscopic precision is required to enable storage of large amounts of data on such a small surface area. To preserve their integrity, please observe the following when handling floppy disks:
 - Never touch the magnetic medium inside the disk.
 - Do not use or store floppy disks in dirty or dusty areas.
 - Do not subject floppy disks to temperature extremes (e.g., direct sunlight in an enclosed vehicle). Recommended temperature range: 0 to 50° C (50 to 122° F).
 - Do not expose floppy disks to strong magnetic fields, such as those generated by loudspeakers.
- Floppy disks have a "write protect" tab which can protect the disk from accidental erasure. It is recommended that the tab be kept in the PROTECT position, and moved to the WRITE position only when you wish to write new data onto the disk.

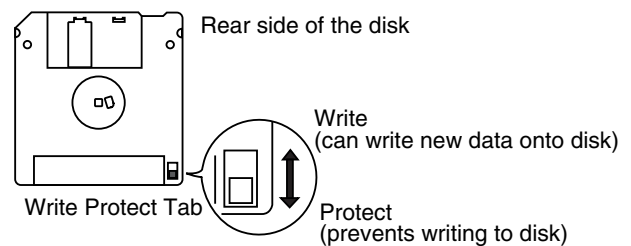

- The identification label should be firmly affixed to the disk. Should the label come loose while the disk is in the drive, it may be difficult to remove the disk.
- Store all disks in a safe place to avoid damaging them, and to protect them from dust, dirt, and other hazards. By using a dirty or dust-ridden disk, you risk damaging the disk, as well as causing the disk drive to malfunction.
- Disks containing performance data for this unit should always be locked (have their write protect tab slid to the "Protect" position) before you insert them into the drive on some other unit (except the PR-300, or a product in the HP-G, HPi, MT, KR, or Atelier families), or into a computer's drive. Otherwise (if the write protect tab remains in the "Write" position), when you perform any disk operations using the other device's disk drive (such as checking the contents of the disk, or loading data), you risk rendering the disk unreadable by this unit's disk drive.

Handling CD-ROMs

- Avoid touching or scratching the shiny underside (encoded surface) of the disc. Damaged or dirty CD-ROM discs may not be read properly. Keep your discs clean using a commercially available CD cleaner.

* GS () is a registered trademark of Roland Corporation.

* XG lite () is a registered trademark of Yamaha Corporation.

* All product names mentioned in this document are trademarks or registered trademarks of their respective owners.

Contents

USING THE UNIT SAFELY	3
IMPORTANT NOTES	5
Before You Begin Playing	9
Making the Connections	9
Connecting the pedal cable	9
Connecting the Speaker Cable (HPi-7LE only)	9
Attach the music rest	9
Connect the power cord	9
Connect headphones	9
Using the Headphone Hook	10
Opening and Closing the Lid	10
Turning the Power On/Off	10
Adjusting the Volume or Brightness of the Sound	10
Adjusting the Contrast of the Screen	10
About the Pedals	11
Disabling Functions Other Than Piano Performance (Panel Lock)	11
Cancelling Auto Demo	11
Panel Descriptions	12
Front Panel	12
Rear Panel	13
Bottom Panel	13
Music Rest	13
Basic Operation and the Main Screen	14
Basic operation	14
1. Notation screen (basic screen)	14
2. List screen	14
3. Detailed settings screen	14
Messages	14
Playing Along With A Song	15
Notation Screen	15
Button Operations	16
Playing a Song	16
Playing songs consecutively (All Song Play)	18
Playing back at a fixed tempo	19
Registering the Songs You Like (Favorites)	19
Removing Songs from Favorites	19
Using the Metronome	20
Adding a Count to Assist Your Timing	21
Assigning Markers to a Song for Repeated Practice	22
Assigning a marker in the middle of a measure (Resolution)	23
Changing the Key of the Keyboard or Song Playback (Transpose)	24
Adjusting the Keyboard Touch (Key Touch)	25
Adding Variety to Your Performances	26
Selecting the Sound to Play	26
Playing percussion instruments or sound effects	26
Applying Effects to the Sound	27
Adding reverberation to the sound (Reverb)	27
Adding richness to the sound (Chorus)	27
Playing Two Sounds Layered Together (Dual)	27
Playing Different Sounds in the Right and Left Hand (Split)	28
Changing from dual performance to split performance	29
To switch from split to dual performance	29
Using the Lesson Function (Visual Lesson)	30
Practicing with Internal Songs and Songs on Floppy Disks	31
Adding an Accompaniment to Your Performance (Pianist Function)	32
Playing in a Wonderland of Sound	33
Explanation of each selection	33
Recording Your Performance	34
Recording Along with a Song	34
Recording a New Song	36
Re-recording	38
Erasing a Recorded Song	39
Other Recording Methods	39
Recording with an accompaniment (the Pianist function)	39
Multitrack recording on five tracks	40
Saving Your Performance	41
Using Floppy Disks	41
Inserting/removing a floppy disk	41
Formatting a floppy disk	41
Saving Songs	42
Deleting Saved Songs	43
Copying Songs	44
Playing Back Music Files or a Song that was Saved on Floppy Disk	46
Convenient Functions	47
Changing the Notation Screen Settings	47
Editing Songs	48
Undoing Edits (Undo)	49
Copying Measures (Copy)	49
Correcting Timing Discrepancies (Quantize)	49
Deleting Measures (Delete)	50
Inserting Blank Measures (Insert)	50
Transposing Individual Parts (Transpose)	51
Making Measures Blank (Erase)	51
Exchanging Parts (Part Exchange)	51
Correcting Notes One by One (Note Edit)	52
Modifying the Tone Changes in a Song (PC Edit)	52
Saving the Notation Data in BMP Format	52
Functions that Can be Selected Using the [Function] Button	54
Adjusting the volume balance between accompaniment and keyboard (Balance)	55
Adjusting the Piano Sounds (Piano Setting)	55

Contents

Adjusting the depth of the effects (Effect).....	55
Setting the reference pitch and temperament (Tuning).....	55
Mic Echo.....	56
Changing the function of the pedals (Pedal)	56
Changing the language displayed in the screen (Language)	56
Selecting Images To Be Shown on the Displays (User Image Display).....	57
Setting the Demo (Auto DEMO).....	57
Changing the parts assigned to the track buttons during SMF playback (Track Assign).....	57
Recording and Playing Back Performances of Specific Instruments (16 Track).....	58
Formatting the User Memory (Initialize User Memory).....	59
Remembering the settings even when the power is turned off (Memory Backup).....	59
Restoring the factory settings (Factory Reset)	60
Using the V-LINK function	60
Changing the Tone Settings When Playing Back Songs (Play Mode)	60
Playing the Demos.....	60
Connecting External Devices.....	61
Connecting Audio Devices.....	61
Connections with MIDI Devices.....	61
What is MIDI?.....	61
Connections to a Computer	62
Making MIDI-Related Settings	62
MIDI settings	62
Making the Settings for the USB Driver	63
Appendix	64
Trouble Shooting	64
If this Message Appears on Screen	66
Tone List.....	67
SFX Set	69
Drum Set List.....	70
Chord List	74
Internal Song List.....	75
Songs for Visual Lesson	76
Pianist Style List.....	76
Music Files That the HPi-7 Can Use	77
MIDI Implementation Chart	78
Main Specifications.....	79
Index.....	80
Connecting an External Display (HPi-7LE only).....	82

Conventions Used in This Manual

This manual uses the following conventions in the interest of simpler, more concise instructions.

- Button names are enclosed in square brackets “[]”, as in One Touch Program [Piano] button.
- An asterisk (*) at the beginning of a paragraph indicates a note or precaution. These should not be ignored.
- (p. **) refers to pages within the manual.
- [+][-], [▲][▼], [◀][▶] means that you should press one or the other button.

Before You Begin Playing

Making the Connections

Connecting the pedal cable

Insert the pedal cable into the Pedal connector on the rear panel of the HPi-7.

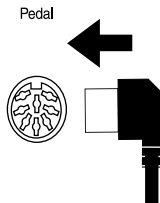

Connecting the Speaker Cable (HPi-7LE only)

- 1 As shown in the diagram, connect the speaker cable leading from the speaker box of the stand to the speaker connector located on the rear bottom of the HPi-7 LE. Push the speaker cable in until it clicks into position.

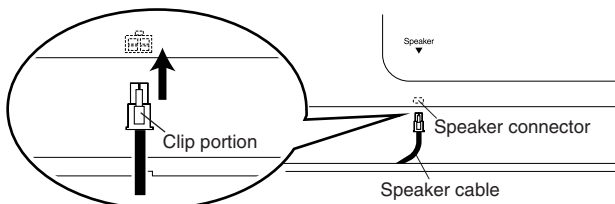

- * Do not put anything that contains water (e.g., flower vases) on this unit. Also, avoid the use of insecticides, perfumes, alcohol, nail polish, spray cans, etc., near the unit. The speakers of this piano are mounted beneath the upper surface, and face upwards. Malfunctions or accidents may occur if liquids contact any part of the speakers.

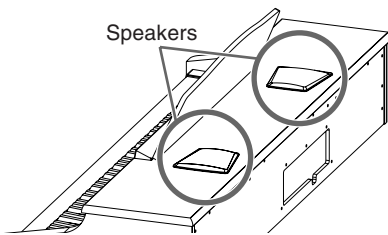

Attach the music rest

The music rest of the HPi-7 contains a liquid crystal display screen. Use the following procedure, and handle the music rest with care.

- 1 Insert the music rest as shown in the diagram.

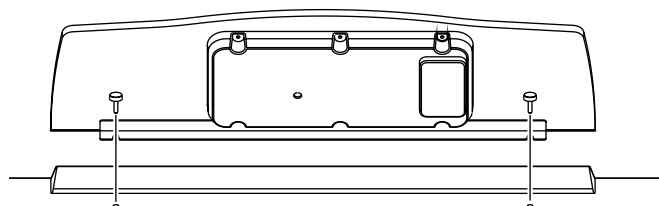

- 2 Connect the cable of the music rest to the LCD Out connector on the rear panel of the HPi-7.

- * The power must be off when connecting the cable of the music rest.

Connecting

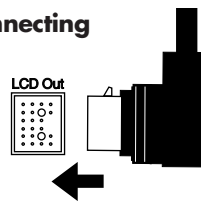

Disconnecting

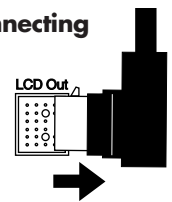

Connect the power cord

Insert the included power cord into the AC inlet on the bottom panel of the HPi-7, and then plug it into an AC power outlet.

- * Use only the included power cord.

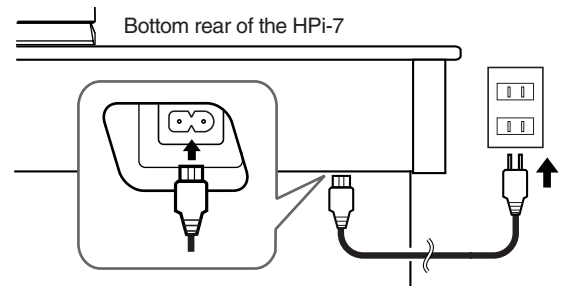

Connect headphones

- 1 Plug the headphones into the Phones jack on the bottom panel of the HPi-7.

When you connect headphones, no sound will be output from the internal speakers.

The headphone volume is adjusted by the [Volume] knob (p. 12) of the HPi-7.

- * Please use stereo headphones.
- * Make sure to use only Roland headphones. Headphones from other manufacturers may be unable to provide sufficient volume.

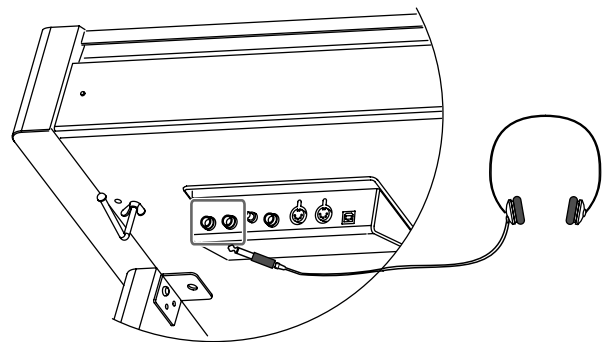

Some Notes on Using Headphones

- To avoid damaging or severing the headphone cord, be sure to handle the headphones by holding the phones themselves, and grasping the plug and not the cord when pulling the headphone plug.
- To prevent possible auditory damage, loss of hearing, or damage to the headphones, the headphones should not be used at an excessively high volume. Listen at appropriate levels.
- The headphones may be damaged if the volume is too high when they are plugged in. Connect the headphones only after turning the volume down completely.

Before You Begin Playing

Using the Headphone Hook

Whenever you are not using the headphones, you can hang them on the headphone hook at the lower left of the HPi-7.

Attaching the Headphone Hook

Press and twist the headphone hook included with the HPi-7 into the hole in the bottom of the HPi-7 (refer to the figure below). Turn the headphone hook thumbscrew to secure the headphone hook.

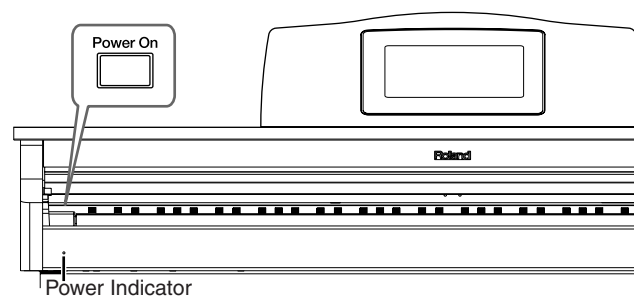
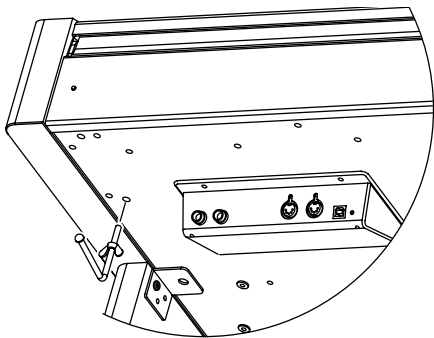

To turn the power off, turn the [Volume] knob all the way to the left, and press the [Power On] switch.

The Power indicator at the left front of the HPi-7 will go dark, and the power will be turned off.

- * If you need to turn off the power completely, first turn off the POWER switch, then unplug the power cord from the power outlet. Refer to **Power Supply** (p. 5).

Opening and Closing the Lid

To open the lid, use both hands to lift it lightly, and slide it away from yourself.

To close the lid, pull it gently toward yourself, and lower it softly after it has been fully extended.

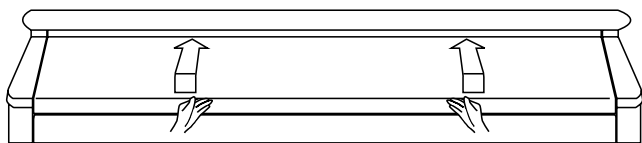

- * Be careful not to get your fingers pinched when opening or closing the lid. If small children will be using the HPi-7, adult supervision should be provided.
- * To prevent accidents, the lid must be closed when transporting the piano.

Turning the Power On/Off

- * Once the connections have been completed (p. 9), turn on power to your various devices in the order specified. By turning on devices in the wrong order, you risk causing malfunction and/or damage to speakers and other devices.

To turn the power on, turn the [Volume] knob all the way down, and then press the [Power On] switch.

The power will turn on, and the Power indicator at the left front of the HPi-7 will light.

After a few seconds, you will be able to play the keyboard to produce sound. Use the [Volume] knob to adjust the volume.

- * This unit is equipped with a protection circuit. A brief interval (a few seconds) after power up is required before the unit will operate normally.

Adjusting the Volume or Brightness of the Sound

Turn the [Volume] knob to adjust the overall volume.

Turn the [Brilliance] knob to adjust the brightness of the sound.



Adjusting the Contrast of the Screen

To adjust the contrast of the screen, turn the [Contrast] knob located at the back of the music rest.

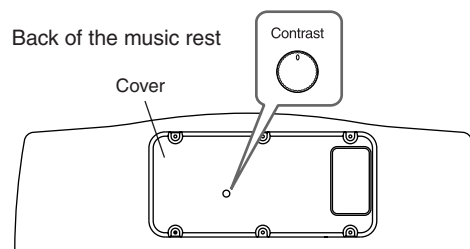

Some Notes on Using the LCD screen

- Never remove the liquid crystal display cover at the back of the music rest. By removing it you risk electrical shock and/or malfunction.
- You may see vertical lines in the screen, but this is due to the structure of a liquid crystal display, and does not indicate a malfunction. By using the [Contrast] knob to adjust the contrast of the screen, you can minimize these lines.
- The contrast of the screen may be affected by the temperature.

About the Pedals

The pedals have the following functions, and are used mainly for piano performance.

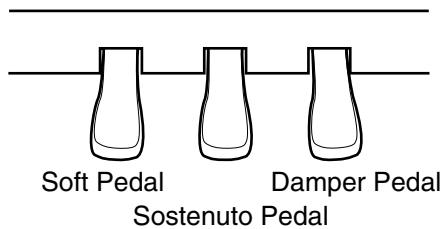

Damper pedal (right pedal)

While this pedal is pressed, notes will be sustained even after you take your fingers off the keys. The depth to which you press the pedal will subtly affect the duration of the sustain.

On an acoustic piano, holding down the damper pedal will allow the remaining strings to resonate in sympathy with the sounds that you played from the keyboard, adding a rich resonance.

The HPi-7 simulates this sympathetic resonance.

→ You can adjust the amount of sympathetic resonance that occurs when you press the damper pedal. Refer to “Adjusting the depth of the effects (Effect)” (p. 55).

Sostenuto pedal (center pedal)

This pedal sustains only the sounds of the keys that were already played when you pressed the pedal.

Soft pedal (left pedal)

When you hold down this pedal and play the keyboard, the sound will have a softer tone.

The softness of the tone can be varied subtly by the depth to which you press the pedal.

→ The Sostenuto pedal and Soft pedal can be given functions other than these. Refer to “Notation Screen” (p. 15) and “Changing the function of the pedals (Pedal)” (p. 56).

About the adjuster

When you move the HPi-7 or if you feel that the pedals are unstable, adjust the adjuster located below the pedals as follows.

- Rotate the adjuster to lower it so that it is in firm contact with the floor. If there is a gap between the pedals and the floor, the pedals may be damaged. In particular when placing the instrument on carpet, adjust this so that the pedals firmly contact the floor.

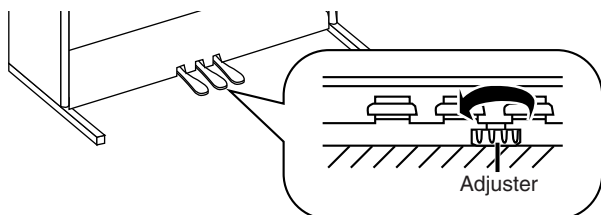

Disabling Functions Other Than Piano Performance (Panel Lock)

The “Panel Lock” function locks the HPi-7 in a state where only piano performance can be used, and all buttons will be disabled. This prevents the settings from being inadvertently modified even if children press the buttons accidentally.

- * In the Panel Lock state, only the grand piano sound can be played. Also, nothing will be displayed in the screen.

- 1 Turn the volume to the minimum, and press the [Power On] switch to turn off the power.
- 2 Hold down the [Function] button, and press the [Power On] switch to turn on the power.

Continue holding down the button for six or seven seconds.

Adjust the volume. When you play the keyboard, the grand piano sound will be heard.

To defeat the Panel Lock function, turn the volume down to the minimum, and turn on the power once again.

Cancelling Auto Demo

The HPi-7 is set at the factory so that it automatically starts playback of the demo songs whenever the keys and controls have been left untouched for a few minutes.

You can cancel this setting.

- 1 Press the [Function] button.

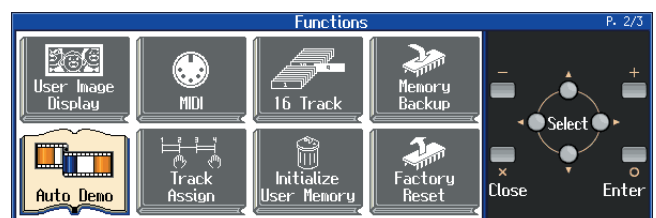

- 2 Press the [◀][▲][▶][▼] buttons to select “Auto Demo,” then press [○(Enter)] button.

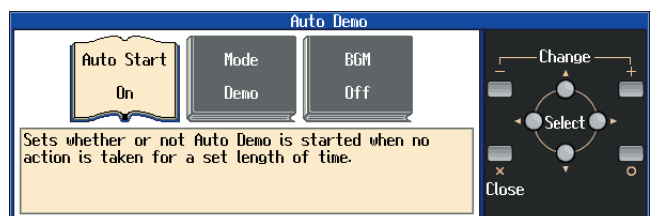

- 3 Press the [◀][▶] buttons to select “Auto Start,” then press the [+][–] buttons to set this to “Off”.
- 4 Press the [×(Close)] button to return the Notation screen to the display.

→ For more details about Auto Demo, refer to p. 57.

Panel Descriptions

Front Panel

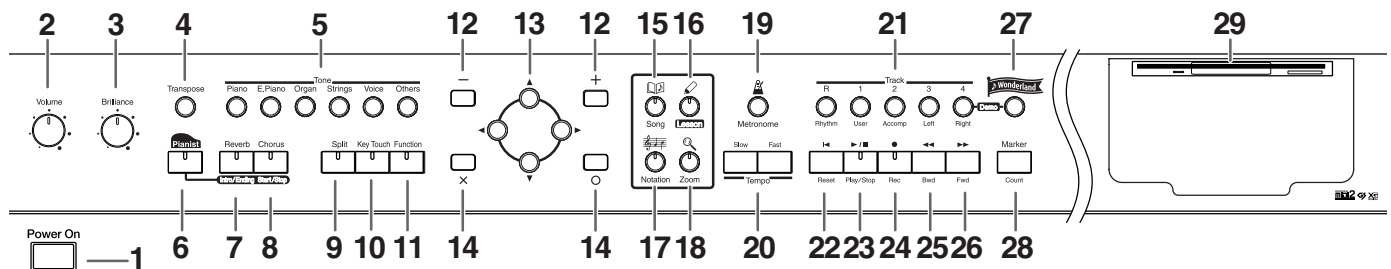

1 [Power On] switch

Pressed to switch the power on and off (p. 10).

2 [Volume] knob

Adjusts the overall volume (p. 10).

3 [Brilliance] knob

Adjusts the brightness of the sound (p. 10).

4 [Transpose] button

Transposes the pitch of the keyboard or the song being played (p. 24).

5 [Tone] buttons

Select the type of sound (the tone group) that will be played from the keyboard (p. 26).

6 [Pianist] button

You can use the Pianist function to add an accompaniment to your playing (p. 32).

7 [Reverb]/[Intro/Ending] button

Adds reverberation to the sound (p. 27).
When you are using the Pianist function, this starts/stops the accompaniment with an intro or ending (p. 32).

8 [Chorus]/[Start/Stop] button

Adds spaciousness to the sound (p. 27).
When you are using the Pianist function, this starts/stops the accompaniment (p. 32).

9 [Split] button

Lets you play different sounds in the left and right-hand areas of the keyboard (p. 28).

10 [Key Touch] button

Adjusts the touch of the keyboard (p. 25).

11 [Function] button

Selects various performance-related functions (p. 41–p. 44, p. 54–p. 63).

12 [+] [-] buttons

Used to select the value that you want to set (p. 14).

13 [◀][▲][▶][▼] buttons (Cursor buttons)

Used to select the item that you want to set (p. 14).
Depending on the screen, other functions may be assigned.

14 [X][O] buttons

Press the [O] button to confirm the selections you've made using the Cursor buttons (13) (p. 14).

The [X] cancels the operation, or displays the notation screen. Depending on the screen, other functions may be assigned.

15 [Song] button

Use this button to select internal songs or songs from floppy disk (p. 16, p. 46).

16 [Lesson] button

You can enjoy your practices with the Lesson function (p. 30).

17 [Notation] button

Displays the notation using the entire screen. (p. 15).

18 [Zoom] button

This magnifies the notation (zooms in) (p. 16).

19 [Metronome] button

Sounds the internal metronome (p. 20).

20 Tempo [Slow] [Fast] buttons

Adjust the tempo (p. 16, p. 20, p. 32).
Simultaneously pressing the [Slow] and [Fast] buttons will restore the basic tempo.

21 Track buttons

Used to play back or record each track of a song (p. 16, p. 37, p. 40).

22 [◀(Reset)] button

Resets the song playback-start location to the beginning of the song.

23 [▶/■(Play/Stop)] button

This starts and stops playback and recording of songs.

24 [●(Rec)] button

When pressed, this button places the instrument in recording standby (p. 34–p. 40).

25 [◀◀(Bwd)] button

Rewinds the song.

26 [▶▶(Fwd)] button

Fast-forwards the song.

27 [Wonderland] button

Here you can enjoy the "Drums," "SFX," and "Game," and learn about instruments while having fun (p. 33).

28 [Marker/Count] button

This is also used for setting the count (p. 21).
These allow you to add and move markers in the notation as well as repeat playback of song segments simply and easily.

29 Disk Drive

You can insert a floppy disk for playing back or saving songs (p. 41, p. 46).

Rear Panel



1 LCD Out Connector

Connect the cable of the music rest to this connector (p. 9).

2 Pedal connector

Connect the pedal cable of the stand to this connector (p. 9).

3 Input jacks

These jacks can be connected to another sound generating device or an audio device, so that the sound of that device will be output from the HPi-7's speakers (p. 61).

4 Output jacks

These jacks can be connected to your audio system to enjoy more powerful sound. They can also be connected to a tape recorder or similar device in order to record your performance on a cassette tape (p. 61).

Bottom Panel

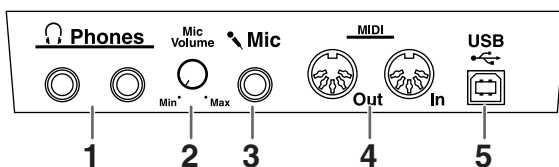

1 Phones jacks

A set of headphones can be connected here (p. 9).

2 Mic Volume knob

Adjusts the volume level for the microphone.

3 Mic jacks

Used for connecting microphones, so that the sound will be output from the HPi-7's speakers (p. 56).

4 MIDI Out/In connector

An external MIDI device can be connected here to receive performance data (p. 61).

5 USB connector

Used for connecting a computer to the HPi-7 using a USB cable (p. 62).

Music Rest

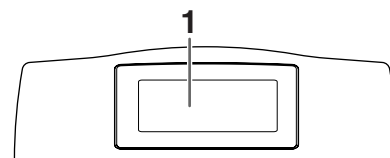

1 Display

This screen displays the notation of an internal song or disk song, and also displays various settings.

- * The explanations in this manual include illustrations that depict what should typically be shown by the display. Note, however, that your unit may incorporate a newer, enhanced version of the system (e.g., includes newer sounds), so what you actually see in the display may not always match what appears in the manual.

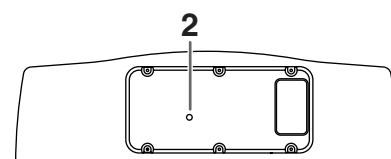

2 [Contrast] knob

This knob adjusts the contrast of the screen (p. 10).

Basic Operation and the Main Screen

Basic operation

The HPi-7 is operated mainly by using the cursor buttons and [O] [X] [+] [-] buttons while viewing the screen.

The every screen shows the functions of the cursor buttons and the [O] [X] [+] [-] buttons.

The main functions are as follows.

Cursor [◀][▲][▶][▼] buttons:

Move to an item to select it, switch pages

[O] **button:** Finalize the selected value

[X] **button:** Display the notation screen, or return to the previous screen

[+] [-] **button:** change the selected value

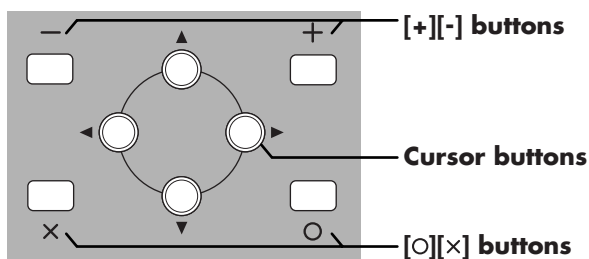

The main screens include the following.

1. Notation screen (basic screen)

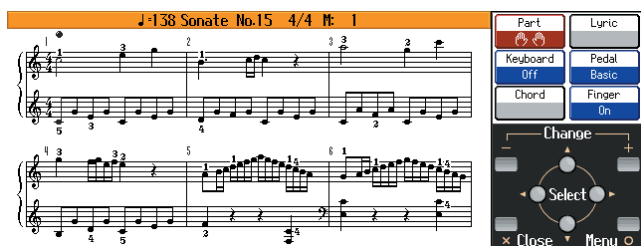

This is the first screen that will be displayed when you turn on the power.

If some other screen is displayed, you can press the [Notation]

button, then press the [O] button to access this screen.

For details on the notation screen display, refer to p. 15.

2. List screen



This type of list screen will appear when you select songs, tones, or accompaniment styles.

In this screen, use the cursor buttons to select the desired item. The selected item will be highlighted.

3. Detailed settings screen

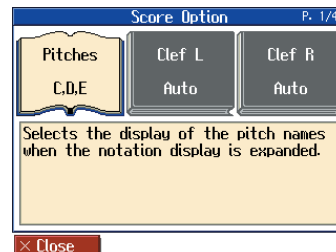
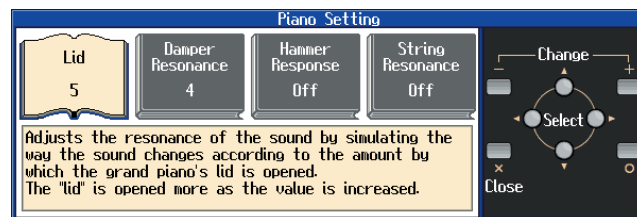

Detailed settings for functions are made in a screen similar to this.

The currently selected item will be highlighted, and you can use the [+] [-] buttons to edit the value. An explanation of the selected item is shown below the item. For some items, an explanation of the values will also be displayed.

If you simultaneously press the [+] and [-] buttons, the value will revert to the basic setting.

When you press the [X] button the selected value will be finalized, and you'll then be returned to the screen that was displayed prior to the current screen.

When "P.*/*" appears at the upper right of the screen, it indicates that there are other parameters on the previous or next page.

Messages

Various messages will sometimes be displayed during operation.

These messages ask you to confirm an operation, inform you of the results of an operation, or indicate an error when an operation could not be performed.

For details on error messages that begin with "Error," refer to p. 66.

When a message like the following is displayed, use the [◀][▶] buttons to select your response, and press the [O] button to finalize it. Pressing the [X] button returns you to the previous screen.



Playing Along With A Song

Notation Screen

When the power of the HPi-7 is turned on, a notation screen like the following will appear in the display.

This can display not only the onboard songs, but also the notation for SMF music files or a performance that you've recorded on the HPi-7.

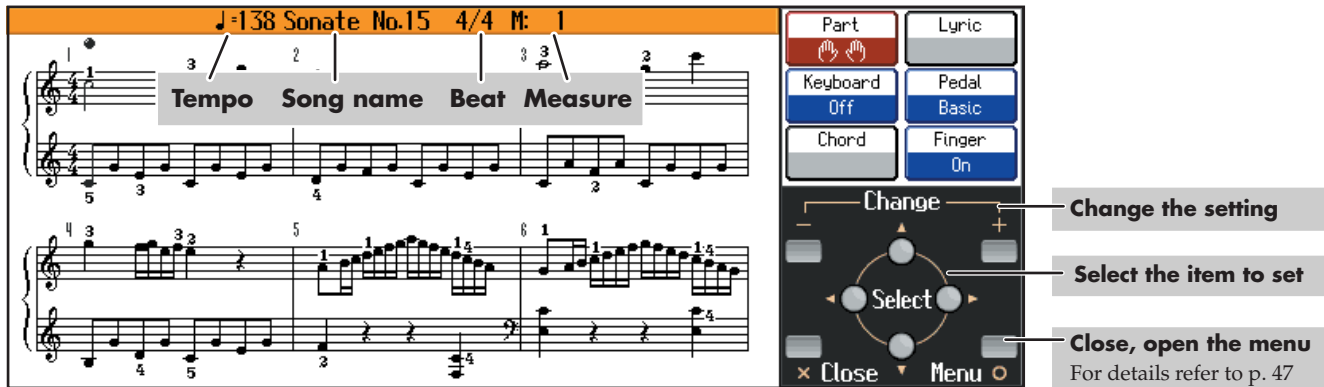

Part

Select the part(s) for which the notation will be displayed.

- : Notation for both hands
- : Right-hand notation only
- : Left-hand notation only
- : Notation of the specified part

(→ to change the part, see p. 47)

Keyboard

The keyboard will be displayed under the notation if you check this.

Chord

When playing back song data that contains chord data, the chord name will be displayed if you check this. This item cannot be selected if there is no chord data.

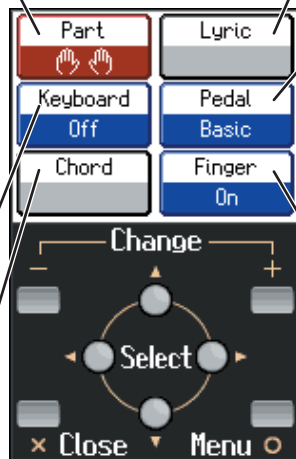

Lyrics

When playing back song data that contains lyric data, the lyrics will be displayed if you check this. This item cannot be selected if there is no lyric data.

Pedal

When "Replay" is selected, you can start and stop playback of the song data by pressing the left pedal (p. 56). When "PageTurn" is selected, you can turn the pages of the score by pressing the pedals. Press the center pedal to turn to the next page in the score, and press the left pedal to turn to the previous page.

Fingering

When playing back song data that includes fingering numbers, the fingering numbers will be displayed if you check this. This is convenient when you want to practice the correct fingering. The fingers are numbered as follows: 1: thumb, 2: index finger, 3: middle finger, 4: ring finger, 5: little finger. This item cannot be selected if there is no fingering data.

- * If you have selected a part that contains no performance data, the notation will not show any notes. To change the part that is displayed, refer to "Changing the Notation Screen Settings" (p. 47).
- * The fingering numbers shown in the screen indicate one possible fingering.
- * The fingering numbers can be displayed only when playing some internal song.

Some notes on the notation screen

- When you begin song playback, the notation screen will show . While this symbol is displayed, performance data is being loaded from floppy disk or internal memory. It may take dozens to read the data. Please wait.
- The displayed notation is generated from the music files, and priority is given to making the display easy to read rather than reproducing a complicated or difficult performance accurately. For this reason, you may notice differences when compared with commercially available sheet music. In particular, this is not suitable for display of sophisticated or complex songs that require detailed notations.
- In the notation screen, lyrics or notes may fall outside the display range of the screen, and fail to be shown.
- If you display the notation or change the displayed part during song playback, the song may sometimes play back from the beginning.

Playing Along With A Song

Button Operations

The following buttons are used to play back a song.

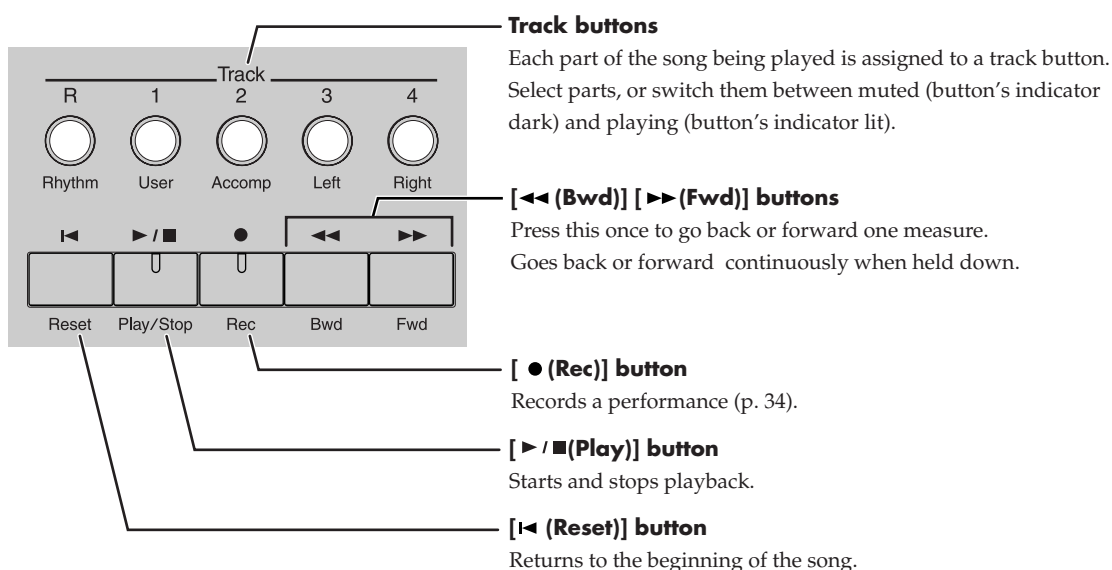
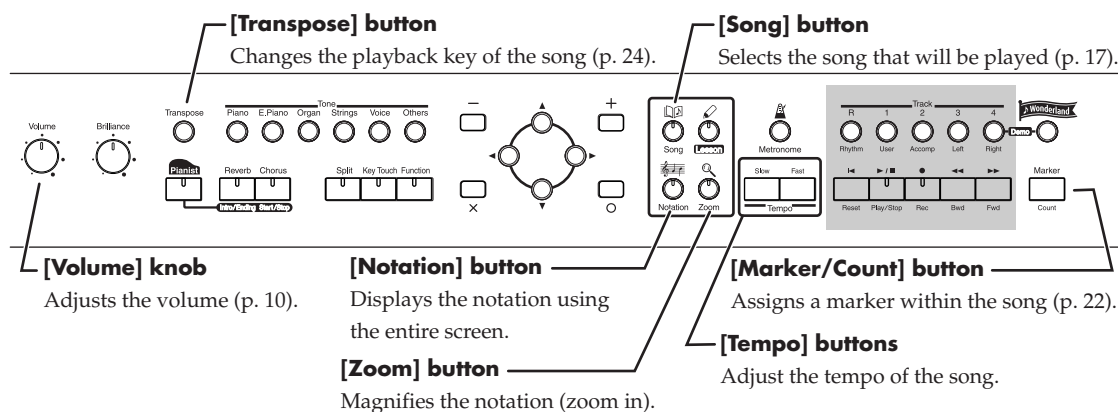

* If you hold down the [▶ / ■ (Play/Stop)] button and press the [>> (Fwd)] button, you will move to the end of the song.

Playing a Song

The HPi-7 comes with 170 piano songs onboard.

All of these can be viewed in the notation screen.

They also have orchestral accompaniments, so you can play along with the accompaniment, or adjust the tempo to the desired speed for easier practice.

→ "Internal Song List" (p. 75)

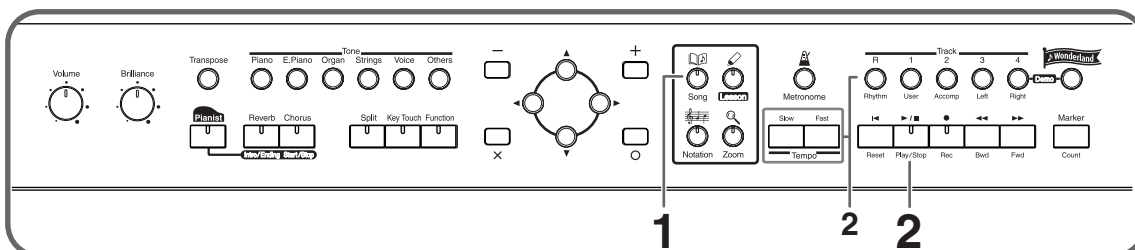

Select a song

1 Press the [Song] button. In the screen, select the song that you want to play.

Genre
Press [◀] [▶] to select the genre.
Selectable songs differ for each genre.

Song name
The name of the currently selected song.

Disk
Select songs from disk.
For details refer to p. 46.

Song list
The selection will be highlighted in black.

Chords, fingerings, and lyrics in songs containing such data are displayed here.

Select a song

Register to "Favorites"
For details refer to p. 19.

Select a genre

Audition the selected song

Back to score screen

Play back

2 Press the [▶ / ■ (Play/stop)] button.

The button's indicator will light.

The song will begin playing.

While the screen shows the  symbol, the song data is being loaded.

To adjust the tempo

Use the Tempo [Slow] [Fast] buttons to adjust the tempo.

The tempo is adjusted in terms of the value of a quarter note, with 10-500 being the permissible range.

If you press the Tempo [Slow] [Fast] buttons simultaneously, you will return to the basic tempo of the song (the tempo before it was modified).

Muting (silencing) parts of the playback

You can mute the sound of specific playback parts, and play them yourself.

Press a track button to mute a specific track.

The indicators of the buttons you pressed will go dark, and the selected track will not be heard.

To cancel muting, press the same track button once again to make the indicator light.

* When playing back SMF music files for Roland Piano Digital series instruments, and the [3/Left hand] button and [4/Right hand] button do not correctly control the left/right-hand performances, please change the "Track Assign" settings.

Please refer to "Changing the parts assigned to the track buttons during SMF playback (Track Assign)" (p. 57).

Stop the song

3 Press the [▶ / ■ (play/Stop)] button once again.

Playback will stop automatically when it reaches the end of the song.

Press the [◀ (Reset)] button to return to the beginning of the song.

Playing Along With A Song

If a screen like the following is displayed



If a song has already been selected in the current area (internal memory), it will not be possible to choose another song or record a new performance.

If you want to erase the song, use the [◀] [▶] buttons to select "OK," then press the [○ (Execute)] button. If you do not want to erase the song, select "Cancel" and save the song on a floppy disk (p. 42).

Playing songs consecutively (All Song Play)

The internal songs can be played back consecutively.

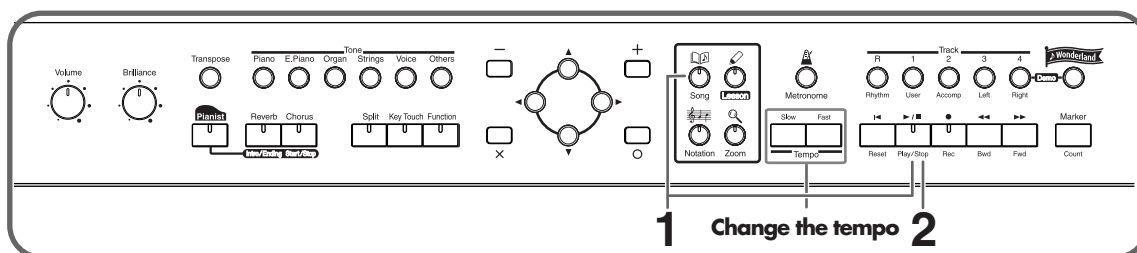

1 Hold down the track [Song] button and press the [▶/■ (Play/Stop)] button.

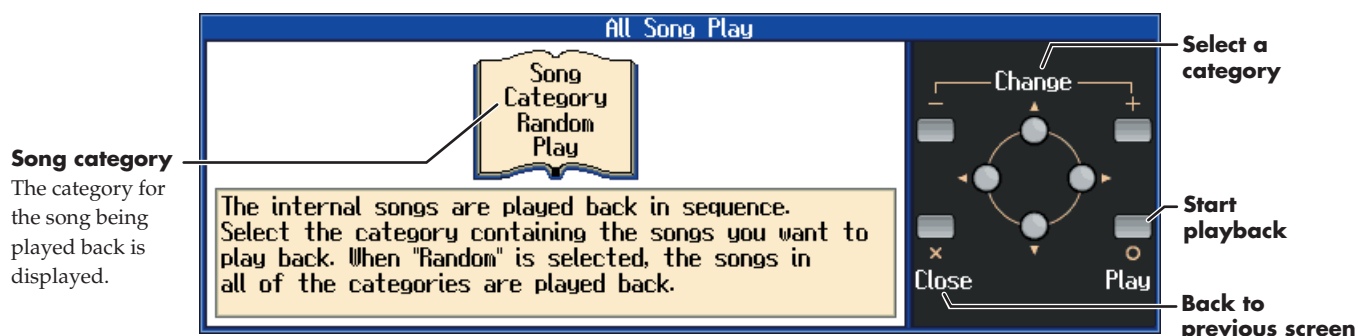

item	Value
Song Category	Random Play, Practice, Masterpieces, Popular, Favorites, Disk (only when the floppy disk is inserted in the floppy disk drive)

When you press the [○ (Play)] button, all of the internal songs in the selected category are played back. If you want to play back songs on floppy disks you have, select "Disk."

If no operations are performed for dozens of seconds, "Random Play" will start automatically.

Songs will be played consecutively.

When all selected songs have been played, playback will return to the first song and resume.

Stop playback

2 Press the [▶/■ (Play/Stop)] button.

Playback will stop.

Playing back at a fixed tempo

In the case of a song with difficult tempo changes, it is effective to practice initially with a fixed tempo. Playing back at a fixed tempo without allowing tempo changes is called "Tempo Mute."

- 1 Hold down the [▶/■ (Play/Stop)] button and press either the Tempo [Slow] or [Fast] button.

While Tempo Mute is enabled, the indication of the tempo in the screen will be highlighted.



When you play back the song, it will play at a constant tempo.

To defeat Tempo Mute, hold down the [▶/■ (Play/Stop)] button and press either the Tempo [Slow] or [Fast] button.

Tempo Mute will also be cancelled when you select a different song.

Registering the Songs You Like (Favorites)

You can register songs you are currently practicing or enjoy playing to "Favorites," allowing you to select these songs easily.

- 1 Selecting the Song

- 2 Press the [+] button.

A screen like the one shown below appears.

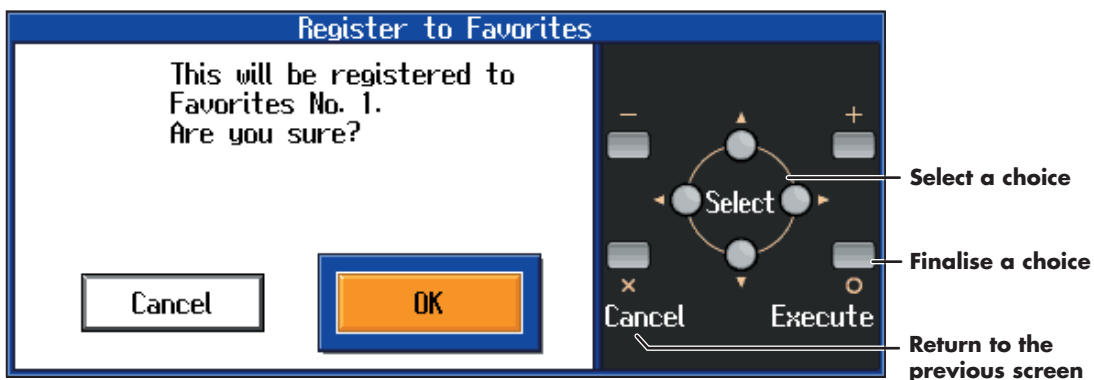

- 3 Select "OK" and press the [○ (Execute)] button.

The selected song is registered to Favorites.

Now you can select the registered song by selecting Favorites for the genre in the Song Selection screen.

* Never turn off the power while the display indicates "Executing...."

Removing Songs from Favorites

Select "Favorites" in the song select screen, choose the song you want to delete, then press the [+] button.

* Never turn off the power while the display indicates "Executing...."

Playing Along With A Song

Using the Metronome

The HPi-7 contains a versatile metronome function.

While a song or accompaniment (Pianist function, p. 32) is playing, the metronome will sound at the corresponding tempo and time signature (Beat).

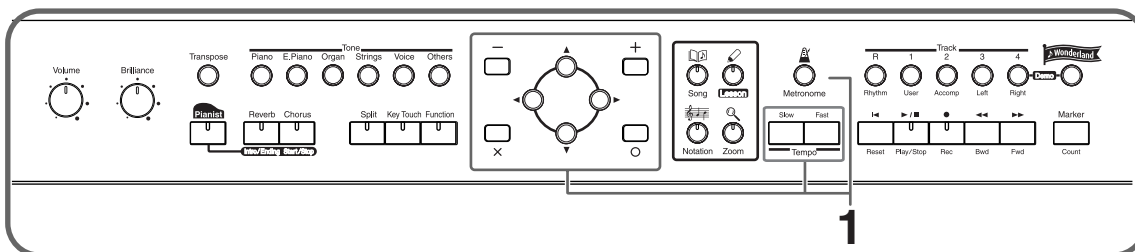

1 Press the [Metronome] button.

The button's indicator will blink according to the time signature (Beat), and the metronome will sound. To stop the metronome, press the [Metronome] button, getting its indicator to go dark.



Volume
Set the metronome volume.

Beat
Set the beat.

Sound
Specify the metronome sound.

Pattern
Specify the timing interval of the metronome's weak beats.

Beat LED
Set the metronome button's indicator on or off.

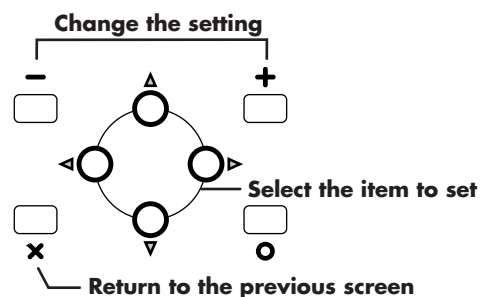

In this screen you can make the following settings.

Item	Setting
Volume	OFF (no sound)-10
Beat	2/2, 0/4, 2/4, 3/4, 4/4, 5/4, 6/4, 7/4, 3/8, 6/8, 9/8, 12/8 * It is not possible to change the "Beat" setting while a song is playing.
Sound	Click, Electronic, Voice (Japanese) ("1," "2," "3" in Japanese), Voice (English) ("1," "2," "3" in English), Animal, Wood Block, Triangle & Castanets, Hand Claps
Pattern	Normal, ♩ (dotted half note), ♪ (half note), ♪ (dotted quarter note), ♪ (quarter note), ♪ (dotted eighth note), ♪ (eighth note), ♪ (sixteenth note), Double (note added to back beat of the first beat), Triple (added notes sound the first beat as a triplet), Shuffle (notes added to create a shuffle)
Beat LED	On (The [Metronome] button's light flashes in time with the beat.), Off (Dark)

Adding a Count to Assist Your Timing

“Count-in” means to sound a count before song playback begins.

“Countdown” means to sound a count after the end of the song introduction (before you begin playing the keyboard).

If you will be playing along with a song, sounding a count will make it easier to match the timing of your performance to the song.

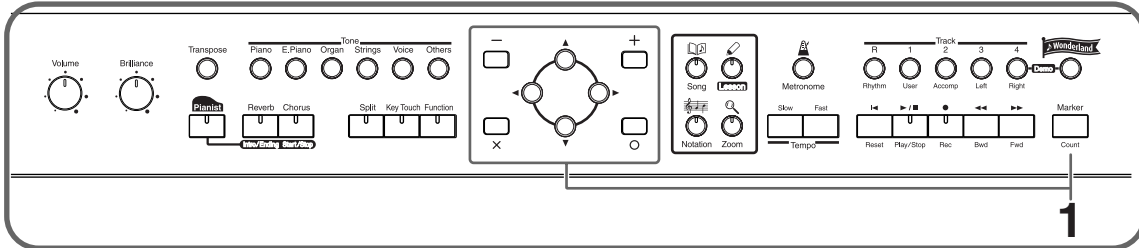

1 Press the [Marker/Count] button.

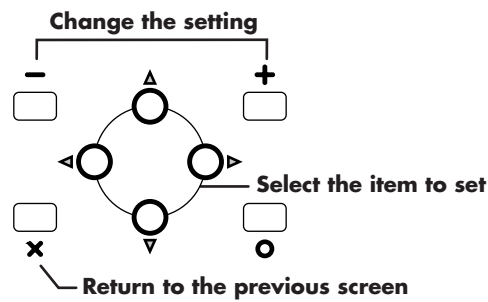
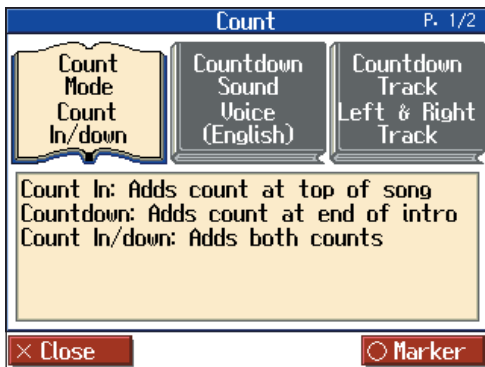

	Item	Setting
Count Mode	Specify what type of count will be added.	Count In (add a count before the performance), Countdown (add a count only before you begin playing), Count In/down (add both a count-in and a countdown)
Countdown Sound	Specify the count-down sound.	Voice (Japanese), Voice (English)
Countdown Track	Specify the track or part that will determine the beginning of the performance when adding a countdown.	Left & Right Track (Right-hand and left-hand parts of a piano song) Left Track (Left-hand part of a piano song) Right Track (Right-hand part of a piano song) Part 1-16
Count In Sound	Specify the count-in sound.	Stick, Click, Electronic, Voice (Japanese), Voice (English), Wood Block, Triangle & Castanets, Hand Clap, Animal
Count In Measure	Specify the length (number of measures) of the count-in.	1, 2
Count In Repeat	When “Repeat” is turned on in the Marker setting screen (p. 22), this specifies whether the count-in will sound each time the range between the markers is repeated, or only the first time.	First time, Each time

Assigning Markers to a Song for Repeated Practice

You can add markers within a song so that you can move to a marked measure, or play back repeatedly between two markers.

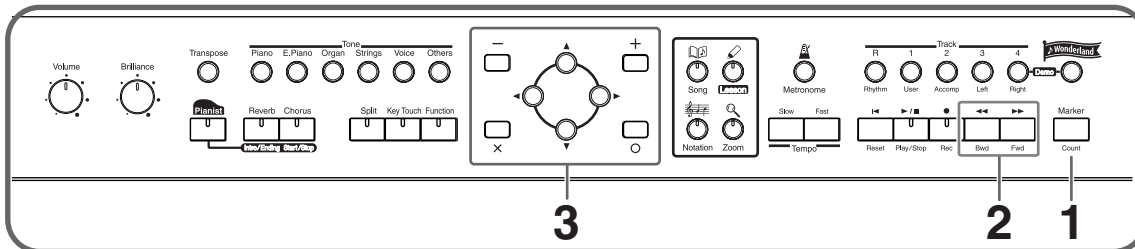

Before you begin, select the song in which you want to assign markers (p. 17).

Access the Marker screen

- 1 Press the [Marker/Count] button. In the Count screen, press the [O] button.

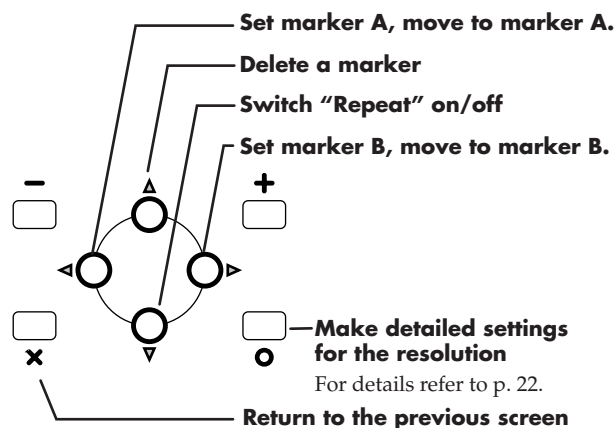
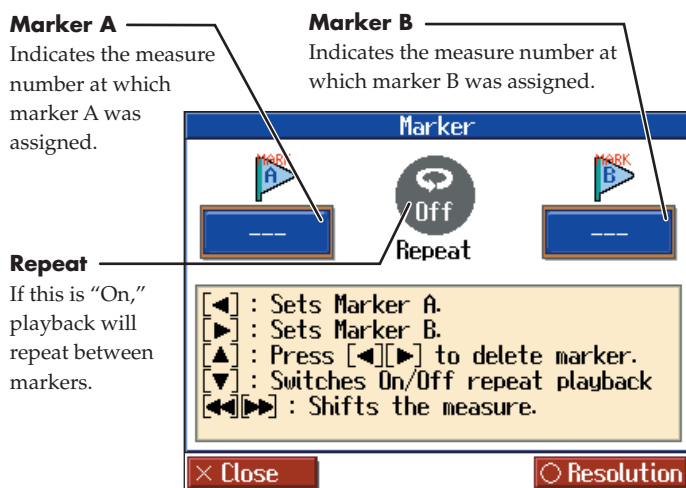

Move to the location at which you want to assign a marker.

- 2 Use the [◀◀(Bwd)] [▶▶(Fwd)] buttons to move to the measure at which you want to assign a marker.

Assign a marker

- 3 Press the [◀] or [▶] button to assign marker A or B.

The screen will indicate the number of the measure at which the marker was assigned.

It is not possible to assign marker B at the same location or earlier than marker A.

→ Markers can also be assigned in units of beats rather than measures. Refer to “Assigning a marker in the middle of a measure (Resolution)” (p. 23).

Moving an assigned marker

After assigning a marker in the song, you can hold down the [◀] button and press the [◀◀(Bwd)] or [▶▶(Fwd)] button to adjust the location at which marker A was assigned. To adjust the location of marker B, hold down the [▶] button and press the [◀◀(Bwd)] or [▶▶(Fwd)] button.

Moving to the location of an assigned marker

After assigning a marker in the song, press either the [◀] or [▶] buttons to move (jump) to the location of the marker.

Playing repeatedly between markers.

After assigning both markers A and B, press the [▼] button. In the screen, turn “Repeat” to “On.” When you press the [▶ / ■ (Play/Stop)] button, playback will repeat between the markers.

If you use Repeat Playback without assigning marker A or B

The entire selected song will be played back repeatedly.

If you use Repeat Playback when only marker A is assigned

The song will play back repeatedly from marker A to the end of the song.

If you use Repeat Playback when only marker B is assigned

The song will play back repeated from the beginning of the song to marker B.

- * If “Repeat” in the Marker screen is turned “On,” you can press the [✕] button to display the Notation screen and play back repeatedly.
Anything you want to do that involves markers, including moving to a particular marker, is accomplished within the Marker screen.

Deleting a marker you’ve assigned

Hold down the [▲] button, and press the [◀] button to delete marker A, or press the [▶] button to delete marker B.

Assigning a marker in the middle of a measure (Resolution)

A marker can be assigned in the middle (at the beginning of a beat) of a measure.

1 Press the [Marker/Count] button. In the Count screen, press the [○ (Marker)] button.

The screen for setting markers appears.

2 Press the [○ (Resolution)] button once more to access the Resolution setting screen.

item	Setting	
Resolution	Measure	Markers will be assigned to the beginning of a measure.
	Beat	Markers will be assigned to the beginning of a beat. → If you want to assign a marker to the beginning of a beat, assign the marker while playing back the song.

Changing the Key of the Keyboard or Song Playback (Transpose)

By using the “Transpose” function, you can transpose your performance without changing the notes you play. For example, if a song is in a difficult key with numerous sharps (♯) or flats (♭), you can use this function to play it in an easier key.

You can also use this function to play back a song in a different key.

When accompanying a vocalist, you can easily transpose the key to a range that is comfortable for the singer, while still playing the notes as written (i.e., with the same fingering positions).

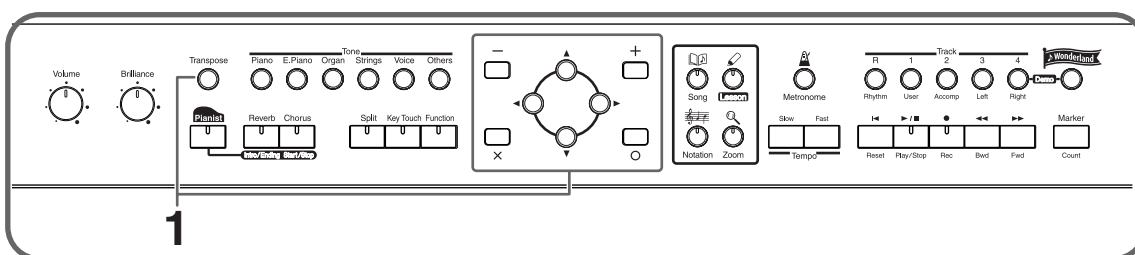

1 Press the [Transpose] button.

For example, if you want the E pitch to sound when you press the C key, set the “Keyboard” transpose setting to “4.”

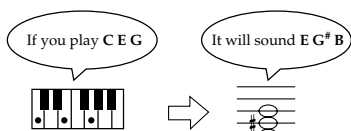

Link
Setting this to “Off” allows you to set values separately for the keyboard and the song data.

Transpose

Keyboard
0

On
Link

Song
0

This transposes the keyboard and song data. Specify the number of semitones you wish. To assign separate values for the keyboard and song data, turn off the link between them.

× Close
○ Link Off

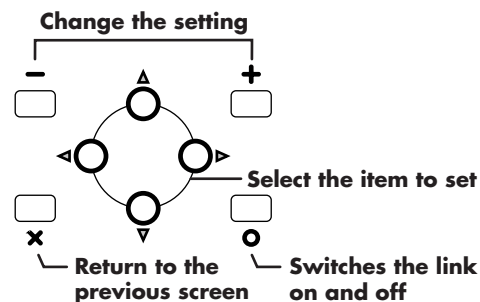

Item		Setting
Keyboard	Transpose the keys played by the keyboard. This setting can be set by holding down the [Transpose] button and pressing the key to which you want to transpose.	-6-0-5
Song	Transpose the song playback.	-24-0-24

When you transpose the keyboard, the [Transpose] button’s indicator will light. If the transpose setting is “0,” the button’s indicator will be dark.

When set to “Link On,” the values for the keyboard and the song data are the same.

When set to “Link Off,” the values for the keyboard and the song data can be set separately. To cancel transposition, press the [Transpose] button, getting its indicator to go dark.

The transposition setting returns to “0”, when you choose another song.

Adjusting the Keyboard Touch (Key Touch)

You can adjust the touch (playing feel) of the keyboard.

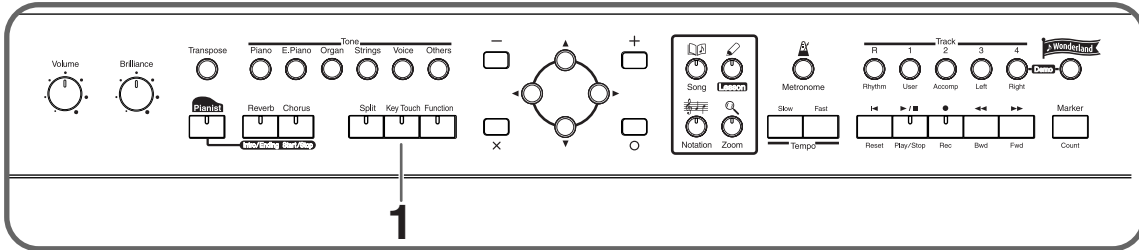

1 Press the [Key Touch] button.

Key Touch
Key Touch
Press to switch the setting.

Key Touch

Key Touch

Medium

Medium: No Light
You can play with the most natural touch. This is the touch closest to that of an acoustic piano.

Close

Change the setting

Return to the previous screen

Item	Indicator		Setting
Key Touch	No Light	Medium	This allows you to play using the most natural touch. This setting is closest to the response of an acoustic piano.
	Red Light	Heavy	Fortissimo (ff) cannot be produced unless you play more strongly than usual, making the keyboard feel heavier. This setting allows you to add more expression when playing dynamically.
	Green Light	Light	Fortissimo (ff) can be produced by playing less strongly than usual, making the keyboard feel lighter. This setting makes it easier for children, whose hands have less strength.
	Orange Light	Fixed	Sounds at a fixed volume, regardless of your keyboard playing strength.

Adding Variety to Your Performances

Selecting the Sound to Play

The HPi-7 contains 600 and more different tones.

The tones are organized into six tone groups, which are assigned to the [Tone] buttons.

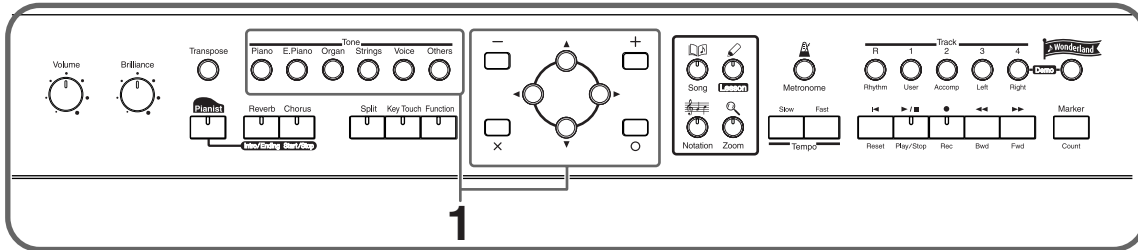

1 Press one of the [Tone] buttons, and select the desired tone in the screen.

When you press a [Tone] button, the button's indicator will light.

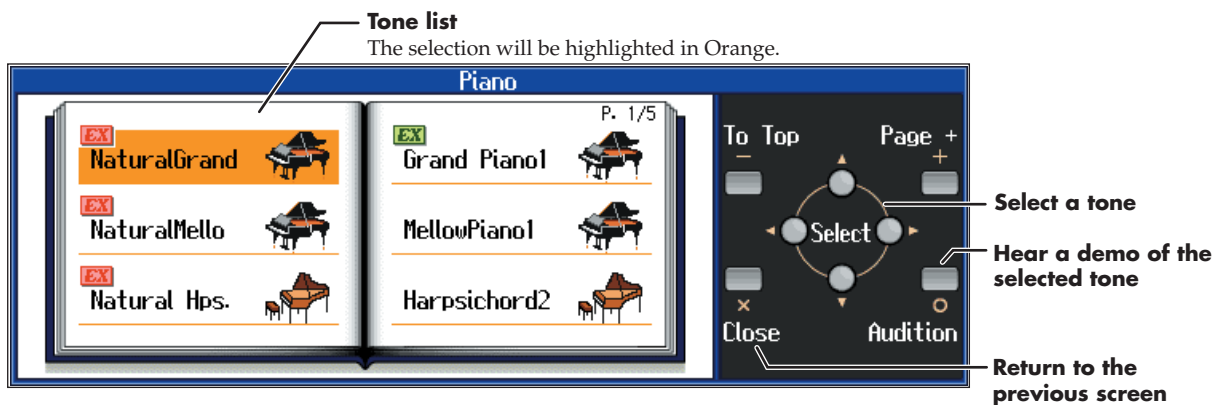

The next time you press this [Tone] button, the tone you finalized here will be heard.

→ "Tone List" (p. 67)

Tones indicated by **EX** is called an "EX voice." These voices are especially recommended.

Tones indicated by a red **EX** mark produce the "Key Off Sound."

What "Key Off Sound" does is recreate the tonal changes produced when the fingers are released from the keys.

Playing percussion instruments or sound effects

Press the Tone [Others] button.

Use the cursor buttons to select a rhythm set such as "DR Standard" or SFX set.

Drum set names are indicated by initial "DR."

Each note of the keyboard will play a different sound.

→ For the sounds that are assigned to each key of a drum set or sound effect set, refer to "Drum Set List" (p. 70).

Applying Effects to the Sound

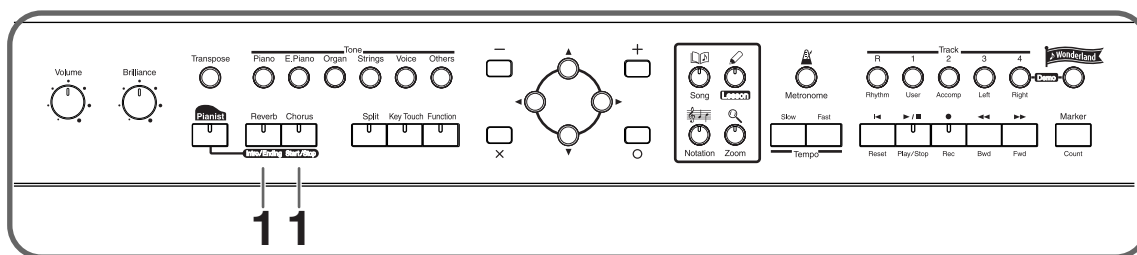

Adding reverberation to the sound (Reverb)

By applying the reverb effect you can produce a pleasant reverberation, making it sound as though you were performing in a concert hall.

1 Press the [Reverb] button.

The button's indicator will light, and a reverb effect will be applied to the sound.

To cancel the reverb effect, press the [Reverb] button, getting its indicator to go dark.

* It is not possible to memorize the reverb effect setting for each sound.

Adding richness to the sound (Chorus)

By applying the chorus effect you can make the sound richer and more spacious.

1 Press the [Chorus] button.

The button's indicator will light, and a chorus effect will be applied to the sound.

To cancel the chorus effect, press the [Chorus] button, getting its indicator to go dark.

* The chorus setting can be memorized for each sound. Turning off the power restores the original settings.

→ The depth of the reverb effect and chorus effect can be adjusted. Refer to "Adjusting the depth of the effects (Effect)" (p. 55).

Playing Two Sounds Layered Together (Dual)

Simultaneously playing two sounds when one key is pressed is called "dual performance."

1 Simultaneously press two of the [Tone] buttons.

Both of the button indicators will light. Of the two buttons, the sound of the left button will be "Tone 1," and the sound of the right button will be "Tone 2."

Adding Variety to Your Performances

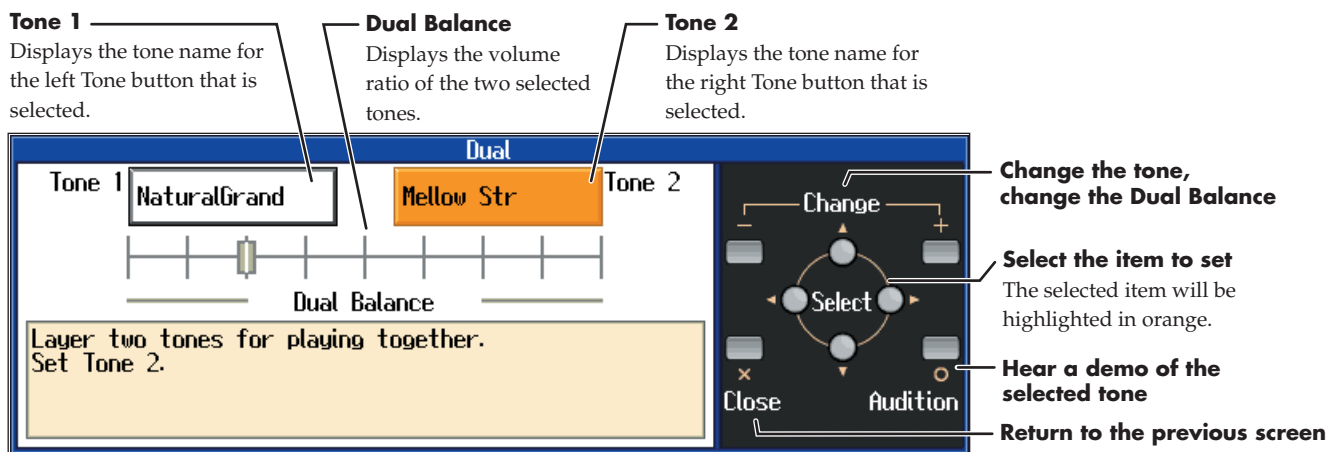

When the tone names of "Tone 1" or "Tone 2" are highlighted, you can press the [+] or [-] button to select tones within the same tone group (p. 26).
To cancel dual performance, press any [Tone] button.

Playing Different Sounds in the Right and Left Hand (Split)

Dividing the keyboard into right-hand and left-hand areas, then playing different sounds in each is called "split performance." The boundary key is called the "split point."

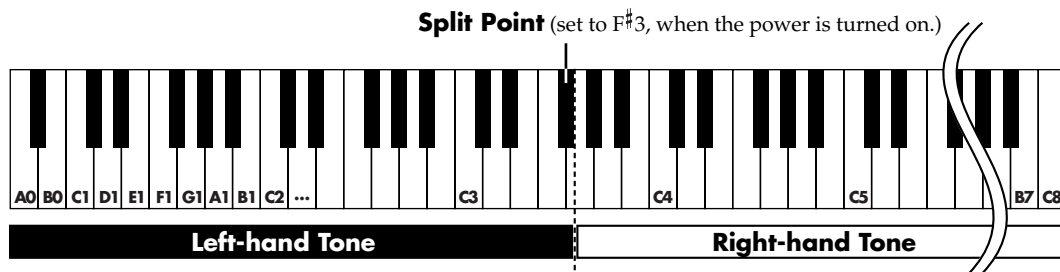

* The split point key is included in the left-hand keyboard area.

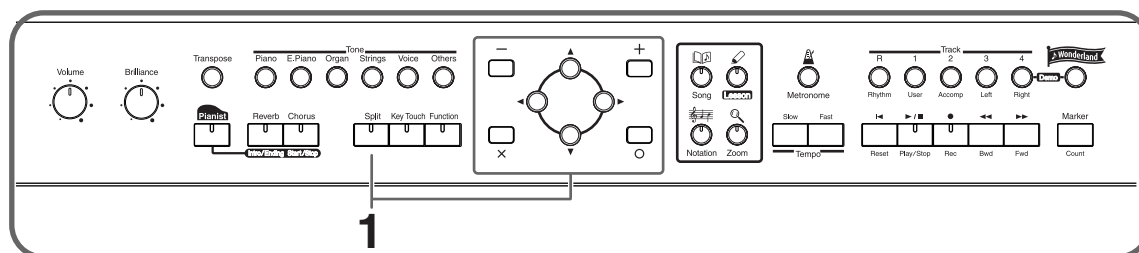

1 Press the [Split] button.

The button's indicator will light.
The tone on the right will be the "Right-hand Tone," and the tone on the left will be the "Left-hand Tone."

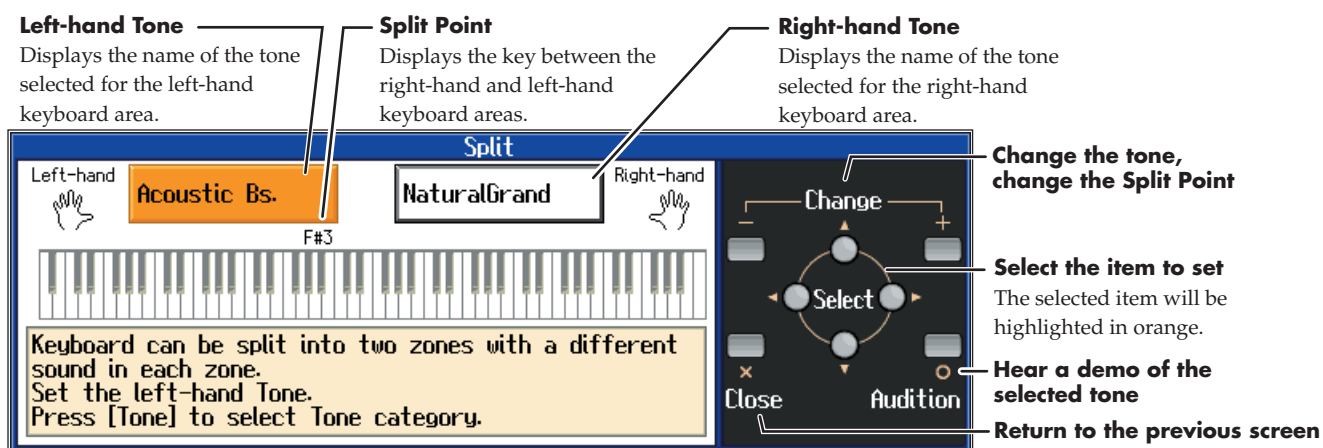

When the “Right-hand Tone” or “Left-hand Tone” are highlighted, you can use the [Tone] buttons and the [+] or [-] button to select tones.

When the “Split Point” is selected, you can press the [+] or [-] button to change the split point.

The split point can also be set by holding down the [Split] button and pressing the key for the desired split point.

To cancel split performance, press the [Split] button, getting its indicator to go dark.

Changing from dual performance to split performance

By changing from dual performance to split performance, you can divide the keyboard into right-hand and left-hand areas, and layer two tones in the right-hand area.

1 When using Dual performance, press the [Split] button.

The [Split] button’s indicator will light.

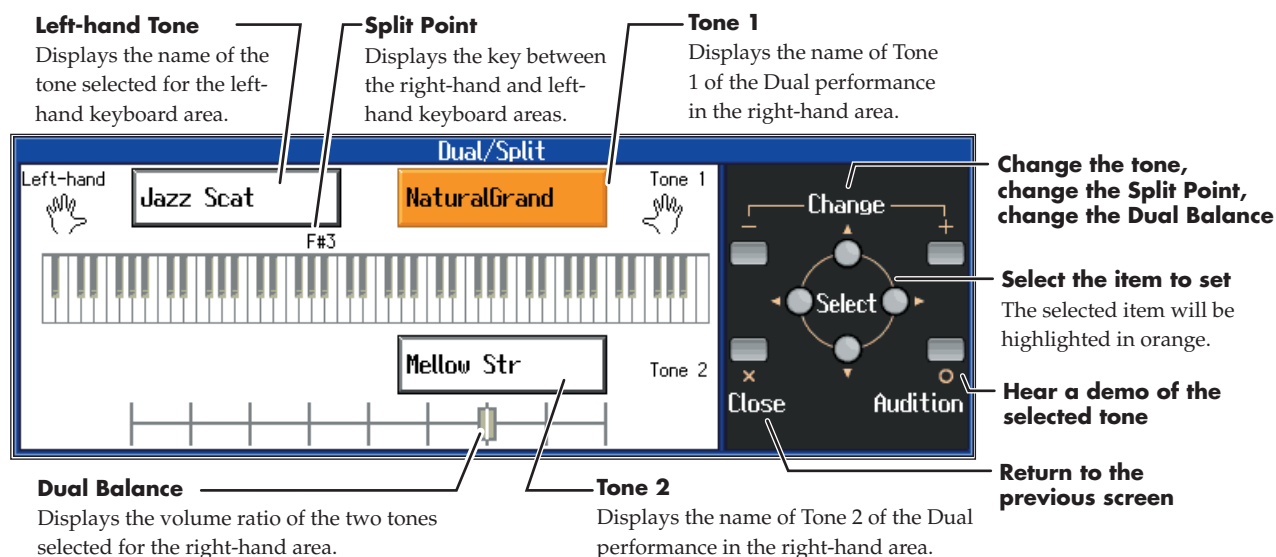

To switch from split to dual performance

1 When using split performance (p. 28), highlight the “Right-hand Tone.”

2 Simultaneously press the two [Tone] buttons that you want to layer.

Using the Lesson Function (Visual Lesson)

You can enjoy your practices with the HPi-7's Lesson function.

Play along with the accompaniment, and a notation indicating how well you have performed appears in the display.

You can select the level and practice songs to match your current abilities. You can also supplement your stock of practice songs with additional music data.

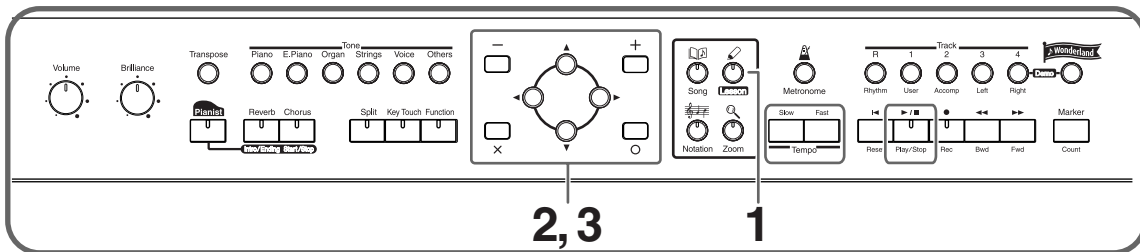

At this point, pressing [O] advances you to the next screen, and pressing [X] returns the previous screen to the display.

1 Press the [Lesson] button.

A screen like the following will appear.

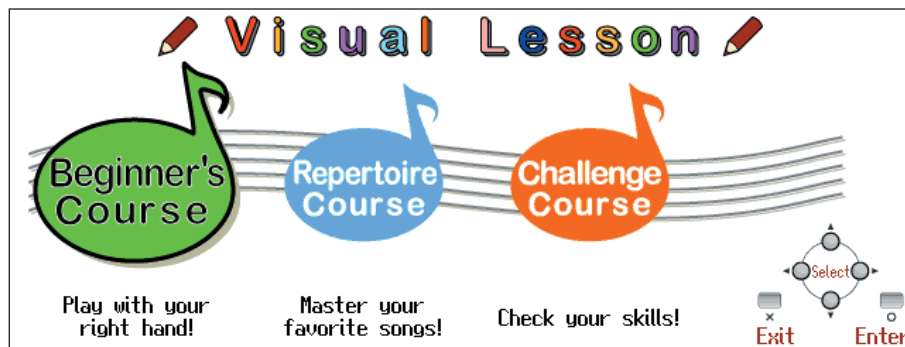

2 Press the [◀] or [▶] button to select a course, then press the [O (Enter)] button.



3 Select a practice song, then press the [O (Next)] button.

Using the Lesson Function (Visual Lesson)

A screen like the one below appears when you select the "Repertoire" course.

Part
This selects the part to be practiced.
setting: Both Hands, Left Hands, Right Hands

Tempo
This sets the tempo for your practice.
setting: Original Tempo, A Little Slower, Slower, Much Slower

Start Measure
This sets the starting measure.

End Measure
This sets the ending measure.

The screen displays: "How do you want to practice? When you've decided, press [O]."
Part: Both Hands
Tempo: Original Tempo
Start Measure: 1
End Measure: 21
A "Select" button is in the center, with "Change" above it and "Prev" and "Next" below it.

Set the tempo and the part you want to practice, then press the [O (Next)] button.

4 Play along with the accompaniment.

When you have finished playing, your score appears in the display.

Press the [O (Review)] button to display the results of your performance in the notation.

Beginner's J=109 Mary Had A Little L M: 3 Song Practice Check Review

Ref. [Musical notation]

You. [Musical notation]

[Piano keyboard]

Rhythm (Light Blue)
The timing of the accent was off.

Sound (Red)
The pitch was incorrect.

? (Green)
A note not in the score was played.

One note [Musical notation]

Stop [Button]

Practicing with Internal Songs and Songs on Floppy Disks

1 Select "Preset/Disk Song" in the practice song select screen, then press the [O (Next)] button.

The song select screen (p. 17) appears.

2 Select a practice song, then press the [O (Enter)] button.

If you have selected the "Repertoire" course, set the tempo and the part you want to practice, then press the [O (Next)] button.

3 Play along with the accompaniment.

When you have finished playing, your score appears in the display.

Press the [O (Review)] button to display the results of your performance in the notation.

Adding an Accompaniment to Your Performance (Pianist Function)

The Pianist function automatically adds a suitable accompaniment to your piano performance. You can choose one of 35 different accompaniment styles as suitable for the song that you want to play. You can specify the accompaniment chord in the left-hand keyboard area, or press a single button to play an intro or ending.

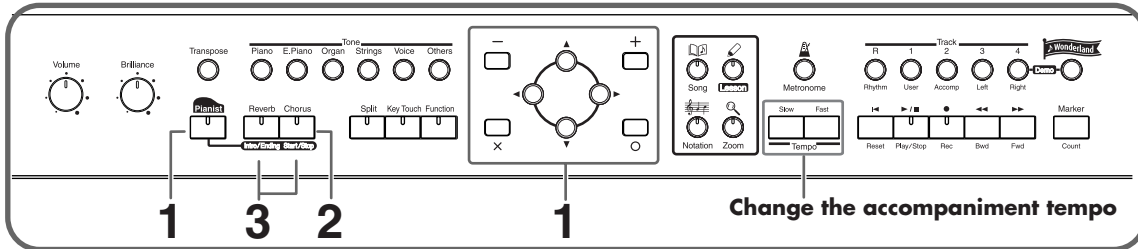

→ “Pianist Style List” (p. 76)

→ “Chord List” (p. 74)

1 Press the [Pianist] button to access the Style Select screen, and select an accompaniment style.

The [Pianist] button’s indicator will light, and the [Intro/Ending] button’s indicator will blink. The keyboard will be divided at the Split Point (p. 28) into right-hand and left-hand areas.



Style list

The selection will be highlighted in orange.

Chord

Starting the accompaniment

2 Either press the [Start/Stop] button, or play a chord in the left-hand keyboard area.

The accompaniment will begin with an intro.

If you do not want to add an intro, press the [Intro/Ending] button so its indicator goes dark, then perform step 2.

In the left-hand keyboard area, specify the accompaniment chord. Play freely in the right-hand keyboard area.

You can press the [O (Chord Finder)] button to display the “Chord Fingering List.”

Stopping the accompaniment

3 Press the [Intro/Ending] button or the [Start/Stop] button.

If you press the [Intro/Ending] button, the accompaniment will stop after an ending. If you press the [Start/Stop] button, the accompaniment will stop immediately.

To cancel the Pianist function, press the [Pianist] button, getting its indicator to go dark.

* When using the Pianist function, you cannot select and play a sound in the left-hand keyboard area.

* You can change the split point by holding down the [Split] button and pressing a key (p. 29).

→ You can change the volume balance between the keyboard playing and the accompaniment. Refer to “Adjusting the volume balance between accompaniment and keyboard (Balance)” (p. 55).

* The accompaniment data produced by the Pianist function will not be output from the MIDI Out connector.

Playing in a Wonderland of Sound

“Wonderland” allows children to experience a variety of sounds and onboard songs with easy operation and enjoyable animation.

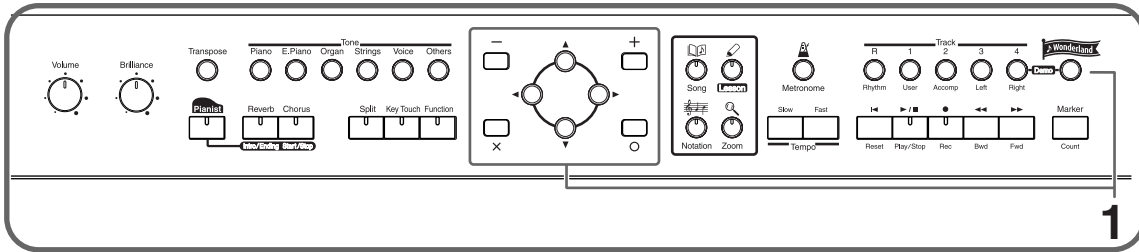

1 Press the [Wonderland] button, and select the desired item in the screen.

After the opening screen is displayed, a screen like the following will appear.

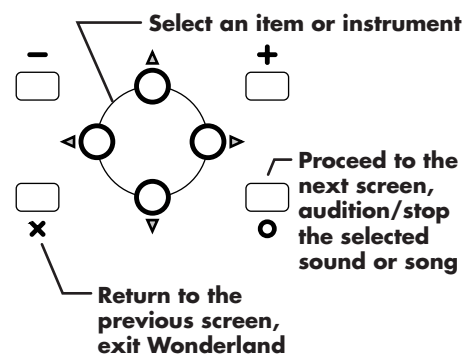
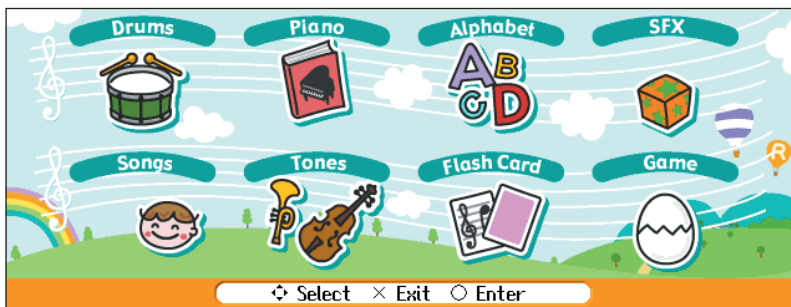

Explanation of each selection

Item	Content
Drums	Select a picture of a percussion instrument to hear the sound of that instrument. Play the keyboard to play the selected percussion instrument.
Piano	Learn about how pianos are made.
Alphabet	Use the keyboard to become familiar with the alphabet.
SFX	Listen to a wide variety of sound effects.
Songs	Listen to the onboard songs.
Tones	Select a picture of an instrument to hear the sound of that instrument. Play the keyboard to play the selected instrument.
Flash Card	In this game, you play the notes shown on the cards.
Game	In this game, you try to name the scales, chords, and rhythms that you hear.

To exit Wonderland, press the [X] button several times, or press the [Wonderland] button, getting its indicator to go dark.

→ When using the Wonderland function, you can use the [Reverb] button and [Chorus] button to apply effects to the sound (p. 27).

However, buttons other than the buttons used in step 1 above, and the [Reverb], [Chorus], and [Key Touch] buttons will not be operable.

Recording Your Performance

The HPi-7 lets you record your own performances.

A recorded performance can be played back to hear your own playing, or to add additional parts. The following types of recording can be done using the HPi-7.

- Record along with an internal song or disk song (→ “Recording Along with a Song”)
- Recording just your own keyboard performance (→ “Recording a New Song” (p. 36))
- Re-recording (p. 38)
- Using the Pianist function to record (→ “Recording with an accompaniment (the Pianist function)” (p. 39))
- Multitrack recording on five tracks (p. 40)

* Songs you record are discarded as soon as you select another song, or turn off the power of the HPi-7. Be sure to save important performances on a floppy disk. Refer to “Saving Songs” (p. 42).

Recording Along with a Song

You can record a performance that you play along with an internal song or disk song.

Here we will explain how you can listen to the accompaniment for an internal song while recording your right-hand performance.

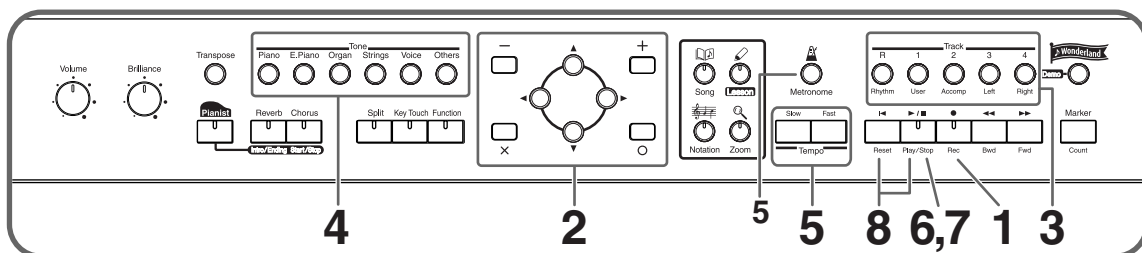

Before you record, first select a song, and press the [X] button to display the Notation screen.

Refer to p. 17 for details on how to select an internal song, or to p. 46 for how to select a disk song.

Make recording settings

1 Press the [●(Rec)] button.

* While the measure number is highlighted, the notation screen is being generated. When the highlighted number returns to normal, please try the operation again.



2 Use the [◀][▶] button to choose “Add On,” then press the [○(Execute)] button.

With this setting, you can record while listening to the selected song.

Press a track button
to select a recording track.

Select the track that you want to record

3 Press the track button for the track that you want to record (i.e., the track that you want to play yourself).

The indicator of the button you pressed will blink, and the HPi-7 enters recording-standby mode. Since in this example we will record the right-hand performance, press the [4/Right] button to make the button's indicator blink.

* Only the sounds of a drum set or SFX set can be recorded in the [R/Rhythm] button.

Select the tone that will be recorded

4 Use the [Tone] buttons to select the tone that you want to record.

After selecting the Tone, press the [X(close)] button to display the Notation screen.

Set the tempo

5 Use the [Tempo] buttons to set the recording tempo.

* You can also record using the metronome. In this case, the sound of the metronome will not be recorded.

Start recording

6 Press the [▶/■ (Play/Stop)] button.

After a two-measure count, recording will begin.

Note that recording will also begin as soon as you play anything on the keyboard, even if you do not press the [▶/■ (Play/Stop)] button. In this case, no count will be heard.

When recording begins, the [▶/■ (Play/Stop)] button and the [●(Rec)] button indicators will light. Go ahead and perform on the keyboard.

Stop recording

7 Press the [▶/■ (Play/Stop)] button.

Recording will stop, and the [▶/■ (Play/Stop)] button and the [●(Rec)] button indicators will go out.

Play back the recorded performance

8 Press the [◀(Reset)] button, and then press the [▶/■ (Play/Stop)] button.

You will hear the recorded performance.

To stop the playback, press the [▶/■ (Play/Stop)] button once again.

Recording a New Song

Here's how to record your own keyboard performance without using an internal song.

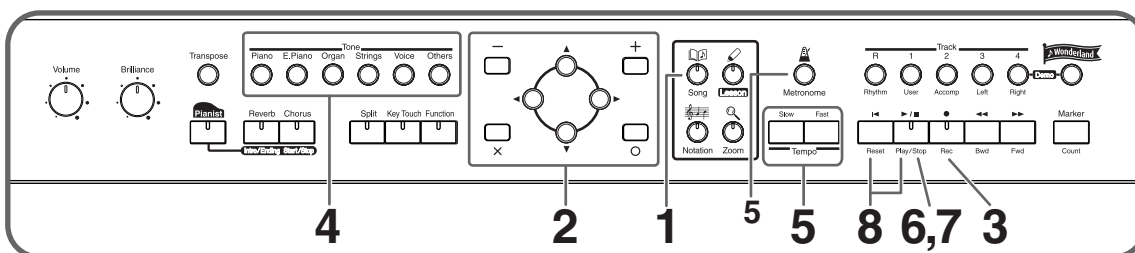

Make recording settings (choose "New Song")

- 1 Press the [Song] button.

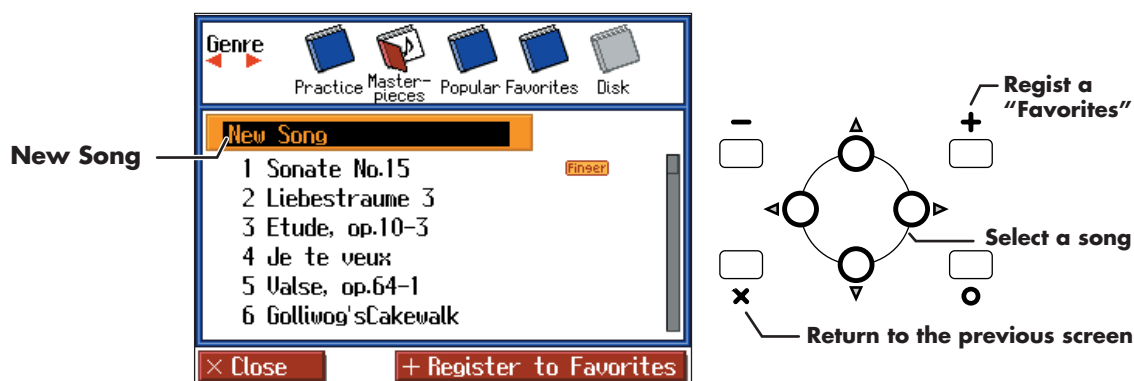

- 2 Press the [▲] button to return to the first song, then press the [▲] button once more to select "New Song."

When you press any of the [◀][▲][▶][▼] buttons while a song in the HPi-7's current (the internal memory) is selected, the display will ask "Delete the selected song. OK?" (p. 18). When you delete the song, the "0: New Song" is displayed.

The notation will appear when you press the [Notation] button.

- 3 Press the [●(Rec)] button.

The indicators of all Track buttons will blink, and the HPi-7 enters recording-standby mode.

- * If the display indicates "Close/ New Song/ Add On," select "New Song." In this case, steps 1-2 will be omitted.
- * Be aware that if you select "New Song," the currently selected song will disappear.

Select the tone that will be recorded

- 4 Use the [Tone] buttons to select the tone that you want to use for recording.

After selecting the Tone, press the [X] button to display the Notation screen.

- 5 Use the [Tempo] buttons to set the recording tempo.

If you want to change the time signature (beat) of the song, press the [Metronome] button and make settings in the Metronome screen.

After setting the tempo, press the [X] button to display the Notation screen.

- * You can use the metronome while recording. In this case, the metronome sound will not be recorded.

Start recording

6 Press the [▶ / ■ (Play/Stop)] button.

After a two-measure count, recording will begin.

Note that recording will also begin as soon as you play anything on the keyboard, even if you do not press the [▶ / ■ (Play/Stop)] button. In this case, no count will be heard.

Once recording begins, the [▶ / ■ (Play/Stop)] button and the [● (Rec)] button indicators will light. Go ahead and perform on the keyboard.

Stop recording

7 Press the [▶ / ■ (Play/Stop)] button.

Recording will stop, and the [▶ / ■ (Play/Stop)] button and the [● (Rec)] button indicators will go out.

The recorded performance will be recorded on the [1/User] button.

Play back the recorded performance

8 Press the [◀ (Reset)] button, and then press the [▶ / ■ (Play/Stop)] button.

You will hear the recorded performance.

To stop the playback, press the [▶ / ■ (Play/Stop)] button once gain.

Track button assignments for the recorded performance

When you record only a keyboard performance, the performance will be assigned to the track buttons as follows.

- **Normal performance (playing a single sound from the entire keyboard)**

The performance is recorded to the [1/User] button.

- **Dual performance**

The performance is recorded to the [1/User] button.

- **Split performance**

The left-hand performance is recorded to the [3/Left] button, and the right-hand performance to the [4/Right] button.

- **Dual performance and Split performance**

The left-hand performance is recorded to the [3/Left] button, and the right-hand dual performance to the [4/Right] button.

- **Drum set or sound effect performance**

The performance is recorded to the [R/Rhythm] button.

Re-recording

When you want to re-record, specify the track button whose performance you want to re-record, and then record again.

When you select a previously recorded track button and re-record, the performance from the location at which you begin recording up to the location at which you stop recording will be replaced by the newly re-recorded performance.

* The tempo of the song is stored within the song that was selected. You can slow down the tempo for recording, but when you play back the performance it will play back at the original tempo.

1 Use the [◀◀(Bwd)] or [▶▶(Fwd)] button to move to the measure that you want to re-record.

2 Press the [●(Rec)] button.



3 Choose "Add On."

With this setting, you can record while listening to the selected song.

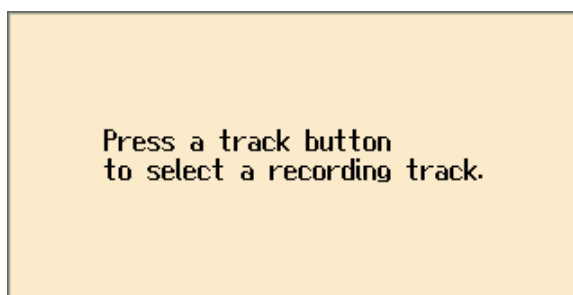

4 Press the track button for the track that you want to re-record.

The indicators of the button you pressed and of the [▶ / ■ (Play/Stop)] button will blink, and the HPi-7 enters recording-standby mode.

5 Press the [▶ / ■ (Play/Stop)] button to start recording.

After a two-measure count, recording will begin.

When recording begins, the [▶ / ■ (Play/Stop)] button and [●(Rec)] button indicators will light. Go ahead and perform on the keyboard.

6 Press the [▶ / ■ (Play/Stop)] button to stop recording.

The [▶ / ■ (Play/Stop)] button and the [●(Rec)] button indicators will go out.

Erasing a Recorded Song

A recorded song can be erased in the following two ways:

- 1 After recording a song, press the [Song] button and select another song in the song-select screen.
- 2 Hold down the [Song] button and press the [● (Rec)] button.

When either of these operations are performed, a display like the following will appear.



If you select "OK," the song will be deleted.

If you do not want to erase the song, save it on a floppy disk or Favorite (p. 42).

Other Recording Methods

Recording with an accompaniment (the Pianist function)

You can use the Pianist function to record while adding an accompaniment.

→ For details on the Pianist function, refer to "Adding an Accompaniment to Your Performance (Pianist Function)" (p. 32).

- 1 As described in steps 1 and 2 of "Recording a New Song" (p. 36), select "New Song."
- 2 Press the [● (Rec)] button.
The indicators of all Track buttons will blink, and the HPi-7 enters recording-standby mode.
- 3 Press the [Pianist] button and select the desired accompaniment style.
Adjust the tempo as necessary.
- 4 Recording will begin at the moment you either press the [Start/Stop] button or begin playing in the left-hand keyboard area.
If you press the [▶ / ■ (Play/Stop)] button, the accompaniment will begin with an intro after a two-measure count, and recording will begin simultaneously.
- 5 When you press either the [Intro/Ending] or [Start/Stop] button to stop the accompaniment, recording will also stop simultaneously.
You can also press the [▶ / ■ (Play/Stop)] button to stop recording even in the middle of the accompaniment.
The right-hand performance will be recorded on the [4/Right] track, the accompaniment drum sounds will be recorded on the [R/Rhythm] track, and the non-drum accompaniment sounds will be recorded on the [2/Accomp] track.

Recording Your Performance

- * If you want to re-record only your own performance after using the Pianist function to record, you must turn off the Pianist function before you record. If you fail to turn off the Pianist function, the Pianist accompaniment will be added to the previously recorded accompaniment.
- * If you want to re-record the accompaniment of the Pianist function, select the [2/Acomp] track or the [R/Rhythm] track, and re-record.

Multitrack recording on five tracks

Multitrack recording is a method by which you can record additional tracks while listening to the previously recorded tracks.

The HPi-7 provides five tracks, so you can record different sounds on each track to create an ensemble song.

→ You can also record on 16 tracks (p. 58).

Record the first track

1 Record your performance as described in “Recording a New Song” (p. 36).

- * The song tempo will be remembered as the tempo at which you recorded the first track.

Record the second and subsequent tracks

2 Select and record additional tracks one at a time as described in “Re-recording” (p. 38).

For the second and subsequent recordings, you can listen to the previously recorded performances while you record.

Record additional tracks as desired to complete the song.

- * Only drum set or SFX set sounds can be recorded in the [R/Rhythm] button.

The five track buttons and 16 parts

Many songs in commercially available SMF music files consist of 16 parts. The 16 parts are divided among the five track buttons.

The track buttons and the 16 parts correspond as follows.

Track button	Part
[R/Rhythm]	10 (D), 11 (S)
[1/User]	1
[2/Acomp]	2, 5-9, 12-16
[3/Left]	3
[4/Right]	4

Saving Your Performance

The performance data you record on the HPi-7 will be lost when you select another song or turn off the power of the HPi-7. If you want to keep important performance data, you must save it to floppy disks or Favorites.

→ If you will be using a disk drive for the first time, please be sure to read “Before Using Floppy Disks” (p. 6).

Using Floppy Disks

Inserting/removing a floppy disk

Inserting a floppy disk

- 1 With the label of the floppy disk facing upward, insert it into the disk drive until it clicks into place.

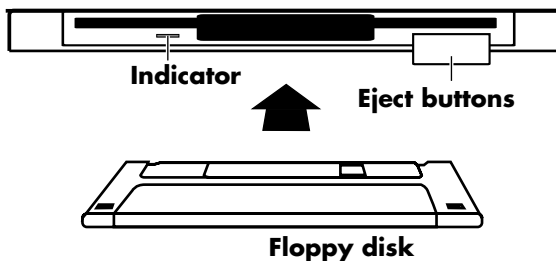

Removing a floppy disk

- 1 Press the eject button.

The floppy disk will protrude from the disk drive. Grasp the edge of the floppy disk and gently pull it out.

- * Don't try to eject the disk while reading or writing is in progress. Attempting to do so may damage the magnetic surface of the disk, rendering it unusable. (The indicator light for the disk drive lights up at full brightness when reading or writing data. Ordinarily, the indicator will be less brightly lit, or be extinguished.)

Formatting a floppy disk

A newly purchased floppy disk, or a floppy disk that has been used by another device cannot be used as is. Such floppy disks must be “formatted” for use with the HPi-7.

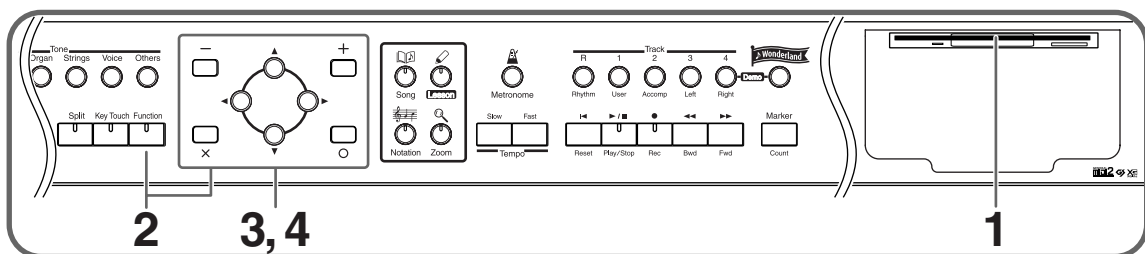

Saving Your Performance

First make sure that the protect tab of the floppy disk is in the “Write (write enable)” position.

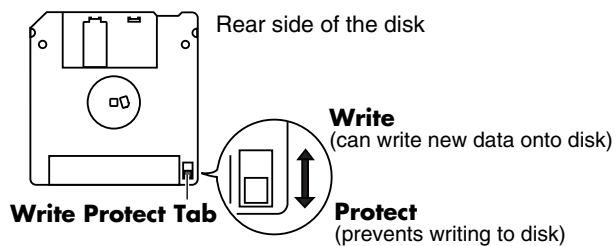

- 1** Insert the floppy disk into the disk drive.
- 2** Press the [Function] button, and select “File” in the screen, and press the [O (Enter)] button.
- 3** Use the [◀] [▶] buttons to select “Format,” and press the [O (Enter)] button.



- 4** Use the [◀] [▶] buttons to select “OK”, then press the [O (Execute)] button.

* Do not remove the floppy disk from the disk drive until formatting is complete.

Saving Songs

When saving to floppy disks, first make sure that the protect tab of the floppy disk is in the “Write (write enable)” position, then insert the floppy disk in the disk drive.

- 1** Press the [Function] button, and select “File” in the screen, and press the [O (Enter)] button.
- 2** Use the [◀] [▶] buttons to select “Save,” and press the [O (Enter)] button.



3 Select the destination and the format in which to save.

Item	Value	Explanation
Save Format	i-Format	The song will be saved in i-format. A song saved in i-format can be listened to on Roland digital pianos (such as those from the HP-G/R/i and KR series), and on units from the MT series.
	SMF	The song will be saved in SMF (Standard MIDI File) format. A song saved in SMF format can be played on the many devices that are able to play back SMF music files (p. 77).
Destination	Disk	Saves the song to the Floppy Disk.
	Favorite	Saves the song to the Favorites.

* You cannot save recorded songs that use copyrighted music files in SMF format.

4 Specify the song name and the save-destination song number.

Song name
Displays the name of the song to save.
Characters that can be input:
ABCDEFGHIJKLMNOPQRSTUVWXYZ
[] ^ _ ` abcdefghijklmnopqrstuvwxyz { } ~
Space ! " # \$ % & ' () * + - / 0 1 2 3 4 5 6 7 8 9 ; : < = > ? @

Change the character, change the song number
When the cursor is located at the song name item, change the character at the cursor location. When the save-destination item is highlighted in white, change the save-destination song number.

Save Destination
Displays the save-destination song number. If you select a song number that displays a song name, and save a new song, the previous song will be erased.

Move the cursor, select an item to set

Finalize the setting and proceed to the next screen

Return to the previous screen

File -> Save

Song Name
Sonata No. 15

Save Destination
2:

Save the song under a new name. If song name appears in save dest. column, song has been saved already. After song name and save destination are determined, press ○.

Change

Select

Prev

Execute

5 Follow the on-screen directions to begin saving the data.

The time required for saving will range from several seconds to half a minute or more.

* Never remove the floppy disk from the disk drive until saving is complete.

Some notes on saving a song

- Due to certain types of handling, the data on a floppy disk can be damaged and become unplayable. We recommend that important song data be saved on two floppy disks.
- When a song is played back on some other devices, notes may drop out or may be played differently.
- When you are finished saving, set the protect tab of the floppy disk to the “protect” position (p. 42). This will prevent the song from being accidentally erased.

Deleting Saved Songs

Here’s how to erase a song that was saved on a floppy disk, or to Favorites.

To delete a song on a floppy disk, first make sure that the protect tab of the floppy disk is in the “write

Saving Your Performance

(write enable)" position (p. 42), then insert the floppy disk in the disk drive.

- 1** Press the [Function] button, and select "File" in the screen, and press the [O (Enter)] button.
- 2** Use [◀] [▶] to select "Delete," and press the [O (Enter)] button.

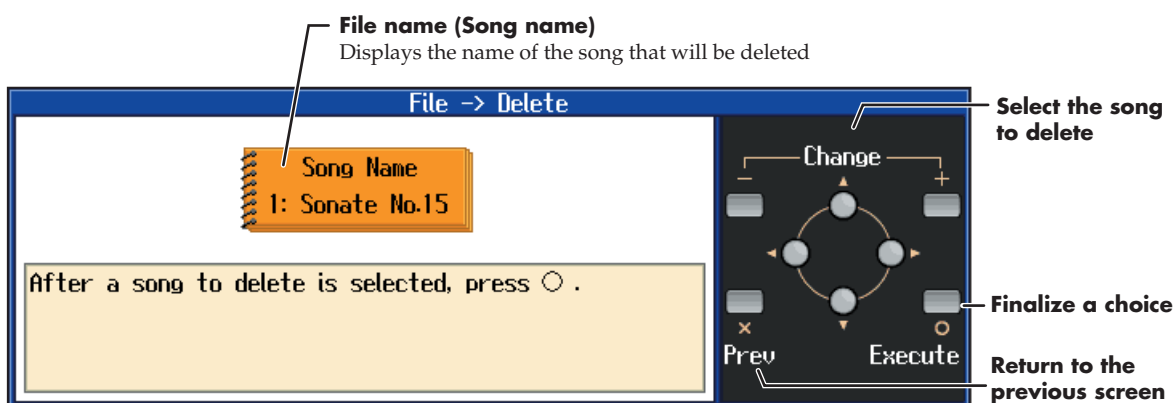
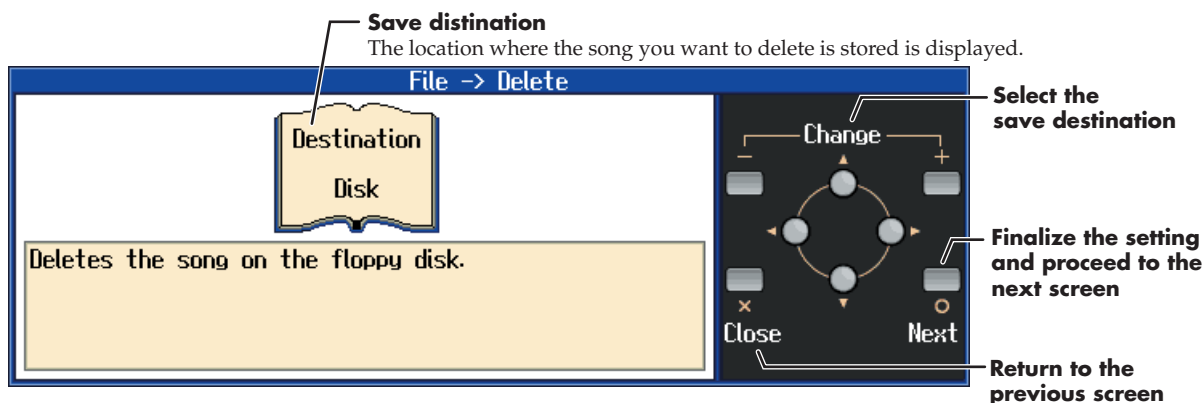

- 3** Select the save destination and the file, then press the [O (Execute)] button.

* Do not remove the floppy disk from the disk drive until deleting is complete.

Copying Songs

You can take songs saved on floppy disks and copy them to Favorites and vice versa.

- 1** Insert the floppy disk with the song to be copied in the disk drive.
- 2** Press the [Function] button, and select "File" in the screen, and press the [O (Enter)] button.
- 3** Use [◀] [▶] to select "Copy," and press the [O (Enter)] button.



4 Select the copy type, and press the [O (Enter)] button.

The following "Copy Song screen" appears.

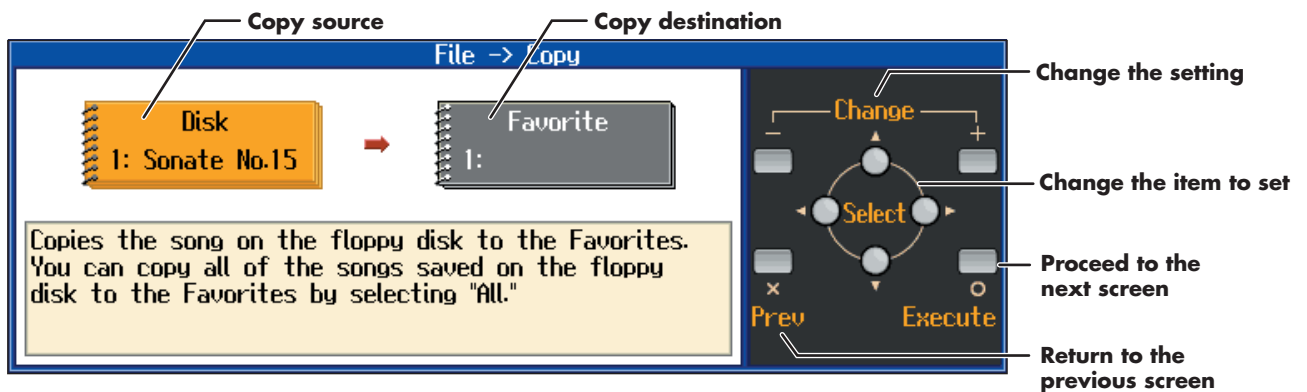

5 Specifying the copy source and the copy destination.

If a song name is displayed with a number, a song is already saved to that number.

If you select a number with previously saved song data and proceed to copy to that location, the previously saved song will be erased. If you don't want to erase a previously saved song, choose a number with no song name appears in the destination column.

When "All" is selected, all of the songs on the disk are copied to Favorites.

6 Press the [O (Execute)] button.

* Do not eject the floppy disk from the disk drive until the copy is finished.

Playing Back Music Files or a Song that was Saved on Floppy Disk

Here's how you can play back commercially available music files, or a song that was saved on a floppy disk. You can also play the keyboard along with the song playback.

→ For details on using the notation screen, refer to p. 15.

→ If you will be using a disk drive for the first time, please be sure to read "Before Using Floppy Disks" (p. 6).

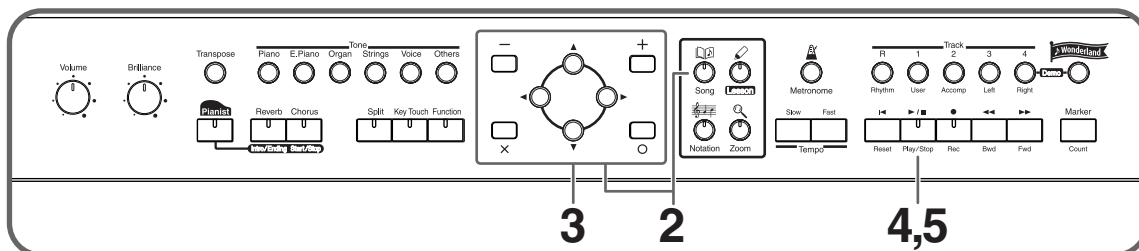

1 Insert the floppy disk into the disk drive.

Select a song

2 Press the [Song] button, and select "Disk" as the genre in the screen.

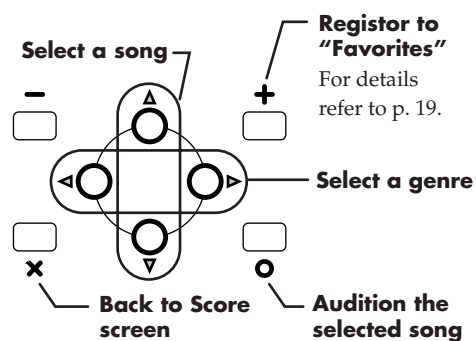
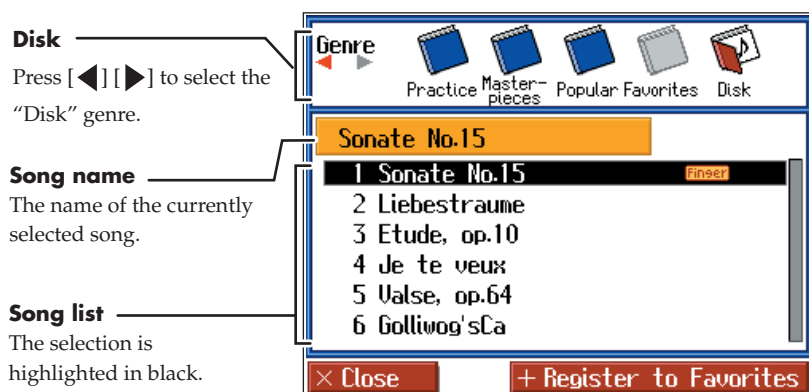

3 Select the song that you want to play back.

If a screen like the following is displayed

If a song has already been selected in the current area (internal memory), it will not be possible to select another song or record a new performance.

If it is OK to erase the existing song, select "OK." If you do not want to erase the song, select "Cancel" and save the song on a floppy disk (p. 42).



Play back the song

Press the [▶ / ■ (Play/Stop)] button.

The notation screen will appear, and the song will begin playing.

The measure number in the screen will be highlighted the music file is being loaded. Please wait.

To stop playback, press the [▶ / ■ (Play/Stop)] button once again.

Convenient Functions

Changing the Notation Screen Settings

You can change the parts shown in the notation screen, and how the notation is displayed.

- 1** Press the [Notation] button, and press the [O (Options)] button.
- 2** Press the [O (Menu)] button to display the "Score Menu."
- 3** Select "Score Option" and press the [O (Enter)] button.

The following screen will appear.

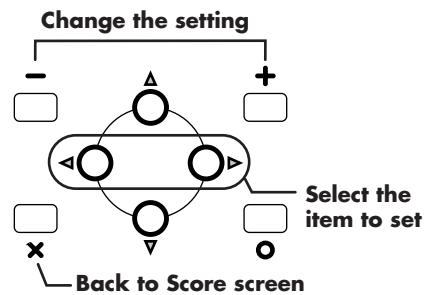
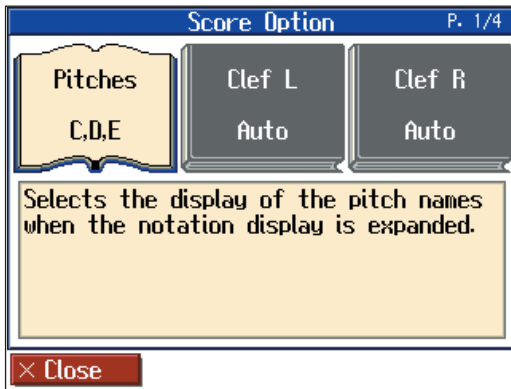

Item	Setting	
Pitches Specify how note names are displayed when the notation screen is expanded.	Off	Not displayed.
	C, D, E	The note name will be displayed.
	Do, Re, Mi (Fixed)	The pitch names (fixed Do) are displayed.
	Do, Re, Mi (Movable)	The syllable names (movable Do) are displayed.

Item	Setting	
Clef L, Clef R Specify whether the notation will be displayed as a G-clef or F-clef.	Auto	The display will be switched automatically.
	G clef	Select a G-clef notation.
	F clef	Select a F-clef notation.

Item	Setting
User Select the part that will be displayed when you select for "Part" in the notation screen.	User Track, Parts 1-16

Item	Setting
Lower Select the part that will be displayed when you select for "Part" in the notation screen.	Lower Track, Parts 1-16

Item	Setting
Upper Select the part that will be displayed when you select for "Part" in the notation screen.	Upper Track, Part 1-16

Item	Setting	
Key Display the notation in the specified key.	Auto	The key will be set automatically according to the song file.
	# x 6-0-b x 5	The notation will be displayed in the specified key.

Item	Setting
Resolution Sets the minimum note value displayed in the screen.	16th Note, 32nd Note

Item	Setting
Bouncing Ball Sets whether or not the animation of the ball bouncing in time with the tempo is to be displayed when song data is played back.	On, Off

Item	Setting
Color Notation Sets whether or not the note currently being played appears in color in the notation when song data is played back.	On, Off

Editing Songs

There are many ways you can edit performances recorded using the HPi-7 Track button (p. 40) or 16-track sequencer (p. 58).

Basic Operation of the Editing Functions

- 1** Press the [Notation] button, and press the [O (Options)] button.
- 2** Press the [O (Menu)] button to display the "Score Menu."
- 3** Select the "Song Edit", then press the [O (Enter)] button.

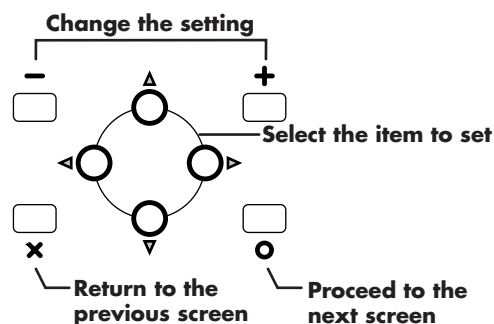
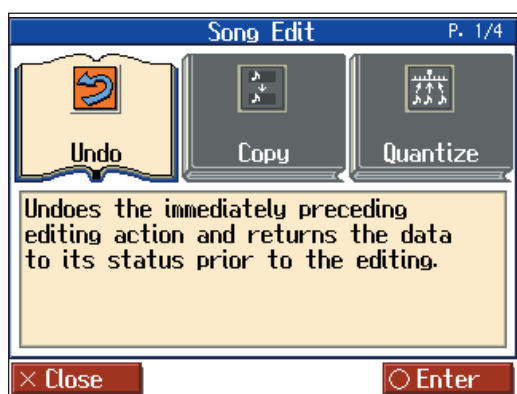

- 4** Select an editing function to set that function.

For more detailed information, refer to the corresponding page for each function.

Function	Description	Page
Undo	Undoes editing operations that have been performed.	p. 49
Copy	Copies measures.	p. 49
Quantize	Evens out sounds in recorded performances.	p. 49
Delete	Deletes measures.	p. 50
Insert	Inserts a blank measure.	p. 50
Transpose	Transposes parts individually.	p. 51
Erase	Erases data in measures, creating blank measures.	p. 51
Part Exchange	Exchanges the sounds in parts.	p. 51
Note Edit	Allows corrections to be made note by note.	p. 52
PC Edit	Allows editing of the Tones changes that occur during a song.	p. 52

- "PC" stands for "Program Change," which is a command that tells an instrument to change the sound it's using. With songs that rely on the use of a variety of sounds, a "PC" needs to be located at every point within the song where the Tone is to be changed.
- * Some edits can't be undone, not even by choosing "Undo." We recommend saving songs to floppy disks or to user memory before editing. For more on how to save songs, refer to "Saving Songs" (p. 42).
- You can press the [▶ / ■ (Play/Stop)] button in the "Song Edit screen" to play back the song you want to edit. However, you cannot play back the song while editing in the various edit screens.

Undoing Edits (Undo)

You can cancel an editing operation that you've just carried out. This is handy when you want to undo an edit and restore data to the way it was before.

* There are some edits that can't be restored.

Editing functions that can be undone appear on screen.

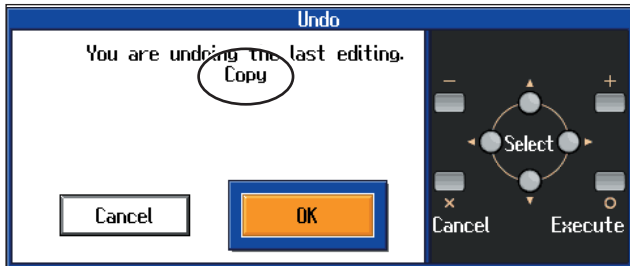

If you select "Cancel", the undo is cancelled, and you're returned to the Song Edit screen.

If you select "OK", undone the most recent edit.

Copying Measures (Copy)

You can copy a portion of a performance to a different bar in the same Part or to a measure in another Part. This is handy when you're composing a song that repeats a similar phrase.

Ex. To copy measures 5-7 to measure 8.

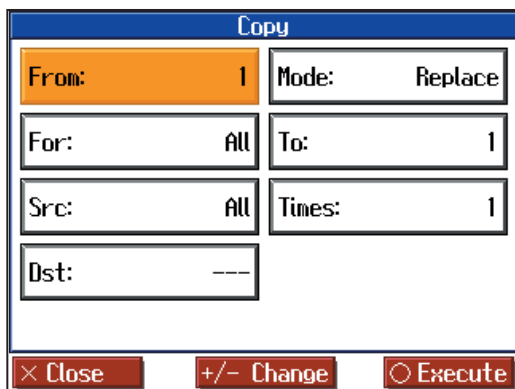
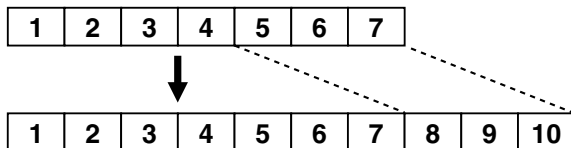

Item	Content
From	Measure number of the first measure of the segment to be copied
For	Number of measures to be copied
Src	Copy-source Track button or part number Choosing "All" copies all Parts. "---" appears in the "Dst" column. If you choose a Track button, you can only copy to the selected Track button. You cannot copy to the other Track buttons.
Dst	Copy-destination part number

Item	Content						
	Data can be copied in the following three ways:						
Mode	<table border="1"> <tr> <td>Replace</td> <td>If there is a performance recorded at the copy destination, this previous recording is erased, and the copied data is written in its place.</td> </tr> <tr> <td>Mix</td> <td>If there is a performance recorded at the copy destination, the copied data is layered over the previous recording. If the Tones used for the copy source and copy destination are different, the copy-destination Tone is used.</td> </tr> <tr> <td>Insert</td> <td>If there is a performance recorded at the copy destination, the copied portion is inserted without erasing the previous recording. The song is lengthened by the number of inserted measures.</td> </tr> </table>	Replace	If there is a performance recorded at the copy destination, this previous recording is erased, and the copied data is written in its place.	Mix	If there is a performance recorded at the copy destination, the copied data is layered over the previous recording. If the Tones used for the copy source and copy destination are different, the copy-destination Tone is used.	Insert	If there is a performance recorded at the copy destination, the copied portion is inserted without erasing the previous recording. The song is lengthened by the number of inserted measures.
Replace	If there is a performance recorded at the copy destination, this previous recording is erased, and the copied data is written in its place.						
Mix	If there is a performance recorded at the copy destination, the copied data is layered over the previous recording. If the Tones used for the copy source and copy destination are different, the copy-destination Tone is used.						
Insert	If there is a performance recorded at the copy destination, the copied portion is inserted without erasing the previous recording. The song is lengthened by the number of inserted measures.						
To	Copy-destination measure number When "End" is selected, the data is copied to the end of the song.						
Times	Number of times the data is to be copied						

Correcting Timing Discrepancies (Quantize)

You can correct for timing discrepancies in a recorded performance by automatically aligning the music with the timing you specify. This is called "Quantizing."

As an example, let's say that the timing of some quarter-notes in a performance is a little off. In this case, you can quantize the performance with quarter-note timing, thus making the timing accurate.

Example: Quarter-note resolution



Example: Sixteenth-note resolution

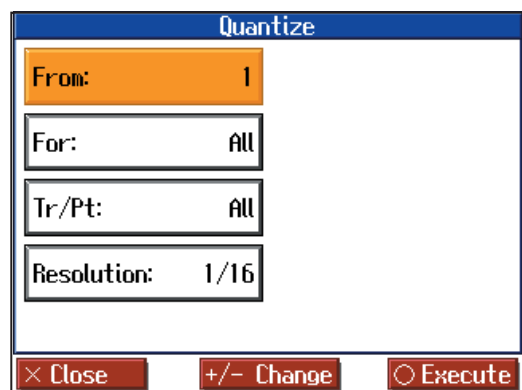
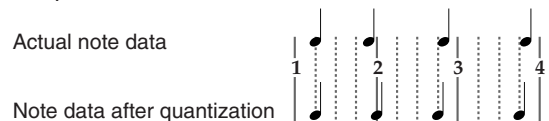

Convenient Functions

Item	Content
From	Measure number of the first measure of the segment to be quantized
For	Number of measures to be quantized
Tr/Pt	Track button or part number to be quantized Choosing "All" quantizes the same passage in all Parts.
Resolution	Quantization timing Select one of the following values 1/2 (half note), 1/4 (quarter note), 1/6 (quarter-note triplet), 1/8 (eighth note), 1/12 (eighth-note triplet), 1/16 (sixteenth note), 1/24 (sixteenth-note triplet), 1/32 (thirty-second note)

Deleting Measures (Delete)

You can delete a part of a performance measure by measure. When a portion of a performance is deleted, the rest of the performance is shifted up to fill the gap. Erasing measures in a specified passage is called "deleting."

Ex. To delete measures (bars) 5-8

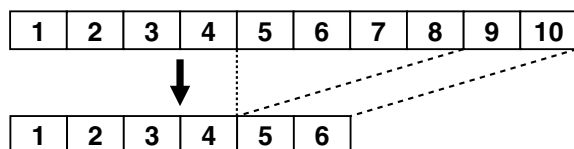

Delete	
From:	1
For:	All
Tr/Pt:	All
<input type="button" value="Close"/> <input type="button" value="+/- Change"/> <input type="button" value="Execute"/>	

Item	Content
From	Measure number of the first measure of the segment to be deleted
For	Number of measures to be deleted
Tr/Pt	Track button or part number to be deleted When "All" is selected, the same portion of all parts is deleted.

Inserting Blank Measures (Insert)

You can add a blank measure at a location you specify. This addition of a blank measure is called "insertion."

Ex. To insert measures (bars) 5-7

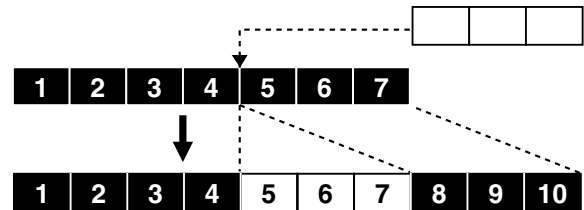

Insert	
From:	1
For:	1
Tr/Pt:	All
<input type="button" value="Close"/> <input type="button" value="+/- Change"/> <input type="button" value="Execute"/>	

Item	Content
From	Measure number of the first measure of the segment to be inserted
For	Number of measures to be inserted
Tr/Pt	Track button or part number where data will be inserted When "All" is selected, blank measures are inserted at the same place in all parts.

Transposing Individual Parts (Transpose)

You can transpose specified parts and tracks individually.

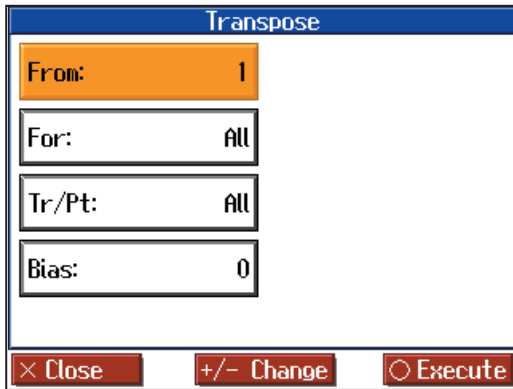

Item	Content
From	Measure number of the first measure of the segment to be transposed
For	Number of measures to be transposed
Tr/Pt	Track button or part number to be transposed When "All" is selected, the same portion of all parts is transposed.
Bias	The range of transposition You can select the range to transpose the data, from -24 (two octaves down) to +24 (two octaves up), adjustable in semitones.

You cannot transpose performances of the drum sets and sound effect sets (such as the Rhythm Track).

Making Measures Blank (Erase)

You can delete the performance data in a specified block of measures, turning them into blank measures without reducing the length of the song. This process is called "erasing."

Ex. To erase measures (bars) 5-8

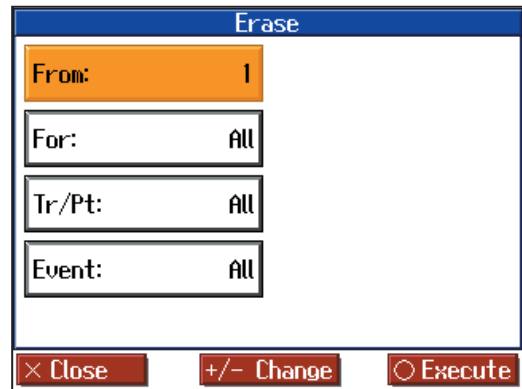
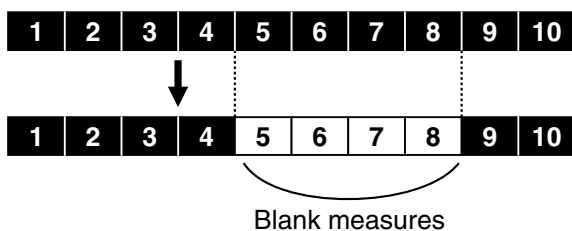

Item	Content	
From	Measure number of the first measure of the segment to be erased	
For	Number of measures to be erased	
Tr/Pt	Track button or part number to be erased When "All" is selected, the same portion of all parts is erased.	
Event	Select from the following types of performance data to erase:	
	All	All performance data, including notes, tempos, Tones switches, volume changes, etc., are erased.
	Tempo	Tempo data is erased. Erasing the tempo data for all measures results in a single, constant tempo.
	Prog. Change	Erases the data for switching Tones (p. 52).
	Note	Erases only notes.
	Except Notes	Erases all of the performance data except for the notes.
	Expression	Erases Expression (volume change) information.
	Lyrics	Only the lyrics are removed.

Exchanging Parts (Part Exchange)

You can exchange the notes recorded for a particular part with the notes recorded for another part. This process of exchanging parts is called "part exchange."

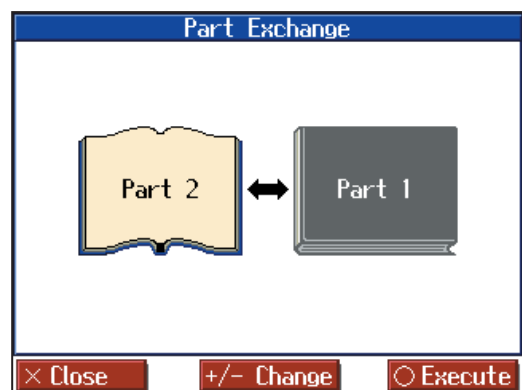

Convenient Functions

Correcting Notes One by One (Note Edit)

You can make corrections in a recorded performance one note at a time. This process of making changes in individual notes is called “note editing.”

- You can make these corrections by using note editing:
 - Deleting misplayed notes
 - Changing the scale of a single note
 - Changing the force used in playing a single key (velocity)
 - Change the fingering.

	Note	Velocity	Finger	
	001:03:000	E5	75	3
↑	001:04:000	G5	67	---
Event	002:01:000	B4	69	1
↓	002:02:058	C5	62	---
	002:02:087	D5	60	---

← Part →

× Close +/- Change ○ Delete

The note-location display uses “Measure: Beat: Tick” as the format. A tick is a unit of time that’s shorter than a beat.

Use the [◀] [▶] buttons to select the part with the note to be edited. The Part number appears at the top of the screen.

Use the [◀◀(Bwd)] button and the [▶▶(Fwd)] button or use [▲] [▼] buttons to find the note to be corrected.

When you’ve found the note you want to correct, use the [◀] [▶] buttons to select “Pitch” or “Velocity,” or “Fingering” for the note.

Use the [-] [+] buttons to correct the pitch or velocity. If you want to delete the note, press the [○ (Delete)] button.

Modifying the Tone Changes in a Song (PC Edit)

In some songs, the instrument sound changes during the course of the song (that is, the Tone changes in the middle of a Part). In such songs, an instruction to switch the Tone is inserted at the place where you want the sound to change. This instruction is called a “Program Change” (PC), and actions such as deleting program changes, or changing the selected Tone by them are called “PC editing.”

It is not possible to insert a program change into a measure or beat that does not contain a program change.

↑	HEAD	---
Event	001:01:000	Grand Piano!
↓	END	---

← Part →

× Close +/- Change ○ Delete

The PC-location display uses “Measure: Beat: Tick” as the format. A tick is a unit of time that’s shorter than a beat.

Use the [◀] [▶] buttons to select the part with the program change to be edited.

The Part number appears at the top of the screen.

Use the [◀◀(Bwd)] button and the [▶▶(Fwd)] button or use [◀] [▶] buttons to find the program change to be edited.

When you’ve found the Program Change you want to modify, select “Tone Name” on the screen.

Press a Tone button to select a Tone group, then select a Tone with the [-] [+] buttons. When selecting Part 10 or 11, select the drum set or effect sound.

If you want to delete the Program Change, press the [○ (Delete)] button.

Saving the Notation Data in BMP Format

You can take notations that are displayed on the HPi-7 and save them to floppy disks. You can also use saved image data to your computer.

- * You cannot save copyrighted song data.
- * Other than for your own personal enjoyment, use of the notations that are output without the permission of the copyright holder is prohibited by law.

1 Insert the floppy disk onto which you want to save the image data in the HPi-7’s disk drive.

Use a floppy disk formatted on the HPi-7.
For more on formatting disks, refer to p. 41.

- 2 Select the song you want to save (p. 17).
- 3 Press the [Notation] button, and press the [Options] button.
- 4 Press the [Menu] button to display the "Score Menu".
- 5 Select the "BMP output", and press the [Enter] button.

A screen like the one shown below appears.

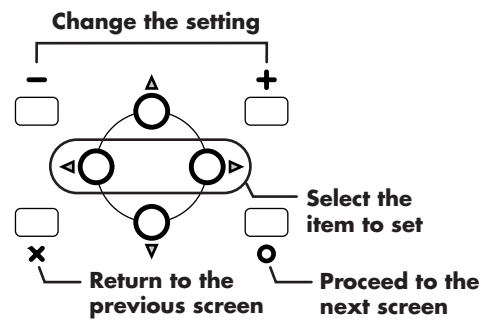
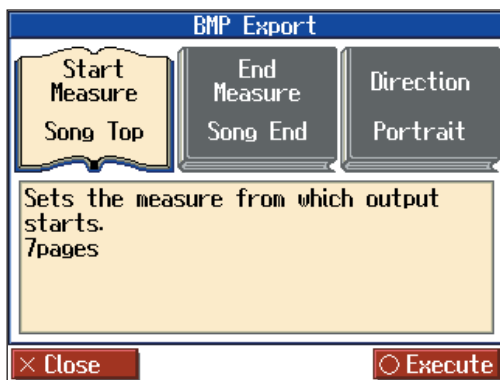

The following screen appears when you select a copyrighted song.



Press the [OK] button or the [Close] button at this point to return to Step 2 and select a different song.

- 6 Set the range to be saved.

Item	Setting	Description
Start Measure	Song Top, 2 -	Selects the measure from which output starts.
End Measure	- Song End	Selects the measure from which output ends.
Direction	Portrait, Landscape	Selects the orientation for output of the notation.

- 7 Press the [Execute] button.

The notation is saved to the floppy disk as image data in BMP (bitmap) format.

* Do not remove the floppy disk while "save" is in progress.

Convenient Functions

Functions that Can be Selected Using the [Function] Button

Here's how you can easily make changes such as tuning the HPi-7 or changing the function of the pedals.

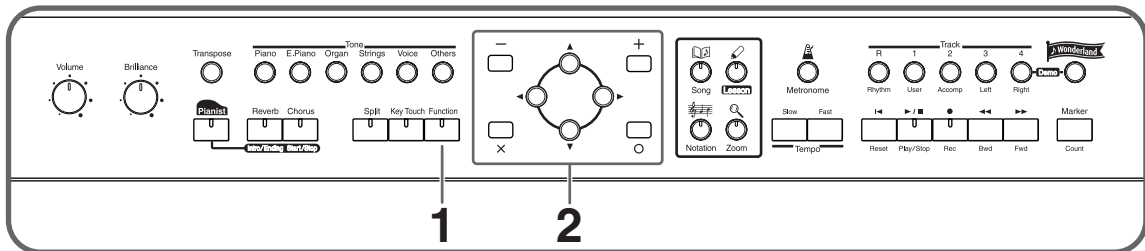

1 Press the [Function] button.

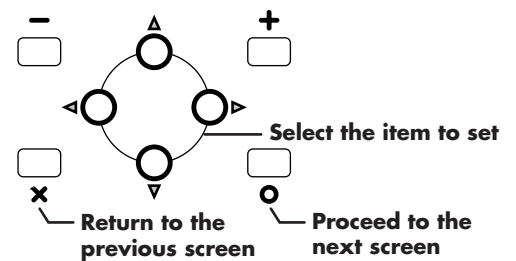
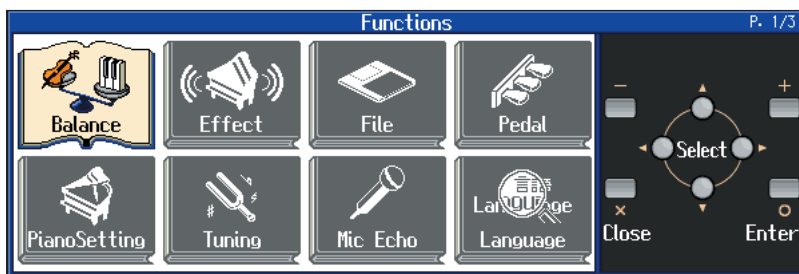

2 Use the cursor buttons to select the item that you want to set, and then press the [O (Enter)] button.

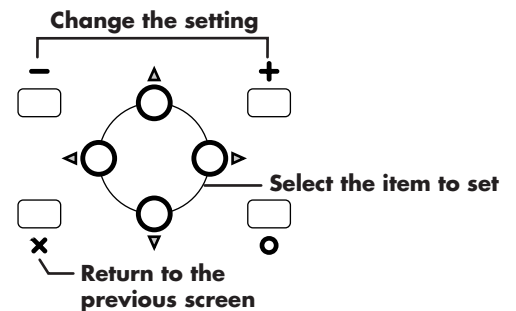
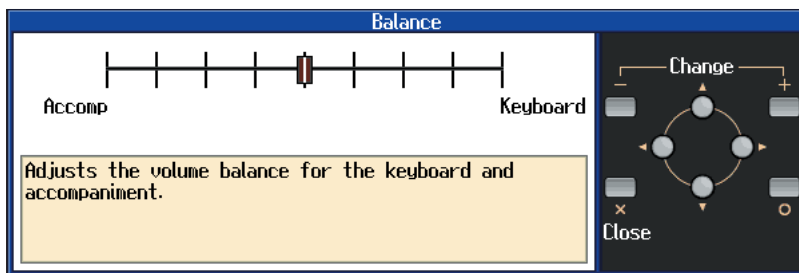

Follow the directions shown in the screen.

For details on the contents and settings of each item, refer to p. 55–p. 60. Refer to p. 62 on “MIDI,” and refer to p. 41 on “File.”

Adjusting the volume balance between accompaniment and keyboard (Balance)

You can adjust the balance between the volume of the sound played from the keyboard and the volume of the song playback or Pianist function (p. 32) accompaniment.

Setting

Press [►] to change the setting toward “Keyboard”
Decreases the volume of the song or accompaniment

Press [◀] to change the setting toward “Accomp”
Decreases the volume of the keyboard sound

Adjusting the Piano Sounds (Piano Setting)

The HPi-7 is capable of reproducing a variety of the acoustic piano’s distinctive characteristics. You can also adjust these to suit your own taste and style.

* This setting is valid when some piano sounds are selected.

Opening/Closing the Piano Lid (Lid)

This simulates the actual changes in sound that occur when the lid of a grand piano is set at different heights.

Setting

1–6 The lid is opened more as the value is increased.

Adjusting Resonance when the damper pedal is depressed (Damper Resonance)

You can adjust this resonance (Damper Resonance) when the damper pedal is depressed.

On an acoustic piano, holding down the damper pedal will allow the remaining strings to resonate in sympathy with the sounds that you played from the keyboard, adding a rich resonance. The resonance is called “sympathetic resonance.”

Setting

Off, 1–10 Increasing the value will increase the amount of effect.

Changing How Rapidly Sounds Are Expressed According to the Force Used to Play the Keys (Hammer Response)

You can adjust the timing with which sounds are produced according to the force used to play the keys.

When a key is pressed on an acoustic piano, it causes a hammer to move and strike the strings, producing sound. The hammers move more slowly when the keys are played gently, meaning that sounds are produced just slightly later than when you play the keyboard with greater force.

Setting

Off, 1–10 Increasing the value will increase the amount of effect.

Adjusting the Resonant Sounds when the keys are pressed (String Resonance)

When the keys are pressed on an acoustic piano, the strings for keys that are already pressed also vibrate sympathetically. The function used to reproduce this resonance is called “String Resonance.”

Setting

Off, 1–10 Increasing the value will increase the amount of effect.

Adjusting the depth of the effects (Effect)

You can adjust the depth of the reverb (p. 27) and chorus (p. 27). Refer to p. 54 for the procedure.

Setting

1–10 Increasing the value will increase the amount of effect.

* This setting is valid when the [Chorus] button or [Reverb] button is turned on to apply an effect to the sound.

→ Holding down the [Reverb] or [Chorus] button, press the [+] or [-] button to adjust the depth of each effect.

Setting the reference pitch and temperament (Tuning)

Refer to p. 54 for the procedure.

Master Tune

In situations such as when playing in ensemble with other instruments, you can adjust the HPi-7’s reference pitch to that of another instrument. Middle A is used as the reference pitch for tuning instruments.

The process of adjusting the reference pitch to match another instrument is called “Tuning.”

Setting

415.3 Hz–440.0 Hz–466.2 Hz

Stretch Tuning

Pianos are generally tuned so that the low range is flatter and the high range is sharper than equal tempered pitches. This method of tuning is unique to the piano, and is known as “stretched tuning.”

Setting	Description
On	This tuning curve expands the low range and high range. It is suitable for piano solos. This setting is selected when the power is turned on.
Off	This is the standard tuning curve. It is suitable when playing in an ensemble with other instruments.

Convenient Functions

Temperament

You can play classical styles such as Baroque using historic temperaments (tuning methods). Today, compositions are generally created with equal temperament in mind and are played using equal temperament. However in past ages of classical music, a variety of temperaments were used. By playing in the temperament that was in use when a composition was created, you can experience the sonorities of chords originally intended for that song.

Setting	Description
Equal	This temperament divides the octave into 12 equal parts. All intervals will be slightly out of tune by the same amount.
Just Major	This temperament makes the 5th and 3rd intervals pure. It is unsuitable for playing melodies and modulation is not possible, but it produces beautifully harmonious chords.
Just Minor	Just intonation differs between major and minor keys. The same results as major can be obtained in a minor key.
Arabic	This tuning is suitable for the music of Arabia.
Kirnberger	This temperament is a modification of meantone temperament and just intonation, allowing more freedom of modulation. It allows you to play in all keys (third method).
Pythagorean	This temperament is based on the theories of the Greek philosopher Pythagoras, and has pure fourths and fifths. Chords containing a third will sound impure, but melodies will sound good.
Meantone	This temperament is a partial compromise of just intonation in order to allow modulation.
Werkmeister	This temperament is a combination of meantone and Pythagorean temperaments. It allows you to play in all keys. (First method, number three.)

Key

When playing in a temperament other than equal temperament, you must specify the tonic (the note corresponding to C for a major key, or to A for a minor key) of the key in which you will play.

If you have selected equal temperament, it is not necessary to select the tonic.

Setting C, C#, D, Eb, E, F, F#, G, Ab, A, Bb, B

Mic Echo

When you use the mic, you can add a karaoke-like echo effect to the mic.

Refer to p. 54 for the procedure.

Setting

Off, 1–10 Increasing the value will increase the amount of effect.

Changing the function of the pedals (Pedal)

You can change the function of the left pedal and center pedal. Refer to p. 54 for the procedure.

Setting	Description
Soft (only left pedal)	When you hold down the pedal and play the keyboard, the sound will have a softer tone.
Sostenuto (only center pedal)	Only the notes that were played while the pedal was held down will be sustained.
Tap Tempo	The tempo of the song, accompaniment, or metronome will be set by the interval at which you press the pedal. When the pedal to which this function is assigned is pressed several times at the desired rate, the tempo will be set accordingly.
Lower Damper	When using Split performance, the same effect as the damper pedal will be applied to the left-hand keyboard area.
Replay	Pressing the pedal during playback of a song stops the playback. When the pedal is released, playback resumes from the beginning of the measure that was playing when the pedal was pressed. When the pedal is pressed in rapid succession, the playback will resume back up the same number of measures as the number of times the pedal is pressed.
Page Bwd	Press the pedal or the Pad turns the notation appearing on the display to the preceding page while the performance of a song is stopped.
Page Fwd	Press the pedal or the Pad turns the notation appearing on the display to the next page while the performance of a song is stopped.
Composer Start/Stop	Performs the same function as the [Start/Stop] button.

Changing the language displayed in the screen (Language)

You can change the language that is displayed in the screen. Refer to p. 54 for the procedure.

Setting

English, Japanese, German, French, Spanish

* German, French, and Spanish are displayed for some functions. Other screens will be displayed in English.

Selecting Images To Be Shown on the Displays (User Image Display)

You can have image data from computers and other devices shown on the onboard display.

- 1** Take a floppy disk to which the image data stored in the HPi-7 has been saved, and insert the disk in the disk drive.
- 2** At Step 2 in p. 54, select "User Image Display" and press the [O (Enter)] button.
- 3** Select the image you want to be displayed from the list, then press the [+ (Save) button.
When you press [O (Preview)] button, you can then show the selected image data on the display.

Image Data That HPi-7 can display

Size	640 x 240 pixels
Color	1/4/8 bit (2/16/256 colors)
Format	BMP format (The HPi-7 cannot deal with compressed image data).
Name	<p>1–8 characters in length (lowercase is ok). A filename extension of ".BMP" (uppercase characters) must be added after the name.</p> <p>The following characters can be used to name an image. A B C D E F G H I J K L M N O P Q R S T U V W X Y Z a b c d e f g h i j k l m n o p q r s t u v w x y z 0 1 2 3 4 5 6 7 8 9 # \$ % & ` () - @ ~ { } ^ _ !</p> <p>* If you use a character that cannot be used in a name, it will be replaced by another character when displayed.</p>

To Delete a Saved Image

- 4** Press the [▲] button to return to the top of the list, then press the [▲] button once more.
The file name for the saved image is highlighted.
- 5** Press the [+ (Delete)] button.

Setting the Demo (Auto DEMO)

Sets whether or not Auto mode is started when no action is taken for a set length of time.

Refer to p. 54 for the procedure.

Item	Description	Setting
Auto Start	Sets whether or not Auto mode is started when no action is taken for a set length of time.	On, Off
Mode	Selects the image to be displayed in the screen when Auto mode starts. Select "Demo" to display the demo introducing the piano's functions. Select "User Image" to display the image saved with "User Image Display."	Demo, User Image
BGM	Selects whether or not BGM (background music) is played when Auto mode starts. When "On" is selected, all of the songs are played in random order.	On, Off

→ If you select "Demo" with an image saved in "User Image Display," the saved image appears at the beginning of the demo.

Changing the parts assigned to the track buttons during SMF playback (Track Assign)

Ordinarily, when playing back SMF music files for Roland Piano Digital instruments (p. 77), the left-hand part is assigned to the Track [3/Left] button, and the right-hand part is assigned to the Track [4/Right] button.

However, right-hand and left-hand part assignments in certain SMF music files may differ. If these are set to "Auto," and as a result you are unable to use the track buttons to control the left- and right-hand parts properly, change the setting to "2/1 Part" or "3/4 Part."

Refer to p. 54 for the procedure.

Setting	Description
Auto	The part assigned to each track will be determined automatically, depending on the song file.
2/1 Part	Part 1 will be assigned to the right-hand track, part 2 to the left-hand track, and part 3 to the user track.
3/4 Part	Part 4 will be assigned to the right-hand track, part 3 to the left-hand track, and part 1 to the user track.

* After changing this setting, try selecting the song once again.

Convenient Functions

Recording and Playing Back Performances of Specific Instruments (16 Track)

Multitrack recording is a method of recording whereby you listen to what has previously been recorded while recording new parts on top of that material.

The HPi-7 lets you record 16 separate parts. By recording a different tone to each part, you can create song data for performances that feature up to 16 different tones layered together.

The function used for recording the 16 individual parts one at a time is called the “16-track sequencer.”

16-Track Sequencer

You can record performances for up to 16 parts, overlaying them part by part, to create a single song.

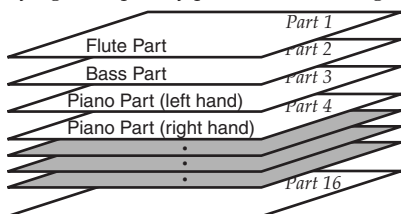

16-Track Sequencer and the Track Buttons

In addition to the “16-Track Sequencer” function, the “Track Buttons” (p. 16) are another of the unit’s playing/recording functions.

In addition to the “16-track sequencer,” the HPi-7 also features the “track buttons” (p. 16).

These “track buttons” group the 16-track sequencer’s 16 parts with five buttons. Using the 16-track sequencer to work with performances recorded with the track buttons allows you to record even more sounds and edit with precision.

The track buttons correspond to the 16-track sequencer's parts as shown below.

Track button	Part
[R/Rhythm]	D (10), S (11)
[1/Whole]	1
[2/Bass Accomp]	2, 5–9, 12–16
[3/Lower]	3
[4/Upper]	4

Each of the 16-track sequencer’s parts is used for recording a single tone, so you cannot use it to record tones that combine two tones simultaneously, as in Dual (p. 27) and Split (p. 28) performances.

In addition, when recording performances using the Pianist function, you can select only one part to record. If you want to record multiple parts simultaneously with the Pianist function, you should use the track buttons. Refer to “Recording with an accompaniment (the Pianist function)” (p. 39).

You can also change the tones in each part, select specific parts for playback (solo), and prevent specified parts from playing (mute). Playback with only a single part muted is called “Minus One.” You can even set solo and muting during playback.

→ Part 11 of Roland SMF music data that is available for purchase is included with the track button [2/Bass and Accompaniment], but the correspondence of other parts to the track buttons is the same.

* Some commercially available SMF music file may contain data that cannot be edited.

Basic Procedure

First, have the song that you want to edit selected.

- 1 Press the [Function] button, then use the [◀][▶] button to select “16 Track” and press the [○] button.

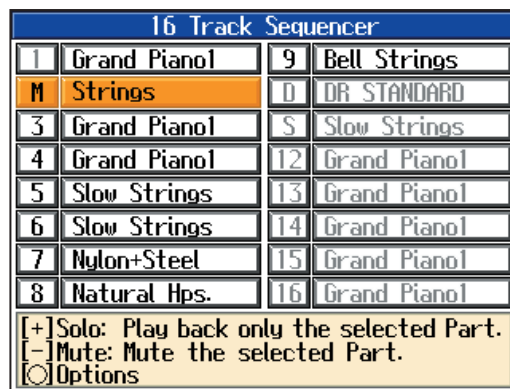

- 2 Press the [◀][▲][▶][▼] buttons to select the part you want to edit.
- 3 Make the settings for the part and record.
- 4 When you have finished the settings and recording, press the [X] button
The following screen will appear.

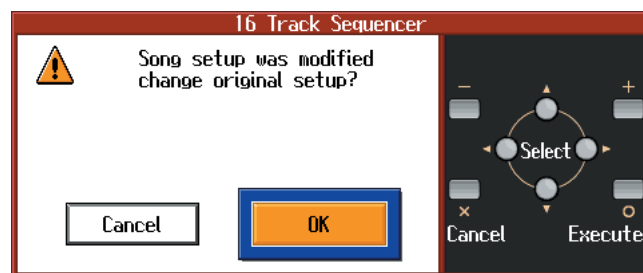

- 5 Press the [◀][▶] buttons to select “OK,” then press the [○] (Execute) button.

Preventing a Part from Playing (Mute)

Press the [+] or [-] button to select Solo or Mute.

The number of the muted part is displayed as “M.”

Pressing the [+] or [-] button once more cancels Solo or Mute.

Changing Tones

Select tones by pressing the [Tone] button and the [+] or [-] button.

Recording

Use the [◀◀(Bwd)] or [▶▶(Fwd)] buttons to move to the measure you want to record.

Set the recording tempo and metronome.

- 1 Press the [● (Record)] button.
The HPI-7 goes into record standby.
- 2 Press the [▶ / ■ (Play/Stop)] button to start recording.
Two measures of the count-in sound is played, and the recording begins.
- 3 Press the [▶ / ■ (Play/Stop)] button to stop recording.

Making Part Settings

This makes more detailed settings for the parts.

- 1 Select the part you want to edit, then press the [○ (Options)] button.
The following screen will appear.

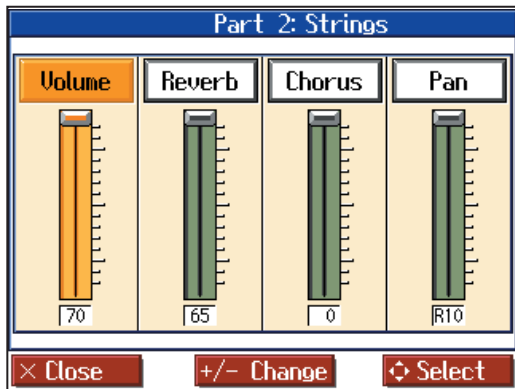

- 2 Press the [◀] or [▶] button to select the parameter, then change the value with the [+] or [-] buttons.

Display	Description
Volume	Changes the volume level.
Reverb	Changes the amount of reverb effect applied to the sound.
Chorus	Changes the amount of chorus applied.
Panpot	Shifts the direction from which the sound is heard between left and right. Press the [+] button to shift the sound to the right, or press the [-] button to shift it to the left.

What's Panpot?

Panpot is the control that determines the placement of the sound in the stereo sound field between left and right speakers. By altering the Panpot setting, you can change the perceived location of the sound between the left and right speakers.

Formatting the User Memory (Initialize User Memory)

The HPI-7 features an internal storage area where you can save recorded performances and User Styles. This space is called the "User Memory."

The following content is stored to the user memory.

- Content registered to the "Favorites"
- Image files set with the "User Image Display"

To delete all of the content held in the user memory and restore the original factory settings, carry out the following procedure.

- 1 In step 2 on p. 54, select "Initialize User Memory" and press the [○ (Enter)] button, and a message will be displayed.
- 2 Use the [◀] or [▶] buttons to select "OK," then press the [○ (Execute)] button to carry out the Initializing procedure.

* Never turn off the power while the display indicates "Executing..." Doing so will damage the HPI-7's internal memory, making it unusable.

Carrying out this operation does not initialize any settings other than the user memory settings. To restore settings other than those for the user memory to the original factory settings, carry out Factory Reset.

Remembering the settings even when the power is turned off (Memory Backup)

Normally, the settings of the various variations will revert to their default values when the power is turned off. However, you can specify that the various settings will be remembered even when the power is turned off.

This function is called "Memory Backup."

- 1 In step 2 on p. 54, select "Memory Backup" and press the [○ (Enter)] button, and a message will be displayed.
- 2 Use the [◀] or [▶] buttons to select "OK," then press the [○ (Execute)] button to carry out the Memory Backup procedure.

Convenient Functions

Stored contents

Master Tune, Stretch Tuning, Temperament, Key (p. 55)
Lid, Damper Resonance, Hammer Response, String Resonance (p. 55)

Key Touch (p. 25)

Metronome Sound (p. 20)

Count In Sound, Countdown Sound, Count In Measure (p. 21)

Language (p. 56), Track Assign (p. 57), Reverb Switch, Reverb Depth (p. 55)

* Never turn off the power while the display indicates "Writing..." Doing so will damage the HPi-7's internal memory, making it unusable.

→ The settings for the following parameters are saved even without Memory Backup.

Auto Demo (p. 57), USB Driver (p. 63)

Restoring the factory settings (Factory Reset)

The memory backup settings can be restored to the factory-set condition. This operation is referred to as "Factory Reset."

1 In step 2 on p. 54, select "Factory Reset" and press the [O] button, and a message will be displayed.

2 Use the [◀] or [▶] buttons to select "OK," then press the [O (Execute)] button to carry out the Factory Reset procedure.

Once the Factory Reset has been completed, switch the power off, then on again.

* Never turn off the power while the display indicates "Executing..." Doing so will damage the HPi-7's internal memory, making it unusable.

Using the V-LINK function

Connecting the HPi-7 to a V-LINK compatible image device allows you to control the images with the HPi-7.

V-LINK (**V-LINK**) is functionality promoted by Roland that allows linked performance of music and visual material. By using V-LINK-compatible video equipment, visual effects can be easily linked to, and made part of the expressive elements of a performance.

Refer to p. 54 for the procedure.

* To prevent malfunction and/or damage to speakers or other devices, always turn down the volume, and turn off the power on all devices before making any connections.

Setting	Description
On	Switches to Image Control mode. You can control images using the twelve keys at the left end of the keyboard.
Off	Cancels Image Control mode.

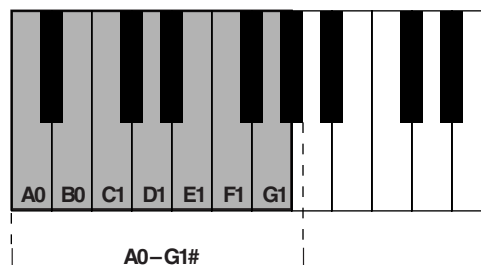

While V-LINK is switched on, no sound is produced when you press any of the twelve keys at the left end of the keyboard.

Changing the Tone Settings When Playing Back Songs (Play Mode)

With the normal setting, GS tones (sounds that are compatible with other GS instruments) will normally be used to play back song data. By changing this setting, you can play back song using HPi-7-specific tones for certain portions of the data. Refer to p. 54 for the procedure.

Setting	Description
GS	Playback uses GS-compatible tones for performances that sound like other GS instruments.
HPi-7	Playback uses HPi-7 tones for greater expressiveness. However, differences may appear when playing back using devices other than the HPi-7.

* After changing this setting, try selecting the song once again.

Playing the Demos

You can play demo songs that give you an idea of the HPi-7's various functions.

1 Hold down the Track [4/Left] button and press the [Wonderland] button.

The songs in the "Masterpieces" category are played back, and the screens showing the HPi-7's functions appear in sequence in the display.

2 To delete a demo song, press the [X] button.

→ You can set the HPi-7 so that the demo songs start playing automatically in All Song Play if the instrument is not played or adjusted for several minutes.

Connecting External Devices

Connecting Audio Devices

You can connect audio devices to play the sound of the HPi-7 through the speakers of your audio system, or to record your performance on a tape recorder or other recording device. Use phone plug audio cables (sold separately) to make connections.

- * When connection cables with resistors are used, the volume level of equipment connected to the input jacks may be low. If this happens, use connection cables that do not contain resistors, such as those from the Roland PCS series.

Example connections

- * To prevent malfunction and/or damage to speakers or other devices, always turn down the volume, and turn off the power on all devices before making any connections.

Playing the sound of the HPi-7 through the speakers of an audio system/Recording the performance of the HPi-7 on a recording device

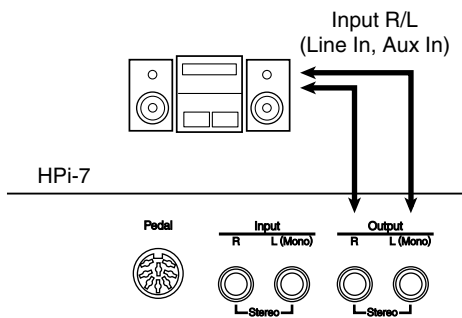

Use the following procedure when turning on the power.

- 1 Turn on the power of the HPi-7.
- 2 Turn on the power of the connected device.
- 3 Adjust the volume of each device.

Playing the sound of an audio device through the speakers of the HPi-7

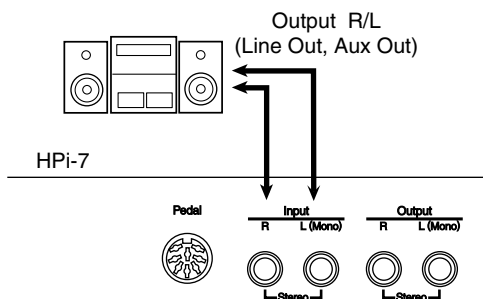

Use the following procedure when turning on the power.

- 1 Turn on the power of the connected device.
- 2 Turn on the power of the HPi-7.
- 3 Adjust the volume of each device.

Connections with MIDI Devices

By connecting external MIDI devices and exchanging performance data, a device can control the performance of another device. For example, you can play sounds from another device, or select sounds remotely.

What is MIDI?

“MIDI” stands for “Musical Instrument Digital Interface,” and is a universal standard created to allow for the exchange of performance data among electronic musical instruments and computers. The HPi-7 provides MIDI connectors, which allow performance data to be exchanged with an external device. When these connectors are used to connect the HPi-7 to external devices, an even wider range of possibilities becomes available.

- * A separate publication titled “MIDI Implementation” is also available. It provides complete details concerning the way MIDI has been implemented on this unit. If you should require this publication (such as when you intend to carry out byte-level programming), please contact the nearest Roland Service Center or authorized Roland distributor.

Example connections

- * To prevent malfunction and/or damage to speakers or other devices, always turn down the volume, and turn off the power on all devices before making any connections.

Playing the HPi-7 from a MIDI sequencer/Recording an HPi-7 performance on a MIDI sequencer

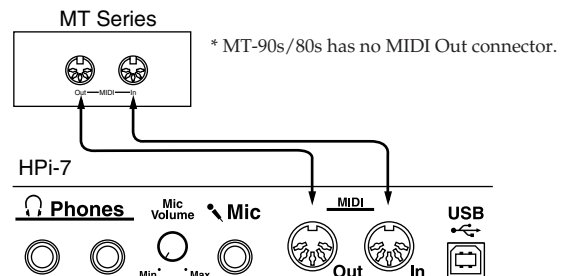

- * If you are connecting a MIDI sequencer, set “Local Off.” For details refer to “Local Control setting” (p. 62).

Perform on the HPi-7 to play a MIDI sound generator

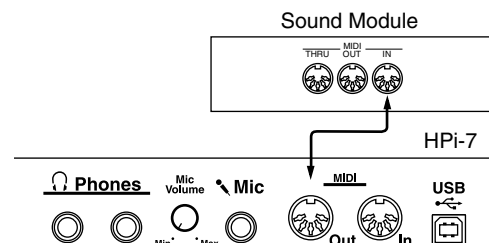

- For details on MIDI settings, refer to “Making MIDI-Related Settings” (p. 62).

Connecting External Devices

Connections to a Computer

You can use a USB connector to connect the HPi-7 to your computer.

Roland's "Visual MT" is installed, you will be able to play the sound of the software sound generator from the HPi-7's speakers, or save a recorded HPi-7 song on your computer.

For more details, refer to the separate "USB Installation Guide."

- * To prevent malfunction and/or damage to speakers or other devices, always turn down the volume, and turn off the power on all devices before making any connections.
- * Connecting your computer to the HPi-7 for the first time requires installation of the "USB Driver" (on the included CD-ROM) to the computer. For more details, refer to the separate "USB Installation Guide."
- * Only MIDI data can be transmitted using USB.
- * Use a USB cable no longer than 3 meters.
- * USB cables are not included. Consult your Roland dealer if you need to purchase.
- * Turn on the power to the HPi-7 before starting up MIDI applications on the computer. Do not turn the HPi-7 on or off while any MIDI application is running.
- * Do not connect or disconnect the USB cable while the HPi-7's power is on.
- * If not using USB, disconnect the USB cable from the HPi-7.
- * If, during the transmission/reception of data, the computer switches to energy-saving mode or suspended mode, or if the HPi-7's power is switched on or off, the computer may freeze, or the HPi-7's operation may become unstable.
- * When using your computer's sequencer software to record HPi-7 performances, we recommend setting the sequencer software's Soft Thru to "OFF."

Making MIDI-Related Settings

Here's how you can set the transmit channel and other MIDI-related settings.

1 Press the [Function] button.

2 Select "MIDI," and press the [O] button.

Follow the directions that appear in the screen.

MIDI settings

MIDI transmit channel setting

MIDI has sixteen "MIDI channels," numbered 1–16. Even if a MIDI device is connected, it will not be possible to play or select sounds unless the MIDI channels of the two devices match.

* When Dual performance (p. 27) is being used on the HPi-7, only the channel you specify here will be transmitted.

* The HPi-7 receives all channels 1–16.

Item	Explanation	Setting
Transmit Channel	Select the MIDI transmit channel.	1–16

Local Control setting

If the data that is produced when you play the keyboard is sent to the sound generation section via both routes (1) and (2) as shown in the diagram, notes will be doubled or may be interrupted. To prevent this, use the "Local Off" setting to disconnect route (1). Set Local Off if you have connected the HPi-7 to a MIDI sequencer.

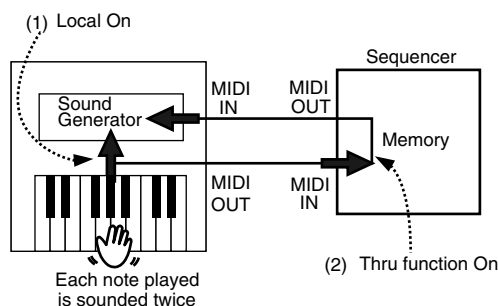

- * When a Roland MT series instrument is connected, it is not necessary to make the Local Off setting. The MT transmits a Local Off message when the power is turned on. If you turn on the power in the order of the HPi-7 → MT series, Local Off will be set automatically.

Item	Explanation	Setting
Local Control	Switch the Local Control setting on/off.	On, Off

Composer Out setting

If you want a performance recorded on the HPi-7 to be transmitted to an external MIDI device or computer, turn the “Composer Out” setting “On.”

Item	Explanation	Setting
Composer Out	Specify whether a recorded performance will be transmitted to a MIDI device.	On, Off

Program Change setting

Program changes are a type of message that tell a device to “switch to sound number `x’.” A device that receives this message will select the sound of the corresponding number.

When you use this setting to specify a program change (program number), that program number will be transmitted to a MIDI device connected to the HPi-7. A MIDI device that receives the program number will switch to the sound corresponding to that program number.

Normally, program changes select from 128 different sounds. However, some MIDI devices have more than 128 sounds. For such devices, Bank Select messages are combined with Program Change messages to select sounds. Bank Select consists of two messages: MSB (controller number 0; value: 0-127), and LSB (controller number 32; value: 0-127).

* Some MIDI devices cannot use bank select messages. Alternatively, some devices may use bank select messages, but ignore the LSB message.

Item	Explanation	Setting
Bank Select MSB	Transmit the bank select MSB.	0 (00h)–127 (7FH)
Bank Select LSB	Transmit the bank select LSB.	0 (00h)–127 (7FH)
Program Change	Transmit the program number.	1 (00h)–128 (7FH)

Making the Settings for the USB Driver

If you intend to connect to a computer using the USB connector, you need to make the following setting before you make the connection.

- 1 Press the [Function] button.
- 2 Select “USB Driver,” and press the [O] button.

Item	Setting	Explanation
USB Driver Selects the USB driver type.	Vendor	Select this when using the supplied driver with a USB connection.
	Generic	Select this when using a generic USB driver included with the OS with a USB connection.

- 3 Turn on the power once again.

Trouble Shooting

If you think there's a problem, read this first.

Case	Cause/Remedy
The power doesn't come on.	Is the power cord connected and plugged in correctly? (p. 9)
The button doesn't work.	Is the panel locked? (p. 11) Turn the power off, then back on.
Nothing appears on screen.	The HPI-7 uses a liquid-crystal screen, so text may not be displayed when the ambient temperature is below freezing.
	Is the music rest (screen) connection cable connected correctly? (p. 9)
Vertical lines appear in the screen/Color is "washed out" at the edges of the screen	These occur due to the nature of a liquid crystal display, and do not indicate a malfunction. They can be minimized by adjusting the brightness of the screen (p. 10).
No sound is heard.	Is the volume level of the HPI-7 (p. 10) or connected device turned all the way down?
	Are headphones plugged in?
	Has a plug remained connected to the Phones jack? (p. 9) When you connect the headphones, the sound is heard only through the headphones.
	Could the "Balance" setting be set all the way toward "Accomp" or "Keyboard"? (p. 55)
No sound is heard (when a MIDI instrument is connected).	Have all devices been switched on? (p. 61)
	Are the MIDI cables connected correctly? (p. 61)
	Does the MIDI channel match the connected instrument? (p. 62)
No sound is heard when the keyboard is played.	Has Local Control been set to "Off"?
	When Local Control is set to Off, no sound is produced by playing the keyboard, Set Local Control to On (p. 62).
Volume of keyboard is too low	Could the "Balance" setting be set all the way toward "Accomp"? (p. 55)
No sound from left-hand section of keyboard	Is the [Pianist] button's indicator lit? (p. 32) If the [Pianist] button's indicator is lit, there will be no sound from the left-hand section of the keyboard.
	No sound from the left side is V-LINK switched on? (p. 60)
	When V-LINK is switched on, the twelve keys at the left end of the keyboard are used to control images, and no sounds are played with these keys.
Sounds are heard twice (doubled) when the keyboard is played.	Is the HPI-7 in Dual play? (p. 27)
	When the HPI-7 is connected to an external sequencer, set it to the Local OFF mode (p. 62). Alternatively, the sequencer could be set so its Soft Thru feature is OFF.
Not all played notes are sounded.	The maximum number of notes that the HPI-7 can play simultaneously is 128. Frequent use of the damper pedal during automatic accompaniment or when playing along with a song on floppy disk may result in performance data with too many notes, causing some notes to drop out.

Case	Cause/Remedy
Can't select a tone	Press the [X] button several times to return to the notation screen (p. 15), and then select a tone.
The tuning or pitch of the keyboard or song is off.	Have you set Transpose? (p. 24)
	Are the settings for the "Temperament" and "Stretch Tuning" correct? (p. 55)
	Is the setting for the "Tuning" correct? (p. 55)
Volume of accompaniment or internal song is too low	Could the "Balance" setting be set all the way toward "Keyboard"? (p. 55)
Song doesn't play back	Does the screen indicate message, like "Deletes the selected song. OK?" (p. 18)
	The internal songs cannot be played back while recorded performance data remains in the HPI-7's memory. Try playing back the song after deleting the performance data.
Only the sound of a particular instrument in a song does not play	Is the light for the Track button extinguished? (p. 16, p. 58)
	If the button light is out, the music on that track is not heard. Press the track button so the light is illuminated. Or cancel the mute in the "16 track" screen.
Pressing the [Reset] button doesn't return to the beginning of the song.	Some music files may contain settings that stop play at a point partway through the song. Press the [Reset] button several times more to return to the beginning of the tune.
The [Fwd] and [Bwd] buttons don't work.	The [Fwd] and [Bwd] reverse buttons are ignored while music files is being read in. Wait until processing finishes.
	If you attempt to play back performance data that contains more data than the entire capacity of the HPI-7's memory, you may find that operations other than playback (such as rewind or fast forward) become unavailable.
There is a slight delay before playback of a song on floppy disk starts.	There are two types of SMF music files: format 0 and format 1. If the song uses SMF format 1 data, there will be a slight delay until playback starts. Refer to the booklet that came with the music files you're using to determine the format type.
Can't record	Has one of the track buttons for recording been selected? (p. 38)
	It is not possible to record while the notation is being generated. Once the unit has finished generating the notation (i.e., when the measure number in the screen is no longer highlighted), try the operation once again.
Tempo of recorded song or metronome is off	If you select an internal song in which the tempo changes during the song, and then record, the tempo will change in the same way for the performances that are recorded on the other tracks. The tempo of the metronome will also change in the same way.
	If you record additional material without erasing the previously recorded song, the song will be recorded at the first-recorded tempo. Please erase the previously recorded song before you re-record (p. 39).

Case	Cause/Remedy
The Tone has changed.	When a performance made along with a Music Files tune has been recorded, recording the performance to button [1/User] may make the Tones for buttons [3/Left] and [4/Right] change as well.
The recorded performance has disappeared.	Any performance that has been recorded is deleted when the power to the HPi-7 is turned off or a song is selected. A performance cannot be restored once it's been deleted.
Lyrics are not indicated properly in the display.	With some music files, the lyrics cannot be displayed correctly.
	In the notation screen, some lyrics or notes could extend beyond the edges of the screen, and not be displayed.
Notation is not indicated properly in the display.	If you select a part that does not contain performance data, notes will not be displayed in the notation. Change the part that is displayed (p. 47).
	The notation screen feature is particularly unsuitable for the display of difficult, complex musical works that demand accurate notation. Refer to "Some notes on the notation screen" (p. 15).
	In the notation screen, some lyrics or notes could extend beyond the edges of the screen, and not be displayed.
Song becomes unstable	In certain cases, such as when playing songs on disks, the song may lag when excessive amounts of performance data are used.
Depressing a pedal has no effect, or the pedal effect doesn't stop.	Is the pedal connected correctly? Make sure the pedal cord extending from the stand is securely connected to the pedal jack on the rear of the unit (p. 9).
	Has a different function been assigned to the pedal? See "Changing the function of the pedals (Pedal)" (p. 56).
The pedal rattles	Adjust the adjuster underneath the pedal so that the pedal presses firmly against the floor surface (p. 11).
Reverberation still audible even with Reverb turned off	Since the HPi-7's piano sounds faithfully reproduce the sense of spaciousness and reverberation of an actual acoustic piano's sound, a certain amount of reverberation is still perceptible, even with the reverb effect deactivated.
In the upper range, the sound changes abruptly beyond a certain key	On an acoustic piano, notes in the upper one and a half octaves of the keyboard continue to sound until they decay naturally, regardless of the damper pedal. There is a difference in the timbre as well. Roland pianos faithfully simulate such characteristics of the acoustic piano. On the HPi-7, the range that is unaffected by the damper pedal will change depending on the Key Transpose setting.

Case	Cause/Remedy
A High-pitched whine is produced	When listening through headphones: Some of the more flamboyant and effervescent piano tones feature an ample high-end component, which may make the sound appear to have metallic reverberation added. Since this reverberation becomes particularly audible when supplemented by heavy reverb, you may be able to diminish the problem by reducing the amount of reverb applied to the sound.
	When listening through speakers: Here, a different cause (such as resonance produced by the HPi-7) would be suspect. Consult your Roland dealer or nearest Roland Service Center.
The bass range sounds odd, or there is a vibrating resonance	When listening through speakers: Playing at loud volumes may cause instruments near the HPi-7 to resonate. Resonation can also occur with fluorescent light tubes, glass doors, and other objects. In particular, this problem occurs more easily when the bass component is increased, and when the sound is played at higher volumes. Use the following measures to suppress such resonance. <ul style="list-style-type: none"> • Place speakers so they are 10–15 cm from walls and other surfaces. • Reduce the volume. • Move the speakers away from any resonating objects.
	When listening through headphones: Here, a different cause (such as resonance produced by the HPi-7) would be suspect. Consult your Roland dealer or nearest Roland Service Center.
The volume level of the instrument connected to Input jacks is too low.	Could you be using a connection cable that contains a resistor? Use a connection cable that does not contain a resistor.
Titles of songs on floppy disk not being displayed	Has the song name data (Sequence/Track Name Meta Event) been entered in the file? Song titles are not displayed if the song name data is blank or consists exclusively of spaces.
	Is the file name no more than eight single-byte characters?
	Have any double-byte characters (such as Japanese Hiragana or Kanji characters) been used in the file name? This instrument does not display double-byte characters. For characters that can be used with this instrument, refer to p. 43.
	Is ".MID" used as the extension? The song cannot be treated as song data if a different extension is used.

If this Message Appears on Screen

Indication	Meaning
PU	When a song with a pickup (a song that does not start on the first beat) is played back, the measure numbers will be indicated in the display as PU, 1, 2, and so forth.
00: This data cannot be saved in SMF format. You cannot save on this floppy.	To protect the copyright, this music file cannot be saved as an SMF. Also, the music file can not be saved. If you want to save it, please save on the same floppy disk.
01: You cannot save this data.	You can only read the music file. It can not be saved on a floppy disk or user memory.
02: Write protected.	The protect tab on the floppy disk is set to the Protect position (p. 6). Change it to the Write position. Repeat the procedure.
03: This is a master disk.	This floppy disk cannot store the format or save any data. Insert a different disk and repeat the procedure.
04: Can't save to this disk.	The data cannot be saved onto this floppy disk because the format is different. Use the floppy disk in the same format.
05: You can't overwrite this file.	A new song cannot be written on this song. Select a different song number or use a different floppy disk, and repeat the procedure.
10: No disk.	No floppy disk is connected to the disk drive. Insert the disk correctly, and repeat the procedure.
11: Disk or memory full.	There is not sufficient space left on the floppy disk or User memory for the data to be saved. Insert a different floppy disk or delete files on user memory, and repeat the procedure.
12: Disk is not formatted.	The floppy disk inserted into the disk drive can't be read. Be sure you're using Roland SMF Music Files or other music files compatible with Roland digital pianos (p. 77). Also, if you want to save your work on floppy disk, you need to format the floppy disk first (p. 41).
13: Disk ejected while it was being accessed.	The floppy disk was removed from the disk drive while reading or writing was in progress. Insert the floppy disk and repeat the procedure.
14: Corrupt sector found on disk or in memory.	This floppy disk is damaged and cannot be used. Insert a different disk and repeat the procedure.

Indication	Meaning
15: Can't read this data.	Be sure you're using Roland SMF Music Files or other music files compatible with Roland digital pianos (p. 77).
16: Playback is aborted.	The HPi-7 cannot read the floppy disk quickly enough. Press the [▶ / ■ (Play/Stop)] button, then press the [◀ (Reset)] button and [▶ / ■ (Play/Stop)] button to play the song.
17: The selected image data cannot be displayed.	The selected image data cannot be displayed. If it cannot be made to appear either on the HPi-7's display or the external display, you will need to prepare image data that can be used with the HPi-7 (p. 57).
30: Can't do this function. Memory full.	Save the song on a floppy disk (p. 42) to delete the song data stored on the HPi-7 memory.
40: Buffer full.	The HPi-7 cannot deal with the excessive MIDI data sent from the external MIDI device. Reduce the amount of MIDI data sent to the HPi-7.
41: MIDI cable disconnected.	A MIDI cable has been disconnected. Connect it properly and securely.
42: Can't record.	An excessive amount of performance data has been sent to HPi-7 in one time and therefore could not be recorded.
51: Memory error.	There is something wrong with the system. Repeat the procedure from the beginning. If it is not solved after you have tried several times, contact the Roland service center.

Tone List

Piano

NaturalGrand **
NaturalMello **
Natural Hps. **
Grand Piano1
MellowPiano1
Harpischord2
Natural Gnd2 **
MellowPiano2
NaturalC.Hps **
Grand Piano2
DetunedPiano
PianoStrings
Piano Choir
Honky-tonk
Ballad Piano
Piano Str2
Honky-tonk 2
Rock Piano
Bright Piano
UprightPiano
Mono Piano
Bell Piano
Air Grand
Piano 1
Piano 2
Piano 3

E.Piano

Pop E.Piano
Stage EP
Vibraphone
Morning Lite
70's E.Piano
Vibe Tr.
E.Piano 1
E.Piano 2
Marimba
60's EP2
Clav.
Marimba Tr.
Steel Drums
Tremolo EP
Soft E.Piano
60's E.Piano
Vibra Bells
Celesta
Xylophone
E. Grand
Jazzy Vib+Gt
MIDI Piano1
MIDI Piano2
FM+SA EP
St.FM EP
Hard FM EP
Soft Marimba
EG+E.Piano 1
EG+E.Piano 2
Hard EP2
Glockenspiel
E.Piano 3
Mild E.Piano
Music Box

Balafon
Hard E.Piano
Mild E.Grand
Hard Clav.
Soft Clav.
Reso Clav.
Phase Clav.
Analog Clav.
Pop Vibe.
Pop Celesta
Tubular-bell
Santur
Kalimba

Organ

ChurchOrgan1
Nason flt 8'
Rotary Organ
Mellow Bars
ChurchOrgan2
Jazz Organ1
Full Organ 1
Lower Organ1
Theater Org.
Bandoneon
Organ Flute
Pipe Organ 1
Pipe Organ 2
Jazz Organ2
Full Organ 2
Full Organ 3
Lower Organ2
Rock Organ1
Harmonica
Pop Organ
Accordion
BrightAccord
Trem.Flute
Jazz Organ3
Jazz Organ4
Full Organ 4
Rotary Org.S
Rotary Org.F
Rock Organ2
Organ Bass
Metalic Org.
VS Organ
Organ 1
Organ 2
Digi Church

Strings

Mellow Str
Bright Str
Strings
Slow Strings
Choir Str
Harp Strings
Violin
Cello
Warm Strings
Orchestra
Orchestra 2
Oct Strings

St. Harp
Velo Strings
Legato Str
PizzicatoStr
SlowStrings2
Bell Strings
OrchestraHit
Warm JP Str
Slow Violin
Contrabass
Timpani
DecayStrings
Syn.Strings1
Syn.Strings2
Strings 2
OB Strings
Decay Str2
Euro Hit
6th Hit
Bass Hit
Soprano Sax
Flute
Trumpet
MutedTrumpet
AltoSax + Tp
Oboe
Clarinet
TromboneSoft
Soft Brass
GS Tuba
Power Brass
St. Brass ff
English Horn
BrassSection
Blow Sax
Bright Brass
Brass ff
EX Trumpet
Grow Sax
Alto Sax
Tenor Sax
GS Bari Sax
Fr.Horn Solo
Synth Brass3
Trombone 2
Piccolo
Pan Flute
GS Pan Flute
Blow Pipe
Bottle Blow
Bassoon
Recorder
French Horn
Synth Brass1
Synth Brass2
Oct SynBrass
Shakuhachi
Brass 1
Brass 2
Ocarina

Voice

Jazz Scat
Rich Choir

Boys Choir
Glasswaves
Holy Voices
Glittery Pad
HollowReleas
Voice Oohs
Dat Accent
Bap Accent
Dat & Bap
Thum Voice
Pop Voice
Org Bells
Doos Voice
Mellow Choir
Choir Oohs
Choir Aahs
Decay Choir
Decay Pad
Warm SquPad
New Age Pad
LM PureLead
LM Square
Natural Lead
2600 SubOsc
SquareWave2
Fantasia
Crystal
Harpvox
CC Solo
Brightness
Syn.Square
JP8 Square
FM Lead 1
FM Lead 2
Mg Lead
Dual Sqr&Saw
P5 Saw Lead
Rhythmic Saw
Waspy Synth
JP8 Pulse
Cheese Saw
SynVox
Clear Bells
Soft Crystal
Digi Bells
Nylon Harp
Nylon + EP
Fantasia 2
Soft Pad
P5 Poly
Reso Saw
RAVE Vox
Fat & Perky
Heaven II
JP8 Sqr Pad
Sweep Pad 2
Big Panner
Ai-yai-a
Echo Pan 2
Falling Down
Poly King
Warm Pad
RandomEnding

Others

Nylon Guitar
Steel Guitar
Jazz Guitar
Acoustic Bs.
A.Bass+Cymb
12str Guitar
DR POP
DR ROCK
DR JAZZBRUSH
DR STANDARD
SOUND EFFECT
Nylon+Steel
Nylon Gt.o
Hawaiian Gt.
Banjo
JC E.Guitar
Muted Gt.
DistortionGt
Steel Vox
Rock Rhythm
Rock Rhythm2
Overdrive Gt
Power Guitar
Power Gt.2
Muted Dis.Gt
Wood Bass
W.Bass+Ride
Fingered Bs.
Picked Bs.
Fretless Bs.
Slap Bass
Muted Gt.2
Mellow Gt.
5th Dist.
Feedback Gt2
Synth Bass 1
Synth Bass 2
SynthBass101
Jungle Bass
Modular Bass
WireStr Bass
ResoSH Bass
SH101 Bass
Mute PickBs.
Mr.Smooth
Open Hard
Dazed Guitar
Acid Guitar
Ukulele
Koto
Shamisen
DR ROOM
DR POWER
DR ELECTRO
DR TR-808
DR DANCE
DR JAZZ
DR BRUSH
DR ORCHESTRA
DR GS STAND
DR GS ROOM
DR GS BRUSH
Piano 1

Tone List

Piano 1w	Feedback Gt.	Whistle	Wind	OverdriveGt*
Piano 1d	Gt.Harmonics	Ocarina	Stream	Dist.Guitar*
Piano 2	Gt. Feedback	Square Wave	Bubble	Gt.Harmo*
Piano 2w	GS Ac.Bass	Square	Bird	Acoustic Bs*
Piano 3	GS Fing.Bass	Sine Wave	Dog	Fingered Bs*
Piano 3w	GS Picked Bs	Saw Wave	Horse-Gallop	Picked Bs.*
GS Honkytonk	Fretless Bs.	Saw	Bird 2	Fretless Bs*
Honky-tonk 2	Slap Bass	Doctor Solo	Telephone 1	Slap Bass 1*
GS E.Piano1	Slap Bass 2	Syn.Calliope	Telephone 2	Slap Bass 2*
GS E.Piano2	SynthBass101	Chiffer Lead	DoorCreaking	Synth Bass1*
60's E.Piano	Synth Bass 1	Charang	Door	Synth Bass2*
E.Piano 1v	Synth Bass 2	Solo Vox	Scratch	Rubber Bass*
E.Piano 2v	Synth Bass 3	5th Saw Wave	Windchime	Violin*
Detuned EP 1	Synth Bass 4	Bass & Lead	Helicopter	Viola*
Detuned EP 2	Rubber Bass	Fantasia	Car-Engine	Cello*
GS Harpsi.	GS Violin	Warm Pad	Car-Stop	Contrabass*
Coupled Hps.	Slow Violin	Polysynth	Car-Pass	Tremolo Str*
Harpsi.w	Viola	Space Voice	Car-Crash	Pizzicato*
Harpsi.o	GS Cello	Bowed Glass	Siren	Harp*
Soft Clav.	Contrabass	Metal Pad	Train	Timpani*
Celesta	GS Trem.Str	Halo Pad	Jetplane	Strings*
GS Glocken	PizzicatoStr	Sweep Pad	Starship	SlowStrings*
GS Music Box	GS Harp	Ice Rain	Burst Noise	Syn.Str 1*
Vibraphone	Timpani	Soundtrack	Applause	Syn.Str 2*
Vibe.w	GS Strings	Crystal	Laughing	Choir Aahs*
GS Marimba	Orchestra	Syn Mallet	Screaming	Pop Voice*
Marimba	GS Sl.Str	Atmosphere	Punch	SynVox*
Xylophone	Syn.Strings1	Brightness	Heart Beat	Orche.Hit*
Tubular-bell	Syn.Strings2	Goblin	Footsteps	Trumpet*
Church Bell	Syn.Strings3	Echo Drops	Gun Shot	Trombone*
Carillon	Choir Aahs	Echo Bell	Machine Gun	Tuba*
GS Santur	Choir	Echo Pan	Lasergun	M.Trumpet*
Organ 1	Pop Voice	Star Theme	Explosion	FrenchHorns*
Organ 2	SynVox	Sitar	Piano 1*	Brass 1*
Pop Organ 1	OrchestraHit	Sitar 2	Piano 2*	SynthBrass1*
Detuned Or.1	GS Trumpet	Banjo	Piano 3*	SynthBrass2*
Detuned Or.2	GS Trombone	GS Shamisen	Honky-tonk*	A.Brass 1*
GS ChurchOr1	Trombone 2	Koto	E.Piano 1*	Soprano Sax*
GS ChurchOr2	GS Tuba	Taisho Koto	E.Piano 2*	Alto Sax*
Church Org.3	MutedTrumpet	Kalimba	Harpsichord*	Tenor Sax*
Full Organ 4	French Horn	Bagpipe	Clav.*	BaritoneSax*
Jazz Organ1	Fr.Horn 2	Fiddle	Celesta*	Oboe*
Rock Organ2	Brass 1	Shanai	Glocken*	EnglishHorn*
Reed Organ	Brass 2	Tinkle Bell	Music Box*	Bassoon*
Accordion Fr	Synth Brass1	Agogo	Vibraphone*	Clarinet*
Accordion It	Synth Brass2	Steel Drums	Marimba*	Piccolo*
GS Harmonica	Synth Brass3	Woodblock	Xylophone*	Flute*
Bandoneon	Synth Brass4	Castanets	Tubularbell*	Recorder*
GS Nylon Gt.	AnalogBrass1	Taiko	Santur*	Pan Flute*
Nylon Guitar	AnalogBrass2	Concert BD	Organ 1*	Bottle Blow*
Nylon Gt.o	GS Sop.Sax	Melo. Tom 1	Organ 2*	Shakuhachi*
Ukulele	Alto Sax	Melo. Tom 2	Pop Organ 1*	Whistle*
Steel-str.Gt	Tenor Sax	Synth Drum	Rock Organ2*	Ocarina*
12-str.Gt	GS Bari Sax	808 Tom	ChurchOrg.1*	Square Wave*
GS Mandolin	GS Oboe	Elec Perc.	Reed Organ*	Saw Wave*
Jazz Guitar	GS Eng.Horn	Reverse Cym.	AccordionFr*	Doctor Solo*
GS Hawaiian	Bassoon	Gt.FretNoise	Harmonica*	SynCalliope*
Clean Gt.	Clarinet	Gt.Cut Noise	Bandoneon*	ChifferLead*
Chorus Gt.	Piccolo	String Slap	Nylon-strGt*	Charang*
Muted Gt.	GS Flute	Breath Noise	Steel-strGt*	Solo Vox*
Funk Gt.	Recorder	Fl.Key Click	Jazz Guitar*	5th SawWave*
Funk Gt.2	GS Pan Flute	Seashore	Clean Gt.*	Bass & Lead*
Overdrive Gt	GS BottleBlw	Rain	Muted Gt.*	Fantasia*
GS Dist.Gt	Shakuhachi	Thunder	Funk Gt.*	Warm Pad*

Polysynth*
 Space Voice*
 Bowed Glass*
 Metal Pad*
 Halo Pad*
 Sweep Pad*
 Ice Rain*
 Soundtrack*
 Crystal*
 Syn Mallet*
 Atmosphere*
 Brightness*
 Goblin*
 Echo Drops*
 Star Theme*
 Sitar*
 Banjo*
 Shamisen*
 Koto*
 Kalimba*
 Bagpipe*
 Fiddle*
 Shanai*
 Tinkle Bell*
 Agogo*
 Steel Drums*
 Woodblock*
 Taiko*
 Melo.Tom 1*
 Synth Drum*
 ReverseCym.*
 Fret Noise*
 BreathNoise*
 Seashore*
 Bird*
 Telephone 1*
 Helicopter*
 Applause*
 Gun Shot*

- * Tone with a "*" symbol appended to their name may not play back satisfactorily on other GS sound generating devices.
- * Tone with a "***" symbol appended to their name may produce the Key Off sound (reproduces the tonal change produced when the fingers are released from the keys).

SFX Set

- * ----: No sound.
- * [EXC]: will not sound simultaneously with other percussion instruments of the same number.

SOUND EFFECT	
21	----
22	----
23	----
24	----
25	----
26	----
27	----
28	----
29	----
30	----
31	----
32	----
33	----
34	----
35	----
C2 36	----
37	----
38	----
39	High Q
40	Slap
41	Scratch Push [EXC7]
42	Scratch Pull [EXC7]
43	Sticks
44	Square Click
45	Metronome Click
46	Metronome Bell
47	Guitar sliding Finger
C3 48	Guitar cutting noise (up)
49	Guitar cutting noise (down)
50	String slap of double bass
51	Fl.Key Click
52	Laughing
53	Screaming
54	Punch
55	Heart Beat
56	Footsteps1
57	Footsteps2
58	Applause
59	Door Creaking
C4 60	Door
61	Scratch
62	Wind Chimes
63	Car-Engine
64	Car-Stop
65	Car-Pass
66	Car-Crash
67	Siren
68	Train
69	Jetplane
70	Helicopter
71	Starship
C5 72	Gun Shot
73	Machine Gun
74	Lasergun
75	Explosion
76	Dog
77	Horse-Gallop
78	Birds
79	Rain
80	Thunder
81	Wind
82	Seashore
83	Stream
C6 84	Bubble
85	Cat
86	Bird
87	BabyLaughing
88	Boeeseen
89	Glass & Glam
90	Ice Ring
91	Crack Bottle
92	Pour Bottle
93	Car Horn
94	R.Crossing
95	SL 1
C7 96	SL 2
97	Seal
98	Fancy Animal
99	Elephant
100	Bike
101	----
102	Applause
103	----
104	----
105	----

Drum Set List

* -----: No sound.

* [EXC]: will not sound simultaneously with other percussion instruments of the same number.

	DR POP	DR ROCK	DR JAZZBRUSH
21	R&B Snare	R&B Snare	R&B Snare
22	Rock Snare	Pop Snare m	Pop Snare m
23	Rock Snare	Pop Snare m	Pop Snare m
24	Pop Snare m	Pop Snare m	Pop Snare m
25	Pop Snare Ghost	Pop Snare Ghost	Pop Snare Ghost
26	Pop Snare m	Pop Snare m	Pop Snare m
27	Finger Snap	Finger Snap	Finger Snap
28	707 Claps	707 Claps	707 Claps
29	Hand Clap [EXC7]	Hand Clap [EXC7]	Hand Clap [EXC7]
30	Hand Clap2 [EXC7]	Hand Clap2 [EXC7]	Hand Clap2 [EXC7]
31	Hand Clap	Hand Clap	Hand Clap
32	Pop Pedal HH [EXC1]	Pop Pedal HH [EXC1]	Pop Pedal HH [EXC1]
33	Gospel Hand Clap	Gospel Hand Clap	Gospel Hand Clap
34	Snare Roll	Snare Roll	Snare Roll
35	Pop Kick	Rock Kick	Pop Kick
C2 36	Pop Kick	Rock Kick	Pop Kick
37	Pop Side Stick	Rock Side Stick	Jazz Snare Swing
38	Pop Sanre s	Rock Sanre s	Jazz Sanre
39	Pop Snare Ghost	Rock Snare Ghost	Pop Snare Swing
40	Pop Snare s	Rock Snare s	Jazz Sanre
41	Pop Low Tom f	Rock Low Tom f	Jazz Low Tom f
42	Pop CHH 1 [EXC1]	Rock CHH 1 [EXC1]	Pop CHH 1 [EXC1]
43	Pop Low Tom	Rock Low Tom	Jazz Low Tom
44	Pop CHH 2 [EXC1]	Rock CHH 2 [EXC1]	Pop CHH 2 [EXC1]
45	Pop Mid Tom f	Rock Mid Tom f	Jazz Mid Tom f
46	Pop OHH [EXC1]	Rock OHH [EXC1]	Pop OHH [EXC1]
47	Pop Mid Tom	Rock Mid Tom	Jazz Mid Tom
C3 48	Pop High Tom f	Rock High Tom f	Jazz High Tom f
49	Pop Crash Cymbal 1	Rock Crash Cymbal	Jazz Crash Cymbal 1
50	Pop High Tom	Rock High Tom	Jazz High Tom
51	Pop Ride Cymbal 1	Rock Ride Cymbal 1	Jazz Ride Cymbal 1
52	Pop Chinees Cymbal	Pop Chinees Cymbal	Jazz Chinees Cymbal
53	Pop Ride Bell	Pop Ride Bell	Jazz Ride Cymbal 2
54	Tambourine 2	Tambourine 2	Tambourine 2
55	Splash Cymbal	Splash Cymbal	Splash Cymbal
56	Cha Cha Cowbell	Cha Cha Cowbell	Cha Cha Cowbell
57	Pop Crash Cymbal 2	Chinees Cymbal	Jazz Crash Cymbal 2
58	Vibra-slap 2	Vibra-slap 2	Vibra-slap 2
59	Pop Ride Cymbal 2	Pop Ride Cymbal 3	Pop Ride Cymbal 2
C4 60	High Bongo 2	High Bongo 2	High Bongo 2
61	Low Bongo 2	Low Bongo 2	Low Bongo 2
62	Mute Conga	Mute Conga	Mute Conga
63	High Conga 2	High Conga 2	High Conga 2
64	Low Conga 2	Low Conga 2	Low Conga 2
65	High Timbale 2	High Timbale 2	High Timbale 2
66	Low Timbale 2	Low Timbale 2	Low Timbale 2
67	High Agogo	High Agogo	High Agogo
68	Low Agogo	Low Agogo	Low Agogo
69	Shaker 3	Shaker 3	Shaker 3
70	Shaker 4	Shaker 4	Shaker 4
71	Short Hi Whistle [EXC2]	Short Hi Whistle [EXC2]	Short Hi Whistle [EXC2]
C5 72	Long Low Whistle [EXC2]	Long Low Whistle [EXC2]	Long Low Whistle [EXC2]
73	Short Guiro [EXC3]	Short Guiro [EXC3]	Short Guiro [EXC3]
74	Long Guiro [EXC3]	Long Guiro [EXC3]	Long Guiro [EXC3]
75	Claves	Claves	Claves
76	High Wood Block	High Wood Block	High Wood Block
77	Low Wood Block	Low Wood Block	Low Wood Block
78	Mute Cuica [EXC4]	Mute Cuica [EXC4]	Mute Cuica [EXC4]
79	Open Cuica [EXC4]	Open Cuica [EXC4]	Open Cuica [EXC4]
80	Mute Triangle [EXC5]	Mute Triangle [EXC5]	Mute Triangle [EXC5]
81	Open Triangle [EXC5]	Open Triangle [EXC5]	Open Triangle [EXC5]
82	Shaker	Shaker	Shaker
83	Jingle Bell	Jingle Bell	Jingle Bell
C6 84	Bell Tree	Bell Tree	Bell Tree
85	Castanets	Castanets	Castanets
86	Mute Surdo [EXC6]	Mute Surdo [EXC6]	Mute Surdo [EXC6]
87	Open Surdo [EXC6]	Open Surdo [EXC6]	Open Surdo [EXC6]
88	Cana	Cana	Cana
89	Falamenco Hi-Timbale	Falamenco Hi-Timbale	Falamenco Hi-Timbale
90	Falamenco Lo-Timbale	Falamenco Lo-Timbale	Falamenco Lo-Timbale
91	Falamenco Tmbl Flam	Falamenco Tmbl Flam	Falamenco Tmbl Flam
92	Shekere 1	Shekere 1	Shekere 1
93	Shekere 2	Shekere 2	Shekere 2
94	Low Bongo Mute	Low Bongo Mute	Low Bongo Mute
95	High Bongo Mute	High Bongo Mute	High Bongo Mute
C7 96	-----	-----	-----
97	-----	-----	-----
98	-----	-----	-----
99	-----	-----	-----
100	Falamenco HC	Falamenco HC	Falamenco HC
101	Falamenco HC	Falamenco HC	Falamenco HC
102	Bongo Cowbell	Bongo Cowbell	Bongo Cowbell
103	-----	-----	-----
104	Bongo Cowbell	Bongo Cowbell	Bongo Cowbell
105	-----	-----	-----

Drum Set List

* -----: No sound.

* [EXC]: will not sound simultaneously with other percussion instruments of the same number.

	DR STANDARD	DR ROOM	DR POWER	DR ELECTRONIC
21	-----	-----	-----	-----
22	-----	-----	-----	-----
23	-----	-----	-----	-----
24	Bar Chime	Bar Chime	Bar Chime	Bar Chime
25	Snare Roll	Snare Roll	Snare Roll	Snare Roll
26	Finger Snap	Finger Snap	Finger Snap	Finger Snap
27	High Q	High Q	High Q	High Q
28	Slap	Slap	Slap	Slap
29	Scratch Push [EXC7]	Scratch Push [EXC7]	Scratch Push [EXC7]	Scratch Push [EXC7]
30	Scratch Pull [EXC7]	Scratch Pull [EXC7]	Scratch Pull [EXC7]	Scratch Pull [EXC7]
31	Sticks	Sticks	Sticks	Sticks
32	Square Click	Square Click	Square Click	Square Click
33	Metronome Click	Metronome Click	Metronome Click	Metronome Click
34	Metronome Bell	Metronome Bell	Metronome Bell	Metronome Bell
35	Std Kick 2'	Kick1	Std Kick 2'	Std Kick 2'
C2 36	Kick 1	Room Kick	MONDO Kick	Elec BD
37	Side Stick	Side Stick	Side Stick	Side Stick
38	Std Snr 1	Room Snr 1	Gated SD	Elec SD
39	Hand Clap	Hand Clap	Hand Clap	Hand Clap
40	Std Snr 2	Std Snr 1	Snare Drum 2	Gated SD
41	Low Tom 2	Room Low Tom 2'	Room Low Tom 2	Elec Low Tom 2
42	Closed Hi-hat 1' [EXC1]	Closed Hi-hat 1' [EXC1]	Closed Hi-hat 1 [EXC1]	Closed Hi-hat 1 [EXC1]
43	Low Tom 1	Room Low Tom 1'	Room Low Tom 1	Elec Low Tom 1
44	Pedal Hi-hat 1' [EXC1]	Pedal Hi-hat 1' [EXC1]	Pedal Hi-hat 1 [EXC1]	Pedal Hi-hat 1 [EXC1]
45	Mid Tom 2	Room Mid Tom 2'	Room Mid Tom 2	Elec Mid Tom 2
46	Open Hi-hat 1' [EXC1]	Open Hi-hat 1' [EXC1]	Open Hi-hat 1 [EXC1]	Open Hi-hat 1 [EXC1]
47	Mid Tom 1	Room Mid Tom 1'	Room Mid Tom 1	Elec Mid Tom 1
C3 48	High Tom 2	Room Hi Tom 2'	Room Hi Tom 2	Elec Hi Tom 2
49	Crash Cymbal 1	Crash Cymbal 1	Crash Cymbal 1	Crash Cymbal 1
50	High Tom 1	Room Hi Tom 1'	Room Hi Tom 1	Elec Hi Tom 1
51	Ride Cymbal 1	Ride Cymbal 1	Ride Cymbal 1	Ride Cymbal 1
52	Chinese Cymbal	Chinese Cymbal	Chinese Cymbal	Reverse Cymbal
53	Ride Bell	Ride Bell	Ride Bell	Ride Bell
54	Tambourine	Tambourine	Tambourine	Tambourine
55	Splash Cymbal	Splash Cymbal	Splash Cymbal	Splash Cymbal
56	Cowbell	Cowbell	Cowbell	Cowbell
57	Crash Cymbal 2	Crash Cymbal 2	Crash Cymbal 2	Crash Cymbal 2
58	Vibra-slap	Vibra-slap	Vibra-slap	Vibra-slap
59	Ride Cymbal 2	Ride Cymbal 2	Ride Cymbal 2	Ride Cymbal 2
C4 60	High Bongo	High Bongo	High Bongo	High Bongo
61	Low Bongo	Low Bongo	Low Bongo	Low Bongo
62	Mute High Conga	Mute High Conga	Mute High Conga	Mute High Conga
63	Open High Conga	Open High Conga	Open High Conga	Open High Conga
64	Low Conga	Low Conga	Low Conga	Low Conga
65	High Timbale	High Timbale	High Timbale	High Timbale
66	Low Timbale	Low Timbale	Low Timbale	Low Timbale
67	High Agogo	High Agogo	High Agogo	High Agogo
68	Low Agogo	Low Agogo	Low Agogo	Low Agogo
69	Cabasa	Cabasa	Cabasa	Cabasa
70	Maracas	Maracas	Maracas	Maracas
71	Short Hi Whistle [EXC2]	Short Hi Whistle [EXC2]	Short Hi Whistle [EXC2]	Short Hi Whistle [EXC2]
C5 72	Long Low Whistle [EXC2]	Long Low Whistle [EXC2]	Long Low Whistle [EXC2]	Long Low Whistle [EXC2]
73	Short Guiro [EXC3]	Short Guiro [EXC3]	Short Guiro [EXC3]	Short Guiro [EXC3]
74	Long Guiro [EXC3]	Long Guiro [EXC3]	Long Guiro [EXC3]	Long Guiro [EXC3]
75	Claves	Claves	Claves	Claves
76	High Wood Block	High Wood Block	High Wood Block	High Wood Block
77	Low Wood Block	Low Wood Block	Low Wood Block	Low Wood Block
78	Mute Cuica [EXC4]	Mute Cuica [EXC4]	Mute Cuica [EXC4]	Mute Cuica [EXC4]
79	Open Cuica [EXC4]	Open Cuica [EXC4]	Open Cuica [EXC4]	Open Cuica [EXC4]
80	Mute Triangle [EXC5]	Mute Triangle [EXC5]	Mute Triangle [EXC5]	Mute Triangle [EXC5]
81	Open Triangle [EXC5]	Open Triangle [EXC5]	Open Triangle [EXC5]	Open Triangle [EXC5]
82	Shaker	Shaker	Shaker	Shaker
83	Jingle Bell	Jingle Bell	Jingle Bell	Jingle Bell
C6 84	Bell Tree	Bell Tree	Bell Tree	Bell Tree
85	Castanets	Castanets	Castanets	Castanets
86	Mute Surdo [EXC6]	Mute Surdo [EXC6]	Mute Surdo [EXC6]	Mute Surdo [EXC6]
87	Open Surdo [EXC6]	Open Surdo [EXC6]	Open Surdo [EXC6]	Open Surdo [EXC6]
88	-----	-----	-----	-----

Drum Set List

* -----: No sound.

* [EXC]: will not sound simultaneously with other percussion instruments of the same number.

	DR TR-808	DR DANCE	DR JAZZ DR GS STAND	DR BRUSH
21	-----	-----	-----	-----
22	-----	-----	-----	-----
23	-----	-----	-----	-----
24	Bar Chime	Bar Chime	Bar Chime	Bar Chime
25	Snare Roll	Snare Roll	Snare Roll	Snare Roll
26	Finger Snap	Finger Snap	Finger Snap	Finger Snap
27	High Q	High Q	High Q	High Q
28	Slap	Slap	Slap	Slap
29	Scratch Push [EXC7]	Scratch Push [EXC7]	Scratch Push [EXC7]	Scratch Push [EXC7]
30	Scratch Pull [EXC7]	Scratch Pull [EXC7]	Scratch Pull [EXC7]	Scratch Pull [EXC7]
31	Sticks	Dance Snr 1	Sticks	Sticks
32	Square Click	Square Click	Square Click	Square Click
33	Metronome Click	Metronome Click	Metronome Click	Metronome Click
34	Metronome Bell	Metronome Bell	Metronome Bell	Metronome Bell
35	Std Kick 2	Kick 1	Std Kick 2	Kick 2
C2 36	808 Bass Drum 1	808 Bass Drum 2	Std Kick 1	Kick 1
37	808 Rim Shot	808 Rim Shot	Side Stick	Side Stick
38	808 Snare Drum	TR-909 Snr	Snare Drum 1	Brush Tap
39	Hand Clap	Hand Clap	Hand Clap	Brush Slap
40	Snare Drum 2	Dance Snr 2	Snare Drum 2	Brush Swirl
41	808 Low Tom 2	808 Low Tom 2	Low Tom 2	Brush Low Tom 2
42	808 CHH [EXC1]	808 CHH [EXC1]	Closed Hi-hat 1 [EXC1]	Closed Hi-hat 2 [EXC1]
43	808 Low Tom 1	808 Low Tom 1	Low Tom 1	Brush Low Tom 1
44	808 CHH [EXC1]	808 CHH [EXC1]	Pedal Hi-hat 1 [EXC1]	Pedal Hi-hat 2 [EXC1]
45	808 Mid Tom 2	808 Mid Tom 2	Mid Tom 2	Brush Mid Tom 2
46	808 OHH [EXC1]	808 OHH [EXC1]	Open Hi-hat 1 [EXC1]	Open Hi-hat 2 [EXC1]
47	808 Mid Tom 1	808 Mid Tom 1	Mid Tom 1	Brush Mid Tom 1
C3 48	808 Hi Tom 2	808 Hi Tom 2	High Tom 2	Brush Hi Tom 2
49	808 Cymbal	808 Cymbal	Crash Cymbal 1	Crash Cymbal 1
50	808 Hi Tom 1	808 Hi Tom 1	High Tom 1	Brush Hi Tom 1
51	Ride Cymbal 1	Ride Cymbal 1	Ride Cymbal 1	Ride Cymbal 1
52	Chinese Cymbal	Chinese Cymbal	Chinese Cymbal	Chinese Cymbal
53	Ride Bell	Ride Bell	Ride Bell	Ride Bell
54	Tambourine	Tambourine	Tambourine	Tambourine
55	Splash Cymbal	Splash Cymbal	Splash Cymbal	Splash Cymbal
56	808 Cowbell	808 Cowbell	Cowbell	Cowbell
57	Crash Cymbal 2	Crash Cymbal 2	Crash Cymbal 2	Crash Cymbal 2
58	Vibra-slap	Vibra-slap	Vibra-slap	Vibra-slap
59	Ride Cymbal 2	Ride Cymbal 2	Ride Cymbal 2	Ride Cymbal 2
C4 60	High Bongo	High Bongo	High Bongo	High Bongo
61	Low Bongo	Low Bongo	Low Bongo	Low Bongo
62	808 High Conga	808 High Conga	Mute High Conga	Mute High Conga
63	808 Mid Conga	808 Mid Conga	Open High Conga	Open High Conga
64	808 Low Conga	808 Low Conga	Low Conga	Low Conga
65	High Timbale	High Timbale	High Timbale	High Timbale
66	Low Timbale	Low Timbale	Low Timbale	Low Timbale
67	High Agogo	High Agogo	High Agogo	High Agogo
68	Low Agogo	Low Agogo	Low Agogo	Low Agogo
69	Cabasa	Cabasa	Cabasa	Cabasa
70	808 Maracas	808 Maracas	Maracas	Maracas
71	Short Hi Whistle [EXC2]	Short Hi Whistle [EXC2]	Short Hi Whistle [EXC2]	Short Hi Whistle [EXC2]
C5 72	Long Low Whistle [EXC2]	Long Low Whistle [EXC2]	Long Low Whistle [EXC2]	Long Low Whistle [EXC2]
73	Short Guiro [EXC3]	Short Guiro [EXC3]	Short Guiro [EXC3]	Short Guiro [EXC3]
74	Long Guiro [EXC3]	Long Guiro [EXC3]	Long Guiro [EXC3]	Long Guiro [EXC3]
75	808 Claves	808 Claves	Claves	Claves
76	High Wood Block	High Wood Block	High Wood Block	High Wood Block
77	Low Wood Block	Low Wood Block	Low Wood Block	Low Wood Block
78	Mute Cuica [EXC4]	Mute Cuica [EXC4]	Mute Cuica [EXC4]	Mute Cuica [EXC4]
79	Open Cuica [EXC4]	Open Cuica [EXC4]	Open Cuica [EXC4]	Open Cuica [EXC4]
80	Mute Triangle [EXC5]	Mute Triangle [EXC5]	Mute Triangle [EXC5]	Mute Triangle [EXC5]
81	Open Triangle [EXC5]	Open Triangle [EXC5]	Open Triangle [EXC5]	Open Triangle [EXC5]
82	Shaker	Shaker	Shaker	Shaker
83	Jingle Bell	Jingle Bell	Jingle Bell	Jingle Bell
C6 84	Bell Tree	Bell Tree	Bell Tree	Bell Tree
85	Castanets	Castanets	Castanets	Castanets
86	Mute Surdo [EXC6]	Mute Surdo [EXC6]	Mute Surdo [EXC6]	Mute Surdo [EXC6]
87	Open Surdo [EXC6]	Open Surdo [EXC6]	Open Surdo [EXC6]	Open Surdo [EXC6]
88	-----	-----	-----	-----

Drum Set List

* -----: No sound.









































































* [EXC]: will not sound simultaneously with other percussion instruments of the same number.

	DR ORCHESTRA	DR GS ROOM	DR GS BRUSH
21	-----	-----	-----
22	-----	-----	-----
23	-----	-----	-----
24	Bar Chime	Bar Chime	Bar Chime
25	Snare Roll	Snare Roll	Snare Roll
26	Finger Snap	Finger Snap	Finger Snap
27	Close Hi-hat [EXC1]	High Q	High Q
28	Pedal Hi-hat [EXC1]	Slap	Slap
29	Open Hi-hat [EXC1]	Scratch Push [EXC7]	Scratch Push [EXC7]
30	Ride Cymbal	Scratch Pull [EXC7]	Scratch Pull [EXC7]
31	Sticks	Sticks	Sticks
32	Square Click	Square Click	Square Click
33	Metronome Click	Metronome Click	Metronome Click
34	Metronome Bell	Metronome Bell	Metronome Bell
35	Concert BD 2	Std Kick 2	Std Kick 2
C2 36	Concert BD 1	Std Kick 1	Std Kick 1
37	Side Stick	Side Stick	Side Stick
38	Concert SD	Snare Drum 1	Brush Tap
39	Castanets	Hand Clap	Brush Slap
40	Concert SD	Snare Drum 2	Brush Swirl
41	Timpani F	Room Low Tom 2	Low Tom 2
42	Timpani F#	Closed Hi-hat 1 [EXC1]	Closed Hi-hat 1 [EXC1]
43	Timpani G	Room Low Tom 1	Low Tom 1
44	Timpani G#	Pedal Hi-hat 1 [EXC1]	Pedal Hi-hat 1 [EXC1]
45	Timpani A	Room Mid Tom 2	Mid Tom 2
46	Timpani A#	Open Hi-hat 1 [EXC1]	Open Hi-hat 1 [EXC1]
47	Timpani B	Room Mid Tom 1	Mid Tom 1
C3 48	Timpani c	Room Hi Tom 2	High Tom 2
49	Timpani c#	Crash Cymbal 1	Crash Cymbal 1
50	Timpani d	Room Hi Tom 1	High Tom 1
51	Timpani d#	Ride Cymbal 1	Ride Cymbal 1
52	Timpani e	Chinese Cymbal	Chinese Cymbal
53	Timpani f	Ride Bell	Ride Bell
54	Tambourine	Tambourine	Tambourine
55	Splash Cymbal	Splash Cymbal	Splash Cymbal
56	Cowbell	Cowbell	Cowbell
57	Concert Cymbal 2	Crash Cymbal 2	Crash Cymbal 2
58	Vibra-slap	Vibra-slap	Vibra-slap
59	Concert Cymbal 1	Ride Cymbal 2	Ride Cymbal 2
C4 60	High Bongo	High Bongo	High Bongo
61	Low Bongo	Low Bongo	Low Bongo
62	Mute High Conga	Mute High Conga	Mute High Conga
63	Open High Conga	Open High Conga	Open High Conga
64	Low Conga	Low Conga	Low Conga
65	High Timbale	High Timbale	High Timbale
66	Low Timbale	Low Timbale	Low Timbale
67	High Agogo	High Agogo	High Agogo
68	Low Agogo	Low Agogo	Low Agogo
69	Cabasa	Cabasa	Cabasa
70	Maracas	Maracas	Maracas
71	Short Hi Whistle [EXC2]	Short Hi Whistle [EXC2]	Short Hi Whistle [EXC2]
C5 72	Long Low Whistle [EXC2]	Long Low Whistle [EXC2]	Long Low Whistle [EXC2]
73	Short Guiro [EXC3]	Short Guiro [EXC3]	Short Guiro [EXC3]
74	Long Guiro [EXC3]	Long Guiro [EXC3]	Long Guiro [EXC3]
75	Claves	Claves	Claves
76	High Wood Block	High Wood Block	High Wood Block
77	Low Wood Block	Low Wood Block	Low Wood Block
78	Mute Cuica [EXC4]	Mute Cuica [EXC4]	Mute Cuica [EXC4]
79	Open Cuica [EXC4]	Open Cuica [EXC4]	Open Cuica [EXC4]
80	Mute Triangle [EXC5]	Mute Triangle [EXC5]	Mute Triangle [EXC5]
81	Open Triangle [EXC5]	Open Triangle [EXC5]	Open Triangle [EXC5]
82	Shaker	Shaker	Shaker
83	Jingle Bell	Jingle Bell	Jingle Bell
C6 84	Bell Tree	Bell Tree	Bell Tree
85	Castanets	Castanets	Castanets
86	Mute Surdo [EXC6]	Mute Surdo [EXC6]	Mute Surdo [EXC6]
87	Open Surdo [EXC6]	Open Surdo [EXC6]	Open Surdo [EXC6]
88	Applause	-----	-----

Chord List

● symbol: Indicates the constituent note of chords.

★ symbol: Chord shown with an "★" can be played by pressing just the key marked with the "★."

C 	C# 	D 	E\flat 	E 	F 
Cmaj7 	C#maj7 	Dmaj7 	E\flat maj7 	Emaj7 	Fmaj7 
C7 	C#7 	D7 	E\flat 7 	E7 	F7 
Cm 	C#m 	Dm 	E\flat m 	Em 	Fm 
Cm7 	C#m7 	Dm7 	E\flat m7 	Em7 	Fm7 
Cdim 	C#dim 	Ddim 	E\flat dim 	Edim 	Fdim 
F# 	G 	A\flat 	A 	B\flat 	B 
F#maj7 	Gmaj7 	A\flat maj7 	Amaj7 	B\flat maj7 	Bmaj7 
F#7 	G7 	A\flat 7 	A7 	B\flat 7 	B7 
F#m 	Gm 	A\flat m 	Am 	B\flat m 	Bm 
F#m7 	Gm7 	A\flat m7 	Am7 	B\flat m7 	Bm7 
F#dim 	Gdim 	A\flat dim 	Adim 	B\flat dim 	Bdim 

Internal Song List

- All rights reserved. Unauthorized use of this material for purposes other than private, personal enjoyment is a violation of applicable laws.

Practice	
1	Openness
2	Arabesque
3	Pastoral
4	A Small Gathering
5	Innocence
6	Progress
7	The Clear Stream
8	Gracefulness
9	The Hunt
10	Tender Flower
11	The Young Shepherdess
12	Farewell
13	Consolation
14	Austrian Dance
15	Ballad
16	Sighing
17	The Chatterbox
18	Restlessness
19	Ave Maria
20	Tarantella
21	Angelic Harmony
22	Gondola Song
23	The Return
24	The Swallow
25	The Knight Errant
26	Invention 1
27	Invention 2
28	Invention 3
29	Invention 4
30	Invention 5
31	Invention 6
32	Invention 7
33	Invention 8
34	Invention 9
35	Invention 10
36	Invention 11
37	Invention 12
38	Invention 13
39	Invention 14
40	Invention 15
41	Beyer 15
42	Beyer 21
43	Beyer 25
44	Beyer 29
45	Beyer 34
46	Beyer 38
47	Beyer 42
48	Beyer 46
49	Beyer 51
50	Beyer 55
51	Beyer 60
52	Beyer 64
53	Beyer 67
54	Beyer 73
55	Beyer 78
56	Beyer 81
57	Beyer 90
58	Beyer 93
59	Beyer 98
60	Beyer 103
61	Czerny 100-1
62	Czerny 100-10

63	Czerny 100-20
64	Czerny 100-30
65	Czerny 100-38
66	Czerny 100-43
67	Czerny 100-60
68	Czerny 100-75
69	Czerny 100-86
70	Czerny 100-96
71	Old MacDonald Had A Farm
72	Puppy's March
73	Twinkle Twinkle, Little Star
74	Frog Song
75	Little Fox
76	Jingle Bells
77	Lightly Row
78	The Cuckoo
79	Mary Had A Little Lamb
80	London Bridge
81	Joy To The World

Masterpieces	
1	Sonate fur Klavier No. 15
2	Liebestraume III
3	Etude, op.10-3
4	Je te veux
5	Valse, op.64-1
6	Golliwog's Cake walk
7	Fantaisie-Impromptu
8	Alabesque 1
9	An der schonen, blauen Donau
10	Auf Flugeln des Gesanges
11	Mazurka No.5
12	1ere Gymnopedie
13	Etude, op.25-1
14	Clair de Lune
15	Etude, op.10-5
16	Doctor Gradus ad Parnassum
17	Grande Valse Brillante
18	La priere d'une Vierge
19	Course en Troika
20	To The Spring
21	Valse, op.64-2
22	Radetzky Marsch
23	Traumerei
24	Moments Musicaux III
25	Prelude, op.28-15
26	The harmonious blacksmith
27	Ungarische Tanze V
28	Turkischer Marsch (Beethoven)
29	Nocturne No.2
30	Fruhlingslied
31	Praludium
32	Jagerlied
33	Menuet Antique
34	Fur Elise
35	Turkischer Marsch (Mozart)
36	Standchen
37	Humoreske
38	Blumenlied
39	Alpenglockchen
40	Menuett G dur (Beethoven)
41	Venezianisches Gondellied
42	Alpenabendrote
43	Farewell to the Piano

44	Brautchor
45	Battle of Waterloo
46	Wiener Marsch
47	Le Coucou
48	Menuett G dur (Bach)
49	Spinnerlied
50	Gavotte
51	Heidenroslein
52	Zigeuner Tanz
53	La Cinquantaine
54	Csikos Post
55	Dolly's Dreaming Awakening
56	La Violette
57	Frohlicher Landmann
58	Sonatine op.36-1 (Clementi)
59	Sonatine op.20-1 (Kuhlau)
60	Sonatine No.5 (Beethoven)

Popular	
1	Canon (Pachelbel)
2	Ombra maifu
3	Les patineurs, Valse
4	Brindisi
5	Die Lorelei
6	Entertainer
7	Annie Laurie
8	O'sole Mio
9	Grandfather's Clock
10	Ave Maria
11	Greensleeves
12	Hallelujah!
13	Stagecoach
14	Little Brown Jug
15	Amazing Grace
16	Londonderry Air
17	Silent Night, Holy Night
18	When The Saints Go Marchin' In
19	Preludelight *
20	Blue Sky Rag *
21	Late Night Chopin *
22	Sun Daze *
23	Keepers Tale *
24	Secret Agent *
25	Kismet's Salsa *
26	Roll Over Ludwig *
27	A Prelude To... *
28	Count On The Blues *
29	One Down And Easy *
30	Bach's A Boppin' *
31	From Matthew's Passion *
32	Hungarian Rag *
33	Paganini Boogie *
34	Fly Free *

- * Song with a "*" symbol appended to their name may not allow output of their notations as image data in BMP (bitmap) format.

Pianist Style List

Songs for Visual Lesson

Beginner's Course

Mary Had A Little Lamb
Come Birds
The Cuckoo
Old MacDonald Had A Farm
London Bridge
Oh! Susanna
Sonata (Mozart)
Aura Lee
Pathetique
Amazing Grace

Repertoire Course

Traumerei
Trepak
Canon (Pachelbel)
I've Been Working On The Railroad
Silent Night, Holy Night
Clair De Lune
La Primavera
Grandfather's Clock
Eine Kleine Nachtmusik
Gymnopedie 1

Challenge Course

Hanon
Burgmuller
Beethoven
Chopin
Fast Play
Finger Technique
Chord
American Folk Song
Screen Music
Jazz

Pianist Style List

Piano Pop
Jazz Club
EnglishWaltz
Kids Shuffle
'70s Dance
PianoClasic1
'70s Pop
Piano Night
Fast Waltz
MarchingBand
Slow 8-Beat
PianoClasic2
Ballad Pop
Piano Ballad
MidBossa Nova
PianoShuffle
Pop Rock
Piano Polka
Light Pops
'50s Ballad
Piano Latin
P.Swing Pop
P.Gospel
P.Concerto 1
P.Pop
P.Swing
P.Slow Waltz
P.Ragtime
P.Rock'nRoll
P.Concerto 2
P.Ballad
P.Stride
P.Bossa Nova
P.Shuffle
P.'50s Rock

Music Files That the HPi-7 Can Use

What Are Music Files?

Music Files contain information describing the details of a musical performance, such as “the C3 key on a keyboard was pressed for this amount of time, using this amount of force.” By inserting the floppy disk into the disk drive on the HP, the performance information is sent from the floppy disk to the piano, and played faithfully by the piano. This is different than a CD, since the music file does not contain a recording of the sound itself. This makes it possible to erase certain parts, or to change instruments, tempos and keys freely, allowing you to use it in many different ways.

Regarding Copyright

Use of the song data supplied with the Data Disk attached to this product for any purpose other than private, personal enjoyment without the permission of the copyright holder is prohibited by law. Additionally, this data must not be copied, nor used in a secondary copyrighted work without the permission of the copyright holder.

■ The HPi-7 allows you to use the following music files

- Floppy disks saved on a Roland MT Series, or Roland Piano Digital HP-G/R/i and KR Series instrument
 - Roland Digital Piano Compatible Music Files
Roland’s original music file is made specifically for practicing the piano. Some follow an instructional curriculum, allowing for a complete range of lessons, such as “practicing each hand separately” or “listening to only the accompaniment.”
 - SMF Music Files (720KB/1.44MB format)
SMFs (Standard MIDI Files) use a standard format for music file that was formulated so that files containing music file could be widely compatible, regardless of the manufacturer of the listening device. An enormous variety of music is available, whether it be for listening, for practicing musical instruments, for Karaoke, etc.
- * If you wish to purchase SMF Music Files, please consult the retailer where you purchased your HPi-7.

SMF with Lyrics

“SMF with Lyrics” refers to SMF (Standard MIDI File) that contains the lyrics. When Music Files carrying the “SMF with Lyrics” logo are played back on a compatible device (one bearing the same logo), the lyrics will appear in its display.

■ About the HPi-7 Sound Generator

The HPi-7 come equipped with GM 2/GS sound generators.

General MIDI

The General MIDI is a set of recommendations which seeks to provide a way to go beyond the limitations of proprietary designs, and standardize the MIDI capabilities of sound generating devices. Sound generating devices and music files that meets the General MIDI standard bears the General MIDI logo. Music files bearing the General MIDI logo can be played back using any General MIDI sound generating unit to produce essentially the same musical performance.

General MIDI 2

The upwardly compatible General MIDI 2 recommendations pick up where the original General MIDI left off, offering enhanced expressive capabilities, and even greater compatibility. Issues that were not covered by the original General MIDI recommendations, such as how sounds are to be edited, and how effects should be handled, have now been precisely defined. Moreover, the available sounds have been expanded. General MIDI 2 compliant sound generators are capable of reliably playing back music files that carry either the General MIDI or General MIDI 2 logo. In some cases, the conventional form of General MIDI, which does not include the new enhancements, is referred to as “General MIDI 1” as a way of distinguishing it from General MIDI 2.

GS Format

The GS Format is Roland’s set of specifications for standardizing the performance of sound generating devices. In addition to including support for everything defined by the General MIDI, the highly compatible GS Format additionally offers an expanded number of sounds, provides for the editing of sounds, and spells out many details for a wide range of extra features, including effects such as reverb and chorus. Designed with the future in mind, the GS Format can readily include new sounds and support new hardware features when they arrive. Since it is upwardly compatible with the General MIDI, Roland’s GS Format is capable of reliably playing back GM Scores equally as well as it performs GS music files (music files that have been created with the GS Format in mind). This product supports both the General MIDI 2 and the GS Format, and can be used to play back music data carrying either of these logos.

XG lite

XG is a tone generator format of YAMAHA Corporation, that defines the ways in which voices are expanded or edited and the structure and type of effects, in addition to the General MIDI 1 specification. XGlite is a simplified version of XG tone generation format. You can play back any XG music files using an XGlite tone generator. However, keep in mind that some music files may play back differently compared to the original files, due to the reduced set of control parameters and effects.

MIDI Implementation Chart

Function...		Transmitted	Recognized	Remarks
Basic Channel	Default Changed	1 1-16	1-16 1-16	
Mode	Default Messages Altered	Mode 3 x *****	Mode 3 Mode 3, 4(M=1)	* 2
Note Number :	True Voice	15-113 *****	0-127 0-127	
Velocity	Note ON Note OFF	O O	O O	
After Touch	Key's Ch's	x x	O O	*1 *1
Pitch Bend		O	O	
Control Change	0, 32 1 5 6, 38 7 10 11 64 65 66 67 84 91 93 98, 99 100, 101	O O *3 O *3 O *3 O O *3 O *3 O O O *3 O O O *3 O O *3 O O *3	O *1 O *1 O *1 O *1 O *1 O *1 O *1 O *1 O *1 O *1 O (Reverb) O (Chorus) O *1 O *1	Bank select Modulation Portamento time Data entry Volume Panpot Expression Hold 1 Portamento Sostenuto Soft Portamento control Effect1 depth Effect3 depth NRPN LSB, MSB RPN LSB, MSB
Prog Change	: True #	0-127 *****	O 0-127	Program number 1-128
System Exclusive		O	O	
System Common	: Song Pos : Song Sel : Tune	x x x	x x x	
System Real Time	: Clock : Commands	O x	x x	
Aux Message	: All sound off : Reset all controllers : Local Control : All Notes OFF : Active Sense : Reset	x x x x O x	O (120, 126, 127) O O O (123-125) O x	
Notes		* 1 O x is selectable by Sys Ex. * 2 Recognized as M=1 even if M≠1. * 3 O x is selectable by Composer Out setting.		

Mode 1 : OMNI ON, POLY Mode 2 : OMNI ON, MONO
Mode 3 : OMNI OFF, POLY Mode 4 : OMNI OFF, MONO

O : Yes
X : No

Main Specifications

<Keyboard>	
Keyboard	88 keys (Progressive Hammer Action Keyboard with Escapement)
Touch Sensitivity	Light, Medium, Heavy, Fixed
Keyboard Mode	Whole Split (split point adjustable) Dual (volume balance adjustable) Pianist Manual Drums/SFX
<Sound Generator> Conforms to GM2 / GS / XG Lite	
Max. Polyphony	128 voices
Tones	600 sounds in 6 groups (including 15 drum sets, 1 SFX set)
Temperament	8 types, tonic selectable
Stretched Tuning	2 types
Master Tuning	415.3 Hz–466.2 Hz (adjustable in increments of 0.1 Hz)
Transpose	Key Transpose (-6+5 in semitones) Playback Transpose (-24+24 in semitones)
Effects	Reverb (10 levels), Chorus (10 levels) Damper Resonance (for Piano only, 10 levels), String Resonance (for Piano only, 10 levels), Lid (for Piano only, 10 levels) Hammer Response (for Piano only, 10 levels)
<Arranger>	
Music Styles	35 Pianist Styles
Control	Start/Stop Intro/Ending
<Composer>	
Metronome	Beat: 2/2, 0/4, 2/4, 3/4, 4/4, 5/4, 6/4, 7/4, 3/8, 6/8, 9/8, 12/8
	Volume: 10 levels
	Pattern: 11 patterns
	Sound: 8 types
Tracks	5 tracks / 16 tracks
Song	1 song
Note Storage	Approx. 30,000 notes
Tempo	Quarter note = 10–500
Resolution	120 ticks per quarter note
Edit	Copy, Quantize, Delete, Insert, Erase, Transpose, Part Exchange, Note Edit, PC Edit
Control	Reset, Play/Stop, Rec, Bwd, Fwd, Track Select, All Song Play, Random Play, Count-in, Countdown, Marker Set, Repeat, Tempo Mute
<Disk Drive / Disk Storage> 3.5-inch Micro Floppy Disk Drive	
Disk Format	720 K bytes (2DD), 1.44 M bytes (2HD)
Files	Max. 99 songs
Note Storage	Approx. 120,000 notes (2DD) Approx. 240,000 notes (2HD)
Playable Software	Standard MIDI Files (Format 0/1) Roland Original Format (i-format)
Save	Standard MIDI Files (Format 0) Roland Original Format (i-format)

<Others>	
Internal Songs	Over 170 songs
User Memory	Max. 200 songs on Favorites, 1 User image
Rated Power Output	HPi-7: 40 W x 2 HPi-7LE: 50 W x 2
Speakers	HPi-7: 20 cm x 2 HPi-7LE: 20 cm x 2 (Speaker Box), 5cm x 2
Display	640 x 240 dots graphic color LCD (with backlit)
Notation	Grand staff / G clef staff / F clef staff, with note name / lyrics / chords / fingering
Languages	English/Japanese/German/French/Spanish
Lyrics	HPi-7: Yes (Built-in Display, MIDI Out) HPi-7LE: Yes (Built-in Display, MIDI Out, External display)
Control	Volume, Brilliance, LCD contrast, Mic volume
Pedals	Damper (half-pedal recognition) Soft (half-pedal recognition, function assignable) Sostenuto (function assignable)
Other Functions	Panel Lock, Replay, Wonderland/Game, Auto demo, Visual lesson, BMP export, Mic echo, User image display, V-LINK
Connectors	Output jacks (L/Mono, R) Input jacks (L/Mono, R) Headphones jack (Stereo) x 2 Mic Input jack MIDI In connector MIDI Out connector Pedal connector (8 pin DIN type) LCD connector (20 pin) USB connector Ext Display connector (15-pin D-Sub type, HPi-7LE only)
Power Supply	AC 117 V, AC 230 V or AC 240V (50/60 Hz), AC 220 V (60 Hz)
Power Consumption	HPi-7: 105 W (117 V/230 V/240 V) HPi-7LE: 120 W (117 V/230 V/240 V)
Dimensions	(including piano stand) 1,421 (W) x 526 (D) x 894 (H) mm 56 (W) x 20-3/4 (D) x 35-1/4 (H) inches
	(Including piano stand and music rest) 1,421 (W) x 526 (D) x 1,101 (H) mm 56 (W) x 20-3/4 (D) x 43-3/8 (H) inches
Weights (including piano stand)	HPi-7: 69 kg / 153 lbs HPi-7LE: 80 kg / 176 lbs 6 oz
Accessories	Owner's Manual Roland 60 Classical Piano Masterpieces Installation Guide CD-ROM (Roland Digital Piano USB Driver) Power Cord Headphones Hook Music Rest (with installation screws)

* In the interest of product improvement, the specifications and/or appearance of this unit are subject to change without prior notice.

Index

A	
Adjuster	11
All Song Play	18
Alphabet	33
Audio Device	61
Auto Demo	11
B	
Balance	55
BMP Format	52
Bouncing Ball	47
C	
Chord List	74
Chorus	27
Clef L	47
Clef R	47
Color Notation	47
Connections to a Computer	62
Contrast	10
Copy	49
Copying Songs	44
Count	21
Countdown	21
Count-in	21
D	
Damper pedal	11
Damper Resonance	55
Delete	50
Deleting Saved Songs	43
Demo	60
Direction	53
Drum Set List	70
Drums	33
Dual	27
E	
Effect	55
Effects	27
End Measure	53
Erase	51
Error Message	66
F	
Factory Reset	60
Factory Setting	
User Memory	59
Favorites	19
Flash Card	33
Floppy Disk	41, 46
G	
Game	33
General MIDI	77
General MIDI 2	77
GS	77
GS Format	77
H	
Hammer Response	55
Headphones	9
I	
Initialize User Memory	59
Insert	50
Internal Song List	75
K	
Key	47
Key Touch	25
L	
Language	56
Lid	10, 55
Lower	47
M	
Marker	22
Memory Backup	59
Message	66
Metronome	20
MIDI Device	61
Music Files	77
Music rest	9
Mute	17
N	
Note Edit	52
P	
Panel Lock	11
Part Exchange	51
PC Edit	52
Pedal	11, 56
Pedal cable	9
Percussion	26
Pianist Function	32
Pianist Style List	76
Piano	33

Piano Setting 55
 Pitches 47
 Play Mode 60
 Power cord 9
 Power On/Off 10

Q

Quantize 49

R

Recording 34, 36
 Resolution
 Marker 23
 Notation 47
 Reverb 27

S

Saving Songs 42
 SFX 33
 SFX Set 69
 SMF 77
 SMF Music files 77
 Soft pedal 11
 Song Edit 48
 Songs 33
 Sostenuato pedal 11
 Sound Generator 77
 Split 28
 Start Measure 53
 String Resonance 55
 Switch (Power On) 10

T

Tempo 17, 19
 Tone 26
 Tone List 67
 Tones 33
 Track 37
 Track Assign 57
 Track button 40
 Transpose 24, 51
 Trouble Shooting 64
 Tuning 55

U

Undo 49
 Upper 47
 USB 63
 User 47
 User Image Display 57

User Memory
 Formatting 59

V

Visual Lesson 30
 V-LINK 60

W

Wonderland 33

X

XG lite 77



This product complies with the requirements of European Directives EMC 89/336/EEC and LVD 73/23/EEC.

For EU Countries

FEDERAL COMMUNICATIONS COMMISSION RADIO FREQUENCY INTERFERENCE STATEMENT

This equipment has been tested and found to comply with the limits for a Class B digital device, pursuant to Part 15 of the FCC Rules. These limits are designed to provide reasonable protection against harmful interference in a residential installation. This equipment generates, uses, and can radiate radio frequency energy and, if not installed and used in accordance with the instructions, may cause harmful interference to radio communications. However, there is no guarantee that interference will not occur in a particular installation. If this equipment does cause harmful interference to radio or television reception, which can be determined by turning the equipment off and on, the user is encouraged to try to correct the interference by one or more of the following measures:

- Reorient or relocate the receiving antenna.
- Increase the separation between the equipment and receiver.
- Connect the equipment into an outlet on a circuit different from that to which the receiver is connected.
- Consult the dealer or an experienced radio/TV technician for help.

This device complies with Part 15 of the FCC Rules. Operation is subject to the following two conditions:

- (1) This device may not cause harmful interference, and
- (2) This device must accept any interference received, including interference that may cause undesired operation.

Unauthorized changes or modification to this system can void the users authority to operate this equipment.
This equipment requires shielded interface cables in order to meet FCC class B Limit.

For the USA

NOTICE

This Class B digital apparatus meets all requirements of the Canadian Interference-Causing Equipment Regulations.

AVIS

Cet appareil numérique de la classe B respecte toutes les exigences du Règlement sur le matériel brouilleur du Canada.

For Canada

Connecting an External Display (HPi-7LE only)

You can connect a computer display or other such external display to the instrument, and display scores and lyrics on the larger screen.

Displays That Can Be Connected to This Instrument

In general, a great many of the VGA displays and multiscan displays that are available on the market are compatible with this instrument. However, before you connect any display, make sure it meets the following specifications:

- Resolution 640 x 240 pixels
- Horizontal scan frequency 31.5 kHz
- Vertical scan frequency 60 Hz
- Connector 3-row, 15-pin D-Sub type
- Signal Analog

* An externally connected display will mirror the content of the HPi-7LE's onboard display. When connected, the screen is blank at the top and bottom, as shown in the figure.

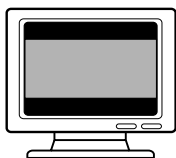

* Confirm that the display to be used is compatible with the frequencies mentioned above. Using a display that is not compatible with the above frequencies may result in incorrect image output when images move, and in certain cases may even damage the display.

Making the Connections

To prevent malfunction and/or damage to speakers or other devices, always turn down the volume, and turn off the power on all devices before making any connections.

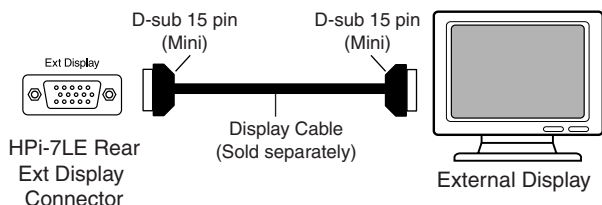

- 1 Turn off the power to the HPi-7LE and the display to be connected.
- 2 Use display cable (sold separately) to connect the display to the Ext Display connector on the HPi-7LE.
- 3 Switch on the HPi-7LE.
- 4 Switch on the connected display.

→ For more on handling the external display, refer to your display's owner's manual.

- * When using the HPi-7LE with a display placed on it, be sure to note the following precautions.
 - Make sure the display sits stably on the HPi-7LE before use.
 - If you are placing the display on top of the HPi-7LE, we recommend using a liquid crystal display (LCD). If using a cathode ray tube (CRT) display, take extra care to ensure that the display rests stably on the instrument.
 - Keep the base of the display within one of the areas shown by the dotted lines in the illustration below.

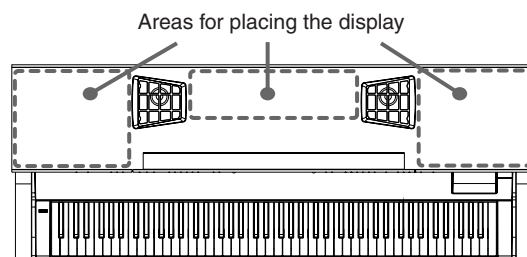

Turning the Power Off

After use, turn off the power using the following procedure.

- 1 Turn the volume all the way down on the HPi-7LE.
- 2 Turn off the HPi-7LE.
- 3 Turn off the connected display.

This owner's manual is printed on recycled paper.