

## PERCUSSION SOUND MODULE **TD-6**

# Owner's Manual

Thank you, and congratulations on your choice of the Roland Percussion Sound Module TD-6.

Before using this unit, carefully read the sections entitled: "USING THE UNIT SAFELY" (p. 2-3) and "IMPORTANT NOTES" (p. 4-5). These sections provide important information concerning the proper operation of the unit. Additionally, in order to feel assured that you have gained a good grasp of every feature provided by your new unit, Owner's manual should be read in its entirety. The manual should be saved and kept on hand as a convenient reference.

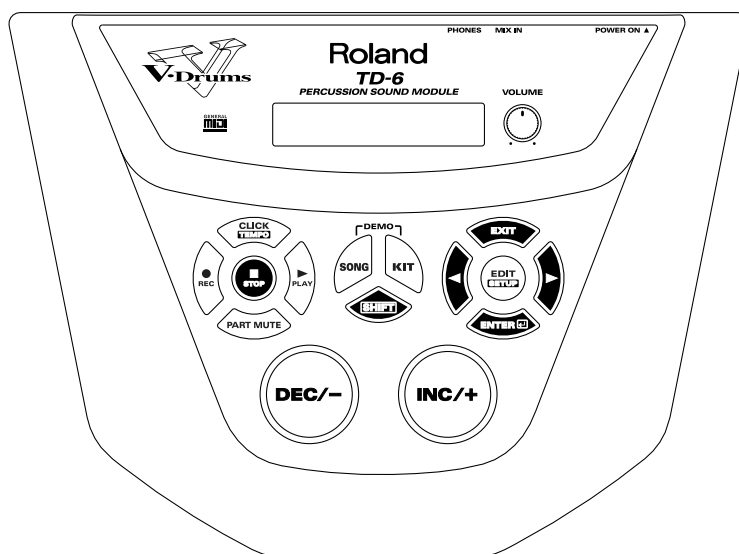

\* All product names mentioned in this document are trademarks or registered trademarks of their respective owners.

Copyright © 2001 ROLAND CORPORATION

All rights reserved. No part of this publication may be reproduced in any form without the written permission of ROLAND CORPORATION.



**IMPORTANT:** THE WIRES IN THIS MAINS LEAD ARE COLOURED IN ACCORDANCE WITH THE FOLLOWING CODE.



BLUE: NEUTRAL  
BROWN: LIVE

As the colours of the wires in the mains lead of this apparatus may not correspond with the coloured markings identifying the terminals in your plug, proceed as follows:  
The wire which is coloured BLUE must be connected to the terminal which is marked with the letter N or coloured BLACK.  
The wire which is coloured BROWN must be connected to the terminal which is marked with the letter L or coloured RED.  
Under no circumstances must either of the above wires be connected to the earth terminal of a three pin plug.







## USING THE UNIT SAFELY

### INSTRUCTIONS FOR THE PREVENTION OF FIRE, ELECTRIC SHOCK, OR INJURY TO PERSONS

About  WARNING and  CAUTION Notices





 <b>WARNING</b>	Used for instructions intended to alert the user to the risk of death or severe injury should the unit be used improperly.
 <b>CAUTION</b>	Used for instructions intended to alert the user to the risk of injury or material damage should the unit be used improperly.  * Material damage refers to damage or other adverse effects caused with respect to the home and all its furnishings, as well to domestic animals or pets.

About the Symbols





	The  symbol alerts the user to important instructions or warnings. The specific meaning of the symbol is determined by the design contained within the triangle. In the case of the symbol at left, it is used for general cautions, warnings, or alerts to danger.
	The  symbol alerts the user to items that must never be carried out (are forbidden). The specific thing that must not be done is indicated by the design contained within the circle. In the case of the symbol at left, it means that the unit must never be disassembled.
	The  symbol alerts the user to things that must be carried out. The specific thing that must be done is indicated by the design contained within the circle. In the case of the symbol at left, it means that the power-cord plug must be unplugged from the outlet.

### ALWAYS OBSERVE THE FOLLOWING









#### **WARNING**

- Before using this unit, make sure to read the instructions below, and the Owner's Manual. 
- Do not open (or modify in any way) the unit or its AC adaptor. 
- Do not attempt to repair the unit, or replace parts within it (except when this manual provides specific instructions directing you to do so). Refer all servicing to your retailer, the nearest Roland Service Center, or an authorized Roland distributor, as listed on the "Information" page. 
- Never use or store the unit in places that are:
  - Subject to temperature extremes (e.g., direct sunlight in an enclosed vehicle, near a heating duct, on top of heat-generating equipment); or are 
  - Damp (e.g., baths, washrooms, on wet floors); or are 
  - Humid; or are
  - Exposed to rain; or are
  - Dusty; or are
  - Subject to high levels of vibration.











#### **WARNING**

- This unit should be used only with a rack or stand that is recommended by Roland. 
- When using the unit with a rack or stand recommended by Roland, the rack or stand must be carefully placed so it is level and sure to remain stable. If not using a rack or stand, you still need to make sure that any location you choose for placing the unit provides a level surface that will properly support the unit, and keep it from wobbling. 
- Be sure to use only the AC adaptor supplied with the unit. Also, make sure the line voltage at the installation matches the input voltage specified on the AC adaptor's body. Other AC adaptors may use a different polarity, or be designed for a different voltage, so their use could result in damage, malfunction, or electric shock.   

- Do not excessively twist or bend the power cord, nor place heavy objects on it. Doing so can damage the cord, producing severed elements and short circuits. Damaged cords are fire and shock hazards! 

## **WARNING**

- This unit, either alone or in combination with an amplifier and headphones or speakers, may be capable of producing sound levels that could cause permanent hearing loss. Do not operate for a long period of time at a high volume level, or at a level that is uncomfortable. If you experience any hearing loss or ringing in the ears, you should immediately stop using the unit, and consult an audiologist. 
- Do not allow any objects (e.g., flammable material, coins, pins); or liquids of any kind (water, soft drinks, etc.) to penetrate the unit.   

- Immediately turn the power off, remove the AC adaptor from the outlet, and request servicing by your retailer, the nearest Roland Service Center, or an authorized Roland distributor, as listed on the “Information” page when:  
  - The AC adaptor or the power-supply cord has been damaged; or
  - Objects have fallen into, or liquid has been spilled onto the unit; or
  - The unit has been exposed to rain (or otherwise has become wet); or
  - The unit does not appear to operate normally or exhibits a marked change in performance.
- In households with small children, an adult should provide supervision until the child is capable of following all the rules essential for the safe operation of the unit. 
- Protect the unit from strong impact. (Do not drop it!) 
- Do not force the unit’s power-supply cord to share an outlet with an unreasonable number of other devices. Be especially careful when using extension cords—the total power used by all devices you have connected to the extension cord’s outlet must never exceed the power rating (watts/amperes) for the extension cord. Excessive loads can cause the insulation on the cord to heat up and eventually melt through. 
- Before using the unit in a foreign country, consult with your retailer, the nearest Roland Service Center, or an authorized Roland distributor, as listed on the “Information” page. 

## **CAUTION**

- The unit and the AC adaptor should be located so their location or position does not interfere with their proper ventilation. 
- Always grasp only the plug or the body of the AC adaptor when plugging into, or unplugging from, an outlet or this unit. 
- Whenever the unit is to remain unused for an extended period of time, disconnect the AC adaptor. 
- Try to prevent cords and cables from becoming entangled. Also, all cords and cables should be placed so they are out of the reach of children. 
- Never climb on top of, nor place heavy objects on the unit. 
- Never handle the AC adaptor body, or its plugs, with wet hands when plugging into, or unplugging from, an outlet or this unit. 
- Before moving the unit, disconnect the AC adaptor and all cords coming from external devices. 
- Before cleaning the unit, turn off the power and unplug the AC adaptor from the outlet (p. 23). 
- Whenever you suspect the possibility of lightning in your area, disconnect the AC adaptor from the outlet. 
- Should you remove screws, make sure to put them in a safe place out of children’s reach, so there is no chance of them being swallowed accidentally. 

# IMPORTANT NOTES

In addition to the items listed under “USING THE UNIT SAFELY” on page 2–3, please read and observe the following:

## Power Supply

- Do not use this unit on the same power circuit with any device that will generate line noise (such as an electric motor or variable lighting system).
- The AC adaptor will begin to generate heat after long hours of consecutive use. This is normal, and is not a cause for concern.
- Before connecting this unit to other devices, turn off the power to all units. This will help prevent malfunctions and/or damage to speakers or other devices.

## Placement

- Using the unit near power amplifiers (or other equipment containing large power transformers) may induce hum. To alleviate the problem, change the orientation of this unit; or move it farther away from the source of interference.
- This device may interfere with radio and television reception. Do not use this device in the vicinity of such receivers.
- Do not expose the unit to direct sunlight, place it near devices that radiate heat, leave it inside an enclosed vehicle, or otherwise subject it to temperature extremes. Excessive heat can deform or discolor the unit.
- To avoid possible breakdown, do not use the unit in a wet area, such as an area exposed to rain or other moisture.

## Maintenance

- For everyday cleaning wipe the unit with a soft, dry cloth or one that has been slightly dampened with water. To remove stubborn dirt, use a cloth impregnated with a mild, non-abrasive detergent. Afterwards, be sure to wipe the unit thoroughly with a soft, dry cloth.
- Never use benzine, thinners, alcohol or solvents of any kind, to avoid the possibility of discoloration and/or deformation.

## Repairs and Data

- Please be aware that all data contained in the unit’s memory may be lost when the unit is sent for repairs. Important data should always be backed up in another MIDI device (e.g., a sequencer), or written down on paper (when possible). During repairs, due care is taken to avoid the loss of data. However, in certain cases (such as when circuitry related to memory itself is out of order), we regret that it may not be possible to restore the data, and Roland assumes no liability concerning such loss of data.

## Memory Backup

- This unit contains a battery which powers the unit’s memory circuits while the main power is off. When this battery becomes weak, the message shown below will appear in the display. Once you see this message, have the battery replaced with a fresh one as soon as possible to avoid the loss of all data in memory. To have the battery replaced, consult with your retailer, the nearest Roland Service Center, or an authorized Roland distributor, as listed on the “Information” page.

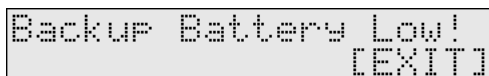

```
Backup Battery Low!  
[EXIT]
```

## Additional Precautions

- Please be aware that the contents of memory can be irretrievably lost as a result of a malfunction, or the improper operation of the unit. To protect yourself against the risk of losing important data, we recommend that you periodically save a backup copy of important data you have stored in the unit's memory in another MIDI device (e.g., a sequencer).
- Unfortunately, it may be impossible to restore the contents of data that was stored in the unit's memory or another MIDI device (e.g., a sequencer) once it has been lost. Roland Corporation assumes no liability concerning such loss of data.
- Use a reasonable amount of care when using the unit's buttons, sliders, or other controls; and when using its jacks and connectors. Rough handling can lead to malfunctions.
- Never strike or apply strong pressure to the display.
- When connecting / disconnecting all cables, grasp the connector itself—never pull on the cable. This way you will avoid causing shorts, or damage to the cable's internal elements.
- To avoid disturbing your neighbors, try to keep the unit's volume at reasonable levels. You may prefer to use headphones, so you do not need to be concerned about those around you (especially when it is late at night).
- Since sound vibrations can be transmitted through floors and walls to a greater degree than expected, take care not to allow such sound to become a nuisance to neighbors, especially at night and when using headphones. Although the drum pads and pedals are designed so there is a minimal amount of extraneous sound produced when they're struck, rubber heads tend to produce louder sounds compared to mesh heads. You can effectively reduce much of the unwanted sound from the pads by switching to mesh heads.
- When you need to transport the unit, package it in the box (including padding) that it came in, if possible. Otherwise, you will need to use equivalent packaging materials.
- Use a cable from Roland to make the connection. If using some other make of connection cable, please note the following precautions.
  - Some connection cables contain resistors. Do not use cables that incorporate resistors for connecting to this unit. The use of such cables can cause the sound level to be extremely low, or impossible to hear. For information on cable specifications, contact the manufacturer of the cable.

# Contents

<b>USING THE UNIT SAFELY .....</b>	<b>2</b>
<b>IMPORTANT NOTES.....</b>	<b>4</b>
<b>Contents .....</b>	<b>6</b>
<b>Features .....</b>	<b>12</b>
<b>How to Use This Manual .....</b>	<b>14</b>
Composition of This Manual.....	14
Terms Used in This Manual .....	14
<b>Setup Guide .....</b>	<b>15</b>
<hr/>	
<b>Panel Descriptions .....</b>	<b>16</b>
Front Panel.....	16
Rear Panel .....	18
<b>Making the Settings.....</b>	<b>19</b>
Mounting the TD-6 to the Stand .....	19
Connecting the Pads and the Pedals .....	20
About Polarity Switch.....	21
Connecting Two Pads to Trigger Inputs 5/6 (TOM2/AUX) and 7/8 (TOM3/4).....	21
Connecting Two Kick Trigger Units.....	22
Connecting Headphones, Audio Equipment, Amps, and Other Gear .....	23
<b>Turning On/Off the Power .....</b>	<b>24</b>
Turning Off the Power .....	25
<b>Restoring the Factory Settings (Factory Reset).....</b>	<b>26</b>
<b>Listening to the Demo Songs.....</b>	<b>28</b>
<b>Selecting the Pad Type .....</b>	<b>30</b>
<b>Adjusting the Sensitivity of the Pad .....</b>	<b>32</b>
<b>About the Pads .....</b>	<b>34</b>
Trigger Inputs and the Pads You Can Use.....	34
Trigger Input Functions.....	34
Combinations of Pad and Trigger Type.....	35
Recommended Parameters for the Pads .....	36
Playing the Pads .....	37
Pad Head Shots and Rim Shots .....	37
Cross Stick.....	37
Cymbal Bow Shots/Edge Shots/Bell Shots.....	38
Cymbal Choke.....	39
Hi-Hat Control Pedal .....	39

## **Quick Start..... 41**

---

**Choosing a Drum Kit.....42**

**Playing While Listening to the Metronome/Click .....43**

Switching the Click On and Off..... 43

Adjusting the Click Volume (Level)..... 44

Adjusting the Click Tempo..... 45

**Playing Along with Songs .....46**

Choosing a Song and Playing Back ..... 46

    Choosing a Song ..... 46

    Playing Back a Song ..... 47

Adjusting the Song Volume ..... 48

    Setting the Backing Part (Melodic Instruments etc.) Volume ..... 48

    Setting the Drums and Percussion Volume ..... 48

Temporarily Changing the Tempo of a Song ..... 49

Muting the Pre-programmed Drums in Songs ..... 50

**Using the Pads to Play Songs.....52**

**Playing with a CD, Tape, or MD (Using MIX IN Jack) .....53**

**Using the TD-6 As a General MIDI Sound Module.....54**

## **Advanced Use ..... 55**

---

**Chapter 1 Creating Your Own Drum Kit .....(Kit Edit) .....56**

About Drum Kits and the Drum Kit Screen..... 56

    About the Drum Kits..... 56

    About the Drum Kit Screen..... 57

Choosing a Drum Kit ..... (Drum Kit) ..... 57

Choosing the Pad to Edit..... 57

    Choosing a Pad by Hitting It ..... 57

    Choosing on the TD-6 ..... 58

Notation Used in the Screen ..... 58

Helpful Functions for Edit ..... 58

    Listening the INST (Instrument) assigned to a Pad ..... (Preview) ..... 58

    Locking the Setting Screen While Editing One Instrument ... (Note Chase) ..... 59

Choosing an Instrument ..... 59

    About the Instruments..... 59

    Choosing from the Group Names..... (Inst Group) ..... 59

    Choosing an Instrument ..... (Inst) ..... 60

Instrument Settings ..... (INST) ..... 60

    Adjusting the Volume of the Pad..... (Level) ..... 61

    Setting the Pan Position..... (Pan) ..... 61

    Adjusting the Pitch..... (Pitch)..... 61

    Adjusting the Decay (Length of Sound)..... (Decay)..... 61

Ambience Settings .....	(AMBIENCE) .....	62
Switching Ambience On/Off.....	(Ambience Switch).....	62
Ambience “Send” Level for Each Instrument .....	(Ambience Send Level) ....	62
Choose “Location” Where the Drums are Played .....	(Studio Type) .....	62
Changing the Wall Surface Material.....	(Wall Type) .....	63
Determine the Room Size .....	(Room Size).....	63
Adjusting the Entire Drum Kit’s Overall Ambience .....	(Ambience Level) .....	63
Equalizer Settings .....	(EQUALIZER).....	64
Switching the Equalizer On/Off.....	(Master Equalizer Switch)..	64
Adjusting the Sound .....	(High Gain, Low Gain)....	64
Settings for Various Functions .....	(CONTROL) .....	64
Playing a Song by Hitting a Pad.....	(Pad Pattern) .....	65
Control the “Level” of the Pattern with Playing Dynamics...	(Pad Pattern Velocity) .....	65
Pitch Control		
with the Hi-Hat Control Pedal On/Off for Each Pad .....	(Pitch Control Assign) .....	66
MIDI Note Number for Each Pad .....	(Note Number) .....	66
MIDI Gate Time for Each Pad.....	(Gate Time) .....	67
Overall Drum Kit Settings .....	(COMMON) .....	68
Overall Drum Kit Volume .....	(Master Volume) .....	68
Adjusting the Volume of the Pedal Hi-Hat Sound.....	(Pedal Hi-Hat Volume) ....	68
Setting the Range for the Pitch Control		
with the Hi-Hat Control Pedal .....	(Pedal Pitch Control Range) ...	68
Naming the Drum Kit.....	(Kit Name).....	69
Copying a Drum Kit .....	(COPY).....	69
Restoring the Factory Settings for the Edited Drum Kit.....		70
Switching the Order of the Drum Kits .....	(EXCHANGE) .....	70
<b>Chapter 2 Making the Pad and Trigger Settings.....(SETUP/TRIG) .....</b>	<b>71</b>	
About the Screen Display .....		71
Notation Used in the Screen.....		71
About the Input Indicator .....		71
Selecting the Pad Type.....	(Trigger Type).....	71
Setting the Pad Sensitivity and Making Other Settings .....	(TRIGGER BASIC) .....	72
Adjusting the Pad Sensitivity .....	(Sensitivity) .....	73
Setting the Minimum Levels for the Pads.....	(Threshold).....	73
Adjust How Playing Dynamics Changes the Volume .....	(Trigger Curve).....	73
Eliminate Crosstalk Between Pads.....	(Crosstalk Cancel) .....	74
Fine-Tuning the Trigger Parameter Settings.....	(TRIGGER ADVANCED)..	74
Adjusting the Trigger Signal Detection Time.....	(Scan Time) .....	75
Detecting Trigger Signal Attenuation		
and Cancelling Incorrect Triggering.....	(Retrigger Cancel) .....	75
Double Triggering Prevention .....	(Mask Time) .....	75
Setting Rim Sensitivity on the PD-120 and PD-80R.....	(Rim Sens) .....	76
Using the TD-6 with Acoustic Triggers .....		76
<b>Chapter 3 Global Settings for the TD-6 .....</b>	<b>(SETUP/UTILITY, Factory Reset) ...</b>	<b>77</b>
Making the Global Settings .....	(UTILITY).....	77
Display Contrast Adjustment .....	(LCD Contrast) .....	77
Percussion Part Volume Control .....	(Percussion Part Level)....	77



Backing Instruments Volume Control.....	(Backing Level).....	78
Muting Parts of a Song.....	(Mute) .....	78
Tuning the TD-6.....	(Master Tune) .....	78
Preview Volume Control.....	(Preview Velocity) .....	79
Checking the Remaining Amount of Memory.....	(Available Memory) .....	79
Restoring the Factory Settings .....	(Factory Reset).....	79
<b>Chapter 4 Setting the Metronome .....</b>	<b>(Click Edit).....</b>	<b>80</b>
Switching the Click On/Off.....	(Click) .....	80
Tempo Adjustment .....	(Tempo) .....	80
Setting the Way the Click Sounds .....		80
Volume Adjustment .....	(Click Level).....	80
Setting the Time Signature .....	(Time Signature).....	81
Setting the Interval .....	(Interval).....	81
Selecting the Click Sound .....	(Inst) .....	81
Stereo Position.....	(Pan) .....	81
Inserting a Count Before Playback or Recording.....	(Play Count In, Rec Count In) ..	81
<b>Chapter 5 Editing Songs.....</b>	<b>(SONG Edit).....</b>	<b>82</b>
About Songs and the Song Screen .....		82
About Songs .....		82
About the Song Screen.....		83
Choosing a Song.....		84
Choosing from a Category .....	(Song Category).....	84
Choosing a Song .....	(Song).....	84
Playing Back a Song .....		84
Convenient Function for Playback.....		84
Adjusting the Song Volume .....		85
Muting a Selected Part.....	(Part Mute) .....	85
Overall Song Settings.....	(COMMON) .....	86
Setting the Tempo.....	(Tempo) .....	86
Selecting How the Song Plays Back (LOOP, 1SHOT, TAP) ...	(Play Type) .....	86
Playing Back the Song from the First Note/Event .....	(Quick Play) .....	87
Reset Time When Using Tap Playback.....	(Reset Time) .....	87
Preventing Layering of Sounds in Tap Playback.....	(Tap Exclusive Switch) ....	87
Protecting User Song Settings.....	(Song Lock) .....	87
Naming a Song.....	(Song Name) .....	88
Part Settings .....	(PART) .....	88
Choosing Percussion Set and Instruments .....	(Percussion Set, Inst).....	89
Adjusting the Part Volume.....	(Level) .....	89
Adjusting the Stereo Position.....	(Pan) .....	90
Adjusting the Amount of Ambience.....	(Ambience Send Level) ....	90
Adjusting the Bend Range.....	(Bend Range) .....	90
Copying a Song.....	(COPY) .....	90
Deleting a Song.....	(DELETE) .....	91
Erasing Performance Data in a Song.....	(ERASE).....	92

<b>Chapter 6 Recording a Song .....</b>	<b>(Realtime Recording) ..93</b>
Preparations for Recording .....	93
When Recording Pad Performances .....	93
Recording Performances by External MIDI Devices .....	93
How To Record .....	(RECORDING STANDBY) .. 94
Setting the Time Signature .....	(Time Signature)..... 94
Setting the Number of Measures.....	(Length) ..... 94
Setting the Song Tempo.....	(Tempo) ..... 94
Quantize During Recording.....	(Quantize) ..... 95
Selecting the Recording Method	
(Loop All, Loop1, Loop2, Replace).....	(Recording Mode) ..... 95
Start Recording with a Pad or Pedal Trigger.....	(Hit Pad Start) ..... 95
<b>Chapter 7 Making the MIDI Settings .....</b>	<b>(SETUP/MIDI, BULK DUMP) ....96</b>
About MIDI .....	96
MIDI Connectors .....	96
MIDI Channels and Multi-timbral Sound Modules .....	96
How the Internal Sequencer Operates.....	97
Making the MIDI Settings .....	(MIDI COMMON) ..... 97
Automatically Switching Instrument Settings Screens .....	(Note Chase) ..... 98
When Using as MIDI Controller	
for External MIDI Device Only.....	(Local Control)..... 98
Synchronizing with an External MIDI Device .....	(Sync Mode) ..... 98
Setting Priority for Playing Drums and Percussion .....	(Channel 10 Priority) ..... 99
Hi-Hat Control Pedal Data Reduction.....	(Pedal Data Thin) ..... 99
Switch to the GM (General MIDI) Mode.....	(GM Mode) ..... 100
Preventing the TD-6 from Switching	
to GM (General MIDI) Mode .....	(Rx GM ON)..... 100
Mixing MIDI Signals Coming to the MIDI IN	
with Real Time Performance on the Pads.....	(Soft Thru) ..... 101
Set the Device ID.....	(Device ID) ..... 101
Setting the TD-6 So That Program Changes	
Are Not Transmitted .....	(Tx PC Sw) ..... 102
Are Not Received.....	(Rx PC Sw) ..... 102
MIDI Channel Settings for a Part.....	(MIDI PART) ..... 102
MIDI Messages Stop Function for Specific Parts	
in GM (General MIDI) Mode .....	(GM PART)..... 103
Saving Data to an External MIDI Device .....	(BULK DUMP) ..... 103
Returning Saved Data to the TD-6 .....	104
<b>Chapter 8 Features Using MIDI and Setting Examples .....</b>	<b>105</b>
About Transmitting/Receiving Program Changes .....	105
Triggering an External Sound Device by Playing the TD-6 .....	105
Combining with an External MIDI Sequencer.....	106
Importing Sequence Data from an External MIDI Device	
to the TD-6's Internal Sequencer .....	106
Recording Your Performance to an External Sequencer.....	106
Using the TD-6 As a Sound Module .....	107

**Appendices ..... 109**

<b>Troubleshooting .....</b>	<b>110</b>
No Sound .....	110
No Sound/Low volume from Device Connected to the MIX IN Jack .....	112
Drum Kit Does Not Sound As Intended.....	112
Pad Does Not Sound As Intended .....	113
Song Does Not Sound As Intended .....	114
Sound is distorted.....	114
Problems Operating the TD-6 .....	115
Display Is Too Light Or Too Dark .....	115
<b>Messages and Error Messages .....</b>	<b>116</b>
System and Battery Error Messages.....	116
Messages and Error Messages Related to Sequencers and Songs.....	116
Messages and Error Messages Related to MIDI.....	117
<b>Drum Kit List.....</b>	<b>118</b>
<b>Drum Instrument List.....</b>	<b>120</b>
<b>Preset Percussion Set List.....</b>	<b>124</b>
<b>Backing Instrument List.....</b>	<b>126</b>
<b>Preset Song List .....</b>	<b>128</b>
<b>Parameter List .....</b>	<b>130</b>
<b>MIDI Implementation .....</b>	<b>135</b>
<b>Block Diagram .....</b>	<b>151</b>
<b>Specifications .....</b>	<b>152</b>
<b>Index.....</b>	<b>153</b>

# Features

## Full Palette of Internal Sounds for All Uses, from Practice to Live Performance

---

### ■ Includes 99 Different Drum Kits

You can immediately start playing any of a variety of drum kits, just by selecting the drum kit. Whether for practice or live performances, these kits can be applied in a wide range of situations.

### ■ 1, 042 Drum Instruments

You can combine different drum instruments used in a wide range of musical genres to create your own original drum kits.

### ■ 150 Different Preset Songs

To get right down to practicing, you merely need to select a Preset song. Then you can play the drum part just by muting only the Preset song's drum performance.

You also get 100 internal songs that you can use to record your own drum performances (User songs).

### ■ 262 Backing Instruments

The TD-6's abundance of backing instruments allow you to record in a variety of musical genres.

## Rich Expression

---

### ■ Cross Stick Technique Available (p. 37)

### ■ Play Rim Shots (p. 37), Cymbal Edge Shots (p. 38), and Use Cymbal Choking (p. 39)

### ■ Pitch Control Available with the Hi-Hat Control Pedal (p. 66)

You can use the hi-hat control pedal to change the pitch of the pad instruments.

## Function and Operations Perfect for Live Performances

---

- Flat Top Design for Great Visibility
- Buttons Light for Easy Operation, Even On Stage
- Large [INC/+] and [DEC/-] Buttons That Can Be Operated Even with Drum Sticks

## Convenient Functions for Practicing

---

- Includes Metronome (Click) (p. 80)
- Includes Part Mute Function for Muting of Specific Parts When Playing With Preset Songs (p. 50, p. 78)

## Expandability/Compatibility

---

### ■ Also Compatible With

Pads (PD-5, PD-6, PD-7, PD-9, PD-80, PD-80R, PD-100, PD-120)

Cymbals (CY-6, CY-12H, CY-14C, CY-15R)

Kick Trigger Units (KD-5, KD-7, KD-80, KD-120)

Hi-Hat Control Pedals (FD-7, FD-6; FD-6 is included with TD-6K)

### ■ Use the TD-6 As a MIDI Sound Module With an External Sequencer (p. 106)

### ■ Support for General MIDI (p. 54, p. 100)

The TD-6 has a GM mode that can play back GM scores.

This mode includes a function allowing you to mute the sound only of a specified part during playback of GM scores. This is a very convenient feature for practicing and playing along.

#### General MIDI ( ) System

General MIDI is a set of recommendations which seeks to provide a way to go beyond the limitations of proprietary designs, and standardize the MIDI capabilities of sound generating devices. Sound generating devices and music files that meet the General MIDI standard bear the General MIDI logo (  ).

Music files bearing the General MIDI logo can be played back using any General MIDI sound generating unit to produce essentially the same musical performance.

# How to Use This Manual

## Composition of This Manual

This owner's manual is organized as follows.

### Setup Guide (p. 15)

For those using the TD-6 for the first time, this volume explains the preparations needed for playing sounds, including how to set up the stand, make pad settings, and turn on the TD-6's power.

Also provided are explanations of how to combine the TD-6 with other optional pads for fullest utilization of the TD-6's features and functions.

### Quick Start (p. 41)

This contains descriptions explaining how to easily enjoy performing with the TD-6's numerous internal drum kits and Preset songs.

### Advanced Use (p. 55)

The TD-6 allows you use the drum kits you like to create new drum kits and to create songs from recordings of what you play.

This section provides detailed explanations of all of the TD-6's functions.

- **Chapter 1 Functions For Creating Drum Kits** (p. 56)  
Here are the settings used for creating sounds.
- **Chapter 2 Functions For Correctly Performing with the Pads** (p. 71)  
This describes the settings you need to make in order to get the most expression from the TD-6 and pads.
- **Chapter 3 TD-6 Settings** (p. 77)  
Included in this section are settings such as display contrast and song volume that are applied to the TD-6 as a whole.
- **Chapters 4–6 Using the sequencer and related functions** (p. 80)  
Found here are metronome (click) settings, as well as song performance, recording, editing, and other settings for sequencers.
- **Chapters 7–8 MIDI Settings and Examples of How MIDI Is Used** (p. 96)  
This chapter explains how to use MIDI —whether it be for saving data to an external device, or for using the TD-6 as a General MIDI sound module.

### Appendices (p. 109)

If you run into problems, refer to “Troubleshooting” to make sure that the settings are correct. If an error message appears during operation, refer to “Messages and Error Messages” and take appropriate action. This section also provides various lists, and the MIDI implementation charts.

## Terms Used in This Manual

- Button names are enclosed in square brackets “[ ],” as in [KIT] button.
- (p. \*\*) indicates a reference page.

- Steps in operations may be abbreviated as described below.

[KIT] → [EDIT]

1. Press [KIT].

2. Press [EDIT].

[SHIFT] + [KIT]

1. While holding down [SHIFT], press [KIT].

- The functions of some buttons, such as [EDIT (SETUP)], change if pressed while [SHIFT] is held down; the function that is enabled when [SHIFT] is held down is shown in parentheses.
- Symbols appearing before the beginning of sentences in the manual have the following meanings.



These indicate cautionary notes. Be sure to read them.



These are memos containing information regarding settings and functions. Read it as necessary.



These are useful hints for operation. Read it as necessary.



These point to reference information. Read it as necessary.



These are descriptions of terminology. Read it as necessary.

\* *The explanations in this manual include illustrations that depict what should typically be shown by the display. Note, however, that your unit may incorporate a newer, enhanced version of the system (e.g., includes newer sounds), so what you actually see in the display may not always match what appears in the manual.*



PERCUSSION SOUND MODULE **TD-6**

# Setup Guide

# Panel Descriptions

## Front Panel

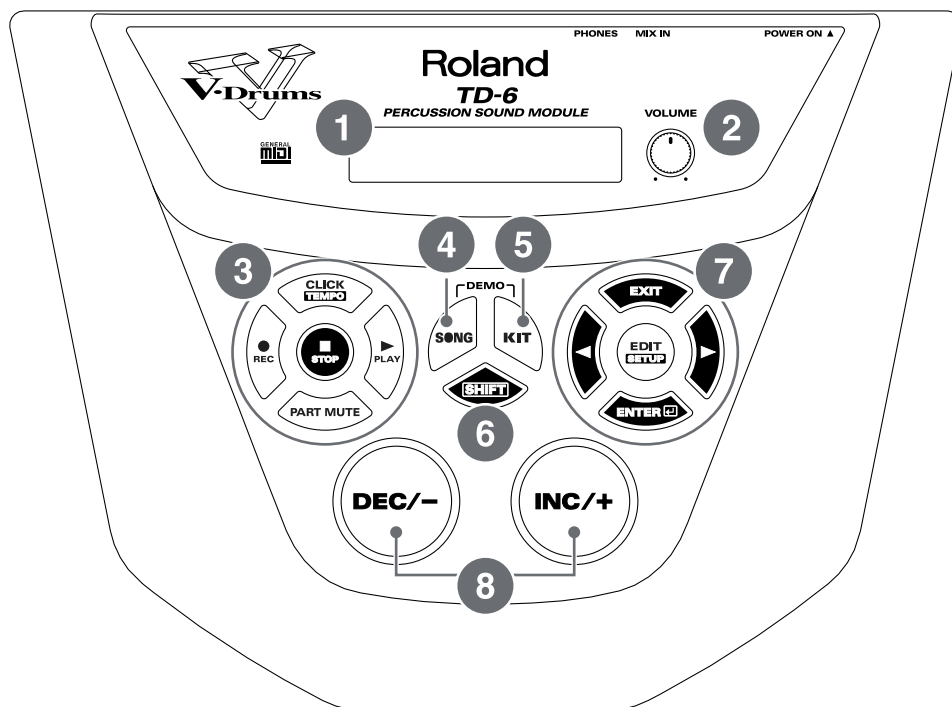

### 1 Display

The screen displays information, indicating the drum kit name, song name, and settings etc.

### 2 VOLUME Knob

Adjusts the volume of the TD-6 (p. 25). Even when headphones are connected, sound will still be output from the various output jacks.

### 3 Sequencer Section

- **CLICK (TEMPO) Button**  
Turn the click on/off (p. 43).  
When you hold down the [SHIFT] button and press the [CLICK (TEMPO)] button, the tempo settings screen appears in the display (p. 45, p. 49).
- **REC ● Button**  
Calls up the recording settings screen (Recording Standby; p. 94).
- **STOP ■ Button**  
Stop song playback (p. 47). When pressed while the song is stopped, this returns you to the beginning of the song.
- **PLAY ► Button**  
Play back the song (p. 47). Starts recording if pressed when the TD-6 is in recording standby mode (p. 94).
- **PART MUTE Button**  
Mutes the performance of specified parts (p. 50).



**4 SONG Button**

Calls up the song's basic settings screen (p. 83).

**5 KIT Button**





Calls up the drum kit's basic settings screen (p. 57).

**6 SHIFT Button**

Used in conjunction with other buttons.

Operation	Function
[SHIFT] + [KIT]	Gives a preview of the sound of the instrument assigned to the selected pad (Preview; p. 58)
[SHIFT] + [◀], [▶]	<ul style="list-style-type: none"> <li>• Selects the trigger input (Trigger Select; p. 58)</li> <li>• Deletes or inserts one character when setting drum kit names and song names (p. 69, p. 88)</li> </ul>
[SHIFT] + [CLICK (TEMPO)]	Displays the tempo settings screen (p. 45, p. 49)
[SHIFT] + [EDIT (SETUP)]	For making overall settings for the TD-6 (Setup; p. 71, p. 77, p. 93)
[SHIFT] + [SONG]	Displays the volume settings screen for the backing instruments (melodic and other instruments) (p. 48)
[SHIFT] + [PLAY ▶]	While the song is playing back, the buttons corresponding to the percussion pad drum tones are lit (p. 47).
[SHIFT] + [STOP ■]	Jumps to songs that have not been used (new User songs) (p. 93)
[SHIFT] + [PART MUTE]	Displays the settings screen for muting parts (p. 78)
[SHIFT] + [INC/+], [DEC/-]	<ul style="list-style-type: none"> <li>• For making large changes at a time in the values of settings</li> <li>• Changes instrument groups and song categories (p. 59, p. 84)</li> <li>• Switches uppercase and lowercase letters and symbols when setting drum kit names and song names (p. 69, p. 88)</li> </ul>

**7 Editing section**

- **EXIT Button**  
Returns to the previous stage screen. When pressed a number of times, the display returns to either the Drum Kit screen or the Song screen.
- **◀, ▶ Button**  
These switch the screen if pressed when “” or “” is shown in the display.  
You can select the trigger input by holding down the [SHIFT] button and pressing [◀] or [▶] (p. 58).  
In the SONG screen, rewinding and fast forwarding are carried out in one-measure units (p. 47).
- **EDIT (SETUP) Button**  
Displays the drum kit or song settings screen. By holding down the [SHIFT] button and pressing the [EDIT (SETUP)] button, you can make overall settings for the TD-6.
- **ENTER  Button**  
Switches the screen if pressed when “” is shown in the display.

**8 INC/+ (Increment) Button, DEC/- (Decrement) Button**

These are used to switch drum kits and songs and to make changes in the settings values.

- Pressing the [INC/+] button increases the value, and pressing the [DEC/-] button decreases the value.
- When making an on/off setting, [INC/+] will turn the setting on and [DEC/-] will turn it off.
- When [SHIFT] is held down and [INC/+] or [DEC/-] is pressed, settings values are then changed in larger increments or decrements.
- When [INC/+] is held down and then [DEC/-] is pressed, settings values increase rapidly; when [DEC/+] is held down and then [INC/-] is pressed, settings values then decrease rapidly.

## Rear Panel

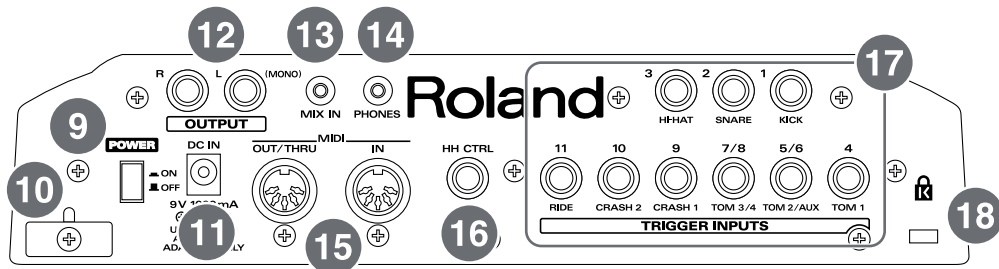

### 9 POWER Switch

Switch turns the power on/off (p. 24).

### 10 Cord Hook

Anchor the power cord (p. 23).

### 11 AC Adaptor Jack

Connect the supplied AC adaptor to this jack (p. 23).

### 12 OUTPUT Jacks (L (MONO), R)

Connect these to your amp or audio system. For monaural output use the L/MONO jack (p. 23).

### 13 MIX IN Jack

Connect this to your CD, MD, cassette player, or other similar device (p. 53).

The sound that is input to this jack will be output from the OUTPUT jacks and the PHONES jack.

### 14 PHONES Jack

A pair of stereo headphones can be connected to this jack (p. 23).

Even when headphones are connected, sound will still be output from the output jacks.

### 15 MIDI Connectors (IN, OUT/THRU)

Use these connectors when using a MIDI sequencer, MIDI keyboard, or other MIDI device to play sounds with the TD-6, when using the TD-6 and pads to play sounds from an external MIDI sound generator, or when saving the TD-6's settings to, or loading settings from a MIDI sequencer.

### 16 HH CTRL (Hi-Hat Control) Jack

Connect a hi-hat control pedal (the optional FD-7 or FD-6; FD-6 is included with the TD-6K) here. (p. 20)

### 17 TRIGGER INPUTS

Use these inputs to connect optional pads, cymbals, and kick trigger units to the TD-6 (p. 20).

For more detailed information on each trigger input, refer to "Trigger Inputs and the Pads You Can Use" (p. 34).

### 18 Security Slot (K)

<http://www.kensington.com/>

# Making the Settings

## Mounting the TD-6 to the Stand

1

Attach the stand holder (included with the optional drum stand) to the TD-6.

Using the screws attached to the bottom panel, attach the holder so the unit is oriented as shown in the diagram.

### NOTE

Use the 8 mm screws (M5 x 8) provided with the TD-6. Use of other screws may result in damage to the unit.

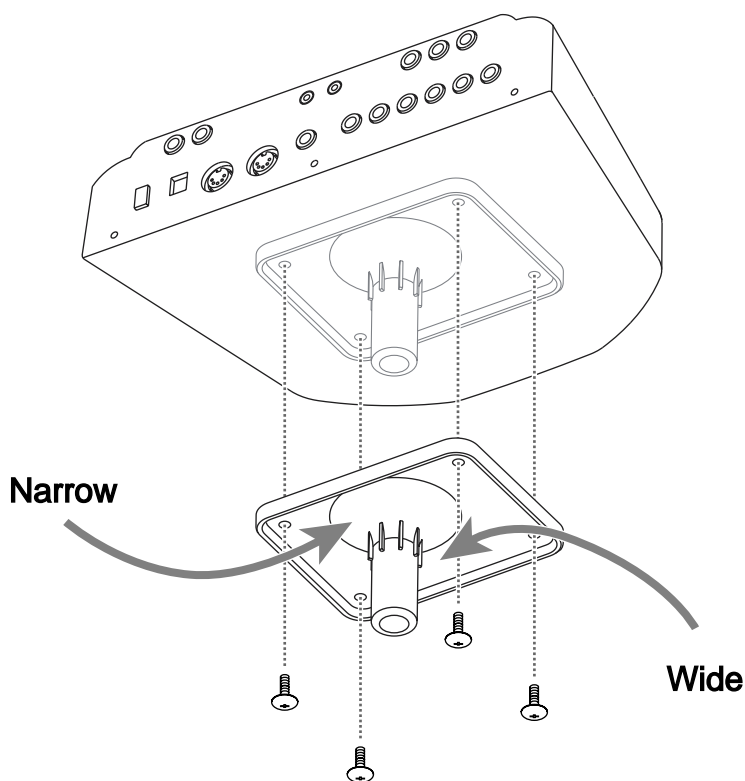

2

Attach the TD-6 and stand holder to the drum stand (such as the optional MDS-6, MDS-7U, MDS-8, or MDS-10).

For details on assembling the drum stand and attaching the TD-6, refer to the owner's manual for the drum stand.

### NOTE

- When turning the unit upside-down, get a bunch of newspapers or magazines, and place them under the four corners or at both ends to prevent damage to the buttons and controls. Also, you should try to orient the unit so no buttons or controls get damaged.
- When turning the unit upside-down, handle with care to avoid dropping it, or allowing it to fall or tip over.

### MEMO

To attach the TD-6 to a cymbal stand or other such stand, you may want to use the optional APC-33 All Purpose Clamp to secure the stand holder. It can be attached to a pipe of 10.5 mm–30 mm radius.

## Connecting the Pads and the Pedals

Using the provided cables, connect the pads, cymbal pads, hi-hat control pedal, and kick trigger unit.

Carefully refer to the numbers shown in the illustration and connect to the appropriate TRIGGER INPUT jacks on the TD-6's rear panel.

### Setting Example

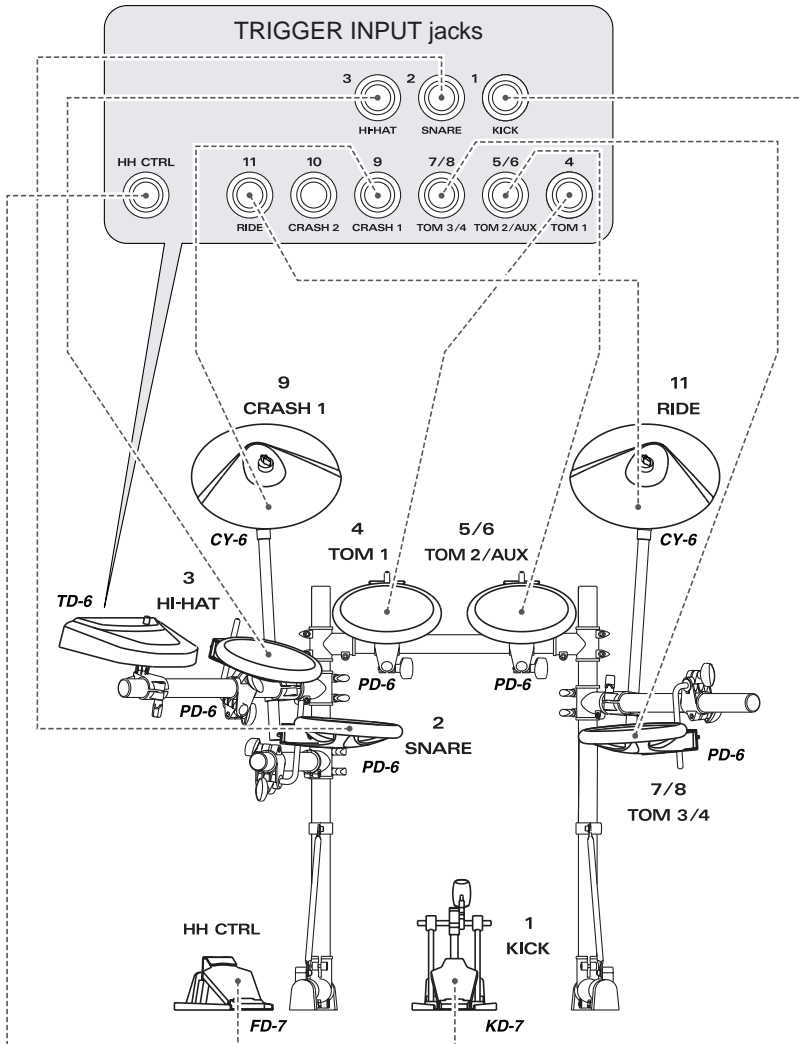

### NOTE

Before using pads with mesh heads (PD-80, PD-80R, PD-100, PD-120, KD-80, or KD-120), be sure to adjust the head tension. Striking the head when the head tension is loose may damage the sensor. For more information on adjusting the head tension, refer to the owner's manual for each pad.

### MEMO

For fullest performance expression, make exclusive use of Roland's line of optional pads (PD-5, PD-6, PD-7, PD-9, PD-80, PD-80R, PD-100, and PD-120), cymbals (CY-6, CY-12H, CY-14C, and CY-15R), and kick trigger units (KD-7, KD-80, and KD-120).

## ■ About Polarity Switch

If you are using the PD-7, PD-9, or KD-7, move the pad's polarity switch to the "- (Roland)" position. For more detailed information regarding the polarity switch, refer to your PD-7, PD-9, or KD-7 owner's manual.

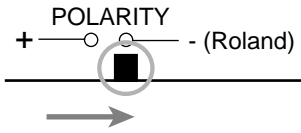

## ■ Connecting Two Pads to Trigger Inputs 5/6 (TOM2/AUX) and 7/8 (TOM3/4)

With the optional cable (PCS-31) or standard insert cable, two pads may be connected to the trigger inputs 5/6 (TOM2/AUX) and 7/8 (TOM3/4).



These trigger inputs do not handle rim sounds.

### TD-6 Rear Panel

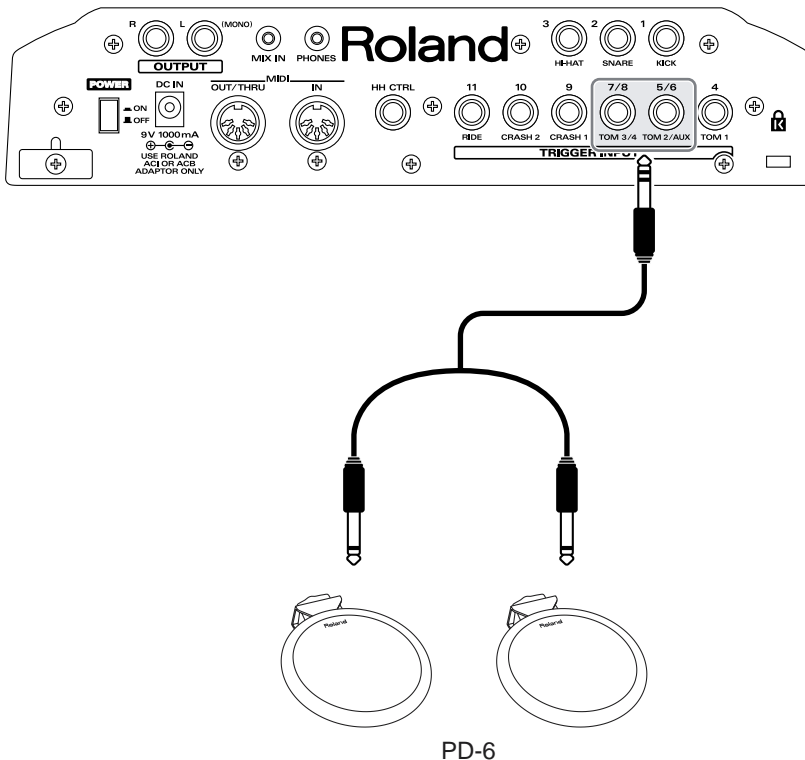

## ■ Connecting Two Kick Trigger Units

When using the KD-7 kick trigger unit (optional), you can connect two KD-7s together for twin pedal performances.

When connecting two KD-7s with the KD-7's Mix In jack, the Kick Trigger signal is slightly weakened. In this case, raise the sensitivity for the trigger inputs to which the KD-7's are connected (SETUP/TRIG BASIC/Sensitivity; p. 73).



When using two KD-7s, you cannot assign different instruments to each unit individually.

### TD-6 Rear Panel

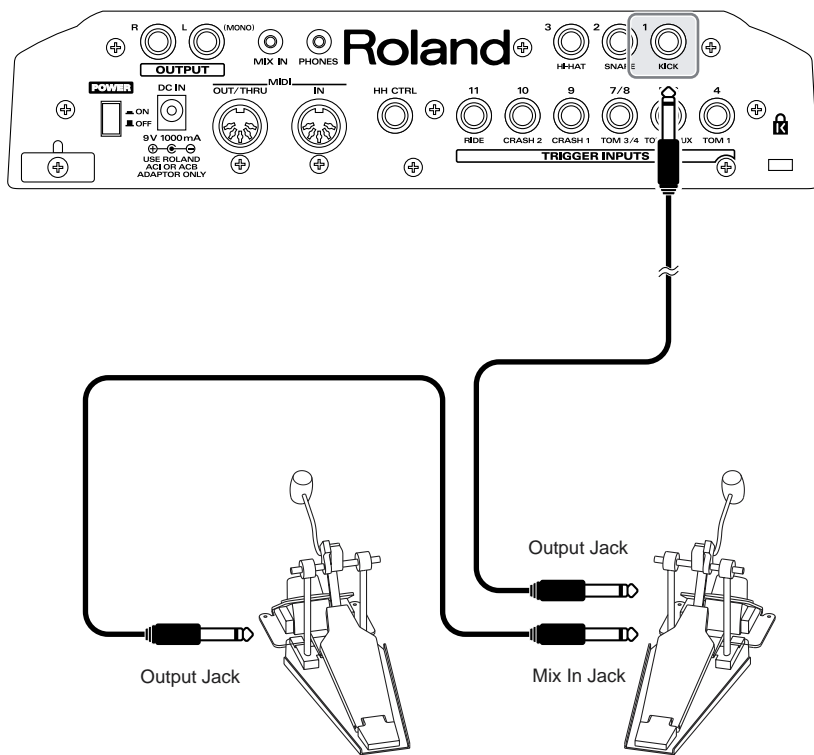

Kick Trigger Units (KD-7)  
+  
Kick Pedals

# Connecting Headphones, Audio Equipment, Amps, and Other Gear

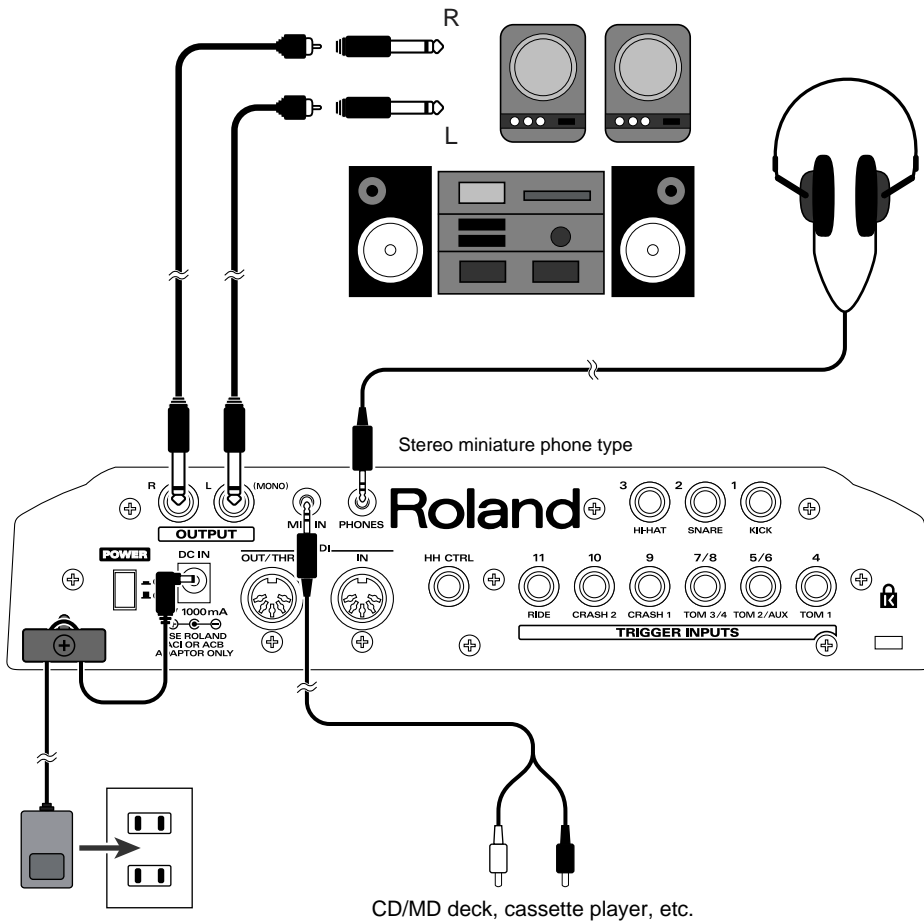

**1** Turn off the power of all devices before you make connections.

**NOTE**

To prevent malfunction and/or damage to speakers or other devices, always turn down the volume, and turn off the power on all devices before making any connections.

**2** Connect the supplied AC adaptor to the AC adaptor jack.

**3** Connect the OUTPUT L(MONO) and R jacks on the rear panel to your audio system or amp. If using headphones, connect them to the PHONES jack.

**4** Plug the AC adaptor plug into a power outlet.

**NOTE**

To prevent the inadvertent disruption of power to your unit (should the plug be pulled out accidentally), and to avoid applying undue stress to the AC adaptor jack, anchor the power cord using the cord hook, as shown in the illustration.

**HINT**

Using the TD-6's MIX IN Jack, allows you to play along with a CD or other such sound input (p. 53).

# Turning On/Off the Power

## NOTE

Once the connections have been completed (p. 23), turn on power to your various devices in the order specified. By turning on devices in the wrong order, you risk causing malfunction and/or damage to speakers and other devices.

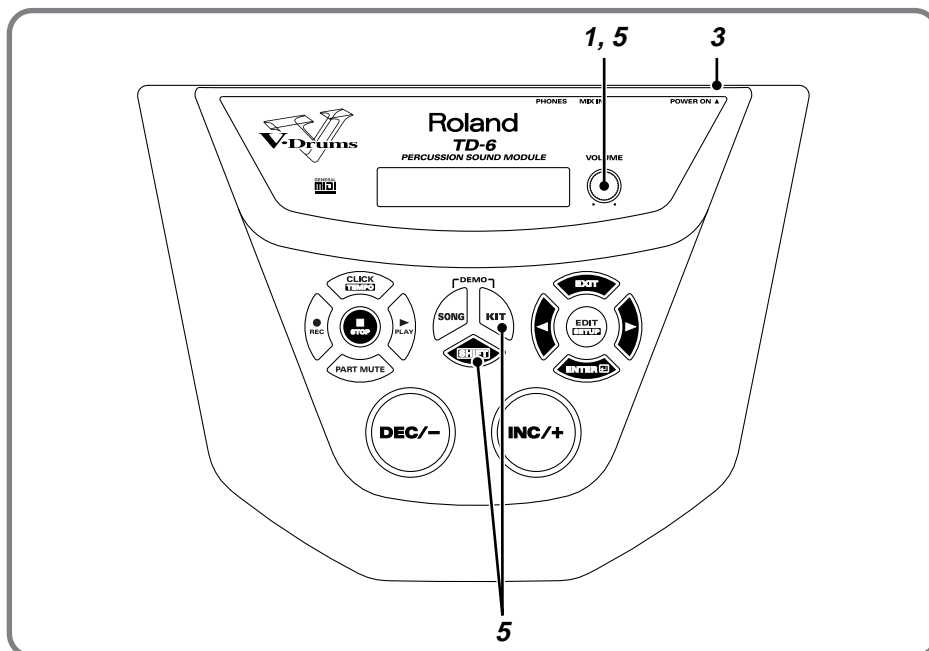

- 1 Turn the [VOLUME] knob completely to the left to lower the volume to the minimum level.
- 2 Turn down the volume control on the connected amp or audio system.
- 3 Press the [POWER] button to turn on the power.

## Precautions When Turning on the Power

After the power is turned on, the drum kit name (shown in the following figure) appears in the display; do NOT press any pad or pedal until [KIT] has lighted.



## NOTE

This unit is equipped with a protection circuit. A brief interval (a few seconds) after power up is required before the unit will operate normally.

## MEMO

If the hi-hat control pedal (the optional FD-7; or for the TD-6K exclusively, the FD-6) is pressed when the power is turned on, control of the hi-hat's opening and closing will not work correctly. Striking the pads when turning on the power degrades the pad response when the pads are struck lightly.



**4** Turn on the power to the connected amp or audio system.

**5** Press [SHIFT] + [KIT] or strike the pad, and while listening to the sound, gradually bring up [VOLUME] to adjust the volume level.  
Also raise the volume level of the connected amp or audio system to the appropriate level.

### **No Sound Even When Pressing [SHIFT] + [KIT]**

**Check the following points.**

#### **When Using an Amp or Audio System**

- Is the amp or audio system volume setting correct?
- Are the TD-6 and the amp or audio system connected correctly?
- Is there a problem with any connector cable?
- Have the input select settings of your audio system or amp been made correctly?

#### **When using headphones:**

- Are the headphones connected to the [PHONES] jack?



#### **Caution Concerning Volume**

If the volume levels used when striking the pads are left unchanged when playing back demo songs or other songs, the volume may increase suddenly, which may cause ear pain and damaged speakers. Before playing back songs or patterns, rotate the [VOLUME] knob counterclockwise to lower the volume levels, then readjust to a suitable volume while listening to the playback.

## Turning Off the Power

---

**1** Completely turn down the volume of the TD-6 and any connected external devices.

**2** Turn off the power to all external devices.

**3** Press the TD-6's [POWER] switch to turn off the power.

# Restoring the Factory Settings (Factory Reset)

This restores the pad and instrument settings, song data, and other information stored in the TD-6 to the original factory settings.

## NOTE

All data and settings stored in the TD-6 are lost in carrying out this operation. Use the “Bulk Dump” operation to save crucial data and settings to an external MIDI device (SETUP/BULK DUMP/ Bulk Dump; p. 103).

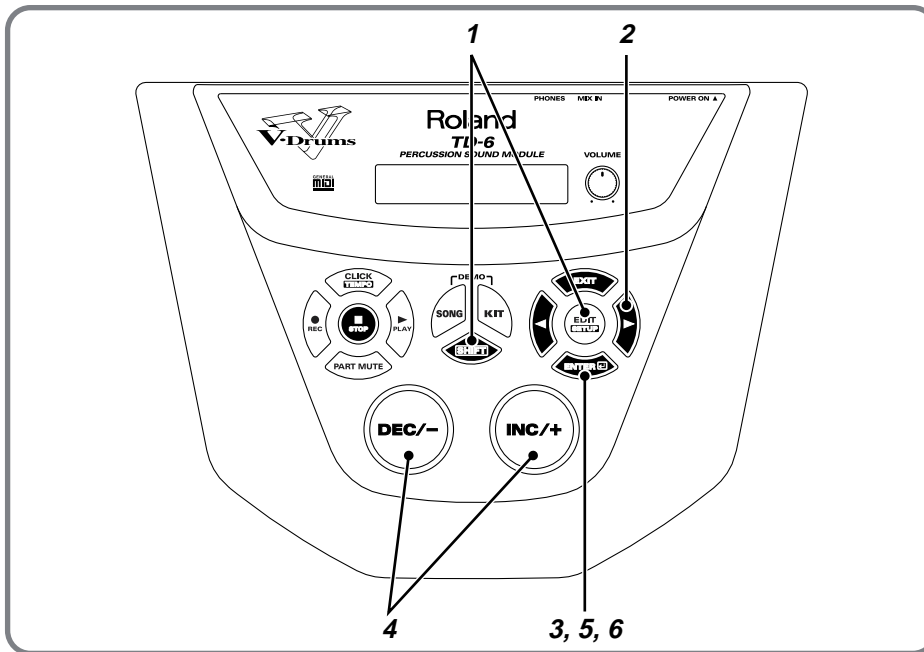

- 1 While holding down [SHIFT], press [EDIT (SETUP)].  
[EDIT (SETUP)] lights.

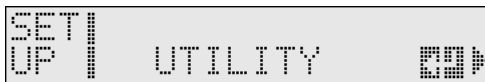

- 2 Press [▶] to select “FactoryReset.”



- 3 Press [ENTER].

The Factory Reset screen appears.

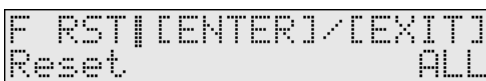

## HINT

When [SHIFT] and [EDIT (SETUP)] are held down when the power is turned on, the display jumps to the Factory Reset screen. When carrying out Factory Reset, read from Step 4.

**4**

Press [INC/+] or [DEC/-] to select the parameter you want to restore to factory settings.

Here, select “ALL” to restore all of the settings to the original factory values.

**ALL:**

All internal settings will be restored to the factory settings.

**THIS DRUM KIT:**

Only the settings for the currently selected drum kit are restored to the factory settings.

**ALL DRUM KITS:**

The settings for all of the TD-6’s internal drum kits are restored to the factory settings.

**ALL SONGS:**

All of the TD-6’s internal song data is restored to the factory settings.

**5**

Press [ENTER] [ ] .

The confirmation screen appears.



```
Are You Sure?  
[ENTER] / [EXIT]
```



Press [EXIT] to cancel the operation.

**6**

If you’re ready to proceed, press [ENTER] [ ] , and the Factory Reset operation will be executed.

**7**

When the Factory Reset is finished, the Completed screen appears.

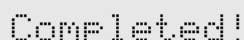

```
Completed!
```

# Listening to the Demo Songs

The TD-6 features four demo songs demonstrating the TD-6's sounds and expressive capabilities.

The drums played on the demo songs were played in real time into a sequencer.

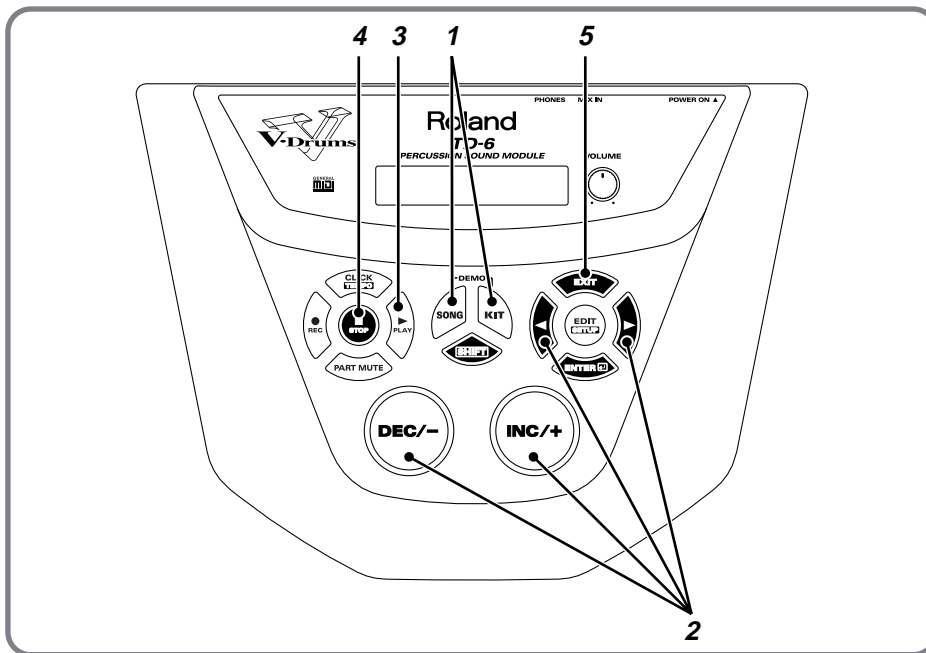

1

While holding down [KIT], press [SONG].

The "DEMONSTRATION" screen appears.

```
TD-6 DEMONSTRATION
1. CREOLET1
```

## NOTE

- All rights reserved. Unauthorized use of this material for purposes other than private, personal enjoyment is a violation of applicable laws.
- No data for the music that is played will be output from MIDI OUT.

**2**

Press [INC/+] or [DEC/-], or press [ ◀ ] or [ ▶ ] to select the song to play back.

**1. CREOLET1**

Copyright © 2001, Roland Corporation  
Drum kit being used: #72 “RoseWood”

**2. CREOLET2**

Copyright © 2001, Roland Corporation  
Drum kit being used: #20 “Natural”

**3. TC R&B**

Copyright © 2001, Roland Corporation  
Drum kit being used: #1 “AcuStick”

**4. SNAG LTN**

Copyright © 2001, Roland Corporation  
Drum kit being used: #3 “Groove”

**3**

Press [PLAY ▶ ].

Playback of the demo songs begins, and the four demo songs are played continuously in sequence.

**4**

When you want to stop the performance, press [STOP ■ ].

**5**

When you have finished listening to the demo song, press [KIT], [SONG] or [EXIT].

**NOTE****Caution Concerning Volume**

If the volume levels used when striking the pads are left unchanged when playing back demo songs, the volume may increase suddenly, which may cause ear pain and damaged speakers. When playing back demo songs, rotate [VOLUME] to the left (counterclockwise) to bring the volume level back down, then while playing back the song, readjust the volume to an appropriate level.

# Selecting the Pad Type

Make the settings for the type of pads to be used (**trigger type**) to ensure that the TD-6 accurately receives what is being played on the pads.

Set each trigger input as described below.

**Settings optimized for the TD-6K are provided in factory settings on the TD-6.**

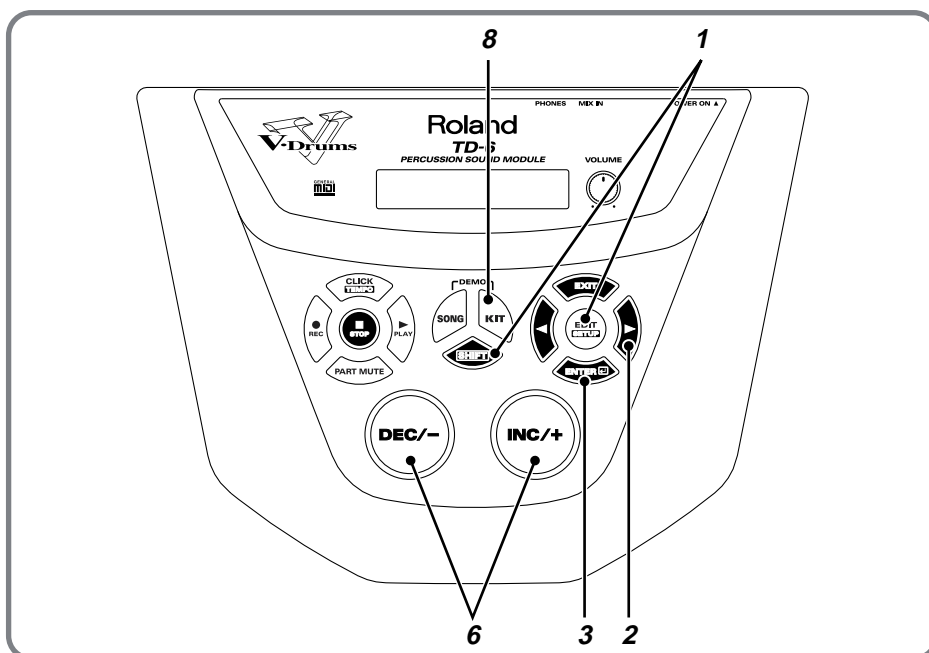

## MEMO

The following parameters are automatically set to the most efficient values for each pad when you select the trigger type.

### Basic Trigger Parameters (SETUP/TRIG BASIC; p. 72)

- Sensitivity
- Threshold
- TrigCurve

### Advanced Trigger Parameters (SETUP/TRIG ADVNCD; p. 74)

- Scan Time
- Retrig Cancel
- Mask Time
- Rim Sens



For the most suitable values for each trigger type, refer to p. 36.

## NOTE

You may need to adjust the value since these are just the reference value.

**1**

While holding down [SHIFT], press [EDIT (SETUP)].

[EDIT (SETUP)] lights.



**2**

Press [▶] to select "TRIG BASIC."



**3**

Press [ENTER].



4

Strike the pad you wish to set.

The setting screen for the struck pad appears.



**HINT**

You can also make the selection by pressing [SHIFT] + [◀] or [SHIFT] + [▶] (Trigger Select).

5

Select the most suitable trigger type from the following chart for the pad you are using.

Pad	Trigger Type	Pad	Trigger Type
PD-5	PD7/9	CY-6	CY6
PD-6	PD6	CY-12H	CY Type
PD-7	PD7/9	CY-14C	CY Type
PD-9	PD7/9	CY-15R	CY Type
PD-80	PD80/100	KD-5	KD7
PD-80R	PD80R	KD-7	KD7
PD-100	PD80/100	KD-80	KD Type
PD-120	PD120	KD-120	KD Type

6

Press [INC/+] or [DEC/-] to select the trigger type.

7

Repeat Steps 4–6 to set the trigger type for each pad.

8

Press [KIT].

[KIT] lights, and the Drum Kit screen appears.



9

Strike the pads and press the pedals to check the following.

- Are sounds being played with all pads and pedals?
- Is the right instrument for each pad being played?

If the correct sound is not being played, check the pad settings once more and refer to “Troubleshooting” (p. 110).

**MEMO**

These settings apply to both the head and the rim.

# Adjusting the Sensitivity of the Pad

You may wish to adjust the sensitivity of the pads to accommodate your personal taste and style of performing. Adjusting the TD-6's sensitivity allows you to change the correlation between your playing velocity (strength) and the response and volume of the sound.

## MEMO

The sensitivity setting is automatically set to the most efficient values for each pad when you select the trigger type (p. 30). Adjust as needed.

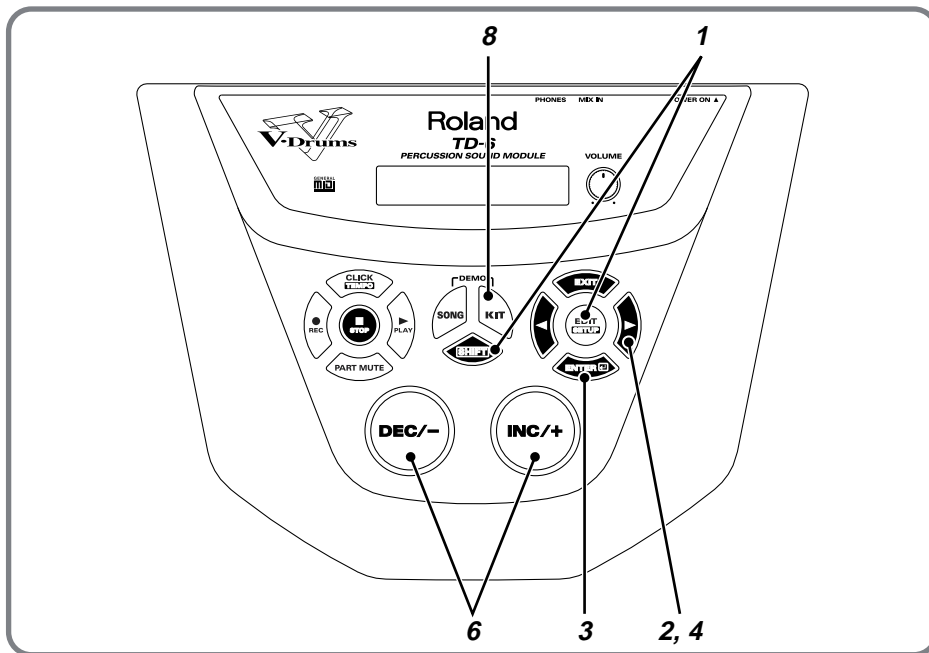

- 1 While holding down [SHIFT], press [EDIT (SETUP)].  
[EDIT (SETUP)] lights.



- 2 Press [▶] to select "TRIG BASIC."



- 3 Press [ENTER].



- 4** Press [ ▶ ] to select “Sensitivity.”



- 5** Strike the pad you wish to set.  
The setting screen for the struck pad appears.



- 6** Press [INC/+] or [DEC/-] to adjust the sensitivity of the pads.  
Here you can make a setting of 1-16.  
Higher settings result in higher sensitivity, so that the pad will produce a loud volume even when struck softly.  
Lower settings result in lower sensitivity, so that the pad will produce a low volume even when struck forcefully.

**Setting the Overall Target**

Set the sensitivity so that the indicator reaches the maximum position when you play with your maximum dynamics. A flag, such as shown in the following, is raised when the indicator reaches the maximum position (→ → [ ]).

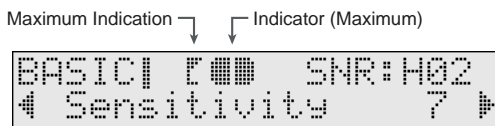
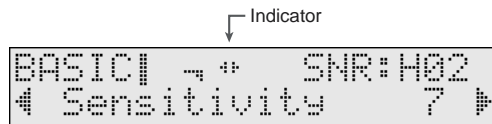

- 7** Repeat Steps 5 and 6 to make any other necessary pad sensitivity adjustments.

- 8** Press [KIT].  
[KIT] lights, and the Drum Kit screen appears.



**HINT**

You can also make the selection by pressing [SHIFT] + [ ◀ ] or [SHIFT] + [ ▶ ] (Trigger Select).

**MEMO**

These settings apply to both the head and the rim.

**MEMO**

With electronic drum kits, overall volume is another important element. Listening at low volumes may make it seem that there is too little change in volume, so you might raise the sensitivity excessively without really needing to. In order to make these settings correctly, adjust the volume of amps or headphones to appropriate levels.

# About the Pads

## Trigger Inputs and the Pads You Can Use

Although you can use previous model pads, kick trigger units, and other such devices with the TD-6, there may be incompatibilities between pads and trigger inputs, which may prevent you from being able to perform on some pads.

### ■ Trigger Input Functions

The following shows the available trigger input functions.

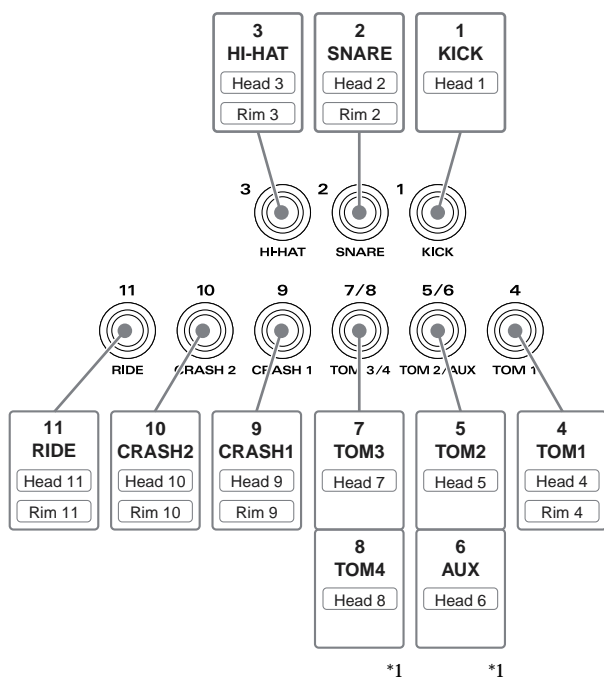

### NOTE

Use the cable provided with the pad to connect the pad to the TD-6. The rim sound becomes unavailable when you use a monaural cable to connect a pad that is capable of playing rim shots and chokes.

\*1: By using an optional cable (the PCS-31) or standard insert cable, you can use two pads to a single trigger input jack. When using the cable provided with the pad to connect a single pad, use "Trigger Input 5 (TOM2)" and "Trigger Input 7 (TOM 3)". For more on how to make the necessary connections, refer to p. 21.

## Combinations of Pad and Trigger Type

To enjoy full use of all the functionality offered by the TD-6 and your pads, be sure to review the following chart and select the pads best suited for your aims.

			Trigger Input Jacks										
			1 (KIK)	2 (SNR)	3 (HH)	4 (T1)	5 (T2)	6 (AUX)	7 (T3)	8 (T4)	9 (CR1)	10 (CR2)	11 (RD)
Kick Trigger Units	KD-5	Head	O	O	O	O	O	O	O	O	O	O	O
	KD-7	Head	O	O	O	O	O	O	O	O	O	O	O
	KD-80	Head	O	O	O	O	O	O	O	O	O	O	O
	KD-120	Head	O	O	O	O	O	O	O	O	O	O	O
Pads	PD-5	Head	O	O	O	O	O	O	O	O	O	O	O
	PD-6	Head	O	O	O	O	O	O	O	O	O	O	O
	PD-7	Head	O	O	O	O	O	O	O	O	O	O	O
		Rim, Choke	/	O	O	O	/	/	/	/	O	O	O
	PD-9	Head	O	O	O	O	O	O	O	O	O	O	O
		Rim, Choke	/	O	O	O	/	/	/	/	O	O	O
	PD-80	Head	O	O	O	O	O	O	O	O	O	O	O
	PD-80R	Head	O	O	O	O	O	O	O	O	O	O	O
		Rim	/	O	X	X	/	/	/	/	X	X	X
	PD-100	Head	O	O	O	O	O	O	O	O	O	O	O
PD-120	Head	O	O	O	O	O	O	O	O	O	O	O	
	Rim	/	O	X	X	/	/	/	/	X	X	X	
Cymbals	CY-6	Head (Bow)	O	O	O	O	O	O	O	O	O	O	O
		Rim (Edge), Choke	/	O	O	O	/	/	/	/	O	O	O
	CY-12H	Head (Bow)	O	O	O	O	O	O	O	O	O	O	O
		Rim (Edge), Choke	/	O	O	O	/	/	/	/	O	O	O
	CY-14C	Head (Bow)	O	O	O	O	O	O	O	O	O	O	O
		Rim (Edge), Choke	/	O	O	O	/	/	/	/	O	O	O
CY-15R *1	Head (Bow)	O	O	O	O	O	O	O	O	O	O	O	
	Rim (Edge/Bow), Choke	/	O	O	O	/	/	/	/	O	O	O	

\*2

O: Can be used.

X: Cannot be used.

Slash: These trigger inputs do not handle rim sounds.

\*1: When choking is applied to the CY-15R, you can then play either edge shots or bell shots.

\*2: TRIGGER INPUTS 6 (AUX) and 8 (TOM) can only be used when using an optional cable (PCS-31) or standard insert cable to connect two pads to one trigger input jack. For more detailed information, refer to the previous section.

## ■ Recommended Parameters for the Pads

The trigger parameters (except the Xtalk Cancel) are automatically set to the most efficient values for each pad when you select the trigger type.

You may need to adjust the value since these are just the reference value. Make settings for the parameters as needed (Basic Trigger Parameters: p. 72; Advanced Trigger Parameters: p. 74).

Pad		TrigType	Basic Trigger Parameters				Advanced Trigger Parameters			
			Sensitivity	Threshold	TrigCurve	Xtalk Cancel	Scan Time	Retrig Cancel	Mask Time	Rim Sens
Kick Trigger Unit	KD-5	KD7	8	5	LINEAR	20	2.0	5	8	
	KD-7	KD7	8	5	LINEAR	20	2.0	5	8	
	KD-80	KD Type	10	4	LINEAR	20	2.0	5	4	
	KD-120	KD Type	10	4	LINEAR	20	2.0	5	4	
Pad	PD-5	PD7/9	8	3	LINEAR	40	0.5	3	4	
	PD-6	PD6	7	3	LINEAR	40	1.0	3	4	
	PD-7	PD7/9	8	3	LINEAR	40	0.5	3	4	
	PD-9	PD7/9	8	3	LINEAR	40	0.5	3	4	
	PD-80	PD80/100	8	3	LINEAR	40	1.0	3	4	
	PD-80R	PD80R	8	1	LINEAR	40	1.0	3	4	11
	PD-100	PD80/100	8	3	LINEAR	40	1.0	3	4	
PD-120	PD120	9	1	LINEAR	20	1.6	3	4	7	
Cymbal	CY-6	CY6	10	3	LINEAR	30	2.0	3	8	
	CY-12H	CY Type	10	3	LINEAR	30	0.5	3	8	
	CY-14C	CY Type	10	3	LINEAR	30	0.5	3	8	
	CY-15R	CY Type	10	3	LINEAR	30	0.5	3	8	
Others	Other 1		8	3	LINEAR	40	1.5	3	4	
	Other 2		8	3	LINEAR	40	3.0	3	8	
	AcDrTrig		12	5	LINEAR	40	3.0	3	12	

### NOTE

The “Xtalk Cancel (Crosstalk Cancel)” value does not change when the trigger type is changed. It should be adjusted as necessary to match the actual state of your configuration and the environment in which it is being used (SETUP/TRIG BASIC/Xtalk Cancel; p. 74).



- For details about “Other 1” and “Other 2,” refer to p. 72.
- Use the “AcDrTrig” setting when you use acoustic drums to sound the TD-6. For details refer to “Using the TD-6 with Acoustic Triggers” (p. 76).

# Playing the Pads

## ■ Pad Head Shots and Rim Shots

When you perform a head shot, the head instrument is played; rim shots produce the sound of the rim instrument.

To play a rim shot, you must **strike both the head and the rim of the pad simultaneously**.

**PD-7, PD-9, PD-80R, PD-120:**

Both head and rim shots are available.

**PD-5, PD-6, PD-80, PD-100:**

Only head shots are available

### Head Shot

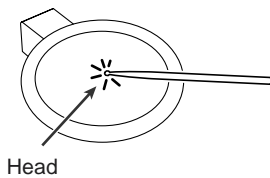

### Rim Shot

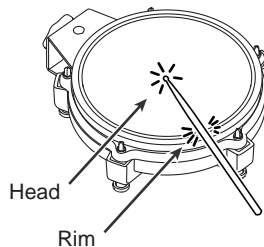
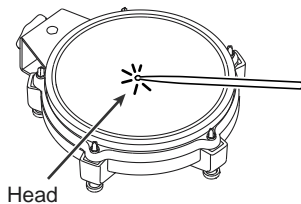
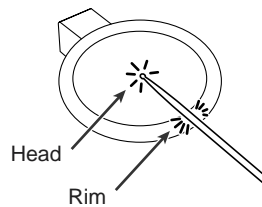

## ■ Cross Stick

When you perform a cross stick, the rim instrument is played.

When using the PD-80R or PD-120 to play the cross stick, be sure that you only strike the rim (outer edge) of the pad. Placing your hand on the head (center area) of the pad prevents the cross stick sound from being played properly.

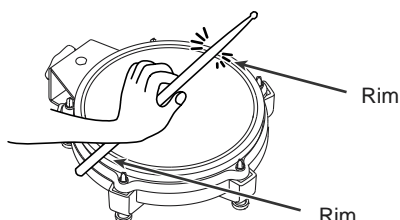

### MEMO

When using rim shots on the PD-80R or PD-120, connect the pad to **TRIGGER INPUT 2 (SNARE)**.

### MEMO

- When using rim shots on the PD-80R or PD-120, connect the pad to **TRIGGER INPUT 2 (SNARE)**.
- The cross stick is also referred to as a “closed rim shot.”

### HINT

By selecting the instruments with “XS” after the instrument name, playing a rim shot produces a rim shot tone, and cross sticking gives a cross stick tone.

## ■ Cymbal Bow Shots/Edge Shots/Bell Shots

When you perform a bow shot, the head instrument is played; edge shots and bell shots produce the sound of the rim instrument.

### CY-6, CY-12H, CY-14C:

Capable of bow shots and edge shots.

### CY-15R:

In addition to bow shots, either edge shots or bell shots can be played. Bell shots are played by striking the bell with the shoulder of the stick.

### MEMO

When playing edge shots with the CY-15R, use the BOW/EDGE output; for bell shots, use the BOW/BELL output.

**Bow Shot**

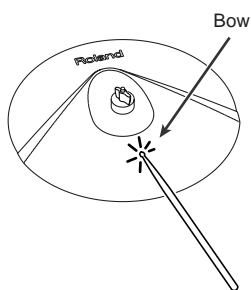

**Edge Shot**

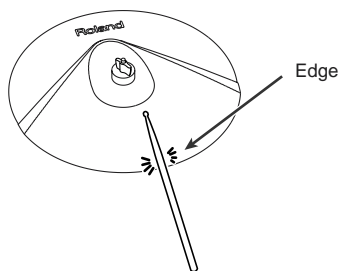

**Bell Shot**

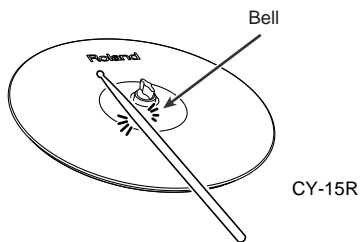

## ■ Cymbal Choke

By striking a pad and then squeezing the rim portion of the pad, you can mute the note while the note is still sounding. This performance technique is known as **choking**.

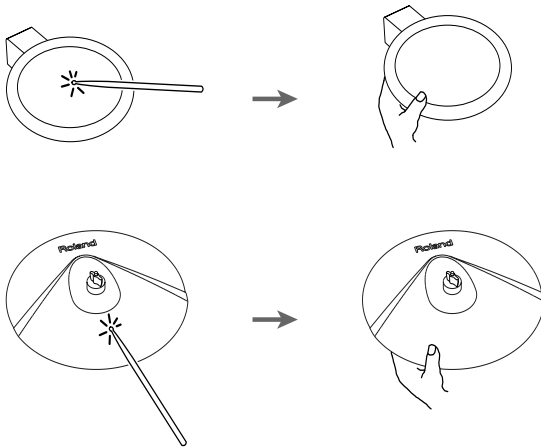

## Hi-Hat Control Pedal

By connecting a hi-hat control pedal (the optional FD-7; or for the TD-6K exclusively, the FD-6), you can obtain consecutive control of the hi-hat's opening and closing.

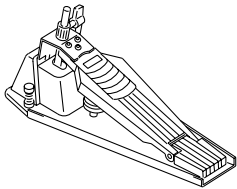

FD-7

### Open Hi-Hat:

Strike the hi-hat without pressing the pedal

### Closed Hi-Hat:

Strike the hi-hat with the pedal pressed

### Foot Open:

Completely press down the pedal

### Foot Closed:

Press the pedal and then immediately release it







PERCUSSION SOUND MODULE **TD-6**

# Quick Start

# Choosing a Drum Kit

The TD-6 comes with 99 preset drum kits. Now's probably a good time for you to try out the drum kits by selecting and playing them.

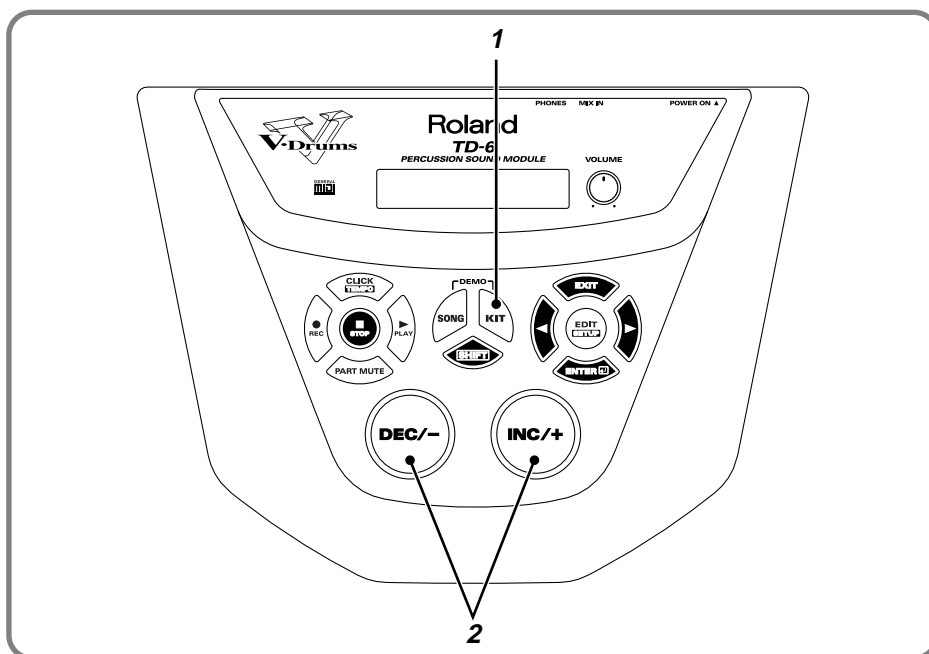

**1** Press [KIT].

[KIT] lights, and the “DRUM KIT” screen appears.

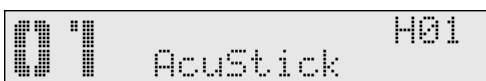

**2** Press [INC/+] or [DEC/-] to select the drum kit.

## Pattern Inadvertently Starts Playing When Pad is Struck

Drum kits feature a setting whereby a pad can be struck to start playback of a song (Pad Pattern function; p. 65).

- **To stop the song currently playing:**  
Press the [STOP ■] button on the panel (the [PLAY ►] light goes off).
- **To stop the song from playing when the pad is struck:**  
Turn the Pad Pattern feature off (KIT/CONTROL/PadPtn; p. 65).



To see which drum sets can be selected here, refer to “Drum Kit List” (p. 118).



A **drum kit** is a collection of settings that includes each pad’s instrument settings, the effect settings, and other settings. For details, refer to p. 56.



A drum kit performance is recorded in preset song #1 “DRUMS.”

By switching drum kits during playback of preset song #1 (p. 46), you can listen to and compare a variety of different drum kits.



To see which drum set using the Pad Pattern function, refer to “Drum Kit List” (p. 118).

# Playing While Listening to the Metronome/Click

## Switching the Click On and Off

Try using metronome (click).

You can switch the click sound on and off by pressing [CLICK].

[CLICK] lights when set to play the sound.

Click is played



Lit

Click is not played



Unlit



You can select the instrument sound and beat used for the click. For details, refer to the p. 80.

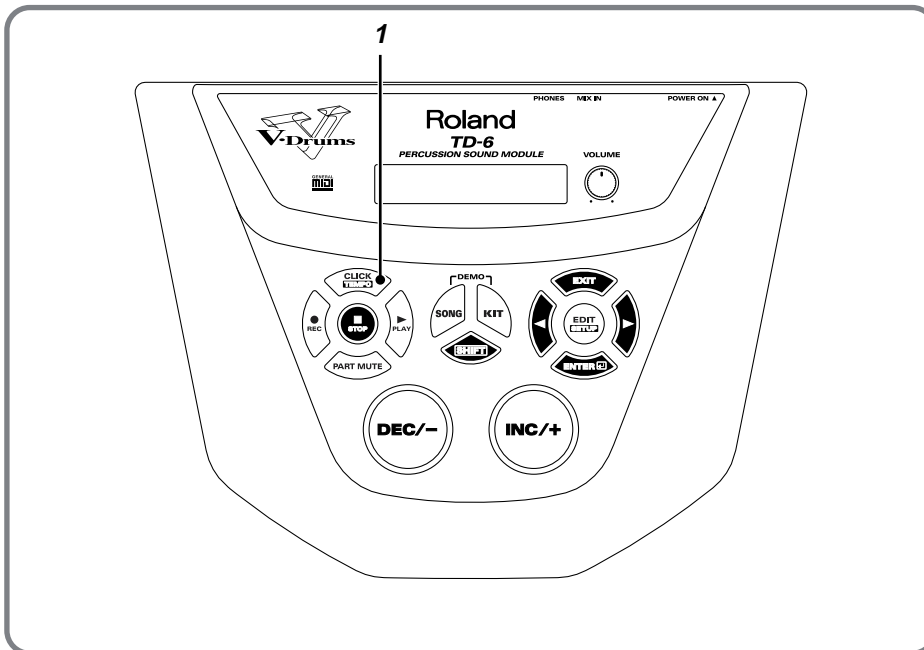

1

Press [CLICK].

[CLICK] lights, and the click sound begins to play.



## Adjusting the Click Volume (Level)

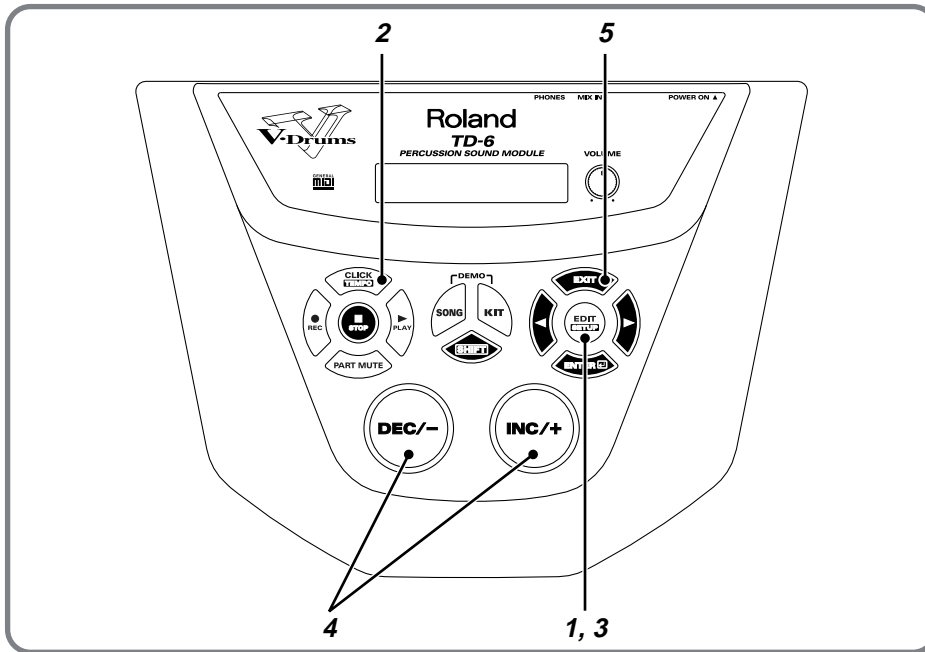

- 1 Confirm that [EDIT] is not lit.  
If [EDIT] lights, you can press [KIT] or [SONG] to turn it off.



- 2 Press [CLICK].  
[CLICK] lights, and the click sound begins to play.



- 3 Press [EDIT].  
[EDIT] lights, and the click volume settings screen appears.



```
CLICK!
Click Level 100 #
```

- 4 Press [INC/+] or [DEC/-] to select the volume.
- 5 When you finish making settings, press [EXIT] to end the procedure.

## Adjusting the Click Tempo

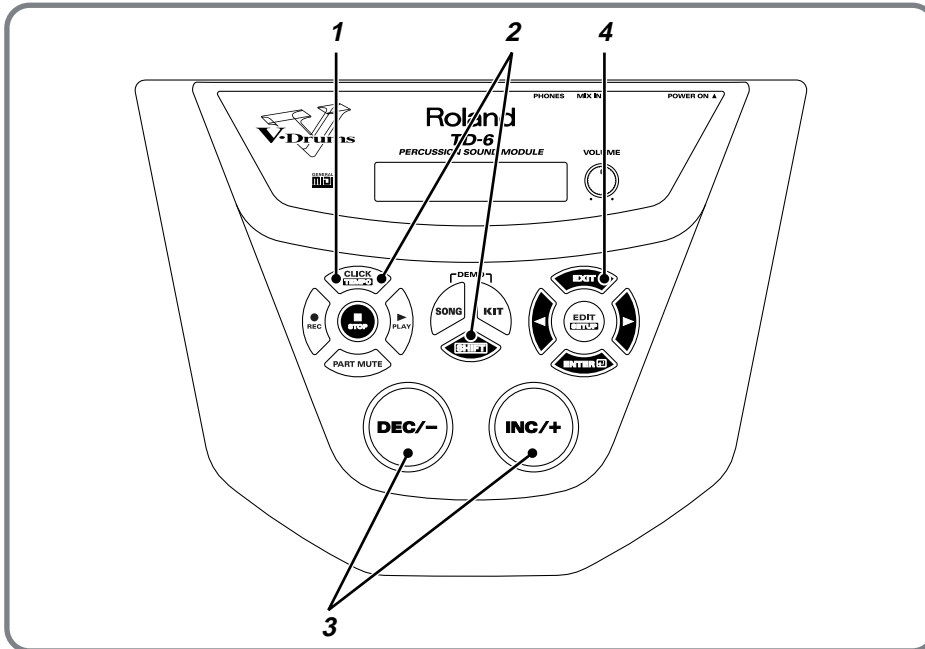

- 1 Press [CLICK].  
[CLICK] lights, and the click sound begins to play.



- 2 While holding down [SHIFT], press [CLICK (TEMPO)].  
The Tempo screen appears.

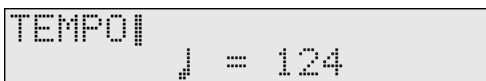

- 3 Press [INC/+] or [DEC/-] to select the tempo.
- 4 When you finish making settings, press [EXIT] to end the procedure.  
The “Tempo” screen is removed from the display.

# Playing Along with Songs

## Choosing a Song and Playing Back

The TD-6 features a sequencer that can record and play back accompaniment tracks and drum performances.

This sequencer comes loaded with 150 Preset (internal) songs.

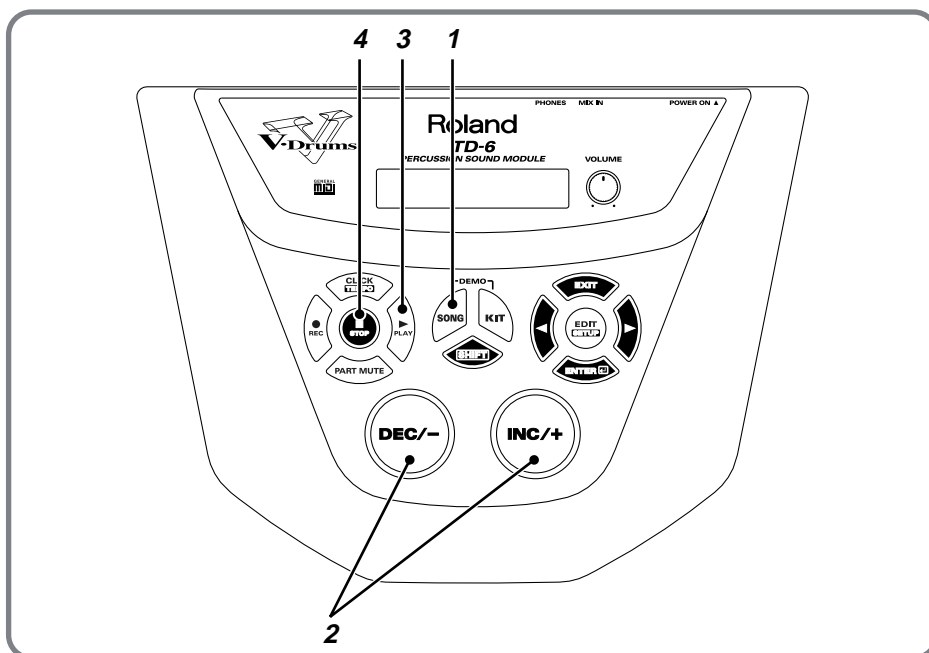

### HINT

You can record songs yourself. For details, refer to the p. 93.

### NOTE

**The song stops suddenly when playing the pads:** Striking the pad set the pad pattern function while a song is playing back will cause song playback to switch to the newly selected song. Some “songs” are very short, a few notes, or even one chord. So “sudden” stops can be caused by accidentally triggering one of these short songs. For more on this function, refer to p. 65 and p. 114.

## ■ Choosing a Song

1

Press [SONG].

[SONG] lights, and the SONG screen appears.



DRUMS	4/4	53
001 DRUMS	001-01	

2

Press [INC/+] or [DEC/-] to select the song.



To see which songs can be selected here, refer to “Preset Song List” (p. 128).

### HINT

By holding down [SHIFT] and pressing [INC/+] or [DEC/-], you can select the song category.

## ■ Playing Back a Song

- 3** Press the [PLAY ►] button, and the song will begin playing.  
[PLAY ►] lights.



- 4** To stop playback of the song, press [STOP ■].  
The [PLAY ►] light goes out.



When playback of a song is stopped, you can do the following.

- Pressing [STOP ■], returns you to the beginning of the song.
- Pressing [►], advances you to the next measure.
- Pressing [◀], returns you to the previous measure.

### Convenient Function for Playback

When playing back a Preset song, you can have the buttons corresponding to the drums being played light up.

You can also have the buttons light even when drum tones are muted, making this convenient for practicing with the Preset songs.

1. Hold down [SHIFT] and press [PLAY ►].  
Playback of the song begins, and the buttons corresponding to the performance of the percussion part drums light up.

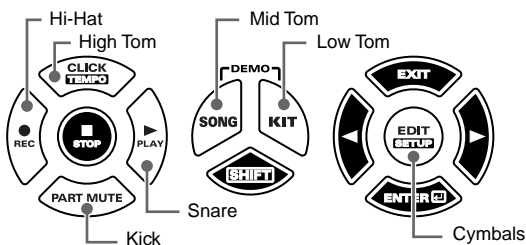

2. To stop the playback, press [STOP ■].



For details, refer to p. 84.



This function cannot be used with songs in which drum performances are recorded to the drum kit part. (The performance of the preset song #1 “DRUMS” is recorded to the drum kit part.)

## Adjusting the Song Volume

You can adjust the song volume to correct the drum kit volume balance. Song volume consists of the two following adjustments.

### Backing Volume:

Adjusts the volume of melodic instruments etc. other than percussion.

### Percussion Part Volume:

Adjusts the volume of the drums and percussion sounds.



The volume set here is applied to all songs.

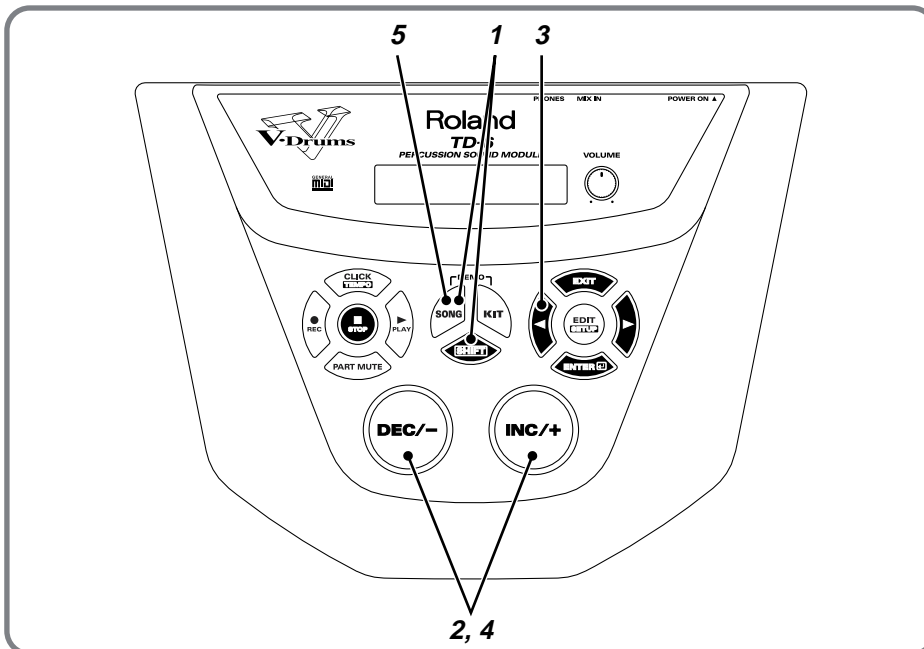

### ■ Setting the Backing Part (Melodic Instruments etc.) Volume

1

While holding down [SHIFT], press [SONG].

The screen for setting the volume level of the melodic instruments etc. appears.

```
UTILITY|
4 BackingLevel 100 ▶
```

2

Press [INC/+] or [DEC/-] to select the volume.

### ■ Setting the Drums and Percussion Volume

3

Press [◀].

The screen for setting the volume level of the drums and percussion appears.

```
UTILITY|
4 PercPrtLevel 100 ▶
```



- The volume balance among the parts is adjusted in the “Level” (SONG/PART/Level; p. 89)
- Here, adjust the volume of the percussion part. Although drum performances in the Preset songs are recorded to the percussion part (except for preset song #1 “DRUMS”), when you create your own songs, what you play on the pads is recorded to the drum kit part. The volume level of the drum kit part is adjusted in the “MasterVolume” (Master Volume) (KIT/COMMON/MasterVolume; p. 68).



- 4 Press [INC/+] or [DEC/-] to select the volume.
- 5 When you finish making settings, press [SONG] to end the procedure.

## Temporarily Changing the Tempo of a Song

You can temporarily change the tempo of a song while playback is in progress. The song returns to its preset tempo when a different song is selected.

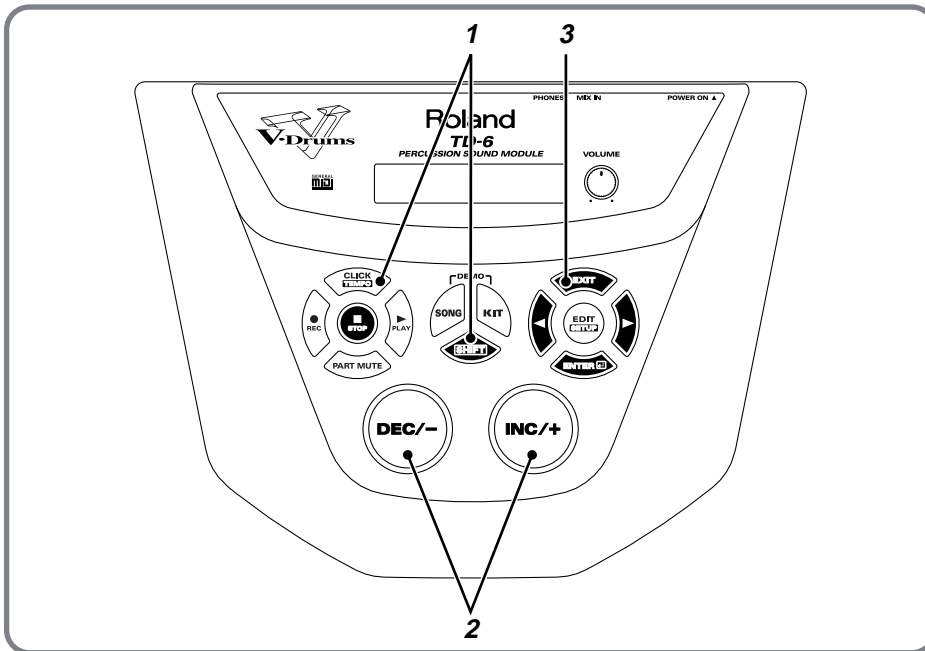

- 1 While holding down [SHIFT], press [CLICK (TEMPO)].  
The Tempo settings screen appears.

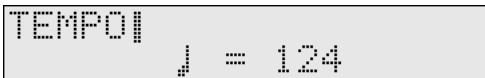

- 2 Press [INC/+] or [DEC/-] to select the tempo.
- 3 When you finish making settings, press [EXIT] to end the procedure.

## Muting the Pre-programmed Drums in Songs

You can mute just the drums recorded in a song. So you can play along.  
Try this using Song #8, “URBAN.”

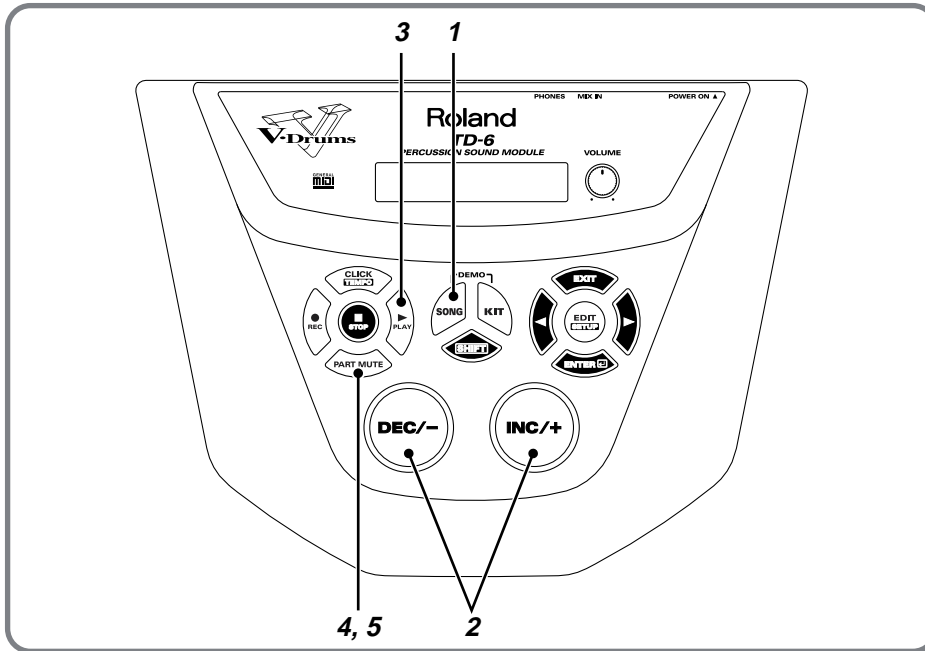

**1** Press [SONG].

[SONG] lights, and the SONG screen appears.



DRUMS	4/4	50
001 DRUMS		001-01

**2** Press [INC/+] or [DEC/-] to select Song #8.

ROCK	4/4	-+
020 URBAN		001-01

### MEMO

Part Mute settings remain in effect even when the song is switched.

### NOTE

Note numbers for muted drum sounds are predetermined and cannot be changed.



Refer to p. 125 for a list of mute note numbers.

- 3** Press the [PLAY ▶] button, and the song will begin playing.  
[PLAY ▶] lights.



- 4** Press [PART MUTE].  
[PART MUTE] lights, and the drum sound are muted.



- 5** To hear the drums, press [PART MUTE] once more.  
The [PART MUTE] light goes out.

**MEMO**

At the factory settings, pressing [PART MUTE] mutes only percussion part drum tones.

**HINT**

By pressing [SHIFT] + [PART MUTE], you can change the part to be muted (SETUP/UTILITY/Mute; p. 78).

# Using the Pads to Play Songs

The pads can also be set so that they start the performance of songs when struck (**Pad Pattern function**).

This function is available only with electronic drums.

The Pad Pattern function is already selected in Drum Kit #14, "1ManBand."

Use this kit to try out this function.

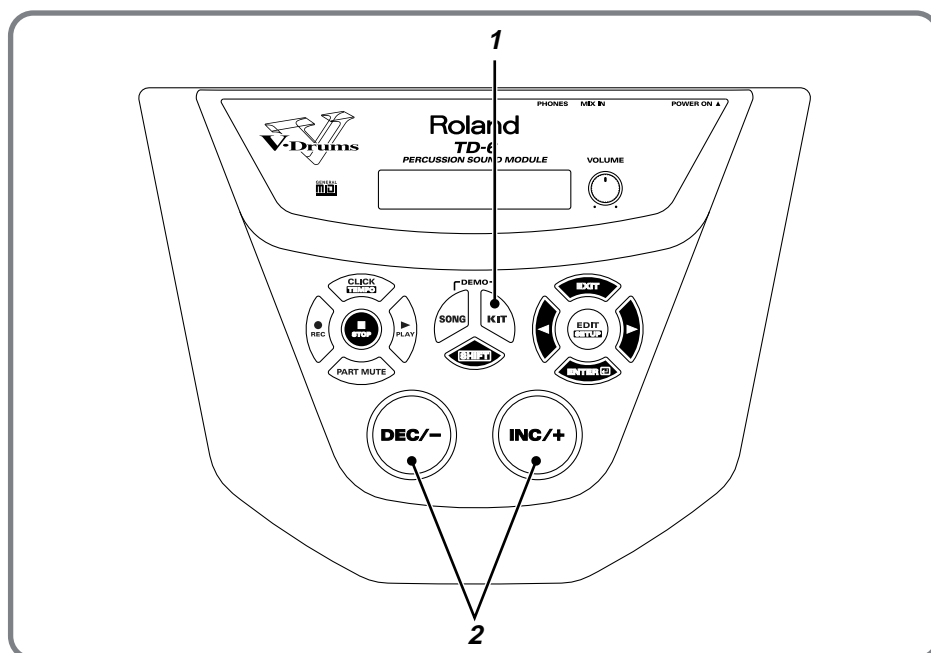

**1** Press [KIT].

[KIT] lights, and the "DRUM KIT" screen appears.



**2** Press [INC/+] or [DEC/-] to select Drum Kit #14.



**3** Playback of the song begins when the following pads are struck.

**1 KICK:** You can play the bass-line note by note (step by step) with your kick drum.

**9 CRASH1 Rim:** The chords progress when you strike the pad.

## HINT

- Make the following settings when selecting the Pad Pattern function yourself.
  - "Pad Ptn (Pad Pattern)" (KIT/CONTROL/Pad Ptn; p. 65), "Pad Ptn Velo (Pad Pattern Velocity)" (KIT/CONTROL/Pad Ptn Velo; p. 65)
  - The following are auxiliary functions available when you use songs in which Tap Playback or One Shot Playback is specified.
    - "Quick Play" (SONG/COMMON/Quick Play; p. 87),
    - "Reset Time" (SONG/COMMON/Reset Time; p. 87),
    - "Tap Exc Sw (Tap Exclusive Switch)" (SONG/COMMON/Tap Exc Sw; p. 87)

## MEMO

The following drum kits use the Pad Pattern function.

- #13 "Syn&Bass"
  - #18 "DrumSolo"
  - #97 "Tabla"
- Refer to "Drum Kit List" (p. 118) to find other drum kits.

# Playing with a CD, Tape, or MD (Using MIX IN Jack)

Using the TD-6's MIX IN jack allows you to play along with a CD or other external audio sources.

1

Make the connections as shown in the following figure.

Headphones,  
audio equipment, amp, etc.

CD/MD deck,  
cassette player, etc.

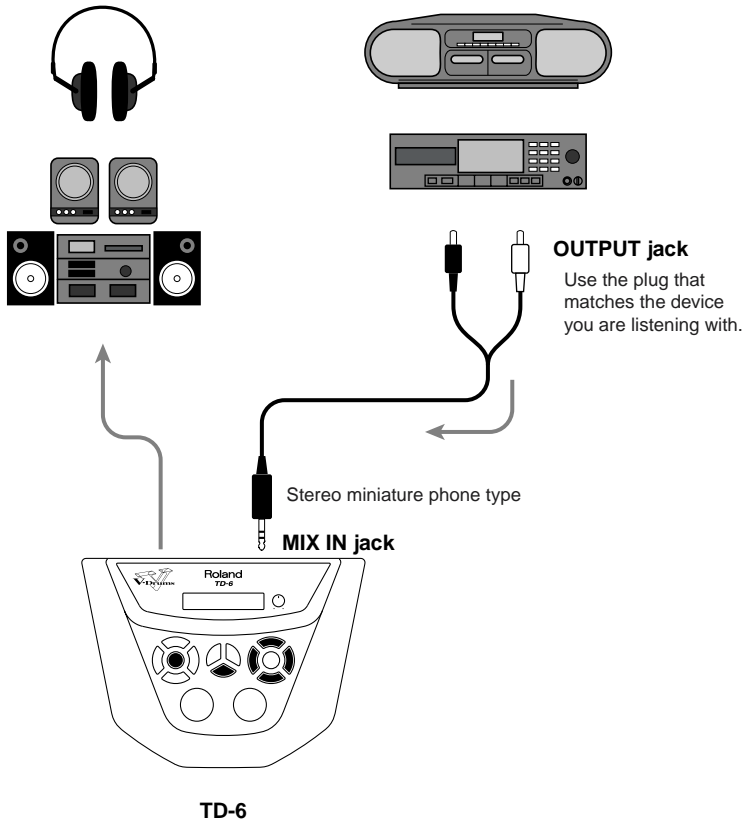

2

When you begin playback of the CD deck or other device, the performance is then audible through the headphones, audio equipment, amp, or other device.

## NOTE

To prevent malfunction and/or damage to speakers or other devices, always turn down the volume, and turn off the power on all devices before making any connections.

## HINT

Adjust the volume level of the playback device when correcting the volume balance between the CD or other sound input and the drum kit.

# Using the TD-6 As a General MIDI Sound

## Module

The TD-6 features GM mode, allowing it to play back GM scores (music data for GM sound generators) from an External Sequencer. The TD-6 has a function that lets you mute only the drum sounds in GM mode, making this a very useful feature. For details, refer to “Switch to the GM (General MIDI) Mode (GM Mode)” (p. 100) and “MIDI Messages Stop Function for Specific Parts in GM (General MIDI) Mode (GM PART)” (p. 103).



The TD-6 can also be used as a sound module along with MIDI keyboards and MIDI sequencers (p. 107).

### When Using the TD-6 as a GM Sound Module (p. 100)

- The TD-6 functions as a 16-part multi-timbre sound module.
- The internal sequencer is disabled.
- Drum kit parts cannot be played using MIDI messages sent from an external device. They can be played only by playing pads connected to the TD-6.



PERCUSSION SOUND MODULE **TD-6**

# *Advanced Use*

# Chapter 1 Creating Your Own Drum Kit (Kit Edit)

## Parameters That Can Be Set Here

### KIT

- INST (Instrument Settings) (p. 60)
  - Inst
  - Level
  - Pan
  - Pitch
  - Decay
- AMBIENCE (Ambience Settings) (p. 62)
  - Ambience Switch
  - Ambience Send Level
  - Studio Type
  - Wall Type
  - Room Size
  - Ambience Level
- EQUALIZER (Equalizer Settings) (p. 64)
  - Master Equalizer Switch
  - High Gain
  - Low Gain
- CONTROL (Settings for Various Functions) (p. 64)
  - Pad Pattern
  - Pad Pattern Velocity
  - Pitch Control Assign
  - Note Number
  - Gate Time
- COMMON (Overall Drum Kit Settings) (p. 68)
  - Master Volume
  - Pedal Hi-Hat Volume
  - Pitch Control Range
  - Drum Kit Name
- COPY (Copying Drum Kits) (p. 69)
- EXCHANGE (Exchanging Drum Kits) (p. 70)

## About Drum Kits and the Drum Kit Screen

### About the Drum Kits

A drum kit is a collection of settings, including how each pad's sound is played, effects settings, hi-hat control pedal settings, etc.

- There are 99 drum kits altogether.
- You can change the drum kits you like to create new drum kits.
- Changed settings are saved automatically.

### HINT

You can restore drum kits with changed settings to their original factory settings. Refer to “Restoring the Factory Settings for the Edited Drum Kit” (p. 70).

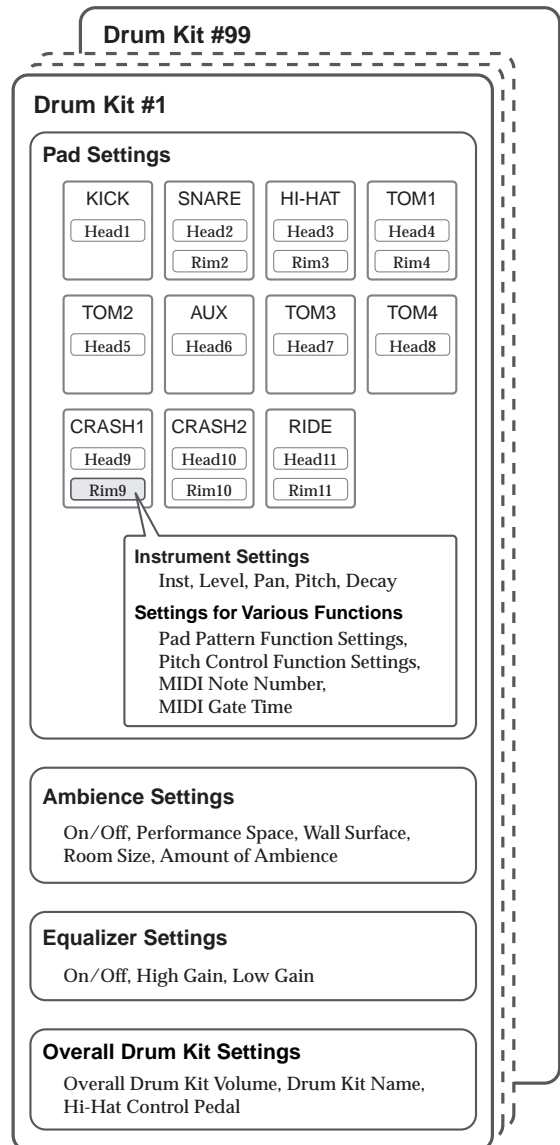



## About the Drum Kit Screen

The screen displayed when [KIT] is pressed is referred to as the Drum Kit screen.

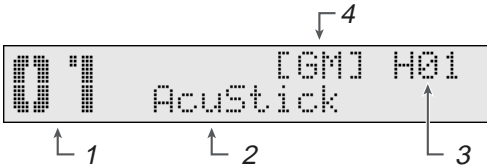

### 1 Drum Kit Number

Displays the number of the currently selected drum kit.

### 2 Drum Kit Name

The name of the currently selected drum kit is displayed.

### 3 Currently Selected Pad

The trigger input number for the selected pad is indicated. “H” appears when a head is selected, and “R” appears when the rim is selected.



For instructions on selecting pads, refer to p. 57.

### 4 GM Mode On/Off

While in GM mode, “[GM]” appears in the screen. Otherwise, in normal mode, nothing is indicated. For more detailed information about GM mode, refer to p. 100.



GM Mode is normally off when the power is turned on.

## Choosing a Drum Kit (Drum Kit)

When a drum kit is selected, each pad’s settings, ambience, EQ settings, etc. are switched.



To see what drum kits are provided with the factory settings, refer to the “Drum Kit List” (p. 118).

### 1. Press [KIT].

[KIT] lights, and the Drum Kit screen appears.

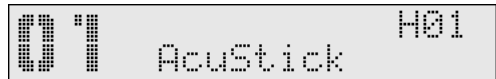

### 2. Press [INC/+] or [DEC/-] to select the drum kit.

Drum Kit: 1-99

## Choosing the Pad to Edit

The following two methods can be used for selecting the pad for which you want to make settings.

### Choosing a Pad by Hitting It

#### 1. Press [KIT], then [EDIT].

[KIT] and [EDIT] light.



#### 2. Press [ENTER] [ ] .

#### 3. Strike the pad to be set.

The setting screen for the struck pad appears.

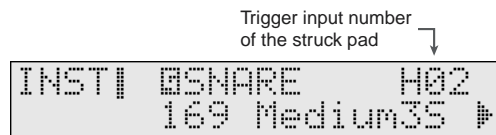

You can make settings preventing the display from switching to the instrument’s settings screen even when the pad is struck. When the TD-6 is set so that the screen does not switch, the trigger input number appears in brackets ([ ]). For more detailed information, refer to “Locking the Setting Screen While Editing One Instrument (Note Chase)” (p. 59).



## Choosing on the TD-6

1. Press [KIT], then [EDIT].

[KIT] and [EDIT] light.



2. Press [ENTER] [ ].

The instrument selection screen appears.



3. Hold down [SHIFT] and press [◀] or [▶] to select the trigger input number for the pad being set.

The trigger input number being selected for the set pad is indicated in the upper right of the screen.

The trigger input numbers are shown in the following sequence.

H01 → H02 → R02 → H03 → R03 → H04 → R04 → H05 →  
 H06 → H07 → H08 → H09 → R09 → H10 → R10 → H11 →  
 R11

Selecting the Trigger Input Number ↴



### NOTE

- Settings screens for trigger inputs to which no pad is connected and for rim trigger inputs for which the connected pads are not capable of producing rim sounds are also displayed.
- Trigger Inputs 6 (AUX) and 8 (TOM4) can be used only when two pads are connected to Trigger Input jacks 5/6 (TOM2/AUX) and 7/8 (TOM3/4) (p. 21).

## Notation Used in the Screen

Trigger input numbers and names are indicated in instrument settings screens.



Screen	Name	Screen	Name
KIK	KICK	T3	TOM3
SNR	SNARE	T4	TOM4
HH	HI-HAT	CR1	CRASH1
T1	TOM1	CR2	CRASH2
T2	TOM2	RD	RIDE
AUX	AUX		

## Helpful Functions for Edit

### Listening the INST (Instrument) assigned to a Pad (Preview)

Even when no pad is connected to the TD-6, you can select trigger input numbers and make settings while checking out instrument sounds.

### HINT

The preview velocity is set in “Preview Velo (Preview Velocity)” (SETUP/UTILITY/Preview Velo; p. 79).

1. Hold down [SHIFT] and press [◀] or [▶] to select the trigger input number.

The trigger input number for the selected pad is indicated in the upper right of the screen.

2. While holding down [SHIFT], press [KIT]

You can preview instruments.

## Locking the Setting Screen While Editing One Instrument (Note Chase)

**Note Chase** is a function in which a pad is selected either by striking the pad or when MIDI data corresponding to that pad is received. The display automatically switches to the settings screen when the pad settings are made.

To prevent the settings screen from switching if you happen to tap or touch other pads while making settings, set this to “OFF.”

### HINT

If you want to set other pads with this setting remaining at “OFF,” you can switch settings screens by holding down [SHIFT] and pressing [◀] or [▶] to select the trigger input number.

1. While holding down [SHIFT], press [EDIT] ([SETUP]).  
[EDIT] lights.



2. Press [▶] to select “MIDI COMMON.”

3. Press [ENTER] (◻).



4. Press [DEC/-] to select “OFF.”

Even when another pad is struck, the pad settings screen is prevented from switching.



5. When you finish making settings, press [KIT] to end the procedure.

When “Note Chase” is set to “OFF,” the trigger input number appears in brackets ([ ]).

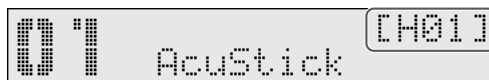

## Choosing an Instrument

### About the Instruments

The TD-6 features 1,024 different instruments which are categorized into 13 separate groups, such as KICK, SNARE, and TOM.

You can individually adjust the Level, Pan, Pitch, and Decay settings for instruments set to the pads.

### Choosing from the Group Names (Inst Group)

Find and select instruments from the Group names.



To see which instrument groups can be selected here, refer to “Drum Instrument List” (p. 120).

1. Confirm that [CLICK] is not lit.

If this lights, press [CLICK] to extinguish it.

2. Press [KIT], then [EDIT].

[KIT] and [EDIT] light.



3. Press [ENTER] (◻).

4. Strike the pad you wish to set.

The setting screen for the struck pad appears.

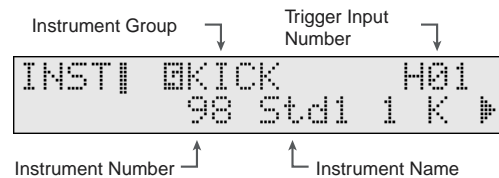

5. Hold down [SHIFT] and press [INC/+] or [DEC/-] to select the instrument group.

#### Inst Group:

KICK, SNARE, TOM, HI-HAT, CRASH, RIDE, PERC, SPECIAL, MELODIC, VOICES, REVERSE, FIXED HI-HAT, OFF

## Choosing an Instrument (Inst)

Select the instrument you want to sound when the pad is struck.



To see which instruments can be selected here, refer to “Drum Instrument List” (p. 120).

### NOTE

No sound is played if the pads are struck when the instrument is set to “1024 OFF.”

### MEMO

- When the “HI-HAT” instrument group is selected for a pad, you can then use a hi-hat control pedal (the optional FD-7; or for the TD-6K exclusively, the FD-6) to control the opening and closing of the hi-hat.
- When the hi-hat control pedal (the optional FD-7; or for the TD-6K exclusively, the FD-6) is pressed, the pedal hi-hat tone automatically switches according to the instrument set for the Trigger Input 3 (HI-HAT) head. The closed hi-hat (foot) can not be changed separately.

**1. Confirm that [CLICK] is not lit.**

If this lights, press [CLICK] to extinguish it.

**2. Press [KIT], then [EDIT].**

[KIT] and [EDIT] light.



**3. Press [ENTER □].**

**4. Strike the pad you wish to set.**

The setting screen for the struck pad appears.

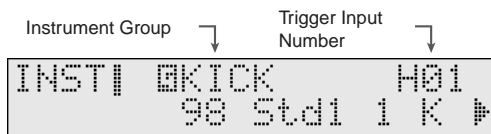

**5. Press [INC/+] or [DEC/-] to select the instrument.**

### HINT

You can select the instrument group by holding down [SHIFT] and pressing [INC/+] or [DEC/-] (p. 59).

Inst: 1-1024

## Instrument Settings (INST)

You can each adjust the Level, Pan, Pitch, and Decay settings for each instruments assigned to a pad.

**1. Confirm that [CLICK] is not lit.**

If this lights, press [CLICK] to extinguish it.

**2. Press [KIT], then [EDIT].**

[KIT] and [EDIT] light.



**3. Press [ENTER □].**

**4. Press [◀] or [▶] to select the parameter to be set.**



↑ Parameter to set

**5. Strike the pad you wish to set.**

The setting screen for the struck pad appears.

**6. Press [INC/+] or [DEC/-] to make the setting.**



↑ Value

**7. When you finish making settings, press [KIT] to end the procedure.**

## Adjusting the Volume of the Pad (Level)

Adjusts the volume of the instrument. Raising the value will increase the volume. With a setting of “0,” no sound is produced.

Make the adjustment here when correcting the volume balance between instruments.

### HINT

The pedal hi-hat volume is set in “Pedal HH Vol (Pedal Hi-Hat Volume)” (KIT/COMMON/Pedal HH Vol; p. 68).

```

INSTI          KIK:H01
4 Level       127 ▶
  
```

Level: 0–127

## Setting the Pan Position (Pan)

This adjusts the instrument’s pan setting (the perceived position of the sound between left and right speakers).

### NOTE

- Pan settings apply to both the head and rim. The rim settings value appears in parentheses. If either the head or rim settings are changed, the settings for the other are changed automatically.

```

INSTI          SNR:R02
4 Pan         (CENTER) ▶
  
```

- This setting is applied only when connected in stereo.

```

INSTI          KIK:H01
4 Pan         CENTER ▶
  
```

**Pan:** L15–CENTER–R15, RANDOM, ALTERNATE

- L15:** Sound is positioned at the extreme left.
- CENTER:** Sound is positioned in the center.
- R15:** Sound is positioned at the extreme right.
- RANDOM:** The panning changes randomly each time the pad is struck.
- ALTERNATE:** The panning alternately switches between left and right each time the pad is struck.

## Adjusting the Pitch (Pitch)

Adjusts the pitch of the instrument. The pitch is raised the higher the value is set. When set to “0,” the sound is played at the instrument’s default value.

### NOTE

For some instruments, raising or lowering the value beyond a certain point may not produce further change.

```

INSTI          KIK:H01
4 Pitch       0 ▶
  
```

Pitch: -480–+480

## Adjusting the Decay (Length of Sound) (Decay)

Adjusts the decay of the instrument’s sound. Higher settings will result in a longer decay time. When set to “0,” the sound is played at the instrument’s default value.

### NOTE

For some instruments, raising or lowering the value beyond a certain point may not produce further change.

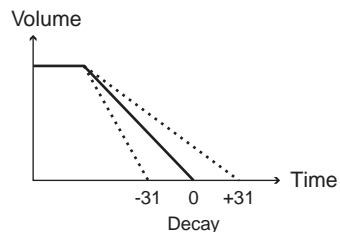

```

INSTI          KIK:H01
4 Decay       0
  
```

Decay: -31–+31

## Ambience Settings (AMBIENCE)

Here you can choose (on a per drum kit basis) the location, room size, wall material, etc.

1. Press [KIT], then [EDIT].

[KIT] and [EDIT] light.

2. Press [▶] to select “AMBIENCE.”

```
KIT |
EDIT | ← AMBIENCE →
```

3. Press [ENTER].

4. Press [◀] or [▶] to select the parameter you wish to edit.

```
AMBI
Ambience Sw ON →
```

↑ Parameter to set

5. Press [INC/+] or [DEC/-] to make the setting.

```
AMBI
Ambience Sw ON →
```

↑ Value

6. When you finish making settings, press [KIT] to end the procedure.

### Switching Ambience On/Off (Ambience Switch)

This switches the ambience on and off.

```
AMBI
Ambience Sw ON →
```

Ambience Sw (Ambience Switch): OFF, ON

### Ambience “Send” Level for Each Instrument (Ambience Send Level)

You can adjust the ambience level for each instrument individually. The ambience effect deepens the higher the value is set. When set to “0,” no ambience is applied.

Strike a pad to select it, then make the setting.

#### HINT

The entire drum kit’s overall ambience depth is set in “Amb Level (Ambience Level)” (KIT/AMBIENCE/Amb Level; p. 63).

```
AMBI KIK:H01
← AmbSendLevel 19 →
```

AmbSendLevel (Ambience Send Level):0-127

### Choose “Location” Where the Drums are Played (Studio Type)

The TD-6 includes nine different internal Studio Types you can select for the drum “location.” Before you make detailed settings, use this setting to select the basic type of acoustic environment in which you will be playing.

```
AMBI
← Studio THEATER →
```

Studio (Studio Type):

LIVING (Living Room), BATHROOM,  
STUDIO (Recording Studio), GARAGE,  
LOCKER (Locker Room), THEATER, CAVE,  
GYM (Gymnasium),  
STADIUM (Domed Stadium)

## Changing the Wall Surface Material (Wall Type)

Select the surface material of the walls in the room in which the drums are played.



**WallType (Wall Type): WOOD, PLASTER, GLASS**

### WOOD:

Simulates the sound of a wood-walled room producing a warm sound.

### PLASTER:

Simulates a plaster-walled room producing a more “naturally live” sound.

### GLASS:

Simulates a glass-walled room producing a very bright ambience.

## Determine the Room Size (Room Size)

Select the size the room in which the drums are played.

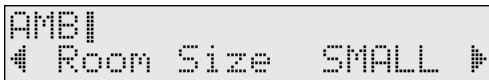

**Room Size: SMALL, MEDIUM, LARGE**

## Adjusting the Entire Drum Kit's Overall Ambience (Ambience Level)

Adjusts the amount of overall ambience level used for each drum kit. The ambience effect deepens the higher the value is set. When set to “0,” no ambience is applied.

### HINT

The ambience level for each individual instrument is set in “Amb Snd Lvl (Ambience Send Level)” (KIT/AMBIENCE/ (AmbSendLevel; p. 62).



**Amb Level (Ambience Level): 0-127**

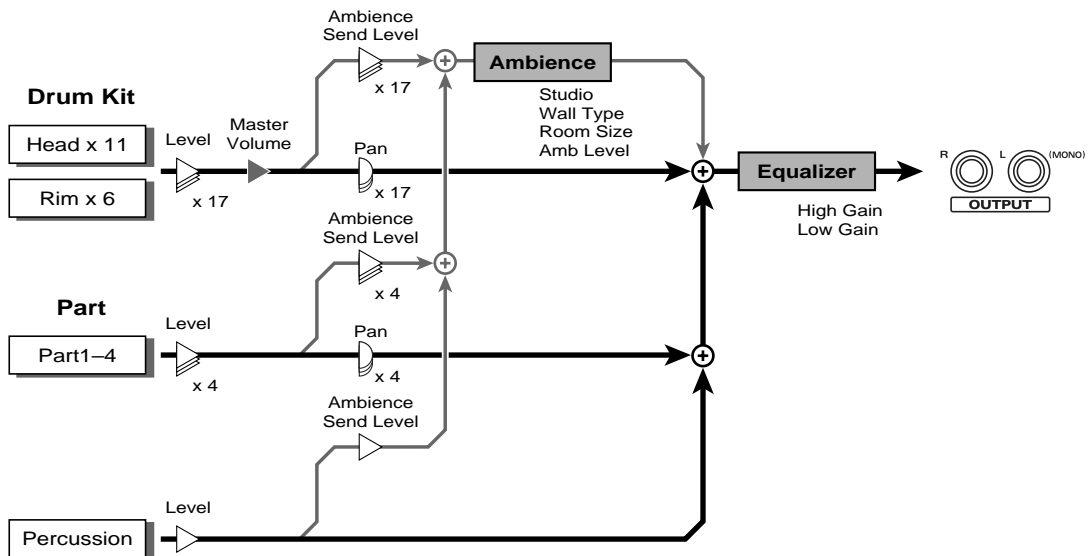

## Equalizer Settings (EQUALIZER)

A two-band equalizer (for high and low frequency ranges) is used to adjust the sound of each drum kit.

An equalizer lets you boost or cut specified frequency ranges to adjust the tone. You can make separate settings for the amount of boost or cut (the gain) in the high-frequency and low-frequency ranges.

1. **Confirm that [CLICK] is not lit.**  
If this lights, press [CLICK] to extinguish it.
2. **Press [KIT], then [EDIT].**  
[KIT] and [EDIT] light.
3. **Press [▶] to select “EQUALIZER.”**

```
KIT |
EDIT | 4 EQUALIZER EQ▶
```

4. **Press [ENTER □].**
5. **Press [◀] or [▶] to select the parameter you wish to edit.**

```
EQI
Master EQ Sw ON ▶
```

↑ Parameter to set

6. **Press [INC/+] or [DEC/-] to make the setting.**

```
EQI
Master EQ Sw ON ▶
```

↑ Value

7. **When you finish making settings, press [KIT] to end the procedure.**

## Switching the Equalizer On/Off (Master Equalizer Switch)

Switches the equalizer on and off.

```
EQI
Master EQ Sw ON ▶
```

Master EQ Sw (Master Equalizer Switch):  
OFF, ON

## Adjusting the Sound (High Gain, Low Gain)

Set the amount of boost or cut (GAIN) in the high frequencies (HIGH) and low frequencies (LOW). Raise to boost the sound, lower to cut. The equalizer has no effect when “GAIN” is set to “0.”

```
EQI
4 High Gain +3dB ▶
```

High Gain: -12dB~+12dB

```
EQI
4 Low Gain 0dB
```

Low Gain: -12dB~+12dB

## Settings for Various Functions (CONTROL)

These are settings for a variety of different features, such as one that lets you start a song by striking a pad (Pad Pattern function; p. 65) and a function whereby you can use the hi-hat control pedal to control instrument pitches (Pitch Control; p. 66), along with MIDI Note Number and MIDI Gate Time settings.

1. **Confirm that [CLICK] is not lit.**  
If this lights, press [CLICK] to extinguish it.
2. **Press [KIT], then [EDIT].**  
[KIT] and [EDIT] light.
3. **Press [▶] to select “CONTROL.”**

```
KIT | KIK:H01
EDIT | 4 CONTROL EQ▶
```

4. **Press [ENTER □].**
5. **Press [◀] or [▶] to select the parameter you wish to edit.**

```
CTRLI H01
Pad Ptn OFF ▶
```

↑ Parameter to set



6. **Strike the pad you wish to set.**

The setting screen for the struck pad appears.

7. **Press [INC/+] or [DEC/-] to make the setting.**

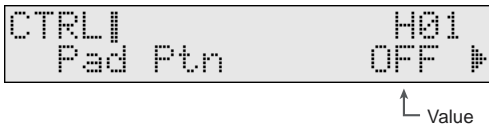

8. **When you finish making settings, press [KIT] to end the procedure.**

**Playing a Song by Hitting a Pad (Pad Pattern)**

The **Pad Pattern** function is a feature that lets you start the performance of pre-specified songs by striking the pads. This function provides a very convenient way to use songs during a live performance or when practicing.

**The Song Set “LOOP” or “ONE SHOT”**

**LOOP:** After the song is played back all the way to the end, playback then repeats, starting at the beginning of the song.

**ONE SHOT:** Playback stops once the end of the song is reached. Each time the pad is struck returns you to the beginning of the song and starts playback.

When triggering/playing a song that is set to “LOOP” or “ONE SHOT” mode, if you trigger another song (from a pad, also in “LOOP” or “ONE SHOT” mode then the last song played will have priority. Don’t forget that some “songs” are very short, a few notes, or even one chord. So “sudden” stops can be caused by accidentally triggering one of these short songs. Always check your Pad Pattern settings.

If you have switched a song whose instrument settings are different, the sound may be interrupted for an instant.

**The Song Set “Tap”**

The sounds are played back in sequence each time the pad is struck.

If you are playing a song set “LOOP” or “ONE SHOT” and you then play a song set to TAP playback....then you can use/ listen to both at the same time.



- To see which songs can be selected here, refer to “Preset Song List” (p. 128).
- For the play type of the song, refer to p. 86.



- This setting cannot be made in GM mode (p. 100).
- Performances using the Pad Pattern function cannot be recorded to sequencers.



- You can select the song Category by holding down [SHIFT] and pressing [INC/+] or [DEC/-].
- You can preview a song by holding down [SHIFT] and pressing [KIT].
- To prevent the sound of an instrument assigned to a pad from playing, set the instrument’s “Level” to “0” (KIT/INST/Level; p. 61).
- You can get a stronger response when striking the pads by playing back with the song’s velocity changed (KIT/CONTROL/Pad Ptn Velo; p. 65).
- The TD-6 features auxiliary functions for songs set to One Shot Playback and Tap Playback.

For more details, refer to

“Quick Play” (SONG/COMMON/Quick Play; p. 87),

“Reset Time” (SONG/COMMON/Reset Time; p. 87),

and “Tap Exc Sw (Tap Exclusive Switch)” (SONG/COMMON/Tap Exc Sw; p. 87).

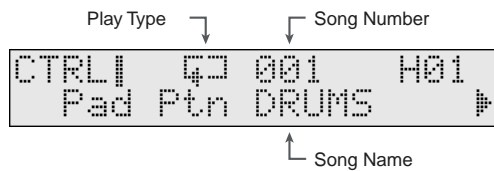

**Pad Ptn (Pad Pattern): OFF, 1-250**

**Control the “Level” of the Pattern with Playing Dynamics (Pad Pattern Velocity)**

When performing with the Pad Pattern function, you can have the velocity used for playback of the song change according to the force with which the pads are struck. When set to “OFF,” the song is played back using the velocity specified for the song, regardless of how strongly the pads are struck.



- This setting cannot be made in GM mode (p. 100).
- When “Pad Ptn (Pad Pattern)” is set to “OFF,” a horizontal line ( ——— ) is displayed, and you cannot make this setting. Refer to the previous section, then after selecting the song, make the setting.

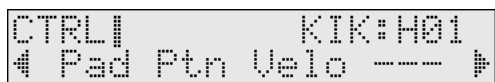

**Pad Ptn Velo (Pad Pattern Velocity): OFF, ON**

## Pitch Control with the Hi-Hat Control Pedal On/Off for Each Pad (Pitch Control Assign)

**Pitch Control** is a function that lets you change the pitch of an instrument assigned to a pad according to the amount the hi-hat control pedal is pressed. Releasing the pedal returns the instrument to its original pitch.

Here, make the Pitch Control on/off setting for each pad. When set to “OFF,” the instrument’s pitch remains unchanged.



The range over which the pitch changes is set in “PchCtrlRange (Pitch Control Range)” (KIT/COMMON/PchCtrlRange; p. 68).



- To prevent the pedal hi-hat sound from being played when the hi-hat pedal is pressed, set “Pedal HH Vol (Pedal Hi-Hat Volume)” to “0” (KIT/COMMON/Pedal HH Vol; p. 68).
- To make pitch changes occur more smoothly, set “PdlDataThin (Pedal Data Thin)” to “1” or “OFF” (SETUP/MIDI COMMON/PdlDataThin; p. 99).

```
CTRL1      KIK:H01
4 Pitch Ctrl OFF
```

**Pitch Ctrl (Pitch Control Assign): OFF, ON**

## MIDI Note Number for Each Pad (Note Number)

In each drum kit, you can set the MIDI note numbers to be transmitted/received by each pad.

For the hi-hat, make the setting only for the note number for the Open Hi-Hat (default setting is 46 (A#2)). With this setting, the closed hi-hat (initial settings value of 42 (F#2)) and pedal hi-hat (initial settings value of 44 (G#2)) are changed together to the open setting.



This setting cannot be made in GM mode (p. 100).



When the open hi-hat note number is set to “60 (C4),” the note number for the closed hi-hat becomes “56 (G#3)” and the note number for the pedal hi-hat becomes “58 (A#3).”



For information on factory-set note number settings, refer to “Drum Kit Note Numbers” (p. 125) in the “Preset Percussion Set List.”

```
CTRL1      KIK:H01
4 Note No. 36(C 2)
```

**Note No. (Note Number): 0 (C -) -127 (G 9)**

## Sounding an External MIDI Device by Playing Pads Connected to the TD-6

Specify the MIDI note numbers (key numbers on a keyboard) that will be transmitted by the TD-6 when the pads are struck. Set this to the note number of the sound that you wish to play on the external sound module or sampler.

## Using an External MIDI Device to Play TD-6 Drum Kit Part Sounds (TD-6 Used As Sound Module)

Specify the note number corresponding to the pad. When the TD-6 receives the note number specified here, the instrument assigned to the pad is played.



On the TD-6, the drum kit part and percussion part can both be set to Channel 10 at the same time.

When two parts are set to channel 10, you should also set “CH10Priority (Channel 10 Priority)” to determine whether

the instrument (the drum kit part) or the percussion set instrument (the percussion part) is to be played when the note number is received (SETUP/MIDI COMMON/CH10Priority; p. 99).

### When Setting Multiple Pads to the Same Note Number

When using an external MIDI device to play TD-6 drum kits, if overlapping note numbers are received, the instrument assigned to the pad connected to the lowest-numbered trigger input is sounded.

When note numbers for the head and rim are duplicated, the head instrument is played.

When the pad is struck, the note number set for the pad is sent.

#### NOTE

When the same note number is assigned to more than one pad, then " \* " appears in the settings screen for the pad that is prevented from sounding even when the Note Number is received.

```
CTRL| SNR:R02
4 Note No. 38(D 2)*#
```

#### HINT

The following appears in the display when "38 (D2)" is specified for the head (H02) and rim (R02) of Trigger Input 2 (SNARE) and the head (H04) of Trigger Input 4 (TOM1).

Trigger Input 2 (SNARE) Head

```
CTRL| SNR:H02
4 Note No. 38(D 2) #
```

Trigger Input 2 (SNARE) Rim

```
CTRL| SNR:R02
4 Note No. 38(D 2)*#
```

Trigger Input 4 (TOM1) Head

```
CTRL| T1:H04
4 Note No. 38(D 2)*#
```

In this case, when Note Number 38 (D2) is received, the instrument assigned to the HEAD of TRIGGER INPUT 2 (SNARE) is played.

## MIDI Gate Time for Each Pad (Gate Time)

For each pad, you can specify the length of time the note will "hold" during transmission from the MIDI OUT.

Percussion sound modules normally produce sound only in response to "Note on" messages, and ignore "Note off" messages. However general-purpose sound modules or samplers do receive the note-off messages that are transmitted and respond by turning off the sound.

At the factory settings, the Gate Time setting is set to the minimum value, since a drum sound module will likely not make use of it. If a sound module received this data as it is receiving a Note OFF message, the interval will be too short, so most sounds will not be played (or it may sound like barely perceptible noise). To avoid this problem, set a longer gate time for each pad that is to be played.

#### NOTE

This setting cannot be made in GM mode (p. 100).

```
CTRL| KIK:H01
4 Gate Time 0.1sec
```

**Gate Time: 0.1–8.0 sec (0.1 sec. steps)**

## Overall Drum Kit Settings (COMMON)

Make the settings for each drum kit.

1. **Confirm that [CLICK] is not lit.**  
If this lights, press [CLICK] to extinguish it.
2. **Press [KIT], then [EDIT].**  
[KIT] and [EDIT] light.
3. **Press [▶] to select “COMMON.”**

```
KIT |
EDIT | ◀ COMMON ▶
```

4. **Press [ENTER] [◻].**
5. **Press [◀] or [▶] to select the parameter you wish to edit.**

```
COMMON |
MasterVolume 127 ▶
```

↑ Parameter to set

6. **Press [INC/+] or [DEC/-] to make the setting.**

```
COMMON |
MasterVolume 127 ▶
```

↑ Value

7. **When you finish making settings, press [KIT] to end the procedure.**

## Overall Drum Kit Volume (Master Volume)

You can adjust the overall volume of the drum kit while preserving the volume balance between each of the pads. The higher the value is set, the greater the volume. With a setting of “0,” no sound is produced.

### HINT

The volume balance among the pads is adjusted in the “Level” (KIT/INST/Level; p. 61).

```
COMMON |
MasterVolume 127 ▶
```

**MasterVolume (Master Volume): 0–127**

## Adjusting the Volume of the Pedal Hi-Hat Sound (Pedal Hi-Hat Volume)

For each drum kit, you can adjust the volume of the pedal hi-hat that sound (when the hi-hat control pedal is pressed). The higher the value is set, the greater the volume. With a setting of “0,” no sound is produced.

### MEMO

Set the volume level of other pads with the “Level” setting (KIT/INST/Level; p. 61).

```
COMMON |
Pedal HH Vol 8 ▶
```

**Pedal HH Vol (Pedal Hi-Hat Volume): 0–15**

## Setting the Range for the Pitch Control with the Hi-Hat Control Pedal (Pedal Pitch Control Range)

Pitch Control is a function that lets you change the pitch of an instrument assigned to a pad according to the amount the hi-hat control pedal is pressed.

Releasing the pedal returns the instrument to its original pitch.

The degree to which the pitch is to change when the hi-hat control pedal is pressed is set in semitone (half-step) increments from -24 (down two octaves) to +24 (up two octaves). When set to “0,” there is no change in pitch.



Pitch Control is turned on and off in the “Pitch Ctrl (Pitch Control)” setting (KIT/CONTROL/Pitch Ctrl; p. 66).

### HINT

- To prevent the pedal hi-hat sound from being played when the hi-hat pedal is pressed, set “Pedal HH Vol (Pedal Hi-Hat Volume)” to “0” (KIT/COMMON/Pedal HH Vol; p. 68).
- To have changes in pitch occur smoothly, set “PdldataThin (Pedal Data Thin)” to “1” or “OFF” (SETUP/MIDI COMMON/PdldataThin; p. 99).

```
COMMON |
PchCtrlRange 0 ▶
```

**PchCtrlRange (Pedal Pitch Control Range): -24–+24**

## Naming the Drum Kit (Kit Name)

Each kit can be given a name of up to 8 characters.

Press [ ◀ ] or [ ▶ ] to move the cursor (under bar) to the character you want to change, then press [INC/+] or [DEC/-] to select the character.

### HINT

- Holding down [SHIFT] and pressing [INC/+] switches through the following sequence: uppercase alphabet → lowercase alphabet → 0 → ! → space. Holding down [SHIFT] and pressing [DEC/-] switches through the sequence in reverse order.
- Holding down [SHIFT] and pressing [ ◀ ] deletes the character at the cursor position and closes the resulting space by shifting forward the characters that follow.
- Holding down [SHIFT] and pressing [ ▶ ] inserts a space at the character at the cursor position and shifts back the characters that follow.

```
COMMON|
4 KitName[AcuStick]
```

### KitName (Drum Kit Name): 8 characters

The following characters may be used.

```
ABCDEFGHIJKLMNPOQRSTUVWXYZ
abcdefghijklmnopqrstuvwxyz
0123456789
!##%&"'^\_-+*/=<>()[]{}.,:;?@*~+=|
space
```

## Copying a Drum Kit (COPY)

You can copy the instrument, ambience, equalizer, and all other settings in a drum kit.

Executing this operation deletes the content of the copy destination, so check all content carefully before carrying out this operation.

1. Confirm that [CLICK] is not lit.  
If this lights, press [CLICK] to extinguish it.
2. Press [KIT], then [EDIT].  
[KIT] and [EDIT] light.
3. Press [ ▶ ] to select "COPY."

```
KIT |
EDIT| 4 COPY      [ENTER]
```

4. Press [ENTER].
5. Press [INC/+] or [DEC/-] to select the copy-source drum kit.

```
COPY|
Src P01 AcuStick [▶]
```

Drum Kit Number      Drum Kit Name

6. Press [ ▶ ].  
The copy destination drum kit selection screen appears.
7. Press [INC/+] or [DEC/-] to select the copy-destination drum kit.

```
COPY| [ENTER]/[EXIT]
4 Dst U01 AcuStick
```

Drum Kit Number      Drum Kit Name

8. Press [ENTER].  
Press [EXIT] to cancel the operation.

```
Are You Sure?
[ENTER] / [EXIT]
```

9. Press [ENTER] to execute the operation.  
When you have finished copying the drum kit, the Completed screen appears.

```
Completed!
```

10. When you finish copying, press [KIT] to end the procedure.

Src (Copy Source):  
P01-P99 (Factory Setting Drum Kits),  
U01-U99 (Drum Kits)

### HINT

Select a drum kit marked with " P " as the copy source (P01-P99) to restore original factory drum kits.

Dst (Copy Destination):  
U01-U99 (Drum Kits)

## Restoring the Factory Settings for the Edited Drum Kit

You can restore reconfigured drum kits to their original factory conditions.

### Drum Kit Copy Function

Follow the procedure described on p. 69 to select a drum kit marked with “ P ” (P01–P99) as the copy source.

### Factory Reset Function

1. Select the drum kit that you want to return to factory conditions.
2. Follow the procedure for Factory Reset (p. 79) to select “THIS DRUM KIT.”

## Switching the Order of the Drum Kits (EXCHANGE)

You can switch (exchange) the place in order of any two drum kits.

1. Confirm that [CLICK] is not lit.  
If this lights, press [CLICK] to extinguish it.
2. Press [KIT], then [EDIT].  
[KIT] and [EDIT] light.
3. Press [▶] to select “EXCHANGE.”

```
KIT |
EDIT|◀ EXCHANGE  [ENTER]
```

4. Press [ENTER].
5. Press [INC/+] or [DEC/-] to select the (first) drum kit to be exchanged.

```
XCHG|
Src  U01 AcuStick ▶
```

Drum Kit Number ↑      ↑ Drum Kit Name

6. Press [▶].

7. Press [INC/+] or [DEC/-] to select the (second) drum kit to be exchanged.

```
XCHG| [ENTER]/[EXIT]
4 Dst U02 Rock It!
```

Drum Kit Number ↑      ↑ Drum Kit Name

8. Press [ENTER].

Press [EXIT] to cancel the operation.

```
Are You Sure?
[ENTER] / [EXIT]
```

9. Press [ENTER] to execute the operation.

When you have finished exchanging the drum kits, the Completed screen appears.

```
Completed!
```

10. When you finish exchanging, press [KIT] to end the procedure.

Src (Exchange Source):  
U01–U99 (Drum Kits)

Dst (Exchange Destination):  
U01–U99 (Drum Kits)

# Chapter 2 Making the Pad and Trigger Settings (SETUP/TRIG)

## Parameters That Can Be Set Here

### SETUP

- TRIGGER BASIC (Pad Sensitivity Settings) (p. 72)
  - Trigger Type
  - Sensitivity
  - Threshold
  - Trigger Curve
  - Crosstalk Cancel
- TRIGGER ADVANCED (Detailed Pad Settings) (p. 74)
  - Scan Time
  - Retrigger Cancel
  - Mask Time
  - Rim Sensitivity

## About the Screen Display

### Notation Used in the Screen

Trigger input numbers and names are indicated in pad and trigger settings screens.

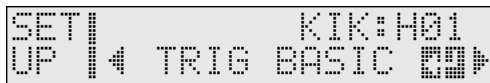

Screen	Name	Screen	Name
KIK	KICK	T3	TOM3
SNR	SNARE	T4	TOM4
HH	HI-HAT	CR1	CRASH1
T1	TOM1	CR2	CRASH2
T2	TOM2	RD	RIDE
AUX	AUX		

### About the Input Indicator

The input indicator is indicated in the pad and trigger settings screens as shown in the following. A flag is raised when the indicator reaches the maximum position ( ← → [ ] ).

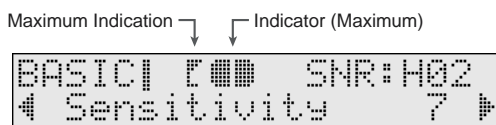
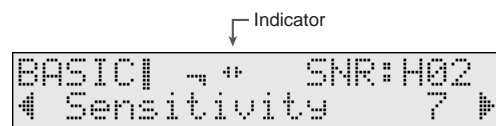

## Selecting the Pad Type (Trigger Type)

To ensure that the TD-6 accurately receives signals sent from the pads, be sure to specify the **trigger type** (the type of pads being used).

Set each trigger input as described below.

Setting the trigger type allows the TD-6 to accurately detect the force used to strike the pads and avoid secondary sounding of a pad (retriggering). You can also set this up for PD-80R and PD-120 rim shots.

After making the trigger type settings, adjust the pad sensitivity and carry out other adjustments as needed.

### MEMO

When you set the Trigger Type, the following parameters are automatically set to the most efficient values.

They should be adjusted as necessary to match the actual state of your configuration and the environment in which it is being used.

#### Basic Trigger Parameter

(SETUP/TRIG BASIC; p. 72)

- Sensitivity
- Threshold
- TrigCurve

#### Advanced Trigger Parameter

(SETUP/TRIG ADVNCD; p. 74)

- Scan Time
- Retrigger Cancel
- Mask Time
- Rim Sens



For the most suitable values for each trigger type, refer to p. 36.

1. While holding down [SHIFT], press [EDIT (SETUP)].

[EDIT] lights.

2. Press [▶] to select "TRIG BASIC."



3. Press [ENTER] [↵].



4. Strike the pad you wish to set.

The setting screen for the struck pad appears.



This setting applies to both the head and rim.

5. Find the trigger type for the pad you are using from the following chart.

Pad	Trigger Type	Pad	Trigger Type
PD-5	PD7/9	CY-6	CY6
PD-6	PD6	CY-12H	CY Type
PD-7	PD7/9	CY-14C	CY Type
PD-9	PD7/9	CY-15R	CY Type
PD-80	PD80/100	KD-5	KD7
PD-80R	PD80R	KD-7	KD7
PD-100	PD80/100	KD-80	KD Type
PD-120	PD120	KD-120	KD Type



- Use the “AcDrTrig” setting when you use acoustic drums to sound the TD-6. For details refer to “Using the TD-6 with Acoustic Triggers” (p. 76).
- When using a pad made by another manufacturer, first select “PD7/9” and try playing the pad. (For a kick, select “KD Type.”) If, with this setting, the pad striking force does not produce a stable volume, try a setting of “P1.” A setting of “P2” will be even more stable, but since the Scan Time (p. 69) will be even longer, the interval from when the pad is struck until the sound is heard will be slightly (approximately 0.003 seconds) longer, or it will be difficult to obtain changes based on playing dynamics. The “Other 1” and “Other 2” settings are for use with pads with trigger output waveforms that have a slow attack.



There may be no improvement of conditions when non-Roland pads are used, even after changing the trigger parameter settings. For fullest expression in performance, we recommend the exclusive use of Roland pads.

6. Press [INC/+] or [DEC/-] to make the setting.



↑ Value

7. When you finish making settings, press [KIT] or [SONG] to end the procedure.

TrigTyp (Trigger Type):

PD6, PD7/9, PD-80/100, PD80R, PD120, KD7, KD Type, CY6, CY Type, Other 1, Other 2, AcDrTrig

## Setting the Pad Sensitivity and Making Other Settings (TRIGGER BASIC)

You can make more detailed settings for the pad type and sensitivity.

The following parameters (Basic Trigger Parameters except the “Xtalk Cancel”) are automatically set to the most efficient values for each pad when you select the “TrigTyp (Trigger Type)” (SETUP/TRIG BASIC/TrigTyp; p. 71).

Make the settings for each parameter as needed.

1. While holding down [SHIFT], press [EDIT] (SETUP)].

[EDIT] lights.

2. Press [▶] to select “TRIG BASIC.”

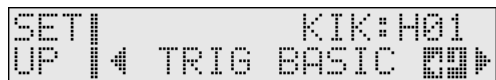

3. Press [ENTER] [↵].

4. Press [◀] or [▶] to select the parameter you wish to edit.

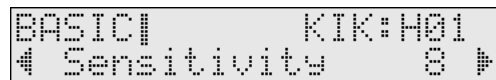

↑ Parameter to set

5. Strike the pad you wish to set.

The settings screen for the struck pad appears, and the input indicator fluctuates.

6. Press [INC/+] or [DEC/-] to make the setting.

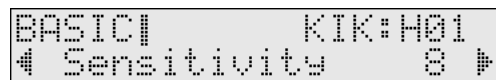

↑ Value

7. When you finish making settings, press [KIT] or [SONG] to end the procedure.



## Adjusting the Pad Sensitivity (Sensitivity)

Adjust the sensitivity of the pad to regulate the pad response. Higher settings result in higher sensitivity, so that the pad will produce a loud volume even when struck softly.

Adjust the "Sensitivity" value so that the strongest strikes cause the input indicator (p. 71) to reach nearly all the way to the maximum level.

```
BASIC1      KIK:H01
4 Sensitivity 8
```

**Sensitivity: 1-16**

## Setting the Minimum Levels for the Pads (Threshold)

This setting allows a trigger signal to be received only when the pad is struck harder than a specified force. This can be used to prevent a pad from sounding in response to extraneous vibrations from another pad. In the following example, B will sound but A and C will not sound.

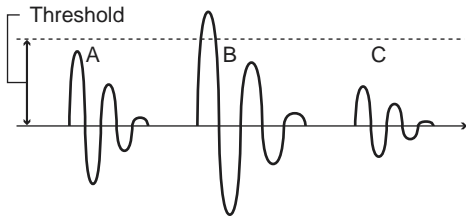

When set to a higher value, no sound is produced when the pad is struck lightly. Gradually raise the "Threshold" value while striking the pad. Check this and adjust accordingly. Repeat this process until you get the perfect setting for your playing style.

```
BASIC1      KIK:H01
4 Threshold  5
```

**Threshold: 0-15**

## Adjust How Playing Dynamics Changes the Volume (Trigger Curve)

This setting allows to control the relation between the velocity (striking force) and changes in volume (the dynamic curve.)

Adjust this curve until the response feels as natural as possible.

```
BASIC1      KIK:H01
4 TrigCurve  LINEAR
```

### TrigCurve (Trigger Curve):

**LINEAR, EXP1, EXP2, LOG1, LOG2, SPLINE, LOUD1, LOUD2**

#### LINEAR:

The standard setting. This produces the most natural correspondence between the strength of the strike and the change in volume.

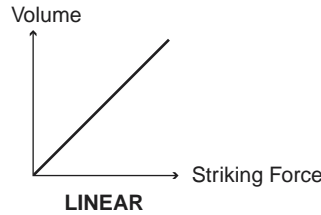

#### EXP1, EXP2:

Compared to LINEAR, a strong strike will produce a greater change.

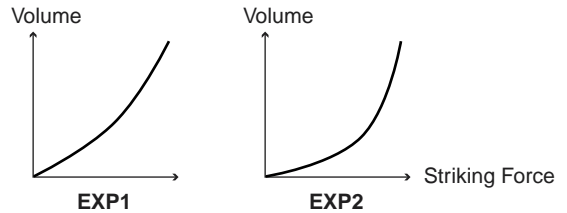

#### LOG1, LOG2:

Compared to LINEAR, a soft strike will produce a greater change.

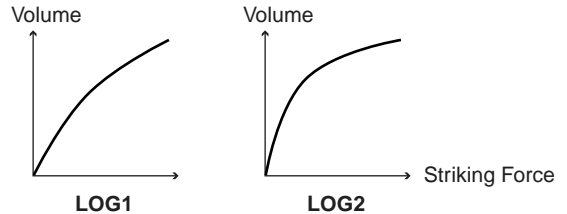

**SPLINE:**

Extreme changes are made in response to the force used to strike the pad.

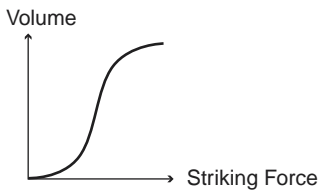

**SPLINE**

**LOUD1, LOUD2:**

Changes made in response to the striking force are minor, maintaining a volume level at which it is easy to play. When using drum triggers, these settings help maintain stable levels.

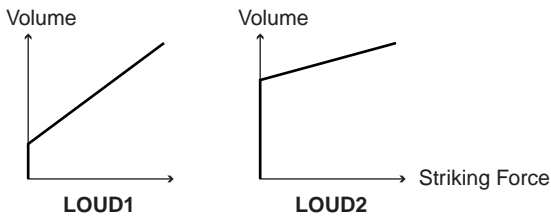

**Eliminate Crosstalk Between Pads (Crosstalk Cancel)**

When two pads are mounted on the same stand, the vibration produced by hitting one pad may trigger the sound from another pad unintentionally (This is called **crosstalk**.) You can avoid this problem by adjusting Crosstalk Cancel on the pad that is sounding inadvertently.

If the value is set too high, then when two pads are played simultaneously, the one that is struck less forcefully will not sound. So be careful and set this parameter to the minimum value required to prevent such crosstalk. With a setting of “OFF,” crosstalk prevention does not function.

**HINT**

In some cases, you can prevent crosstalk between two pads you have connected by increasing the distance between the pads.

**Example:**

**When hitting a snare pad, the hi-hat cymbal also sounds**

Set the “Xtalk Cancel (Crosstalk Cancel) for the pad being used for the hi-hat while striking the snare pad. Striking the snare pad, raise the “CROSSTALK” setting for the hi-hat cymbal pad from “OFF” through “20,” “25.”.. until crosstalk no longer occurs. As this value is raised, the hi-hat cymbal pad will be less prone to receive crosstalk from other pads.

**HINT**

The pad’s settings screen is not switched when “Note Chase” is set to “OFF” (SETUP/MIDI COMMON/Note Chase; p. 59, p. 98).



**Xtalk Cancel (Crosstalk Cancel):**

**OFF, 20, 25, 30, 35, 40, 45, 50, 55, 60, 65, 70, 75, 80**

**Fine-Tuning the Trigger Parameter Settings (TRIGGER ADVANCED)**

The following parameters (Advanced Trigger Parameters) are automatically set to the most efficient values for each pad when you select the TRIGGER TYPE (SETUP/TRIG BASIC/TrigTyp; p. 71), and don’t require adjustment, except if you experience any of the problems that are discussed below.

1. While holding down [SHIFT], press [EDIT (SETUP)]. [EDIT] lights.

2. Press [▶] to select “TRIG ADVNCD.”

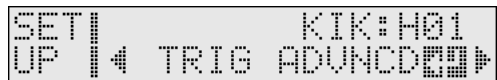

3. Press [ENTER].

4. Press [◀] or [▶] to select the parameter you wish to edit.

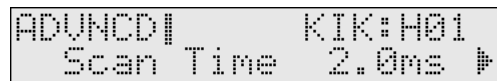

↑ Parameter to set

5. Strike the pad you wish to set.

The settings screen for the struck pad appears, and the input indicator fluctuates.

6. Press [INC/+] or [DEC/-] to make the setting.



↑ Value

7. When you finish making settings, press [KIT] or [SONG] to end the procedure.

## Adjusting the Trigger Signal Detection Time (Scan Time)

Since the rise time of the trigger signal waveform may differ slightly depending on the characteristics of each pad or acoustic drum trigger (drum pickup), you may notice that identical hits (velocity) may produce sound at different volumes. If this occurs, you can adjust the “SCAN TIME” so that your velocity of playing can be detected more precisely. As the value is set higher, the time it takes for the sound to be played increases.

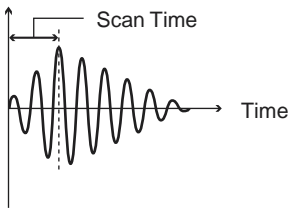

### Making the settings

While repeatedly hitting the pad at a constant force, gradually raise the Scan Time value from 0 msec, until the resulting volume stabilizes at the loudest level. At this setting, try both soft and loud strikes, and make sure that the volume changes appropriately.

```
ADUNCDI KIK:H01
Scan Time 2.0ms
```

Scan Time: 0–4.0 (ms) (0.1ms steps)

## Detecting Trigger Signal Attenuation and Cancelling Incorrect Triggering (Retrigger Cancel)

Playing snare drum pads and other devices with commercially available acoustic drum triggers attached may result in altered waveforms, which may also cause inadvertent sounding at Point A in the following figure.

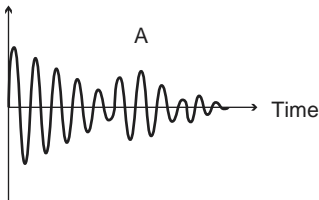

This occurs in particular at the decaying edge of the waveform. Retrigger Cancel detects such distortion in and prevents retriggering from occurring.

Although setting this to a high value prevents retriggering, it then becomes easy for sounds to be omitted when the drums

played fast (roll etc.). Set this to the lowest value possible while still ensuring that there is no retriggering.



You can also eliminate this problem of retriggering with the Mask Time setting. Mask Time does not detect trigger signals if they occur within the specified amount of time after the previous trigger signal was received. Retrigger Cancel detects the attenuation of the trigger signal level, and triggers the sound after internally determining which trigger signals were actually generated when the head was struck, while weeding out the other false trigger signals that need not trigger a sound.

### Making the settings

While repeatedly striking the pad, raise the “Retrig Cancel” value until retriggering no longer occurs.

```
ADUNCDI KIK:H01
Retrig Cancel 5
```

Retrig Cancel (Retrigger Cancel): 1–16

## Double Triggering Prevention (Mask Time)

On a kick pad, for example, if the beater bounces back and strikes the pad a second time immediately after the intended stroke—or, like with acoustic drums if you leave the bass drum beater against the head—it can cause a single strike to “double trigger” (two sounds instead of the intended one). The Mask Time setting helps to prevent such problems. Once a pad has been hit, any additional trigger signals occurring within the specified “MASKTIME” (0–64 msec) will be ignored.

When set to a high value, it then becomes easy for sounds to be omitted when the kick is struck repeatedly in rapid succession. Set this to as low a value as you can.

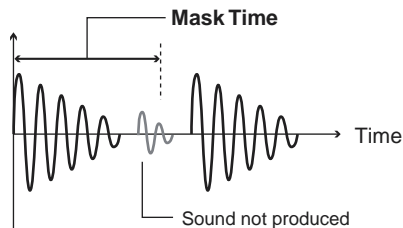

If two or more sounds are being produced when you strike the head just once, then adjust Retrigger Cancel.

### Making the settings

While stepping on the pad being used for the kick, raise the “Mask Time” value until there is no more bouncing (sounds made by the rebounding of the beater).

```
ADUNCDI      KIK:H01
4 Mask Time   8ms
```

Mask Time: 0–64ms (4ms steps)

### Setting Rim Sensitivity on the PD-120 and PD-80R (Rim Sens)

When a PD-80R or PD-120 is used for TRIGGER INPUT 2 (SNARE), you can then adjust the Rim Sensitivity.

Setting this to a higher value makes it easier to get rim sounds. When set to “OFF,” playing a rim shot produces the head instrument’s sound. Increasing the value excessively may cause the rim instrument to sound as well when the head is struck.

#### NOTE

- This can be adjusted only when the Trigger Input 2 “Trigger Type (Trig Type)” is set to either “PD80R” or “PD120” (SETUP/TRIG BASIC/Trig Type; p. 71).
- When the trigger type is set to something other than “PD80R” or “PD120,” or when a trigger input other than Trigger Input 2 is selected, a horizontal line ( ——— ) appears, and you cannot make the setting.

```
ADUNCDI      KIK:H01
4 Rim Sens   -----
```

- You cannot adjust the rim sensitivity of the PD-7 and PD-9. Both rim and head use the same values.

```
ADUNCDI      SNR:H02
4 Rim Sens   11
```

Rim Sens (Rim Sensitivity): OFF, 1–15

## Using the TD-6 with Acoustic Triggers

First, attach a commercially available acoustic drum trigger to the acoustic drums. When finished, proceed with the following settings.

1. **Set the trigger type to “AcDrTrig.”**  
(SETUP/TRIG BASIC/Trig Type; p. 71)
2. **Set “Threshold” to “0” as a reference value.**  
(SETUP/TRIG BASIC/Threshold; p. 73)
3. **Set “TrigCurve (Trigger Curve)” to “LINEAR” as a reference value.**  
(SETUP/TRIG BASIC/TrigCurve; p. 73)
4. **Set the “Sensitivity.”**  
(SETUP/TRIG BASIC/Sensitivity; p. 73)
5. **Set the “Scan Time.”**  
(SETUP/TRIG ADVNCD/Scan Time; p. 75)  
Strike the head several times with the same force, and adjust this parameter if the volume is uneven.
6. **Set the “Retrig Cancel (Retrigger Cancel).”**  
(SETUP/TRIG ADVNCD/Retrig Cancel; p. 75)  
This prevents multiple notes from sounding when a drum is struck once (mainly for a snare drum or toms).
7. **Set the “Mask Time.”**  
(SETUP/TRIG ADVNCD/Mask Time; p. 75)  
On a kick drum, this prevents two sounds instead of the intended “one.”
8. **Set the “Xtalk Cancel (Crosstalk Cancel).”**  
(SETUP/TRIG BASIC/Xtalk Cancel; p. 74)  
This prevents other instruments with drum triggers from sounding when a drum to which a drum trigger has been attached is struck. If a higher value is set, and if two pads are played simultaneously, the one that is struck less forcefully will not sound. Set this to as low a value as you can.
9. **Set the “Threshold.”**  
(SETUP/TRIG BASIC/Threshold; p. 73)  
If notes are unintentionally sounded even after you have adjusted the “CROSSTALK” setting, adjust the “THRESHOLD.” Setting this to a higher value may prevent sounds from being produced when the pad is struck lightly. Set this to as low a value as you can.
10. **Set the “TrigCurve (Trigger Curve).”**  
(SETUP/TRIG BASIC/TrigCurve; p. 73)  
If changes in playing dynamics do not produce a natural change in the volume of the TD-6 instrument, adjust this parameter.

# Chapter 3 Global Settings for the TD-6 (SETUP/UTILITY, Factory Reset)

## Parameters That Can Be Set Here

### SETUP

- UTILITY (Overall Settings) (p. 77)
  - LCD Contrast
  - Percussion Part Level
  - Backing Level
  - Mute
  - Master Tune
  - Preview Velocity
  - Available Memory
- Factory Reset (Restoring the Factory Settings) (p. 79)

## Making the Global Settings (UTILITY)

Overall settings that apply to the entire TD-6.

1. While holding down [SHIFT], press [EDIT (SETUP)].

[EDIT] lights.



2. Press [ENTER].
3. Press [◀] or [▶] to select the parameter you wish to edit.

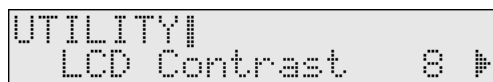

↑ Parameter to set

4. Press [INC/+] or [DEC/-] to make the setting.



↑ Value

5. When you finish making settings, press [KIT] or [SONG] to end the procedure.

## Display Contrast Adjustment (LCD Contrast)

The display contrast is strongly influenced by the location of the TD-6 and the lighting of the room it's in. Adjust this parameter when needed. A larger value results in a brighter screen.



LCD Contrast: 1-16

## Percussion Part Volume Control (Percussion Part Level)

This adjusts the volume of the percussion part.

Raising the value will increase the volume. With a setting of "0," no sound is produced.

### NOTE

- This setting cannot be made in GM mode (p. 100).
- This volume setting is applied to all songs. Even when songs are switched, the setting does not change.

### HINT

The volume level of the drum kit part is adjusted in the "MasterVolume (Master Volume)" (KIT/COMMON/MasterVolume; p. 68).



PercPrtLevel (Percussion Part Level): 0-127

## Backing Instruments Volume Control (Backing Level)

This adjusts the volume of the backing part (Parts 1–4). Raising the value will increase the volume. With a setting of “0,” no sound is produced.

### NOTE

- This setting cannot be made in GM mode (p. 100).
- This volume setting is applied to all songs. Even when songs are switched, the setting does not change.

### HINT

- The volume level of the drum kit part is adjusted in the “MasterVolume (Master Volume)” (KIT/COMMON/MasterVolume; p. 68).
- Adjust the volume level of each part to correct the volume balance among the parts (SONG/PART/Level; p. 89).
- Hold down [SHIFT] and press [SONG] to jump to this screen.

UTILITY  
4 BackingLevel 100

**BackingLevel (Backing Level): 0–127**

## Muting Parts of a Song (Mute)

Select the part that is to be muted when [PART MUTE] is pressed. [PART MUTE] lights while the muting is in effect.

### NOTE

This setting cannot be made in GM mode (p. 100).

### HINT

Hold down [SHIFT] and press [PART MUTE] to jump to this screen.

### MEMO

- This setting remains in effect even when songs are switched and when the TD-6 is played using data from an external MIDI device.
- All percussion instruments in the Preset songs (except for Preset song #1 “DRUMS”) are recorded to the percussion parts.
- Note numbers for muted drum instruments are predetermined and cannot be changed. For more on

muting note numbers, refer to the “Preset Percussion Set List” (p. 124).

- Performances using the TD-6 and pads are recorded as a drum kit part.

UTILITY  
4 Mute SongDrum

### Mute:

**SongDrum, SongDrm/Prc, UserDrmPart, Part1, Part2, Part3, Part4, Part1-4**

### SongDrum:

Mutes only the drum instruments in the percussion part (the percussion instruments still sound). This is convenient when performing with Preset songs.

### SongDrm/Prc:

All percussion part instruments are muted.

### UserDrmPart:

Mutes the performance recorded to the drum kit part. This is convenient when you want to perform along with songs you have recorded yourself.

### Part1, Part2, Part3, Part4:

The individual parts are muted.

### Part1-4:

All Parts 1–4 are muted.

## Tuning the TD-6 (Master Tune)

This tunes Parts 1–4 as a whole.

The reference pitch is 440.0 Hz.

### MEMO

Tuning of the drum kit part and percussion part instruments is not affected by this setting.

UTILITY  
4 MasterTune 440.0

### MasterTune (Master Tune):

**415.3–466.2 (Hz) (0.1 Hz steps)**

## Preview Volume Control (Preview Velocity)

This sets the velocity used when an instrument is previewed. Raising the value will increase the volume. With a setting of “0,” no sound is produced.

```
UTILITY|
4 Preview Velo 90 ▶
```

Preview Velocity: 0–127

## Checking the Remaining Amount of Memory (Available Memory)

You can check the amount of available memory.

```
UTILITY|
4 AvailMemory 100%
```

AvailMemory (Available Memory): 0–100%

## Restoring the Factory Settings (Factory Reset)

This restores the pad and instrument settings, song data, and other information stored in the TD-6 to the original factory settings.

### NOTE

All data and settings stored in the TD-6 are lost in carrying out this operation. Use the “Bulk Dump” operation to save crucial data and settings to an external MIDI device (SETUP/BULK DUMP/Bulk Dump; p. 103).

### HINT

When [SHIFT] and [EDIT (SETUP)] are held down when the power is turned on, the display jumps to the Factory Reset screen. When carrying out Factory Reset, read from step 4.

1. While holding down [SHIFT], press [EDIT (SETUP)].  
[EDIT (SETUP)] lights.

2. Press [▶] to select “FactoryReset”

```
SET|
UP | 4 FactoryReset
```

3. Press [ENTER].

The Factory Reset screen appears.

4. Press [INC/+] or [DEC/-] to select the parameter you want to restore to factory settings.

```
F RST| [ENTER]/[EXIT]
Reset ALL
```

↑ Value

5. Press [ENTER].

Press [EXIT] to cancel the operation.

The confirmation screen appears.

```
Are You Sure?
[ENTER] / [EXIT]
```

6. If you're ready to proceed, press [ENTER], and the Factory Reset operation will be executed.
7. When the Factory Reset is finished, the Completed screen appears.

```
Completed!
```

### Reset (Factory Reset):

**ALL, THIS DRUM KIT, ALL DRUM KITS,  
ALL SONGS**

#### ALL:

All internal settings will be restored to the factory settings.

#### THIS DRUM KIT:

Only the settings for the currently selected drum kit are restored to the factory settings.

#### ALL DRUM KITS:

The settings for all of the TD-6's internal drum kits are restored to the factory settings.

#### ALL SONGS:

All of the TD-6's internal song data is restored to the factory settings.

# Chapter 4 Setting the Metronome (Click Edit)

## Parameters That Can Be Set Here

### CLICK (Click Settings) (p. 80)

- Click Level
- Time Signature
- Interval
- Inst
- Pan
- Play Count In
- Rec Count In

## Switching the Click On/Off (Click)

You can switch the click sound on and off by pressing [CLICK]. [CLICK] lights while the click sound is set to be played.

Click is played



Lit

Click is not played



Unlit



Click cannot be used in GM mode (p. 100).

## Tempo Adjustment (Tempo)

For each song selected, the tempo of the click changes to the tempo specified for that song.

1. Press [CLICK].  
[CLICK] lights, and the click sound begins to play.
2. While holding down [SHIFT], press [CLICK (TEMPO)].  
The "TEMPO" screen appears.



3. Press [INC/+] or [DEC/-] to select the tempo.
4. When you finish making settings, press [EXIT] to end the procedure.  
The "TEMPO" screen disappears.

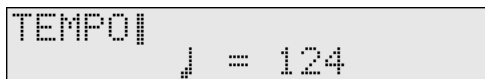

TEMPO: 20-260

## Setting the Way the Click Sounds

Settings that determine how the click sounds, volume, time signature etc.

1. Confirm that [EDIT] is not lit.  
If this lights, press [KIT] or [SONG] to extinguish it.
2. Press [CLICK].  
[CLICK] lights, and the click sound begins to play.
3. Press [EDIT].
4. Press [◀] or [▶] to select the parameter you wish to edit.



↑ Parameter to set

5. Press [INC/+] or [DEC/-] to make the setting.



↑ Value

6. When you finish making settings, press [KIT] or [SONG] to end the procedure.

## Volume Adjustment (Click Level)

Adjusts the volume of the click sound. Raising the value will increase the volume. With a setting of "0," no sound is produced.

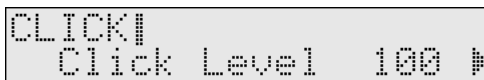

Click Level: 0-127



## Setting the Time Signature (Time Signature)

Specify the time signature of the click sound. When the numerator is set to “0,” no accent is added to the first beat. The metronome click sound then plays at a fixed volume.

### NOTE

It is not possible to change the time signature of the metronome clicks while a song is playing back. The metronome clicks corresponds to the time signature of the song.



**Time Sig (Time Signature):**  
0–13/2, 0–13/4, 0–13/8, 0–13/16

## Setting the Interval (Interval)

Setting How the Sound Plays (Interval).



**Interval:**  
1/2 (half note), 3/8 (dotted quarter note),  
1/4 (quarter note), 1/8 (eighth note),  
1/12 (12th note), 1/16 (16th note)

## Selecting the Click Sound (Inst)

You can choose the sound for the metronome click. When the parameter is set to “VOICE,” the click is sound becomes a human voice.



**Inst:**  
VOICE, CLICK, BEEP, METRONOME, CLAVES,  
WOOD BLOCK, STICKS, CROSS STICK,  
TRIANGLE, COWBELL, CONGA, TALKING DRM,  
MARACAS, CABASA, CUICA, AGOGO,  
TAMBOURINE, SNAPS, 909 SNARE, 808  
COWBELL

## Stereo Position (Pan)

You can localize the metronome click within the stereo sound field.

### NOTE

The effect set here is applied only when connected in stereo.



**Pan: L15–Center–R15**

**L15:** Sound is positioned at the extreme left.  
**CENTER:** Positions the sound in the center.  
**R15:** Sound is positioned at the extreme right.

## Inserting a Count Before Playback or Recording (Play Count In, Rec Count In)

You can have a count sound (click) inserted before recording or playback of a song begins.



**PlayCountIn (Play Count In):**  
OFF, 1MEAS, 2MEAS

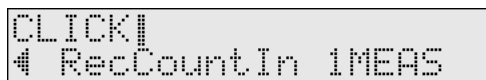

**RecCountIn (Rec Count In):**  
OFF, 1MEAS, 2MEAS

**OFF:**  
Playback/recording will begin without a count-in.  
**1MEAS:**  
Playback/recording begins after a 1-measure count-in.  
**2MEAS:**  
Playback/recording begins after a 2-measure count-in.

# Chapter 5 Editing Songs (SONG Edit)

## Parameters That Can Be Set Here

### SONG

- COMMON (Overall Settings) (p. 86)
  - Tempo
  - Play Type
  - Quick Play
  - Reset Time
  - Tap Exclusive Switch
  - Song Lock
  - Song Name
- PART (Pad Settings) (p. 88)
  - Percussion Set/Inst
  - Level
  - Pan
  - Ambience Send Level
  - Bend Range
- COPY (Copying Songs) (p. 90)
- DELETE (Deleting Songs) (p. 91)
- ERASE (Erasing Songs) (p. 92)

## About Songs and the Song Screen

### About Songs

The TD-6's sequencer organizes music into six parts. The Drum Kit part is used to record/play back what is played on the pads. Additionally, Part 1, Part 2, Part 3, and Part 4 are the four backing instrument parts (backing parts), and there is another Percussion part.

The collective performance of these six parts is called a **song**.



Sequencer cannot be used in GM mode (p. 100).

### Preset (Internal) Songs (Songs 1–150)

What the various parts should play has already been recorded. The performances in Preset patterns cannot be changed, deleted, or recorded. These songs come in handy for backing during drum practice, or for live performances.



Drum performances in the Preset songs (except song #1 "DRUMS") are recorded to the percussion part.

### Using Preset Songs

You cannot save any changes you make to the settings in preset songs. While you can make temporary changes to these settings, they revert to the settings already selected for that preset song when another song is selected.

Furthermore, preset songs cannot be edited or recorded.

- The following appears in the display when you attempt to change the settings. Press [EXIT] to dismiss the message.

- The following is displayed when the [REC ●] is pressed with a Preset song selected and select a new user song automatically.

If you want to change, edit, or record any preset song settings, copy them to a user song (p. 90). When user song settings are altered, the changes are saved automatically.

### About Preset Song Copyright

The sounds, phrases and songs contained in this product are sound recordings protected by copyright. Roland hereby grants to purchasers of this product the permission to utilize the sound recordings contained in this product for the creation and recording of original musical works; provided however, the sound recordings contained in this product may not be sampled, downloaded or otherwise re-recorded, in whole or in part, for any other purpose, including but not limited to the transmission of all or any part of the sound recordings via the internet or other digital or analog means of transmission, and/or the manufacture, for sale or otherwise, of any collection of sampled sounds, phrases or patterns, on CD-ROM or equivalent means.

The sound recordings contained in this product are the original works of Roland Corporation. Roland is not responsible for the use of the sound recordings contained in this product, and assumes no liability for any infringement of any copyright of any third party arising out of use of the sounds, phrases and patterns in this product.

### User Songs (Songs 151–250)

These are songs that can be recorded and edited. You can record performances exactly as they are played using the pads or an external MIDI keyboard (Realtime Recording; p. 93). Changes in User song settings are saved automatically.

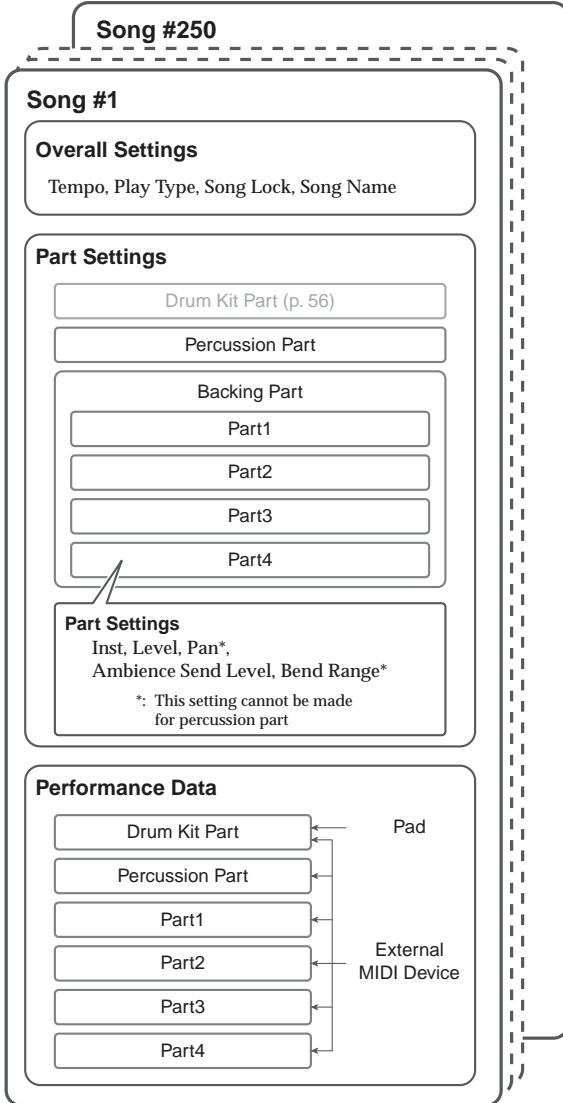

## About the Song Screen

The screen that appears when [SONG] is pressed is called the Song screen.

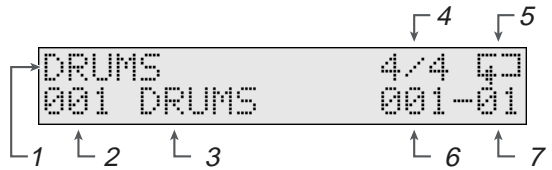

### 1 Song Category

Shows the category of the currently selected song.

### 2 Song Number

Shows the number of the currently selected song.

### 3 Song Name

Shows the name of the currently selected song.

### 4 Beat

### 5 Playback Method Setting (p. 86)

This indicates the song playback type.

### 6 Measure Number

The current measure number is indicated. Pressing [PLAY ►] starts playback from the beginning of the measure indicated here.

### 7 Beat

The current beat is indicated.

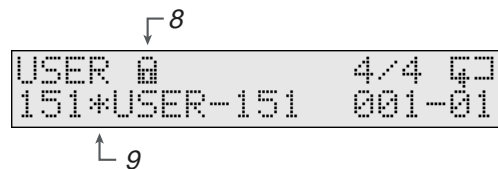

### 8 Song Lock Setting

"0" appears with User songs that have Song Lock (p. 87) set to "ON."

### 9 New User Song

"\*" indicates a new User song.

## MEMO

Only the performance data is recorded to the drum kit part. When the song is played back, the settings of instruments and effects etc. of the current selected drum kit are used.

## Choosing a Song

Part settings are switched when a song is selected.



To see which songs can be selected here, refer to “Preset Song List” (p. 128).

### Choosing from a Category (Song Category)

Select songs by searching the category names.

**1. Press [SONG].**

[SONG] lights, and the SONG screen appears.

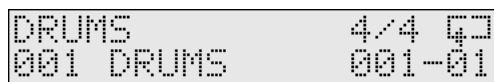

**2. Hold down [SHIFT] and press [INC/+] or [DEC/-] to select the song category.**

**SONG CATEGORY:**

**DRUMS, ROCK, METAL, BALLAD, R&B, BLUES, POPS, R&R, COUNTRY, JAZZ, FUSION, DANCE, REGGAE, LATIN, BRAZIL, BASICPTN, LOOP, 1SHOT, TAP, USER**

### Choosing a Song (Song)

**1. Press [SONG].**

[SONG] lights, and the SONG screen appears.

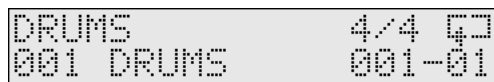

**2. Press [INC/+] or [DEC/-] to select the song.**

**SONG: 1-250**

## Playing Back a Song

**1. Select the song that you wish to play back (foregoing paragraph).**

**2. Press [PLAY ►].**

[PLAY ►] lights, and playback of the song begins.

**3. To stop playback of the song, press [STOP ■].**

The [PLAY ►] light goes out, and the song returns to the beginning of the measure that was being played back.

**MEMO**

When playback of a song is stopped, you can do the following.

- Pressing [STOP ■], returns you to the beginning of the song.
- Pressing [►], advances you to the next measure.
- Pressing [◄], returns you to the previous measure.

**HINT**

- To temporarily change the tempo of the song, hold down [SHIFT] and press [CLICK] (p. 86).
- To insert a count before playback of the song, set “PlyCountIn (Play Count In)” (CLICK/PlyCountIn; p. 81).

### Convenient Function for Playback

During playback of a song, you can have the buttons corresponding to the drums being played in the percussion part light up.

You can also have the buttons light even when Part Mute (p. 85) is in use, making this convenient for practicing with the Preset songs.

Drum Instrument	Button Lit	Note Number
Kick	[PART MUTE]	35, 36
Snare	[PLAY ►]	37, 38, 39, 40
Low Tom	[KIT]	41, 43
Hi-Hat	[REC]	42, 44, 46
Mid Tom	[SONG]	45, 47
Hi Tom	[CLICK]	48, 50
Cymbal	[EDIT]	49, 51, 52, 53, 55, 57, 59

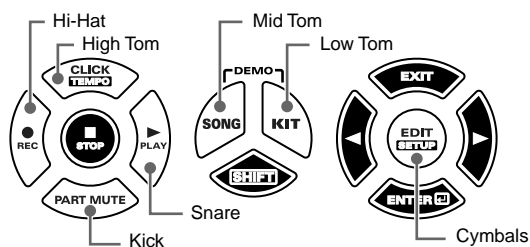

**MEMO**

Even when “9 Perc Only” or “10 Special” is selected for the percussion set, the buttons still light up according to the note numbers.

**NOTE**

- The correspondence between the lighted buttons and note numbers is predetermined and cannot be changed.
- This function cannot be used with songs in which drum performances are recorded to the drum kit part.

1. **Select the song to be played back (p. 84).**
2. **Hold down [SHIFT] and press [PLAY ► ].**  
Playback of the song begins, and the buttons corresponding to the performance of the percussion part drums light up.
3. **To stop the playback, press [STOP ■ ].**

## Adjusting the Song Volume

You can adjust the volume of the song in the backing parts (Parts 1–4) and the percussion part.

Raising the value will increase the volume. With a setting of “0,” no sound is produced.

**NOTE**

This volume setting is applied to all songs.

**HINT**

- Although drum performances in the Preset songs are recorded to the “percussion part,” when you create your own songs, what you play on the pads is recorded to the “drum kit part.” The volume level of the drum kit part is adjusted in the “MasterVolume” (Master Volume) (KIT/COMMON/MasterVolume; p. 68).
  - Adjust the volume level of each part to correct the volume balance among the parts (SONG/PART/Level; p. 89).
1. **While holding down [SHIFT], press [SONG].**  
The screen for setting the volume of the backing parts appears.

```
UTILITY|
# BackingLevel 100 ▶
```

2. **Press [INC/+] or [DEC/-] to make the setting.**

3. **Press [◀].**

The screen for setting the volume of the percussion part appears.

```
UTILITY|
# PercPrtLevel 100 ▶
```

4. **Press [INC/+] or [DEC/-] to make the setting.**
5. **When you finish making settings, press [SONG] to end the procedure.**

```
UTILITY|
# BackingLevel 100 ▶
```

**BackingLevel (Backing Level): 0–127**

```
UTILITY|
# PercPrtLevel 100 ▶
```

**PercPrtLevel (Percussion Part Level): 0–127**

## Muting a Selected Part (Part Mute)

Each time [PART MUTE] is pressed the mute is alternately turned on or off. [PART MUTE] lights when the mute is on. At the factory settings, only percussion part drum tones are muted.

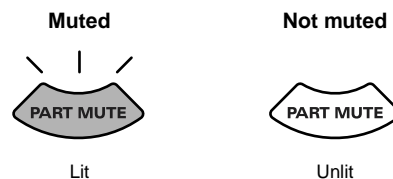
**HINT**

The part to be muted here is selected in “Mute” (SETUP/UTILITY/Mute; p. 78). Hold down [SHIFT] and press [PART MUTE] to jump to the settings screen.

**NOTE**

Settings for muted parts are applied to all songs.

## Overall Song Settings (COMMON)

Make the settings for each song.

### NOTE

- If you want to save any changes made to Preset song settings, first copy the song to a User Song before making the changes (SONG/COPY; p. 90). Changes made to a Preset song are only temporary, so when you select a different song, the song reverts to its predetermined part settings. Changes made to Preset songs cannot be saved.
- Settings of parts which have the Song Lock (SONG/COMMON/Song Lock; p. 87) set to "ON" cannot be changed. Make the settings after setting this to "OFF."

**1. Confirm that [CLICK] is not lit.**

If this lights, press [CLICK] to extinguish it.

**2. Press [SONG], then [EDIT].**

[SONG] and [EDIT] light.



**3. Press [ENTER].**

**4. Press [◀] or [▶] to select the parameter you wish to edit.**



↑ Parameter to set

**5. Press [INC/+] or [DEC/-] to make the setting.**



↑ Value

**6. When you finish making settings, press [SONG] to end the procedure.**

## Setting the Tempo (Tempo)

You can set the tempo for each song individually. When a song is selected, the tempo you specify here will be set automatically. Changes made to a Preset song are temporary, and when you select a different song, the song reverts to its predetermined settings.



Tempo: 20–260

## Temporarily Changing the Tempo of a Song During Playback

You can temporarily change the tempo of a song while it is being played back.

When another song is selected, the song reverts to the tempo (SONG/COMMON/Tempo) preset for that song. This is convenient for practicing or other times when you want to temporarily change to tempo for playback.

**1. While holding down [SHIFT], press [CLICK].**

The Tempo screen appears.



**2. Press [INC/+] or [DEC/-] to make the setting.**

## Selecting How the Song Plays Back (LOOP, 1SHOT, TAP) (Play Type)

This specifies how songs will be played back. When [PLAY ▶] is pressed or when the pad specified with the Pad Pattern function (p. 65) is struck, then the song is played back using the type specified here.

### NOTE

- User songs recorded with "Quantize" (p. 95) set to "OFF" may not play back correctly with Tap Playback.
- New songs cannot be set to "Tap." Change this after first recording something to the song.

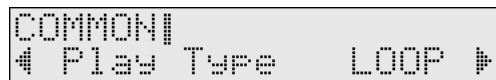

### PLAY TYPE: LOOP, 1SHOT, TAP

**LOOP (◀□):**

After the pattern is played back all the way to the end, playback then repeats, starting at the beginning of the song. Playback continues until [STOP ■] is pressed.

**1SHOT (ONE SHOT) (→+):**

Playback stops once the end of the song is reached. When set to Pad Pattern Function (p. 65), each time the pad is struck returns you to the beginning of the song and starts playback.

**TAP (⦿⦿):**

The sounds in the song are played back one by one in sequence each time [PLAY ▶] is pressed. When set to Pad Pattern Function (p. 65), the sounds are played back in sequence each time the pad is struck.

## Playing Back the Song from the First Note/Event (Quick Play)

This is an auxiliary function available when “LOOP” or “ISHOT” is specified as the Play Type for the song (SONG/COMMON/Play Type; previous section).

Quick Play starts playback of the pattern from the first note (first event) even if when you recorded the pattern, you left a pause at the beginning. For example if you had just played/recorded freely, ignoring the tempo clock.

### NOTE

When “Quick Play” is set to “ON,” stopping playback of the song returns you to the beginning of the song.

### MEMO

The blank portion is played when you return to the beginning of the song while in Loop Playback.



Quick Play: OFF, ON

## Reset Time When Using Tap Playback (Reset Time)

This is an auxiliary function available when “TAP” is specified as the Play Type for the song (SONG/COMMON/Play Type; p. 86).

This feature automatically returns you to the beginning of the song if during Tap Playback the song is not played back within a specified interval. This value sets the time from when the song was last played back; if the set time elapses, then returns to the beginning before it is next played back.

When performing with the Pad Pattern function, if you start playback by striking a pad and then do not strike the pad again within the specified interval, the song is returned to the beginning. If it is set to “OFF,” this function will be disabled.

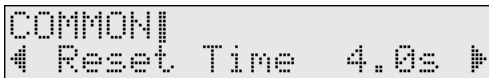

Reset Time: OFF, 0.1–8.0s (0.1 sec steps)

## Preventing Layering of Sounds in Tap Playback (Tap Exclusive Switch)

This is an auxiliary function available when “TAP” is specified as the Play Type for the song (SONG/COMMON/Play Type; p. 86).

In Tap playback, if one sound is set to play before the previous sound has finished playing, this setting allows you to either have the previous sound stop and the subsequent sound start playing (ON) or have the two sounds layered (OFF).



Tap Exc SW (Tap Exclusive Switch): OFF, ON

OFF:

The previous sound continues to play to the end, while the subsequent sound is superimposed on it.

ON:

The previous sound stops while in progress, and the subsequent sound starts playing.

## Protecting User Song Settings (Song Lock)

To prevent accidental erasure or editing, you can lock User songs.

If you attempt to change the settings of a song for which this set to “ON,” a warning screen appears, and you cannot change the settings.

However, you cannot select this during recording of a song or when a new User song is selected by pressing [SHIFT] +

[STOP ■]. Since you can also lock unused User Songs, then in situations such as when using the TD-6 as a sound module, it's a good idea to lock songs when you want to save their settings.

[ ] appears in the Song screen when a User Song is locked.

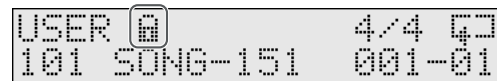

### NOTE

The settings screen does not appear when a Preset song is selected.



Song Lock: OFF, ON

## Naming a Song (Song Name)

You can use up to eight characters when naming a User song. Press [◀] or [▶] to move the cursor (under bar) to the character you want to change, then press [INC/+] or [DEC/-] to select the character.

### NOTE

The settings screen does not appear when a Preset song is selected.

### HINT

- Holding down [SHIFT] and pressing [INC/+] switches through the following sequence: uppercase alphabet → lowercase alphabet → 0 → ! → space. Holding down [SHIFT] and pressing [DEC/-] switches through the sequence in reverse order.
- Holding down [SHIFT] and pressing [◀] deletes the character at the cursor position and closes the resulting space by shifting forward the characters that follow.
- Holding down [SHIFT] and pressing [▶] inserts a space the character at the cursor position and shifts back the characters that follow.

```
COMMON|
4 SngName[USER-151]
```

### SngName (Song Name): 8 characters

The following characters may be used.

```
ABCDEFGHIJKLMNOPQRSTUVWXYZ
abcdefghijklmnopqrstuvwxyz
0123456789
!##%&'*^`_+~*/=<>()[]{}.,:;?@#++!
space
```

## Part Settings (PART)

Set the backing parts (Parts 1–4) and percussion part in each song.

### NOTE

- Changes made to a Preset song are only temporary, and when you select a different song, the song reverts to its predetermined part settings. If you want to save any changes made to Preset song settings, first copy the song to a User Song before making the changes (SONG/COPY; p. 90).
- Settings of parts which have the Song Lock (SONG/COMMON/Song Lock; p. 87) set to “ON” cannot be changed. Make the settings after setting this to “OFF.”



For the drum kit part settings, refer to Chapter 1.

1. **Confirm that [CLICK] is not lit.**  
If this lights, press [CLICK] to extinguish it.
2. **Press [SONG], then [EDIT].**  
[SONG] and [EDIT] light.
3. **Press [◀] or [▶] to select the part to be set.**

```
SONG|
EDIT|4 PART:Perc [▶]
```

↑ Part to set

4. **Press [ENTER □].**
5. **Press [◀] or [▶] to select the parameter you wish to edit.**

```
PERC|
Set 1 Standard 1 [▶]
```

↑ Parameter to set

6. **Press [INC/+] or [DEC/-] to make the setting.**

```
PERC|
Set 1 Standard 1 [▶]
```

↑ Value

7. **When you finish making settings, press [SONG] to end the procedure.**



## Choosing Percussion Set and Instruments (Percussion Set, Inst)

Select a percussion set for the percussion part and instruments for Parts 1–4.

### Percussion Part

The TD-6 features ten Preset percussion sets that are ready to use.



You cannot change the content of the Preset percussion sets.



To see which percussion sets can be selected here, refer to the “Preset Percussion Set List” (p. 124).



#### Percussion Set:

A collection of a number of percussion instruments. A different percussion instrument is assigned to each note number, so multiple instruments can be used at one time.

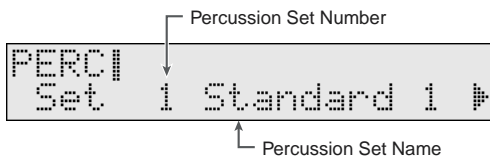

#### Set (Percussion Set): 1–10

### Parts 1–4

You can select all internal tones in sequence, including variation tones.

You can switch instrument groups for the backing instruments by holding down [SHIFT] and pressing [INC/+] or [DEC/-].



To see which backing instruments and instrument groups can be selected here, refer to the “Backing Instrument List” (p. 126).



Instrument numbers correspond to the program numbers (1–128).



#### Variation Tone:

This is a type of tone that varies slightly from that of the instrument number. The number of variation tones varies with the instrument number.

#### Capital sounds

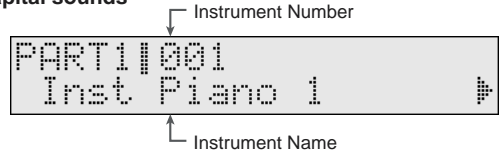

#### Variation sounds

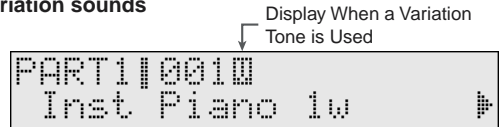

#### Backing Inst: 1–128

## Adjusting the Part Volume (Level)

Specifies the volume at each point. Raising the value will increase the volume. With a setting of “0,” no sound is produced.

Adjust here to balance the volume levels of the different parts.



#### LEVEL: 0–127

## Adjusting the Stereo Position (Pan)

Adjusts the pan (the perceived location of the sound between the left and right speakers).

### NOTE

The effect set here applies only when connected in stereo.

### MEMO

Percussion parts do not feature the Pan setting.



**Pan:** L15–Center–R15

**L15:** Sound is positioned at the extreme left.

**CENTER:** Sound is positioned in the center.

**R15:** Sound is positioned at the extreme right.

## Adjusting the Amount of Ambience (Ambience Send Level)

You can adjust the ambience level for each part individually. The ambience effect deepens the higher the value is set. When set to “0,” no ambience is applied.

### NOTE

The specified ambience effect is applied to the currently selected drum kit. To check how the effect sounds, select a drum kit that has the Ambience Switch set to “ON.” (KIT/ AMBIENCE/ Ambience SW; p. 62)



**AmbSendLevel:** 0–127

## Adjusting the Bend Range (Bend Range)

This adjusts the degree to which the pitch of the sound is changed when the maximum Pitch Bend is received from an external MIDI device.

This can be set from “0” to “24” (two octaves) in semitone steps. When set to “0,” no change is made.

### MEMO

Percussion parts do not feature the Bend range setting.



**Bend Range:** 0–24

## Copying a Song (COPY)

This is used to copy Preset songs and User songs to other User songs.

Part instruments and volume and other settings are copied just as they are.

Executing this operation deletes the content of the copy destination, so check all content carefully before carrying out this operation.

### 1. Confirm that [CLICK] is not lit.

If this lights, press [CLICK] to extinguish it.

### 2. Press [SONG], then [EDIT].

[SONG] and [EDIT] light.

### 3. Press [▶] to select “COPY.”



### 4. Press [ENTER].

### 5. Press [◀] or [▶] to select the copy source song.

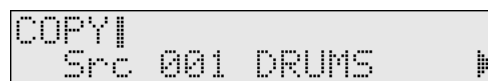

↑ Copy source song

### 6. Press [▶].

The copy destination song selection screen appears.

7. Press [INC/+] or [DEC/-] to select copy destination song.

**HINT**

You can select a song that has not yet been used by holding down [SHIFT] and pressing [STOP ■]. New User songs are indicated by “\* ” in the display.

```
COPY| [ENTER]/[EXIT]
4 Dst*151 USER-151
```

↑ Copy destination song

8. Press [ENTER □].

Press [EXIT] to cancel the operation.

```
Are You Sure?
[ENTER] / [EXIT]
```

9. Press [ENTER □] to execute the operation.

When you have finished copying the song, the Completed screen appears.

```
Completed!
```

10. When you finish copying, press [SONG] to end the procedure.

Src (Copy Source): 1-250

Dst (Copy Destination): 151-250

## Deleting a Song (DELETE)

This deletes all of the song's settings, turning the song into a new User song.

1. Confirm that [CLICK] is not lit.

If this lights, press [CLICK] to extinguish it.

2. Press [SONG], then [EDIT].

[SONG] and [EDIT] light.

3. Press [▶] to select “DELETE.”

```
SONG|
EDIT| 4 DELETE
```

4. Press [ENTER □].

5. Press [INC/+] or [DEC/-] to select the song to be deleted.

```
DEL| [ENTER]/[EXIT]
Song 151 USER-151
```

↑ Song being deleted

6. Press [ENTER □].

Press [EXIT] to cancel the operation.

```
Are You Sure?
[ENTER] / [EXIT]
```

7. Press [ENTER □] to execute the operation.

When you have finished deleting the song, the Completed screen appears.

```
Completed!
```

8. When you finish deleting, press [SONG] to end the procedure.

SONG (Delete Song): 151-250

## Erasing Performance Data in a Song (ERASE)

This erases the User song. Only the performance data is erased, and the beat, measure length, parts, and the song's other settings are left intact. You can also erase specific parts.

1. **Confirm that [CLICK] is not lit.**  
If this lights, press [CLICK] to extinguish it.

2. **Press [SONG], then [EDIT].**  
[SONG] and [EDIT] light.

3. **Press [▶] to select "ERASE."**

A screenshot of the SONG EDIT menu. The screen displays 'SONG|' on the top line and 'EDIT|4 ERASE' on the bottom line. A cursor is positioned at the end of the 'ERASE' option. To the right of the screen, there is a small icon of a square with a diagonal line through it.

4. **Press [ENTER] [↵].**
5. **Press [INC/+] or [DEC/-] to select the song to be erased.**

A screenshot of the ERASE menu. The screen displays 'ERASE|' on the top line and 'Song 151 USER-151▶' on the bottom line. A cursor is positioned at the end of the 'USER-151' option.

↑ Song being erased

6. **Press [▶].**
7. **Press [INC/+] or [DEC/-] to select the part to be erased.**

A screenshot of the ERASE menu. The screen displays 'ERASE| [CENTER] / [EXIT]' on the top line and '4 Part ALL' on the bottom line. A cursor is positioned at the end of the 'ALL' option.

↑ Part being erased

8. **Press [ENTER] [↵].**  
Press [EXIT] to cancel the operation.

A screenshot of the 'Are You Sure?' confirmation screen. The screen displays 'Are You Sure?' on the top line and '[ENTER] / [EXIT]' on the bottom line.

9. **Press [ENTER] [↵] to execute the operation.**  
When you have finished erasing the song or part, the Completed screen appears.

A screenshot of the 'Completed!' screen. The screen displays 'Completed!' in the center.

10. **When you finish erasing, press [SONG] to end the procedure.**

### SONG (Erase Song): 151–250

#### Part (Erase Part):

**ALL, KIT, PERC, PART1, PART2, PART3, PART4**

#### ALL:

The performance data for all parts is erased.

#### KIT:

The performance data for the drum part is erased.

#### PERC:

The performance data for the percussion part is erased.

#### PART1:

The performance data for Part 1 is erased.

#### PART2:

The performance data for Part 2 is erased.

#### PART3:

The performance data for Part 3 is erased.

#### PART4:

The performance data for Part 4 is erased.

# Chapter 6 Recording a Song (Realtime Recording)

## Parameters That Can Be Set Here

RECORDING STANDBY (Recording Settings) (p. 94)

- Time Signature
- Length
- Tempo
- Quantize
- Recording Mode
- Hit Pad Start

What is played on the pads or on an external MIDI keyboard can be recorded (**Realtime Recording**).

The performance of the hi-hat control pedal is also recorded.

### NOTE

- Sequencer cannot be used in GM mode (p. 100).
- The amount that can be recorded to the TD-6 is limited. Please keep in mind that even though there are 100 user songs, the amount of memory available will be determined by how much data is recorded into each song.

### HINT

- Recording the hi-hat control pedal performance data consumes a large amount of memory. Make the settings related to recording performance data in “PdlDataThin (Pedal Data Thin)” (SETUP/MIDI COMMON/PdlDataThin; p. 99).
- You can check the amount of available memory in “AvailMemory (Available Memory)” (SETUP/UTILITY/AvailMemory; p. 79).

## Preparations for Recording

Before starting to record, first make the MIDI, part, and other such settings.

## When Recording Pad Performances

Only the performance data is recorded to the drum kit part. When the song is played back, the settings of instruments and effects etc. of the current selected drum kit are used.

### 1. Select the User Song to be recorded (p. 84).

You can select a new User song by holding down [SHIFT] and pressing [STOP ■] while in the Song screen. New User songs are indicated by “※” in the display.

### HINT

If there are no new User songs available, you can delete an unneeded song (SONG/DELETE; p. 91).

### 2. Record using the procedure described in “How To Record (RECORDING STANDBY)” (p. 94).

## Recording Performances by External MIDI Devices

### 1. Match the external MIDI device’s MIDI transmission channel with the MIDI channel of the part to be recorded. (SETUP/MIDI PART Part CH; p. 102)

Part	Factory Preset MIDI Channel
Drum Kit Part	CH10
Percussion Part	CH10
Part 1	CH1
Part 2	CH2
Part 3	CH3
Part 4	CH4

### 2. Select CH10 to layer the drum kit part and percussion part together; when recording from an external MIDI device, then set “CH10Priority (Channel 10 Priority)” to determine whether the drum kit part or the percussion part is to be recorded. (SETUP/MIDI COMMON/CH10Priority; p. 99)

### 3. Select the User Song to be recorded (p. 84). You can select a new User song by holding down [SHIFT] and pressing [STOP ■] while in the Song screen. New User songs are indicated by “※” in the display.

### HINT

If there are no new User songs available, you can delete an unneeded song (SONG/DELETE; p. 91).

### 4. Select the part instrument or percussion set to be recorded (SONG/PART/Inst; p. 89).

### NOTE

Program Change and Bank Select messages transmitted from an external MIDI device are not recorded by the sequencer. Use the TD-6 to select the part instruments.

### 5. Make the other settings for the part to be recorded. (SONG/PART; p. 88)

### 6. Record using the procedure described in “How To Record (RECORDING STANDBY)” (p. 94).

## How To Record (RECORDING STANDBY)

1. Prepare for recording using the procedure described in “Preparations for Recording” (p. 93).

2. Press [SONG] → [REC ● ].

[PLAY ►] flashes, while [SONG], [REC ●] and [CLICK] light up.

### HINT

- If a Preset song is selected when you press [REC ● ], then a new User song is selected automatically. In this case, new User songs that have Song Lock (SONG/COMMON/Song Lock; p. 87) set to “ON” cannot be selected.
- If there are no new User songs available, delete any unneeded songs (SONG/DELETE; p. 91).
- To cancel the recording, press [STOP ■] or [EXIT].

3. Press [◀] or [▶] to select the parameter you wish to edit.

```
REC STBYI
Time Sig 4/4 ▶
```

↑ Parameter to set

4. Press [INC/+] or [DEC/-] to make the setting.

```
REC STBYI
Time Sig 4/4 ▶
```

↑ Value

5. Press [PLAY ►] to begin recording.

[PLAY ►] stops flashing and remains lit, and recording begins.

The following appears in the upper left of the screen during recording.

```
Recording 4/4
151 USER-151 001-01
```

### MEMO

To insert a count before recording, set “RecCountIn (Recording Count In)” (CLICK/RecCountIn; p. 81).

6. Play with pads or MIDI keyboards to record.

7. Press [STOP ■] to stop recording.

The [PLAY ►] and [REC ●] lights go out.

## Setting the Time Signature (Time Signature)

This specifies the beat of the song to be recorded.

### NOTE

The time signature cannot be changed when recording additional material to a previously recorded song.

```
REC STBYI
Time Sig 4/4 ▶
```

**Time Sig (Time Signature):**

1-13/2, 1-13/4, 2-13/8, 4-13/16

## Setting the Number of Measures (Length)

This specifies the measure length in the song being recorded.

### MEMO

When “REPLACE” is specified as the recording mode (SONG/REC/RecMode; p. 95), the measure length setting is unnecessary. The recorded measure length is automatically specified as the “Length.”

```
REC STBYI
4 Length 1 ▶
```

**Length: 1-999**

## Setting the Song Tempo (Tempo)

This specifies the tempo used when recording and playing back the song.

```
REC STBYI
4 Tempo J= 120 ▶
```

**Tempo: 20-260**

## Quantize During Recording (Quantize)

“Quantize” is a function that corrects mistakes or discrepancies in the timing of the performance being recorded.

Timing problems almost always occur when recording performances using pads, a MIDI keyboard, or other instruments. This function corrects timing mistakes and allows you to make recordings with accurate timing.

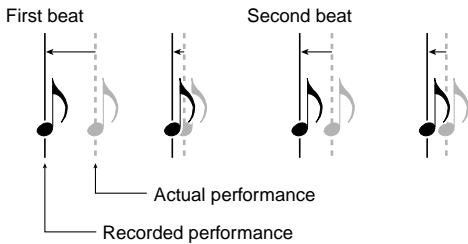

This is usually set to the shortest note appearing in the phrase to be recorded. When set to “OFF,” the pattern is then recorded with the timing used in performance.

### HINT

Carry out the quantize when recording a song using Tap Playback. You may be unable to play back the song correctly with Tap Playback if quantize is set to “OFF” when the song is recorded.



### Quantize:

- ♩ 8 (8th note), ♩<sub>3</sub> 8T (8th note triplets),
- ♩ 16 (16th note), ♩<sub>3</sub> 16T (16th note triplets),
- ♩ 32 (32nd note), ♩<sub>3</sub> 32T (32nd note triplets),
- ♩ 64 (64th note), OFF

## Selecting the Recording Method (Loop All, Loop1, Loop2, Replace) (Recording Mode)

Selects how recording will take place.



### RecMode (Recording Mode): REPLACE, LOOP ALL, LOOP 1, LOOP 2

#### REPLACE:

Recording continues until [STOP ■] is pressed. All data previously recorded in the all parts is erased.

#### LOOP ALL:

The entire song repeats, and the new material is layered onto the previous performance.

#### LOOP1:

The measure starting from the point where recording begins is repeated, and the new material is layered onto the previous performance.

#### LOOP2:

The two measures starting from the point where recording begins are repeated, and the new material is layered onto the previous performance.

## Start Recording with a Pad or Pedal Trigger (Hit Pad Start)

This function starts the recording process the instant you strike a pad or pedal.

### HINT

The “RecCountIn (Recording Count In)” setting is disregarded (CLICK/RecCountIn; p. 81).



### HitPadStart (Hit Pad Start): OFF, ON

# Chapter 7 Making the MIDI Settings (SETUP/MIDI, BULK DUMP)

## Parameters That Can Be Set Here

### SETUP

- MIDI COMMON (MIDI Settings) (p. 97)
  - Note Chase
  - Local Control
  - Sync Mode
  - Channel 10 Priority
  - Pedal Data Thin
  - GM Mode
  - Rx GM ON
  - Soft Thru
  - Device ID
  - Tx PC Switch
  - Rx PC Switch
- MIDI PART (MIDI Channel Settings for a Part) (p. 102)
- GM PART (MIDI Messages Stop Function in GM Mode) (p. 103)
- BULK DUMP (Saving Data to an External MIDI Device) (p. 103)

## About MIDI

**MIDI (Musical Instrument Digital Interface)** is a standard that allows performance data and other information to be exchanged among electronic musical instruments and computers. MIDI With a MIDI cable connecting MIDI devices that are equipped with MIDI connectors, you can play multiple instruments with a single keyboard, have multiple MIDI instruments perform in ensemble, program the settings to change automatically to match the performance as the song progresses, and more.

While using only pads with the TD-6, there is no need to have any detailed knowledge of MIDI. For those who wish to use MIDI keyboards to record patterns on the TD-6, use it as a sound module with external sequencers, or learn the TD-6 at a more advanced level, the following explains such matters related to MIDI.

## MIDI Connectors

The TD-6 has the following two types of MIDI connectors.

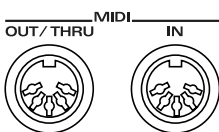

## MIDI IN Connector Function

This receives MIDI messages transmitted from an external MIDI device. When it receives MIDI messages, the TD-6 performs a variety of actions such as playing sounds and switching drum kits and part instruments.

## MIDI OUT/THRU Connector Function

MIDI messages are transmitted from this connector to external MIDI devices. The TD-6 transmits pad and sequencer performance data from the MIDI OUT/THRU connector. You can also transmit various settings content, songs, and other data you want to save to another device (Bulk Dump; p. 103). The TD-6 MIDI OUT and MIDI THRU connectors are combined into a single connector. The function is selected in the “Soft Thru” setting (SETUP/MIDI COMMON/SOFT Thru; p. 101). When “Soft Thru” is set to “ON,” pad and sequencer performance data are transmitted to an external device as is along with messages received at the MIDI IN connector.

### MEMO

As shipped from the factory, this is set to MIDI OUT.

## MIDI Channels and Multi-timbral Sound Modules

MIDI can send numerous streams of performance data over a single MIDI cable. This is made possible by MIDI channels. MIDI channels allow messages intended for a given instrument to be distinguished from messages intended for another instrument. In some ways, MIDI channels are similar to television channels. By changing channels on a television you can view programs from many different broadcast stations. This is because the television set has thus been directed to selectively display only the information being transmitted by a particular station. In the same way, MIDI also allows a device to select the information intended for that device out of the variety of information that is being transmitted to it.

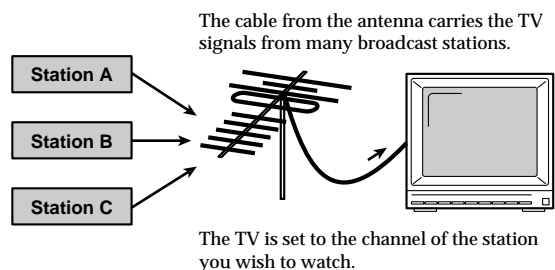

There are sixteen MIDI channels, numbered 1–16. Set the receiving device so that it will receive only the channel that it needs to receive.

### Example:

Set the TD-6 to send Channel 1 and Channel 2, then set sound module A to receive only Channel 1 and sound module B only Channel 2. In this way, sound module A plays the guitar part and sound module B plays the bass part.



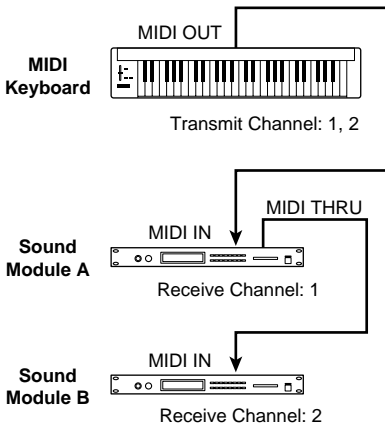

When used as a sound module, the TD-6 can receive on up to six of the sixteen MIDI channels (16 channels in GM mode). Sound modules like the TD-6 which can receive multiple MIDI channels simultaneously to play different sounds on each channel are called “multi-timbral sound modules.”

### How the Internal Sequencer Operates

A sequencer is an electronic instrument used for recording and playback of performances. The TD-6 features such a sequencer function. The TD-6 comes with 150 different built-in performance songs (Preset songs) which can be used for drum practice and other purposes. You can also create your own songs.

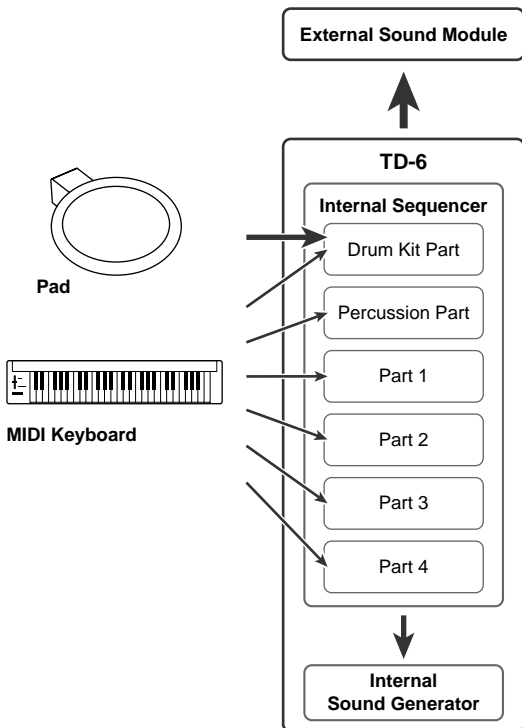

For playback, the performance data that has been recorded to the sequencer is sent to the sound module, which produces the sound. The data for each of the sequencer’s parts causes the corresponding part in the internal sound module to be played. When performance data is recorded, the performance data from pads and MIDI keyboards is sent to the sequencer; the data recorded here is then sent to the sound module for playback.

When recording drum kit and percussion set performance, the performance data is sent to the drum kit part and percussion part according to the setting of channel 10 priority (SETUP/MIDI COMMON/CH10Priority; p. 99).

### NOTE

When using the TD-6 as a GM sound module, the internal sequencer is disabled.

## Making the MIDI Settings (MIDI COMMON)

Make the TD-6’s MIDI settings.

1. While holding down [SHIFT], press [EDIT (SETUP)].  
[EDIT] lights.

2. Press [▶] to select “MIDI COMMON.”



3. Press [ENTER].

4. Press [◀] or [▶] to select the parameter you wish to edit.



↑ Parameter to set

5. Press [INC/+] or [DEC/-] to make the setting.



↑ Value

6. When you finish making settings, press [KIT] or [SONG] to end the procedure.

## Automatically Switching Instrument Settings Screens (Note Chase)

**Note Chase** is a function in which a pad is selected either by striking the pad or when MIDI data corresponding to that pad is received.

When set to “OFF,” the pad’s settings screen is prevented from switching, even when MIDI data for a pad is received. Here, the trigger input number appears in brackets ( [ ] ). If you want to set other pads with this setting remaining at “OFF,” you can switch settings screens by holding down [SHIFT] and pressing [ ◀ ] or [ ▶ ] to select the trigger input number.



**Note Chase: OFF, ON**

## When Using as MIDI Controller for External MIDI Device Only (Local Control)

This setting is required when you wish to record your pads and internal sequencer performance on an external MIDI sequencer. The performance data from the pads and internal sequencer, rather than being sent directly to the sound module section (Local Control Off), is first sent to the external sequencer, and then on to the TD-6’s sound module.

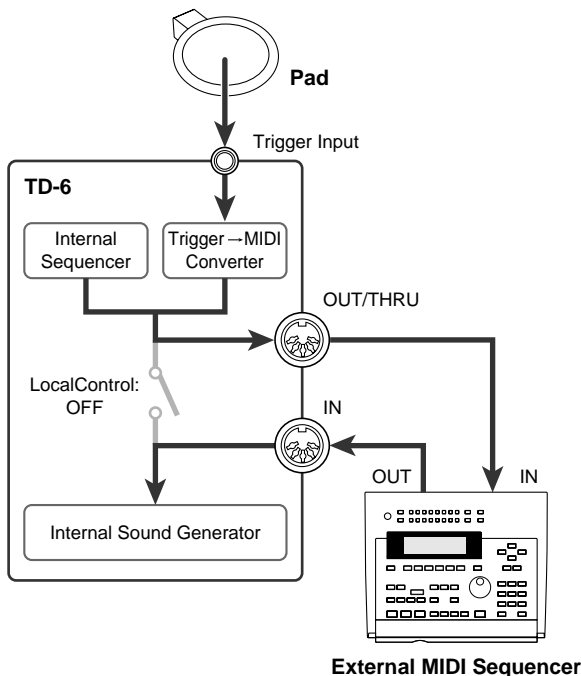

### NOTE

- The settings screen does not appear in GM mode.
- If you make connections and record as shown, with a setting of Local On, duplicate notes will be re-transmitted to the TD-6 and will not be played correctly.



**LocalControl (Local Control): OFF, ON**

#### OFF:

The pads and internal sequencer are disconnected from the TD-6’s internal sound generator. Striking the pads does not cause sound to be produced by the internal sound generator.

#### ON:

The pads and internal sequencer are connected to the TD-6’s internal sound generator. Sounds are produced by the internal sound generator when the pads are struck.

## Synchronizing with an External MIDI Device (Sync Mode)

This section discusses the settings that allow an external MIDI sequencer and the TD-6’s sequencer to be synchronized. The device that is playing back is called the “master” and the device that is synchronizing to the playback is called the “slave.”

### NOTE

The settings screen does not appear in GM mode.



**Sync Mode: INT, EXT, REMOTE**

#### INT (INTERNAL):

The TD-6’s tempo setting is used in playback and recording.

#### EXT (EXTERNAL):

The TD-6’s sequencer operates in accord with external tempo data.

#### REMOTE:

Playback begins, pauses, and stops in accord with data from the external device, but the TD-6’s tempo setting is used for the playback tempo.

## Setting Priority for Playing Drums and Percussion (Channel 10 Priority)

This setting is necessary when both drum kit part and percussion part are simultaneously assigned to Channel 10. When note numbers to which percussion part's instruments are assigned (18 (F#0)–96 (C7)) are assigned to the pads, then select which instrument sounds are to be played when the note number is received.



When recording MIDI keyboard performances (p. 93) or loading external sequencer data to the TD-6 (p. 106), the data is stored to the sounded part according to this setting.

### CH10

Percussion Part	Note No.	Drum Kit Part
Std 1 T2	48 C3	4/TOM1
Med16 Cr	49	9/CRASH1
Std 1 T1	50	4/TOM1 Rim
Pop Rd	51	11/RIDE
China18"	52	10/CRASH2 Rim
Pop Rdb	53	11/RIDE Rim
Tambrn 1	54	
Splsh12"	55	9/CRASH1 Rim
Cowbell1	56	
Quik16Cr	57	10/CRASH2
VibraSlp	58	
Pop Rde	59	
R8Bng Hi	60 C4	
R8Bng Lo	61	
Conga Mt	62	
Conga Sl	63	
Conga Op	64	

#### CH10 Priority

PERC		KIT	
	Note No.		Note No.
Std 1 T2	48 C3	4/TOM1	
Med16 Cr	49	9/CRASH1	
Std 1 T1	50	4/TOM1 Rim	
Pop Rd	51	11/RIDE	
China18"	52	10/CRASH2 Rim	
Pop Rdb	53	11/RIDE Rim	
Tambrn 1	54	Tambrn 1	
Splsh12"	55	9/CRASH1 Rim	
Cowbell1	56	Cowbell1	
Quik16Cr	57	10/CRASH2	
VibraSlp	58	VibraSlp	
Pop Rde	59	Pop Rde	
R8Bng Hi	60 C4	R8Bng H	
R8Bng Lo	61	R8Bng Lo	
Conga Mt	62	Conga Mt	
Conga Sl	63	Conga Sl	
Conga Op	64	Conga Op	



The settings screen does not appear in GM mode.



### CH10Priority (Channel 10 Priority): KIT, PERC

#### KIT (Drum Kit Part):

When overlapping note numbers are received, the drum kit part's instrument (the pad instrument) is sounded.

#### PERC (Percussion Part):

The percussion part's instrument is always played.

## Hi-Hat Control Pedal Data Reduction (Pedal Data Thin)

This function allows you to prevent an excessive amount of data from being transmitted from the pedal to the internal sequencer or via the MIDI OUT.



When you want to make smooth changes in the pitch control with the Hi-Hat control Pedal, set this to "1" or "OFF."



The settings screen does not appear in GM mode.



### Pd1DataThin (Pedal Data Thin): OFF, 1, 2

#### OFF:

Data sent from the pedal is not reduced.

#### 1:

This reduces the data sent from the pedal. Usually, "1" is selected.

#### 2:

This reduces the data sent from the pedal. This setting results in even less data than when "1" is selected.

## Switch to the GM (General MIDI) Mode (GM Mode)

The TD-6 features a GM mode—a convenient way to play back GM score data (music files for General MIDI sound module).



For more on the GM system, refer to p. 13.

To ensure proper playback of GM scores, set the TD-6 to GM mode.

Setting this to “ON” initializes the TD-6’s internal sound generator for use with GM, while the GM System percussion set (Standard Set) is assigned to Part 10, and Piano 1 is assigned to all other parts.

The TD-6 switches to GM mode at the following times.

- When Switching to GM Mode
- When it receives a GM System On message from an external MIDI device
- When the TD-6 has received a GM System On message as the result of playing back a song containing a GM System On message on an external MIDI device



To mute the performance of a specific part in GM mode, you can make the appropriate setting for “GM PART” (SETUP/GM PART/Part Rx Sw; p. 103).



- You cannot use the TD-6 to make changes to the part settings. Change the setting by sending the Control Change Bank Select (CC0#, CC32#) and Program Change (PC) from the external MIDI device.
- When the power is turned on, “GM Mode” is ordinarily set to “OFF.”
- Drum kit parts cannot be played using MIDI messages sent from an external device. They can be played only by playing pads connected to the TD-6.
- Sequencers cannot be used in GM mode. The [SONG], [PLAY ►], [STOP ■], [REC ●], [CLICK], and [PART MUTE] buttons are disabled. Also, [SHIFT] + [CLICK (TEMPO)] cannot be used.
- Some parameters cannot be set in GM mode. For more detailed information, refer to “Parameter List” (p. 130).
- Program changes in GM mode are predetermined, and thus cannot be changed. Use the program changes in the “Preset Percussion Set List” (p. 124) and “Backing Instrument List” (p. 126).
- The pan of the percussion set is based on how the set sounds from where the drums are played. Be aware that the panning recommended with General MIDI is reversed.

### MEMO

While in GM mode, “[GM]” appears in the drum kit screen.



**GM Mode: OFF, ON**

## Preventing the TD-6 from Switching to GM (General MIDI) Mode (Rx GM ON)

This setting prevents the TD-6 from switching to GM mode, even when a “GM System ON message” is received from an external MIDI device.



**RX GM ON: OFF, ON**

### OFF:

Even when a “GM System ON message” is received, the TD-6 does not switch to GM mode. If you wish to switch to GM mode, follow the procedures described on foregoing paragraph to switch manually.

### ON:

When a “GM System ON message” is received, the TD-6 switches to GM mode.

### GM System On Message

This is a message which switches a device to an operating mode that is compatible with the GM system, or to initialize a sound generator so that it will be compatible with the GM system.

When “RX GM ON” is set to “OFF,” the GM System ON message is ignored.

## Mixing MIDI Signals Coming to the MIDI IN with Real Time Performance on the Pads (Soft Thru)

This setting causes data (except for System Exclusive messages) received at MIDI IN to be output from the MIDI OUT/THRU connector along with the pad and sequencer performance data.

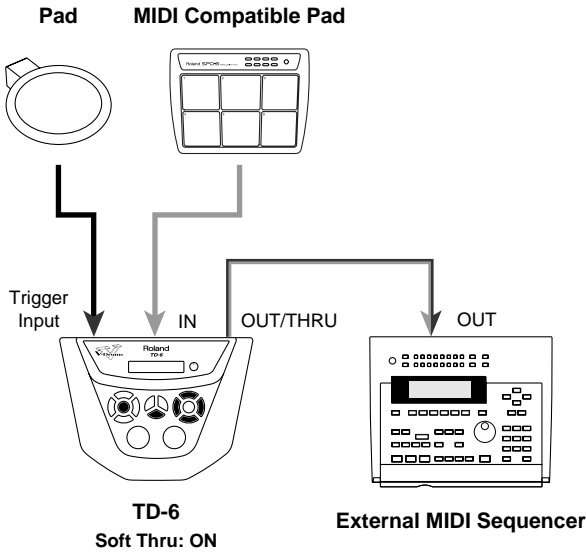

### HINT

If this setting is not used, leave it "OFF" as the trigger response of the pads will be faster.



### Soft Thru: OFF, ON

#### OFF:

Only pad and sequencer performance data is output from the MIDI OUT/THRU connector.

#### ON:

Data received at MIDI IN is output together with the pad and sequencer performance data from the MIDI OUT/THRU connector.

## Set the Device ID (Device ID)

The setting described here is necessary only when you wish to transmit separate data to two or more TD-6 units at the same time. Do not change this setting in any other case.

### MEMO

At the factory settings, the device ID is set to "17."

#### Example:

When saving data using Bulk Dump (p. 103), save using "17" as the TD-6 Device ID. When re-transmitting this data back to the TD-6, it won't receive if the Device ID is set to something other than "17." Even if you happen to have another TD-6 connected, data will not be received if the Device ID is set to something other than "17."

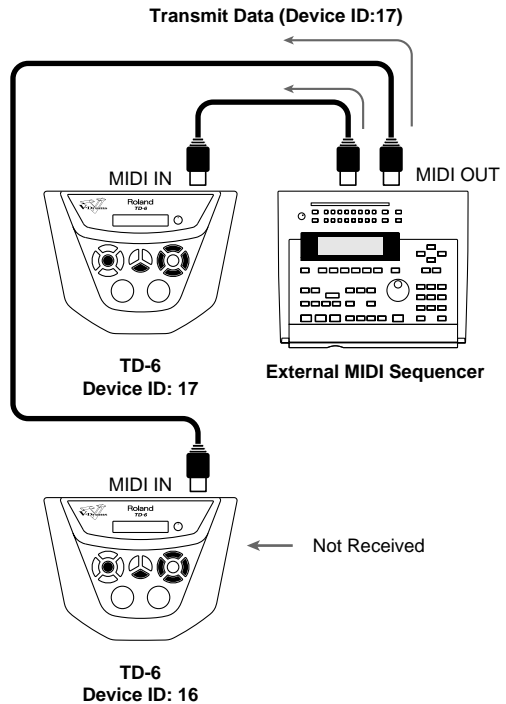

### NOTE

If you lose track of the Device ID setting that was used when saving data via a bulk dump, it will no longer be possible to reload the bulk data that was saved.



### Device ID: 1-32

## Setting the TD-6 So That Program Changes Are Not Transmitted (Tx PC Sw)

The TD-6 sends a Program Change message to external devices when the drums kit is switched. If this is "OFF", Program Changes will not be transmitted.

### MEMO

The TD-6's drum kit program numbers are always the same as the drum kit numbers; this relationship is fixed, and cannot be changed.

### NOTE

The settings screen does not appear in GM mode.



**Tx PC Sw (Tx PC Switch): OFF, ON**

#### OFF:

Program Change messages are not transmitted, even when drums kits are switched.

#### ON:

Program Change messages are transmitted when drum kits are switched.

## Setting the TD-6 So That Program Changes Are Not Received (Rx PC Sw)

The TD-6's drum kits are switched when a Program Change message is received from an external MIDI device. When set to "OFF," the drum kits do not switch, even when a Program Change message is received.

### MEMO

The TD-6's drum kit program numbers are always the same as the drum kit numbers; this relationship is fixed, and cannot be changed.

### NOTE

The settings screen does not appear in GM mode.

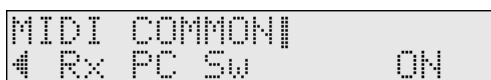

**Rx PC Sw (Rx PC Switch): OFF, ON**

#### OFF:

The drum kits are not switched, even when Program Change

messages are received from an external MIDI device.

#### ON:

The drum kits are switched when Program Change messages are received from an external MIDI device.

## MIDI Channel Settings for a Part (MIDI PART)

For each part, you can specify the channel on which the TD-6 will receive and transmit MIDI messages.

At a setting of "1" through "16," MIDI messages will be transmitted and received on that channel. When set to "OFF," MIDI messages for that part are not transmitted.

### HINT

Drum kit parts and percussion parts can be overlaid and set to "CH 10." Make the "CH10Priority (Channel 10 Priority)" setting to determine whether the drum kit part instrument or percussion part instrument is to be sounded when MIDI messages are received (SETUP/MIDI COMMON/CH10Priority; p. 99).

### NOTE

In GM mode (p. 100), the part's channel is predetermined, and thus cannot be changed.

1. While holding down [SHIFT], press [EDIT (SETUP)].  
[EDIT] lights.
2. Press [▶] to select "MIDI PART."

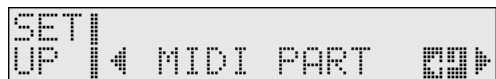

### NOTE

When "GM Mode" is set to "ON," "GM PART" is displayed, and you cannot make the setting. Make the setting after first setting "GM Mode" to "OFF" (SETUP/MIDI COMMON/GM Mode; p. 100).

3. Press [ENTER □].
4. Press [◀] or [▶] to select the part to be set.



↑ Select Part

5. Press [INC/+] or [DEC/-] to make the setting.
6. When you finish making settings, press [KIT] or [SONG] to end the procedure.

```
MIDI PART1 (4▶SelPrt)
  KitPart CH  10 ▶
```

↑ Value

**Part CH (Part Tx Rx Channel): CH 1-CH16, OFF**

## MIDI Messages Stop Function for Specific Parts in GM (General MIDI) Mode (GM PART)

In GM mode, you can make the setting that determines whether or not MIDI messages are to be received for each individual part.

When set to “OFF,” that part’s MIDI messages are not received.

1. While holding down [SHIFT], press [EDIT (SETUP)].  
[EDIT] lights.

2. Press [▶] to select “GM PART.”

```
SETUP | 4 GM PART  [ENTER]
```

### NOTE

When “GM Mode” is set to “OFF,” “MIDI PART” is displayed, and you cannot make the setting.

Make the setting after first setting “GM Mode” to “ON” (SETUP/MIDI COMMON/GM Mode; p. 100).

3. Press [ENTER].
4. Press [◀] or [▶] to select the part to be set.

```
GM PART1 (4▶SelPrt)
  Part1 Rx Sw  ON ▶
```

↑ Select Part

5. Press [INC/+] or [DEC/-] to make the setting.

```
GM PART1 (4▶SelPrt)
  Part1 Rx Sw  ON ▶
```

↑ Value

6. When you finish making settings, press [KIT] to end the procedure.

**Part Rx Sw (Part Rx Switch): OFF, ON**

## Saving Data to an External MIDI Device (BULK DUMP)

You can save the TD-6’s drum kits, songs, general settings, and more to an external MIDI sequencer.

use the external sequencer as you would when recording musical data, and perform the following steps on the TD-6 as shown in the following diagram.

### NOTE

Bulk Dump is one kind of System Exclusive message. Be sure to use an external MIDI sequencer that is capable of recording System Exclusive messages. In addition, confirm that the sequencer is not set to “Do not receive System Exclusive messages.”

### HINT

Setting the Device ID (SETUP/MIDI COMMON/DeviceID; p. 101) makes operation more convenient when multiple TD-6’s are connected.



For more detailed information concerning external MIDI devices, be sure to read the owner’s manuals for the devices you are using.

1. Use a MIDI cable to connect the TD-6’s MIDI OUT connector to the MIDI IN connector of the external sequencer.

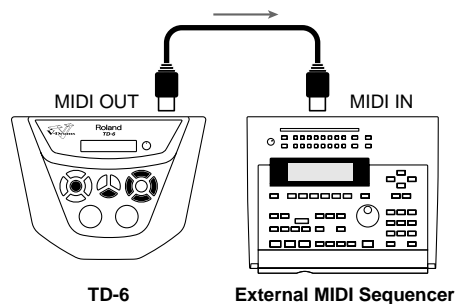

2. While holding down [SHIFT], press [EDIT (SETUP)].  
[EDIT] lights.

3. Press [▶] to select “BULK DUMP.”

```
SETUP | 4 BULK DUMP  [ENTER]
```

4. Press [ENTER].

- Press [INC/+] or [DEC/-] to select the content to be saved.



Content being saved ↗

- Start the recording process of the external sequencer.
- Press [ENTER ].  
Press [EXIT] to cancel the operation.



- Press [ENTER ] to start the data transmission.



- When you have finished transmitting, the Completed screen appears.

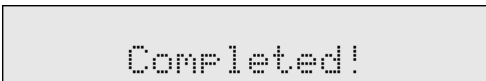

- Stop recording on the external sequencer.

**Bulk Dump:**

**ALL, SETUP, ALL SONGS, ALL KITS,  
KIT 01-KIT 99**

**ALL:**

All data, including the setup (trigger, pad, and other such settings), drum kits, and User songs are transmitted.

**SETUP:**

All setup data is transmitted.

**ALL SONGS:**

All data for User Songs 151-250 is transmitted.

**ALL KITS:**

All data for Drum Kits 1-99 is transmitted.

**KIT 01-KIT 99:**

Only the data for the selected drum kit is transmitted.

## Returning Saved Data to the TD-6

This returns settings that have been saved to a sequencer or other external MIDI device back to the TD-6.

**NOTE**

At this time, the TD-6's data is overwritten. Save any data you need to an external MIDI device before carrying out this operation.

**MEMO**

Set the Device ID (SETUP/MIDI COMMON/DeviceID; p. 101) used when the bulk data was saved.

- Use a MIDI cable to connect the TD-6's MIDI IN connector to the MIDI OUT connector of the external sequencer.

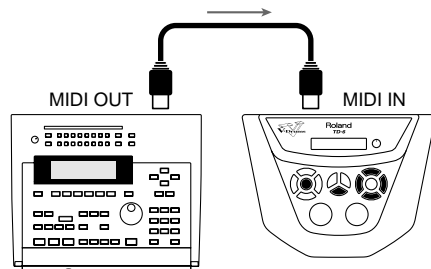

External MIDI Sequencer

TD-6

- Send the settings data from the external sequencer to the TD-6.

The transmitted settings are reproduced.



# Chapter 8 Features Using MIDI and Setting Examples

## About Transmitting/Receiving Program Changes

### Drum Kit

The drum kit program numbers are always the same as the drum kit numbers; this relationship is fixed, and cannot be changed.

### Percussion Set

Percussion set program numbers are predetermined. Refer to the "Preset Percussion Set List" (p. 124).

### Backing Part (Part 1-4) Instruments

The instrument program numbers, and controller numbers 0 and 32 are fixed. Refer to the "Backing Instrument List" (p. 126).



If tone changes are made on an external MIDI device, the TD-6's instruments are switched, but the change is not recorded by the sequencer.

## Triggering an External Sound Device by Playing the TD-6

This sets the TD-6 so that the external MIDI sound module is sounded when the pads are struck.



With this setting, both the TD-6 and the external sound module can play simultaneously.

1. Use a MIDI cable to connect the MIDI OUT connector of the TD-6 to the MIDI IN connector of the external MIDI device.

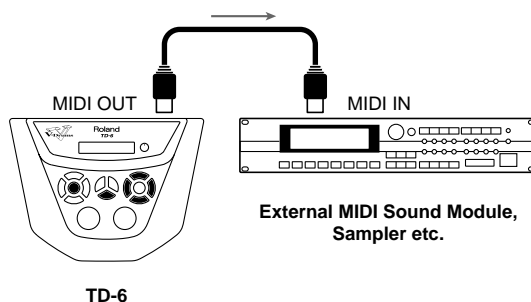

2. Match the MIDI channel to be used for transmitting data from the TD-6 and the MIDI channel that the external MIDI device will use for receiving the data. (SETUP/MIDI PART/CH; p. 102)
3. Specify the note number to be transmitted from each pad. (KIT/CONTROL/Note No.; p. 66)  
Set this to the note number of the sound that you wish to play on the external MIDI sound module or sampler.
4. Set the MIDI Gate Time. (KIT/CONTROL/Gate Time; p. 67)



You can use different pad note number and gate time settings in each drum kit.

## Combining with an External MIDI Sequencer

### Importing Sequence Data from an External MIDI Device to the TD-6's Internal Sequencer

You can load data created on another sequencer from the MIDI IN connector and record the data on the TD-6's sequencer, then use the data as a song. The backing part (Parts 1-4), percussion part, and drum kit part can be imported simultaneously.

#### NOTE

When TD-6's instruments are changed from an external MIDI device, the change is not recorded by the TD-6's sequencer. Use the TD-6 to make each part's instrument settings.



For more on external MIDI device operations, refer to the owner's manuals for the devices you are using.

1. Use a MIDI cable to connect the MIDI IN connector of the TD-6 to the MIDI OUT connector of the external MIDI device.

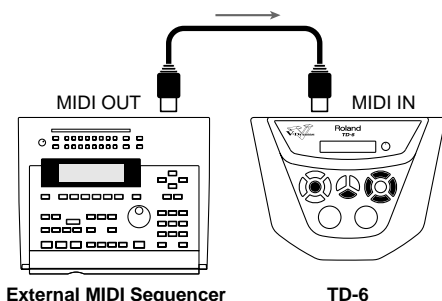

2. Match the MIDI channel to be used for transmitting data from the external MIDI device and the MIDI channel that the TD-6 will use for receiving the data. (SETUP/MIDI PART/CH; p. 102)
3. Set "CH10Priority (Channel 10 Priority)" as needed when recording drum and percussion performances. (SETUP/MIDI COMMON/CH10Priority; p. 99)
4. Set "Sync Mode" to "EXT" in order to synchronize the TD-6 to the external sequencer. (SETUP/MIDI COMMON/Sync Mode)

5. Select one of the TD-6's new User songs (p. 84). You can select a new User song by holding down [SHIFT] and pressing [STOP ■] while in the Song screen.

#### HINT

New User songs are indicated by "※" in the display.

6. Make the settings for the TD-6's parts. (SONG/PART; p. 88)  
Specify the part instruments and percussion sets, volume levels, etc.
7. Press [REC ●], then make the recording settings (p. 94).  
**Time Sig:** Set the beat (time signature) to comply with that of the loaded data.  
**Rec Mode:** Set this to "REPLACE."
8. Start playback of the external MIDI device.  
The TD-6 automatically begins recording.
9. When you have finished recording, stop the recording of the external MIDI device.  
The TD-6 stops recording automatically.

### Recording Your Performance to an External Sequencer

This makes the settings that allow performances of the pads to be recorded by an external MIDI sequencer.

1. Use a MIDI cable to connect the TD-6 and MIDI sequencer MIDI connectors as shown in the following figure.

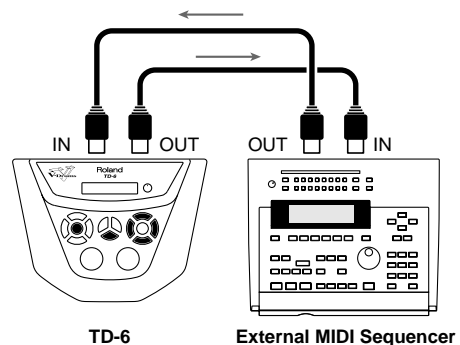

2. Set Local Control to "OFF." (SETUP/MIDI COMMON/LocalControl; p. 98)
3. Match the MIDI channel to be used for transmitting data from the TD-6 and the MIDI channel that the external MIDI sequencer is to use for receiving the data. (SETUP/MIDI PART/CH; p. 102)

4. Start the recording process of the external MIDI sequencer.
5. The performances of the pads are recorded as they are played.
6. When you have finished playing, stop recording with the external MIDI sequencer.
7. When playback of the external MIDI sequencer begins, the TD-6 is played.

## Using the TD-6 As a Sound Module

Here, the TD-6 is used as a sound module. You can connect an external MIDI sequencer and play back songs or connect a MIDI-compatible keyboard or pads for performance.

1. Use a MIDI cable to connect the MIDI IN connector of the TD-6 to the MIDI OUT connector of the external MIDI device.

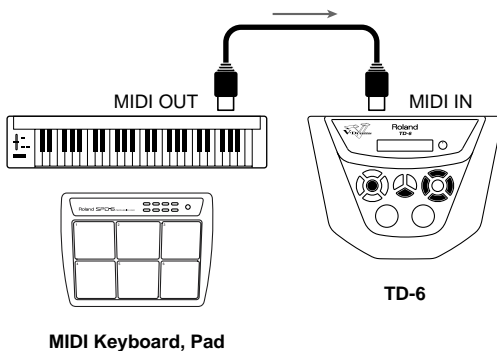

2. Match the MIDI channel to be used for transmitting data from the external MIDI device and the MIDI channel that the TD-6 will use for receiving the data. (SETUP/MIDI PART/CH; p. 102)
3. Set “CH10Priority (Channel 10 Priority)” as needed when playing drum and percussion performances with an external MIDI sequencer. (SETUP/MIDI COMMON/CH10Priority; p. 99)
4. Select one of the TD-6’s new User songs (p. 84).  
You can select a song that has not yet been used by holding down [SHIFT] and pressing [STOP ■].

### HINT

New User songs are indicated by “※” in the display.

5. Make the settings for the TD-6’s parts. (SONG/PART; p. 88)

Specify the part instruments and percussion sets, volume levels, etc.

### HINT

When using the TD-6 as a sound module, the sounds you select must be assigned to a SONG as the song parameters store which sounds you are using. Once you select a new User song and make the settings, you can then call up these settings just by selecting this song. You can also prevent recording or changes to the settings by setting “Song Lock” to “ON” (SONG/COMMON/Song Lock; p. 87).

6. When playing the external MIDI device, the TD-6 will sound.





*PERCUSSION SOUND MODULE* **TD-6**

# *Appendices*

# Troubleshooting

This section outlines points to check if you experience problems, and what to do about them.

## No Sound

### No Sound

#### Has the [VOLUME] been lowered?

→ Rotate the [VOLUME] knob to be sure.

#### Is Local control set to "OFF?" (SETUP/MIDI COMMON/LocalControl; p. 98)

→ Local Control should be set to "ON" if an external sequencer is not being used.

### No Drum Kit Sound

#### Is the overall drum kit volume level turned down? (KIT/COMMON/MasterVolume; p. 68)

→ Press [INC/+] or [DEC/-] to set the volume.

### No Sound from One or More Pads

#### Is the volume level of an instrument lowered? (KIT/INST/Level; p. 61)

→ Strike the pad that is not producing sound to switch to the pad's settings screen. Press [INC/+] or [DEC/-] to set the volume.

#### Is the pad connected correctly? (p. 20, p. 34)

- Make sure that the pad connections are correct, and that each pad is connected to the proper input.
- Use only the provided cables to connect the pads.

#### Is the instrument set to #1024 (OFF)? (KIT/INST; p. 60)

→ #1024 (OFF) is a setting used to prevent any sounds from being played. Select an instrument numbered 1–1,023.

### Cannot Make Rim Shots/ Rim Shots Not Sounding

#### Do you have a pad that is capable of producing rim shots connected to a trigger input that is capable of handling rim shots? (p. 34)

- When using the PD-80R or PD-120 to play rim shots, connect to Trigger Input 2 (SNARE).
- When using the PD-7, PD-9, CY-6, CY-12H, CY-14C, or CY-15R to play rim shots (or edge/bell shots) or choking, connect to Trigger Input 2 (SNARE), 3 (HI-HAT), 4 (TOM1), 9 (CRASH1), 10 (CRASH2), or 11 (RIDE).
- The PD-5, PD-6, PD-80, and PD-100 are not capable of producing rim shots.

#### Is the Rim Sensitivity set to "0?" (SETUP/TRIG ADVNC D/Rim Sens; p. 76)

→ Press [INC/+] or [DEC/-] to make the setting.

#### MEMO

You need to set the "Rim Sens" when using the PD-80R or PD-120 to play rim shots.

## Cannot Make Cross Sticks/ Cross Sticks Not Sounding

Do you have a pad connected to a trigger input that is capable of handling cross sticks?  
(p. 34)

→ When using the PD-80R or PD-120 to play cross sticks, connect to Trigger Input 2 (SNARE).

Has the instrument that can be used for playing the cross sticks been selected?  
(KIT/INST; p. 60, Drum Instrument List; p. 120)

→ Use the instrument with the “XS.”

Are you playing the cross stick correctly?  
(p. 37)

→ For cross stick, make sure your hand or stick does not touch or strike the head.

## No Sound When the Pad is Struck Softly

Did you strike a pad or press the pedal at any time from when the TD-6’s power was turned on until the kit name appeared in the display?

→ Using the procedure of p. 24, turn the power on once again without playing any pads or pedals during the TD-6’s warm up.

### NOTE

#### Precautions When Turning On the Power

When the TD-6 is turned on, it carries out a check of the pads. If you strike a pad or press the pedal anytime during this process, the pads cannot be checked properly, resulting in incorrect functioning of the pads.

## No Sound When [SHIFT] + [KIT] (Preview) Is Pressed

Is the [PREVIEW] button velocity set to “0?”  
(SETUP/UTILITY/Preview Velo; p. 79)

→ Press [INC/+] or [DEC/-] to make the setting.

## No Click/Metronome Sound

Does [CLICK] light? (p. 80)

→ Press [CLICK] to light the button.

Is the click volume level set to “0?”  
(CLICK/Click Level; p. 80)

→ Press [INC/+] or [DEC/-] to make the setting.

## Song Does Not Play

Is GM Mode set to “ON?”  
(SETUP/MIDI COMMON/GM Mode; p. 100)

→ Press [INC/+] or [DEC/-] to set this to “OFF.” The sequencer does not function when the TD-6 is in GM mode.

Are you playing a new User song?

→ Play back a song that contains performance data.

### MEMO

New User songs are indicated by “\* ” in the display.

Is the volume level of the backing part and percussion part set to “0?”  
(SETUP/UTILITY/PercPartLevel, BackingLevel; p. 77, p. 78)

→ Press [INC/+] or [DEC/-] to make the setting.

### HINT

Press [SHIFT] + [SONG] to jump to the backing part volume settings screen.

## Specific Part in Song Not Being Played

Does [PART MUTE] light? (p. 85)

→ Press [PART MUTE] so that the light is turned off.

Is the volume level for each part set to "0?"  
(SONG/PART/Level; p. 89)

→ Press [INC/+] or [DEC/-] to make the setting.

## TD-6 Not Playing Even During Performance of External Sequencer or Keyboard

Is the part's MIDI channel correct? Or is the channel set to "OFF?" (SETUP/MIDI PART/Part CH; p. 102)

→ Press [INC/+] or [DEC/-] to make the setting.

Is the volume level for each part set to "0?"  
(SONG/PART/Level; p. 89)

→ Press [INC/+] or [DEC/-] to make the setting.

## External Sequencer Not Playing Even During Performance of TD-6 and Pads

Is the part's MIDI channel correct? Or is the channel set to "OFF?"  
(SETUP/MIDI PART/Part CH; p. 102)

→ Press [INC/+] or [DEC/-] to make the setting.

## In GM mode, No Sound of a Specific Part in a Performance

Is it set not to receive MIDI messages?  
(SETUP/GM PART/Part Rx Sw; p. 103)

→ Press [INC/+] or [DEC/-] to make the setting.

## No Sound/Low volume from Device Connected to the MIX IN Jack

---

Could you be using a connection cable that contains a resistor?

→ Use a connection cable that does not contain a resistor.

Is the volume level of the connected device turned down completely?

→ Refer to the owner's manual for the device, then set the volume.

## Drum Kit Does Not Sound As Intended

---

### Pressing [SHIFT] + [KIT] (Preview) Starts Playback of the Song

Is the Pad Pattern function (a feature that starts performance of songs when a pad is struck) specified for the selected pad?  
(KIT/CONTROL/Pad Ptn; p. 65)

→ Press [DEC/-] to set this to "OFF."



To stop playback of a song in progress, press [STOP ■].



## No Ambience Applied

**Is the drum kit's Ambience set to "OFF?"**  
(KIT/AMBIENCE/Amb Sw; p. 62)

→ Press [INC/+] or [DEC/-] to make the setting.

**Is the drum kit's overall Ambience level set to "0?"** (KIT/AMBIENCE/Amb Level; p. 63)

→ Press [INC/+] or [DEC/-] to make the setting.

**Has the Ambience level for individual instruments been lowered?**

(KIT/AMBIENCE/AmbSendLevel; p. 62)

→ Strike the pad to which Ambience is not being applied to display the settings screen for that pad. Press [INC/+] or [DEC/-] to make the setting.

## No Equalizer Applied

**Is the drum kit's Equalizer set to "OFF?"**  
(KIT/EQUALIZER/Master EQ Sw; p. 64)

→ Press [INC/+] to set this to "ON."

**Is the Gain set to "0?"**

(KIT/EQUALIZER/High Gain, Low Gain; p. 64)

→ Press [INC/+] or [DEC/-] to make the setting.

## Pad Does Not Sound As Intended

### Pad Not Playing Correctly

**Is the trigger type setting correct?**  
(SETUP/TRIG BASIC/Trig Type; p. 71)

→ Press [INC/+] or [DEC/-] to make the setting.

**Is the pad's sensitivity setting correct?**  
(SETUP/TRIG BASIC/Sensitivity; p. 73)

→ Press [INC/+] or [DEC/-] to make the setting.

#### MEMO

For fullest expression in performance, we recommend the exclusive use of Roland pads.

**Is the KD-80, KD-120, PD-80, PD-80R, PD-100 or PD-120 head tightened uniformly?**

→ Refer to the owner's manual for the pad you are using, then adjust the head tension.

#### HINT

If pad volume or other quality is unstable, making the head tension somewhat tighter improve stability.

## Wrong Sound Plays

**Is there a mistake in the head and rim selection? (p. 57)**

→ With some parameters, you can make separate settings for the head and rim. At this time, confirm the trigger type appearing in the upper right of the screen, then make the settings.

**Are you making the rim shot (p. 37) and cross stick (p. 37) correctly?**

→ To play rim shots, strike the head and rim simultaneously. For cross stick, make sure your hand or stick does not touch or strike the head.

## Song Does Not Sound As Intended

---

### Song Sounds Odd

Have the part settings been changed?  
(SONG/PART; p. 88)

→ Press [INC/+] or [DEC/-] to make the settings.

### Playback Stops Immediately After Beginning

Is the song playback type set to "TAP?"  
(SONG/COMMON/Play Type; p. 86)

→ Press [DEC/-] to set this to "LOOP" or "1SHOT."  
"TAP" refers to the convenient playback function in Pad Pattern (tapping the pad causes the song to be played back).

### The Song Stops Suddenly When Playing the Pads

Are you using the Pad Pattern function?  
(KIT/CONTROL/Pad Ptn; p. 65)

→ If so, look at your settings. Or see p. 65.  
When triggering/playing a song that is set to "LOOP" or "ONE SHOT" mode, if you trigger another song (from a pad), also in "LOOP" or "ONE SHOT" mode then the last song played will have priority. Don't forget that some "songs" are very short, a few notes, or even one chord. So "sudden" stops can be caused by accidentally triggering one of these short songs. Always check your Pad Pattern settings.

## Sound is distorted

---

### Sound in Headphones Distorted

Sometimes, setting the headphone output too high using certain tones can make it appear that the sound is somewhat distorted.

→ Turn down [VOLUME] completely. This alleviates the distortion.

### Output Sound Is Distorted

Sounds may become distorted somewhat because of certain instrument and equalizer settings.

→ Lower the pad's instrument volume.  
(KIT/INST/Level; p. 61)  
→ Setting the Pan (positioning) at or near the center may suppress the distortion. (KIT/INST/Pan; p. 61)

## Problems Operating the TD-6

### Striking Pads Does Not Switch the Settings Screen

Is the pad's settings screen locked?  
(SETUP/MIDI COMMON/Note Chase; p. 59, p. 98)

→ Press [INC/+] to set this to "ON."



You can press [SHIFT] + [◀] or [▶] to switch to other pads' settings screens.

### Song Screen Not Displayed

Is GM Mode set to "ON?"  
(SETUP/MIDI COMMON/GM Mode; p. 100)

→ Press [DEC/-] to set this to "OFF." The sequencer does not function when the TD-6 is in GM mode.

### Cannot Record or Edit User Song

Is Song Lock set to "ON?"  
(SONG/COMMON/Song Lock; p. 87)

→ Press [DEC/-] to set this to "OFF."

## Cannot Carry Out Bulk Dump

Is the MIDI connector used to connect the MIDI cable correct? (p. 96)

→ If you wish to save a bulk dump on an external device, connect the TD-6's MIDI OUT/THRU connector to the external sequencer's MIDI IN connector.

Could the external MIDI device be set in such a way as to cause it to decline the reception of MIDI Exclusive messages?

→ Refer to the owner's manual for the external MIDI device, then set it so that the reception of System Exclusive data is enabled.



System exclusive data is data unique to individual devices, so verify all settings.

## Display Is Too Light Or Too Dark

Is the display contrast properly adjusted?  
(SETUP/UTILITY/LCD Contrast; p. 77)

→ Press [INC/+] or [DEC/-] to make the setting.



The visibility of the display will change depending on the viewing angle and on room lighting conditions. The visibility of the display will change depending on the viewing angle and on room lighting conditions.

# Messages and Error Messages

This section explains the meaning of the various error messages and other messages that the TD-6 may display, and describes the measures to take when these appear.

When [EXIT] appears as shown in the following figure, you can press [EXIT] to dismiss the message.

A rectangular display box showing the text "System Error!" on the top line and "[EXIT]" on the bottom line.

## System and Battery Error Messages

### System Error!

A rectangular display box showing the text "System Error!" on the top line and "[EXIT]" on the bottom line.

A problem has occurred with the internal system. Consult your Roland dealer or nearest Roland Service Center.

### Backup NG! Execute Reset All!

A rectangular display box showing the text "Backup NG! Execute" on the top line, "Reset All!" on the second line, and "[ENTER]" on the bottom line.

Data in the TD-6's memory may be corrupted.

The TD-6's internal backup battery (the battery used for saving User memory data) is fully drained; internal data has been lost.

Consult your dealer or a nearby Roland service station to have the battery replaced.

You can use the TD-6 temporarily by following the instructions appearing in the display.

#### 1. Press [ENTER] .

A rectangular display box showing the text "Execute Reset All!" on the top line and "[ENTER]" on the bottom line.

#### 2. Press [ENTER] once again.

Factory Reset is executed, enabling you to use the TD-6 temporarily.



Carrying out a Factory Reset deletes all of the current TD-6's data and settings, and returns them to the original factory settings.

### Backup Battery Low!

A rectangular display box showing the text "Backup Battery Low!" on the top line and "[EXIT]" on the bottom line.

The internal backup battery of the TD-6 (a battery that maintains data in the user memory) has run down.

Contact your dealer or a nearby Roland service center to have the battery replaced.

## Messages and Error Messages Related to Sequencers and Songs

### DATA OVERLOAD!

A rectangular display box showing the text "Data Overload!" on the top line and "[EXIT]" on the bottom line.

Song contained an excessive amount of data, and as a result could not be output successfully from MIDI OUT.

Try eliminating a track that has too much data.

### 999 Measure Maximum!

A rectangular display box showing the text "999 Measure Maximum!" on the top line and "[EXIT]" on the bottom line.

The maximum number of measures for one song has been exceeded, and as a result no more can be recorded to the song.

### Not Enough Memory!

A rectangular display box showing the text "Not Enough Memory!" on the top line and "[EXIT]" on the bottom line.

Song recording or editing could not be carried out because there was not enough internal memory.

Try deleting songs that are no longer needed (SONG/DELETE; p. 91).

### Changes Not Saved! Preset Song!

A rectangular display box showing the text "Changes Not Saved!" on the top line, "Preset Song!" on the second line, and "[EXIT]" on the bottom line.

This is a Preset song; changes to settings are not saved.

**Song Lock ON!**

```
Song Lock On!
```

Song Lock is on for this song; it cannot be edited or recorded. Set Song Lock to "OFF" (SONG/COMMON/Song Lock; p. 87).

**Empty Song!**

```
Empty Song!
```

This song contains no performance data; it cannot be edited.

**No Empty Song!**

```
No Empty Song!
```

There are no empty songs for recording. Try deleting songs that are no longer needed (SONG/DELETE; p. 91).

**New User Song Selected!**

```
New User Song  
Selected!
```

Select a new User song automatically.

**HINT**

This is displayed when the following operations are carried out.

- When pressing [SHIFT] + [STOP ■] in the song screen or the screen for selecting the copy destination in song copy
- When [REC ●] is pressed with a Preset song selected

**Preset Song!**

```
Preset Song!
```

This is the preset song; the settings cannot be changed.

**Messages and Error Messages Related to MIDI****MIDI Offline!**

```
MIDI Offline!
```

Something has caused a break in communication with the external MIDI device. Check that MIDI cables have not been disconnected or broken.

**Checksum Error!**

```
Checksum Error!  
[EXIT]
```

The checksum value of a system exclusive message was incorrect. Correct the checksum value.

**MIDI Buffer Full!**

```
MIDI Buffer Full!  
[EXIT]
```

A large amount of MIDI messages were received, and could not be processed completely. Confirm that the external MIDI device is properly connected (p. 105). If this does not resolve the problem, reduce the amount of MIDI messages being transmitted to the TD-6.

**Data Transmitting... Please, Wait.**

```
Data Transmitting...  
Please, Wait.
```

Bulk data is being transmitted in response to an external request for transmission.

**Bulk Data Transmit Aborted!**

```
Bulk Data Transmit  
Aborted!
```

The bulk dump has been cancelled.

**Data Receiving... Please, Wait.**

```
Data Receiving...  
Please, Wait.
```

Bulk data is being received. Do not turn off the power.

# Drum Kit List

No.	Drum Kit Name	Remark
1	AcuStick	
2	Rock It!	
3	Groove	
4	Jazzy	* x-stick
5	Ballad X	* x-stick
6	TR-808	
7	Brushes	
8	Tekno	
9	LatnPerc	* Pad Pattern (SNR_H, CR1_R)
10	Orch Set	
11	HipHop	
12	JazzFunk	
13	Syn&Bass	* Pad Pattern (KIK, CR1_H/R, CR2_H, RD_H)
14	lManBand	* Pad Pattern (KIK, CR1_R, CR2_R)
15	DryTight	
16	Guitars	* Pad Pattern (HH_H)
17	Mexi-Mix	
18	DrumSolo	* Pad Pattern (KIK, T1_H, T2, T3, T4)
19	Voices	
20	Natural	
21	Crack!	
22	Fusion	
23	Buzz	
24	TKO	
25	PowrFusn	
26	Pocket	
27	Studiol	
28	Dry	
29	Ringer	
30	RockBand	* Pad Pattern (T4, AUX)

No.	Drum Kit Name	Remark
31	HevyRock	
32	DenkiRok	
33	"A" Team	
34	Rocker X	* x-stick
35	HardRock	
36	HevyMetl	
37	RokCncrt	
38	JazzOne	
39	B-Bop X	* x-stick
40	BIG Band	* Pad Pattern (KIK, CR1_R, AUX)
41	Sizzle	
42	BrushAmb	
43	BrshSwel	
44	Electro	
45	TR-909	
46	808Mix	
47	909Mix	
48	808...9!	
49	Dance808	
50	Snowki	* Pad Pattern (CR1_R)
51	LazyPlat	
52	Jungle	
53	ElecBoom	
54	ElecMix	
55	Slip	
56	Drum'nBs	* Pad Pattern (CR2_H/R)
57	HomeBoy	
58	Far Away	
59	"Scat"	
60	Dome	

No.	Drum Kit Name	Remark	No.	Drum Kit Name	Remark
61	Club		81	SteelSnr	
62	JzTheatr	* x-stick	82	BrassSnr	
63	TileRoom		83	BelBrSnr	
64	Garage		84	JunkYard	
65	GigaHall		85	BrikHous	
66	Cave		86	OpenLoFi	
67	Timbongo		87	Lazy	
68	LowFi		88	Cartoon	
69	Scary		89	Studio2	
70	Fibre		90	Studio3	
71	Birch		91	PopKit X	* x-stick
72	RoseWood		92	Standrd1	
73	Oyster		93	Standrd2	
74	Melody		94	Room	
75	Kids		95	Power	
76	Gospel		96	Jazz	
77	PedalEFX		97	Tabla	* Pad Pattern (CR1_R, RD_H)
78	Gate		98	LatnSqnc	* Pad Pattern (CR1_R, CR2_R)
79	Science!		99	User Kit	
80	CopprSnr				

**No.:** Drum Kit Number (Program Number)

\* x-stick:

A velocity switching “snare rim” sound, that when played softly produces a cross stick sound, and when played harder produces a rim shot sound.

When using the PD-80R or PD-120 for snare (trigger input 2), you can play using the cross stick technique.

\*Pad Pattern:

The pad pattern function (p. 65) is set for the pads within the parentheses ( ).

(KIK = Kick, SNR = Snare, HH = Hi-Hat, T = Tom, CR = Crash, RD = Ride, H = Head, R = Rim)

No.92 Standard-96 Jazz:

This kit has the instruments in each percussion set assigned to the pads.

No.99 User Kit:

Parameters including volume etc. are set to standard values.

Use this when creating a kit from scratch.



You can restore an edited drum kit to its factory settings. For more information, refer to “Restoring the Factory Settings for the Edited Drum Kit” (p. 70).

# Drum Instrument List

No.	Name	Remark
<b>KICK</b>		
1	DblHeadK	
2	Sharp K	
3	Acous K	
4	Meat K	
5	R8 Low K	
6	R8 Dry K	
7	WdBeatrK	
8	Open K	
9	VintageK	
10	26"DeepK	
11	ThickHdK	
12	Round K	
13	MediumK	
14	BigRoomK	
15	Big K	
16	BigLowK	
17	Studio1K	
18	Studio2K	
19	Studio3K	
20	Studio4K	
21	Studio5K	
22	Studio6K	
23	Studio7K	
24	Studio8K	
25	Buzz 1 K	
26	Buzz 2 K	
27	Buzz 3 K	
28	Buzz 4 K	
29	Buzz 5 K	
30	Room 1 K	
31	Room 2 K	
32	Room 3 K	
33	Room 4 K	
34	Room 5 K	
35	Room 6 K	
36	Room 7 K	
37	Amb 1 K	
38	Amb 2 K	
39	Amb 3 K	
40	Amb 4 K	
41	Solid1 K	
42	Solid2 K	
43	Solid3 K	
44	Jazz 1 K	
45	Jazz 2 K	
46	18"JazzK	
47	BrshHitK	
48	Wood 1 K	
49	Wood 2 K	
50	Wood 3 K	
51	Wood 4 K	
52	Maple1 K	
53	Maple2 K	
54	Oak K	
55	Birch K	
56	RoseWodK	
57	OnePly K	
58	Oyster K	
59	Dry K	
60	DryMed K	
61	DryHardK	
62	DeepDryK	
63	Fusion K	

64	SandBagK
65	BsktBalk
66	Mondo K
67	MdVrb1 K
68	MdVrb2 K
69	Sizzle K
70	Box K
71	Ninja K
72	Dance K
73	House K
74	Pillow K
75	Rap K
76	TR808 K
77	808HardK
78	808BoomK
79	808NoizK
80	TR909 K
81	909WoodK
82	909HdAtK
83	ElephntK
84	Cattle K
85	Door K
86	Punch K
87	MachineK
88	Broken K
89	BendUp K
90	HrdNoizK
91	R8SolidK
92	ThinHedK
93	Tight K
94	Chunk K
95	Gate K
96	Giant K
97	Inside K
98	Std1 1 K
99	Std1 2 K
100	Std2 1 K
101	Std2 2 K
102	Room 8 K
103	Room 9 K
104	Power K1
105	Power K2
106	Jazz 3 K
107	Jazz 4 K
108	Brush K
109	Elec 1 K
110	Elec 2 K
111	ElBend K
112	Plastk1K
113	Plastk2K
114	Gabba K
115	Gabba2 K
116	Tail K
117	Jungle K
118	HipHop K
119	LoFi 1 K
120	LoFi 2 K
121	LoFi 3 K
122	LoFi 4 K
123	Noisy K
124	Splat K
125	Scrach1K
126	Scrach2K
127	Hi-Q K
128	Space K
129	SynBassK

## SNARE

130	Custom S
131	Cstm RS
132	CstmBr S
133	CstmBrRS
134	CstmSt S
135	CstmStRS
136	PicololS
137	Pcol RS
138	PcolBr S
139	PcolBrRS
140	PcolSt S
141	PcolStRS
142	Picolo2S
143	Pco2 RS
144	Pco2Br S
145	Pco2BrRS
146	Pco2St S
147	Pco2StRS
148	Picolo3S
149	Pco3 RS
150	Pco3Br S
151	Pco3BrRS
152	Pco3St S
153	Pco3StRS
154	Medium1S
155	Med1 RS
156	Med1 XS *x-stick
157	Med1Br S
158	Med1BrRS
159	Med1BrXS *x-stick
160	Med1St S
161	Med1StRS
162	Med1StXS *x-stick
163	Medium2S
164	Med2 RS
165	Med2Br S
166	Med2BrRS
167	Med2St S
168	Med2StRS
169	Medium3S
170	Med3 RS
171	Med3Br S
172	Med3BrRS
173	Med3St S
174	Med3StRS
175	Medium4S
176	Med4 RS
177	Med4Br S
178	Med4BrRS
179	Med4St S
180	Med4StRS
181	Fat1 S
182	Fat1 RS
183	Fat1Br S
184	Fat1BrRS
185	Fat1St S
186	Fat1StRS
187	Fat2 S
188	Fat2 RS
189	Fat2Br S
190	Fat2BrRS
191	Fat2St S
192	Fat2StRS
193	AcousticS
194	Acus RS
195	AcusBr S

196	AcusBrRS
197	AcusSt S
198	AcusStRS
199	VintageS
200	Vntg RS
201	VntgBr S
202	VntgBrRS
203	VntgSt S
204	VntgStRS
205	Comp S
206	Comp RS
207	CompBr S
208	CompBrRS
209	CompSt S
210	CompStRS
211	Jazz S
212	Jazz RS
213	Jazz XS *x-stick
214	JazzBr S
215	JazzBrRS
216	JazzBrXS *x-stick
217	JazzSt S
218	JazzStRS
219	JazzStXS *x-stick
220	Dirty S
221	Drty RS
222	DrtyBr S
223	DrtyBrRS
224	DrtySt S
225	DrtyStRS
226	13" S
227	13" RS
228	Birch S
229	Birch RS
230	TD7Mpl S
231	TD7MplRS
232	Ballad S
233	Brush1 S
234	Brush2 S
235	Brush3 S
236	Brsh Tap
237	Brsh Slp
238	Brsh Swl
239	BrshTmbS
240	MIDIbr1S
241	MIDIbr2S
242	MIDIbr3S
243	Boston S
244	BostonRS
245	Bronze S
246	Brnz RS
247	Bronze2S
248	Brnz2 RS
249	Birch2 S
250	Copper S
251	Copper2S
252	10" S
253	L.A. S
254	London S
255	Ring S
256	Ring RS
257	Rock S
258	Rock RS
259	R8MapleS
260	R8Mpl RS
261	BigShotS
262	Std1 1 S
263	Std1 2 S



264 Std2 1 S  
 265 Std2 2 S  
 266 Room 1 S  
 267 Room 2 S  
 268 Power1 S  
 269 Power2 S  
 270 Gate S  
 271 Jazz 2 S  
 272 Jazz 3 S  
 273 Funk S  
 274 Funk RS  
 275 Bop S  
 276 Bop RS  
 277 Picolo5S  
 278 Pco5 RS  
 279 Picolo6S  
 280 Pco6 RS  
 281 Medium5S  
 282 Med5 RS  
 283 Medium6S  
 284 Med6 RS  
 285 Medium7S  
 286 Med7 RS  
 287 Medium8S  
 288 Med8 RS  
 289 Fat3 S  
 290 Fat3 RS  
 291 Fat4 S  
 292 Fat4 RS  
 293 DynamicS  
 294 Dynmc RS  
 295 Roll S  
 296 Buzz S  
 297 Dopin1 S  
 298 Dopin2 S  
 299 Reggae S  
 300 Cruddy S  
 301 Dance1 S  
 302 Dance2 S  
 303 House S  
 304 HousDpns  
 305 Clap! S  
 306 Whack S  
 307 TR808 S  
 308 TR909 S  
 309 Elec 1 S  
 310 Elec 2 S  
 311 Elec 3 S  
 312 ElNoiz S  
 313 HipHop1S  
 314 HipHop2S  
 315 LoFi S  
 316 LoFi RS  
 317 Radio S  
 318 CrsStk 1  
 319 CrsStk 2  
 320 CrsStk 3  
 321 CrsStk 4  
 322 CrsStk 5  
 323 CrsStk 6  
 324 808Crstk

**TOM**

325 OysterT1  
 326 OysterT2  
 327 OysterT3  
 328 OysterT4  
 329 Comp T1  
 330 Comp T2  
 331 Comp T3  
 332 Comp T4

333 Fibre T1  
 334 Fibre T2  
 335 Fibre T3  
 336 Fibre T4  
 337 Dry1 T1  
 338 Dry1 T2  
 339 Dry1 T3  
 340 Dry1 T4  
 341 Dry2 T1  
 342 Dry2 T2  
 343 Dry2 T3  
 344 Dry2 T4  
 345 Maple T1  
 346 Maple T2  
 347 Maple T3  
 348 Maple T4  
 349 Rose T1  
 350 Rose T2  
 351 Rose T3  
 352 Rose T4  
 353 SakuraT1  
 354 SakuraT2  
 355 SakuraT3  
 356 SakuraT4  
 357 Jazz1 T1  
 358 Jazz1 T2  
 359 Jazz1 T3  
 360 Jazz1 T4  
 361 Jazz2 T1  
 362 Jazz2 T2  
 363 Jazz2 T3  
 364 Jazz2 T4  
 365 Buzz1 T1  
 366 Buzz1 T2  
 367 Buzz1 T3  
 368 Buzz1 T4  
 369 Buzz2 T1  
 370 Buzz2 T2  
 371 Buzz2 T3  
 372 Buzz2 T4  
 373 Buzz3 T1  
 374 Buzz3 T2  
 375 Buzz3 T3  
 376 Buzz3 T4  
 377 Buzz4 T1  
 378 Buzz4 T2  
 379 Buzz4 T3  
 380 Buzz4 T4  
 381 NatralT1  
 382 NatralT2  
 383 NatralT3  
 384 NatralT4  
 385 Natrl2T1  
 386 Natrl2T2  
 387 Natrl2T3  
 388 Natrl2T4  
 389 StudioT1  
 390 StudioT2  
 391 StudioT3  
 392 StudioT4  
 393 Slap T1  
 394 Slap T2  
 395 Slap T3  
 396 Slap T4  
 397 Room1 T1  
 398 Room1 T2  
 399 Room1 T3  
 400 Room1 T4  
 401 Room2 T1  
 402 Room2 T2  
 403 Room2 T3  
 404 Room2 T4

405 Room3 T1  
 406 Room3 T2  
 407 Room3 T3  
 408 Room3 T4  
 409 Room4 T1  
 410 Room4 T2  
 411 Room4 T3  
 412 Room4 T4  
 413 Room5 T1  
 414 Room5 T2  
 415 Room5 T3  
 416 Room5 T4  
 417 Big T1  
 418 Big T2  
 419 Big T3  
 420 Big T4  
 421 Rock T1  
 422 Rock T2  
 423 Rock T3  
 424 Rock T4  
 425 Punch T1  
 426 Punch T2  
 427 Punch T3  
 428 Punch T4  
 429 Oak T1  
 430 Oak T2  
 431 Oak T3  
 432 Oak T4  
 433 Balsa T1  
 434 Balsa T2  
 435 Balsa T3  
 436 Balsa T4  
 437 VintgeT1  
 438 VintgeT2  
 439 VintgeT3  
 440 VintgeT4  
 441 Brsh1 T1  
 442 Brsh1 T2  
 443 Brsh1 T3  
 444 Brsh1 T4  
 445 Brsh2 T1  
 446 Brsh2 T2  
 447 Brsh2 T3  
 448 Brsh2 T4  
 449 Dark T1  
 450 Dark T2  
 451 Dark T3  
 452 Dark T4  
 453 AttackT1  
 454 AttackT2  
 455 AttackT3  
 456 AttackT4  
 457 Hall T1  
 458 Hall T2  
 459 Hall T3  
 460 Hall T4  
 461 Birch T1  
 462 Birch T2  
 463 Birch T3  
 464 Birch T4  
 465 Beech T1  
 466 Beech T2  
 467 Beech T3  
 468 Beech T4  
 469 Micro T1  
 470 Micro T2  
 471 Micro T3  
 472 Micro T4  
 473 Bend T1  
 474 Bend T2  
 475 Bend T3  
 476 Bend T4

477 Bowl T1  
 478 Bowl T2  
 479 Bowl T3  
 480 Bowl T4  
 481 Dirty T1  
 482 Dirty T2  
 483 Dirty T3  
 484 Dirty T4  
 485 Std 1 T1  
 486 Std 1 T2  
 487 Std 1 T3  
 488 Std 1 T4  
 489 Std 1 T5  
 490 Std 1 T6  
 491 Std 2 T1  
 492 Std 2 T2  
 493 Std 2 T3  
 494 Std 2 T4  
 495 Std 2 T5  
 496 Std 2 T6  
 497 Room6 T1  
 498 Room6 T2  
 499 Room6 T3  
 500 Room6 T4  
 501 Room6 T5  
 502 Room6 T6  
 503 Power T1  
 504 Power T2  
 505 Power T3  
 506 Power T4  
 507 Power T5  
 508 Power T6  
 509 Jazz3 T1  
 510 Jazz3 T2  
 511 Jazz3 T3  
 512 Jazz3 T4  
 513 Jazz3 T5  
 514 Jazz3 T6  
 515 Brsh3 T1  
 516 Brsh3 T2  
 517 Brsh3 T3  
 518 Brsh3 T4  
 519 Brsh3 T5  
 520 Brsh3 T6  
 521 Gate T1  
 522 Gate T2  
 523 Gate T3  
 524 Gate T4  
 525 LoFi T1  
 526 LoFi T2  
 527 LoFi T3  
 528 LoFi T4  
 529 ElBendT1  
 530 ElBendT2  
 531 ElBendT3  
 532 ElBendT4  
 533 ElBnd2T1  
 534 ElBnd2T2  
 535 ElBnd2T3  
 536 ElBnd2T4  
 537 ElBnd3T1  
 538 ElBnd3T2  
 539 ElBnd3T3  
 540 ElBnd3T4  
 541 ElNoisT1  
 542 ElNoisT2  
 543 ElNoisT3  
 544 ElNoisT4  
 545 ElDualT1  
 546 ElDualT2  
 547 ElDualT3  
 548 ElDualT4

## Drum Instrument List

No.	Name	Remark
549	Elec T1	
550	Elec T2	
551	Elec T3	
552	Elec T4	
553	Elec T5	
554	Elec T6	
555	TR808 T1	
556	TR808 T2	
557	TR808 T3	
558	TR808 T4	
559	TR808 T5	
560	TR808 T6	

### HI-HAT

561	Pure HH
562	PureEgHH
563	BrightHH
564	BritEgHH
565	Jazz HH
566	JazzEgHH
567	Thin HH
568	ThinEgHH
569	Heavy HH
570	HevyEgHH
571	Light HH
572	LigtEgHH
573	Dark HH
574	DarkEgHH
575	12" HH
576	12"Eg HH
577	13" HH
578	13"Eg HH
579	14" HH
580	14"Eg HH
581	15" HH
582	15"Eg HH
583	Brush1HH
584	Brush2HH
585	SizzleHH
586	Sizle2HH
587	Voice HH
588	HandC HH
589	TambrnHH
590	MaracsHH
591	TR808 HH
592	TR909 HH
593	CR78 HH
594	Mtl1808HH
595	Mtl1909HH
596	Mtl178 HH
597	LoFil HH
598	LoFi2 HH

### CRASH

599	Medl4 Cr
600	Medl6 Cr
601	Medl8 Cr
602	Quik16Cr
603	Quik18Cr
604	Thin16Cr
605	Thin18Cr
606	Brsh1 Cr
607	Brsh2 Cr
608	Sz1Br Cr
609	Swell Cr
610	Splsh 6"
611	Splsh 8"
612	Splsh10"

613	Splsh12"
614	Cup 4"
615	Cup 6"
616	HdSpl 8"
617	HdSpl10"
618	China10"
619	China12"
620	China18"
621	China20"
622	Sz1China
623	Sz1China
624	PgyzBack
625	PgyCrsh1
626	PgyCrsh2
627	PgyCrsh3
628	PgSplsh1
629	PgSplsh2
630	PhaseCym
631	Elec Cr
632	TR808 Cr
633	LoFil Cr
634	LoFi2 Cr

### RIDE

635	Jazz Rd
636	Jazz RdE
637	Jazz RdB
638	Jazz RdX *Bow/Bell
639	Pop Rd
640	Pop RdE
641	Pop RdB
642	Pop RdX *Bow/Bell
643	Rock Rd
644	Rock RdE
645	Rock RdB
646	Rock RdX *Bow/Bell
647	Lite Rd
648	Lite RdE
649	Lite RdB
650	Lite RdX *Bow/Bell
651	CrashRd
652	CrashRdE
653	DkCrsRd
654	DkCrsRdE
655	Brsh1 Rd
656	Brsh2 Rd
657	Sz1Br Rd
658	Sz11 Rd
659	Sz11 RdE
660	Sz11 RdB
661	Sz11 RdX *Bow/Bell
662	Sz12 Rd
663	Sz12 RdE
664	Sz12 RdB
665	Sz12 RdX *Bow/Bell
666	Sz13 Rd
667	Sz13 RdE
668	Sz13 RdB
669	Sz13 RdX *Bow/Bell
670	Sz14 Rd
671	Pgy Rd1
672	Pgy Rd1B
673	Pgy Rd1X *Bow/Bell
674	Pgy Rd2
675	Pgy Rd2B
676	Pgy Rd2X *Bow/Bell
677	LoFi Rd
678	LoFi RdE
679	LoFi RdB

### PERCUSSION

680	R8Bng Hi
681	R8Bng Lo
682	R8Bng2Hi
683	R8Bng2Lo
684	Bongo Hi
685	Bongo Lo
686	Bongo2Hi
687	Bongo2Lo
688	R8Cng Mt
689	R8Cng Hi
690	R8Cng Lo
691	Conga Mt
692	Conga Sl
693	Conga Op
694	Conga Lo
695	CngMt VS
696	CngSl VS
697	Cowbell1
698	Cowbell2
699	CowblDuo
700	Claves
701	GiroLng1
702	GuiroSht
703	GiroLng2
704	Guiro VS
705	Maracas
706	Shaker
707	SmlShakr
708	Tambrn 1
709	Tambrn 2
710	Tambrn 3
711	Tambrn 4
712	Tmb11 Hi
713	Tmb11 Rm
714	Tmb11 Lo
715	Paila
716	Tmb12 Hi
717	Tmb12 Lo
718	VibraSlp
719	Agogo Hi
720	Agogo Lo
721	Agogo2Hi
722	Agogo2Lo
723	CabasaUp
724	CabasaDw
725	CabasaVS
726	CuicaMt1
727	Cuica Op
728	Cuica Lo
729	CuicaMt2
730	PandroMt
731	PandroOp
732	PandroSl
733	PandroVS
734	SurdoHmt
735	SurdoHOp
736	SurdoHVS
737	SurdoLmt
738	SurdoLOp
739	SurdoLVS
740	Whistle
741	Whisl Sh
742	Caxixi
743	Tabla Na
744	TablaTin
745	TablaTun
746	Tabla Te
747	Tabla Ti
748	Baya Ge
749	Baya Ka

750	Baya Gin
751	Baya Sld
752	Pot Drum
753	PotDr Mt
754	PotDr VS
755	TalkinDr
756	ThaiGong
757	ThaiGng2
758	BellTree
759	TinyGong
760	Gong
761	TemplBel
762	Wa-Daiko
763	Taiko
764	Sleibell
765	TreeChim
766	TringlOp
767	TringlMt
768	TringlVS
769	R70TriOp
770	R70TriMt
771	R70TriVS
772	Castanet
773	WdBlk Hi
774	WdBlk Lo
775	ConcrtBD
776	ConBD Mt
777	Hand Cym
778	HndCymMt
779	TimpaniG
780	TimpaniC
781	TimpaniE
782	PercHit1
783	PercHit2
784	Orch Maj
785	Orch Min
786	Orch Dim
787	Kick/Rol
788	Kick/Cym
789	OrchRoll
790	OrchChok
791	Hit Roll
792	Finale
793	808Clap
794	808Cwbl1
795	808Cwbl2
796	808Marcs
797	808Clavs
798	808Conga
799	909RIM
800	909CLAP
801	78Cowbel
802	78Guiro
803	78GiroSt
804	78Maracs
805	78MBeat
806	78Tambrn
807	78Bongo
808	78Claves
809	78Rim
810	55Claves

### SPECIAL

811	Applause
812	Encore
813	Bird
814	Dog
815	Bubbles
816	Heart Bt
817	Telephon
818	Punch

819 KungFoo  
 820 Pistol  
 821 Gun Shot  
 822 Glass  
 823 Hammer  
 824 Bucket  
 825 Barrel  
 826 TrashCan  
 827 Af Stomp  
 828 Bounce  
 829 CuicaHit  
 830 Monster  
 831 AirDrive  
 832 Car Door  
 833 Car Cell  
 834 CarEngin  
 835 Car Horn  
 836 Helicptr  
 837 Thunder  
 838 Bomb  
 839 Sticks  
 840 Click  
 841 Tamb FX  
 842 Tek Klik  
 843 Beep Hi  
 844 Beep Low  
 845 MetroBel  
 846 MetroClk  
 847 Snaps  
 848 Clap  
 849 NoizClap  
 850 Tek Noiz  
 851 Mtl Slap  
 852 R8 Slap  
 853 Vocoder1  
 854 Vocoder2  
 855 Vocoder3  
 856 DynScrch  
 857 Scrach 1  
 858 Scrach 2  
 859 Scrach 3  
 860 Scrach 4  
 861 Scrach 5  
 862 Scrach 6  
 863 ScrchLP  
 864 Phil Hit  
 865 LoFi Hit  
 866 Hi-Q  
 867 Hoo...  
 868 DaoDrill  
 869 Scrape  
 870 Martian  
 871 CoroCoro  
 872 CoroBend  
 873 Burt

874 Boing 1  
 875 Boing 2  
 876 TeknoBrd  
 877 Nantoka!  
 878 ElecBird  
 879 MtlBend1  
 880 MtlBend2  
 881 MtlNoise  
 882 MtlPhase  
 883 Laser  
 884 Mystery  
 885 TimeTrip  
 886 Kick Amb  
 887 SnareAmb  
 888 Tom Amb

**MELODIC**

889 Kalimba  
 890 Steel Dr  
 891 Glcknspl  
 892 Vibraphn  
 893 Marimba  
 894 Xylophon  
 895 Tublrbel  
 896 Celesta  
 897 Saw Wave  
 898 TB Bass  
 899 SlapBass  
 900 Gt Slide  
 901 GtScrach  
 902 GuitDist  
 903 GuitBs 1  
 904 GuitBs 2  
 905 CutGtDwn  
 906 CutGtUp  
 907 FletNoiz  
 908 Bs Slide  
 909 WahGtDwl  
 910 WahGtUp1  
 911 WahGtDw2  
 912 WahGtUp2  
 913 Shami VS  
 914 Brass VS  
 915 StrngsVS  
 916 Pizicato  
 917 TeknoHit  
 918 FunkHit1  
 919 FunkHit2  
 920 FunkHit3

**VOICE**

921 Lady Ahh  
 922 Aouuu!  
 923 Hooh!

924 Haa!  
 925 SayYeah!  
 926 Yeah  
 927 Ahhh  
 928 Haaa  
 929 Achaa!  
 930 Nope!  
 931 Bap  
 932 Dat  
 933 BapDatVS  
 934 Doot  
 935 DaoFall1  
 936 DaoFall2  
 937 DaoFall3  
 938 DaoFall4  
 939 DoDat VS  
 940 DoDao VS  
 941 Scat1 VS  
 942 Scat2 VS  
 943 Scat3 VS  
 944 Scat4 VS  
 945 Scat5 VS  
 946 Voice K  
 947 VoiceLoK  
 948 Voice S  
 949 Voice T1  
 950 Voice T2  
 951 Voice T3  
 952 Voice T4  
 953 Voice Cr  
 954 Count 1  
 955 Count 2  
 956 Count 3  
 957 Count 4  
 958 Count 5  
 959 Count 6  
 960 Count 7  
 961 Count 8  
 962 Count 9  
 963 Count 10  
 964 Count 11  
 965 Count 12  
 966 Count 13  
 967 CountAnd  
 968 Count E  
 969 Count A  
 970 Count Ti  
 971 Count Ta

**REVERSE**

972 RvsKick1  
 973 RvsKick2  
 974 RvsSnr 1  
 975 RvsSnr 2  
 976 RvsTom

977 RvsCrsh1  
 978 RvsCrsh2  
 979 RvsChina  
 980 RvsBelTr  
 981 Rvs Hi-Q  
 982 RvsMFaze  
 983 RvsAirDr  
 984 RvsBoin1  
 985 RvsBoin2  
 986 Rvs Bend  
 987 RvsVocod  
 988 RvsCarcl  
 989 RvsEngin

**FIXED HI-HAT**

990 Std1 CH  
 991 Std1 ECH  
 992 Std1 OH  
 993 Std1 EOH  
 994 Std1 PdH  
 995 Std2 CH  
 996 Std2 ECH  
 997 Std2 OH  
 998 Std2 PdH  
 999 Room CH  
 1000 Room ECH  
 1001 Room OH  
 1002 Room EOH  
 1003 Room PdH  
 1004 Powr CH  
 1005 Powr ECH  
 1006 Powr OH  
 1007 Powr PdH  
 1008 Brsh CH  
 1009 Brsh ECH  
 1010 Brsh OH  
 1011 Brsh PdH  
 1012 Elec CH  
 1013 Elec OH  
 1014 Elec PdH  
 1015 808 CH  
 1016 808 ECH  
 1017 808 OH  
 1018 808 EOH  
 1019 808 PdH  
 1020 LoFi CH  
 1021 LoFi OH  
 1022 LoFi EOH  
 1023 LoFi PdH

**OFF**

1024 OFF

\*x-stick (XS):

A velocity switching "snare rim" sound, that when played softly produces a cross stick sound, and when played harder, produces a rim shot sound.

\*Bow/Bell (RdX):

A "cross-faded" type of sounds. With velocity, you can control "bow" and "bell" sound.

RS: Rim shot sound

VS: Velocity switching sound

Inst Group "FIXED HI-HAT":

These are hi-hat sounds that cannot be controlled by the FD-7 (optional) foot controller.

# Preset Percussion Set List

	1. Standard 1 PC100	2. Standard 2 PC101	3. Room PC102	4. Power PC103	5. Electronic PC104	6. 808/909 PC105	
	Note No. 18	Bs Slide 2	←	←	←	←	
	19	GtScrach 1	←	←	←	←	
	20	Gt Slide 1	←	←	←	←	
	21	CutGtDwn 1	←	←	←	←	
	22	CutGtUp 1	←	←	←	←	
	23	WahGtDwl 1	←	←	←	←	
C1	24	WahGtUp1 1	←	←	←	←	
	25	WahGtDw2 1	←	←	←	←	
	26	WahGtUp2 1	←	←	←	←	
	27	Hi-Q 1	←	←	←	←	
	28	Mtl Slap 2	←	←	←	←	
	29	Scrach 3 1	←	←	←	←	
	30	Scrach 2 1	←	←	←	←	
	31	Sticks 1	←	←	←	←	
	32	Click 1	←	←	←	←	
	33	MetroClk 1	←	←	←	←	
	34	MetroBel 1	←	←	←	←	
	35	Std1 2 K 2	Std2 2 K	Room 9 K	Power K2	Elec 2 K	TR909 K
C2	36	Std1 1 K 2	Std2 1 K	Room 8 K	Power K1	Elec 1 K	TR808 K
	37	CrsStk 3 1	←	CrsStk 1	←	CrsStk 3	808Crstk
	38	Std1 1 S 3	Std2 1 S	Room 1 S	Power1 S	Elec 1 S	TR808 S
	39	Clap 1	←	←	←	←	808Clap
	40	Std1 2 S 4	Std2 2 S	Room 2 S	Power2 S	Gate S	TR909 S
	41	Std 1 T6 2	Std 2 T6	Room6 T6	Power T6	Elec T6	TR808 T6
	42	Std1 CH 2	Std2 CH	Room CH	Power CH	Elec CH	808 ECH
	43	Std 1 T5 2	Std 2 T5	Room6 T5	Power T5	Elec T5	TR808 T5
	44	Std1 PdH 1	Std2 PdH	Room PdH	Power PdH	Elec PdH	808 PdH
	45	Std 1 T4 2	Std 2 T47	Room6 T4	Power T4	Elec T4	TR808 T4
	46	Std1 EOH 1	Std2 OH	Room EOH	Power OH	Elec OH	808 EOH
	47	Std 1 T3 2	Std 2 T3	Room6 T3	Power T3	Elec T3	TR808 T3
C3	48	Std 1 T2 2	Std 2 T2	Room6 T2	Power T2	Elec T2	TR808 T2
	49	Med16 Cr 2	←	←	←	←	TR808 CR
	50	Std 1 T1 2	Std 2 T1	Room6 T1	Power T1	Elec T1	TR808 T1
	51	Pop Rd 2	Jazz Rd	Pop Rd	Jazz Rd	Pop Rd	←
	52	China18" 1	←	←	←	RvsCrsh2	China18"
	53	Pop RdB 1	Jazz RdB	Pop RdB	Jazz RdB	Pop RdB	←
	54	Tambrn 1	←	←	←	←	78Tambrn
	55	Splsh12" 1	←	←	←	←	←
	56	Cowbell1 1	Cowbell12	←	←	Cowbell1	808Cwb11
	57	Quik16Cr 2	←	←	←	←	←
	58	VibraSlp 1	←	←	←	←	
	59	Pop RdE 1	Jazz RdE	Pop RdE	Jazz RdE	Pop RdE	←
C4	60	R8Bng Hi 2	←	←	←	←	78Bongo
	61	R8Bng Lo 2	←	←	←	←	78Bongo
	62	Conga Mt 2	←	←	←	←	808Conga
	63	Conga Sl 2	←	←	←	←	808Conga
	64	Conga Op 2	←	←	←	←	808Conga
	65	Tmb11 Rm 2	←	←	←	←	←
	66	Tmb11 Lo 2	←	←	←	←	←
	67	Agogo Hi 1	←	←	←	←	←
	68	Agogo Lo 1	←	←	←	←	←
	69	CabasaUp 1	←	←	←	←	←
	70	Maracas 1	←	←	←	←	808Marcs
	71	Whisl Sh 1	←	←	←	←	←
C5	72	Whistle 1	←	←	←	←	←
	73	GuiroSht 1	←	←	←	←	78GiroSt
	74	GiroLngl 1	←	←	←	←	78Guiro
	75	Claves 1	←	←	←	←	808Clavs
	76	WdBlk Hi 1	←	←	←	←	←
	77	WdBlk Lo 1	←	←	←	←	←
	78	CuicaMt1 1	←	←	←	←	←
	79	Cuica Op 1	←	←	←	←	←
	80	TringlMt 1	←	←	←	←	←
	81	TringlOp 1	←	←	←	←	←
	82	Shaker 1	←	←	←	←	
	83	Sleibell 1	←	←	←	←	
C6	84	BellTree 1	←	←	←	←	←
	85	Castanet 1	←	←	←	←	←
	86	SurdoLMt 3	←	←	←	←	←
	87	SurdoLOp 2	←	←	←	←	←
	88	OFF 0	←	←	←	←	←
	89	R8Cng Hi 2	←	←	←	←	←
	90	TinyGong 1	←	←	←	←	←
	91	Gong 1	←	←	←	←	←
	92	PandroMt 1	←	←	←	←	←
	93	PandroOp 2	←	←	←	←	←
	94	PandroSl 1	←	←	←	←	
	95	TreeChim 1	←	←	←	←	
C7	96	Caxixi 1	←	←	←	←	

# Preset Percussion Set List

	7. Jazz PC106	8. Brush PC107	9. Perc Only PC108	10. Special PC109	Mute	Drum Kit Note Numbers
	18 Bs Slide	←	R8Bng2Hi	FunkHit2		The note numbers assigned to each trigger inputs
	19 GtScrach	←	R8Bng2Lo	FunkHit2		
	20 Gt Slide	←	Bongo Hi	FunkHit2		
	21 CutGtDwn	←	Bongo Lo	FunkHit2		
	22 CutGtUp	←	Bongo2Hi	FunkHit3		TRIG 3 (HI-HAT)CLOSE RIM
	23 WahGtDwl	←	Bongo2Lo	FunkHit3		
C1	24 WahGtUp1	←	R8Cng Mt	FunkHit3		
	25 WahGtDw2	←	R8Cng Hi	FunkHit3		
	26 WahGtUp2	←	R8Cng Lo	FunkHit1		TRIG 3 (HI-HAT)OPEN RIM
	27 Hi-Q	←	Cowb1Duo	FunkHit1		
	28 Mtl Slap	←	Tambrn 2	FunkHit1		
	29 Scrach 3	←	Tambrn 3	FunkHit1		
	30 Scrach 2	←	Tmbl2 Hi	TeknoHit		TRIG 8 (TOM4)
	31 Sticks	←	Tmbl2 Lo	TeknoHit		TRIG 6 (AUX)
	32 Click	←	Paila	TeknoHit		
	33 MetroClk	←	Tabla Na	TeknoHit		
	34 MetroBel	←	TablaTin	Heart Bt		
	35 Jazz 4 K	Std2 2 K	TablaTun	Glass	*	
C2	36 Jazz 3 K	Brush K	Tabla Te	Pistol	*	TRIG 1 (KICK1)
	37 CrsStk 3	←	Tabla Ti	ScrchLP	*	
	38 Jazz 2 S	Brsh Tap	Baya Ge	Phil Hit	*	TRIG 2 (SNARE)
	39 Clap	Brsh Slp	Baya Ka	LoFi Hit	*	
	40 Jazz 3 S	Brsh Swl	Baya Gin	Boing 1	*	TRIG 2 (SNARE) RIM
	41 Jazz3 T6	Brsh3 T6	Baya Sld	Monster	*	TRIG 7 (TOM3)
	42 Std1 CH	Brsh CH	Pot Drum	Count	*	TRIG 3 (HI-HAT) CLOSED
	43 Jazz3 T5	Brsh3 T5	PotDr Mt	Count	*	
	44 Std1 PdH	Brsh PdH	TalkinDr	Count	*	TRIG 3 (HI-HAT) PEDAL
	45 Jazz3 T4	Brsh3 T4	ThaiGng2	Count	*	TRIG 5 (TOM2)
46 Std1 EOH	Brsh OH	TinyGong	Count	*	TRIG 3 (HI-HAT) OPEN	
47 Jazz3 T3	Brsh3 T3	Gong	Bomb	*		
C3	48 Jazz3 T2	Brsh3 T2	TemplBel	Thunder	*	TRIG 4 (TOM1)
	49 Med16 Cr	Brsh1 Cr	Wa-Daiko	Car Door	*	TRIG 9 (CRASH1)
	50 Jazz3 T1	Brsh3 T1	Taiko	Car Cell	*	TRIG 4 (TOM1) RIM
	51 Jazz Rd	Brsh1 Rd	R70TriOp	CarEngin	*	TRIG 11 (RIDE)
	52 China18"	←	R70TriMt	Car Horn	*	TRIG 10 (CRASH2) RIM
	53 Jazz RdB	←	TimpaniG	Helicptr	*	TRIG 11 (RIDE) RIM
	54 Tambrn 1	←	TimpaniG	Gt Slide	*	
	55 Splsh12"	←	TimpaniG	GtScrach	*	TRIG 9 (CRASH1) RIM
	56 Cowbell12	←	TimpaniG	GitDist	*	
	57 Quik16Cr	Brsh1 Cr	TimpaniG	GuitBs 1	*	TRIG 10 (CRASH2)
58 VibraSlp	←	TimpaniG	GuitBs 2	*		
59 Jazz RdE	Jazz Rd	TimpaniC	FletNoiz	*		
C4	60 R8Bng Hi	←	TimpaniC	Shami VS		PC: Program Number
	61 R8Bng Lo	←	ThaiGong	Brass VS		←: Same as the left
	62 Conga Mt	←	ThaiGong	StrngsVS		Voices:
	63 Conga Sl	←	ThaiGong	StrngsVS		Number of voice used
	64 Conga Op	←	ThaiGong	StrngsVS		*: Note number for muted drum sounds when muting only the drum instruments of the percussion part.
	65 Tmbl1 Rm	←	PercHit1	Pizicato		
	66 Tmbl1 Lo	←	PercHit2	RvsKick1		
	67 Agogo Hi	←	Orch Maj	RvsSnr 2		
	68 Agogo Lo	←	Orch Min	RvsCrsh2		
	69 CabasaUp	←	Orch Dim	RvsChina		
70 Maracas	←	Kick/Rol	Lady Ahh			
C5	71 Whisl Sh	←	Kick/Cym	Aoouu!		
	72 Whistle	←	OrchRoll	HooH!		
	73 GuiroSht	←	OrchChok	Haa!		
	74 GiroLngl	←	Hit Roll	SayYeah!		
	75 Claves	←	Finale	Yeah		
	76 WdBlk Hi	←	Applause	Ahhh		
	77 WdBlk Lo	←	Encore	Haaa		
	78 CuicaMt1	←	TreeChim	Achaa!		
	79 Cuica Op	←	808Clap	Nope!		
	80 TringlMt	←	808Cwbl1	Bap		
81 TringlOp	←	808Cwbl2	Dat			
82 Shaker	←	808Marcs	Scat3 VS			
83 Sleibell	←	808Clavs	Doot			
C6	84 BellTree	←	808Conga	DaoFall1		
	85 Castanet	←	909RIM	DaoFall2		
	86 SurdoLMt	←	909CLAP	DaoFall3		
	87 SurdoLOp	←	78Cowbel	DaoFall4		
	88 OFF	←	78Guiro	DoDat VS		
	89 R8Cng Hi	←	78GiroSt	DoDat VS		
	90 TinyGong	←	78Maracs	DoDat VS		
	91 Gong	←	78MBeat	DoDao VS		
	92 PandroMt	←	78Tambrn	Scat1 VS		
	93 PandroOp	←	78Bongo	Scat2 VS		
94 PandroSl	←	78Claves	Scat2 VS			
95 TreeChim	←	78Rim	Scat2 VS			
96 Caxixi	←	55Claves	Scat4 VS			

**MEMO**

In GM Mode, "Standard 1" is assigned.

# Backing Instrument List

PC	CC0	Name	Voices
<b>PIANO</b>			
1	0	Piano 1	1
	8	Piano 1w	2
	16	Piano 1d	1
2	0	Piano 2	1
	8	Piano 2w	2
3	0	Piano 3	1
	8	Piano 3w	2
4	0	Honky-tonk	2
	8	Honky-tonk w	2
<b>E. PIANO</b>			
5	0	E.Piano 1	1
	8	Detuned EP 1	2
	24	60's E.Piano	1
	64	FM+SA EP	2
	65	Hard Rhodes	2
6	0	E.Piano 2	2
	64	Bright FM EP	2
<b>CLAVI</b>			
7	0	Harpsichord	1
	8	Coupled Hps.	2
	16	Harpsi.w	2
	24	Harpsi.o	2
8	0	Clav.	1
	64	Funk Clav.	2
<b>CHROMATIC PERCUSSION</b>			
9	0	Celesta	1
10	0	Glockenspiel	1
11	0	Music Box	1
12	0	Vibraphone	1
	8	Vib.w	2
13	0	Marimba	1
14	0	Xylophone	1
15	0	Tubular-bell	1
	8	Church Bell	1
	9	Carillon	1
16	0	Santur	1
<b>ORGAN</b>			
17	0	Organ 1	1
	8	Detuned Or.1	2
	16	60's Organ 1	1
	32	Organ 4	2
	64	SC88 Organ 4	1
	65	Even Bar	2
18	0	Organ 2	1
	8	Detuned Or.2	2
	32	Organ 5	2
19	0	Organ 3	2

20	0	Church Org.1	1
	8	Church Org.2	2
	16	Church Org.3	2
21	0	Reed Organ	1
22	0	Accordion Fr	2
	8	Accordion It	2
23	0	Harmonica	1
24	0	Bandoneon	2
<b>GUITAR</b>			
25	0	Nylon-str.Gt	1
26	0	Steel-str.Gt	1
	8	12-str.Gt	2
	64	Nylon+Steel	2
27	0	Jazz Gt.	1
	8	Hawaiian Gt.	1
28	0	Clean Gt.	1
	8	Chorus Gt.	2
29	0	Muted Gt.	1
	64	Muted Gt.2	2
	65	Pop Gt.	1
	66	Funk Gt.	1*
	67	Funk Gt.2	1*
30	0	Overdrive Gt	1
	64	Fdbk.Odrv.Gt	2
31	0	DistortionGt	1
	8	Feedback Gt.	2
	64	Heavy Gt.	1
	65	Fdbk. Hvy.Gt	2
	66	Muted Dis.Gt	1
	67	Rock Rhythm	2
32	0	Gt.Harmonics	1
	8	Gt. Feedback	1

## \*: VELOCITY SWITCH

The tone switches at velocity 116.

## BASS

33	0	Acoustic Bs.	2
	64	Elctrc.Ac.Bs	2
34	0	Fingered Bs.	1
	64	Funk Bass	2
	65	Reggae Bass	2
35	0	Picked Bs.	1
	64	Mute PickBs1	1
	65	Mute PickBs2	1
36	0	Fretless Bs.	1
37	0	Slap Bass 1	1
	64	Slap Bass 3	1
	65	Reso Slap	1
	66	Slap Bass 4	1
38	0	Slap Bass 2	1

## SYN. BASS

39	0	Synth Bass 1	1
	1	SynthBass101	1
	8	Synth Bass 3	1
	64	TB303 Bs 1	1
	65	TB303 Bs 2	1
	66	TB303 Bs 3	1
40	0	Synth Bass 2	2
	16	Rubber Bass	2
	64	SH101 Bs 1	1
	65	SH101 Bs 2	1
	66	SH101 Bs 3	1
	67	Modular Bass	2

## ORCHESTRA

41	0	Violin	1
	8	Slow Violin	1
42	0	Viola	1
43	0	Cello	1
44	0	Contrabass	1
45	0	Tremolo Str	1
46	0	PizzicatoStr	1
47	0	Harp	1
48	0	Timpani	1

## STRINGS

49	0	Strings	1
	8	Orchestra	2
50	0	Slow Strings	1
51	0	Syn.Strings1	1
	8	Syn.Strings3	2
	64	Syn.Strings4	2
	65	OB Strings	2
52	0	Syn.Strings2	2
53	0	Choir Aahs	1
	32	Choir Aahs 2	1
54	0	Voice Oohs	1
55	0	SynVox	1
56	0	OrchestraHit	2

## BRASS

57	0	Trumpet	1
58	0	Trombone	1
	1	Trombone 2	2
59	0	Tuba	1
60	0	MutedTrumpet	1
61	0	French Horn	2
	1	Fr.Horn 2	2
62	0	Brass 1	1
	8	Brass 2	2

**SYN. BRASS**

63	0	Synth Brass1	2
	8	Synth Brass3	2
	16	AnalogBrass1	2
	64	Synth Brass5	2
	65	Poly Brass	2
	66	Quack Brass	2
	67	Octave Brass	2
64	0	Synth Brass2	2
	8	Synth Brass4	1
	16	AnalogBrass2	2
	64	Soft Brass	2
	65	Velo Brass 1	2
	66	Velo Brass 2	2

**REED**

65	0	Soprano Sax	1
66	0	Alto Sax	1
67	0	Tenor Sax	1
68	0	Baritone Sax	1
69	0	Oboe	1
70	0	English Horn	1
71	0	Bassoon	1
72	0	Clarinet	1

**PIPE**

73	0	Piccolo	1
74	0	Flute	1
75	0	Recorder	1
76	0	Pan Flute	1
77	0	Bottle Blow	2
78	0	Shakuhachi	2
79	0	Whistle	1
80	0	Ocarina	1

**SYN. LEAD**

81	0	Square Wave	2
	1	Square	1
	8	Sine Wave	1
82	0	Saw Wave	2
	1	Saw	1
	8	Doctor Solo	2
	64	Big Lead	2
	65	Waspy Synth	2
83	0	Syn.Calliope	2
84	0	Chiffer Lead	2
85	0	Charang	2
	64	Dist. Lead 1	2
	65	Dist. Lead 2	2
	66	Funk Lead	2
86	0	Solo Vox	2
87	0	5th Saw Wave	2
	64	Big Fives	2
88	0	Bass & Lead	2
	64	Big & Raw	2
	65	Fat & Perky	2

**SYN. PAD**

89	0	Fantasia	2
90	0	Warm Pad	1
	64	Thick Pad	2
	65	Horn Pad	2
91	0	Polysynth	2
	64	80's PolySyn	2
92	0	Space Voice	1
93	0	Bowed Glass	2
94	0	Metal Pad	2
	64	Panner Pad	2
95	0	Halo Pad	2
96	0	Sweep Pad	1
	64	Polar Pad	1
	65	Converge	1

**SYN. SFX**

97	0	Ice Rain	2
98	0	Soundtrack	2
	64	Ancestral	2
	65	Prologue	2
99	0	Crystal	2
	1	Syn Mallet	1
100	0	Atmosphere	2
101	0	Brightness	2
102	0	Goblin	2
103	0	Echo Drops	1
	1	Echo Bell	2
	2	Echo Pan	2
	64	Echo Pan 2	2
	65	Big Panner	2
	66	Reso Panner	2
104	0	Star Theme	2

**ETHNIC MISC**

105	0	Sitar	1
	1	Sitar 2	2
106	0	Banjo	1
107	0	Shamisen	1
108	0	Koto	1
	8	Taisho Koto	2
109	0	Kalimba	1
110	0	Bagpipe	1
111	0	Fiddle	1
112	0	Shanai	1

**PERCUSSIVE**

113	0	Tinkle Bell	1
114	0	Agogo	1
115	0	Steel Drums	1
116	0	Woodblock	1
	8	Castanets	1
117	0	Taiko	1
	8	Concert BD	1

118	0	Melo. Tom 1	1
	8	Melo. Tom 2	1
119	0	Synth Drum	1
	8	808 Tom	1
	9	Elec Perc.	1
120	0	Reverse Cym.	1

**GUITAR BASS FX**

121	0	Gt.FretNoise	1
	1	Gt.Cut Noise	1
	64	Wah Brush Gt	1
	65	Gt. Slide	1
	66	Gt. Scratch	1
	67	Bass Slide	1

**SFX**

122	0	Breath Noise	1
	1	Fl.Key Click	1
123	0	Seashore	1
	1	Rain	1
	2	Thunder	1
	3	Wind	1
	5	Bubble	2
124	0	Bird	2
	1	Dog	1
	3	Bird 2	1
125	0	Telephone 1	1
	1	Telephone 2	1
	3	Door	1
	5	Wind Chimes	2
126	0	Helicopter	1
	2	Car-Stop	1
	9	Burst Noise	2
	64	Space Tri.	1
127	0	Applause	2
	3	Punch	1
128	0	Gun Shot	1
	2	Lasergun	1
	3	Explosion	2

PC: Program Number  
(Instrument Number)

CC: Value of control change  
number 0

Voices: Number of voices used

**MEMO**

- To switch instruments from the external MIDI device, send "0" on the CC32# (Control Change Bank Select) from the external MIDI device to the TD-6.
- The value of the CC32# (Control Change Bank Select) that the TD-6 transmits is always "0."

# Preset Song List

No.	Name	Time Sig	Length	Tempo	Type
<b>DRUMS</b>					
1	DRUMS	4/4	8	124	LOOP
<b>ROCK</b>					
2	8BT'ROK1	4/4	36	114	1SHOT
3	8BT'ROK2	4/4	30	140	1SHOT
4	MED ROK	4/4	24	109	1SHOT
5	SHFL ROK	4/4	26	126	1SHOT
6	FUNK ROK	4/4	32	100	1SHOT
7	SLOW ROK	4/4	20	72	1SHOT
8	URBAN	4/4	29	113	1SHOT
9	UPBEAT	4/4	33	100	1SHOT
10	TRIPLETS	4/4	35	105	1SHOT
11	16BT'ROK	4/4	31	86	1SHOT
12	CYBER	4/4	30	129	1SHOT
13	HARDROCK	4/4	22	195	1SHOT
14	FNKYHR	4/4	20	100	1SHOT
15	BOOGIE	4/4	48	216	1SHOT
16	HARD POP	4/4	38	175	1SHOT
<b>METAL</b>					
17	EARLYMTL	4/4	24	120	1SHOT
18	SPEED1	4/4	27	182	1SHOT
19	SPEED2	4/4	41	236	1SHOT
20	THRASH	4/4	32	195	1SHOT
<b>BALLAD</b>					
21	6/8BLD	6/8	28	50	1SHOT
22	POPBLD	4/4	24	65	1SHOT
23	ROCK BLD	4/4	24	64	1SHOT
24	PIANOBLD	4/4	15	65	1SHOT
25	16BT'BLD	4/4	29	75	1SHOT
<b>R&amp;B</b>					
26	OLD R&B1	4/4	27	154	1SHOT
27	OLD R&B2	4/4	28	148	1SHOT
28	OLD R&B3	4/4	25	150	1SHOT
29	OLD R&B4	4/4	22	82	1SHOT
30	R&B SHFL	4/4	23	112	1SHOT
31	R&B HOP1	4/4	35	96	1SHOT
32	R&B HOP2	4/4	42	93	1SHOT
33	SMTH GRV	4/4	24	73	1SHOT
34	SHFL GRV	4/4	26	96	1SHOT

No.	Name	Time Sig	Length	Tempo	Type
<b>BLUES</b>					
35	BLUES1	4/4	30	67	1SHOT
36	BLUES2	4/4	36	113	1SHOT
37	BLUES3	4/4	21	55	1SHOT
<b>POPS</b>					
38	BGM POP	4/4	27	88	1SHOT
39	REFRESH	4/4	25	89	1SHOT
40	DANCEPOP	4/4	25	120	1SHOT
41	POP ROCK	4/4	38	123	1SHOT
42	ACOUSPOP	4/4	20	89	1SHOT
43	70'S POP	4/4	32	215	1SHOT
44	ELEC POP	4/4	21	100	1SHOT
45	POP WLTZ	3/4	26	120	1SHOT
<b>R&amp;R</b>					
46	ROCKABLY	4/4	21	96	1SHOT
47	ROCKIN'	4/4	32	170	1SHOT
48	SURF ROK	4/4	24	150	1SHOT
<b>COUNTRY</b>					
49	BLUEGRSS	4/4	22	142	1SHOT
50	CNTRYBLD	4/4	36	105	1SHOT
51	CNTRYROK	4/4	37	125	1SHOT
<b>JAZZ</b>					
52	SWING1	4/4	39	200	1SHOT
53	SWING2	4/4	37	192	1SHOT
54	JAZZ WLZ	3/4	51	110	1SHOT
55	JAZZ BLD	4/4	42	110	1SHOT
56	LATINJAZ	4/4	37	167	1SHOT
57	6/8 JAZZ	6/8	35	93	1SHOT
58	SMTHJAZZ	4/4	39	183	1SHOT
59	BIGBAND	4/4	32	130	1SHOT
<b>FUSION</b>					
60	ACID FS	4/4	29	96	1SHOT
61	SLOW FS	4/4	22	85	1SHOT
62	MED SHFL	4/4	27	86	1SHOT
63	UP SHFL	4/4	37	130	1SHOT
64	FUNK FS1	4/4	41	120	1SHOT
65	FUNK FS2	4/4	24	112	1SHOT
66	3/4 FS	3/4	46	123	1SHOT
67	BGM FS	4/4	25	82	1SHOT
68	CTMP'FS	4/4	25	100	1SHOT



No.	Name	Time Sig	Length	Tempo	Type
<b>DANCE</b>					
69	HIPHOP	4/4	37	90	1SHOT
70	EUROBEAT	4/4	35	132	1SHOT
71	HOUSE	4/4	34	122	1SHOT
72	FUNK1	4/4	24	105	1SHOT
73	FUNK2	4/4	23	113	1SHOT
74	FUNK3	4/4	25	102	1SHOT
75	808HPHOP	4/4	20	102	1SHOT
76	JAZZFUNK	4/4	24	125	1SHOT
77	ACIDFUNK	4/4	24	86	1SHOT
78	HPHPJAZZ	4/4	24	96	1SHOT
79	TEKPOP	4/4	23	118	1SHOT
80	DRUM'NBS	4/4	24	82	1SHOT
<b>REGGAE</b>					
81	REGGAE1	4/4	22	96	1SHOT
82	REGGAE2	4/4	29	142	1SHOT
83	REGGAE3	4/4	20	132	1SHOT
84	REGGAE4	4/4	24	125	1SHOT
85	SKA	4/4	27	192	1SHOT
<b>LATIN</b>					
86	LATIN1	4/4	41	120	1SHOT
87	LATIN2	4/4	41	108	1SHOT
88	LATIN3	4/4	33	130	1SHOT
89	MAMBO	4/4	36	182	1SHOT
90	MERENGUE	4/4	36	207	1SHOT
91	SALSA1	4/4	30	115	1SHOT
92	SALSA2	4/4	25	102	1SHOT
93	SALSA3	4/4	47	165	1SHOT
94	SONGO	4/4	24	109	1SHOT
95	TJANO	4/4	24	89	1SHOT
<b>BRAZIL</b>					
96	BOSSA	4/4	27	85	1SHOT
97	SAMBA1	4/4	20	152	1SHOT
98	SAMBA2	4/4	28	136	1SHOT
<b>BASICPTN</b>					
99	8BEAT1	4/4	8	118	LOOP
100	8BEAT2	4/4	16	140	LOOP
101	8BEAT3	4/4	8	113	LOOP
102	SHUFFL1	4/4	8	120	LOOP
103	SHUFFL2	4/4	8	108	LOOP
104	16BEAT1	4/4	4	120	LOOP
105	16BEAT2	4/4	4	112	LOOP
106	SLOW	4/4	8	64	LOOP
107	FUNK	4/4	8	106	LOOP
108	BLUES	4/4	12	120	LOOP
109	DIXIE	4/4	8	162	LOOP
110	BOSSA BT	4/4	4	120	LOOP

No.	Name	Time Sig	Length	Tempo	Type
<b>LOOP</b>					
111	LATN PTN	4/4	2	120	LOOP
112	CLAVES	4/4	1	120	LOOP
113	TABLA	4/4	2	128	LOOP
<b>1SHOT</b>					
114	DRUMFILL	4/4	1	120	1SHOT
115	DBL BASS	4/4	1	130	1SHOT
116	ROLL T1	4/4	1	130	1SHOT
117	ROLL T2	4/4	1	130	1SHOT
118	ROLL T3	4/4	1	130	1SHOT
119	LATNFILL	4/4	2	120	1SHOT
120	ROLLBNGO	4/4	1	117	1SHOT
121	SPANISH	4/4	2	123	1SHOT
122	BRS FALL	4/4	1	120	1SHOT
123	ENCORE	4/4	7	120	1SHOT
<b>TAP</b>					
124	SAMBA	4/4	1	120	TAP
125	ACO BASS	4/4	4	160	TAP
126	BRS SECT	4/4	5	160	TAP
127	GRV BASS	4/4	2	120	TAP
128	GRV PAD	4/4	2	120	TAP
129	GRV CHRDR	4/4	1	120	TAP
130	ADLBSOLO	4/4	16	120	TAP
131	JAZZEND1	4/4	6	60	TAP
132	JAZZEND2	4/4	4	100	TAP
133	FUNK BRK	4/4	1	130	TAP
134	FUNKEND1	4/4	2	130	TAP
135	FUNKEND2	4/4	3	130	TAP
136	SANTUR	4/4	3	128	TAP
137	STRINGS	4/4	8	128	TAP
138	RESOBASS	4/4	2	120	TAP
139	SYNCHRD1	4/4	3	120	TAP
140	SYNCHRD2	4/4	3	120	TAP
141	GTRCHRD1	4/4	1	120	TAP
142	GTRCHRD2	4/4	1	120	TAP
143	PAD&BASS	4/4	8	80	TAP
144	ACO GTR	4/4	6	86	TAP
145	WAH GTR	4/4	1	120	TAP
146	CUT GTR	4/4	1	120	TAP
147	VOICES	4/4	2	120	TAP
148	ANLGPERC	4/4	1	120	TAP
149	SFX TAP	4/4	5	120	TAP
150	CAR CELL	4/4	3	120	TAP

# Parameter List

## Drum Kit Parameters

### KIT

Parameter		Value
Drum Kit (p. 57)	Drum Kit	1-99

### KIT/INST

Parameter		Value
Inst (p. 60)	Instrument	1-1024
Inst Group (p. 59)	Instrument Group	KICK, SNARE, TOM, HI-HAT, CRASH, RIDE, PERC, SPECIAL, MELODIC, VOICES, REVERSE, FIXED HI-HAT, OFF
Level (p. 61)	Level	0-127
Pan (p. 61)	Pan	L15-CENTER-R15, RANDOM, ALTERNATE
Pitch (p. 61)	Pitch	-480+480
Decay (p. 61)	Decay	-31+31

### KIT/AMBIENCE

Parameter		Value
Ambience Sw (p. 62)	Ambience Switch	OFF, ON
AmbSendLevel (p. 62)	Ambience Send Level	0-127
Studio (p. 62)	Studio Type	LIVING, BATHROOM, STUDIO, GARAGE, LOCKER, THEATER, CAVE, GYM, STADIUM
WallType (p. 63)	Wall Type	WOOD, PLASTER, GLASS
Room Size (p. 63)	Room Size	SMALL, MEDIUM, LARGE
Amb Level (p. 63)	Ambience Level	0-127

### KIT/EQUALIZER

Parameter		Value
Master EQ Sw (p. 64)	Master Equalizer Switch	OFF, ON
High Gain (p. 64)	High Gain	-12dB+12dB
Low Gain (p. 64)	Low Gain	-12dB+12dB

### KIT/CONTROL

Parameter		Value	
Pad Ptn (p. 65)	Pad Pattern	OFF, 1-250	+
Pad Ptn Velo (p. 65)	Pad Pattern Velocity	OFF, ON	+
Pitch Ctrl (p. 66)	Pitch Control Assign	OFF, ON	
Note No. (p. 66)	Note Number	0 (C -)-127 (G 9)	+
Gate Time (p. 67)	Gate Time	0.1sec-8.0sec (0.1 sec steps)	+

+: This setting cannot be made in GM mode.

### KIT/COMMON

Parameter		Value
MasterVolume (p. 68)	Master Volume	0-127
Pedal HH Vol (p. 68)	Pedal Hi-Hat Volume	0-15
PchCtrlRange (p. 68)	Pitch Control Range	-24+24
KitName (p. 69)	Drum Kit Name	8 characters (*1)

\*1: ABCDEFGHIJKLMNOPQRSTUVWXYZ abcdefghijklmnopqrstuvwxyz  
 0123456789 !#\$%&'()\*+,-\*/=<>()[]{}.,:;?@#++| space

## KIT/COPY

Parameter		Value
Src (p. 69)	Copy Source	P01-P99, U01-U99
Dst (p. 69)	Copy Destination	U01-U99

## KIT/EXCHANGE

Parameter		Value
Src (p. 70)	Exchange Source	P01-P99, U01-U99
Dst (p. 70)	Exchange Destination	U01-U99

## Song Parameters

## SONG

Parameter		Value
Song (p. 84)	Song	1-250 +
Song Category (p. 84)	Song Category	DRUMS, ROCK, METAL, BALLAD, R&B, BLUES, POPS, R&R, COUNTRY, JAZZ, FUSION, DANCE, REGGAE, LATIN, BRAZIL, BASICPTN, LOOP, 1SHOT, TAP, USER +

+: This setting cannot be made in GM mode.

## SONG/COMMON

Parameter		Value
Tempo (p. 86)	Tempo	20-260 +
Play Type (p. 86)	Play Type	LOOP, 1SHOT, TAP +
Quick Play (p. 87)	Quick Play	OFF, ON +
Reset Time (p. 87)	Reset Time	OFF, 0.1s-8.0s (0.1 sec steps) +
Tap Exc Sw (p. 87)	Tap Exclusive Switch	OFF, ON +
Song Lock (p. 87)	Song Lock	OFF, ON #
SngName (p. 88)	Song Name	8 characters (*1) #

+: This setting cannot be made in GM mode.

#: This setting cannot be made when the preset song is selected.

\*1: ABCDEFGHIJKLMNOPQRSTUVWXYZ abcdefghijklmnopqrstuvwxyz  
0123456789 !"#%&'()\*+,-\*/=<>()[]{}.,:;?@#\*+! space

## SONG/PART:Perc

Parameter		Value
Set (p. 89)	Percussion Set	1-10 +
Level (p. 89)	Level	0-127 +
AmbSendLevel (p. 90)	Ambience Send Level	0-127 +

+: This setting cannot be made in GM mode.

## SONG/PART:Part1-Part4

Parameter		Value
Inst (p. 89)	Instrument	1-128 +
Level (p. 89)	Level	0-127 +
Pan (p. 90)	Pan	L15-CENTER-R15 +
AmbSendLevel (p. 90)	Ambience Send Level	0-127 +
Bend Range (p. 90)	Bend Range	0-24 +

+: This setting cannot be made in GM mode.

## Parameter List

### SONG/COPY

Parameter		Value	
Src (p. 90)	Copy Source	1–250	+
Dst (p. 90)	Copy Destination	151–250	+

+: This setting cannot be made in GM mode.

### SONG/DELETE

Parameter		Value	
Song (p. 91)	Delete Song	151–250	+

+: This setting cannot be made in GM mode.

### SONG/ERASE

Parameter		Value	
Song (p. 92)	Erase Song	151–250	+
Part (p. 92)	Erase Part	ALL, KIT, PERC, PART1, PART2, PART3, PART4	+

+: This setting cannot be made in GM mode.

## Setup Parameters

### SETUP/UTILITY

Parameter		Value	
LCD Contrast (p. 77)	LCD Contrast	1–16	
PercPrtLevel (p. 77)	Percussion Part Level	0–127	+
Backing Level (p. 78)	Backing Level	0–127	+
Mute (p. 78)	Mute	SongDrum, SongDrm/Prc, UserDrmPart, Part1, Part2, Part3, Part4, Part1-4	+
Master Tune (p. 78)	Master Tune	415.3–466.2 (0.1 Hz steps)	
Preview Velo (p. 79)	Preview Velocity	0–127	
AvailMemory (p. 79)	Available Memory	0–100% (check only)	

+: This setting cannot be made in GM mode.

### SETUP/TRIG BASIC

Parameter		Value	
TrigTyp (p. 71)	Trigger Type	PD6, PD7/9, PD80/100, PD80R, PD120, KD7, KD Type, CY6, CY Type, Other 1, Other 2, AcDrTrig	
Secsitivity (p. 73)	Sensitivity	1–16	
Threshold (p. 73)	Threshold	0–15	
TrigCurve (p. 73)	Trigger Curve	LINEAR, EXP1, EXP2, LOG1, LOG2, SPLINE, LOUD1, LOUD2	
Xtalk Cancel (p. 74)	Crosstalk Cancel	OFF, 20–80 (5 steps)	

### SETUP/TRIG ADVNCD

Parameter		Value	
Scan Time (p. 75)	Scan Time	0–4.0ms (0.1 ms steps)	
Retrig Cancel (p. 75)	Retrigger Cancel	1–16	
Mask Time (p. 75)	Mask Time	0–64ms (4ms steps)	
Rim Sens (p. 76)	Rim Sensitivity	OFF, 1–15	

## SETUP/MIDI COMMON

Parameter		Value	
Note Chase (p. 98)	Note Chase	OFF, ON	
Local Control (p. 98)	Local Control	OFF, ON	+
Sync Mode (p. 98)	Sync Mode	INT, EXT, REMOTE	+
CH10Priority (p. 99)	Channel 10 Priority	KIT, PERC	+
PdldataThin (p. 99)	Pedal Data Thin	OFF, 1, 2	+
GM Mode (p. 100)	GM Mode	OFF, ON	
Rx GM ON (p. 100)	Rx GM On	OFF, ON	
Soft Thru (p. 101)	Soft Thru	OFF, ON	
Device ID (p. 101)	Device ID	1-32	
Tx PC Sw (p. 102)	Tx PC Switch	OFF, ON	+
Rx PC Sw (p. 102)	Rx PC Switch	OFF, ON	+

+: This setting cannot be made in GM mode.

## SETUP/MIDI PART

Parameter		Value	
KitPart CH (p. 102)	Drum Kit Part MIDI Channel	1-16, OFF	+
PercPart CH (p. 102)	Percussion Part MIDI Channel	1-16, OFF	+
Part1 CH (p. 102)	Part 1 MIDI Channel	1-16, OFF	+
Part2 CH (p. 102)	Part 2 MIDI Channel	1-16, OFF	+
Part3 CH (p. 102)	Part 3 MIDI Channel	1-16, OFF	+
Part4 CH (p. 102)	Part 4 MIDI Channel	1-16, OFF	+

+: This setting cannot be made in GM mode.

## SETUP/GM PART

Parameter		Value	
Part1 Rx Sw (p. 103)	Part 1 Rx Switch	OFF, ON	-
Part2 Rx Sw (p. 103)	Part 2 Rx Switch	OFF, ON	-
Part3 Rx Sw (p. 103)	Part 3 Rx Switch	OFF, ON	-
Part4 Rx Sw (p. 103)	Part 4 Rx Switch	OFF, ON	-
Part5 Rx Sw (p. 103)	Part 5 Rx Switch	OFF, ON	-
Part6 Rx Sw (p. 103)	Part 6 Rx Switch	OFF, ON	-
Part7 Rx Sw (p. 103)	Part 7 Rx Switch	OFF, ON	-
Part8 Rx Sw (p. 103)	Part 8 Rx Switch	OFF, ON	-
Part9 Rx Sw (p. 103)	Part 9 Rx Switch	OFF, ON	-
Part10 Rx Sw (p. 103)	Part 10 Rx Switch	OFF, ON	-
Part11 Rx Sw (p. 103)	Part 11 Rx Switch	OFF, ON	-
Part12 Rx Sw (p. 103)	Part 12 Rx Switch	OFF, ON	-
Part13 Rx Sw (p. 103)	Part 13 Rx Switch	OFF, ON	-
Part14 Rx Sw (p. 103)	Part 14 Rx Switch	OFF, ON	-
Part15 Rx Sw (p. 103)	Part 15 Rx Switch	OFF, ON	-
Part16 Rx Sw (p. 103)	Part 16 Rx Switch	OFF, ON	-

-: This setting can be made in GM mode only.

## SETUP/BULK DUMP

Parameter		Value
Bulk Dump (p. 103)	Bulk Dump	ALL, SETUP, ALL SONGS, ALL KITS, KIT 01-KIT 99

## SETUP/FactoryReset

Parameter		Value
Reset (p. 79)	Factory Reset	ALL, THIS DRUM KIT, ALL DRUM KITS, ALL SONGS

## Click Parameters

### CLICK

Parameter		Value	
Click Level (p. 80)	Click Level	0-127	+
Time Sig (p. 81)	Time Signature	0-13/2, 0-13/4, 0-13/8, 0-13/16	+
Interval (p. 81)	Interval	1/2, 3/8, 1/4, 4/8, 1/12, 1/16	+
Inst (p. 81)	Inst	VOICE, CLICK, BEEP, METRONOME, CLAVES, WOOD BLOCK, STICKS, CROSS STICK, TRIANGLE, COWBELL, CONGA, TALKING DRM, MARACAS, CABASA, CUICA, AGOGO, TAMBOURINE, SNAPS, 909 SNARE, 808 COWBELL	+
Pan (p. 81)	Pan	L15-CENTER-R15	+
PlyCountIn (p. 81)	Play Count In	OFF, 1MEAS, 2MEAS	+
RecCountIn (p. 81)	Recording Count In	OFF, 1MEAS, 2MEAS	+

+: This setting cannot be made in GM mode.

## Song Recording

### Recording Standby

Parameter		Value	
Time Sig (p. 94)	Time Signature	1-13/2, 1-13/4, 1-13/8, 1-13/16	+
Length (p. 94)	Length	1-999	+
Tempo (p. 94)	Tempo	20-260	+
Quantize (p. 95)	Quantize	♪ 8 (8th note), ♪ 8T (8th note triplets), ♪ 16 (16th note), ♪ 16T (16th note triplets), ♪ 32 (32nd note), ♪ 32T (32nd note triplets), ♪ 64 (64th note), OFF	+
Rec Mode (p. 95)	Recording Mode	REPLACE, LOOP ALL, LOOP 1, LOOP 2	+
HitPadStart (p. 95)	Hit Pad Start	OFF, ON	+

+: This setting cannot be made in GM mode.

## Tempo

### Tempo

Parameter		Value	
Tempo (p. 80, p. 86)	Tempo	20-260	+

+: This setting cannot be made in GM mode.

# MIDI Implementation

Model TD-6

Version 1.00 Feb. 13, 2001

## ◆ Normal mode

### Section 1. Receive data

#### ■ Channel Voice Messages

\* Following Channel Voice Messages can be recorded in SETUP/MIDI PART/Part CH.

#### ● Note Off

Status	2nd byte	3rd byte
8nH	kkH	vvH
9nH	kkH	00H

n = MIDI channel number: 0H - FH (ch.1 - ch.16)  
 kk = note number: 00H - 7FH (0 - 127)  
 vv = note off velocity: 00H - 7FH (0 - 127)

- \* Only the channel assigned to the backing part can be received.
- \* The Velocity Values of Note Off message are ignored.
- \* When recording, this is recorded in the sequencer data itself.

#### ● Note On

Status	2nd byte	3rd byte
9nH	kkH	vvH

n = MIDI channel number: 0H - FH (ch.1 - ch.16)  
 kk = note number: 00H - 7FH (0 - 127)  
 vv = note on velocity: 00H - 7FH (0 - 127)

- \* A channel which is assigned to the drum kit part will receive only the note numbers which are specified by the drum kit.
- \* A channel which is assigned to the percussion part will receive only the note numbers which are specified by the percussion set.
- \* When recording, this is recorded in the sequencer data itself.

#### ● Polyphonic Key Pressure

Status	2nd byte	3rd byte
AnH	kkH	vvH

n = MIDI channel number: 0H - FH (ch.1 - ch.16)  
 kk = note number: 00H - 7FH (0 - 127)  
 vv = Value: 00H - 7FH (0 - 127)

- \* A channel which is assigned to the drum kit part will receive only the note numbers which are specified by the drum kit.
- \* If the value is greater than 40H (64), the decay of the note sounded by the received note number will be shortened.
- \* Not recorded in the sequencer.

#### ● Control Change

##### ○ Bank Select (Controller number 0, 32)

Status	2nd byte	3rd byte
BnH	00H	mmH
BnH	20H	llH

n = MIDI channel number: 0H - FH (ch.1 - ch.16)  
 mm = Bank number MSB: 00H - 7FH (bank.1 - bank.128)  
 ll = Bank number LSB: processed as 00H

- \* Not Received when SETUP/MIDI COMMON/Rx PC Sw is set to "OFF".(Initial Value is ON)
- \* Bank select processing will be suspended until a program change message is received.
- \* Only the channel assigned to the backing part can be received.
- \* Not recorded in the sequencer.

##### ○ Foot Control (Controller number 4)

Status	2nd byte	3rd byte
BnH	04H	vvH

n = MIDI channel number: 0H - FH (ch.1 - ch.16)  
 vv = Control value: 00H - 7FH (0 - 127)

- \* Only the channel assigned to the drum kit part can be received.
- \* When recording, this will be recorded as PEDAL CC data in the sequencer data itself.

##### ○ Data Entry (Controller number 6)

Status	2nd byte	3rd byte
BnH	06H	mmH

n = MIDI channel number: 0H - FH (ch.1 - ch.16)  
 mm = The value of the parameter specified by RPN.

- \* Only the channel assigned to the backing part can be received.
- \* Not recorded in the sequencer.

On the normal mode of TD-6, RPN can be used to modify the following parameters.

RPN	Data entry	Explanation
MSB LSB 00H 00H	MSB LSB mmH ---	Pitch Bend Sensitivity mm: 00H - 18H (0 - 24 semitones) LSB: ignored (processed as 00H) specify up to 2 octaves in semitone steps
7FH 7FH	---	RPN null set condition where RPN is unspecified. The data entry messages after set RPN null will be ignored.(No Data entry messages are required after RPN null). Settings already made will not change. MSB,LSB of data entry:ignored

##### ○ Volume (Controller number 7)

Status	2nd byte	3rd byte
BnH	07H	vvH

n = MIDI channel number: 0H - FH (ch.1 - ch.16)  
 vv = Volume: 00H - 7FH (0 - 127)

- \* Volume messages are used to adjust the volume balance of each part.
- \* Only the channel assigned to the percussion part and the backing part can be received.
- \* Not recorded in the sequencer.

##### ○ Pan (Controller number 10)

Status	2nd byte	3rd byte
BnH	0AH	vvH

n = MIDI channel number: 0H - FH (ch.1 - ch.16)  
 vv = Pan: 00H - 40H - 7FH (Left - Center - Right)

- \* Only the channel assigned to the backing part can be received.
- \* Not recorded in the sequencer.

##### ○ Hold 1 (Controller number 64)

Status	2nd byte	3rd byte
BnH	40H	vvH

n = MIDI channel number: 0H - FH (ch.1 - ch.16)  
 vv = Control value: 00H - 7FH (0 - 127) 0-63 = OFF, 64-127 = ON

- \* Only the channel assigned to the backing part can be received.
- \* When recording, this is recorded in the sequencer data itself.

# MIDI Implementation

## ○ Effect 1(Reverb Send Level) (Controller number 91)

Status	2nd byte	3rd byte
BnH	5BH	vvH

n = MIDI channel number: 0H - FH (ch.1 - ch.16)  
 vv = Reverb send level: 00H - 7FH (0 - 127)

- \* Only the channel assigned to the backing part can be received.
- \* When recording, this is recorded in the sequencer data itself.

## ○ RPN MSB/LSB (Controller number 101, 100)

Status	2nd byte	3rd byte
BnH	65H	mmH
BnH	64H	llH

n = MIDI channel number: 0H - FH (ch.1 - ch.16)  
 mm = upper byte of parameter number specified by RPN (MSB)  
 ll = lower byte of parameter number specified by RPN (LSB)

- \* Only the channel assigned to the backing part can be received.
- \* The value specified by RPN will not be reset even by messages such as program change or reset all controllers.
- \* When recording, this is recorded in the sequencer data itself.

\*\*RPN\*\*

The RPN (Registered Parameter Number) messages are expanded control changes, and each function of an RPN is described by the MIDI Standard. To use these messages, you must first use RPN (controller number 100 and 110, their order does not matter) to specify the parameter to be controlled, and then use Data Entry messages (controller number 6, 38) to specify the value of the specified parameter. Once an RPN parameter has been specified, all data entry messages received on that channel will modify the value of that parameter. To prevent accidents, it is recommended that you set RPN null (RPN number = 7FH 7FH) when you have finished setting the value of the desired parameter. Refer to "Examples of actual MIDI messages" <Example 4> (page 146).

On the normal mode of TD-6, RPN can be used to modify the following parameters. Regarding the value of each parameter, refer to Data Entry (Controller number 6).

RPN	ll	Parameter
00H	00H	Pitch Bend Sensitivity
7FH	7FH	RPN null

## ● Program Change

Status	2nd byte
CnH	ppH

n = MIDI channel number: 0H - FH (ch.1 - ch.16)  
 pp = Program number: 00H - 7FH (prog.1 - prog.128)

- \* Not Received when SETUP/MIDI COMMON/Rx PC Sw is set to "OFF". (Initial Value is ON)
- \* The sound will change beginning with the next note-on after the program change is received. Voices which were already sounding before the program change was received will not be affected.
- \* Not recorded in the sequencer.

## ● Pitch Bend Change

Status	2nd byte	3rd byte
EnH	llH	mmH

n = MIDI channel number: 0H - FH (ch.1 - ch.16)  
 mm, ll = Pitch Bend value: 00 00H - 40 00H - 7F 7FH (-8192 - 0 - +8191)

- \* Only the channel assigned to the backing part can be received.
- \* When recording, this is recorded in the sequencer data itself.

## ■ Channel Mode Messages

### ● All Sounds Off (Controller number 120)

Status	2nd byte	3rd byte
BnH	78H	00H

n = MIDI channel number: 0H - FH (ch.1 - ch.16)

- \* When this message is received, all currently-sounding notes on the corresponding channel will be silenced. However, the status of channel messages will not change.
- \* When recording, this is recorded in the sequencer data itself.

### ● Reset All Controllers (Controller number 121)

Status	2nd byte	3rd byte
BnH	79H	00H

n = MIDI channel number: 0H - FH (ch.1 - ch.16)

- \* When this message is received, the following controllers will be set to their reset values.
- \* When recording, a control message carrying the reset value will be created and recorded.

Controller	Reset value
Pitch Bend Change	+/-0 (center)
Polyphonic Key Pressure	0 (off)
Foot Control	0 (off)
Hold 1	0 (off)
RPN	unset; previously set data will not change

### ● All Notes Off (Controller number 123)

Status	2nd byte	3rd byte
BnH	7BH	00H

n = MIDI channel number: 0H - FH (ch.1 - ch.16)

- \* When All Notes Off is received, all notes on the corresponding channel will be turned off. However if Hold 1 is ON, the sound will be continued until these are turned off.
- \* In the recording mode, Note OFF message will be created for corresponding Note ON message, and will be recorded.

### ● OMNI OFF (Controller number 124)

Status	2nd byte	3rd byte
BnH	7CH	00H

n = MIDI channel number: 0H - FH (ch.1 - ch.16)

- \* The same processing will be carried out as when All Notes Off is received.

### ● OMNI ON (Controller number 125)

Status	2nd byte	3rd byte
BnH	7DH	00H

n = MIDI channel number: 0H - FH (ch.1 - ch.16)

- \* The same processing will be carried out as when All Notes Off is received.

### ● MONO (Controller number 126)

Status	2nd byte	3rd byte
BnH	7EH	mmH

n = MIDI channel number: 0H - FH (ch.1 - ch.16)  
 mm = mono number: 00H - 10H (0 - 16)

- \* The same processing will be carried out as when All Sound Off or All Notes Off is received.



● POLY (Controller number 127)

Status	2nd byte	3rd byte
BnH	7FH	00H

n = MIDI channel number:0H - FH (ch.1 - ch.16)

\* The same processing will be carried out as when All Sound Off or All Notes Off is received.

■ System Realtime Message

\* Following System Realtime Messages cannot be recorded in recording mode.

● Timing Clock

Status
F8H

\* Recognized only when the SETUP/MIDI COMMON/Sync Mode is set to "EXT".

● Start

Status
FAH

\* Recognized only when the SETUP/MIDI COMMON/Sync Mode is set to "EXT" or "REMOTE".

● Continue

Status
FBH

\* Recognized only when the SETUP/MIDI COMMON/Sync Mode is set to "EXT" or "REMOTE".

● Stop

Status
FCH

\* Recognized only when the SETUP/MIDI COMMON/Sync Mode is set to "EXT" or "REMOTE".

● Active Sensing

Status
FEH

\* When Active Sensing is received, the unit will begin monitoring the intervals of all further messages. While monitoring, if the interval between messages exceeds about 420 ms, the same processing will be carried out as when All Sounds Off, All Notes Off and Reset All Controllers are received, and message interval monitoring will be halted.

■ System Exclusive Message

\* Following System Exclusive Messages cannot be recorded.

Status	Data byte	Status
F0H	iiH, ddH, ....., eeH	F7H
F0H:	System Exclusive Message status	
ii = ID number:	an ID number (manufacturer ID) to indicate the manufacturer whose Exclusive message this is. Roland's manufacturer ID is 41H.	
	ID numbers 7EH and 7FH are extensions of the MIDI standard; Universal Non-realtime Messages (7EH) and Universal Realtime Messages (7FH).	
dd,...., ee = data:	00H - 7FH (0 - 127)	
F7H:	EOX (End Of Exclusive)	

The System Exclusive Messages received by the normal mode of TD-6 are; Universal Non-realtime System Exclusive Messages, Data Requests (RQ1), and Data Set (DT1).

● System Exclusive Message

○ Turn General MIDI System On

This is a command message that resets the internal settings of the unit to the General MIDI initial state (General MIDI System - Level 1). After receiving this message, this unit will automatically be set to the proper condition for correctly playing a General MIDI score.

Status	Data byte	Status
F0H	7EH, 7FH, 09H, 01H	F7H

Byte	Explanation
F0H	Exclusive status
7EH	ID number (Universal Non-realtime Message)
7FH	Device ID (Broadcast)
09H	Sub ID#1 (General MIDI Message)
01H	Sub ID#2 (General MIDI 1 On)
F7H	EOX (End Of Exclusive)

\* Not Received when SETUP/MIDI COMMON/Rx GM ON is set to "OFF".(Initial Value is ON)

\* There must be an interval of at least 50 ms between this message and the next.

● Universal Non-realtime System Exclusive Messages

○ Identity Request

Status	Data byte	Status
F0H	7EH, dev, 06H, 01H	F7H

Byte	Explanation
F0H	Exclusive status
7EH	ID number (universal non-realtime message)
dev	Device ID (dev:00H - 1FH (1 - 32) Initial value is 10H (17))
06H, 01H	Identity request
F7H	EOX (End Of Exclusive)

\* Even if the Device ID is 7FH (Broadcast), Identity reply message will be transmitted.

\* When Identity Request is received, Identity reply message will be transmitted (page 139).

● Data transmission

TD-6 can transmit and receive the various parameters using System Exclusive messages.

The exclusive message of TD-6s data has a model ID of 00H 3FH and a device ID of 10H (17). Device ID can be changed in TD-6.'

○ Request data 1 RQ1 (11H)

This message requests the other device to send data. The Address and Size determine the type and amount of data to be sent.

When a Data Request message is received, if the device is ready to transmit data and if the address and size are appropriate, the requested data will be transmitted as a "Data Set 1 (DT1)" message. If not, nothing will be transmitted.

Status	Data byte	Status
F0H	41H, dev, 00H, 3FH, 11H, aaH, bbH, ccH, ddH, ssH, ttH, uuH, vvH, sum	F7H

Byte	Explanation
F0H	Exclusive status
41H	ID number (Roland)
dev	Device ID (dev: 00H - 1FH (1 - 32) Initial value is 10H (17))
00H 3FH	Model ID (TD-6)
11H	Command ID (RQ1)
aaH	Address MSB: upper byte of the starting address of the requested data
bbH	Address 2nd: 2nd byte of the starting address of the requested data

# MIDI Implementation

ccH	Address 3rd: 3rd byte of the starting address of the requested data
ddH	Address LSB: lower byte of the starting address of the requested data
ssH	Size MSB
ttH	Size 2nd
uuH	Size 3rd
vvH	Size LSB
sum	Checksum
F7H	EOX (End Of Exclusive)

- \* The amount of data that can be transmitted at once time will depend on the type of data, and data must be requested using a specific starting address and size. Refer to the Address and Size listed in "Parameter Dump Request" (page 145).
- \* Regarding the checksum please refer to page 146.

## ○ Data set 1 DT1 (12H)

This is the message that actually performs data transmission, and is used when you wish to transmit the data.

Status	Data byte	Status
F0H	41H, dev, 00H, 3FH, 12H, aaH, bbH, ccH, ddH, eeH,... ffH, sum	F7H
Byte	Explanation	
F0H	Exclusive status	
41H	ID number (Roland)	
dev	Device ID (dev: 00H - 1FH (1 - 32) Initial value is 10H (17))	
00H 3FH	Model ID (TD-6)	
12H	Command ID (DT1)	
aaH	Address MSB: upper byte of the starting address of the transmitted data	
bbH	Address 2nd : 2nd byte of the starting address of the transmitted data	
ccH	Address 3rd: 3rd byte of the starting address of the transmitted data	
ddH	Address LSB: lower byte of the starting address of the transmitted data	
eeH	Data: the actual data to be transmitted. Multiple bytes of data are transmitted starting from the address.	
:	:	
ffH	Data	
sum	Checksum	
F7H	EOX (End Of Exclusive)	

- \* The amount of data that can be transmitted at once time will depend on the type of data, and data must be requested using a specific starting address and size. Refer to the Address and Size listed in "Parameter Dump Request" (page 145).
- \* If "Data Set 1" is transmitted successively, there must be an interval of at least 40 ms.
- \* Regarding the checksum please refer to page 146.

## Section 2. Transmit data

- \* When SETUP/MIDI COMMON/Soft Thru is set to "ON", messages received in addition to the following messages are also sent.

### ■ Channel Voice Messages

- \* The following channel voice messages are transmitted on the channel specified as the SETUP/MIDI PART/Part CH.

#### ● Note off

Status	2nd byte	3rd byte
8nH	kkH	vvH
n = MIDI channel number:	0H - FH (ch.1 - ch.16)	
kk = note number:	00H - 7FH (0 - 127)	
vv = Note off velocity:	40H (64) fixed	

#### ● Note on

Status	2nd byte	3rd byte
9nH	kkH	vvH
n = MIDI channel number:	0H - FH (ch.1 - ch.16)	
kk = note number:	00H - 7FH (0 - 127)	
vv = note on velocity:	01H - 7FH (1 - 127)	

- \* On the channel assigned to the drum kit part, the note numbers specified by the drum kit will be transmitted.
- \* On the channel assigned to the percussion part, the note numbers specified by the percussion set will be transmitted.

#### ● Polyphonic Key Pressure

Status	2nd byte	3rd byte
AnH	kkH	vvH
n = MIDI channel number:	0H - FH (ch.1 - ch.16)	
kk = note number:	00H - 7FH (0 - 127)	
vv = value:	00H, 7FH (0, 127)	

- \* On the channel assigned to the drum part, 7FH will be transmitted when the rim of the pad is pressed and 00H when the rim is released, for the note number specified for the head and rim.

#### ● Control Change

##### ○ Bank Select (Controller number 0, 32)

Status	2nd byte	3rd byte
BnH	00H	mmH
BnH	20H	llH
n = MIDI channel number:	0H - FH (ch.1 - ch.16)	
mm = Bank number MSB:	00H - 7FH (bank.1 - bank.128)	
ll = Bank number LSB:	processed as 00H	

- \* Not transmitted when SETUP/MIDI COMMON/Tx PC Sw is set to "OFF". (Initial Value is ON)
- \* Only the channel assigned to the backing part are sent.
- \* Bank selects corresponding to each parts instrument are sent when a song is selected. Also, when instruments are selected for parts, bank selects for the respective instruments are sent.

##### ○ Foot control (Controller number 4)

Status	2nd byte	3rd byte
BnH	04H	vvH
n = MIDI channel number:	0H - FH (ch.1 - ch.16)	
vv = Control value:	00H - 7FH (0 - 127)	

- \* This is transmitted only on the channel which is assigned to the drum kit part.

##### ○ Data Entry (Controller number 6)

Status	2nd byte	3rd byte
BnH	06H	mmH
n = MIDI channel number:	0H - FH (ch.1 - ch.16)	
mm = The value of the parameter specified by RPN.		

- \* Only the channel assigned to the backing part are sent.
- \* When a song is selected or adjust SONG/PART/Bend Range setting, the pitch bend sensitivity of the sequencer song data will be transmitted.

Values for the RPN parameter, on the normal mode of TD-6, are as follows.

RPN	Data entry	Explanation
MSB LSB	MSB LSB	
00H 00H	mmH ---	Pitch Bend Sensitivity mm: 00H - 18H (0 - 24 semitones)
7FH 7FH	--- ---	RPN null set condition where RPN is unspecified.

○ **Volume (Controller number 7)**

Status	2nd byte	3rd byte
BnH	07H	vvH

n = MIDI channel number: 0H - FH (ch.1 - ch.16)  
 vv = Volume: 00H - 7FH (0 - 127)

- \* Only the channel assigned to the percussion part and the backing part are sent.
- \* When a song is selected, the part level of the sequencer song data will be transmitted.

○ **Pan (Controller number 10)**

Status	2nd byte	3rd byte
BnH	0AH	vvH

n = MIDI channel number: 0H - FH (ch.1 - ch.16)  
 vv = Pan: 00H - 40H - 7FH (Left - Center - Right)

- \* Only the channel assigned to the backing part are sent.
- \* When a song is selected, the pan of the sequencer song data will be transmitted.

○ **Hold 1 (Controller number 64)**

Status	2nd byte	3rd byte
BnH	40H	vvH

n = MIDI channel number: 0H - FH (ch.1 - ch.16)  
 vv = Control value: 00H - 7FH (0 - 127) 0-63 = OFF 64-127 = ON

- \* Only the channel assigned to the backing part are sent.
- \* Transmitted only when the TD-6 is in play for song in which Hold 1 is recorded.

○ **Effect 1 (Reverb Send Level) (Controller number 91)**

Status	2nd byte	3rd byte
BnH	5BH	vvH

n = MIDI channel number: 0H - FH (ch.1 - ch.16)  
 vv = Reverb send level: 00H - 7FH (0 - 127)

- \* Only the channel assigned to the percussion part and backing part are sent.
- \* When a song is selected, the reverb send level of the sequencer song data will be transmitted.

○ **RPN MSB/LSB (Controller number 101,100)**

Status	2nd byte	3rd byte
BnH	65H	mmH
BnH	64H	llH

n = MIDI channel number: 0H - FH (ch.1 - ch.16)  
 mm = upper byte of parameter number specified by RPN (MSB)  
 ll = lower byte of parameter number specified by RPN (LSB)

- \* Only the channel assigned to the backing part are sent.
- \* When a song is selected, the pitch bend sensitivity of the sequencer song data will be transmitted.
- \* Regarding the RPN please refer to page 136.

Values for the RPN parameter, on the normal mode of TD-6, are as follows.  
 Regarding the value of each parameter, refer to Data Entry (Controller number 6).

RPN	mm	ll	Parameter
00H	00H		Pitch Bend Sensitivity
7FH	7FH		RPN null

● **Program Change**

Status	2nd byte
CnH	ppH

n = MIDI channel number: 0H - FH (ch.1 - ch.16)  
 pp = Program number: 00H - 7FH (prog.1 - prog.128)

- \* Not transmitted when SETUP/MIDI COMMON/Tx PC Sw is set to "OFF". (Initial Value is ON)
- \* Program changes corresponding to drum kit are sent when drum kits are selected.
- \* Program changes corresponding to each parts instrument are sent when a song

is selected. Also, when instruments are selected for parts, program changes for the respective instruments are sent.'

● **Pitch Bend Change**

Status	2nd byte	3rd byte
EnH	llH	mmH

n = MIDI channel number: 0H - FH (ch.1 - ch.16)  
 mm,ll = Pitch Bend value: 00 00H - 40 00H - 7F 7FH (-8192 - 0 - +8191)

- \* Only the channel assigned to the backing part are sent.
- \* Transmitted only when the TD-6 is in play for song in which pitch bend change is recorded.

■ **System Realtime Message**

● **Timing Clock**

Status
F8H

● **Start**

Status
FAH

● **Continue**

Status
FBH

● **Stop**

Status
FCH

● **Active sensing**

Status
FEH

- \* This will be transmitted constantly at intervals of approximately 250 ms.

■ **System Exclusive Messages**

- \* Regarding the system exclusive message refer to page 137.

Identity reply and Data Set 1 (DT1) are the only System Exclusive messages transmitted by TD-6.

When an appropriate Identity Request or Data Request 1 (RQ1) message is received, the requested internal data will be transmitted.

● **Universal Non-realtime System Exclusive Messages**

○ **Identity Reply**

Status	Data byte	Status
F0H	7EH, dev, 06H, 02H, 41H, 3FH,	F7H
	01H, 00H, 00H, 00H, 02H, 00H, 00H	

Byte	Explanation
F0H	Exclusive status
7EH	ID number (universal non-realtime message)
dev	Device ID (dev: 00H - 1FH (1 - 32) Initial value is 10H (17))
06H 02H	Identity Reply
41H	ID number (Roland)
3FH 01H	Device family code
00H 00H	Device family number code
00H 02H 00H 00H	software revision level
F7H	EOX (End Of Exclusive)

- \* When Identity Request (page 137) is received, Identity Reply message will be transmitted.

## ● Data Transmission

### ○ Data set 1 DT1 (12H)

Status	Data byte	Status
F0H	41H, dev, 00H, 3FH, 12H, aaH, bbH, ccH, ddH, eeH,... fFH, sum	F7H
Byte	Explanation	
F0H	Exclusive status	
41H	ID number (Roland)	
dev	Device ID (dev: 00H - 1FH (1 - 32) Initial value is 10H (17))	
00H 3FH	Model ID (TD-6)	
12H	Command ID (DT1)	
aaH	Address MSB: upper byte of the starting address of the data to be sent	
bbH	Address 2nd: 2nd byte of the starting address of the data to be sent	
ccH	Address 3rd: 3rd byte of the starting address of the data to be sent.	
ddH	Address LSB: lower byte of the starting address of the data to be sent.	
eeH	Data: the actual data to be sent. Multiple bytes of data are transmitted in order starting from the address.	
:	:	
ffH	Data	
sum	Checksum	
F7H	EOX (End Of Exclusive)	

- \* The amount of data that can be transmitted at once time will depend on the type of data, and data must be requested using a specific starting address and size. Refer to the Address and Size listed in "Parameter address map" (page 143).
- \* Data larger than 128 bytes must be divided into packets of 128 bytes or less. If "Data Set 1" is transmitted successively, there must be an interval of at least 40 ms between packets.
- \* Regarding the checksum please refer to page 146.

## ◆ GM mode

### Section 1. Receive data

#### ■ Channel Voice Messages

- \* The following Channel Voice messages can be received on channels for which the SETUP/GM PART/Part Rx Sw is set to "ON".

#### ● Note Off

Status	2nd byte	3rd byte
8nH	kkH	vvH
9nH	kkH	00H
n = MIDI channel number:	0H - FH (ch.1 - ch.16)	
kk = note number:	00H - 7FH (0 - 127)	
vv = note off velocity:	00H - 7FH (0 - 127)	

- \* In the rhythm part (ch.10), ignored this message.
- \* The Velocity Values of Note Off message are ignored.

#### ● Note On

Status	2nd byte	3rd byte
9nH	kkH	vvH
n = MIDI channel number:	0H - FH (ch.1 - ch.16)	
kk = note number:	00H - 7FH (0 - 127)	
vv = note on velocity:	00H - 7FH (0 - 127)	

## ● Control Change

### ○ Modulation (Controller number 1)

Status	2nd byte	3rd byte
BnH	01H	vvH
n = MIDI channel number:	0H - FH (ch.1 - ch.16)	
vv = Modulation depth:	00H - 7FH (0 - 127)	

- \* In the rhythm part (ch.10), ignored this message.

### ○ Data Entry (Controller number 6, 38)

Status	2nd byte	3rd byte
BnH	06H	mmH
BnH	26H	llH

n = MIDI channel number: 0H - FH (ch.1 - ch.16)  
 mm, ll = The value of the parameter specified by RPN.  
 mm = upper byte (MSB), ll = lower byte (LSB)

- \* In the rhythm part (ch.10), ignored this message.

On the GM mode of TD-6, RPN can be used to modify the following parameters.

RPN	Data entry	Explanation
MSB LSB	MSB LSB	
00H 00H	mmH ---	Pitch Bend Sensitivity mm: 00H - 18H (0 - 24 semitones) ll: ignored (processed as 00H) specify up to 2 octaves in semitone steps
00H 01H	mmH llH	Channel Fine Tuning mm,ll: 00 00H - 40 00H - 7F 7FH (-100 - 0 - +99.99 cents) Refer to "About tuning" (page 147).
00H 02H	mmH ---	Channel Coarse Tuning mm: 28H-40H-58H (-24 - 0 - +24 semitones) ll: ignored (processed as 00H)
7FH 7FH	--- ---	RPN null set condition where RPN is unspecified. The data entry messages after set RPN null will be ignored. (No Data entry messages are required after RPN null). Settings already made will not change. mm,ll: ignored

### ○ Volume (Controller number 7)

Status	2nd byte	3rd byte
BnH	07H	vvH
n = MIDI channel number:	0H - FH (ch.1 - ch.16)	
vv = Volume:	00H - 7FH (0 - 127)	

- \* Volume messages are used to adjust the volume balance of each part.

### ○ Pan (Controller number 10)

Status	2nd byte	3rd byte
BnH	0AH	vvH
n = MIDI channel number:	0H - FH (ch.1 - ch.16)	
vv = pan:	00H - 40H - 7FH (Left - Center - Right)	

- \* In the rhythm part (ch.10), ignored this message.

### ○ Expression (Controller number 11)

Status	2nd byte	3rd byte
BnH	0BH	vvH
n = MIDI channel number:	0H - FH (ch.1 - ch.16)	
vv = Expression:	00H - 7FH (0 - 127)	

- \* Expression messages are used to adjust the level of each part. It can be used independently from volume messages. Expression messages are used for musical expression within a performance; e.g., crescendo and decrescendo.

○ Hold 1 (Controller number 64)

Status	2nd byte	3rd byte
BnH	40H	vvH

n = MIDI channel number: 0H - FH (ch.1 - ch.16)  
 vv = Control value: 00H - 7FH (0 - 127) 0-63 = OFF, 64-127 = ON

\* In the rhythm part (ch.10), ignored this message.

○ Effect 1(Reverb Send Level) (Controller number 91)

Status	2nd byte	3rd byte
BnH	5BH	vvH

n = MIDI channel number: 0H - FH (ch.1 - ch.16)  
 vv = Reverb send level: 00H - 7FH (0 - 127)

○ RPN MSB/LSB (Controller number 100, 101)

Status	2nd byte	3rd byte
BnH	65H	mmH
BnH	64H	llH

n = MIDI channel number: 0H - FH (ch.1 - ch.16)  
 mm = upper byte of parameter number specified by RPN (MSB)  
 ll = lower byte of parameter number specified by RPN (LSB)

- \* In the rhythm part (ch.10), ignored this message.
- \* The value specified by RPN will not be reset even by messages such as program change or reset all controllers.
- \* Regarding the RPN please refer to page 136.

On the GM mode of TD-6, RPN can be used to modify the following parameters. Regarding the value of each parameter, refer to Data Entry (Controller number 6, 38).

RPN	ll	Parameter
00H	00H	Pitch Bend Sensitivity
00H	01H	Channel Fine Tuning
00H	02H	Channel Coarse Tuning
7FH	7FH	RPN null

● Program Change

Status	2nd byte
CnH	ppH

n = MIDI channel number: 0H - FH (ch.1 - ch.16)  
 pp = Program number: 00H - 7FH (prog.1 - prog.128)

\* The sound will change beginning with the next note-on after the program change is received. Voices which were already sounding before the program change was received will not be affected.

● Channel Pressure

Status	2nd byte
DnH	vvH

n = MIDI channel number: 0H - FH (ch.1 - ch.16)  
 vv = Channel pressure: 00H - 7FH (0 - 127)

- \* When channel pressure is received, the effect selected for channel pressure, in global parameter control (page 142), is applied.
- \* In the rhythm part (ch.10), ignored this message.

● Pitch Bend Change

Status	2nd byte	3rd byte
EnH	llH	mmH

n = MIDI channel number: 0H - FH (ch.1 - ch.16)  
 mm, ll = Pitch Bend value: 00 00H - 40 00H - 7F 7FH (-8192 - 0 - +8191)

\* In the rhythm part (ch.10), ignored this message.

■ Channel Mode Messages

● All Sounds Off (Controller number 120)

Status	2nd byte	3rd byte
BnH	78H	00H

n = MIDI channel number: 0H - FH (ch.1 - ch.16)

\* When this message is received, all currently-sounding notes on the corresponding channel will be silenced. However, the status of channel messages will not change.

● Reset All Controllers (Controller number 121)

Status	2nd byte	3rd byte
BnH	79H	00H

n = MIDI channel number: 0H - FH (ch.1 - ch.16)

\* When this message is received, the following controllers will be set to their reset values.

Controller	Reset value
Pitch Bend Change	+/-0 (center)
Channel Key Pressure	0 (off)
Modulation	0 (off)
Expression	127 (max)
Hold 1	0 (off)
RPN	unset; previously set data will not change

● All Notes Off (Controller number 123)

Status	2nd byte	3rd byte
BnH	7BH	00H

n = MIDI channel number: 0H - FH (ch.1 - ch.16)

\* When All Notes Off is received, all notes on the corresponding channel will be turned off. However if Hold 1 is ON, the sound will be continued until these are turned off.

■ System Realtime Message

● Active Sensing

Status
FEH

\* When Active Sensing is received, the unit will begin monitoring the intervals of all further messages. While monitoring, if the interval between messages exceeds about 420 ms, the same processing will be carried out as when All Sounds Off, All Notes Off and Reset All Controllers are received, and message interval monitoring will be halted.

■ System Exclusive Message

\* Regarding the system exclusive message refer to page 137.

The System Exclusive Messages received by the normal mode of TD-6 are; Universal Non-realtime System Exclusive Messages, Universal realtime System Exclusive Messages, Data Requests (RQ1), and Data Set (DT1).

## ● System exclusive messages related to mode setting

### ○ Turn General MIDI System On

This is a command message that resets the internal settings of the unit to the General MIDI initial state (General MIDI System - Level 1). After receiving this message, this unit will automatically be set to the proper condition for correctly playing a General MIDI score.

Status	Data byte	Status
F0H	7EH, 7FH, 09H, 01H	F7H
Byte	Explanation	
F0H	Exclusive status	
7EH	ID number (Universal Non-realtime Message)	
7FH	Device ID (Broadcast)	
09H	Sub ID#1 (General MIDI Message)	
01H	Sub ID#2 (General MIDI On)	
F7H	EOX (End Of Exclusive)	

- \* Not Received when SETUP/MIDI COMMON/Rx GM ON is set to "OFF". (Initial Value is ON)
- \* There must be an interval of at least 50 ms between this message and the next.

### ○ Turn General MIDI System Off

When a "GM System Off" is received, the TD-6 is switched to normal mode.

Status	Data byte	Status
F0H	7EH, 7FH, 09H, 02H	F7H
Byte	Explanation	
F0H	Exclusive status	
7EH	ID number (Universal Non-realtime Message)	
7FH	Device ID (Broadcast)	
09H	Sub ID#1 (General MIDI Message)	
02H	Sub ID#2 (General MIDI Off)	
F7H	EOX (End Of Exclusive)	

- \* Not Received when SETUP/MIDI COMMON/Rx GM ON is set to "OFF". (Initial Value is ON)
- \* There must be an interval of at least 50 ms between this message and the next.

## ● Universal Non-realtime System Exclusive Messages

### ○ Identity Request

- \* Regarding the Identity Request refer to page 137.

## ● Global Parameter Control

### ○ Channel Pressure

Status	Data byte	Status
F0H	7FH, dev, 09H, 01H, 0nH, ppH, rrH	F7H
Byte	Explanation	
F0H	Exclusive status	
7FH	ID number (Universal Realtime Message)	
dev	Device ID (dev: 00H - 1FH Initial value is 10H (17))	
09H	Sub ID#1 (Controller Destination Setting)	
01H	Sub ID#2 (Channel Pressure)	
0nH	MIDI channel (00H - 0FH)	
ppH	parameter	
rrH	range	
F7H	EOX (End Of Exclusive)	
pp=0	Pitch Control	
rr=28H-58H	-24 - +24 semitones	
pp=1	Filter Cutoff Control	
rr=00H-7FH	-9600 - +9450 cents	
pp=2	Amplitude Control	
rr=00H-7FH	0 - 200 %	
pp=3	LFO Pitch Depth	

rr=00H-7FH	0 - 600 cents
pp=4	LFO Filter Depth
rr=00H-7FH	0 - 2400 cents
pp=5	LFO Amplitude Depth
rr=00H-7FH	0 - 100 %

- \* Even if the Device ID is 7FH (Broadcast), Identity Reply message will be transmitted.
- \* In the rhythm part (ch.10), ignored this message.

## ● Data transmission

### ○ Request data 1 RQ1 (11H)

- \* Regarding the RQ1 refer to page 137.

### ○ Data set 1 DT1 (12H)

- \* Regarding the DT1 refer to page 138.

## Section 2. Transmit data

- \* When SETUP/MIDI COMMON/Soft Thru is set to "ON", messages received in addition to the following messages are also sent.

## ■ System Realtime Messages

### ● Active sensing

#### Status

FEH

- \* This will be transmitted constantly at intervals of approximately 250 ms.

## ■ System Exclusive Messages

### ● Universal Non-realtime System Exclusive Messages

#### ○ Identity Reply

- \* Regarding the Identity Reply refer to page 139.

### ● Data Transmission

#### ○ Data set 1 DT1 (12H)

- \* Regarding the DT1 refer to page 138.

## ◆ Parameter address map (Model ID = 00H 3FH)

This map indicates address, size, Data (range), Parameter, and Description of parameters which can be transferred using "Data set 1 (DT1)". All the numbers of address, size, Data, and Default Value are indicated in 7-bit Hexadecimal-form.

Addresses marked at "#" cannot be used as starting addresses.

### ■ Parameter Address Block

TD-6 (Model ID = 00H 3FH)

Start address	Description		
00 00 00 00	SETUP	(Individual)	*1-1
01 00 00 00	DRUM KIT 1	(Individual)	*1-2
01 62 00 00	DRUM KIT 99	(Individual)	*1-2
04 00 00 00	dummy (ignored)		
10 00 00 00	USER SONG	(Bulk)	*1-3
40 00 00 00	SETUP	(Bulk)	*1-1
41 00 00 00	DRUM KIT 1	(Bulk)	*1-2
41 62 00 00	DRUM KIT 99	(Bulk)	*1-2
44 00 00 00	dummy (ignored)		

#### \* 1-1 SETUP

Offset address	Description	
00 00 00	TRIGGER	*1-1-1
01 00 00	dummy (ignored)	
05 00 00		
06 00 00	MIDI	*1-1-2
07 00 00	PROGRAM CHANGE SW	*1-1-3
08 00 00	dummy (ignored)	
09 00 00	CONTROL	*1-1-4
0A 00 00	MASTER TUNE	*1-1-5
0B 00 00	dummy (ignored)	

#### \* 1-1-1 TRIGGER

Offset address	Description	
00 00	Pad parameters (1/KICK)	*1-1-1-1
01 00	dummy (ignored)	
02 00	Pad parameters (2/SNARE)	*1-1-1-1
03 00	Pad parameters (4/TOM1)	*1-1-1-1
04 00	Pad parameters (5/TOM2)	*1-1-1-1
05 00	Pad parameters (7/TOM3)	*1-1-1-1
06 00	Pad parameters (3/HI-HAT)	*1-1-1-1
07 00	Pad parameters (9/CRASH1)	*1-1-1-1
08 00	Pad parameters (10/CRASH2)	*1-1-1-1
09 00	Pad parameters (11/RIDE)	*1-1-1-1
0A 00	Pad parameters (6/AUX)	*1-1-1-1
0B 00	Pad parameters (8/TOM4)	*1-1-1-1

#### \* 1-1-1-1 TRIGGER (Pad parameters)

Offset address	Size	Description
00	0000 aaaa	Trigger Type 0 - 11 (PD6, PD7/9, PD80/100, PD80R, PD120, KD7, KD Type, CY6, CY Type, Other 1, Other 2, AcDrTrig)
01	0000 aaaa	Rim Sensitivity 0 - 15 (OFF, 1 - 15) (2/SNARE only)
02	0000 0000	dummy (ignored)

03	0000 aaaa	Sensitivity 0 - 15 (1 - 16)
04	0000 aaaa	Threshold 0 - 15
05	0000 0aaa	Trigger Curve 0 - 7 (LINEAR, EXP1, EXP2, LOG1, LOG2, SPLINE, LOUD1, LOUD2)
06	00aa aaaa	Scan Time 0 - 40 (0.0ms - 4.0ms, 0.1ms step)
07	0000 aaaa	Retrigger Cancel 0 - 15 (1 - 16)
08	000a aaaa	Mask Time 0 - 16
09	0000 aaaa	Crosstalk Cancel 0 - 13 (OFF, 20, 25, 30, 35, 40, 45, 50, 55, 60, 65, 70, 75, 80)
0A	0000 0000	dummy (ignored)
10	0000 0000	
Total size	00 00 00 11	

#### \* 1-1-2 MIDI

Offset address	Size	Description
00 00	000a aaaa	Part1 Tx/Rx Channel 0 - 16 (1 - 16, OFF)
00 01	000a aaaa	Part2 Tx/Rx Channel 0 - 16 (1 - 16, OFF)
00 02	000a aaaa	Part3 Tx/Rx Channel 0 - 16 (1 - 16, OFF)
00 03	000a aaaa	Part4 Tx/Rx Channel 0 - 16 (1 - 16, OFF)
00 04	000a aaaa	Perc Part Tx/Rx Channel 0 - 16 (1 - 16, OFF)
00 05	000a aaaa	Kit Part Tx/Rx Channel 0 - 16 (1 - 16, OFF)
00 06	0000 000a	Note Chase 0 - 1 (OFF, ON)
00 07	0000 000a	Local Control 0 - 1 (OFF, ON)
00 08	0000 000a	Soft Thru 0 - 1 (OFF, ON)
00 09	0000 000a	GM Mode 0 - 1 (OFF, ON)
00 0A	0000 000a	Rx GM On 0 - 1 (OFF, ON)
00 0B	0000 00aa	Sync Mode 0 - 2 (INT, EXT, REMOTE)
00 0C	0000 00aa	Pedal Data Thin 0 - 2 (OFF, 1, 2)
00 0D	0000 0000	dummy (ignored)
00 0E	0000 0000	
00 0F	0000 000a	CH10 Priority 0 - 1 (KIT, PERC)
Total size	00 00 00 10	

#### \* 1-1-3 PROGRAM CHANGE SW

Offset address	Size	Description
00 00	0000 000a	Rx Program Change Sw 0 - 1 (OFF, ON)
00 01	0000 000a	Tx Program Change Sw 0 - 1 (OFF, ON)
00 02	0000 0000	dummy (ignored)
00 70	0000 0000	
Total size	00 00 00 71	

#### \* 1-1-4 CONTROL

Offset address	Size	Description
00 00	0000 0000	dummy (ignored)
00 06	0000 0000	
00 07	0aaa aaaa	Preview Velocity 0 - 127
00 08	0000 0000	dummy (ignored)
00 09	0aaa aaaa	Percussion Part Level 0 - 127
00 0A	0aaa aaaa	Backing Part Level 0 - 127
00 0B	0000 0aaa	Mute Part 0 - 7 (SongDrum, SongDrum/Prc, UserDrumPart, Part1, Part2, Part3, Part4, Part1-4)
Total size	00 00 00 0C	

# MIDI Implementation

## \* 1-1-5 MASTER TUNE

Offset address	Size	Description	
00 00	0000 aaaa	Master Tune	0 - 509
# 00 01	0000 bbbb	[nibbled]	(415.3 - 466.2Hz)
# 00 02	0000 cccc		
# 00 03	0000 dddd		
Total size		00 00 00 04	

## \* 1-2 DRUM KIT

Offset address	Description	
00 00	Common parameters	*1-2-1
01 00	Pad parameters (1/KICK)	*1-2-2
02 00	dummy (ignored)	
03 00	Pad parameters (2/SNARE)	*1-2-2
04 00	Pad parameters (4/TOM1)	*1-2-2
05 00	Pad parameters (5/TOM2)	*1-2-2
06 00	Pad parameters (7/TOM3)	*1-2-2
07 00	Pad parameters (3/HI-HAT)	*1-2-2
08 00	Pad parameters (9/CRASH1)	*1-2-2
09 00	Pad parameters (10/CRASH2)	*1-2-2
0A 00	Pad parameters (11/RIDE)	*1-2-2
0B 00	Pad parameters (6/AUX)	*1-2-2
0C 00	Pad parameters (8/TOM4)	*1-2-2

## \* 1-2-1 DRUM KIT (Common parameters)

Offset address	Size	Description	
00	0aaa aaaa	Drum Kit Name 1	32 - 127
:	:	:	:
07	0aaa aaaa	Drum Kit Name 8	32 - 127
08	0000 aaaa	Studio	1 - 9 (LIVING, BATHROOM, STUDIO, GARAGE, LOCKER, THEATER, CAVE, GYM, STADIUM)
09	0aaa aaaa	Ambience Level	0 - 127
0A	0000 00aa	Wall Type	0 - 2 (WOOD, PLASTER, GLASS)
0B	0000 00aa	Room Size	1 - 3 (SMALL, MEDIUM, LARGE)
0C	0000 0000	dummy (ignored)	
0D	000a aaaa	EQ Low Gain	0 - 24 (-12 - +12db)
0E	0000 0000	dummy (ignored)	
0F	000a aaaa	EQ High Gain	0 - 24 (-12 - +12db)
10	0000 000a	Ambience Sw	0 - 1 (OFF, ON)
11	0000 000a	Master EQ Sw	0 - 1 (OFF, ON)
12	0000 0000	dummy (ignored)	
13	0000 aaaa	Pedal Hi-Hat Volume	0 - 15
14	00aa aaaa	Pedal Pitch Control Range	0 - 48 (-24 - +24semitone)
15	0aaa aaaa	Master Volume	0 - 127
16	0000 0000	dummy (ignored)	
:	:	:	:
18	0000 0000	dummy (ignored)	
Total size		00 00 00 19	

## \* 1-2-2 DRUM KIT (Pad parameters)

Offset address	Size	Description	
00	0000 aaaa	HEAD	Instrument
# 01	0000 bbbb		[nibbled]
# 02	0000 cccc		
# 03	0000 dddd		
04	0000 aaaa	HEAD	Pitch
# 05	0000 bbbb		[nibbled]
# 06	0000 cccc		
# 07	0000 dddd		
08	00aa aaaa	HEAD	Decay
09	0000 aaaa	HEAD	Pad Pattern Number
0A	0000 bbbb		[nibbled]
0B	0000 cccc		
# 0C	0000 dddd		

0D	0aaa aaaa	HEAD	MIDI Gate Time	1 - 80 (0.1s - 8.0s, 0.1s step)
0E	0aaa aaaa	HEAD	Note Number	0 - 127
0F	0000 000a	HEAD	Pad Pattern Velocity	0 - 1 (OFF, ON)
10	0aaa aaaa	HEAD	Level	0 - 127
11	0aaa aaaa	HEAD	Ambience Send Level	0 - 127
12	0000 000a	HEAD	Pitch Control	0 - 1 (OFF, ON)
# 13	0000 aaaa	RIM	Instrument	0 - 1023 (*1)
# 14	0000 bbbb		[nibbled]	(1 - 1024)
# 15	0000 cccc			
# 16	0000 dddd			
17	0000 aaaa	RIM	Pitch	0 - 960 (*1)
# 18	0000 bbbb		[nibbled]	(-480 - +480)
# 19	0000 cccc			
# 1A	0000 dddd			
1B	00aa aaaa	RIM	Decay	0 - 62 (*1) (-31 - +31)
1C	0000 aaaa	RIM	Pad Pattern Number	0 - 250 (*1)
# 1D	0000 bbbb		[nibbled]	(OFF, 1 - 250)
# 1E	0000 cccc			
# 1F	0000 dddd			
20	0aaa aaaa	RIM	MIDI Gate Time	1 - 80 (*1) (0.1s - 8.0s, 0.1s step)
21	0aaa aaaa	RIM	Note Number	0 - 127 (*1)
22	0000 000a	RIM	Pad Pattern Velocity	0 - 1 (*1) (OFF, ON)
23	0aaa aaaa	RIM	Level	0 - 127 (*1)
24	0aaa aaaa	RIM	Ambience Send Level	0 - 127 (*1)
25	0000 000a	RIM	Pitch Control	0 - 1 (*1) (OFF, ON)
26	00aa aaaa		Pan	0 - 32 (L15 - R15, RANDOM, ALTERNATE)
27	0aaa aaaa		dummy (ignore)	
:	:			
2A	0aaa aaaa			
Total size		00 00 00 2B		

(\*1) 2/SNARE, 4/TOM1, 3/HIHAT, 9/CRASH1, 10/CRASH2, 11/RIDE only.

## \* 1-3 USER SONG

Offset address	Description
00 00 00 00	All User Song Request
01 7F 7F 7F	All User Song Data End



## Parameter Address Block Map

An outlined address map of the Exclusive Communication is as follows:

Address(H)	Block	Sub block	Reference
00 00 00 00	SETUP	TRIGGER	*1-1-1
		PAD 1	
		:	
		PAD 12	
		MIDI	*1-1-2
		PROGRAM CHANGE SW	*1-1-3
		CONTROL	*1-1-4
		MASTER TUNE	*1-1-5
01 00 00 00	DRUM KIT	DRUM KIT 1	*1-2
		:	
		DRUM KIT 99	
10 00 00 00	USER SONG		
40 00 00 00	SETUP	Bulk area	
41 00 00 00	DRUM KIT		

## Bulk Dump

Bulk Dump allows you to transmit a large amount of data at once, and is convenient for storing settings for the entire unit on a computer or sequencer. For Bulk Dump Request, you must use the Address and Size listed in the following Bulk Dump Request.

### Parameter Dump Request

Address(H)	Size(H)
10 00 00 00	00 00 00 00
	(All User Songs: dump request for all user songs)
40 00 00 00	00 00 00 00
	(Setup: dump request for all setup except Device ID and LCD Contrast)
41 mm 00 00	00 00 00 00
	(One Drum Kit: single drum kit dump request specified by "mm")
41 7f 00 00	00 00 00 00
	(All Drum Kits: dump request for all drum kits)
mm = 00H - 62H	(Drum Kit No.1 - 99)

- \* Data of preset song (No.1 - 150) cannot be transmitted.
- \* Make sure to set "00 00 00 00" for the data size.

## Supplementary Material

### Decimal and Hexadecimal table

In MIDI documentation, data values and addresses/sizes of exclusive messages etc. are expressed as hexadecimal values for each 7 bits.

The following table shows how these correspond to decimal numbers.

Dec.	Hex.	Dec.	Hex.	Dec.	Hex.	Dec.	Hex.
0	00H	32	20H	64	40H	96	60H
1	01H	33	21H	65	41H	97	61H
2	02H	34	22H	66	42H	98	62H
3	03H	35	23H	67	43H	99	63H
4	04H	36	24H	68	44H	100	64H
5	05H	37	25H	69	45H	101	65H
6	06H	38	26H	70	46H	102	66H
7	07H	39	27H	71	47H	103	67H
8	08H	40	28H	72	48H	104	68H
9	09H	41	29H	73	49H	105	69H
10	0AH	42	2AH	74	4AH	106	6AH
11	0BH	43	2BH	75	4BH	107	6BH
12	0CH	44	2CH	76	4CH	108	6CH
13	0DH	45	2DH	77	4DH	109	6DH
14	0EH	46	2EH	78	4EH	110	6EH
15	0FH	47	2FH	79	4FH	111	6FH
16	10H	48	30H	80	50H	112	70H
17	11H	49	31H	81	51H	113	71H
18	12H	50	32H	82	52H	114	72H
19	13H	51	33H	83	53H	115	73H
20	14H	52	34H	84	54H	116	74H
21	15H	53	35H	85	55H	117	75H
22	16H	54	36H	86	56H	118	76H
23	17H	55	37H	87	57H	119	77H
24	18H	56	38H	88	58H	120	78H
25	19H	57	39H	89	59H	121	79H
26	1AH	58	3AH	90	5AH	122	7AH
27	1BH	59	3BH	91	5BH	123	7BH
28	1CH	60	3CH	92	5CH	124	7CH
29	1DH	61	3DH	93	5DH	125	7DH
30	1EH	62	3EH	94	5EH	126	7EH
31	1FH	63	3FH	95	5FH	127	7FH

- \* Decimal values such as MIDI channel, bank select, and program change are listed as one(1) greater than the values given in the above table.
- \* A 7-bit byte can express data in the range of 128 steps. For data where greater precision is required, we must use two or more bytes. For example, two hexadecimal numbers aa bbH expressing two 7-bit bytes would indicate a value of aa x 128 + bb.
- \* In the case of values which have a +- sign, 00H = -64, 40H = +0, and 7FH = +63, so that the decimal expression would be 64 less than the value given in the above chart. In the case of two types, 00 00H = -8192, 40 00H = +0, and 7F 7FH = +8191. For example if aa bbH were expressed as decimal, this would be aa bbH - 40 00H = aa x 128 + bb - 64 x 128.
- \* Data marked "nibbled" is expressed in hexadecimal in 4-bit units. A value expressed as a 2-byte nibble 0a 0bH has the value of a x 16 + b.

#### <Example1> What is the decimal expression of 5AH ?

From the preceding table, 5AH = 90

#### <Example2> What is the decimal expression of the value 12 34H given as hexadecimal for each 7 bits?

From the preceding table, since 12H = 18 and 34H = 52  
 $18 \times 128 + 52 = 2356$

#### <Example3> What is the decimal expression of the nibbled value 0A 03 09 0D ?

From the preceding table, since 0AH = 10, 03H = 3, 09H = 9, 0DH = 13  
 $((10 \times 16 + 3) \times 16 + 9) \times 16 + 13 = 41885$

#### <Example4> What is the nibbled expression of the decimal value 1258 ?

$$\begin{array}{r} 16) \underline{1258} \\ \underline{78} \quad \dots 10 \\ 16) \underline{\quad 4} \quad \dots 14 \\ \underline{\quad 0} \quad \dots 4 \end{array}$$

Since from the preceding table, 0 = 00H, 4 = 04H, 14 = 0EH, 10 = 0AH, the answer is 00 04 0E 0A

## ■ Examples of actual MIDI message

### <Example1> 92 3E 5F

9n is the Note-on status, and n is the MIDI channel number. Since 2H = 2, 3EH = 62, and 5FH = 95, this is a Note-on message with MIDI CH = 3, note number 62 (note name is D4), and velocity 95.

### <Example2> C9 20

CnH is the Program Change status, and n is the MIDI channel number. Since 9H = 9 and 20H = 32, this is a Program Change message with MIDI CH = 10, program number 33 (Drum Kit No.33).

### <Example3> E3 00 28

EnH is the Pitch Bend Change status, and n is the MIDI channel number. The 2nd byte (00H=0) is the LSB and the 3rd byte (28H=40) is the MSB, but Pitch Bend Value is a signed number in which 40 00H (= 64 x 128 + 0 = 8192) is 0, so this Pitch Bend Value is

$$28\ 00H - 40\ 00H = 40 \times 128 + 0 - (64 \times 128 + 0) = 5120 - 8192 = -3072$$

### <Example4> B3 64 00 65 00 06 0C 26 00 64 7F 65 7F

BnH is the Control Change status, and n is the MIDI channel number. For Control Changes, the 2nd byte is the control number, and the 3rd byte is the value. In a case in which two or more messages consecutive messages have the same status, MIDI has a provision called "running status" which allows the status byte of the second and following messages to be omitted. Thus, the above messages have the following meaning.

B3 64 00	MIDI ch.4, lower byte of RPN parameter number:	00H
(B3) 65 00	(MIDI ch.4) upper byte of RPN parameter number:	00H
(B3) 06 0C	(MIDI ch.4) upper byte of parameter value:	0CH
(B3) 26 00	(MIDI ch.4) lower byte of parameter value:	00H
(B3) 64 7F	(MIDI ch.4) lower byte of RPN parameter number:	7FH
(B3) 65 7F	(MIDI ch.4) upper byte of RPN parameter number:	7FH

In other words, the above messages specify a value of 0C 00H for RPN parameter number 00 00H on MIDI channel 4, and then set the RPN parameter number to 7F 7FH.

RPN parameter number 00 00H is Pitch Bend Sensitivity, and the MSB of the value indicates semitone units, so a value of 0CH = 12 sets the maximum pitch bend range to +- 12 semitones (1 octave). (On GS sound sources the LSB of Pitch Bend Sensitivity is ignored, but the LSB should be transmitted anyway (with a value of 0) so that operation will be correct on any device.)

Once the parameter number has been specified for RPN or NRPN, all Data Entry messages transmitted on that same channel will be valid, so after the desired value has been transmitted, it is a good idea to set the parameter number to 7F 7FH to prevent accidents. This is the reason for the (B3) 64 7F (B3) 65 7F at the end.

It is not desirable for performance data (such as Standard MIDI File data) to contain many events with running status as given in <Example 4>. This is because if playback is halted during the song and then rewound or fast-forwarded, the sequencer may not be able to transmit the correct status, and the sound source will then misinterpret the data. Take care to give each event its own status.

It is also necessary that the RPN or NRPN parameter number setting and the value setting be done in the proper order. On some sequencers, events occurring in the same (or consecutive) clock may be transmitted in an order different than the order in which they were received. For this reason it is a good idea to slightly skew the time of each event (about 1 tick for TPQN =96, and about 5 ticks for TPQN =480).

\* TPQN : Ticks Per Quarter Note

## ● Example of an Exclusive message and calculating a Checksum

Roland Exclusive messages (RQ1, DT1) are transmitted with a checksum at the end (before F7) to make sure that the message was correctly received. The value of the checksum is determined by the address and data (or size) of the transmitted exclusive message.

### ○ How to calculate the checksum

(hexadecimal numbers are indicated by "H")

The checksum is a value derived by adding the address, size and checksum itself and inverting the lower 7 bits.

Here's an example of how the checksum is calculated. We will assume that in the exclusive message we are transmitting, the address is aa bb cc ddH and the data or size is ee ff gg hhH.

$$aa + bb + cc + dd + ee + ff + gg + hh = \text{sum}$$

$$\text{sum} / 128 = \text{quotient} \dots \text{remainder}$$

$$128 - \text{remainder} = \text{checksum}$$

(However, the checksum will be 0 if the remainder is 0.)

### <Example1> Setting pan of snare drum (Trigger 2) in drum kit 1 to "ALTERNATE".

According to the "Parameter address map", the drum kit No.1 has an address of 01 00 00 00H, drum kit pad parameter of Trigger 2 has a offset address of 03 00H and pan has a offset address of 26H. Thus,

$$\begin{array}{r} 01\ 00\ 00\ 00 \\ \quad \quad 03\ 00 \\ +) \quad \quad \quad 26 \\ \hline 01\ 00\ 03\ 26 \end{array}$$

and "ALTERNATE" is a value of 20H,

$$F0\ 41\ 10\ 00\ 3F\ 12\ 01\ 00\ 03\ 26\ 20\ \quad ??\ \quad F7$$

(1) (2) (3) (4) (5) address data checksum (6)

(1) Exclusive status, (2) ID number (Roland), (3) Device ID (17)

(4) Model ID (TD-6), (5) Command ID (DT1), (6) EOX

Next we calculate the checksum.

$$01H + 00H + 03H + 26H + 20H = 1 + 0 + 3 + 38 + 32 = 74 \text{ (sum)}$$

$$74 \text{ (sum)} / 128 = 0 \text{ (quotient)} \dots 74 \text{ (remainder)}$$

$$\text{checksum} = 128 - 74 \text{ (remainder)} = 54 = 36H$$

This means that F0 41 10 00 3F 12 01 00 03 26 20 36 F7 is the message we transmit.

### <Example2> Requesting transmission of master volume of drum kit 1.

According to the "Parameter address map", the drum kit No.1 has an address of 01 00 00 00H, drum kit common parameter has a offset address of 00 00H and master volume has a offset address of 15H. Thus,

$$\begin{array}{r} 01\ 00\ 00\ 00 \\ \quad \quad 00\ 00 \\ +) \quad \quad \quad 15 \\ \hline 01\ 00\ 00\ 15 \end{array}$$

Since Size = 00 00 00 01H,

$$F0\ 41\ 10\ 00\ 3F\ 11\ 01\ 00\ 00\ 15\ 00\ 00\ 00\ 01\ \quad ??\ \quad F7$$

(1) (2) (3) (4) (5) address size checksum (6)

(1) Exclusive status, (2) ID number (Roland), (3) Device ID (17)

(4) Model ID (TD-6), (5) Command ID (RQ1), (6) EOX

Next we calculate the checksum.

$$01H + 00H + 00H + 15H + 00H + 00H + 00H + 01H = 1 + 0 + 0 + 21 + 0 + 0 + 0 + 1 = 23 \text{ (sum)}$$

$$23 \text{ (sum)} / 128 = 0 \text{ (quotient)} \dots 23 \text{ (remainder)}$$

$$\text{checksum} = 128 - 23 \text{ (remainder)} = 105 = 69H$$

This means that F0 41 10 00 3F 11 01 00 00 15 00 00 00 01 69 F7 is the message we transmit.

● About tuning

\* Tuning by sending RPN#1 is only possible in GM mode.

In MIDI, individual Parts are tuned by sending RPN #1 (Channel Fine Tuning) to the appropriate MIDI channel.

In MIDI, an entire device is tuned by either sending RPN #1 to all MIDI channels being used, or by sending a System Exclusive MASTER TUNE (address 00 0A 00 00H).

RPN #1 allows tuning to be specified in steps of approximately 0.012 cents (to be precise, 100/8192 cent). One cent is 1/100th of a semitone. System Exclusive MASTER TUNE allows tuning in steps of 0.1 Hz.

The values of RPN #1 (Channel Fine Tuning) and System Exclusive master tune are added together to determine the actual pitch sounded by each Part.

Frequently used tuning values are given in the following table for your reference. Values are in hexadecimal (decimal in parentheses).

Hz in A4	cent	RPN #1	Sys.Ex. 00 0A 00 00
445.0	+19.56	4C 43 (+1603)	00 01 02 09 (+50)
444.0	+15.67	4A 03 (+1283)	00 01 01 0F (+40)
443.0	+11.76	47 44 (+ 964)	00 01 01 05 (+30)
442.0	+ 7.85	45 03 (+ 643)	00 01 00 0B (+20)
441.0	+ 3.93	42 42 (+ 322)	00 01 00 01 (+10)
440.0	0.00	40 00 ( 0)	00 00 0F 07 ( 0)
439.0	- 3.94	3D 3D (- 323)	00 00 0E 0D (-10)
438.0	- 7.89	3A 7A (- 646)	00 00 0E 03 (-20)

<Example> In GM mode, set the tuning of MIDI channel 3 to A4 = 442.0 Hz

Send RPN#1 to MIDI channel 3. From the above table, the value is 45 03H.

- B2 64 00 MIDI ch.3, lower byte of RPN parameter number : 00H
- (B2) 65 01 (MIDI ch.3) upper byte of RPN parameter number : 01H
- (B2) 06 45 (MIDI ch.3) upper byte of parameter value : 45H
- (B2) 26 03 (MIDI ch.3) lower byte of parameter value : 03H
- (B2) 64 7F (MIDI ch.3) lower byte of RPN parameter number : 7FH
- (B2) 65 7F (MIDI ch.3) upper byte of RPN parameter number : 7FH

# MIDI Implementation Chart

Function...	Transmitted	Recognized	Remarks
Basic Channel Default Changed	1-16, OFF 1-16, OFF	1-16, OFF 1-16, OFF	Memorized (Non-Volatile)
Mode Default Messages Altered	Mode 3 X *****	Mode 3 X *****	
Note Number : True Voice	0-127 0-127	0-127 0-127	
Velocity Note On Note Off	<input type="radio"/> 9nH, v = 1-127 <input type="radio"/> 8nH, v = 64	<input type="radio"/> 9nH, v = 1-127 <input type="radio"/> 8nH, v = 64	
After Touch Key's Channel's	<input type="radio"/> *1 X	<input type="radio"/> *1 X	
Pitch Bend	X	<input type="radio"/> *3	
Control Change	0, 32 1 4 6 7 10 11 64 91 100, 101	X X <input type="radio"/> *1 X X <input type="radio"/> *2 X X <input type="radio"/> *3 <input type="radio"/> *2 X <input type="radio"/> *3	Bank select Modulation Foot control Data entry Volume Panpot Expression Hold 1 Effect 1 (Reverb Send Level) RPN LSB, MSB
Program Change : True Number	<input type="radio"/> 0-127	<input type="radio"/> 0-127	Program No. 1-128
System Exclusive	<input type="radio"/>	<input type="radio"/>	
System Common : Song Position : Song Select : Tune Request	X X X	X X X	
System Real Time : Clock : Commands	X X	X X	
Aux Messages : All Sound Off : Reset All Controllers : Local On/Off : All Notes Off : Active Sensing : System Reset	X X X X <input type="radio"/> X	<input type="radio"/> (120, 126, 127) <input type="radio"/> X <input type="radio"/> (123-127) <input type="radio"/> X	
Notes	* 1 Drum kit part only. * 2 Percussion part and backing part only. * 3 Backing part only.		

Mode 1 : OMNI ON, POLY  
Mode 3 : OMNI OFF, POLY

Mode 2 : OMNI ON, MONO  
Mode 4 : OMNI OFF, MONO

O : Yes  
X : No

# MIDI Implementation Chart

Function...	Transmitted	Recognized	Remarks
Basic Channel Default Changed	1-16, OFF 1-16, OFF	1-16, OFF 1-16, OFF	Memorized (Non-Volatile)
Mode Default Messages Altered	Mode 3 X *****	X X *****	
Note Number : True Voice	0-127 0-127	0-127 0-127	
Velocity Note On Note Off	<input type="radio"/> 9nH, v = 1-127 <input type="radio"/> 8nH, v = 64	<input type="radio"/> 9nH, v = 1-127 <input type="radio"/> 8nH, v = 64	
After Touch Key's Channel's	X X	X X	
Pitch Bend	<input type="radio"/> *3	<input type="radio"/> *3	
Control Change 0, 32 1 4 6 7 10 11 64 91 100, 101	<input type="radio"/> *3 *4 *5 X <input type="radio"/> *1 <input type="radio"/> *3 <input type="radio"/> *2 *4 <input type="radio"/> *3 *4 X <input type="radio"/> *3 <input type="radio"/> *2 *4 <input type="radio"/> *3	X X <input type="radio"/> *1 X X X X X <input type="radio"/> *3 X X	Bank select Modulation Foot control Data entry Volume Panpot Expression Hold 1 Effect 1 (Reverb Send Level) RPN LSB, MSB
Program Change : True Number	<input type="radio"/> *4 *5 0-127	X	Program No. 1-128
System Exclusive	<input type="radio"/>	<input type="radio"/> (do not record)	
System Common : Song Position : Song Select : Tune Request	X X X	X X X	
System Real Time : Clock : Commands	<input type="radio"/> <input type="radio"/>	X X	*6 *7
Aux Messages : All Sound Off : Reset All Controllers : Local On/Off : All Notes Off : Active Sensing : System Reset	X X X X <input type="radio"/> X	<input type="radio"/> <input type="radio"/> X <input type="radio"/> (123-127) <input type="radio"/> (do not record) X	
Notes	*1 Drum kit part only. *2 Percussion part and backing part only. *3 Backing part only. *4 Transmits when song is selected. *5 Transmits when instruments are selected for parts. *6 Receives when Sync Mode setting is "EXT". *7 Receives when Sync Mode setting is "EXT" or "REMOTE".		

Mode 1 : OMNI ON, POLY  
Mode 3 : OMNI OFF, POLY

Mode 2 : OMNI ON, MONO  
Mode 4 : OMNI OFF, MONO

O : Yes  
X : No

# MIDI Implementation Chart

Function...	Transmitted	Recognized	Remarks
Basic Channel Default Changed	X X	1-16, OFF 1-16, OFF	Memorized (Non-Volatile)
Mode Default Messages Altered	X X *****	Mode 3 X *****	
Note Number : True Voice	X *****	0-127 0-127	
Velocity Note On Note Off	X X	○ 9nH, v = 1-127 ○ 8nH, v = 64	
After Touch Key's Channel's	X X	X ○ *1	
Pitch Bend	X	○ *1	
Control Change	0, 32 X 1 X 4 X 6 X 7 X 10 X 11 X 64 X 91 X 100, 101 X	X ○ *1 X ○ *1 ○ ○ *1 ○ ○ *1 ○ ○ *1 ○ ○ *1	Bank select Modulation *1 Foot control Data entry *1 Volume Panpot Expression Hold 1 *1 Effect 1 (Reverb Send Level) RPN LSB, MSB *1
Program Change : True Number	X *****	○ 0-127	Program No. 1-128
System Exclusive	○	○	
System Common : Song Position : Song Select : Tune Request	X X X	X X X	
System Real Time : Clock : Commands	X X	X X	
Aux Messages : All Sound Off : Reset All Controllers : Local On/Off : All Notes Off : Active Sensing : System Reset	X X X X ○ ○ X	○ ○ X ○ ○ ○ X	
Notes	*1 Not received on Channel 10		

Mode 1 : OMNI ON, POLY  
Mode 3 : OMNI OFF, POLY

Mode 2 : OMNI ON, MONO  
Mode 4 : OMNI OFF, MONO

○ : Yes  
X : No

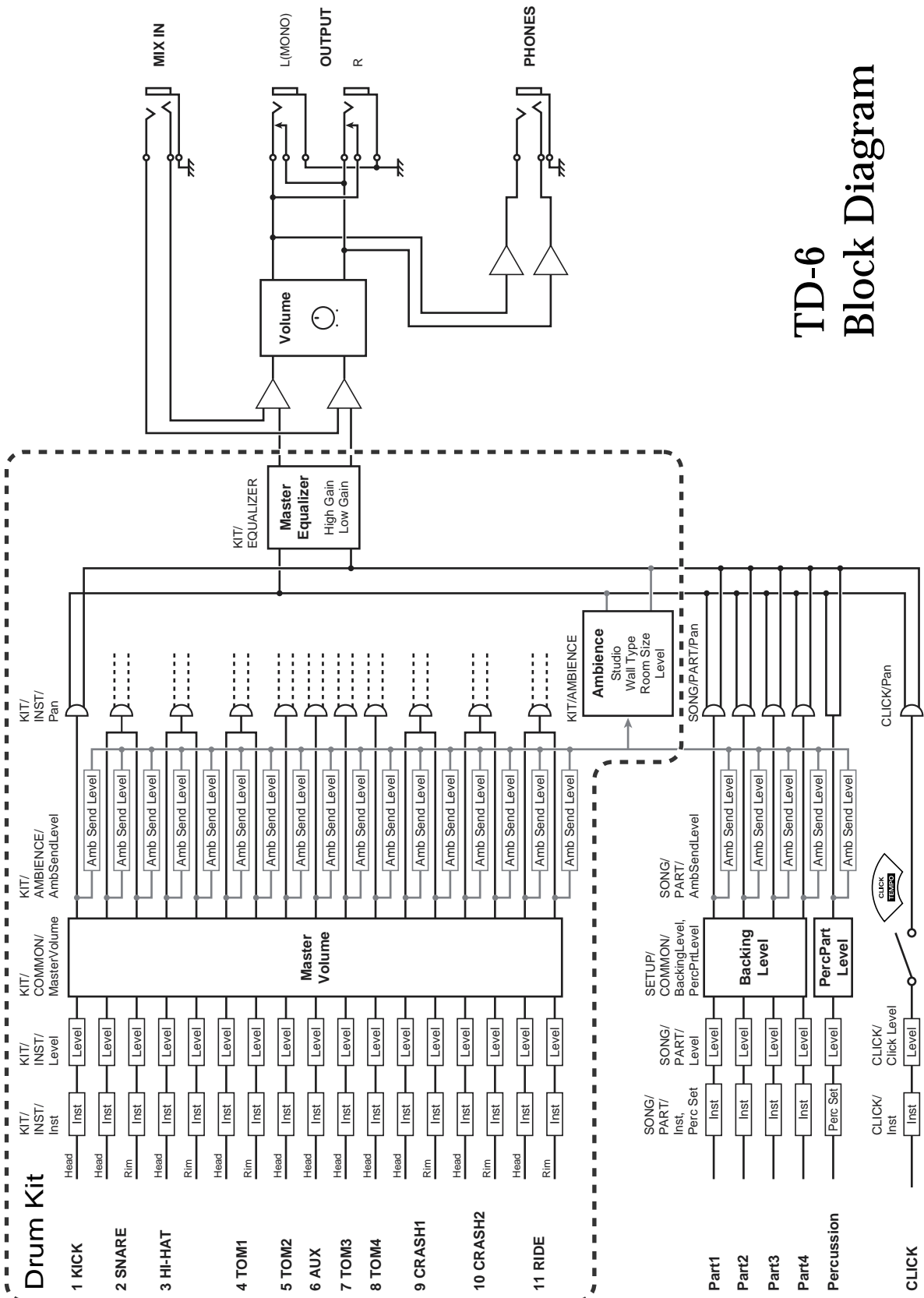

# TD-6 Block Diagram

# Specifications

## TD-6: Percussion Sound Module (Conforms to General MIDI System)

### Maximum Polyphony

64 Voices

### Instruments

Drum Instruments: 1,024

Backing Instruments: 262

### Drum Kits

99

### Effect Types

Ambience

2-Band Master Equalizer

### Sequencer

Preset Songs: 150

User Songs: 100

Parts: 6

Play Functions: One shot, Loop, Tap

Tempo: 20–260

Resolution: 192 ticks per quarter note

Recording Method: Real-time

Maximum Note Storage: approx. 12,000 Notes

### Display

20 characters, 2 lines (backlit LCD)

### Connectors

Trigger Input Jacks: 9 (11 Inputs)

Hi-Hat Control Jack

Output Jacks (L (MONO), R)

Phones Jack (stereo miniature phone type)

Mix in Jack (stereo miniature phone type)

MIDI Connectors (IN, OUT/THRU)

### Output Impedance

1.0 k ohms

### Power Supply

AC Adaptor (DC 9 V)

### Current Draw

1,000 mA

### Dimensions

266 (W) x 199 (D) x 75 (H) mm

10-1/2 (W) x 7-7/8 (D) x 3 (H) inches

### Weight

1.1 kg / 2 lbs 7 oz (excluding AC Adaptor)

### Accessories

Owner's Manual, AC Adaptor (ACI/ACB Series),

Screws (M5 x 8) x 4

### Options

Pads (PD-6, PD-7, PD-9, PD-80, PD-80R, PD-100, PD-120)

Cymbals (CY-6, CY-12H, CY-12R/C, CY-14C, CY-15R)

Kick Trigger Units (KD-7, KD-80, KD-120)

Hi-Hat Control Pedal (FD-7)

Stands (MDS-6, MDS-7U, MDS-8, MDS-10)

Cymbal Mount (MDY-10U)

Pad Mount (MDH-10U)

\* *In the interest of product improvement, the specifications and/or appearance of this unit are subject to change without prior notice.*



# Index

## A

AC Adaptor Jack .....	18
Acoustic Drum Trigger .....	76
Advanced Trigger Parameter .....	74
Amb Level (Ambience Level) .....	63
AMBIENCE .....	62
Ambience Sw (Ambience Switch) .....	62
AmbSendLevel (Ambience Send Level)	
Drum Instrument .....	62
Part1-Part4 .....	90
Percussion Part .....	90
AvailMemory (Available Memory) .....	79

## B

Backing Instrument List .....	126
Backing Part .....	78
BackingLevel (Backing Level) .....	78
Basic Trigger Parameter .....	72
Bell Shots .....	38
Bend Range .....	90
Block Diagram .....	151
Bow Shots .....	38
Bulk Dump	
Receiving .....	104
Transmitting .....	103

## C

CH10Priority (Channel 10 Priority) .....	99
Channel 10 Priority .....	99
CLICK (TEMPO) Button .....	16
Click Level .....	44, 80
Click On/Off .....	43, 80
COMMON	
Drum Kit .....	68
Song .....	86
Copy	
Drum Kit .....	69
Song .....	90
Cord Hook .....	18
Count In .....	81
Cross Stick .....	37
Crosstalk Cancel .....	74
Cymbal Choke .....	39

## D

Decay .....	61
Delete .....	91
Demo Songs .....	28
Device ID .....	101
Display .....	16
Drum Instrument List .....	120
Drum Kit .....	42, 56-57
Drum Kit List .....	118
Drum Kit Name .....	69
Drum Kit Screen .....	57

## E

Edge Shots .....	38
EDIT (SETUP) Button .....	17
ENTER Button .....	17
EQUALIZER .....	64
Erase .....	92
Error Message .....	116
EXCHANGE .....	70
EXIT Button .....	17

## F

Factory Reset .....	26, 79
Front Panel .....	16

## G

Gain .....	64
Gate Time .....	67
General MIDI system .....	13
GM Mode (General MIDI Mode) .....	100
GM Part .....	103
GM System On Message .....	100

## H

Head Shots .....	37
HH CTRL Jack .....	18
High Gain .....	64
Hi-Hat Control Pedal .....	39
HitPadStart (Hit Pad Start) .....	95

**I**

INC/+, DEC/- Button .....	17
Indicator .....	33, 71
INST .....	60
Inst Group .....	59
Instrument	
Click .....	81
Drum Kit .....	60
Part1-Part4 .....	89
Instruments	
Drum Kit .....	59
Internal Sequencer .....	97
Interval .....	81

**K**

KIT	
AMBIENCE .....	62
COMMON .....	68
CONTROL .....	64
COPY .....	69
EQUALIZER .....	64
EXCHANGE .....	70
INST .....	60
KIT Button .....	17
KitName (Drum Kit Name) .....	69

**L**

LCD Contrast .....	77
Length .....	94
Level	
Backing Part .....	48, 78
Click .....	44, 80
Drum Instrument .....	61
Part1-Part4 .....	89
Percussion Part .....	48, 77
Percussion Set .....	89
Preview .....	79
List	
Backing Instrument .....	126
Drum Instrument .....	120
Drum Kit .....	118
Parameter .....	130
Preset Percussion Set .....	124
Preset Song .....	128
LocalControl (Local Control) .....	98
Low Gain .....	64

**M**

Mask Time .....	75
Master EQ Sw (Master Equalizer Switch) .....	64
Master Tune .....	78
Master Volume (Master Volume) .....	68
Message .....	116
Metronome .....	43
MIDI .....	96
MIDI Channel .....	102
MIDI COMMON .....	97
MIDI Connectors .....	18, 96
MIDI Implementation .....	135
MIDI PART .....	102
MIDI Settings .....	97
MIX IN Jack .....	18, 53
Mute .....	50, 78, 85

**N**

Name	
Drum Kit .....	69
Song .....	88
Note Chase .....	59, 98
Note No. (Note Number) .....	66

**O**

OUTPUT Jacks .....	18
--------------------	----

**P**

Pad Pattern .....	52, 65
Pad Ptn (Pad Pattern) .....	65
Pad Ptn Velo (Pad Pattern Velocity) .....	65
Pan	
Click .....	81
Drum Instrument .....	61
Part1-Part4 .....	90
Parameter List .....	130
PART .....	88
Part CH (Part Tx Rx Channel) .....	102
PART MUTE Button .....	16
Part Rx Sw (Part Rx Switch) .....	103
PchCtrlRange (Pedal Pitch Control Range) .....	68
PdlDataThin (Pedal Data Thin) .....	99
Pedal Data Thin .....	99
Pedal HH Vol (Pedal Hi-Hat Volume) .....	68
Pedal Pitch Control Range .....	68
PercPrtLevel (Percussion Part Level) .....	77
Percussion Part Level .....	77
Percussion Set .....	89
PHONES Jack .....	18

Pitch .....	61
Pitch Ctrl (Pitch Control Assign) .....	66
PLAY Button .....	16
Play Type .....	86
Playback .....	84
PlyCountIn (Play Count In) .....	81
Polarity Switch .....	21
Power	
Turning Off .....	25
Turning On .....	24
POWER Switch .....	18
Preset Percussion Set List .....	124
Preset Song .....	82
Preset Song List .....	128
Preview .....	58
Preview Velo (Preview Velocity) .....	79
Program Change	
Transmitting/Receiving Program Changes .....	105

**Q**

Quantize .....	95
Quick Play .....	87

**R**

Rear Panel .....	18
REC Button .....	16
RecCountIn (Rec Count In) .....	81
RecMode (Recording Mode) .....	95
Recommended Parameters for the Pads .....	36
Reset (Factory Reset) .....	79
Reset Time .....	87
Restoring the Factory Settings .....	26, 79
Retrig Cancel (Retrigger Cancel) .....	75
Rim Sens .....	76
Rim Shots .....	37
Room Size .....	63
Rx GM On .....	100
Rx PC Sw (Rx PC Switch) .....	102

**S**

Scan Time .....	75
SECURITY LOCK .....	18
Sensitivity .....	32, 73
Set (Percussion Set) .....	89
SETUP	
BULK DUMP .....	103
FactoryReset .....	79
GM PART .....	103
MIDI COMMON .....	97
MIDI PART .....	102
TRIG ADVNCD .....	74
TRIG BASIC .....	72
UTILITY .....	77
SHIFT Button .....	17
SngName (Song Name) .....	88
Soft Thru .....	101
SONG	
COMMON .....	86
COPY .....	90
DELETE .....	91
ERASE .....	92
PART .....	88
Song .....	46, 82
SONG Button .....	17
Song Category .....	84
Song Lock .....	87
Song Name .....	88
Song Screen .....	83
Stand Holder .....	19
STOP Button .....	16
Studio Type .....	62
Sync Mode .....	98
<b>T</b>	
Tap Exc Sw (Tap Exclusive Switch) .....	87
Tempo	
Click .....	45, 80
Song .....	49, 86, 94
Threshold .....	73
Time Sig (Time Signature)	
Click .....	81
Song .....	94
TRIG ADVNCD .....	74
TRIG BASIC .....	72
TrigCurve (Trigger Curve) .....	73
Trigger Input Functions .....	34
TRIGGER INPUTS .....	18
TrigTyp (Trigger Type) .....	30, 71
Troubleshooting .....	110
Tx PC Sw (Tx PC Switch) .....	102

**U**

User Song ..... 82  
UTILITY ..... 77

**V**

Variation Tone ..... 89  
Volume  
    Backing Part ..... 48, 78  
    Click ..... 44  
    Drum Instrument ..... 61  
    Part1-Part4 ..... 89  
    Percussion Part ..... 48, 77  
    Preview ..... 79  
    Song ..... 48  
VOLUME Knob ..... 16

**W**

WallType (Wall Type) ..... 63

**X**

Xtalk Cancel (Crosstalk Cancel) ..... 74

# MEMO

---

# Information

When you need repair service, call your nearest Roland Service Center or authorized Roland distributor in your country as shown below.

## AFRICA

### EGYPT

**Al Fanny Trading Office**  
9, EBN Hagar A1 Askalany Street,  
ARD El Golf, Heliopolis,  
Cairo 11341, EGYPT  
TEL: 20-2-417-1828

### REUNION

**Maison FO - YAM Marcel**  
25 Rue Jules Hermann,  
Chaudron - BP79 97 491  
Ste Clotilde Cedex,  
REUNION ISLAND  
TEL: (0262) 218-429

### SOUTH AFRICA

**That Other Music Shop  
(PTY) Ltd.**  
11 Melle St., Braamfontein,  
Johannesburg, SOUTH AFRICA

P.O.Box 32918, Braamfontein 2017  
Johannesburg, SOUTH AFRICA  
TEL: (011) 403 4105

### Paul Bothner (PTY) Ltd.

17 Werdmuller Centre,  
Main Road, Claremont 7708  
SOUTH AFRICA

P.O.Box 23032, Claremont 7735,  
SOUTH AFRICA  
TEL: (021) 674 4030

## ASIA

### CHINA

**Roland Shanghai Electronics  
Co., Ltd.**  
5F, No.1500 Pingliang Road  
Shanghai, CHINA  
TEL: (021) 5580-0800

### Roland Shanghai Electronics Co., Ltd.

**(BEIJING OFFICE)**  
10F, No.18 Anhuaxili  
Chaoyang District, Beijing,  
CHINA  
TEL: (010) 6426-5050

### HONG KONG

**Tom Lee Music Co., Ltd.  
Service Division**  
22-32 Pun Shan Street, Tsuen  
Wan, New Territories,  
HONG KONG  
TEL: 2415 0911

### INDIA

**Rivera Ditec (India) Pvt. Ltd.**  
409, Nirman Kendra Mahalaxmi  
Flats Compound Off. Dr. Edwin  
Moses Road, Mumbai-400011,  
INDIA  
TEL: (022) 2493 9051

### INDONESIA

**PT Citra IntiRama**  
Jl. Cideng Timur No. 15J-150  
Jakarta Pusat  
INDONESIA  
TEL: (021) 6324170

### KOREA

**Cosmos Corporation**  
1461-9, Seocho-Dong,  
Seocho Ku, Seoul, KOREA  
TEL: (02) 3486-8855

### MALAYSIA

**BENTLEY MUSIC SDN BHD**  
140 & 142, Jalan Bukit Bintang  
55100 Kuala Lumpur, MALAYSIA  
TEL: (03) 2144-3333

### PHILIPPINES

**G.A. Yupangco & Co. Inc.**  
339 Gil J. Puyat Avenue  
Makati, Metro Manila 1200,  
PHILIPPINES  
TEL: (02) 899 9801

### SINGAPORE

**Swee Lee Company**  
150 Sims Drive,  
SINGAPORE 387381  
TEL: 6846-3676

### CRISTOFORI MUSIC PTE LTD

Blk 3014, Bedok Industrial Park E,  
#02-2148, SINGAPORE 489980  
TEL: 6243-9555

### TAIWAN

**ROLAND TAIWAN  
ENTERPRISE CO., LTD.**  
Room 5, 9fl. No. 112 Chung Shan  
N.Road Sec.2, Taipei, TAIWAN,  
R.O.C.  
TEL: (02) 2561 3339

### THAILAND

**Theera Music Co., Ltd.**  
330 Vergng NakornKasem, Soi 2,  
Bangkok 10100, THAILAND  
TEL: (02) 2248821

### VIETNAM

**Saigon Music**  
138 Tran Quang Khai St.,  
District 1  
Ho Chi Minh City  
VIETNAM  
TEL: (08) 844-4068

## AUSTRALIA/ NEW ZEALAND

### AUSTRALIA

**Roland Corporation  
Australia Pty., Ltd.**  
38 Campbell Avenue  
Dee Why West, NSW 2099  
AUSTRALIA  
TEL: (02) 9982 8266

### NEW ZEALAND

**Roland Corporation Ltd.**  
32 Shaddock Street, Mount Eden,  
Auckland, NEW ZEALAND  
TEL: (09) 3098 715

## CENTRAL/LATIN AMERICA

### ARGENTINA

**Instrumentos Musicales S.A.**  
Av.Santa Fe 2055  
(1123) Buenos Aires  
ARGENTINA  
TEL: (011) 4508-2700

### BRAZIL

**Roland Brasil Ltda**  
Rua San Jose, 780 Sala B  
Parque Industrial San Jose  
Cotia - Sao Paulo - SP, BRAZIL  
TEL: (011) 4615 5666

### COSTA RICA

**JUAN BANSBACH  
Instrumentos Musicales**  
Ave.1, Calle 11, Apartado 10237,  
San Jose, COSTA RICA  
TEL: 258-0211

### CHILE

**Commercial Fancy II S.A.**  
Rut. 96.919.420-1  
Nataliel Cox #739, 4th Floor  
Santiago - Centro, CHILE  
TEL: (02) 688-9540

### EL SALVADOR

**OMNI MUSIC**  
75 Avenida Norte y Final  
Alameda Juan Pablo II,  
Edificio No.4010 San Salvador,  
EL SALVADOR  
TEL: 262-0788

### MEXICO

**Casa Veerkamp, s.a. de c.v.**  
Av. Toluca No. 323, Col. Olivar  
de los Padres 01780 Mexico D.F.  
MEXICO  
TEL: (55) 5668-6699

### PANAMA

**SUPRO MUNDIAL, S.A.**  
Boulevard Andrews, Albrook,  
Panama City, REP. DE PANAMA  
TEL: 315-0101

### PARAGUAY

**Distribuidora De  
Instrumentos Musicales**  
J.E. Olear y ESQ. Manduvira  
Asuncion PARAGUAY  
TEL: (021) 492-124

### URUGUAY

**Todo Musica S.A.**  
Francisco Acuna de Figueroa 1771  
C.P.: 11.800  
Montevideo, URUGUAY  
TEL: (02) 924-2335

### VENEZUELA

**Musicland Digital C.A.**  
Av. Francisco de Miranda,  
Centro Parque de Cristal, Nivel  
C2 Local 20 Caracas  
VENEZUELA  
TEL: (212) 285-8586

## EUROPE

### AUSTRIA

**Roland Austria GES.M.B.H.**  
Siemensstrasse 4, P.O. Box 74,  
A-6063 RUM, AUSTRIA  
TEL: (0512) 26 44 260

### BELGIUM/HOLLAND/ LUXEMBOURG

**Roland Benelux N. V.**  
Houtstraat 3, B-2260, Oevel  
(Westerlo) BELGIUM  
TEL: (014) 575811

### DENMARK

**Roland Scandinavia A/S**  
Nordhavnsvej 7, Postbox 880,  
DK-2100 Copenhagen  
DENMARK  
TEL: 3916 6200

### FRANCE

**Roland France SA**  
4, Rue Paul Henri SPAAK,  
Parc de l'Esplanade, F 77 462 St.  
Thibault, Lagny Cedex FRANCE  
TEL: 01 600 73 500

### FINLAND

**Roland Scandinavia As,  
Filial Finland**  
Elannontie 5  
FIN-01510 Vantaa, FINLAND  
TEL: (09) 68 24 020

### GERMANY

**Roland Elektronische  
Musikinstrumente HmbH.**  
Oststrasse 96, 22844 Norderstedt,  
GERMANY  
TEL: (040) 52 60090

### GREECE

**STOLLAS S.A.  
Music Sound Light**  
155, New National Road  
Patras 26442, GREECE  
TEL: 2610 435400

### HUNGARY

**Roland East Europe Ltd.**  
Warehouse Area 'DEPO' Pf.83  
H-2046 Torokbalint, HUNGARY  
TEL: (23) 511011

### IRELAND

**Roland Ireland**  
Audio House, Belmont Court,  
Donnybrook, Dublin 4,  
Republic of IRELAND  
TEL: (01) 2603501

### ITALY

**Roland Italy S. p. a.**  
Viale delle Industrie 8,  
20020 Arese, Milano, ITALY  
TEL: (02) 937-78300

### NORWAY

**Roland Scandinavia Avd.  
Kontor Norge**  
Lilleakerveien 2 Postboks 95  
Lilleaker N-0216 Oslo  
NORWAY  
TEL: 2273 0074

### POLAND

**P. P. H. Brzostowicz**  
UL. Gibraltarska 4,  
PL-03664 Warszawa POLAND  
TEL: (022) 679 44 19

### PORTUGAL

**Tecnologias Musica e Audio,  
Roland Portugal, S.A.**  
Cais Das Pedras, 8/9-1 Dto  
4050-465 PORTO  
PORTUGAL  
TEL: (022) 608 00 60

### ROMANIA

**FBS LINES**  
Piata Libertatii 1,  
RO-4200 Gheorghhehi  
TEL: (095) 169-5043

### RUSSIA

**MuTek**  
3-Bogatyrskaya Str. 1.k.1  
107 564 Moscow, RUSSIA  
TEL: (095) 169 5043

### SPAIN

**Roland Electronics  
de España, S. A.**  
Calle Bolivia 239, 08020  
Barcelona, SPAIN  
TEL: (93) 308 1000

### SWEDEN

**Roland Scandinavia A/S  
SWEDISH SALES OFFICE**  
Danvig Center 28, 2 tr.  
S-131 30 Nacka SWEDEN  
TEL: (08) 702 00 20

### SWITZERLAND

**Roland (Switzerland) AG**  
Landstrasse 5, Postfach,  
CH-4452 Itingen,  
SWITZERLAND  
TEL: (061) 927-8383

### UKRAINE

**TIC-TAC**  
Mira Str. 19/108  
P.O. Box 180  
295400 Munkachevo, UKRAINE  
TEL: (03131) 414-40

### UNITED KINGDOM

**Roland (U.K.) Ltd.**  
Atlantic Close, Swansea  
Enterprise Park, SWANSEA  
SA7 9FL,  
UNITED KINGDOM  
TEL: (01792) 702701

## MIDDLE EAST

### BAHRAIN

**Moon Stores**  
No.16, Bab Al Bahrain Avenue,  
P.O.Box 247, Manama 304,  
State of BAHRAIN  
TEL: 211 005

### CYPRUS

**Radex Sound Equipment Ltd.**  
17, Diagorou Street, Nicosia,  
CYPRUS  
TEL: (022) 66-9426

### IRAN

**MOCO, INC.**  
No.41 Nike St., Dr.Shariyati Ave.,  
Roberoye Cerah Mirdamad  
Tehran, IRAN  
TEL: (021) 285-4169

### ISRAEL

**Halilit P. Greenspoon &  
Sons Ltd.**  
8 Retzif Ha'aliya Hashnya St.  
Tel-Aviv-Yafa ISRAEL  
TEL: (03) 6823666

### JORDAN

**AMMAN Trading Agency**  
245 Prince Mohammad St.,  
Amman 1118, JORDAN  
TEL: (06) 464-1200

### KUWAIT

**Easa Husain Al Yousifi Est.**  
Abdullah Salem Street,  
Safat, KUWAIT  
TEL: 243-6399

### LEBANON

**Chahine S.A.L.**  
Gerge Zeidan St., Chahine Bldg.,  
Achrifeh, P.O.Box: 16-5857  
Beirut, LEBANON  
TEL: (01) 20-1441

### QATAR

**Al Emadi Co. (Badie Studio  
& Stores)**  
P.O. Box 62,  
Doha, QATAR  
TEL: 4423-554

### SAUDI ARABIA

**aDawlah Universal  
Electronics APL**  
Corniche Road, Aldossary Bldg.,  
1st Floor, Alkhobar,  
SAUDI ARABIA

P.O.Box 2154, Alkhobar 31952  
SAUDI ARABIA  
TEL: (03) 898 2081

### SYRIA

**Technical Light & Sound  
Center**  
Khaled Ebn Al Walid St.  
Bldg. No. 47, P.O. BOX 13520,  
Damascus, SYRIA  
TEL: (011) 223-5384

### TURKEY

**Barkat muzik atletleri ithalat  
ve ihracat Ltd Sti**  
Siraselvilir Caddesi Siraselvilir  
Pasaji No:74/20  
Taksim - Istanbul, TURKEY  
TEL: (0212) 2499324

### U.A.E.

**Zak Electronics & Musical  
Instruments Co. L.L.C.**  
Zabeel Road, Al Sherooq Bldg.,  
No. 14, Grand Floor, Dubai, U.A.E.  
TEL: (04) 3360715

## NORTH AMERICA

### CANADA

**Roland Canada Music Ltd.  
(Head Office)**  
5480 Parkwood Way Richmond  
B. C., V6V 2M4 CANADA  
TEL: (604) 270 6626

### Roland Canada Music Ltd. (Toronto Office)

170 Admiral Boulevard  
Mississauga On L5T 2N6  
CANADA  
TEL: (905) 362 9707

### U. S. A.

**Roland Corporation U.S.**  
5100 S. Eastern Avenue  
Los Angeles, CA 90040-2938,  
U. S. A.  
TEL: (323) 890 3700

For EU Countries

## Apparatus containing Lithium batteries

### ADVARSEL!

Lithiumbatteri - Eksplosionsfare ved fejlagtig håndtering.  
Udskiftning må kun ske med batteri af samme fabrikat og type.  
Levér det brugte batteri tilbage til leverandøren.

### ADVARSEL

Eksplosjonsfare ved feilaktig skifte av batteri.  
Benytt samme batteritype eller en tilsvarende type anbefalt av apparatfabrikanten.  
Brukte batterier kasseres i henhold til fabrikantens instruksjoner.

### CAUTION

Danger of explosion if battery is incorrectly replaced.  
Replace only with the same or equivalent type recommended by the manufacturer.  
Discard used batteries according to the manufacturer's instructions.

### VARNING

Explosionsfara vid felaktigt batteribyte.  
Använd samma batterityp eller en ekvivalent typ som rekommenderas av apparattillverkaren.  
Kassera använt batteri enligt fabrikantens instruktion.

### VAROITUS

Paristo voi räjähtää, jos se on virheellisesti asennettu.  
Vaihda paristo ainoastaan laitevalmistajan suosittelemaan tyyppiin. Hävitä käytetty paristo valmistajan ohjeiden mukaisesti.

For EU Countries



This product complies with the requirements of European Directive 89/336/EEC.

For the USA

## FEDERAL COMMUNICATIONS COMMISSION RADIO FREQUENCY INTERFERENCE STATEMENT

This equipment has been tested and found to comply with the limits for a Class B digital device, pursuant to Part 15 of the FCC Rules. These limits are designed to provide reasonable protection against harmful interference in a residential installation. This equipment generates, uses, and can radiate radio frequency energy and, if not installed and used in accordance with the instructions, may cause harmful interference to radio communications. However, there is no guarantee that interference will not occur in a particular installation. If this equipment does cause harmful interference to radio or television reception, which can be determined by turning the equipment off and on, the user is encouraged to try to correct the interference by one or more of the following measures:

- Reorient or relocate the receiving antenna.
- Increase the separation between the equipment and receiver.
- Connect the equipment into an outlet on a circuit different from that to which the receiver is connected.
- Consult the dealer or an experienced radio/TV technician for help.

This device complies with Part 15 of the FCC Rules. Operation is subject to the following two conditions:

- (1) This device may not cause harmful interference, and
- (2) This device must accept any interference received, including interference that may cause undesired operation.

Unauthorized changes or modification to this system can void the users authority to operate this equipment.  
This equipment requires shielded interface cables in order to meet FCC class B Limit.

For Canada

## NOTICE

This Class B digital apparatus meets all requirements of the Canadian Interference-Causing Equipment Regulations.

## AVIS

Cet appareil numérique de la classe B respecte toutes les exigences du Règlement sur le matériel brouilleur du Canada.

