

# MULTI-FORMAT CONVERTER

# VC-300HD

# VC-200HD

## Owner's Manual

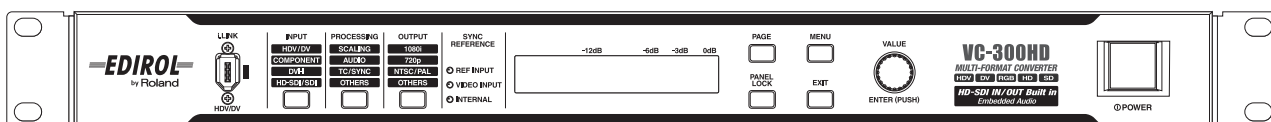
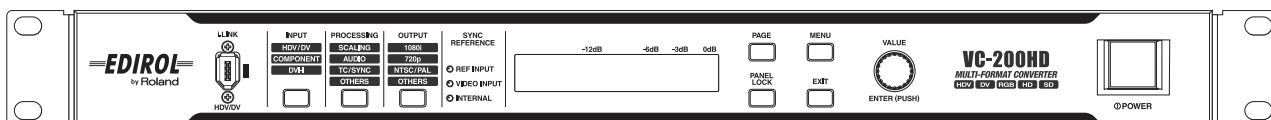



This manual describes the VC-300HD and the VC-200HD. When reading this manual, please note the following.

- VC-300HD-specific features are marked with **VC-300HD** in the title.
- The illustrations used for this manual's explanations depict the VC-300HD. Some of the panel inscriptions and connectors on the VC-200HD are different.

Before using this unit, carefully read the sections entitled: "IMPORTANT SAFETY INSTRUCTIONS" (p. 2), "USING THE UNIT SAFELY" (p. 4–5), and "IMPORTANT NOTES" (p. 6). These sections provide important information concerning the proper operation of the unit. Additionally, in order to feel assured that you have gained a good grasp of every feature provided by your new unit, Owner's Manual should be read in its entirety. The manual should be saved and kept on hand as a convenient reference.

**WARNING:** To reduce the risk of fire or electric shock, do not expose this apparatus to rain or moisture.

 <div style="display: inline-block; border: 1px solid black; padding: 2px; text-align: center; font-weight: bold; font-size: 0.8em;"> <b>CAUTION</b>              RISK OF ELECTRIC SHOCK              DO NOT OPEN         </div> 
<b>ATTENTION:</b> RISQUE DE CHOC ELECTRIQUE NE PAS OUVRIR
<p><b>CAUTION:</b> TO REDUCE THE RISK OF ELECTRIC SHOCK, DO NOT REMOVE COVER (OR BACK). NO USER-SERVICEABLE PARTS INSIDE. REFER SERVICING TO QUALIFIED SERVICE PERSONNEL.</p>



The lightning flash with arrowhead symbol, within an equilateral triangle, is intended to alert the user to the presence of uninsulated "dangerous voltage" within the product's enclosure that may be of sufficient magnitude to constitute a risk of electric shock to persons.



The exclamation point within an equilateral triangle is intended to alert the user to the presence of important operating and maintenance (servicing) instructions in the literature accompanying the product.

**INSTRUCTIONS PERTAINING TO A RISK OF FIRE, ELECTRIC SHOCK, OR INJURY TO PERSONS.**

# IMPORTANT SAFETY INSTRUCTIONS

## SAVE THESE INSTRUCTIONS

**WARNING -** When using electric products, basic precautions should always be followed, including the following:

1. Read these instructions.
2. Keep these instructions.
3. Heed all warnings.
4. Follow all instructions.
5. Do not use this apparatus near water.
6. Clean only with a dry cloth.
7. Do not block any of the ventilation openings. Install in accordance with the manufacturers instructions.
8. Do not install near any heat sources such as radiators, heat registers, stoves, or other apparatus (including amplifiers) that produce heat.
9. Do not defeat the safety purpose of the polarized or grounding-type plug. A polarized plug has two blades with one wider than the other. A grounding type plug has two blades and a third grounding prong. The wide blade or the third prong are provided for your safety. If the provided plug does not fit into your outlet, consult an electrician for replacement of the obsolete outlet.
10. Protect the power cord from being walked on or pinched particularly at plugs, convenience receptacles, and the point where they exit from the apparatus.
11. Only use attachments/accessories specified by the manufacturer.
12. Unplug this apparatus during lightning storms or when unused for long periods of time.
13. Refer all servicing to qualified service personnel. Servicing is required when the apparatus has been damaged in any way, such as power-supply cord or plug is damaged, liquid has been spilled or objects have fallen into the apparatus, the apparatus has been exposed to rain or moisture, does not operate normally, or has been dropped.

**For the U.K.**

**WARNING:** THIS APPARATUS MUST BE EARTHED  
**IMPORTANT:** THE WIRES IN THIS MAINS LEAD ARE COLOURED IN ACCORDANCE WITH THE FOLLOWING CODE.  
 GREEN-AND-YELLOW: EARTH, BLUE: NEUTRAL, BROWN: LIVE

As the colours of the wires in the mains lead of this apparatus may not correspond with the coloured markings identifying the terminals in your plug, proceed as follows:

The wire which is coloured GREEN-AND-YELLOW must be connected to the terminal in the plug which is marked by the letter E or by the safety earth symbol  or coloured GREEN or GREEN-AND-YELLOW.

The wire which is coloured BLUE must be connected to the terminal which is marked with the letter N or coloured BLACK.

The wire which is coloured BROWN must be connected to the terminal which is marked with the letter L or coloured RED.

**For the USA**

### DECLARATION OF CONFORMITY

#### Compliance Information Statement

Model Name : VC-300HD / VC-200HD  
 Type of Equipment : Multi-Format Converter  
 Responsible Party : Roland Systems Group U.S.  
 Address : 425 Sequoia Drive Suite 114, Bellingham, Washington, 98226 USA  
 Telephone : TEL: 360-594-4282



# Table of Contents

<b>USING THE UNIT SAFELY</b> .....	4
<b>IMPORTANT NOTES</b> .....	6
<b>Features</b> .....	7
<b>Checking the Included Items</b> .....	8
<b>Basic Operation</b> .....	<b>9</b>
<b>Panel Descriptions</b> .....	<b>10</b>
Front Panel .....	10
Side Panel .....	11
Rear Panel.....	12
<b>Connecting</b> .....	<b>14</b>
Converting HD Component to HDV .....	15
Converting HD-SDI to HDV .....	17
Converting computer screens (DVI or VGA) to HDV .....	19
Converting HDV to HD Component .....	21
Converting HDV to HD-SDI .....	23
Installation.....	25
<b>Basic Operations</b> .....	<b>26</b>
Turning Power On/Off .....	26
Turning power on .....	26
Turning power off .....	26
Selecting the video input connector.....	26
Selecting the audio input connector.....	27
Selecting the video output format .....	27
Test Pattern / Test Tone Output .....	28
Setting internal processing.....	28
Showing the Display.....	29
Status Screen .....	29
Menu Display and Operation .....	30
Adjusting the Display .....	30
<b>Appendices</b> .....	<b>31</b>
<b>Menus and settings</b> .....	<b>32</b>
<b>Input / Output Signal</b> .....	<b>38</b>
HDV .....	38
SDI.....	38
DV .....	38
DVI.....	38
Interlaced and Progressive .....	38
<b>Installation and Maintenance</b> .....	<b>39</b>
Installing and Removing the Rack Mount Fittings .....	39
Daily Maintenance .....	39
Fan.....	39
<b>Troubleshooting</b> .....	<b>40</b>
Video.....	40
Audio.....	40
Miscellaneous .....	40
<b>Main Specifications</b> .....	<b>41</b>
Exterior Dimensions Diagram .....	42
VC-200HD Block Diagram .....	43
VC-300HD Block Diagram .....	44
Output Format Support Chart.....	45
<b>Index</b> .....	<b>46</b>







# USING THE UNIT SAFELY

## INSTRUCTIONS FOR THE PREVENTION OF FIRE, ELECTRIC SHOCK, OR INJURY TO PERSONS

About  WARNING and  CAUTION Notices







 <b>WARNING</b>	Used for instructions intended to alert the user to the risk of death or severe injury should the unit be used improperly.
 <b>CAUTION</b>	Used for instructions intended to alert the user to the risk of injury or material damage should the unit be used improperly. * Material damage refers to damage or other adverse effects caused with respect to the home and all its furnishings, as well to domestic animals or pets.

About the Symbols







	The  symbol alerts the user to important instructions or warnings. The specific meaning of the symbol is determined by the design contained within the triangle. In the case of the symbol at left, it is used for general
	The  symbol alerts the user to items that must never be carried out (are forbidden). The specific thing that must not be done is indicated by the design contained within the circle. In the case of the symbol at left, it means that the unit must never be disassembled.
	The  symbol alerts the user to things that must be carried out. The specific thing that must be done is indicated by the design contained within the circle. In the case of the symbol at left, it means that the power-cord plug must be unplugged from the outlet.

### ALWAYS OBSERVE THE FOLLOWING







#### WARNING

- Before using this unit, make sure to read the instructions below, and the Owner's Manual. 
- Connect mains plug of this model to a mains socket outlet with a protective earthing connection. 
- Do not open or perform any internal modifications on the unit. 
- Do not attempt to repair the unit, or replace parts within it (except when this manual provides specific instructions directing you to do so). Refer all servicing to your retailer, the nearest Roland Service Center, or an authorized Roland distributor, as listed on the "Information" page. 
- Never use or store the unit in places that are:
  - Subject to temperature extremes (e.g., direct sunlight in an enclosed vehicle, near a heating duct, on top of heat-generating equipment); or are 
  - Damp (e.g., baths, washrooms, on wet floors); or are 
  - Humid; or are
  - Exposed to rain; or are
  - Dusty; or are
  - Subject to high levels of vibration.











#### WARNING

- Make sure you always have the unit placed so it is level and sure to remain stable. Never place it on stands that could wobble, or on inclined surfaces. 
- The unit should be connected to a power supply only of the type described in the operating instructions, or as marked on the top of unit. 
- Use only the attached power-supply cord. Also, the supplied power cord must not be used with any other device. 
- Do not excessively twist or bend the power cord, nor place heavy objects on it. Doing so can damage the cord, producing severed elements and short circuits. Damaged cords are fire and shock hazards! 
- This unit, either alone or in combination with an amplifier and headphones or speakers, may be capable of producing sound levels that could cause permanent hearing loss. Do not operate for a long period of time at a high volume level, or at a level that is uncomfortable. If you experience any hearing loss or ringing in the ears, you should immediately stop using the unit, and consult an audiologist. 
- Do not allow any objects (e.g., flammable material, coins, pins); or liquids of any kind (water, soft drinks, etc.) to penetrate the unit.   

**⚠ WARNING**

- Immediately turn the power off, remove the power cord from the outlet, and request servicing by your retailer, the nearest Roland Service Center, or an authorized Roland distributor, as listed on the “Information” page when:
  - The power-supply cord, or the plug has been damaged; or
  - If smoke or unusual odor occurs
  - Objects have fallen into, or liquid has been spilled onto the unit; or
  - The unit has been exposed to rain (or otherwise has become wet); or
  - The unit does not appear to operate normally or exhibits a marked change in performance.
- In households with small children, an adult should provide supervision until the child is capable of following all the rules essential for the safe operation of the unit.
 
- Protect the unit from strong impact. (Do not drop it!)
 
- Do not force the unit’s power-supply cord to share an outlet with an unreasonable number of other devices. Be especially careful when using extension cords—the total power used by all devices you have connected to the extension cord’s outlet must never exceed the power rating (watts/amperes) for the extension cord. Excessive loads can cause the insulation on the cord to heat up and eventually melt through.
 
- Before using the unit in a foreign country, consult with your retailer, the nearest Roland Service Center, or an authorized Roland distributor, as listed on the “Information” page.
 
- Do not put anything that contains water (e.g., flower vases) on this unit. Also, avoid the use of insecticides, perfumes, alcohol, nail polish, spray cans, etc., near the unit. Swiftly wipe away any liquid that spills on the unit using a dry, soft cloth.
 

**⚠ CAUTION**

- The unit should be located so that its location or position does not interfere with its proper ventilation.
 
- Always grasp only the plug on the power-supply cord when plugging into, or unplugging from, an outlet or this unit.
 
- At regular intervals, you should unplug the power plug and clean it by using a dry cloth to wipe all dust and other accumulations away from its prongs. Also, disconnect the power plug from the power outlet whenever the unit is to remain unused for an extended period of time. Any accumulation of dust between the power plug and the power outlet can result in poor insulation and lead to fire.
 
- Try to prevent cords and cables from becoming entangled. Also, all cords and cables should be placed so they are out of the reach of children.
 
- Never climb on top of, nor place heavy objects on the unit.
 
- Never handle the power cord or its plugs with wet hands when plugging into, or unplugging from, an outlet or this unit.
 
- Before moving the unit, disconnect the power plug from the outlet, and pull out all cords from external devices.
 
- Before cleaning the unit, turn off the power and unplug the power cord from the outlet p. 26
 
- Whenever you suspect the possibility of lightning in your area, pull the plug on the power cord out of the outlet.
 
- Should you remove screws and rubber feet, keep them in a safe place out of children’s reach, so there is no chance of them being swallowed accidentally.
 

# IMPORTANT NOTES

In addition to the items listed under “IMPORTANT SAFETY INSTRUCTIONS” and “USING THE UNIT SAFELY” on pages 2 and 4–5, please read and observe the following:

## Power Supply

- Do not connect this unit to same electrical outlet that is being used by an electrical appliance that is controlled by an inverter (such as a refrigerator, washing machine, microwave oven, or air conditioner), or that contains a motor. Depending on the way in which the electrical appliance is used, power supply noise may cause this unit to malfunction or may produce audible noise. If it is not practical to use a separate electrical outlet, connect a power supply noise filter between this unit and the electrical outlet.
- Before connecting this unit to other devices, turn off the power to all units. This will help prevent malfunctions and/or damage to speakers or other devices.
- Although the LCD and LEDs are switched off when the POWER switch is switched off, this does not mean that the unit has been completely disconnected from the source of power. If you need to turn off the power completely, first turn off the POWER switch, then unplug the power cord from the power outlet. For this reason, the outlet into which you choose to connect the power cord’s plug should be one that is within easy reach and readily accessible.

## Placement

- Using the unit near power amplifiers (or other equipment containing large power transformers) may induce hum. To alleviate the problem, change the orientation of this unit; or move it farther away from the source of interference.
- This device may interfere with radio and television reception. Do not use this device in the vicinity of such receivers.
- Noise may be produced if wireless communications devices, such as cell phones, are operated in the vicinity of this unit. Such noise could occur when receiving or initiating a call, or while conversing. Should you experience such problems, you should relocate such wireless devices so they are at a greater distance from this unit, or switch them off.
- When moved from one location to another where the temperature and/or humidity is very different, water droplets (condensation) may form inside the unit. Damage or malfunction may result if you attempt to use the unit in this condition. Therefore, before using the unit, you must allow it to stand for several hours, until the condensation has completely evaporated.
- Depending on the material and temperature of the surface on which you place the unit, its rubber feet may discolor or mar the surface.  
You can place a piece of felt or cloth under the rubber feet to prevent this from happening. If you do so, please make sure that the unit will not slip or move accidentally.

## Maintenance

- For everyday cleaning wipe the unit with a soft, dry cloth or one that has been slightly dampened with water. To remove stubborn dirt, use a cloth impregnated with a mild, non-abrasive detergent. Afterwards, be sure to wipe the unit thoroughly with a soft, dry cloth.
- Never use benzine, thinners, alcohol or solvents of any kind, to avoid the possibility of discoloration and/or deformation.

## Copyright

- Do not use this unit for purposes that could infringe on a copyright held by a third party. We assume no responsibility whatsoever with regard to any infringements of third-party copyrights arising through your use of this unit.

## Additional Precautions

- Use a reasonable amount of care when using the unit’s buttons, sliders, or other controls; and when using its jacks and connectors. Rough handling can lead to malfunctions.
- Never strike or apply strong pressure to the display.
- When connecting / disconnecting all cables, grasp the connector itself—never pull on the cable. This way you will avoid causing shorts, or damage to the cable’s internal elements.
- A small amount of heat will radiate from the unit during normal operation.
- To avoid disturbing your neighbors, try to keep the unit’s volume at reasonable levels (especially when it is late at night).
- When you need to transport the unit, package it in the box (including padding) that it came in, if possible. Otherwise, you will need to use equivalent packaging materials.
- Some connection cables contain resistors. Do not use cables that incorporate resistors for connecting to this unit. The use of such cables can cause the sound level to be extremely low, or impossible to hear. For information on cable specifications, contact the manufacturer of the cable.

\* All product names mentioned in this document are trademarks or registered trademarks of their respective owners.

# Features

## **HDV/DV Conversion Feature**

This converts analog component, DVI-I, or SDI (HD/SD) signals to HDV or DV in real time. It can also go the other way and convert HDV or DV streams to analog component, DVI, or SDI (HD/SD) signals.

\* Only the VC-300HD supports SDI signals.

## **High-performance Scaler**

The unit has a built-in scaler that can convert input video to video formats having a different number of pixels. For example, it's possible to convert 720p video, or RGB video from a computer, to 1080i.

## **High-quality 4:4:4 10-bit Processing**

The VC-200HD/VC-300HD use 4:4:4/10-bit processing for video calculations. Analog component input is also digitized at 4:4:4 with 10-bit depth. This means that video handled by the unit is processed at the highest quality possible, so there is no degradation.

## **Simultaneous Output**

Converted video is simultaneously output to each output connector.

\* See p. 45 for the relationship between formats and the connectors that can provide a particular type of output. With certain combinations, some output connectors cannot provide output in the selected video format with some combinations.

## **HD-SDI Input and Output**

This VC-300HD is capable of SDI (HD/SD) input and output. This lets you input video digitally from commercial-use video equipment using a single BNC cable.

## **Component Input and Output**

You can input and output HD and SD video using analog components. For instance, it's possible to convert output from the V-440HD Multi-format Video Mixer to HDV or HD-SDI. You can then input the converted video to an HDV video deck or HD device for recording.

## **DVI-I Input**

RGB video from a computer can be input, so you can record presentations and the like on HDV or other video formats. Because DVI-I is supported, you can use either analog or digital signals.

## **Reference-signal Input and Output**

The unit's external synchronizing-signal input is compatible with black burst as well as 2-level and 3-level synchronization. This lets you synchronize the unit to existing house sync.

## **Audio Input and Output with Audio Delay**

You can input analog audio and embed it in HDV or SDI video. What's more, you can set an audio delay, enabling you to delay the audio so it matches a video signal that's been delayed as the result of being routed through a switcher (or for some other reason). You can even make delay settings for audio data input from HDV or SDI.

# Checking the Included Items

The VC-300HD/VC-200HD is packaged with the following items. Please check that all of the items are included.

\* If you find that any item is missing, contact the nearest authorized EDIROL/Roland distributor in your country.

**VC-300HD / VC-200HD**



**Power Cord**

\* Use only the attached power-supply cord.

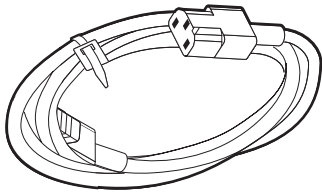

**Rubber Feet (4)**

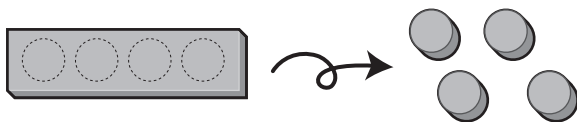

\* The rubber feet are arranged onto one pad. Please remove from the pad to use them.

**Owner's Manual**





# Basic Operation

---

# Panel Descriptions

## Front Panel

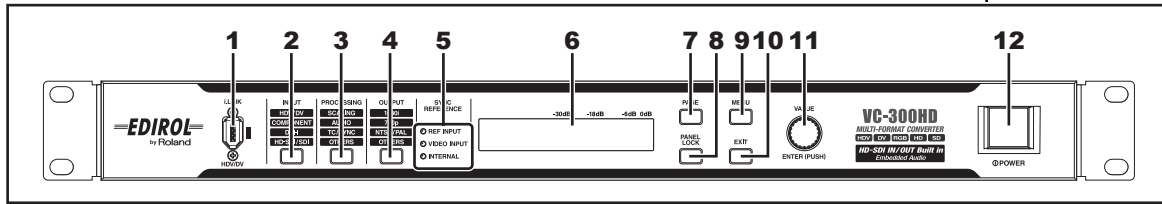

### 1 i.LINK Connector (Front Panel)

This connector handles the input/output of HDV/DV signals and allows for connection of HDV/DV video equipment.

- \* Please do not use this together with the i.LINK connector (p. 13) on the rear panel of the unit. If they are used together, the connected video equipment may not operate properly.

### 2 INPUT Button

Displays the menu for selecting the input connectors for audio and video (p. 26 and p. 27). The menu screen changes each time the INPUT button is pressed. The values of settings are changed with the VALUE/ENTER knob.



Menu displayed when the INPUT button is pressed

- \* When a connector with no input is selected, a black matte image is output.

### 3 PROCESSING Button

Displays the menu for setting internal processing for audio and video (p. 28). The menu screen changes each time the PROCESSING button is pressed. The values of settings are changed with the VALUE/ENTER knob.

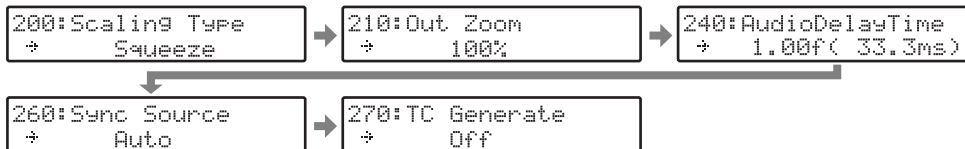

Menu displayed when the PROCESSING button is pressed

### 4 OUTPUT Button

Displays the screen for selecting the video output format and test pattern (p. 27 and p. 28). The menu screen changes each time the OUTPUT button is pressed. The values of settings are changed with the VALUE/ENTER knob.

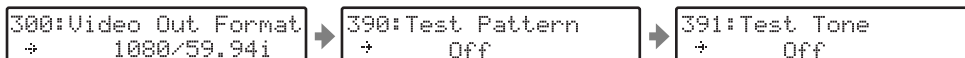

Menu displayed when the OUTPUT button is pressed

### 5 SYNC REFERENCE Indicators

These display the synchronizing signal that has been selected.

Indicator	Selected synchronizing signal
REF INPUT	Uses an external synchronizing signal input via the REF INPUT connector (p. 13).
VIDEO INPUT	Uses the synchronizing signal in the incoming video signal.
INTERNAL	Uses the synchronizing signal in the incoming video signal.

- \* The synchronizing signal can be set with "260: Sync Source," which can be accessed by pressing the PROCESSING button a number of times. See "Setting internal processing" (p. 28) for details.
- \* The synchronizing signal can also be set with "260: Sync Source" (p. 34) from the Menu (p. 30).

#### MEMO

See "Input Format Table" and "Output Format Table" (p. 13) for the signal formats that can be input to, or output from the i.LINK connector.

#### MEMO

The i.LINK connector on this device is a dedicated HDV/DV signal connector. The following devices cannot be connected because the signal is not compatible.

- i.LINK connectors of MicroMV format digital video cameras (MicroMV signal)
- i.LINK connectors on D-VHS decks (MPEG-TS signal)

#### MEMO

No picture is output from a connector that isn't compatible with the selected output format.

#### MEMO

The indicator blinks in the following situations.

- The selected synchronizing signal is not being input
- A synchronizing signal that is different from the output format (p. 27) is being input
- The synchronizing signal cannot be locked

**6 Display**

Shows the Status screens (four types) indicating the status of the unit. Pressing the PAGE button cycles you through the Status screens. The Menu screen is displayed by pressing MENU button. While the Menu screen is displayed, the MENU button is lit.

**7 PAGE Button**

Pressed to select what is shown in the display, such as the Status screen or Menu screen.

**8 PANEL LOCK Button**

Locks front panel operations. To release panel lock, press and hold down the PANEL LOCK button for at least two seconds.

**9 MENU Button**

Shows the menu on the display. If the MENU button is pressed while the Menu is displayed, the unit exits from the Menu screen and returns to the Status screen. Various settings are made with the menu. See "Menu Display and Operation" (p. 30) for details.

**10 EXIT Button**

Cancels the content shown in the menu. If the EXIT button is pressed while an item number (p. 30) is blinking, the unit exits from the Menu screen and returns to the Status screen. If the EXIT button is pressed while a setting's value (p. 30) is blinking, the selected value is canceled.

**11 VALUE/ENTER Knob**

Menu items can be selected by turning the knob clockwise or counterclockwise. Press the knob to select the value for a setting that is displayed onscreen with menu operations.

**12 Power Button**

Switches the unit's power on and off.

**Side Panel**

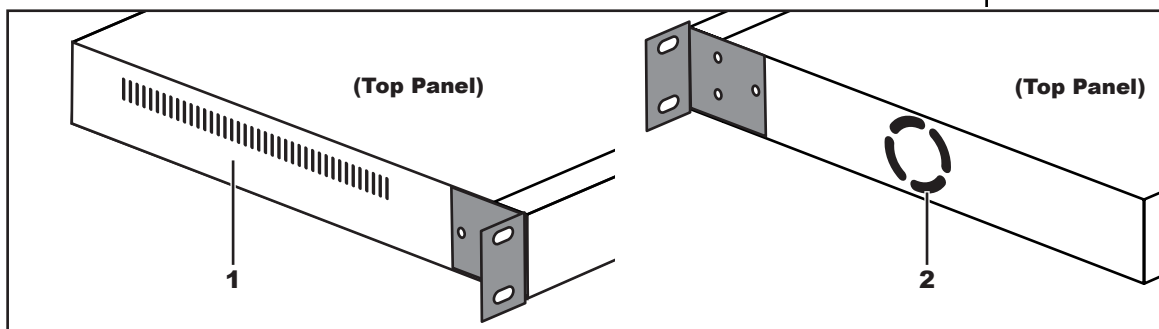

**1 Cooling fan intake vent**

**2 Cooling fan exhaust vent**

The internal cooling fan regulates temperature increases inside the unit. The internal heat is expelled from this side.

\* Please do not block the cooling fan intake vent or exhaust vent. If the exhaust or intake vent is blocked, the internal temperature will rise and heat damage may occur.

# Rear Panel

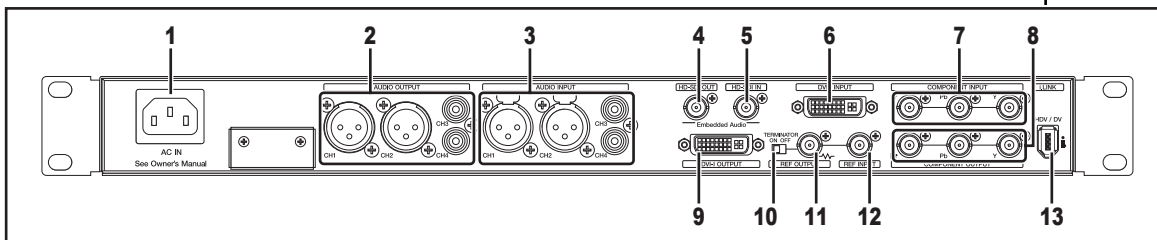

## 1 AC Inlet

Accepts connection of the supplied power cord.

## 2 AUDIO OUTPUT Connectors

**CH1 and CH2 Connectors (XLR Type/Balanced Type)**

**CH3 and CH4 Connectors (RCA Phono Type, Unbalanced Input)**

These connectors provide output of analog audio. Here is where you connect equipment such as monitoring speakers or a television, or a video deck if you intend to record the output.

- \* This device is equipped with balanced (XLR) type jacks. Wiring diagrams for these jacks are shown to the right. Make connections after first checking the wiring diagrams of other equipment you intend to connect.

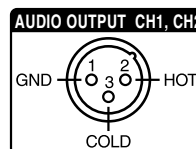

## 3 AUDIO INPUT Connectors

**CH1 and CH2 Connectors (XLR Type/Balanced Type)**

**CH3 and CH4 Connectors (RCA Phono Type, Unbalanced Input)**

These are connectors for inputting analog audio. Audio to be embedded in HDV, DV, and SDI is input here.

- \* Audio that is included with HDV or DV is output from the AUDIO OUTPUT connectors CH1/CH2 or CH3/CH4.
- \* This instrument is equipped with balanced (XLR) type jacks. Wiring diagrams for these jacks are shown to the right. Make connections after first checking the wiring diagrams of other equipment you intend to connect.

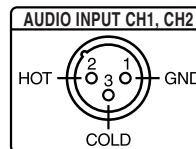

## 4 HD-SDI OUT Connector **VC-300HD**

This connector outputs SDI. Switching of HD-SDI/SD-SDI output takes place automatically when the procedure in "Selecting the video output format" (p. 27) is used to change the output format.

## 5 HD-SDI IN Connector **VC-300HD**

This connector receives SDI input. The input SDI is automatically identified as either HD-SDI or SD-SDI.

## 6 DVI-I INPUT Connector

This connector receives DVI-I signal input. Video that is output from a PC or other DVI output device is input here. The input video format is automatically identified.

## 7 COMPONENT INPUT Connectors

This connector receives component (Y, Pb, Pr) input. HD component video signals from HD devices such as the EDIROL V-440HD and SD component video signals from devices such as DVDs are input here. The HD signals and SD signals are automatically identified.

## 8 COMPONENT OUTPUT Connectors

These connectors are for outputting component video signals. They are for connecting equipment such as a monitor television, video mixer, etc.

## 9 DVI-I OUT Connector

This connector is for outputting a DVI-I signal. This is typically for connecting a flat-screen monitor or television monitor capable of receiving DVI-I signals.

### MEMO

See the tables to the right for the signal formats that can be input or output to each connector.

### MEMO

You can apply delay to output audio. For more information, refer to 240: "AudioDelay Time" (p. 34).

### MEMO

When connection cables with resistors are used, the volume level of equipment connected to the inputs (AUDIO INPUT, AUDIO OUTPUT) may be low. If this happens, use connection cables that do not contain resistors.

### MEMO

See p. 13 for the signal formats that can be input to, or output from the HD-SDI INPUT and HD-SDI OUT connectors.

### HINT

**DVI-I**  
DVI-I receives analog and digital video signals. VGA (D-sub 15-pin) is connected via a commercially available DVI-VGA conversion adapter. This manual uses DVI-A to denote analog video signals input from DVI-I and DVI-D to denote digital video signals.

\* See "DVI" (p. 38) for details.

**10 TERMINATOR Switch**

Switch this on when you don't want to loop-through the synchronizing signal from the REF OUTPUT connector.

**11 REF OUTPUT Connector**

This is the loop through output connector for external synchronizing signals input via the REF INPUT connector. It is connected to the external synchronizing signal input connector of the video equipment to which the unit is synchronized. When using this connector, turn the TERMINATOR switch off.

**12 REF INPUT Connector**

This connector is for inputting the synchronizing signal when operating the unit with external synchronization. Connect a sync-signal generator or the like here.

**13 i.LINK Connector (Rear Panel)**

This connector is for HDV/DV signal input and output. You can connect HDV/DV video equipment here.

\* Please do not use this together with the i.LINK connector (p. 8) on the front panel of the unit. If they are used together, the connected video equipment may not operate properly.

The specifications and appearance of this product are subject to change without notice.

**Input Format Table**

i.LINK Connector	HDV	1080/59.94i, 1080/50i, 720/59.94p, 720/50p
	DV	480/59.94i (NTSC), 576/50i (PAL)
COMPONENT INPUT Connectors	Y/Pb/Pr	1080/59.94i, 1080/50i, 720/59.94p, 720/50p, 480/59.94p, 576/50p, 480/59.94i (NTSC), 576/50i (PAL)
DVI-I INPUT Connector	Digital (RGB)	1600x1200/60Hz, 1400x1050/60/75Hz, 1366x768/60, 1280x1024/60/75Hz, 1280x768/60/75Hz, 1280x960/60Hz, 1152x864/75Hz, 1024x768/60/75Hz, 800x600/60/75Hz, 640x480/60/75Hz
	Analog (Y/Pb/Pr)	1024x768/60Hz, 800x600/60/75Hz, 640x480/60/75Hz
HD-SDI IN Connector	Digital	1080/59.94i, 1080/50i, 720/59.94p, 720/50p, 480/59.94i (NTSC), 576/50i (PAL)

\* If video in a format not listed above is input, it will not be displayed correctly.

**Output Format Table**

i.LINK Connector	HDV	1080/59.94i, 1080/50i, 720/59.94p, 720/50p
	DV	480/59.94i (NTSC), 576/50i (PAL)
COMPONENT OUTPUT Connectors	Y/Pb/Pr	1080/59.94p, 1080/50p, 1080/59.94i, 1080/50i, 720/59.94p, 720/50p, 480/59.94p, 576/50p, 480/59.94i (NTSC), 576/50i (PAL)
DVI-I OUT Connector	Digital (RGB)	1080/59.94p, 1080/50p, 1080/59.94i, 1080/50i, 720/59.94p, 720/50p, 480/59.94p, 576/50p, 480/59.94i (NTSC), 576/50i (PAL)
	Analog (Y/Pb/Pr)	1080/59.94p, 1080/50p, 1080/59.94i, 1080/50i, 720/59.94p, 720/50p, 480/59.94p, 576/50p, 480/59.94i (NTSC), 576/50i (PAL)
HD-SDI OUT Connector	Digital	1080/59.94i, 1080/50i, 720/59.94p, 720/50p, 480/59.94i (NTSC), 576/50i (PAL)

**MEMO**

See the tables to the right for the signal formats that can be input or output to each connector.

**MEMO**

The actual name of the "external synchronizing-signal input connector" may vary from one video device to another.

# Connecting

Connect the VC-200HD or VC-300HD in the way that is appropriate for the intended purpose. This section describes how the various connections need to be made, according to purpose.

## Connection Overview and Support Pages

			Input							
			i.LINK Connector		COMPONENT INPUT Connector		DVI-I Connector		HD-SDI IN Connector	
			HDV	DV	HD	SD	Digital	Analog	HD	SD
Output	i.LINK Connector	HDV	—	—	○ p. 15	○ p. 16	○ p. 19	○ p. 19	○ p. 17	○ p. 17
		DV	—	—	○ p. 16	○ p. 16	○ p. 20	○ p. 20	○ p. 18	○ p. 18
	COMPONENT OUTPUT Connector	HD	○ p. 21	○ p. 22	○ p. 16	○ p. 16	○ p. 20	○ p. 20	○ p. 18	○ p. 18
		SD	○ p. 22	○ p. 22	○ p. 16	○ p. 16	○ p. 20	○ p. 20	○ p. 18	○ p. 18
	DVI-I Connector	Digital	○ p. 24	○ p. 24	○ p. 16	○ p. 16	○ p. 20	○ p. 20	○ p. 18	○ p. 18
		Analog	○ p. 24	○ p. 24	○ p. 16	○ p. 16	○ p. 20	○ p. 20	○ p. 18	○ p. 18
	HD-SDI OUT Connector	HD	○ p. 23	○ p. 24	○ p. 16	○ p. 16	○ p. 20	○ p. 20	○ p. 18	○ p. 18
		SD	○ p. 24	○ p. 24	○ p. 16	○ p. 16	○ p. 20	○ p. 20	○ p. 18	○ p. 18

- \* The combinations indicated with ○ in the chart are input/output that can be converted.
- \* The input/output combinations are described on the pages indicated in the chart with p. ??.
- \* Wherever “VC-300HD” appears, it means that it is supported only on the VC-300HD.
- \* Wherever “—” is shown, it means that it is not supported on either the VC-200HD or VC-300HD.

## About the Procedures

In general, the operating procedures introduced in p. 15–25 involve proceeding through the steps below.

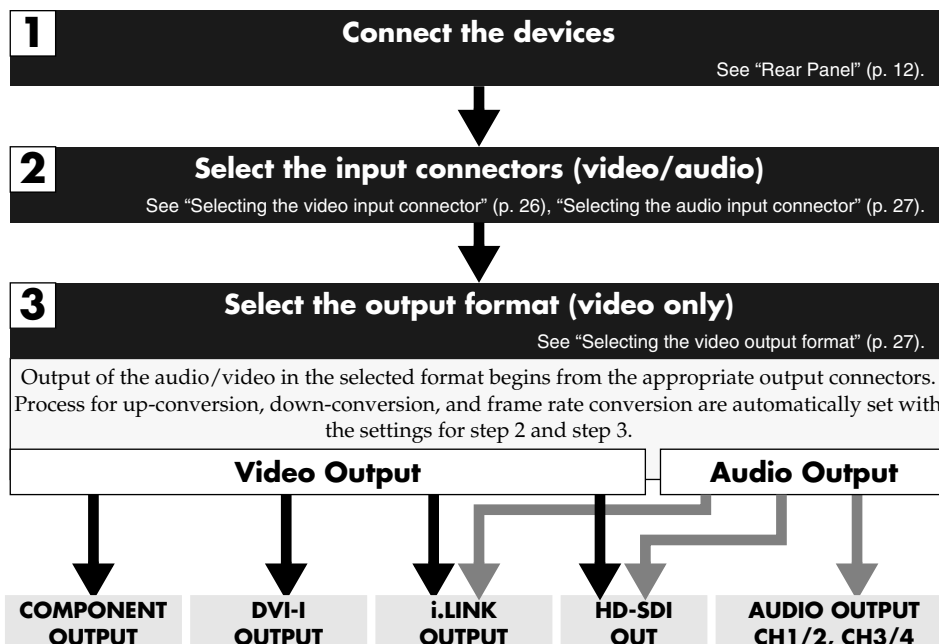

## MEMO

### Frame Rate

This index indicates the number of times (number of frames) that a screen can be redrawn per second. For example, a value of 1080/59.94i means that the screen is redrawn 59.94 times per second.

## Converting HD Component to HDV

HD component video can be converted to HDV, and the HD video can be recorded onto HDV tape. When recording HD component output from an HD video switcher, inexpensive HDV tape can be used.

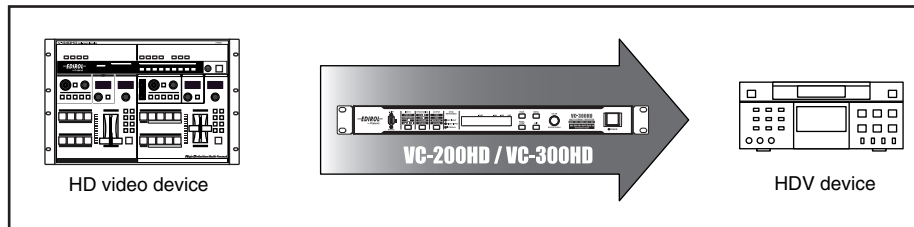

### Connection and Configuration

- 1 Connect the HD video device to the **COMPONENT INPUT** connector using a BNC cable.

\* Make sure to connect the BNC cable securely. If the connection is bad, the color of the output video may be off or synchronization may be lost.

- 2 Connect the HDV device to the **i.LINK** connector using an **i.LINK (IEEE1394)** cable.

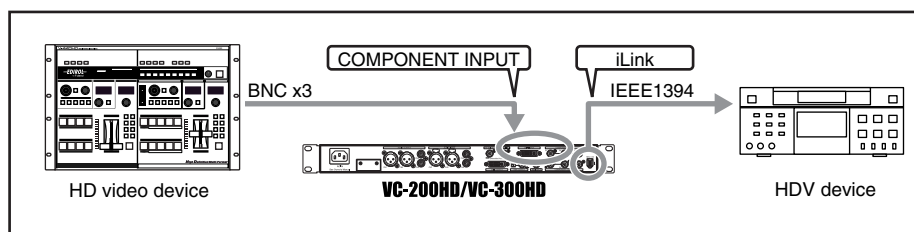

- 3 Connect the HD video device (or audio device) to the **AUDIO INPUT** connectors with an audio cable.

- 4 Press the **POWER** switch to start the unit.

After the unit starts, turn on power to the HD video device and the HDV device.

- 5 Select the video input connector.

- 5-1. Press the **INPUT** button until "100: Video Source" is shown in the display.
- 5-2. Use the **VALUE/ENTER** knob to select "COMPONENT."
- 5-3. Press the **VALUE/ENTER** knob to confirm the selection.

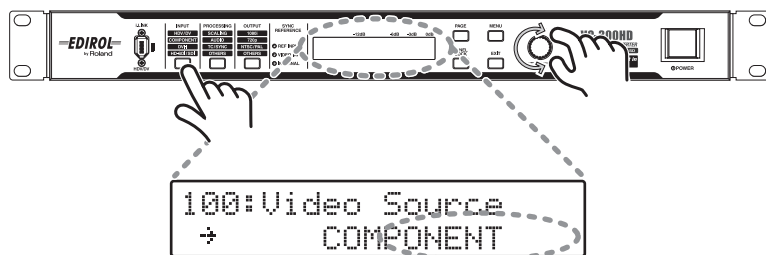

#### MEMO

When the output from the i.LINK connector on this unit is not recognized by the HDV device, turn off power to this unit and then restart it.

#### MEMO

At the factory default settings, audio input to the Ch1 and Ch2 AUDIO INPUT connectors is converted to HDV audio. If you want to use audio input to AUDIO INPUT connectors Ch3 and Ch4, select "CH1-2:3-4 CH3-4:1-2" or "CH1-2:3-4 CH3-4:3-4" in the "160:AUDIO In Ch" menu (p. 32).

#### MEMO

To adjust the nominal input level of audio input to the AUDIO INPUT connectors, use the "161: In Ch1&2 NomLv" menu (p. 33) and the "162: In Ch3&4 NomLv" menu.

## 6 Select the output format.

- 6-1. Press the OUTPUT button until "300: Video Out Format" is shown in the display.
- 6-2. Use the VALUE/ENTER knob to select "1080/59.94i," "1080/50i," "720/59.94p," or "720/50p."
- 6-3. Press the VALUE/ENTER knob to confirm the selection. The video signal is output in the selected video format.

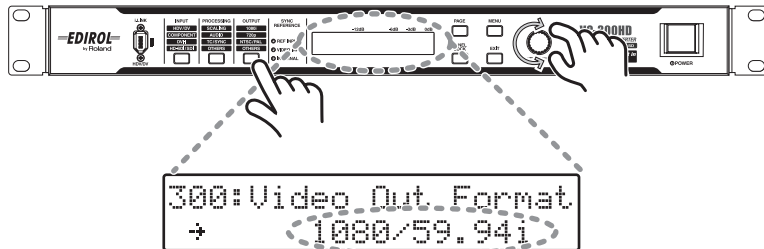

### MEMO

If the aspect ratios of the video selected in step 4. and the output format selected in step 6. are different, select the scaling type with "200: Scaling Type" (p. 33) from the Menu (p. 30).

### Converting HD Component to HD-SDI **VC-300HD**

Perform the settings on the previous page, and connect the HD video device with HD-SDI to the HD-SDI OUT connector. The selection made in Step 6 determines the format of the video that is output. Set this item according to the connected device.

- \* When changing the output video frame rate, please select an appropriate value in step 6.
- \* Refer to the user's manual that came with your HD video equipment to find out which video formats it supports.

### Up-converting SD Component to HDV

By using the scaling feature of this device, SD component video can be up-converted to HD size as well as converted to HDV.

Perform the settings on the previous page, and connect the SD video device to the COMPONENT INPUT connector. The selection made in Step 6 determines the format of the video that is output. Set this item according to the connected device.

- \* When changing the output video frame rate, please select an appropriate value in step 6.
- \* Refer to the user's manual that came with your HD video equipment to find out which video formats it supports.

### Converting HD Component or SD Component to DV

By using the scaling feature of the VC-300HD/VC-200HD, HD component video can be down-converted to SD size as well as converted to DV. Perform the settings on the previous page, and connect the DV device to the i.LINK connector. Select "480/59.94i" in Step 6.

- \* Use this same procedure to convert SD component to DV.
- \* When converting to PAL, select "576/50i" in step 6. For NTSC, select "480i/59.94i."

### Converting HD Component to DVI-I

Perform the settings on the previous page, and connect a DVI-I compatible device, such as a LCD monitor, to the DVI-I OUT connector. The selection made in Step 6 determines the format of the video that is output. Set this item according to the connected device.

- \* When changing the output video frame rate, please select an appropriate value in step 6.

### Changing the Component Size

The VC-300HD/VC-200HD converts (cross converts) 1080i size HD component to 720p as well as SD component to either HD component can size. In this case, select the format to be converted in Step 6, and connect a video device that is compatible with the output format to the COMPONENT OUT connector.



## Converting HD-SDI to HDV **VC-300HD**

Since the VC-300HD/VC-200HD offers HD-SDI input, the HD-SDI or SDI from an HD video device can be converted to HDV.

The output from the HD video switcher can be recorded in HDV, or the video from an HD video deck can be converted to HDV.

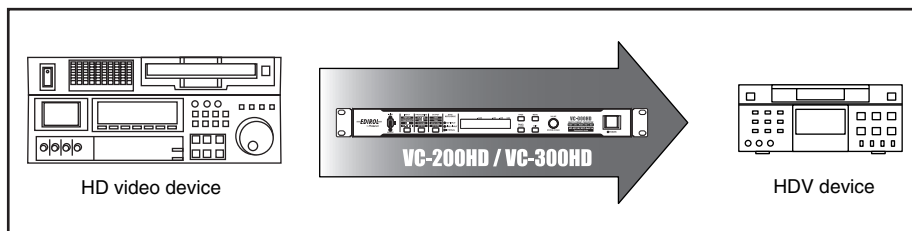

### Connection and Configuration

#### 1 Connect the HD video device to the HD-SDI IN connector using a BNC cable.

- \* Make sure to use a 75 ohm BNC cable. The VC-300HD may not be able to acceptably receive SDI if you use a cable that cannot transmit HD SDI.
- \* Make sure to connect the BNC cable securely. If the connection is bad, the color of the output video may be off or synchronization may be lost.

#### 2 Connect the HDV device to the i.LINK connector using an i.LINK (IEEE1394) cable.

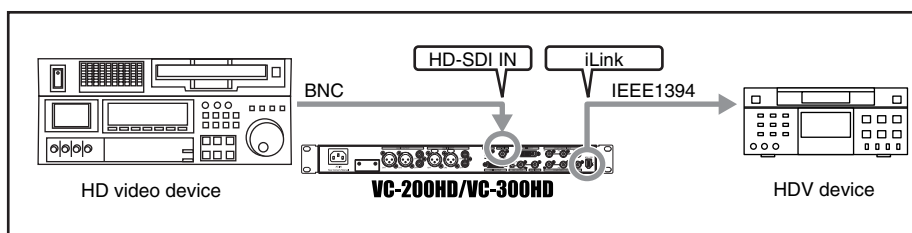

#### MEMO

When the output from the i.LINK connector on this unit is not recognized by the HDV device, turn off power to this unit and then restart it.

#### 3 Press the POWER switch to start the unit.

After the unit starts, turn on power to the HD video device and the HDV device.

#### 4 Select the video input connector.

- 4-1. Press the INPUT button until "100: Video Source" is shown in the display.
- 4-2. Use the VALUE/ENTER knob to select "SDI."
- 4-3. Press the VALUE/ENTER knob to confirm the selection.

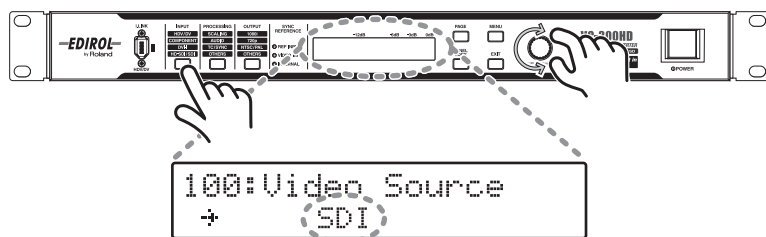

#### 5 Select the audio input connector.

When using HD-SDI that does not have embedded audio, the sound input via the AUDIO INPUT connector must be selected.

- 5-1. Press the INPUT button until "150: Audio Source" is shown in the display.
- 5-2. Use the VALUE/ENTER knob to select "SDI."
- 5-3. Press the VALUE/ENTER knob to confirm the selection.

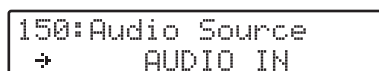

## 6 Select the output format.

- 6-1. Press the OUTPUT button until "300: Video Out Format" is shown in the display.
- 6-2. Use the VALUE/ENTER knob to select "1080/59.94i," "1080/50i," "720/59.94p," or "720/50p."
- 6-3. Press the VALUE/ENTER knob to confirm the selection. The video signal is output in the selected video format.

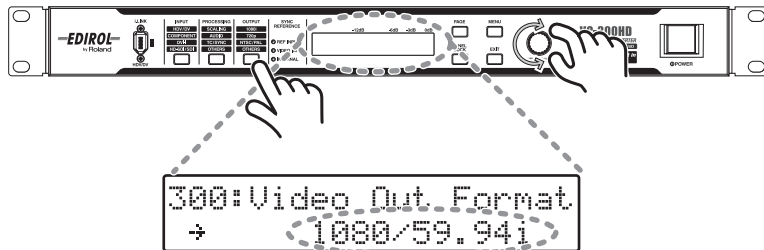

### MEMO

If the aspect ratios of the video selected in step 5. and the output format selected in step 6. are different, select the scaling type with "200: Scaling Type" (p. 33) from the Menu (p. 30).

### Converting SD-SDI to HDV **VC-300HD**

By using the scaling feature of the VC-300HD/VC-200HD, SD-SDI component video can be up-converted to HD size as well as converted to HDV. In this case, conversion can be performed using the same procedure as shown on the previous page.

- \* If conversion cannot be performed properly, it is possible that the "140: SDI IN" (p. 32) from the Menu (p. 30) is not set to "Auto."

### Converting HD-SDI to DV **VC-300HD**

By using the scaling feature of the VC-300HD/VC-200HD, HD-SDI can be down-converted to SD size as well as converted to DV. In this case, after connecting using the procedure on the previous page, select "SD" in Step 6.

- \* When converting to PAL, select "576/50i" in step 6. For NTSC, select "480/59.94i."

### Converting SD-SDI to DV **VC-300HD**

Perform the settings on the previous page, and connect the SD video device to the HD-SDI IN connector. In this case, select "480/59.94i" in Step 6.

- \* When converting to PAL, select "576/50i" in step 6. For NTSC, select "480/59.94i."

### Converting HD-SDI (SD-SDI) to Component **VC-300HD**

Perform the settings on the previous page, and connect the HD video device to the COMPONENT OUTPUT connector. The selection made in Step 6 determines the format of the video that is output. Set this item according to the connected device.

- \* When changing the output video frame rate, please select an appropriate value in step 6.
- \* Refer to the user's manual that came with your HD video equipment to find out which video formats it supports.
- \* When "480/59.94i" is used in Step 6, SD component is output. When converting to PAL, select "576/50i" in step 6. For NTSC, select "480/59.94i."

### Converting HD-SDI (SD-SDI) to DVI-I **VC-300HD**

Perform the settings on the previous page, and connect a DVI-I compatible device, such as a LCD monitor, to the DVI-I OUTPUT connector. The selection made in Step 6 determines the format of the video that is output. Set this item according to the connected device.

- \* When changing the output video frame rate, please select an appropriate value in step 6.

### Changing HD-SDI (SD-SDI) Size **VC-300HD**

The VC-300HD/VC-200HD converts (cross converts) 1080i size HD-SDI to 720p, and SD-SDI and HD-SDI can be mutually converted. In this case, select the format to be converted in Step 6, and connect the video device supporting the output format to the HD-SDI OUT connector.

## Converting computer screens (DVI or VGA) to HDV

DVI or VGA output from a computer can be converted to HDV, and the high resolution images can be recorded to a video. Because the computer screen can be recorded in HD, small text and graphics do maintain clarity.

- \* To input VGA output to the VC-300HD/VC-200HD, please use an RGB-DVI conversion connector and cable to convert to the DVI connector.
- \* See "DVI" (p. 38) for explanation on DVI.

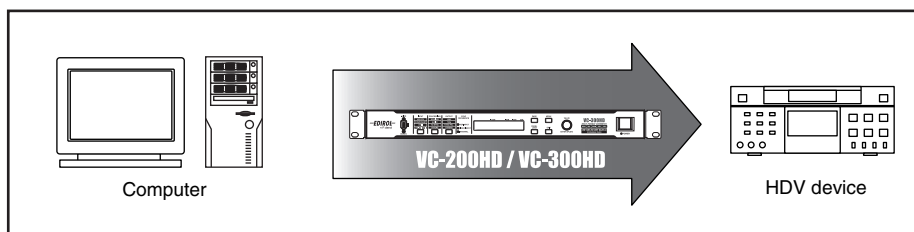

### Connection and Configuration

**1 Connect the computer to the DVI-I INPUT connector using a DVI cable.**

- \* Please use a cable that is suitable for your computer to make the connection.

**2 Connect the HDV device to the i.LINK connector using an i.LINK (IEEE1394) cable.**

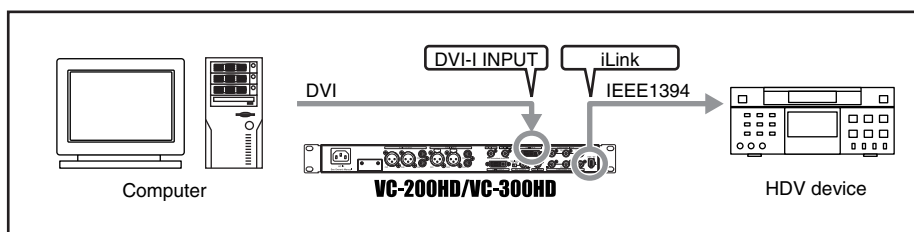

- \* When the output from the i.LINK connector on this unit is not recognized by the HDV device, turn off power to this unit, then restart it.

**3 Connect the computer (or audio device) to the AUDIO INPUT connector using a audio cable.**

**4 Press the POWER switch to start the unit.**

After the unit starts, turn on power to the computer device and the HDV device.

**5 Select the video input connector.**

- 5-1. Press the INPUT button until "100: Video Source" is shown in the display.
- 5-2. Use the VALUE/ENTER knob to select "DVI-D" or "DVI-A."
- 5-3. Press the VALUE/ENTER knob to confirm the selection.

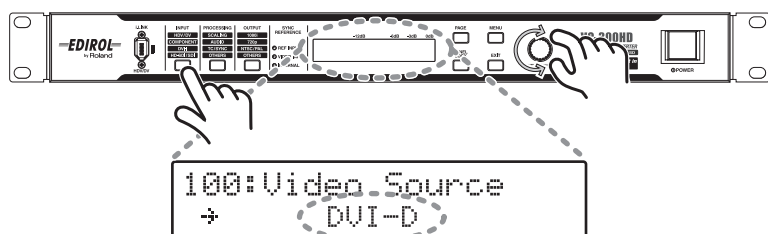

- \* Select "DVI-D" when DVI-D is input, and select "DVI-A" when DVI-A or VGA is input.

**MEMO**

At the factory default settings, audio input to the Ch1 and Ch2 AUDIO INPUT connectors is converted to HDV audio. If you want to use audio input to AUDIO INPUT connectors Ch3 and Ch4, select "CH1-2:3-4 CH3-4:1-2" or "CH1-2:3-4 CH3-4:3-4" in the "160: AUDIO In Ch" menu (p. 32).

**MEMO**

To adjust the nominal input level of audio input to the AUDIO INPUT connectors, use the "161: In Ch1&2 NomLv" menu (p. 33) and the "162: In Ch3&4 NomLv" menu.

**MEMO**

Please select one of the following resolutions for the computer screen resolution. Also, setting the computer "refresh rate" to a value close to the setting for the output format selected in Step 5 can reduce flickering.

**MEMO**

- Digital:**
- 1600 x 1200/60 Hz,
  - 1400 x 1050/60/75 Hz,
  - 1366 x 768/60,
  - 1280 x 1024/60/75 Hz,
  - 1280 x 768/60 Hz,
  - 1280 x 960/60 Hz,
  - 1152 x 864/75 Hz,
  - 1024 x 768/60/75 Hz,
  - 800 x 600/60/75 Hz,
  - 640 x 480/60/75 Hz

**MEMO**

If the device does not recognize input from the computer, restart the computer while leaving the power to the VC-300HD/VC-200HD on.

## 6 Select the output format.

- 6-1. Press the OUTPUT button until "300: Video Out Format" is shown in the display.
- 6-2. Use the VALUE/ENTER knob to select "1080/59.94i," "1080/50i," "720/59.94p," or "720/50p."
- 6-3. Press the VALUE/ENTER knob to confirm the selection. The video signal is output in the selected video format.

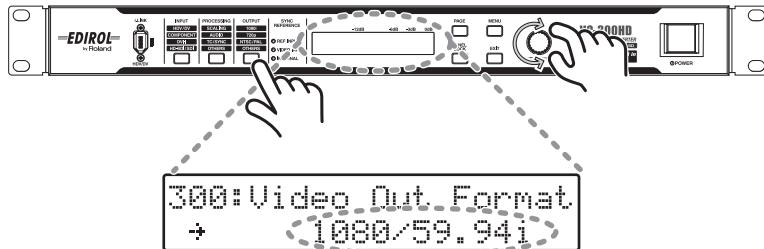

### MEMO

If the aspect ratios of the video selected in step 5. and the output format selected in step 6. are different, select the scaling type with "200: Scaling Type" (p. 33) from the Menu (p. 30).

### Converting DVI-I to HD-SDI (SD-SDI) **VC-300HD**

Perform the settings on the previous page, and connect the HD video device to the HD-SDI OUT connector. The selection made in Step 6 determines the format of the video that is output. Set this item according to the connected device.

- \* When changing the output video frame rate, please select an appropriate value in step 6.
- \* Refer to the user's manual that came with your HD video equipment to find out which video formats it supports.
- \* When "SD" is used in Step 6, SD-SDI is output. When converting to PAL, select "576/50i" in step 6. For NTSC, select "480i/60."

### Converting DVI-I to Component

Perform the settings on the previous page, and connect the HD video device to the COMPONENT OUTPUT connector. The selection made in Step 6 determines the format of the video that is output. Set this item according to the connected device.

- \* When changing the output video frame rate, please select an appropriate value in step 6.
- \* Refer to the user's manual that came with your HD video equipment to find out which video formats it supports.
- \* When "SD" is used in Step 6, SD component is output. When converting to PAL, select "576/50i" in step 6. For NTSC, select "480i/60."

### Converting DVI-I to DV

By using the scaling feature of the VC-300HD/VC-200HD, DVI-I can be down-converted to SD video as well as converted to DV.

Perform the settings on the previous page, and connect the DV device to the i.LINK connector. Select "SD" in Step 6.

- \* When converting to PAL, select "576/50i" in step 6. For NTSC, select "480i/60."

### Converting DVI-I to SD Video

By using the scaling feature of the VC-300HD/VC-200HD, DVI output can be down-converted to SD video.

Perform the settings on the previous page, and connect the SD video device to the COMPONENT OUTPUT connector. Select "SD" in Step 6.

- \* When converting to PAL, select "576/50i" in step 6. For NTSC, select "480i/60."

### Converting DVI-I

The DVI-I output with the VC-300HD/VC-200HD is converted to the video format selected with Step 6. The output video format is as shown below.

- |                   |  |
|-------------------|--|
| Digital (RGB):    | 1080/59.94p, 1080/50p, 1080/59.94i, 1080/50i, 720/59.94p, 720/50p,<br>480/59.94p, 576/50p, 480/59.94i, 576/50i |
| Analog (Y/Pb/Pr): | 1080/59.94p, 1080/50p, 1080/59.94i, 1080/50i, 720/59.94p, 720/50p,<br>480/59.94p, 576/50p, 480/59.94i, 576/50i |

## Converting HDV to HD Component

When video recorded in HDV is converted to HD component, it can be used as HD analog video on an HD video device or in an HD linear editing environment.

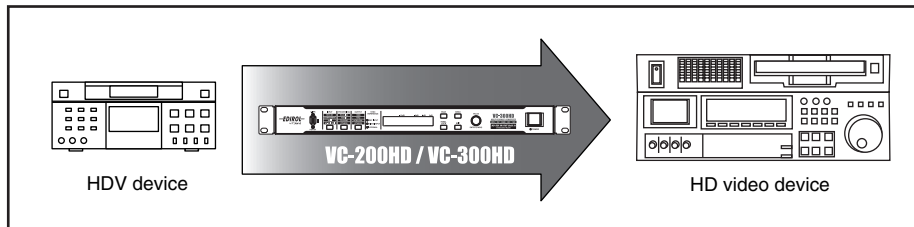

### Connection and Configuration

**1** Connect the HDV device to the i.LINK connector using a i.LINK (IEEE1394) cable.

**2** Connect the HD video device to the COMPONENT OUTPUT connector using a BNC cable.

\* Make sure to connect the BNC cable securely. If the connection is bad, the color of the output video may be off or synchronization may be lost.

\* Use a cable compatible with the video device for connection.

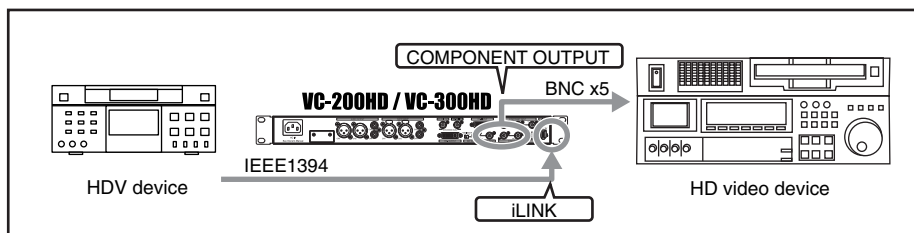

**3** Connect the computer (or audio device) to the AUDIO INPUT connector using a audio cable.

**4** Press the POWER switch to start the unit.

After the unit starts, turn on power to the computer device and the HDV device.

**5** Select the video input connector.

5-1. Press the INPUT button until "100: Video Source" is shown in the display.

5-2. Use the VALUE/ENTER knob to select "i.LINK."

5-3. Press the VALUE/ENTER knob to confirm the selection.

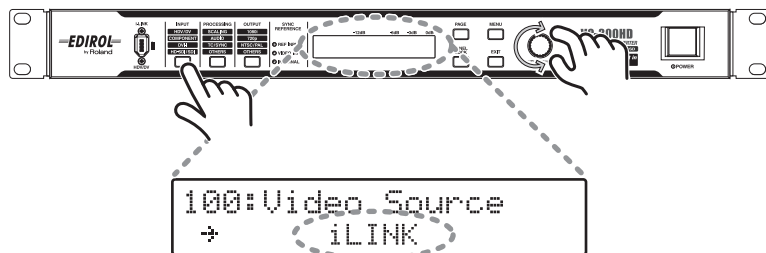

#### MEMO

When the output from the i.LINK connector on this unit is not recognized by the HDV device, turn off power to this unit and then restart it.

#### MEMO

Audio that is included with HDV is output from the AUDIO OUTPUT connectors CH1/ CH2 or CH3/CH4.

## 6 Select the output format.

- 6-1. Press the OUTPUT button until "300: Video Out Format" is shown in the display.
- 6-2. Use the VALUE/ENTER knob to select "1080/59.94i," "1080/50i," "720/59.94p," or "720/50p."
- 6-3. Press the VALUE/ENTER knob to confirm the selection. The video signal is output in the selected video format.

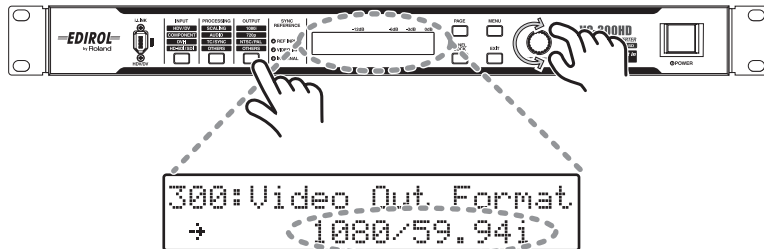

### MEMO

If the aspect ratios of the video selected in step 5. and the output format selected in step 6. are different, select the scaling type with "200: Scaling Type" (p. 33) from the Menu (p. 30).

### Converting HDV to SD Component

By using the scaling feature of the VC-300HD/VC-200HD, HDV can be down-converted to SD size as well as converted to SD component. In this case, after connecting using the procedure on the previous page, select "SD" in Step 5.

- \* When converting to PAL, select "576/50i" in step 6. For NTSC, select "480i/60."

### Converting DV to HD Component

Perform the settings on the previous page, and connect the HD video device to the COMPONENT OUTPUT connector. In this case, select "1080i" or "720p" in Step 5.

- \* When changing the output video frame rate, please select an appropriate value in step 6.
- \* Refer to the user's manual that came with your HD video equipment to find out which video formats it supports.
- \* When "SD" is used in Step 5, SD component is output. When converting to PAL, select "576/50i" in step 6. For NTSC, select "480i/60."
- \* With audio that is 32 kHz, 12 bit, and 4-channel, which is being input to this unit as DV input, only two channels of audio can be used. To select the channels to use in conversion, set "170: DV In Audio Ch" (p. 33) from the Menu (p. 30).

When using all sound from the four channels in conversion, input the analog sound output of the DV device to the AUDIO INPUT connectors, and select "AUDIO IN" with "150: Audio Source" (p. 32) in the Menu (p. 30). Because a time lag occurs between the video and audio, adjust the timing with "240: AudioDelay Time" from the Menu (p. 30).

- \* The same DV recording is output from CH1/CH2 and CH3/CH4 of the AUDIO OUTPUT connectors. The embedded audio output from the HD-SDI OUT connector is output to the channel selected with "450: SDI OUT Audio Ch" (p. 37) from the Menu (p. 30).

## Converting HDV to HD-SDI **VC-300HD**

Video recorded in HDV can be converted to HD-SDI and copied to an HD video device, such as HDCAM or DVCPRO HD, or transmitted over a long distance.

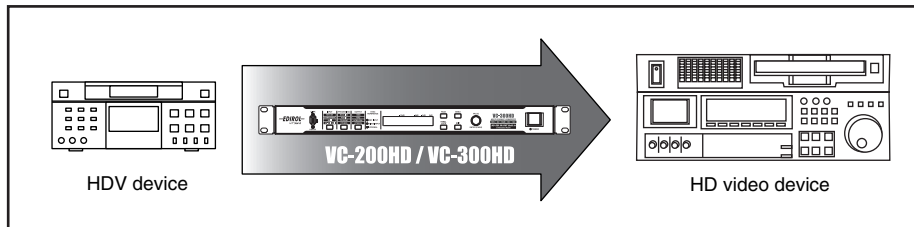

### Connection and Configuration

**1** Connect the HDV device to the **i.LINK** connector using a **i.LINK (IEEE1394)** cable.

**2** Connect the HD video device to the **COMPONENT OUTPUT** connector using a **BNC** cable.

\* Make sure to connect the BNC cable securely. If the connection is bad, the color of the output video may be off or synchronization may be lost.

\* Be sure to connect with a BNC cable. When the connection is bad, the color of the output video may be off or synchronization may be lost.

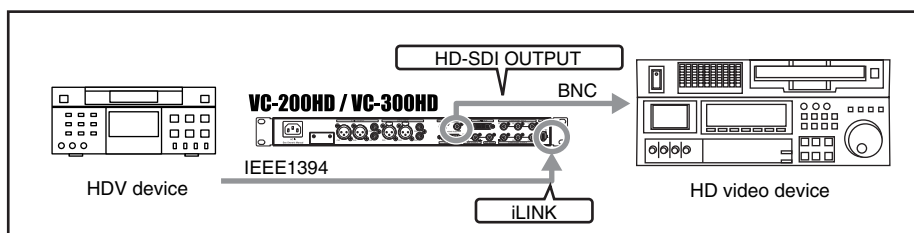

**3** Press the **POWER** switch to start the unit.

After the unit starts, turn on power to the computer device and the HDV device.

**4** Select the video input connector.

4-1. Press the **INPUT** button until "100: Video Source" is shown in the display.

4-2. Use the **VALUE/ENTER** knob to select "i.LINK."

4-3. Press the **VALUE/ENTER** knob to confirm the selection.

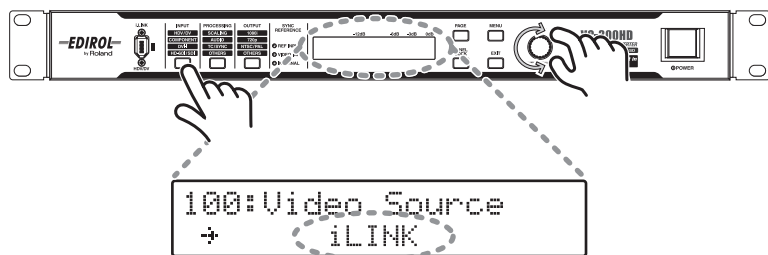

#### MEMO

When the output from the i.LINK connector on this unit is not recognized by the HDV device, turn off power to this unit and then restart it.

#### MEMO

Audio that is included with HDV is output from the **AUDIO OUTPUT** connectors CH1/CH2 or CH3/CH4.

## 5 Select the output format.

- 5-1. Press the OUTPUT button until "300: Video Out Format" is shown in the display.
- 5-2. Use the VALUE/ENTER knob to select "1080/59.94i," "1080/50i," "720/59.94p," or "720/50p."
- 5-3. Press the VALUE/ENTER knob to confirm the selection. The video signal is output in the selected video format.

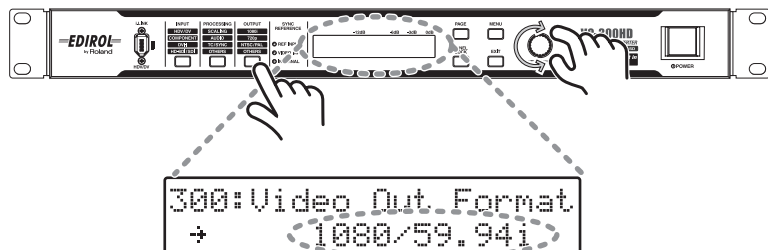

### MEMO

If the aspect ratios of the video selected in step 4. and the output format selected in step 5. are different, select the scaling type with "200: Scaling Type" (p. 33) from the Menu (p. 30).

### Converting HDV to SD-SDI **VC-300HD**

By using the scaling feature of the VC-300HD/VC-200HD, HDV can be down-converted to SD size as well as converted to SD-SDI. In this case, after connecting using the procedure on the previous page, select "SD" in Step 5.

- \* When converting to PAL, select "576/50i" in step 6. For NTSC, select "480i/60."

### Converting HDV (DV) to DVI

Perform the settings on the previous page, and connect a DVI-I compatible device, such as a LCD monitor, to the DVI-I OUTPUT connector. The selection made in Step 5 determines the format of the video that is output. Set this item according to the connected device.

- \* By connecting to a DV device instead of an HDV device, DV can be converted to DVI.
- \* When changing the output video frame rate, please select an appropriate value in step 5.
- \* With audio that is 32 kHz, 12 bit, and 4-channel, which is being input to this unit as DV input, only two channels of audio can be used. To select the channels to use in conversion, set "170: DV In Audio Ch" (p. 33) from the Menu (p. 30).

When using all sound from the four channels in conversion, input the analog sound output of the DV device to the AUDIO INPUT connectors, and select "AUDIO IN" with "150: Audio Source" (p. 32) in the Menu (p. 30). Because a time lag occurs between the video and audio, adjust the timing with "240: Audio Delay Time" from the Menu (p. 30).

- \* The same DV recording is output from CH1/CH2 and CH3/CH4 of the AUDIO OUTPUT connectors. The embedded audio output from the HD-SDI OUT connector is output to the channel selected with "450: SDI OUT Audio Ch" (p. 37) from the Menu (p. 30).

### Converting DV to HD-SDI **VC-300HD**

By using the scaling feature of the VC-300HD/VC-200HD, DV can be up-converted to HD size as well as converted to HD-SDI. In this case, after connecting using the procedure on the previous page, select a video format in Step 5 that is supported by the HD video device being used.

- \* When changing the output video frame rate, please select an appropriate value in step 6.
- \* With audio that is 32 kHz, 12 bit, and 4-channel, which is being input to this unit as DV input, only two channels of audio can be used. To select the channels to use in conversion, set "170: DV In Audio Ch" (p. 33) from the Menu (p. 30).

When using all sound from the four channels in conversion, input the analog sound output of the DV device to the AUDIO INPUT connectors, and select "AUDIO IN" with "150: Audio Source" (p. 32) in the Menu (p. 30). Because a time lag occurs between the video and audio, adjust the timing with "240: Audio Delay Time" from the Menu (p. 30).

- \* The same DV recording is output from CH1/CH2 and CH3/CH4 of the AUDIO OUTPUT connectors. The embedded audio output from the HD-SDI OUT connector is output to the channel selected with "450: SDI OUT Audio Ch" (p. 37) from the Menu (p. 30).



## Installation

### **Attaching the Rubber Feet (included)**

Please attach the feet as necessary; for example, when using the VC-300HD/VC-200HD without mounting it in a rack.

Remove the double-sided tape from the rubber feet, then affix them as shown in the figure below.

- \* The rubber feet are arranged onto one pad. Please remove from the pad to use them.

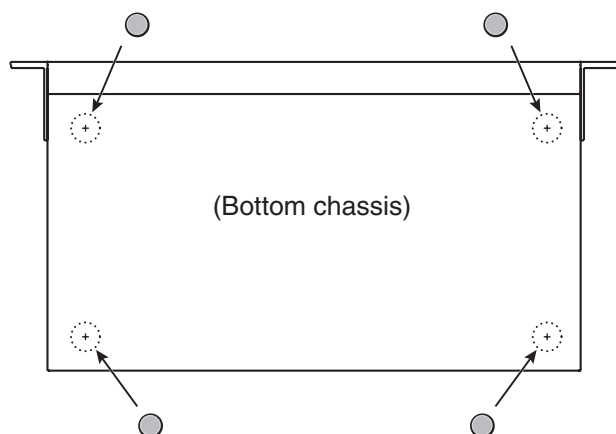

- \* When turning this unit over, place some newspapers or magazines under the four corners or both sides to prevent damage to the buttons and knobs. Also, try to position the unit so its buttons and knobs won't get damaged.
- \* When turning the unit over, be careful not to drop or allow the unit to fall over.

### **Cautions when Rack Mounting**

- When mounting the VC-300HD/VC-200HD in a rack, please pay attention to the following to assure effective cooling.
  - Install in a location with good air flow.
  - Do not obstruct the cooling fan's exhaust vent on the side of the device.
  - Avoid mounting in closed-type racks. Because warm air cannot be exhausted from the rack, efficient cooling cannot occur because warm air is taken in.
  - When the back of the rack cannot be opened, please install an exhaust fan or vent in the upper-rear portion of the rack, where warm air tends to collect.
  - When mounting in a moveable case (portable rack), remove the front or back cover of the case so the front or back of the VC-300HD/VC-200HD is not blocked.
- Be careful not to pinch fingers when attaching to a rack.
- Please also read "Placement" in "Important Notes" (p. 6) for installation.

### **Cautions when Connecting**

- To prevent malfunction and/or damage to speakers or other devices, always turn down the volume, and turn off the power on all devices before making any connections.

# Basic Operations

## Turning Power On/Off

### Turning power on

- Once the connections have been completed (p. 14), turn on power to your various devices in the order specified. By turning on devices in the wrong order, you risk causing malfunction and/or damage to speakers and other devices.
- This unit is equipped with a protection circuit. A brief interval (a few seconds) after power up is required before the unit will operate normally.

- 1 Turn the volume on the connected device all the way down
- 2 Press the **POWER** switch on the left side of the front panel.

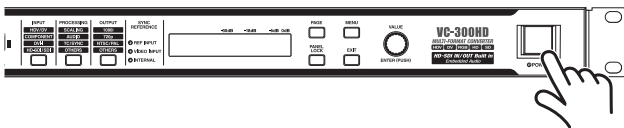

### Turning power off

- When changing settings with the menu (p. 30), first close the main menu before turning power off. If power is turned off without closing the main menu, the set contents will not be saved.
- If you need to turn off the power completely, first turn off the POWER switch, then unplug the power cord from the power outlet. Refer to "Power Supply" (p. 6).

- 1 Turn the volume on the connected device all the way down
- 2 Press the **POWER** switch on the left side of the front panel.

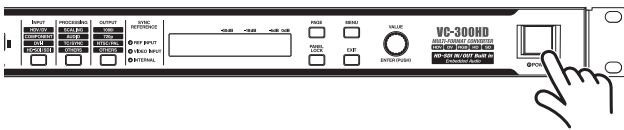

## Selecting the video input connector

This unit has multiple video input connectors: i.LINK connector, COMPONENT connector, DVI-I connector, and HD-SDI connector (VC-300HD). Simultaneous video input is possible.

When converting a video signal, the connector for the video to be converted must be selected.

- 1 Press the **INPUT** button until "100: Video Source" is shown in the display

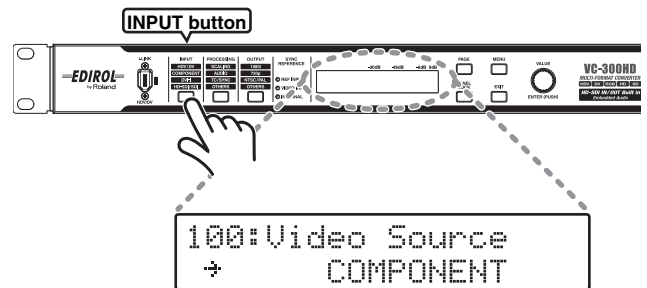

The INPUT button lights, and the screen shown in the figure is displayed.

- 2 Use the **VALUE/ENTER** knob to select the connector where the video is being input

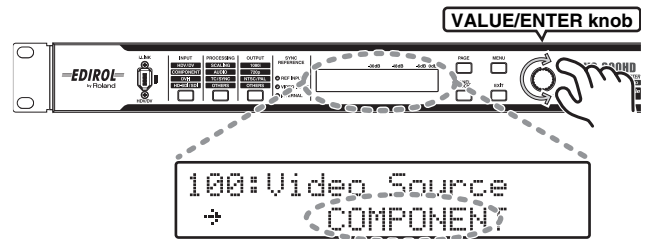

- 3 Press the **VALUE/ENTER** knob to confirm the selection.

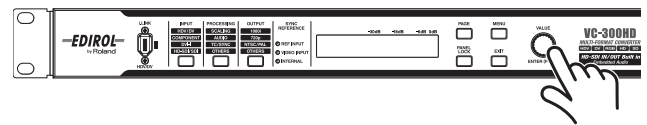

The Status screen returns to the display (p. 29).

When a video signal is input to the selected video input connector, a video signal is output in the output format set with "Selecting the video output format" (p. 27).

- \* When a connector with no input is selected, a black matte image is output.
- \* Specify the video input format with the "110: i.LINK IN" (p. 32), "120: COMPONENT IN" (p. 32), "130: DVD-D IN" (p. 32), "131: DVI-A IN" (p. 32), and "140: SDI I IN" (p. 32) items of the Menu (p. 30).

## Selecting the audio input connector

This unit has several sound input connectors: AUDIO INPUT connectors, i.LINK connector, and HD-SDI connector (VC-300HD only). At the factory settings, the audio input connector appropriate for the video selected under "Selecting the video input connector" (p. 26) is selected.

Use the following procedure to manually select the sound input connector.

- 1 Press the INPUT button until "200: Audio Source" is shown in the display.

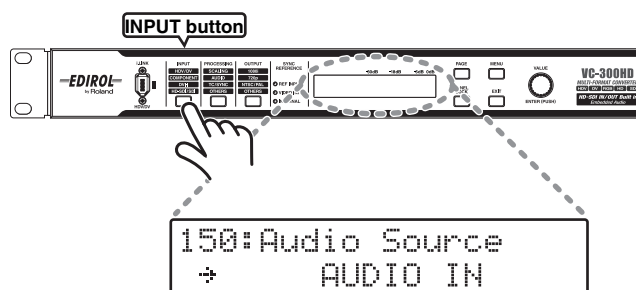

The INPUT button lights, and the screen shown in the figure is displayed.

- 2 Use the VALUE/ENTER knob to select the connector where the audio is being input.

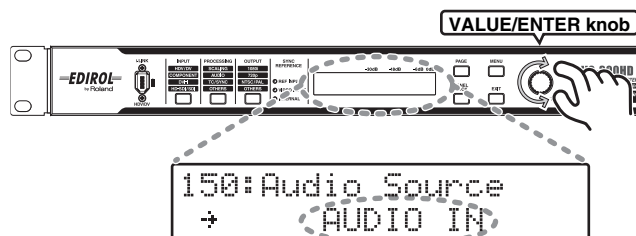

- 3 Press the VALUE/ENTER knob to confirm the selection.

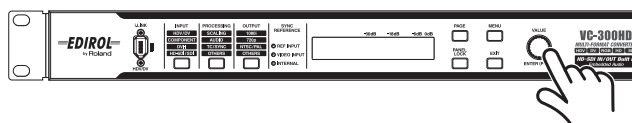

When sound is input to the selected connector, sound is output from the AUDIO OUTPUT connectors, i.LINK connector, or HD-SDI OUT connector (VC-300HD only).

- \* The same HDV or DV recording is output from CH1/CH2 and CH3/CH4 of the AUDIO OUTPUT connectors. The embedded audio output from the HD-SDI OUT connector at this time is output to the channel selected with "450: SDI OUT Audio Ch" (p. 37) from the Menu (p. 30).
- \* When inputting a DV signal (32 kHz, 12 bit, 4-channel) from the i.LINK connector, select the channel to use in conversion with "170: DV In Audio Ch" (p. 33) from the Menu (p. 30).
- \* When sound output from the i.LINK connector is to be output in the 32 kHz, 12 bit, 4-channel format, set "32kHz" with "320: Audio Out Fs" (p. 35) from the Menu (p. 30). At this time, sound is not output from the HD-SDI OUT connector.
- \* Specify the nominal level of the AUDIO INPUT connectors with "161: In Ch1&2 NomLv" (p. 33) and "162: In Ch3&4 NomLv" (p. 33) from the Menu (p. 30).
- \* Specify the nominal level of the AUDIO OUTPUT connectors with "360: Out Ch1&2 NomLv" (p. 35) and "361: Out Ch3&4 NomLv" (p. 35) from the Menu (p. 30).

## Selecting the video output format

The video signal selected with "Selecting the video input connector" on the page to the left can be converted and output in any video format. Follow the procedure below to select a video format to output.

- 1 Press the OUTPUT button until "300: Video Output Format" is shown in the display

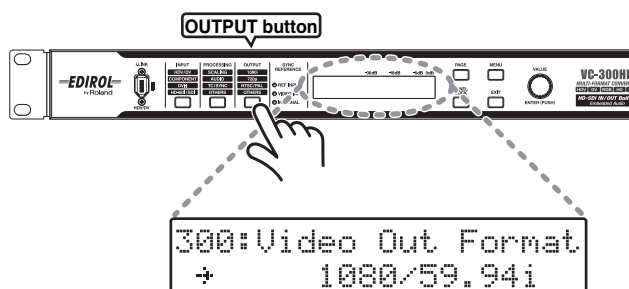

The OUTPUT button lights, and the screen shown in the figure is displayed.

- 2 Use the VALUE/ENTER knob to select the output format.

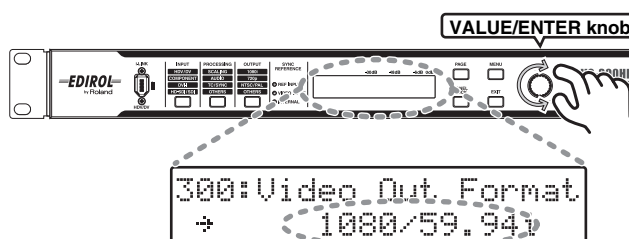

- 3 Press the VALUE/ENTER knob to confirm the selection.

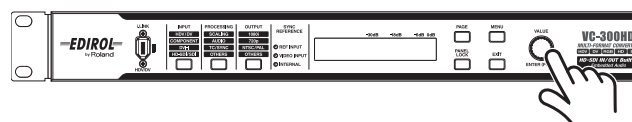

The Status screen returns to the display (p. 29).

Each output connector outputs video in the selected video format.

- \* See the "Output Format Table" (p. 13) for combinations of formats and the connectors that can be output to. Selected video formats for some combinations do not have connectors where they can be output.
- \* If the aspect ratio of the video selected under "Selecting the video input connector" (p. 26) and that of the output format are different, select the scaling type with "200: Scaling Type" (p. 33) from the Menu (p. 30).

## Test Pattern / Test Tone Output

The VC-300HD/VC-200HD can easily output test patterns or test tones.

- 1 Press the **OUTPUT** button until "390: Test Pattern" or "391: Test Tone" is shown in the display

Press the **PAGE** button once to display the test pattern. Press the **PAGE** button twice to display the test tone.

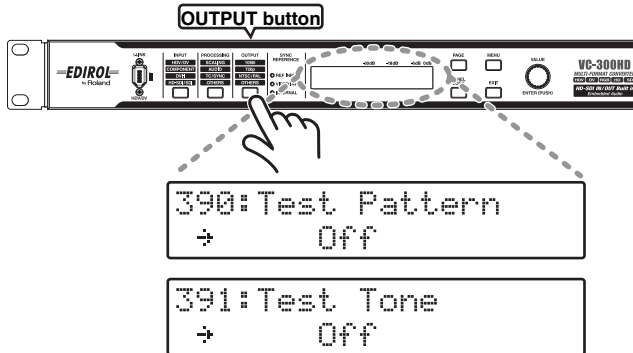

The **OUTPUT** button lights, and the screen shown in the figure is displayed.

- 2 Use the **VALUE/ENTER** knob to select the test pattern/ test tone to output.

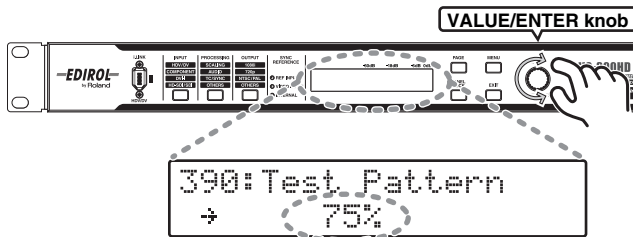

- 3 Press the **VALUE/ENTER** knob to confirm the selection.

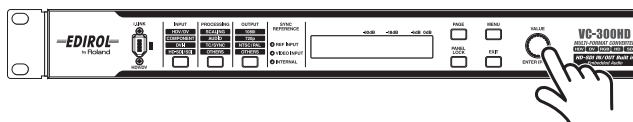

The Status screen returns to the display (p. 29).

- \* When test pattern is selected, each video output connector outputs a test pattern in the video format selected with "Selecting the video output format" (p. 27).

## Setting internal processing

The video aspect ratio, audio delay amount, and audio level can be adjusted.

- 1 Press the **PROCESSING** button until the internal process item is shown in the display

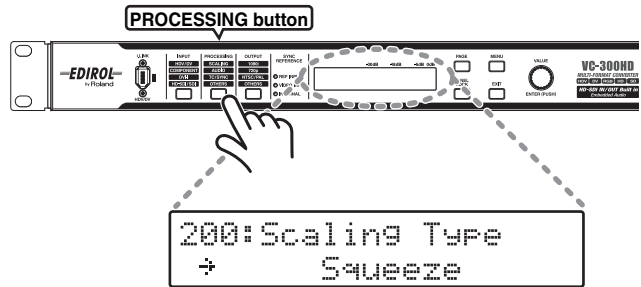

The internal processes that can be selected are of the following 5 types.

Item Name	Internal Process	Description
200: Scaling Type	Sets the aspect ratio.	p. 33
210: Out Zoom	Adjusts the magnification of the output video.	p. 34
240: AudioDelayTime	Sets the delay applied to the output audio.	p. 34
260: Sync Source	Sets the synchronizing signal input source.	p. 34
270: TC Generate	Selects the timecode to embed in the HDV, DV, or HD-SDI output.	p. 34

- 2 Press the **VALUE/ENTER** knob to confirm the value of the setting

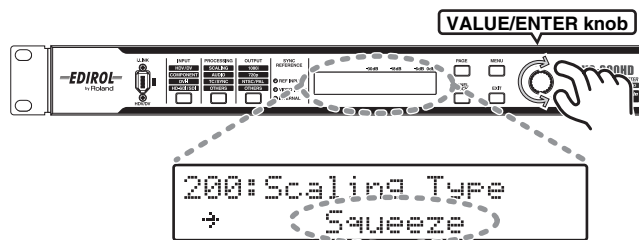

- \* For the settings for each item, see the "Description" page indicated in the table.

- 3 Press the **VALUE/ENTER** knob to confirm the selection.

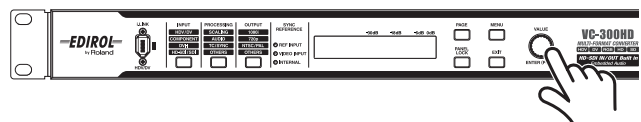

The Status screen returns to the display (p. 29).

## Showing the Display

The display shows the status of the device. It also shows the menu screens for the various settings.

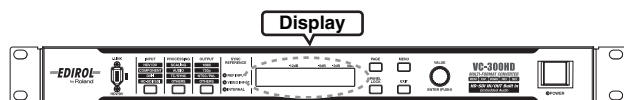

- \* The display may be difficult to read depending on the angle from which the unit is viewed. The character contrast on the display and brightness of the backlight are adjusted with the "900: LCD Contrast" and "901: Light Dimmer" settings (p. 37) from the Menu (p. 30).

### • Status Screen



- \* For details see "Status Screen" below.

### • Menu Screen



- \* For details, see "Menu Display and Operation" (p. 30).

## Panel Lock

When the PANEL LOCK button is lit, "Panel Lock!!" is displayed and no operations can be performed if any button other than the PAGE button is pressed. To release panel lock, press and hold down the PANEL LOCK button for at least two seconds. When panel lock is released, the PANEL LOCK button goes out.



## Status Screen

The Status screen shows the status of the unit. When power to the unit is turned on, the Status screen is displayed.

There are four types of Status screens. Press the PAGE button to change the display.

- Video Input/Output Format
- Audio Level CH1, CH2
- Audio Level CH3, CH4
- Audio Delay
- Timecode

## Video Input/Output Format

Displays the video input/output format.

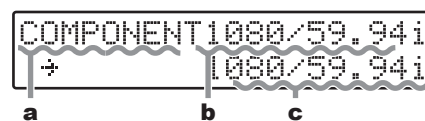

### a Displays the input connector.

- \* The input connector is selected with "Selecting the video input connector" (p. 26).

### b Displays the video input format.

- \* When no video is input to the input connector shown in a., "-----" is displayed.

### c Displays the video output format.

- \* The video output format is selected with "Selecting the video output format" (p. 27).

## Audio Level CH1, CH2

## Audio Level CH3, CH4

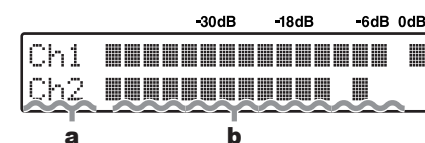

### a Displays the connector where audio is being output.

### b Displays the input audio level of a. The peak is held for a set time.

- \* The audio level cannot be adjusted from this screen. Adjust the audio level from "330: Audio OutCh1&2 Lv" and "331: AudioOutCh3&4Lv" (p. 35) from the Menu (p. 30).
- \* If the audio level is high and the display on the Status screen exceeds 0 dB, the output audio may be distorted. In this case, control the audio level on the device inputting audio to this unit or control the audio level with "330: Audio OutCh1&2 Lv" and "331: AudioOutCh3&4Lv" (p. 35) on the above Menu (p. 30).

## Audio Delay

Displays the amount of audio delay in units of frames. The value in () displays the audio delay in milliseconds.

- \* Set audio delay using the procedure in "Setting internal processing" (p. 28).



## Timecode / User Bit

Displays the time code and user bit output from the i.LINK connector and HD-SDI OUT connector.

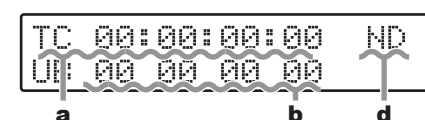

### a Displays the timecode.

- \* If the frame rate of the input video (p. 26) and the output format (p. 27) are different, the displayed timecode is generated internally.

### b Displays the user bit (p. 35).

### c Displays drop frame (D) or non-drop frame (ND).

## Menu Display and Operation

The Menu screen is shown on the display when the MENU button is pressed. Various settings for the VC-300HD/VC-200HD are performed on the Menu screen.

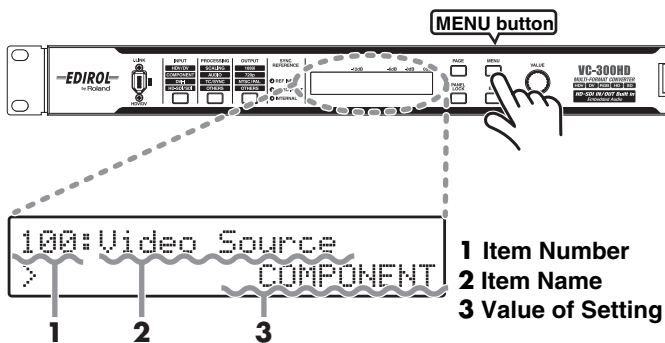

\* See "Menus and settings" (p. 32) for items displayed on the Menu screen.

### Item Selection

When the VALUE/ENTER knob is turned while an item number is blinking, the item number and item name shown on the display changes.

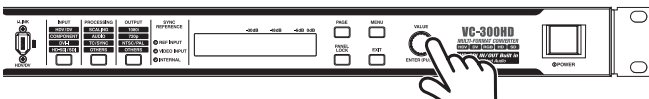

Press the PAGE button to skip groups of item numbers. Press and hold down the PAGE button to display the name of the group being skipped.

The following are the groups.

Name Range of Item Numbers	Group Name	Descriptions
100 – 170	Input Parameter	p. 32
200 – 275	Processing Parameter	p. 33
300 – 391	Output Parameter	p. 35
400 – 460	SDI Parameter	p. 37
900 – 999	System Parameter	p. 37

## Changing the Value of a Setting

Press the VALUE/ENTER knob and the setting's value blinks, indicating that it can be changed.

Use the VALUE/ENTER knob to change the value of the setting.

The selected value for the setting is confirmed by pressing the VALUE/ENTER knob. The setting's value stops blinking and the item number begins to blink.

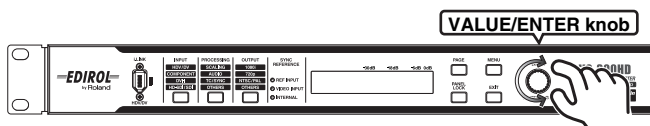

\* If the EXIT button is pressed while the setting's value is blinking, the value is not confirmed and the item returns to the selection status (the item number blinks).

## Exiting from the Menu

When the MENU button is pressed while the Menu is being displayed, the unit exits from the Menu screen and returns to the Status screen (p. 29).

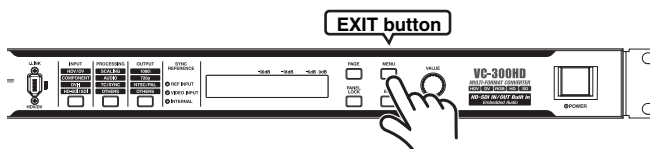

\* If the MENU button is pressed to exit from the Menu while the setting's value is blinking, the selected value is not used.

## Adjusting the Display

The darkness of the text shown in the display and the backlight's brightness can be adjusted with "900: LCD Contrast" and "901: Light Dimmer" (p. 37) from the Menu.

# Appendices

---

# Menus and settings

\* See **Menu Display and Operation** (p. 30) for menu operations.

## 100–162 Input Parameter

Item Number	Item Name	Description and Available Settings
100	Video Source	Specifies connector from which video is to be input. [i.LINK]: Selects the i.LINK connector. COMPONENT: Selects the COMPONENT IN connector. DVI-D: Selects the DVI (Digital) connector. DVI-A: Selects the DVI (Analog) connector. SDI: Selects the HD-SDI IN connector. (VC-300HD only)
110	i.LINK IN	Selects the format of the video input to the i.LINK connector. [Auto]: Selected automatically. 480/59.94i, 576/50i, 720/59.94p, 720/50p, 1080/59.94i, 1080/50i: Select one of these formats.
120	COMPONENT IN	Selects the format of the video input to the COMPONENT INPUT connector. [Auto]: Selected automatically. 480/59.94i, 576/50i, 480/59.94p, 576/50p, 720/59.94p, 720/50p, 1080/59.94i, 1080/50i: Select one of these formats.
122	In 480i Setup	Sets the video input setup level when 480/59.94i is selected for "120: COMPONENT IN." [0IRE]: Selects 0IRE. (NTSC Japan/PAL) 7.5IRE: Selects 7.5IRE. (NTSC excluding Japan)
130	DVI-D IN	Selects the format of the digital video (DVI-D) input to the DVI-I INPUT connector. [Auto]: Selected automatically. 640 x 480/60, 640 x 480/75, 800 x 600/60, 800 x 600/75, 1024 x 768/60, 1024 x 768/75, 1152 x 864/75, 1280 x 768/60, 1280 x 960/60, 1280 x 1024/60, 1280 x 1024/75, 1360 x 768/60: Select one of these formats.
131	DVI-A IN	Selects the format of the analog video (DVI-A) input to the DVI-I INPUT connector. [Auto]: Selected automatically. 640 x 480/60, 640 x 480/75, 800 x 600/60, 800 x 600/75, 1024 x 768/60: Select one of these formats.
132	DVI-A AutoConfig	Automatically adjusts the analog video (DVI-A) input to the DVI-I INPUT connector. When "Please Push [ENTER]" is displayed, press the VALUE/ENTER knob for automatic adjustment. Automatic adjustment automatically changes the values for "133: DVI-A H Position," "134: DVI-A V Position," "135: DVI-A Frequency," and "136: DVI-A Phase."
133	DVI-A H Position	Adjusts the horizontal position of the analog video (DVI-A) input via the DVI-I INPUT connector. -100-[0]- +100 pixel: Larger values move the image to right. * This is automatically adjusted when "132: DVI-A AutoConfig" is used.
134	DVI-A V Position	Adjusts the vertical position of the analog video (DVI-A) input via the DVI-I INPUT connector. -100-[0]- +100 line: Larger values move the image up. * This is automatically adjusted when "132: DVI-A AutoConfig" is used.
135	DVI-A Frequency	Fine tunes the sampling frequency for the analog video (DVI-A) input via the DVI-I INPUT connector. -100-[0]- +100 clock: May be adjusted in this range. * This is automatically adjusted when "132: DVI-A AutoConfig" is used.
136	DVI-A Phase	Fine tunes the sampling phase for the analog video (DVI-A) input via the DVI-I INPUT connector. -100-[0]- +100: May be adjusted in this range. * This is automatically adjusted when "132: DVI-A AutoConfig" is used.
140	SDI IN <b>VC-300HD</b>	Selects the format of the video input to the HD-SDI IN connector. [Auto]: Selected automatically. 480/59.94i, 576/50i, 720/59.94p, 720/50p, 1080/59.94i, 1080/50i: Select one of these formats.
150	Audio Source	Selects the input connector of the audio to be used. [Auto]: Automatically selects the audio input corresponding to "100: Video Source." For i.LINK: Selects the audio input to the i.LINK connector. For COMPONENT: Selects the audio input to the AUDIO INPUT connector. For DVI-D: Selects the audio input to the AUDIO INPUT connector. For DVI-A: Selects the audio input to the AUDIO INPUT connector. For SDI: Selects the audio input to the HD-SDI IN connector. (VC-300HD only) i.LINK: Selects the audio input to the i.LINK connector. AUDIO IN: Selects the audio input to the AUDIO INPUT connector. SDI: Selects the audio input to the HD-SDI IN connector. (VC-300HD only)
160	AUDIO IN Ch	Selects the channels where Sets which channels of the audio output from the AUDIO OUTPUT connectors, HD-SDI OUT connector, and i.LINK connector to assign the audio input to AUDIO INPUT CH1/CH2 and CH3/CH4. * Please also set the SDI output assignment to "450: SDI OUT Audio Ch." (VC-300HD only) CH1/2 CH1/2: Audio output from CH1/CH2 is output to AUDIO IN connector CH1/CH2, and Audio is output from CH3/CH4 output to AUDIO IN connector CH1/CH2. [CH1/2 CH3/4]: Audio output from CH1/CH2 is output to AUDIO IN connector CH1/CH2, and Audio is output from CH3/CH4 output to AUDIO IN connector CH3/CH4. CH3/4 CH1/2: Audio output from CH1/CH2 is output to AUDIO IN connector CH3/CH4, and Audio is output from CH3/CH4 output to AUDIO IN connector CH1/CH2. CH3/4 CH3/4: Audio output from CH1/CH2 is output to AUDIO IN connector CH3/CH4, and Audio is output from CH3/CH4 output to AUDIO IN connector CH3/CH4.

\* The values enclosed in a [box] are the factory defaults.



**100–162 Input Parameter (continued)**

Item Number	Item Name	Description and Available Settings
161	In Ch1&2 NomLv	Sets the input Nominal level for AUDIO INPUT connector CH1 and CH2. +4dBu, -2dBu, -4dBu, -10dBu: Larger numerical values indicate higher levels.
162	In Ch3&4 NomLv	Sets the input Nominal level for AUDIO INPUT connector CH3 and CH4. +0dBu, -6dBu, -8dBu, -14dBu: Larger numerical values indicate higher levels.
170	DV In Audio Ch	Selects the channel with audio output from either the AUDIO OUTPUT connectors or HD-SDI OUT connector when the DV input audio input via the i.LINK connector is 4-channel (32 kHz). * This setting is ignored when the DV input audio is 2-channel (48 kHz).

**200–275 Processing Parameter**

Item Number	Item Name	Description and Available Settings																																																																	
200	Scaling Type	<p>Sets the scaling type.</p> <p>[Squeeze]: Uses the same aspect ratio as the input.</p> <table border="1" style="width: 100%; text-align: center;"> <thead> <tr> <th></th> <th>Original Image</th> <th></th> <th>4:3</th> <th>16:9</th> </tr> </thead> <tbody> <tr> <td>4:3 NTSC / 480i PAL / 576i, 1024 x 768 800 x 600, 640 x 480</td> <td></td> <td>→</td> <td></td> <td></td> </tr> <tr> <td>4:3 (Letterbox) NTSC / 480i PAL / 576i</td> <td></td> <td>→</td> <td></td> <td></td> </tr> <tr> <td>4:3 (Squeeze) NTSC / 480i PAL / 576i</td> <td></td> <td>→</td> <td></td> <td></td> </tr> <tr> <td>16:9 1080i 720p</td> <td></td> <td>→</td> <td></td> <td></td> </tr> </tbody> </table> <p>Side Panel / Let Box: Shows the entire image, with black shown in portions where there is no video image.</p> <table border="1" style="width: 100%; text-align: center;"> <tbody> <tr> <td>4:3, NTSC / 480i PAL / 576i, 1024 x 768 800 x 600, 640 x 480</td> <td></td> <td>→</td> <td></td> <td></td> </tr> <tr> <td>4:3 (Letterbox) NTSC / 480i PAL / 576i</td> <td></td> <td>→</td> <td></td> <td></td> </tr> <tr> <td>4:3 (Squeeze) NTSC / 480i PAL / 576i</td> <td></td> <td>→</td> <td></td> <td></td> </tr> <tr> <td>16:9 1080i 720p</td> <td></td> <td>→</td> <td></td> <td></td> </tr> </tbody> </table> <p>Crop: Displays the image so as to fill the entire screen; does not show the portions extending outside.</p> <table border="1" style="width: 100%; text-align: center;"> <tbody> <tr> <td>4:3, NTSC / 480i PAL / 576i, 1024 x 768 800 x 600, 640 x 480</td> <td></td> <td>→</td> <td></td> <td></td> </tr> <tr> <td>4:3 (Letterbox) NTSC / 480i PAL / 576i</td> <td></td> <td>→</td> <td></td> <td></td> </tr> <tr> <td>4:3 (Squeeze) NTSC / 480i PAL / 576i</td> <td></td> <td>→</td> <td></td> <td></td> </tr> <tr> <td>16:9 1080i 720p</td> <td></td> <td>→</td> <td></td> <td></td> </tr> </tbody> </table>		Original Image		4:3	16:9	4:3 NTSC / 480i PAL / 576i, 1024 x 768 800 x 600, 640 x 480		→			4:3 (Letterbox) NTSC / 480i PAL / 576i		→			4:3 (Squeeze) NTSC / 480i PAL / 576i		→			16:9 1080i 720p		→			4:3, NTSC / 480i PAL / 576i, 1024 x 768 800 x 600, 640 x 480		→			4:3 (Letterbox) NTSC / 480i PAL / 576i		→			4:3 (Squeeze) NTSC / 480i PAL / 576i		→			16:9 1080i 720p		→			4:3, NTSC / 480i PAL / 576i, 1024 x 768 800 x 600, 640 x 480		→			4:3 (Letterbox) NTSC / 480i PAL / 576i		→			4:3 (Squeeze) NTSC / 480i PAL / 576i		→			16:9 1080i 720p		→		
	Original Image		4:3	16:9																																																															
4:3 NTSC / 480i PAL / 576i, 1024 x 768 800 x 600, 640 x 480		→																																																																	
4:3 (Letterbox) NTSC / 480i PAL / 576i		→																																																																	
4:3 (Squeeze) NTSC / 480i PAL / 576i		→																																																																	
16:9 1080i 720p		→																																																																	
4:3, NTSC / 480i PAL / 576i, 1024 x 768 800 x 600, 640 x 480		→																																																																	
4:3 (Letterbox) NTSC / 480i PAL / 576i		→																																																																	
4:3 (Squeeze) NTSC / 480i PAL / 576i		→																																																																	
16:9 1080i 720p		→																																																																	
4:3, NTSC / 480i PAL / 576i, 1024 x 768 800 x 600, 640 x 480		→																																																																	
4:3 (Letterbox) NTSC / 480i PAL / 576i		→																																																																	
4:3 (Squeeze) NTSC / 480i PAL / 576i		→																																																																	
16:9 1080i 720p		→																																																																	

\* The values enclosed in a [box] are the factory defaults.

**200–275 Processing Parameter (continued)**

Item Number	Item Name	Description and Available Settings
210	Out Zoom	Adjusts the magnification of the output video. 50–[100]–200%: Larger numerical values make the image larger. * <i>The maximum value that can be selected changes according to the combination of the input video format (p. 26) and the output format (p. 27).</i>
211	Out H Position	Adjusts the horizontal position of the output video when the aspect ratios of the input video (p. 26) and the output format (p. 27) are different and "Side Panel/Let" or "Crop" is selected with "200: Scaling Type." -100–[0]– +100 %: Larger values move the image right.
212	Out V Position	Adjusts the vertical position of the output video when the aspect ratios of the input video (p. 26) and the output format (p. 27) are different and "Side Panel/Let" or "Crop" is selected with "200: Scaling Type." -100–[0]– +100 lines: Larger values move the image up.
220	Noise Reduction	Obscures noise in the input video so it is unnoticeable. If it is set too strong, the video resolution may be reduced. [Off]: Do not use 1–63: The strength of the Noise Reduction
221	Enhancement	Emphasizes the edges of the input video. If set too strong, the edges may look jagged. [Off]: Do not use 1–63: Strength of Enhancement
222	Video Red Gain	Sets the gain value for red in the video being output. [0]–100%: Larger numerical values indicate a stronger red color.
223	Video Green Gain	Sets the gain value for green in the video being output. [0]–100%: Larger numerical values indicate a stronger green color.
224	Video Blue Gain	Sets the gain value for blue in the video being output. [0]–100%: Larger numerical values indicate a stronger blue color.
240	AudioDelay Time	Sets the delay applied to the output audio. 0.00–[1.00]–15.00f * The time per frame changes according to the frame rate in the value set in "300:Video Out Format." Therefore, the range of values displayed on the screen (??? ms) is as follows. -When the frame rate is 59.94i/59.94p -When the frame rate is 50i/50p
250	Audio Low Gain	Sets the low-range gain value for the sound being output. -12dB–[0]– +12dB: Increasing the numerical value increases the low-range gain value.
251	Audio Mid Gain	Sets the mid-range gain value for the sound being output. -12dB–[0]– +12dB: Increasing the numerical value increases the mid-range gain value.
252	Audio High Gain	Sets the high-range gain value for the sound being output. -12dB–[0]– +12dB: Increasing the numerical value increases the high-range gain value.
260	Sync Source	Sets the synchronizing signal input source. [Auto]: Selected automatically. REF Input: Selects the REF INPUT connector. Video Input: Selects the video being used. Internal: Uses the synchronizing signal generated internally.
261	Sync Adjust	Fine tunes the synchronizing signal. -1000–[0]– +1000 clock: May be adjusted in this range.
270	TC Generate	Selects the timecode to embed in the HDV, DV, or HD-SDI output. * <i>On the VC-200HD, this is set to "Off" at the factory.</i> [Off]: Time code is not embedded. Free Run: Timecode is generated internally. The timecode is generated from when the power is turned on or when "271: TC Offset" is set. Free Run: The time code starts (preset) from the moment settings are made with "271: TC Offset." [Thru]: Use the timecode input from an external source. The timecode that is used will be that which is embedded in the signal of the video connector being used. * <i>This setting is ignored when the frame rates of the input video (p. 26) and the output format (p. 27) are different. The time code output here is the same as when "Free Run" is set.</i> Offset: Output the timecode input from an external source with the offset set with "271: TC Offset" appended to it. The TC that is used will be that which is embedded in the signal of the video connector being used.
271	TC Offset	Sets the offset to apply when "Offset" is selected with "270: TC Generate." This value will be the time code's preset value when "Free Run" is set for "270: TC Generate." The hour (h), minute (m), second (s), and frame (f) values can be set independently for this item. [00h00m00s00f]–23h59m59s24f (When the frame rate value set for "300:Video Out Format" is 50i or 50p) [00h00m00s00f]–23h59m59s29f (When the frame rate value set for "300:Video Out Format" is 59.94i or 59.94p) * <i>The available range for this parameter changes when the "300: Video Out Format" parameter is changed.</i> * <i>When "Free Run" is set for "270: TC Generate," the time code count is reset when this item setting is changed.</i>

\* The values enclosed in a [box] are the factory defaults.

\* For items 201-212 and 220-224, please adjust while confirming on a video monitor.

### 200–275 Processing Parameter (continued)

Item Number	Item Name	Description and Available Settings
274	User Bit	Sets the user bit embedded in the timecode when "Free Run" is set with "270: TC Generate." * Because there is no impact when the value set for "270: TC Generate" is not "Free Run," the input user bit is passed through without any change. If no user bit is input, "FF FF FF FF" is output. This item sets each value independently. [00]–FF, [00]- FF, [00]–FF, [00]- FF: May be adjusted in this range.
275	Drop Frame	Selects drop frame/non-drop frame for the time code when "Free Run" is set with "270: TC Generate." [Drop]: Selects Drop Frame. Non Drop: Selects Non-drop Frame. * The setting is not valid when "1080/50p," "1080/50i," "720/50p," "576/50p," or "576/50i" is selected with "300: Video Out Format."

\* The values enclosed in a [box] are the factory defaults.



### 300–391 Output Parameter

Item Number	Item Name	Description and Available Settings
300	Video Out Format	Selects the format of the video to output. [Auto]: One of the following formats is automatically selected, so as to match the format of the input video. 1080/59.94p, 1080/50p, 1080/59.94i, 1080/50i, 720/59.94p, 720/50p, 480/59.94p, 576/50p, 480/59.94i, 576/50i: Select one of these formats. * If "Auto" is set or if "Free Run" is set with "270: TC Generate" of the video input being used, the time code count is reset when this item setting is changed
311	Out 480i Setup	Sets the video output setup level of the COMPONENT OUT connector when 480/59.94i is selected for "300: Video Out Format." [0IRE]: Selects 0IRE. (NTSC Japan/PAL) 7.5IRE: Selects 7.5IRE. (NTSC excluding Japan)
320	Audio Out Fs	Sets the sampling frequency of the digital audio output from the i.LINK connector or HD-SDI OUT connector. [48 kHz]: Outputs audio in 48 kHz. 32 kHz: Outputs audio in 32 kHz. If "480/59.94i" or "576/50i" is selected with "300: Video Out Format" at this time, the output from the i.LINK connector is a DV signal and the audio is 4 channel. If anything else is set, no video is output from the i.LINK connector.
330	AudioOutCh1&2Lv	Sets the audio output level for AUDIO OUTPUT connectors CH1 and CH2. Mute: Mutes the audio. -40 dB –[0]– +12 dB: Adjusts the sound output level.
331	AudioOutCh1&2Lv	Sets the audio output level for AUDIO OUTPUT connectors CH3 and CH4. Mute: Mutes the audio. -40 dB –[0]– +12 dB: Adjusts the sound output level.
340	Audio Out Mode	Sets the audio mode of the audio output from the AUDIO OUT connector [2Ch]: Outputs 2 channels. 4Ch: Outputs 4 channels.
350	Out Ch1&2 NomLv	Sets the output Nominal level for AUDIO OUTPUT connectors CH1 and CH2. [+4dBu], -2dBu, -4dBu, -10dBu: Larger numerical values indicate higher levels.
351	Out Ch3&4 NomLv	Sets the output Nominal level for AUDIO OUTPUT connectors CH3 and CH4. [+0dBu], -6dBu, -8dBu, -14dBu: Larger numerical values indicate higher levels.
360	DV Locked Audio	When outputting with the DV format from the i.LINK connector, sound is output with "Locked Audio." [Off]: Do not use locked audio. On: Use locked audio.

\* The values enclosed in a [box] are the factory defaults.

\* For items 350 and 351, please adjust while confirming on a monitor speaker.

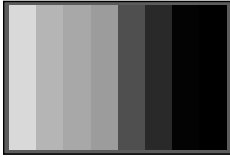
**300–391 Output Parameter (continued)**

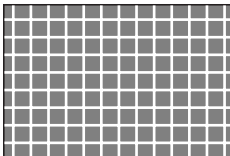
Item Number	Item Name	Description and Available Settings
390	Test Pattern	<p>Displays the test pattern.</p> <p>[Off]: No test pattern is displayed.</p> <p>75%: Displays a 75% color bar.</p>  <p>100%: Displays a 100% color bar.</p>  <p>Hatch: Displays a cross hatch.</p> 
391	Test Tone	<p>Outputs a test tone from the AUDIO OUT connector, i.LINK connector, and HD-SDI connector.</p> <p>[Off]: The test tone is not output.</p> <p>-20dB@1 kHz: Output at -20dB and 1 kHz.</p> <p>-10dB@1 kHz: Output at -10dB and 1 kHz.</p> <p>0dB@1 kHz: Output at 0dB and 1 kHz.</p>

Note: For item numbers 351, 353, and 354, please adjust while confirming with headphones.

Note: The values enclosed in a [box] are the factory defaults.

## 400–452 SDI Parameter **VC-300HD**

Item Number	Item Name	Description and Available Settings
400	SDI IN AudioCh	Selects the channels to be used for conversion with "AUDIO PROCESSOR [CH A&B]" or "AUDIO PROCESSOR [CH C&D]" (p. 43) from the embedded audio input via the HD-SDI IN connector. AB:1/2 CD:1/2: Channels 1 and 2 are used for [CH A&B], and channels 1 and 2 are used for [CH C&D]. [AB:1/2 CD:3/4]: Channels 1 and 2 are used for [CH A&B], and channels 3 and 4 are used for [CH C&D]. AB:1/2 CD:5/6: Channels 1 and 2 are used for [CH A&B], and channels 5 and 6 are used for [CH C&D]. AB:1/2 CD:7/8: Channels 1 and 2 are used for [CH A&B], and channels 7 and 8 are used for [CH C&D]. AB:3/4 CD:1/2: Channels 3 and 4 are used for [CH A&B], and channels 1 and 2 are used for [CH C&D]. AB:3/4 CD:3/4: Channels 3 and 4 are used for [CH A&B], and channels 3 and 4 are used for [CH C&D]. AB:3/4 CD:5/6: Channels 3 and 4 are used for [CH A&B], and channels 5 and 6 are used for [CH C&D]. AB:3/4 CD:7/8: Channels 3 and 4 are used for [CH A&B], and channels 7 and 8 are used for [CH C&D]. AB:5/6 CD:1/2: Channels 5 and 6 are used for [CH A&B], and channels 1 and 2 are used for [CH C&D]. AB:5/6 CD:3/4: Channels 5 and 6 are used for [CH A&B], and channels 3 and 4 are used for [CH C&D]. AB:5/6 CD:5/6: Channels 5 and 6 are used for [CH A&B], and channels 5 and 6 are used for [CH C&D]. AB:5/6 CD:7/8: Channels 5 and 6 are used for [CH A&B], and channels 7 and 8 are used for [CH C&D]. AB:7/8 CD:1/2: Channels 7 and 8 are used for [CH A&B], and channels 1 and 2 are used for [CH C&D]. AB:7/8 CD:3/4: Channels 7 and 8 are used for [CH A&B], and channels 3 and 4 are used for [CH C&D]. AB:7/8 CD:5/6: Channels 7 and 8 are used for [CH A&B], and channels 5 and 6 are used for [CH C&D]. AB:7/8 CD:7/8: Channels 7 and 8 are used for [CH A&B], and channels 7 and 8 are used for [CH C&D].
401	SDI IN TC	Selects the type of embedded Timecode to be input to the HD-SDI IN connector. LTC: Selects the LTC. [VITC]: Selects the VITC.
450	SDI OUT AudioCh	Selects the channels to be used for conversion with "AUDIO PROCESSOR [CH A&B]" or "AUDIO PROCESSOR [CH C&D]" (p. 43) from the embedded audio input via the HD-SDI IN connector. [AB:1/2 CD:3/4]: Channels 1 and 2 are used for [CH A&B], and channels 3 and 4 are used for [CH C&D]. AB:1/2 CD:5/6: Channels 1 and 2 are used for [CH A&B], and channels 5 and 6 are used for [CH C&D]. AB:1/2 CD:7/8: Channels 1 and 2 are used for [CH A&B], and channels 7 and 8 are used for [CH C&D]. AB:3/4 CD:1/2: Channels 3 and 4 are used for [CH A&B], and channels 1 and 2 are used for [CH C&D]. AB:3/4 CD:5/6: Channels 3 and 4 are used for [CH A&B], and channels 5 and 6 are used for [CH C&D]. AB:3/4 CD:7/8: Channels 3 and 4 are used for [CH A&B], and channels 7 and 8 are used for [CH C&D]. AB:5/6 CD:1/2: Channels 5 and 6 are used for [CH A&B], and channels 1 and 2 are used for [CH C&D]. AB:5/6 CD:3/4: Channels 5 and 6 are used for [CH A&B], and channels 3 and 4 are used for [CH C&D]. AB:5/6 CD:7/8: Channels 5 and 6 are used for [CH A&B], and channels 7 and 8 are used for [CH C&D]. AB:7/8 CD:1/2: Channels 7 and 8 are used for [CH A&B], and channels 1 and 2 are used for [CH C&D]. AB:7/8 CD:3/4: Channels 7 and 8 are used for [CH A&B], and channels 3 and 4 are used for [CH C&D]. AB:7/8 CD:5/6: Channels 7 and 8 are used for [CH A&B], and channels 5 and 6 are used for [CH C&D]. * You cannot select the same channel for "AUDIO PROCESSOR [CH A&B]" and "AUDIO PROCESSOR [CH C&D]."
451	SDI OUT TC	Selects the type of embedded Timecode to be output from the HD-SDI IN connector. LTC: Selects the LTC. [VITC]: Selects the VITC.

Note: The values enclosed in a [box] are the factory defaults.

## 900–999 System Parameter

Item Number	Item Name	Description and Available Settings
900	LCD Contrast	Adjusts the display contrast. 0–[7]–10
901	Light Dimmer	Adjusts the brightness of the display backlighting. 0–[7]–10
999	Factory Reset	Resets the settings to the factory defaults. When "Are you sure?" is displayed, press the VALUE/ENTER knob to reset.

\* The values enclosed in a [box] are the factory defaults.

# Input / Output Signal

## HDV

HDV (High Definition Video) is the standard term used for the format to record High-definition television (HDTV) onto DV tape used in digital video cameras.

HDV uses MPEG-2 for video compression. DV uses a method that compresses each video frame individually, but HDV realizes high definition recording with the same data volume as DV by using MPEG-2 inter-frame prediction. Because of this, although high definition video has considerably more data than SD video, it can secure the same amount of recording time as DV.

MPEG-1 Audio Layer-2 is used for audio compression. The sampling frequency is 48 kHz, and the 16-bit stereo audio is compressed with a bit rate of 384 kbps.

The "HDV Standard" defines two types: "HDV 1080i," interlaced scanning with 1080 lines of effective scan lines, and "HDV 720p," 720 lines of progressive scanning.

### HDV 1080i

The HDV1080i method compresses with about 25 Mbps MPEG-2 video and records 1440 x 1080 pixels, interlaced video of 60/50 fields per second (NTSC/PAL).

### HDV 720p

The HDV 720p method compresses with about 19 Mbps MPEG-2 video and records 1280 x 720 pixels, progressive video of 30 or 60/25 or 50 frames per second (NTSC/PAL).

## SDI

SDI (serial digital interface) is a standard defined by SMPTE (Society of Motion Picture and Television Engineers) and is used widely today in the broadcast and video production industries. The SDI standard prescribes methods for transmitting non-compressed serial digital video data using a BNC cable (video coaxial cable) between devices in the production facility.

The SDI standard is of two types: standard definition (SD) SDI and high definition (HD) SDI.

## DV

DV (Digital Video) is the SD television image quality digital video standard. It supports both NTSC and PAL TV standards. One frame of data has video and audio combined. The bit rate is about 27 Mbps. Video compression is only performed with interlaced. Because compression is not performed along the time axis, as with MPEG, compression is about 1/5, but a merit is that video editing can be performed simply at the frame level.

Audio has sampling frequencies of 48/44.1/32 kHz with non-compressed linear PCM. The quantization bit rate is 16 bit in stereo. In 32 kHz mode, the quantization bit rate is 12 bits, so four-channel recording is possible.

## DVI

DVI (Digital Visual Interface) is a video output interface standard designed for maximizing image quality on display devices that focus on digital video, such as LCD monitors. This standard is designed to send uncompressed digital video data to the display. There is also partial compatibility with the HDMI standard. It also supports analog video interfaces (VGA signals) for existing CRT displays, as well as digital interfaces.

The DVI connector on a device can have one of three names, depending on the signals it carries.

DVI-D (digital)

DVI-A (analog)

DVI-I (digital and analog)

Note: According to the standard, a cable length of up to 5 meters is permissible.

## HDMI

HDMI (High-Definition Multimedia Interface) is for AV home electronics that adds audio transmission functionality, copyright protection functionality, and color difference transmission functionality to DVI. To input HDMI to this device, use a separately purchased DVI-I HDMI conversion cable and connect it to the DVI connector.

If a DVI-I HDMI conversion cable is used, then the audio output with HDMI is not output to the DVI side.

## RGB

This is one of the video outputs for computers and is sometimes called VGA output or analog output. In general, it is output using a D-Sub 15-pin (DB-15) connector. For this device, a commercially available DVI adapter (VGA-DVI) can be used in the DVI-I connector for input.

## Interlaced and Progressive

Video gives the appearance of movement by continuously displaying screens (frames) within a fixed time. To transmit screens with an electronic signal, the image is cut into numerous horizontal lines as shown in the figure and is transmitted as "threads" of electronic signals. These "threads" are called scan lines. There are two methods of arranging scan lines: the "interlaced method (i)" and the "progressive method (p)." (See figure at right.)

The interlaced method divides the fields into ODD and EVEN fields and transfers them at a rate of 59.94 fields per second for NTSC. The two fields are displayed alternately, but the image appears to

move smoothly with the 59.94 frames due to the image persistence of human vision. The actual number of frames (frame rate) displayed each second is 29.97 frames for NTSC and 25 frames for PAL.

The progressive method scans screens without interlacing and displays images in frame units. For example, with 720/59.94p, 59.94 image frames are displayed each second; with 720/50p, 50 image frames are displayed each second. However, the time code is the same as for the interlaced method, so when the time code advances one frame, the progressive method video advances two frames.

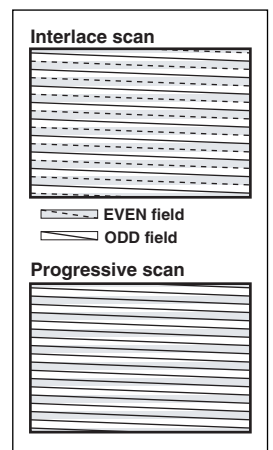

# Installation and Maintenance

## Installing and Removing the Rack Mount Fittings

The rack mounts fittings for this device can be installed or removed.

### **Cautions regarding removing the rack mount fittings**

- Please use a Phillips screwdriver that fits the screw head (No. 2 screwdriver). If the screwdriver does not fit the screw head, then the screw head may become stripped.
- To remove the screws, turn the screwdriver in a counterclockwise direction. To tighten the screws, turn the screwdriver in a clockwise direction.



- When turning this unit over, place newspapers or magazines under the four corners or under both sides to prevent damage to the buttons and knobs. Also, position the unit so that the buttons and knobs won't get damaged.
- When turning the unit upside-down, handle with care to avoid dropping it, or allowing it to fall or tip over.
- When removing the rack mount fittings, remove only the specified screws.

### **How to remove the rack mount fittings**

- 1 Before removing the rack mount fittings, turn off power to this unit and to all connected devices and then unplug the power cord and all connected cables.**
- 2 Remove only the screws indicated in the next figure and then remove the rack mount fittings. A total of six screws on the left and right are removed.**

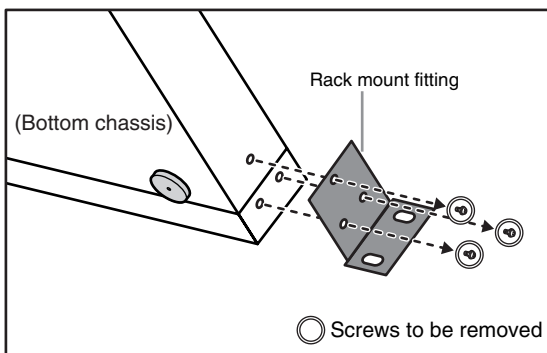

- 3 Replace the screws removed in Step 2 to their original location.**

- \* To attach the rack mount fittings, follow the above procedure in reverse. After attaching, check again that the fittings are attached correctly.

## Daily Maintenance

Forced air cooling is inhibited if the cooling fan's intake vent or exhaust vent becomes blocked with dust and the airflow is impeded.

Periodically use a vacuum cleaner to clear out dust from the cooling fan's exhaust vent and intake vent.

## Fan

If the cooling fan mounted in this device should become damaged, the device may be subject to overheating, because proper cooling cannot occur. If you suspect that the cooling fan is not operating properly, contact the retailer where the unit was purchased or a service center listed on the back of the warranty envelope.

# Troubleshooting

If damage is suspected, please check the following again. If the problem persists after checking the following, please consult with a service center (listed on the back of the warranty envelope) or the retailer from whom this device was purchased.

## Video

### No video is output

- Is the equipment properly connected?
  - Check that all devices are connected properly.
- Is the proper output format selected?
  - If the video output of this unit is not in a format supported by the connected equipment, the video from this device may not be output.
  - Check the formats supported by the connected equipment, and reselect the video format with the OUTPUT button or from the Menu.

\* See "Selecting the video output format" (p. 27)."

### The output video is distorted

- Is the input video, output format, or internal processing being directly switched?
  - The processing method is being set within the unit. Please wait until the video stabilizes.
- Is the video being output in a format that the connected device does not support?
  - If the video output of this unit is not in a format supported by the connected equipment, the video may be distorted.
  - Check the formats supported by the connected equipment, and reselect the video format with the OUTPUT button or from the Menu.

\* See "Selecting the video output format" (p. 27).

- Is it possible that the signal being input via the i.LINK connector contains errors?
  - When the HDV signal or DV signal contains errors, this unit is not capable of correcting them.

### The video moves in a jerky fashion

- Is the input video frame rate different from the output format?
  - When video that has a different frame rate than what has been set for the output format is input, some jerkiness may occasionally be exhibited as the result of the frame rate conversion process. For example, if video with a frame rate of 59.94, as with NTSC, is input, and the frame rate of the output is 50, as with 1080/50i, then 1 out of every 6 frames is not displayed and the video is jerky.

\* See "Selecting the video input connector" (p. 26), "Selecting the video output format" (p. 27).

### The HDV signal is not output

- Is "320: Audio Out Fs" of the Menu (p. 30) set to "32kHz"?
  - Set it to "48kHz."

### No signal is input to the HDV or DV device

- Is input detected with the HDV or DV signal connected to this unit with the i.LINK cable (IEEE 1394 cable)?
  - Check the i.LINK cable (IEEE1394 cable) connection.
  - If the connection is verified, after checking the output format (p. 27), turn power off to this unit and then restart it.

### The HDV device does not accept the HDV signal output from this device

- Does the output format support the HDV device?
  - When the output format selected by pressing the OUTPUT button (p. 10) is not supported by the HDV device, some HDV devices may not display the video even if the HDV signal is received. Please select a format supported by the HDV device being used.

\* See "Selecting the video output format" (p. 27).

## Audio

### There is no audio

- Is audio being input?
  - Check to see that this device and the connected device are turned on.
  - Check to see that this device and the connected device have the volume turned on.
  - Check that the cables are connected.

### The volume of the device connected to the AUDIO INPUT connector is low

- The volume level of the instrument connected to AUDIO INPUT is too low.
  - Could you be using a connection cable that contains a resistor? Use a connection cable that does not contain a resistor.
- Does the connecting cable contain a resistor?
  - Use a connecting cable that doesn't contain a resistor (such as one from the Roland PCS series).

### The video lags behind the audio

- Does the video input to this device pass through a video mixer?
  - Video that passes through a device such as a video mixer or a frame synchronizer has a delay on the output video.
  - When passing through lip sync, please use this device's audio delay feature.

\* See "AudioDelay Time" (p. 34).

### The sound is distorted

- Is the sound level input into this device being clipped?
  - Check the sound level of the input to this device on the Status screen (p. 29). If the maximum sound level is clipped, the input sound will be distorted. In these cases, either turn down the sound level on the connected device or adjust "p. 33" from the menu on this device.

## Miscellaneous

### The SDI signal cannot be captured with non-linear software (VC-300HD only)

- Is the time code being output?
  - Some non-linear software will terminate capture if the time code is lost. Set "270: TC Generate" of the Menu (p. 30) to output the time code.  
If a signal with embedded time code, such as an SDI signal, is set in the input when using VC-300HD, set to "Thru" or "Offset." When using the VC-200HD or when setting a signal that does not have embedded time code, such as a composite signal or a DVI-I signal, with the VC-300HD, set to "Free Run."



# Main Specifications

VC-200HD / VC-300HD: MULTI-FORMAT CONVERTER

## Video Input Format

### ▶ IEEE1394 (i.LINK)

HDV: 1080/59.94i, 1080/50i, 720/59.94p, 720/50p  
DV: 480/59.94, 576/50

### ▶ Component

Y/Pb/Pr: 1080/59.94i, 1080/50i, 720/59.94p, 720/50p,  
480/59.94p, 576/50p, 480/59.94i, 576/50i

### ▶ DVI-I

Digital (RGB):

1600x1200/60Hz, 1400x1050/60/75Hz,  
1280x1024/60/75Hz, 1280x768/60Hz,  
1280x960/60Hz, 1152x864/75Hz,  
1024x768/60/75Hz, 800x600/60/75Hz,  
640x480/60/75Hz

Analog (Y/Pb/Pr):

1024x768/60Hz, 800x600/60/75Hz,  
640x480/60/75Hz

### ▶ HD-SDI/SDI (VC-300HD Only)

1080/59.94i, 1080/50i, 720/59.94p, 720/50p,  
480/59.94i, 576/50i

### ▶ REF: BNC Type Black Burst, BiLevel, TriLevel Sync

## Video Sampling Rate:

SD: 4:4:4 (Y/Cb/Cr), 10 bits, 13.5 MHz

HD: 4:4:4 (Y/Pb/Pr), 10 bits, 74.1758 MHz/74.25 MHz

RGB: 4:4:4 (R/G/B), 10 bits, 25 MHz to 90 MHz

## Video Output Format

### ▶ IEEE1394 (i.LINK)

HDV: 1080/59.94i, 1080/50i, 720/59.94p, 720/50p  
DV: 480/59.94i, 576/50i

### ▶ Component

Y/Pb/Pr: 1080/59.94p, 1080/50p, 1080/59.94i, 1080/50i,  
720/59.94p, 720/50p, 480/59.94p, 576/50p,  
480/59.94i, 576/50i

### ▶ DVI-I

Digital (RGB):

1080/59.94p, 1080/50p, 1080/59.94i,  
1080/50i, 720/59.94p, 720/50p,  
480/59.94p, 576/50p, 480/59.94i, 576/50i

Analog (Y/Pb/Pr):

1080/59.94p, 1080/50p, 1080/59.94i,  
1080/50i, 720/59.94p, 720/50p, 480/59.94p,  
576/50p, 480/59.94i, 576/50i

### ▶ HD-SDI/SDI (VC-300HD Only)

1080/59.94i, 1080/50i, 720/59.94p, 720/50p,  
480/59.94i, 576/50i

### ▶ REF: BNC Type, Loop Thru Output

## Audio Input

### ▶ IEEE1394

HDV: MPEG1 Layer II 16 bit 48 k Hz 384 k bps  
DV: Linear PCM 16 bit 48 k Hz,  
Nonlinear PCM 12 bit 32 k Hz(2ch)

### ▶ Analog

Balanced XLR Type (ch1,ch2):  
+4 dBu, -2 dBu, -4 dBu, -10 dBu Selectable  
Unbalanced RCA phono type(ch3,ch4):  
+0 dBu, -6 dBu, -8 dBu, -14 dBu Selectable  
Audio Sampling Rate: 24 bit, 48 k Hz / 32 k Hz

### ▶ HD-SDI/SDI Embedded Audio (VC-300HD Only)

Linear PCM 24 bit 48 k Hz

## Audio Output

### ▶ IEEE1394

HDV: MPEG1 Layer II 16 bit 48 k Hz 384 kbps  
DV: Linear PCM 16 bit 48 k Hz,  
Nonlinear PCM 12 bit 32 k Hz(2ch)

### ▶ Analog

Balanced XLR Type (ch1,ch2):  
+4 dBu, -2 dBu, -4 dBu, -10 dBu Selectable  
Unbalanced RCA phono type(ch3,ch4):  
+0 dBu, -6 dBu, -8 dBu, -14 dBu Selectable  
Audio Sampling Rate: 24 bit, 48 k Hz / 32 k Hz

### ▶ HD-SDI/SDI Embedded Audio (VC-300HD Only)

Linear PCM 24 bit 48 k Hz

## Processing

### ▶ Video Processing

Scaling: Scaling between the specified input and output  
Frame Sync: Built in frame synchronizer and genlock to external device  
Frame Rate Conversion: from 59.94 to 50 Hz etc.  
I/P Conversion: De-interlace function built-in

### ▶ Audio Processing

Delay: Adjustment with Milli-Second or Frame  
Sample Rate Conversion: from 32 to 48 k Hz etc.

## Video Connectors

IEEE1394 Connector(i.LINK)

6-pin Type, conforms to IEEE1394, HDV standards, Same connector on front and rear

### ➤ COMPONENT Input Connector

HD/SD Y/Pb/Pr BNC Type 75 ohms, BiLevel, TriLevel Sync

### ➤ DVI-I Input Connector

DVI 29pin single link RGB (8 bit each)

Digital RGB dot clock: 25-161MHz (VGA to UXGA)

Analog RGB: R/G/B 0.7 Vp-p, 75 ohms, H/V 5VTTL, RGB dot clock: 25-90MHz(VGA to XGA)

### ➤ HD-SDI/SDI Input Connector (VC-300HD Only)

BNC Type Supports embedded audio

Conforms to SMPTE259M, SMPTE272M, SMPTE292M, SMPTE299M

### ➤ COMPONENT Output Connector

HD/SD Y/Pb/Pr BNC Type 75 ohms, BiLevel, TriLevel Sync

### ➤ DVI-I Output Connector

DVI 29pin single link RGB (8 bit each)

Digital RGB: same timing as analog component

Analog Component: Y/Pb/Pr 75 ohms

### ➤ HD-SDI/SDI Output Connector (VC-300HD Only)

BNC Type Supports embedded audio

Conforms to SMPTE259M, SMPTE272M, SMPTE292M, SMPTE299M

## Audio Connectors

Input Jacks 1ch, 2ch XLR type, 20 k ohms

Input Jacks 3ch, 4ch RCA phono type, 20 k ohms

Output Jacks 1-2 XLR type, 600 ohms

Output Jacks 3-4 RCA phono type, 1 k ohms

## Power Supply

AC 117 V, AC 230 V, AC 240 V (50/60 Hz)

AC 220 V (60 Hz)

## Power Consumption

60 W

## Dimensions

482(430 without Rack Mount Bracket) (W) x 309 (D) x 44 (H) mm

19(16-15/16 without Rack Mount Bracket) (W) x 12-3/16 (D) x 1-

3/4 (H) inches

\* EIA-1U Rack Mount Size

## Weight

4.5 kg

9 lbs 15 oz

## Accessories

Owner's Manual

Rubber feet x 4

Power Cord

(0 dBu = 0.775 V rms)

\* In the interest of product improvement, the specifications and/or appearance of this unit are subject to change without prior notice.

## Exterior Dimensions Diagram

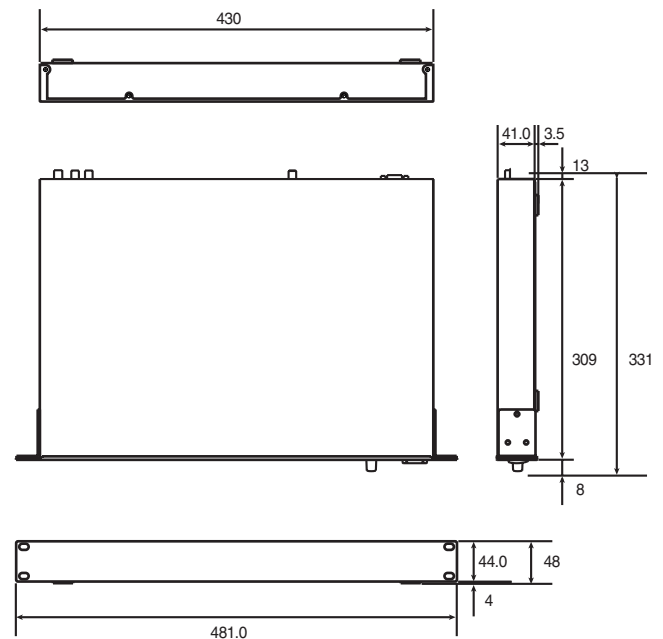

Note: Measurements are with the rubber feet (included) attached.

Note: The power cord is not included.

# VC-200HD Block Diagram

## VC-300HD BLOCK DIAGRAM

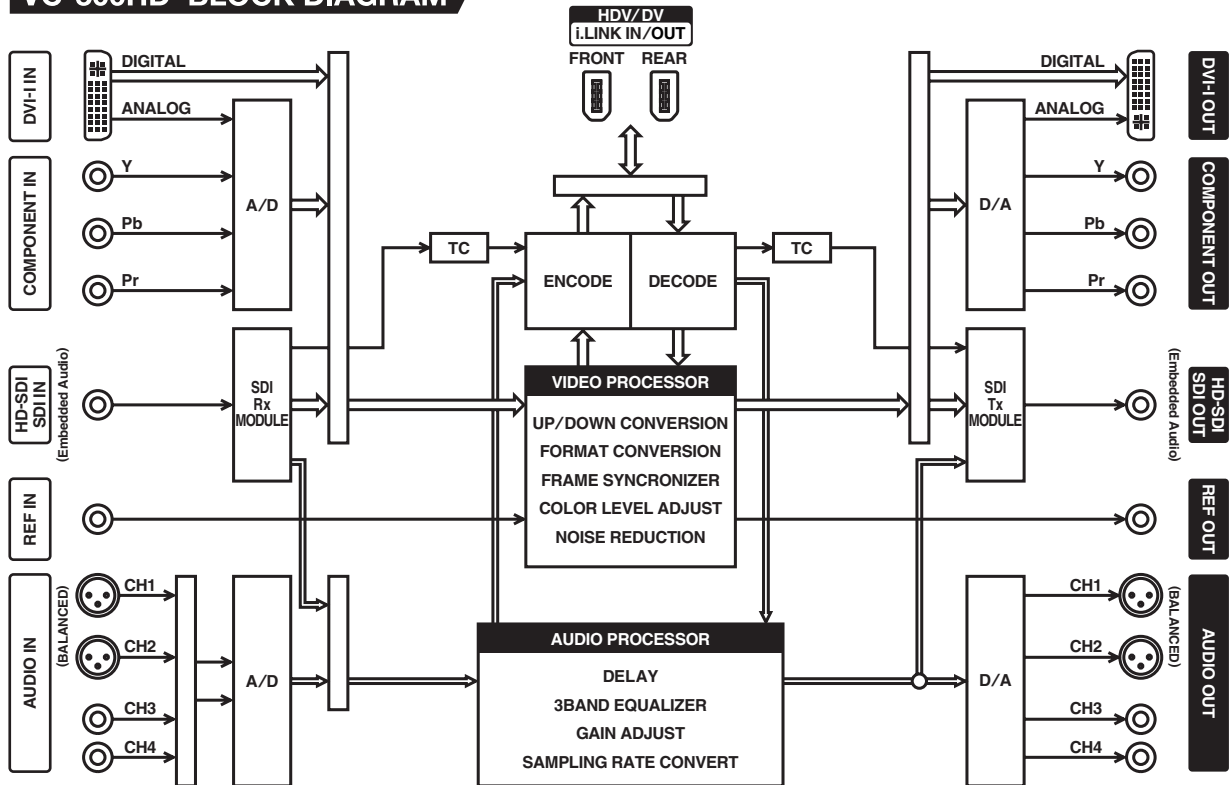

## VC-200HD BLOCK DIAGRAM

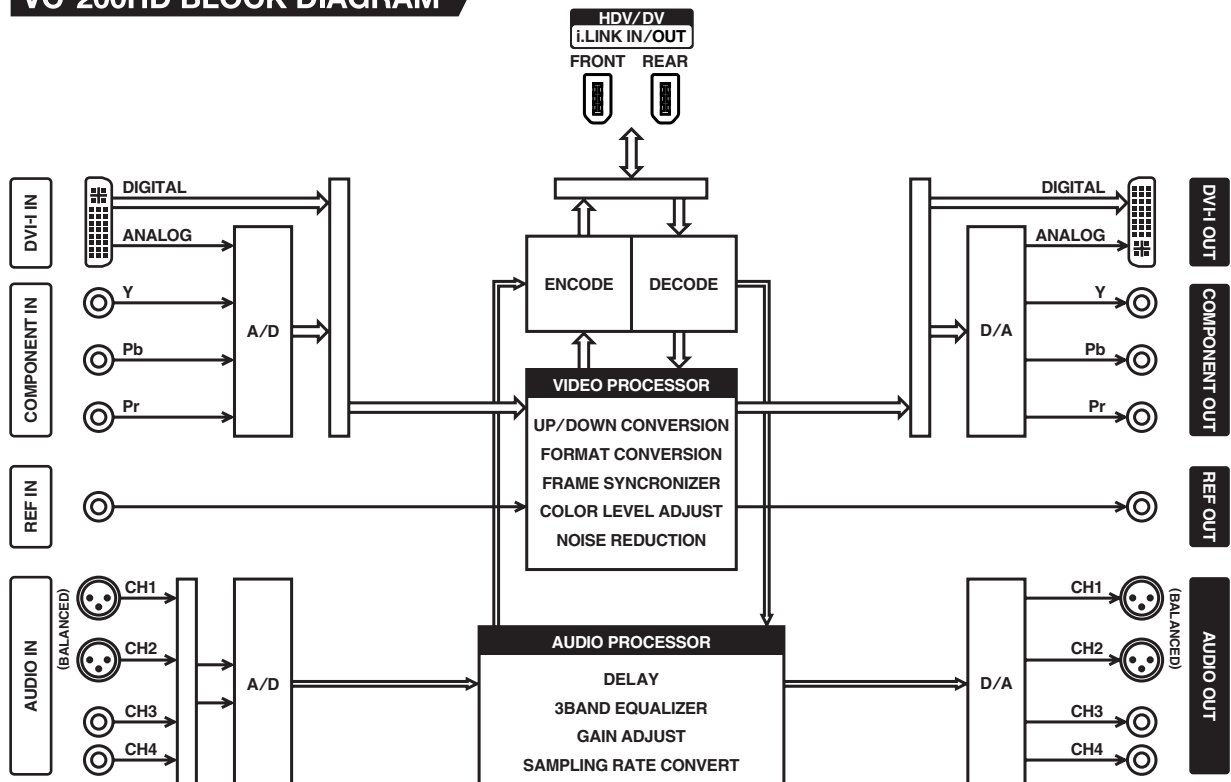

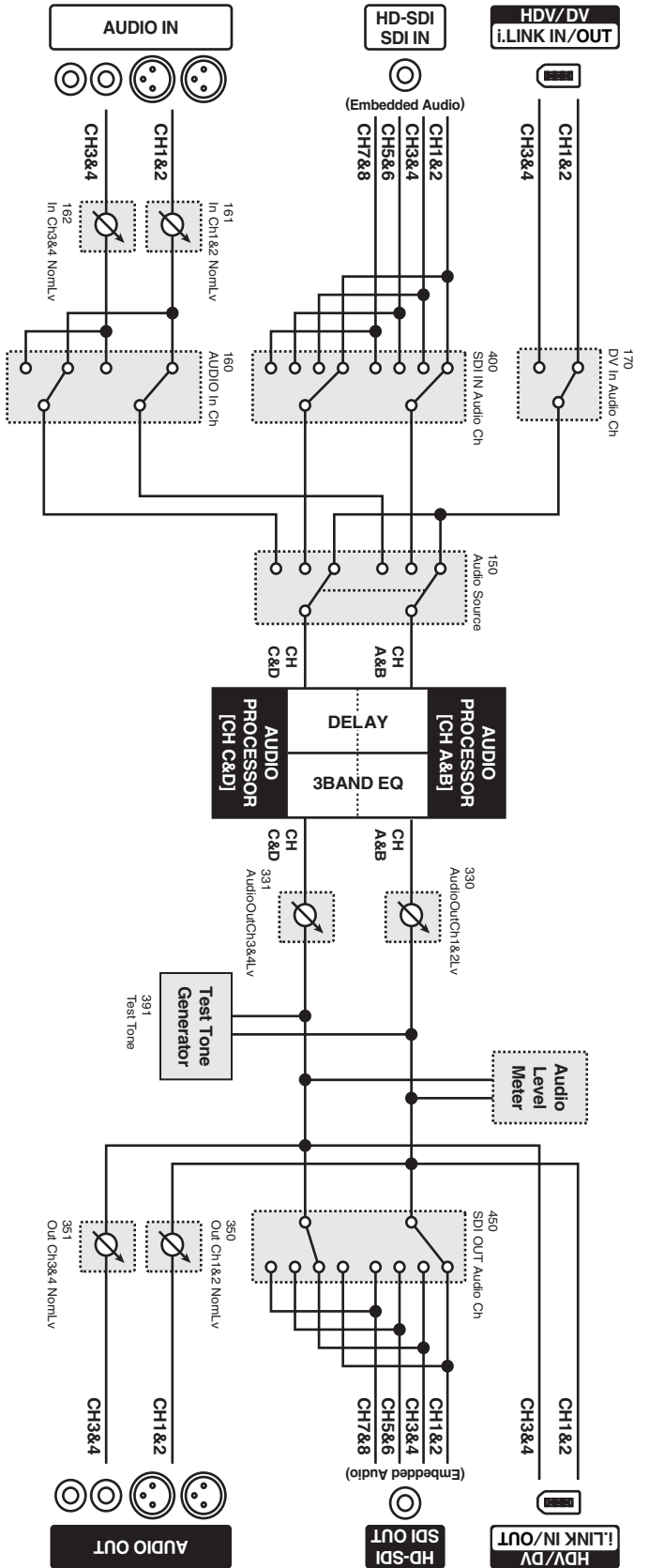

# VC-300HD Block Diagram

## VC-300HD AUDIO BLOCK DIAGRAM

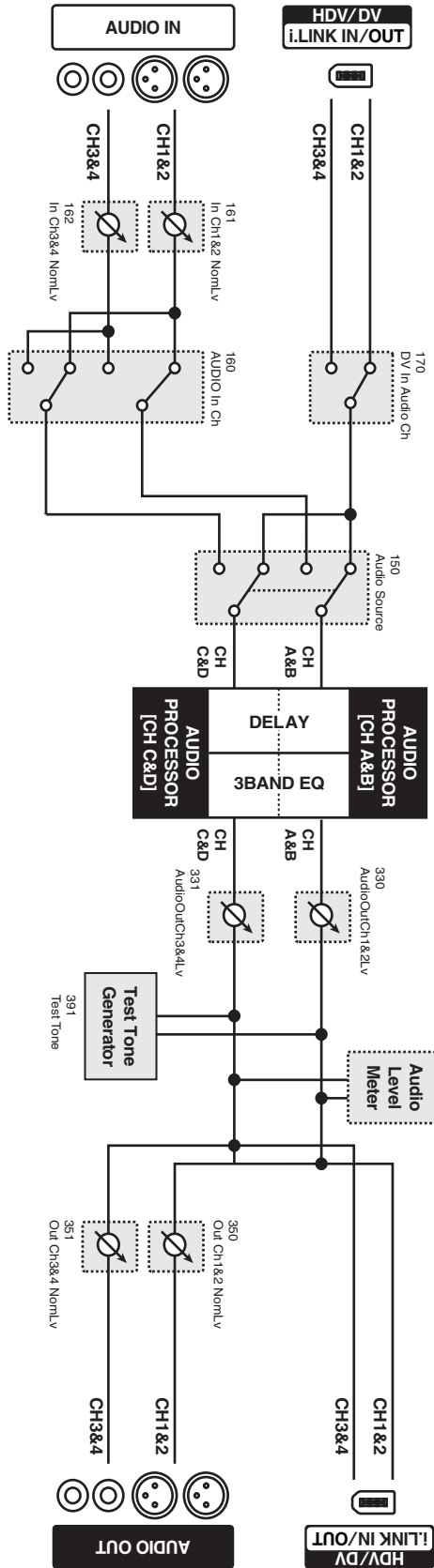

## VC-200HD AUDIO BLOCK DIAGRAM



-For items enclosed by , the settings can be changed via a menu (p.30).  
 -The number and name shown for items enclosed by  are the menu number and menu name.

## Output Format Support Chart

The following lists the video formats that can be output with the output connectors mounted on this device.

Format/Output Connector	i.LINK Connector	COMPONENT OUT Connector	DVI-I OUT Connector (digital)	DVI-I OUT Connector (analog)	HD-SDI OUT Connector
1080/59.94p	—	○	○	—	—
1080/50p	—	○	○	—	—
1080/59.94i	○	○	○	○	○
1080/50i	○	○	○	○	○
720/59.94p	○	○	○	○	○
720/29.97p	○	—	—	—	—
720/50p	○	○	○	○	○
720/25p	○	—	—	—	—
480/59.94p	○	○	○	○	—
576/50p	○	○	○	○	—
480/59.94i (NTSC)	○	○	○	○	○
576/50i (PAL)	○	○	○	○	○

○ indicates that the combination can be output.

# Index

## Numerics

- 32 kHz ..... 27, 33
- 48 kHz ..... 33

## A

- AC Inlet ..... 12
- Audio Delay ..... 28–29
- AUDIO INPUT Connector ..... 12
- Audio Level ..... 29
- AUDIO OUTPUT Connector ..... 12

## B

- balanced (XLR) type jack ..... 12
- BNC cable ..... 17

## C

- COMPONENT INPUT Connector ..... 12
- COMPONENT OUTPUT Connectors ..... 12
- Cooling fan exhaust vent ..... 11
- Cooling fan intake vent ..... 11
- Crop ..... 33

## D

- Delay ..... 7
- Display ..... 11, 29
- drop frame ..... 29
- DV ..... 38
- DVI ..... 38
- DVI-A ..... 32, 38
- DVI-D ..... 32, 38
- DVI-I ..... 38
- DVI-I INPUT Connector ..... 12
- DVI-I OUT Connector ..... 12

## E

- Enhancement ..... 34
- EVEN ..... 38
- EXIT Button ..... 11

## F

- Fan ..... 39
- fields ..... 38
- frame ..... 38
- frequency ..... 32
- Front Panel ..... 10

## H

- HDMI ..... 38
- HD-SDI IN Connector ..... 12
- HD-SDI OUT Connector ..... 12
- HDV ..... 38

## I

- i.LINK Connector ..... 10
- INPUT button ..... 10, 26–27
- input/output format ..... 29
- Interlaced ..... 38
- INTERNAL ..... 10

## L

- Letter Box ..... 33
- Light Dimmer ..... 37

## M

- MENU Button ..... 11

- Menu screen ..... 29–30
- mount fitting ..... 39

## N

- Noise Reduction ..... 34
- nominal level ..... 27, 33
- non-drop frame ..... 29
- NTSC ..... 38

## O

- ODD ..... 38
- OUTPUT button ..... 27–28
- output format ..... 27

## P

- PAGE Button ..... 11
- PAGE button ..... 28–29
- PAL ..... 38
- PANEL LOCK button ..... 11, 29
- Power Button ..... 11
- Power cord ..... 8
- power cord ..... 12
- POWER switch ..... 26
- PROCESSING Button ..... 10
- PROCESSING button ..... 28
- Progressive ..... 38

## R

- Rear Panel ..... 12
- REF INPUT ..... 10
- REF INPUT Connector ..... 13
- REF OUTPUT Connector ..... 13
- RGB ..... 38
- Rubber Feet ..... 8, 25

## S

- sampling phase ..... 32
- scaling ..... 33
- screw ..... 39
- SDI ..... 38
- setup level ..... 32
- Side Panel ..... 11, 33
- Squeeze ..... 33
- Status Screen ..... 29
- SYNC REFERENCE Indicators ..... 10

## T

- TERMINATOR Switch ..... 13
- Test Pattern ..... 28
- Test Tone ..... 28
- Timecode ..... 29

## U

- User Bit ..... 29

## V

- VALUE/ENTER knob ..... 11, 26–28
- VIDEO INPUT ..... 10
- video input format ..... 29
- video output format ..... 29



This product complies with the requirements of European Directives EMC 89/336/EEC and LVD 73/23/EEC.

For EU Countries

For the USA

## FEDERAL COMMUNICATIONS COMMISSION RADIO FREQUENCY INTERFERENCE STATEMENT

This equipment has been tested and found to comply with the limits for a Class B digital device, pursuant to Part 15 of the FCC Rules. These limits are designed to provide reasonable protection against harmful interference in a residential installation. This equipment generates, uses, and can radiate radio frequency energy and, if not installed and used in accordance with the instructions, may cause harmful interference to radio communications. However, there is no guarantee that interference will not occur in a particular installation. If this equipment does cause harmful interference to radio or television reception, which can be determined by turning the equipment off and on, the user is encouraged to try to correct the interference by one or more of the following measures:

- Reorient or relocate the receiving antenna.
- Increase the separation between the equipment and receiver.
- Connect the equipment into an outlet on a circuit different from that to which the receiver is connected.
- Consult the dealer or an experienced radio/TV technician for help.

This device complies with Part 15 of the FCC Rules. Operation is subject to the following two conditions:

- (1) This device may not cause harmful interference, and
- (2) This device must accept any interference received, including interference that may cause undesired operation.

Unauthorized changes or modification to this system can void the users authority to operate this equipment.  
This equipment requires shielded interface cables in order to meet FCC class B Limit.

For Canada

### NOTICE

This Class B digital apparatus meets all requirements of the Canadian Interference-Causing Equipment Regulations.

### AVIS

Cet appareil numérique de la classe B respecte toutes les exigences du Règlement sur le matériel brouilleur du Canada.

For EU Countries



**UK** This symbol indicates that in EU countries, this product must be collected separately from household waste, as defined in each region. Products bearing this symbol must not be discarded together with household waste.

**DE** Dieses Symbol bedeutet, dass dieses Produkt in EU-Ländern getrennt vom Hausmüll gesammelt werden muss gemäß den regionalen Bestimmungen. Mit diesem Symbol gekennzeichnete Produkte dürfen nicht zusammen mit dem Hausmüll entsorgt werden.

**FR** Ce symbole indique que dans les pays de l'Union européenne, ce produit doit être collecté séparément des ordures ménagères selon les directives en vigueur dans chacun de ces pays. Les produits portant ce symbole ne doivent pas être mis au rebut avec les ordures ménagères.

**IT** Questo simbolo indica che nei paesi della Comunità europea questo prodotto deve essere smaltito separatamente dai normali rifiuti domestici, secondo la legislazione in vigore in ciascun paese. I prodotti che riportano questo simbolo non devono essere smaltiti insieme ai rifiuti domestici. Ai sensi dell'art. 13 del D.Lgs. 25 luglio 2005 n. 151.

**ES** Este símbolo indica que en los países de la Unión Europea este producto debe recogerse aparte de los residuos domésticos, tal como está regulado en cada zona. Los productos con este símbolo no se deben depositar con los residuos domésticos.

**PT** Este símbolo indica que nos países da UE, a recolha deste produto deverá ser feita separadamente do lixo doméstico, de acordo com os regulamentos de cada região. Os produtos que apresentem este símbolo não deverão ser eliminados juntamente com o lixo doméstico.

**NL** Dit symbool geeft aan dat in landen van de EU dit product gescheiden van huishoudelijk afval moet worden aangeboden, zoals bepaald per gemeente of regio. Producten die van dit symbool zijn voorzien, mogen niet samen met huishoudelijk afval worden verwijderd.

**DK** Dette symbol angiver, at i EU-lande skal dette produkt opsamles adskilt fra husholdningsaffald, som defineret i hver enkelt region. Produkter med dette symbol må ikke smides ud sammen med husholdningsaffald.

**NO** Dette symbolet indikerer at produktet må behandles som spesialavfall i EU-land, iht. til retningslinjer for den enkelte regionen, og ikke kastes sammen med vanlig husholdningsavfall. Produkter som er merket med dette symbolet, må ikke kastes sammen med vanlig husholdningsavfall.

**SE** Symbolen anger att i EU-länder måste den här produkten kasseras separat från hushållsavfall, i enlighet med varje regions bestämmelser. Produkter med den här symbolen får inte kasseras tillsammans med hushållsavfall.

**FI** Tämä merkintä ilmaisee, että tuote on EU-maissa kerättävä erillään kotitalousjätteistä kunkin alueen voimassa olevien määräysten mukaisesti. Tällä merkinnällä varustettuja tuotteita ei saa hävittää kotitalousjätteiden mukana.

**HU** Ez a szimbólum azt jelenti, hogy az Európai Unióban ezt a terméket a háztartási hulladéktól elkülönítve, az adott régióban érvényes szabályozás szerint kell gyűjteni. Az ezzel a szimbóllal ellátott termékeket nem szabad a háztartási hulladék közé dobni.

**PL** Symbol oznacza, że zgodnie z regulacjami w odpowiednim regionie, w krajach UE produktu nie należy wyrzucać z odpadami domowymi. Produktów opatrzonych tym symbolem nie można utylizować razem z odpadami domowymi.

**CZ** Tento symbol udává, že v zemích EU musí být tento výrobek sbírán odděleně od domácího odpadu, jak je určeno pro každý region. Výrobky nesoucí tento symbol se nesmí vyhazovat spolu s domácím odpadem.

**SK** Tento symbol vyjadruje, že v krajinách EÚ sa musí zber tohto produktu vykonávať oddelene od domového odpadu, podľa nariadení platných v konkrétnej krajine. Produkty s týmto symbolom sa nesmú vyhazovať spolu s domovým odpadom.

**EE** See sümbol näitab, et EL-i maades tuleb see toode olemprügist eraldi koguda, nii nagu on iga piirkonnas määratletud. Selle sümboliga märgitud tooteid ei tohi ära visata koos olmeprügiga.

**LT** Šis simbolis rodo, kad ES šalyse šis produktas turi būti surenkamas atskirai nuo buitinių atliekų, kaip nustatyta kiekviename regione. Šiuo simboliu paženklinėti produktai neturi būti išmetami kartu su buitinių atliekomiš.

**LV** Šis simbols norāda, ka ES valstīs šo produktu jāievāc atsevišķi no mājsaimniecības atkritumiem, kā noteikts katrā reģionā. Produkts ar šo simbolu nedrīkst izmest kopā ar mājsaimniecības atkritumiem.

**SI** Ta simbol označuje, da je treba proizvod v državah EU zbirati ločeno od gospodinjjskih odpadkov, tako kot je določeno v vsaki regiji. Proizvoda s tem znakom ni dovoljeno odlagati skupaj z gospodinjjskimi odpadki.

**GR** Бхфр фп уэмвллл дзллоней вфй уфйт чюсет фэт EE, фп рсгьн бхфр рсЭрей нб ухллЭгефбй оечсйуфь брь фб пйкйбкь брпсЯммбфб, умзчнбнб фз нпмпсеуЯб фэт кьне респнчЮт. Фб рсгьнфб рпх цЭлпх бхфр фп уэмвллл ден рсЭрей нб брпсЯрфпфпфбй мбжЯ нб фб пйкйбкь брпсЯммбфб.



\* 0 4 5 6 4 3 5 6 - 0 1 \*

04564356

07-3-1N