

24-bit DIGITAL STUDIO WORKSTATION

VS-1680



Owner's Manual

Thank you, and congratulations on your choice of the Roland **VS-1680 V-XPANDED** Digital Studio Workstation.

As the owner of the VS-1680 V-XPANDED, you can begin using all functions immediately. Please read the V-XPANDED Owner's Manual (this document) together with the VS-1680 Owner's Manual (three volumes).

If you purchased the V-XPANDED system Zip disk, refer to this manual and upgrade the system software of VS-1680 (to add the V-XPANDED functions). Then, read the V-XPANDED Owner's Manual (this document) together with the VS-1680 Owner's Manual (three volumes).

All product names mentioned in this document are trademarks or registered trademarks of their respective owners.

Copyright © 1999 ROLAND CORPORATION

All rights reserved. No part of this publication may be reproduced in any form without the written permission of ROLAND CORPORATION.

Roland international website: www.rolandcorp.com

Roland U.S. website: www.rolandus.com

Table of Contents

Table of Contents3

Precautions	4
Added functionality (main features)	5
Mixdown using the VS-1680 alone.....	5
Additional effect algorithms	5
Automix editing functionality	5
Enhanced support for CD-R/CD-RW drives	5
Enhanced operations	5
Enhanced screen display	5

Expanding the functionality of the VS-16806

If you purchased the VS-1680 V-XPANDED.....	6
If you purchased the V-XPANDED system program Zip disk	6

Mix 16 tracks down to 2 tracks (Mastering Room).....8

Added mastering tracks	8
Mixing down to the mastering tracks.....	8
Mixdown shortcut 1	10
Mixdown shortcut 2	10
Playing back the mastering tracks	10
Mixing down while inserting effects	11

New effects algorithms14

Making the volume consistent for each frequency band (Mastering Tool Kit).....	14
EQ (Equalizer)	14
BCut (Bass-cut filter).....	15
Enh (Enhancer).....	15
In (Input)	15
Exp (Expander).....	15
Cmp (Compressor)	16
Mix (Mixer)	16
Lmt (Limiter)	16
Out (Output).....	16
Modeling various speakers (Speaker Modeling) ..	17
SpMod (speaker modeling)	17
BCut (Bass-cut filter).....	17
LFT/HFT (Frequency trimmer).....	17
Lmt (Limiter)	18
Effective ways to use speaker modeling	18

Editing an automix19

Erasing data from a specific area (Erase)	19
Copying data to another location (Copy)	20
Smooth data transitions (Gradation)	21
Increasing or decreasing all data values (Shift/ Expand).....	23

Using the VS-1680 with a CD-R/CD-RW drive.....25

Creating an audio CD	25
Creating silence between songs (Disc At Once and Track At Once).....	25
Specifying the writing speed (Speed)	25
Song writing procedure	25
Saving a song to a CD-RW disc (Backup)	27
Checking whether the song was saved correctly (+Verify)	27
Specifying the speed of saving (Speed)	27
Backup procedure	27
Restoring songs from a CD-RW disc (Recover)	28
Specifying the speed of recovery (Speed).....	28
Recovery procedure.....	28

Enhancements related to operation . 30

Shortcut to the Phrase Edit window	30
Creating a new phrase (Phrase New)	30
Sorting the take list (Sort)	30
Deleting a take (Delete).....	31
Naming a take (Name)	32
Dividing a phrase (Phrase Divide/Split).....	33
Automatically dividing a phrase (Phrase Divide) 33	
Dividing a phrase into two parts (Phrase Split) .. 34	
Using the MONITOR knob to adjust the pan (MONITOR knob +[SELECT])	35
Linking the faders of two or more channels (Fader Group).....	36
Copying mixer settings	37
Shift Lock on/off ([SHIFT]+[YES])	38
Removing direct current offset from the mix bus ..	38

Enhancements to the display and specifications39

Checking inserted effects (Icon and Patch Name display).....	39
Checking effects that cannot be used in other channels (Effect insertion location display)	39
Switching the Song Select window (List display) ..	40
Easy Routing	40
Additional template (Mastering)	40
Immediate application of step-edited changes ..	41
Settings not stored in a scene (Monitor Level)	41
Master Send switch display has been changed (Pan/EMIX)	41

Index42

Precautions

- Unfortunately, it may be impossible to restore the data stored on a Zip disk or other form of media once it has been erased, initialized, or otherwise lost. Roland Corporation assumes no liability concerning such loss of data.

- Zip disks contain a plastic disk with a thin coating of magnetic storage medium. Microscopic precision is required to store large amounts of data on such a small surface area. To preserve their integrity, please observe the following when handling Zip disks:
 - Never touch the magnetic medium inside the disk.
 - Do not use or store ZIP disks in dirty or dusty areas.
 - Do not subject ZIP disks to temperature extremes (e.g., direct sunlight in an enclosed vehicle). Recommended temperature range: -22 to 51 °C (-7.6 to 123.8 °F).
 - Do not expose Zip disks to strong magnetic fields, such as those generated by loudspeakers.

- The identification label should be firmly affixed to the disk. Should the label come loose while the disk is in the drive, it may be difficult to remove the disk.

- Store all disks in a safe place to avoid damaging them, and to protect them from dust, dirt, and other hazards. By using a dirty or dust-ridden disk, you risk damaging the disk, as well as causing the disk drive to malfunction.

In the interest of product improvement, the specifications and/or contents of this package are subject to change without prior notice.

Added functionality (main features)

Mixdown using the VS-1680 alone

While playing back sixteen tracks, you can mixdown to any two tracks of the 256 V-tracks (Mastering Room). This is convenient when you wish to prepare tracks for mastering, such as when you are producing an original audio CD (p. 8).

Additional effect algorithms

- A compressor (an effect that makes the volume more consistent) can be applied independently to individual frequency bands (Mastering Tool Kit) (p. 14).
- A Speaker Modeling effect has been added, allowing you to apply the acoustical characteristics of a variety of speakers (p. 17).

Automix editing functionality

Automix data (such as the level or pan of each channel, and effect patch numbers) can be edited in a specified area by deleting, copying, or increasing/decreasing the data values (p. 19).

Enhanced support for CD-R/CD-RW drives

- When producing an original audio CD, you can specify the speed of writing (p. 25).
- When performing a CD-R Backup, you can check whether the data was saved correctly (+Verify: p. 27).
- When performing a CD-R Backup, you can specify the speed of the backup (p. 25).
- When performing a CD-R Recover, you can specify the speed of the recover (p. 28).

Enhanced operations

- In Play condition you can select a phrase for editing, and directly display the Phrase Edit window (p. 30)
- In the Phrase New window, you can sort the Take List (Sort: p. 30).
- In the Phrase New window, you can delete a take from the Take List (Delete: p. 31).
- In the Phrase New window, you can change the name of a take in the Take List (Name: p. 32)
- Phrases can be divided automatically (Phrase Divide: p. 33).
- The MONITOR knob can be used to adjust the pan of each channel (MONITOR knob + [SELECT]: p. 35).

- The faders of two or more channels can be adjusted as a group (Fader Group: p. 36).
- Level and EQ settings of a channel can be copied (p. 37).
- In Play condition, Shift Lock can be turned on/off directly ([SHIFT]+[YES]: p. 38).
- Direct current offset can be removed from the mix bus (p. 38).

Enhanced screen display

- Inserted effects can be viewed as icons and patch names (p. 39).
- Insertion positions of effects that have been inserted in other channels are displayed (p. 39).
- A list display is provided in the Song Select window (p. 40).
- A template (mastering) has been added to Easy Routing (p. 40).
- The results of step editing in Easy Routing are applied immediately (p. 41).
- The monitor level is no longer stored in a scene (p. 41).
- The Master Send switch display has been changed (p. 41).

Expanding the functionality of the VS-1680

There are several ways in which the new functions can be added to the VS-1680. Please read the section that applies to your VS-1680.

NOTE

After you have upgraded the VS-1680, you can continue using the hard disk that you are currently using without any changes. It is not necessary to initialize the hard disk. However, as a precaution against unforeseen accidents, we recommend that you back up your song data before performing the upgrade.

If you purchased the VS-1680 V-XPANDED

If you purchased the VS-1680 V-XPANDED, you need not perform any procedure. Skip this section and begin reading Chapter 2 (p.8).

If you purchased the V-XPANDED system program Zip disk

You can use the V-XPANDED system program Zip disk to add the V-XPANDED functionality to your VS-1680. Prepare the following items.

- VS-1680
- SCSI Zip drive
- VS-1680 V-XPANDED system program Zip disk

NOTE

The V-XPANDED system program Zip disk contains a program which installs the software update. Be careful not to initialize it on the VS-1680.

1. Make sure that the power is turned off on all devices.

NOTE

To prevent malfunction and/or damage to speakers or other devices, always turn down the volume, and turn off the power on all devices before making any connections.

2. Disconnect all cables that were connected to the VS-1680.
3. Connect the SCSI Zip drive to the VS-1680. On the back of the Zip drive, make sure the termination switch is set to 'on'.

NOTE

Have only the SCSI Zip drive connected. Do not connect any other

disk drives.

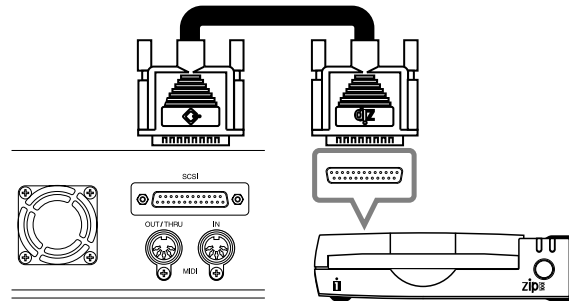

4. Turn on the power of the SCSI zip drive.
5. Insert the VS-1680 V-XPANDED system program Zip disk into the SCSI Zip drive.
6. Connect the power cable to the VS-1680.
7. Turn on the rear panel power switch of the VS-1680.

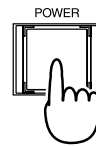

8. Wait for the display to prompt "Update System Program?" and then press [YES].

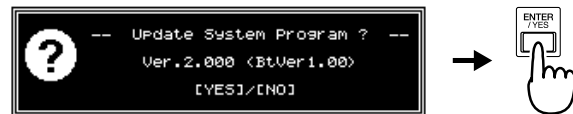

MEMO

If this display does not appear, the VS-1680 was not able to recognize the Zip disk. Turn off the power, re-insert the disk correctly, and turn the power on once again.

9. A message will ask whether you wish to keep the user settings that are stored in your VS-1680. Press [YES] and proceed to step 11. If you wish to initialize (erase) the user settings, press [NO], and proceed to step 10.

The user settings that can be left in the VS-1680 are as follows.

- Easy routing (VS-1680 Owner's Manual, p. 41)
- Effect user patches (VS-1680 Owner's Manual, p. 110)
- Alarm function message (VS-1680 Owner's Manual, p. 193)



- 10.** If you pressed [NO] in step 9, an additional message will ask you to confirm. If you wish to erase (initialize) the user settings, press [YES]. If you press [NO] you will return to step 9.

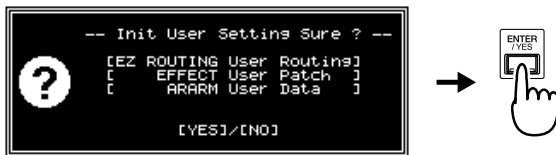

- 11.** The expansion procedure will begin. Please wait for approximately 30 seconds.

NOTE

You must never under any circumstances turn off the power until the function expansion procedure has been completed. Doing so could damage the VS-1680 system.

Now Working...0A

- 12.** Once the following message appears, you may turn off the power. Verify that this message has appeared, and then turn off the rear panel power switch.

Please Reboot OK

- 13.** Turn on the power once again. Verify on the display that the system software is now 2.00 or higher.



MEMO

Subsequently, when starting up the VS-1680, you will not need the V-XPANDED system program Zip disk. Keep this Zip disk in a safe location that is not excessively warm. **The V-XPANDED system program Zip disk cannot be used on any device other than the VS-1680.**

Mix 16 tracks down to 2 tracks (Mastering Room)

From the 256 V-tracks you can now select any two tracks, and mixdown to these two tracks as you play back 16 tracks simultaneously.

Added mastering tracks

Until now, you had to use an external DAT recorder or MD recorder if you wanted to mixdown a song that used all sixteen tracks. For example if you wanted to produce an original audio CD, you needed to first mixdown to an external recorder (DAT or MD), and then re-record that song onto the VS-1680.

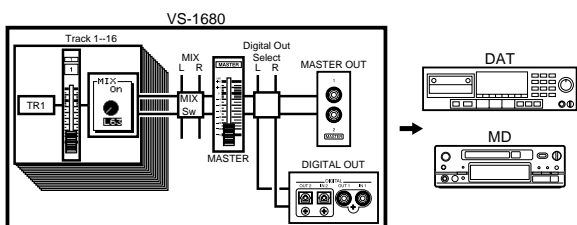

Now, "Mastering tracks" equivalent to this external recorder (DAT or MD) are provided on the VS-1680 itself.

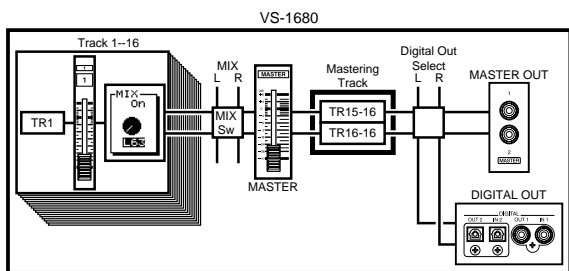

Any two of the 256 V-tracks can be assigned for use as the mastering tracks. With the factory settings, V-track 16 of tracks 15/16 (i.e., 15-16 and 16-16) are assigned as the mastering tracks.

For example, you can play back V-tracks 1-1, 2-1, 3-1...15-1, and 16-1 (a total of 16 tracks), and record the result on V-tracks 15-16 and 16-16 (a total of two tracks).

MEMO

When the Recording mode (VS-1680 Owner's Manual, p. 58) is set to "MAS (mastering)," you can play back V-tracks 1-1, 2-1, 3-1...7-1, and 8-1 (a total of 8 tracks), and record on V-tracks 7-16 and 8-16 (a total of two tracks). **Tracks 9-16 cannot be used.**

Mixing down to the mastering tracks

Here's how to select the mastering tracks, and perform a mixdown.

NOTE

The operation of playing back 16 tracks while you mixdown to the mastering tracks (two tracks) is significantly affected by the speed of the hard disk. For this reason, depending on the structure of the song data (sampling rate and recording mode, or when punch-in/out is used frequently, etc.), or depending on the drive that you use, the display may indicate "Drive Busy," and the operation may not take place correctly. **In order to take full advantage of the VS-1680's potential, such as the number of tracks that can be recorded/played simultaneously, and the recording capacity, we recommend that you use a hard disk which capacity is 2.1 GB or more.**

1. Press [MASTER].
2. Press [PAGE] so that [F6] indicates "M.Tr," and then press [F6 (M.Tr)].

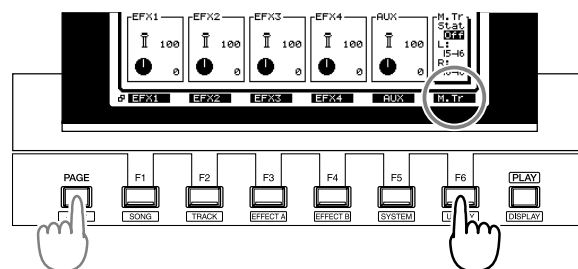

3. Press [ENTER (YES)].
4. Press [▲], [▼], [◀], or [▶] to move the cursor. Use the TIME/VALUE dial to specify the value for each parameter.

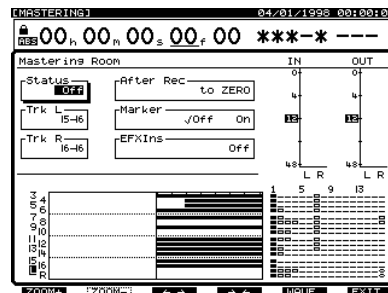

Status

Specify the status of the mastering tracks. For this example, select “Off.”

- Off:** The mastering tracks will not be used.
- Rec:** Play back tracks 1–16 while recording them to the mastering tracks.
- Play:** Play back the mastering tracks. The sound of tracks 1–16 will not be output from the MASTER jacks.



For details on the signal flow (routing) at this time, refer to **Signal flow (routing)** (p. 10).

- Trk L (track L)**
- Trk R (track R)**

Select the two V-tracks (L and R) that will be assigned as mastering tracks. When a new song is created, V-track 16 of tracks 15/16 (15-16, 16-16) will be assigned as the mastering tracks.

After Rec (after recording)

Specify the time location of the mastering track to which the mixdown will be recorded. When creating an original audio CD, it is usually best to select “to ZERO.”

- to ZERO:** Place the data starting at 00h00m00s00f
- to last Phrs:0S:** Place the data after the end of the last phrase in the mastering tracks.
- to last Phrs:2S:** Place the data two seconds after the end of the last phrase in the mastering tracks.
- to last Phrs:4S:** Place the data four seconds after the end of the last phrase in the mastering tracks.
- Stay HERE:** Place the data at the time location at which it was actually recorded.

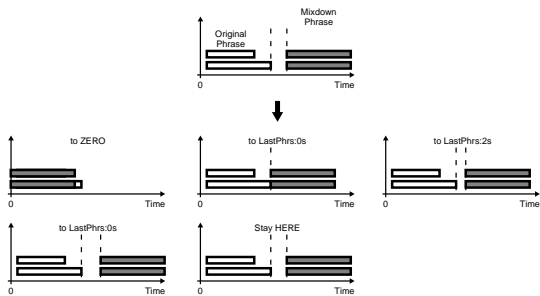

Marker

If this is turned “On,” a track number marker will automatically be assigned to the beginning of the phrase that is mixed down. Normally you will set this “On.”



Depending on the After Rec (After Recording) setting or on the location relative to other markers, the display may indicate “Can’t Set Marker,” and the track number marker may not be assigned.

- 5.** Hold down [STOP], and press the [STATUS] button for all tracks (1–15/16) that you wish to mixdown. The STATUS indicators will light green.

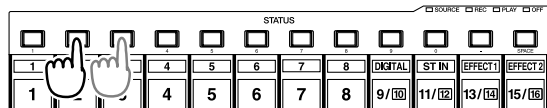

- 6.** Press [FADER] so that the TR (track) indicator lights.

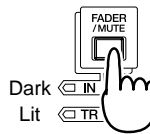

- 7.** Press [PLAY]. The song will play back.
- 8.** Raise and lower the master fader, and verify that the volume of each track changes.



The sound that passes through the master fader will be recorded on the mastering tracks. **In order to record at the optimal audio quality, you should normally set this to the 0 dB position.**

- 9.** Use the channel faders (1–15/16) to adjust the volume balance of each track. At this time the sound that is being output from the MASTER jacks (volume levels, panning) will be recorded to the mastering tracks. It is best to set the volume as high as possible without causing the volume to distort.
- 10.** When you have finished adjusting the volume, press [STOP].
- 11.** Move to the location at which you wish to begin the mixdown (such as 00h00m00s00f).

12. Use the cursor buttons and the Value dial to change the "Status" of the tracks for mastering to "Rec."
13. Press [REC]. The REC indicator will light in red.
14. Press [PLAY]. The PLAY indicator will light in green, and recording will begin.
15. When you finish recording, press [STOP].

Signal flow (routing)

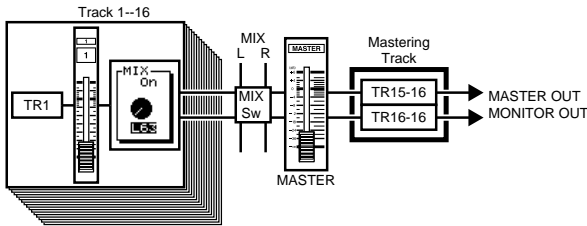

Mixdown shortcut 1

The "Status" of the assigned mastering tracks/V-tracks can also be set as follows.

1. Press [MASTER].
2. Press [PAGE] so that [F6] indicates "M.Tr," and then press [F6 (M.Tr)].

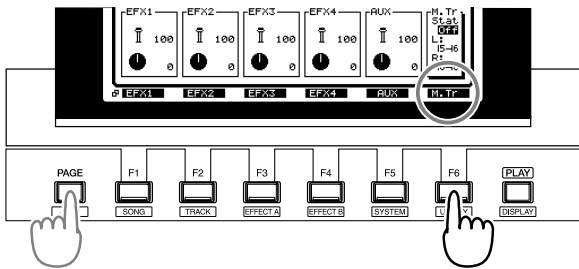

3. Select the status of the mastering tracks. Make sure that the cursor is located at "Stat," and then rotate the TIME/VALUE dial.

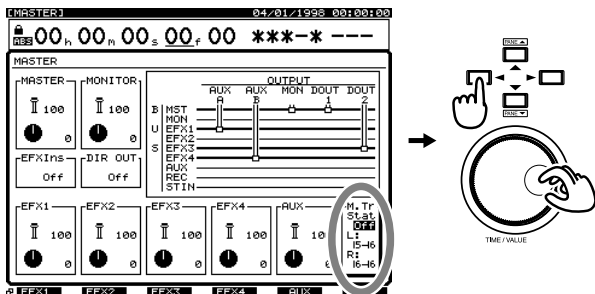

4. Select the V-tracks. Use [▲] or [▼] to move the cursor to "L;" or "R;," and rotate the TIME/VALUE dial.

Mixdown shortcut 2

The "Status" of the mastering tracks can also be set as follows.

1. Press [PLAY (DISPLAY)].
2. Press [PAGE] so that [F6] indicates "M→***" (***) is either Rec, Ply, or Off).

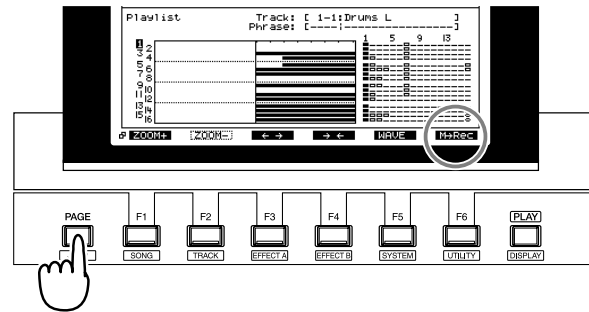

3. Press [F6] to cycle between "M→Rec" → "M→Play" → "M→Off." The current status of the mastering tracks will be shown by the level meters in the display.

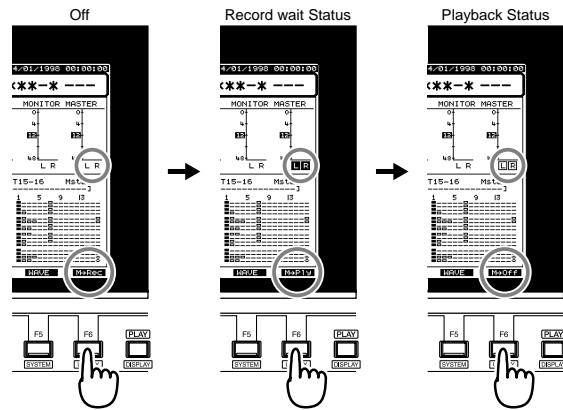

Playing back the mastering tracks

Here's how you can verify the audio that was mixed down to the mastering tracks. **Tracks 1-16 will not be played back.**

1. Press [PLAY (DISPLAY)].
2. Press [PAGE] so that [F6] indicates "M→***" (***) is either Rec, Ply, or Off).

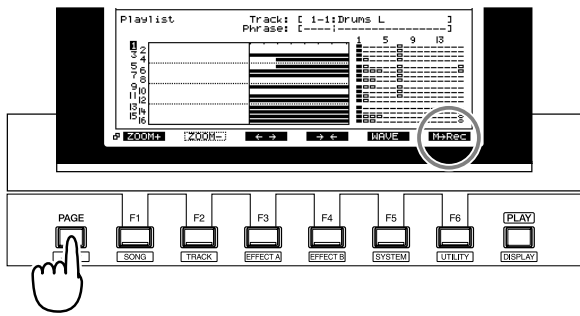

- Press [F6] to cycle between “M→Rec” → “M→Play” → “M→Off.” The current status of the mastering tracks can be viewed in the level meter in the display. For this example, select “M→Off” (playback status: pressing [F6] once again will select Off).

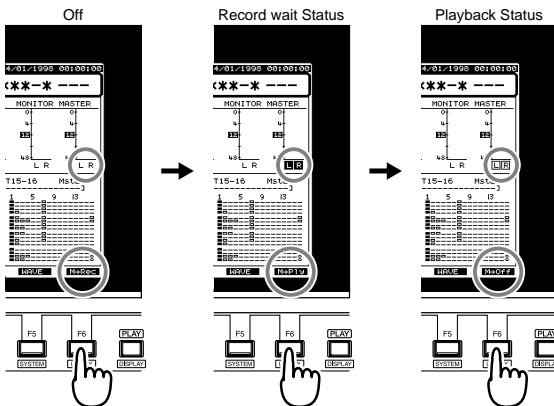

MEMO

For details on the signal flow at this time, refer to **Signal flow (routing)** (p. 11).

- Move to the location at which you started the mixdown.
- Press [▼] so that you can view the playlist of the mastering tracks.

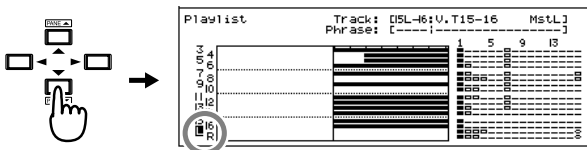

MEMO

If the bottom line of the display is surrounded by a heavy line, you can also use the TIME/VALUE dial to check the playlist of the mastering tracks.

- Press [PLAY]. The mastering tracks will play back. Use the master fader to adjust the volume to a comfortable listening level.

At this time, the function buttons will function as follows (Owner’s Manual, p. 182).

- [F1 (ZOOM+)]:** Enlarges the playlist display in the track direction (three levels).
- [F2 (ZOOM-)]:** Reduces the playlist display in the track direction (three levels).
- [F3 (←→)]:** Enlarges the playlist display in the time direction (five levels).
- [F4 (→←)]:** Reduces the playlist display in the time direction (five levels).
- [F5 (WAVE)]:** Display the sound level (waveform) that is recorded in the tracks.

- When playback ends, press [STOP].

Signal flow (routing)

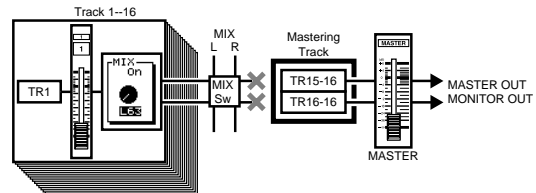

Mixing down while inserting effects

If a separately sold VS8F-2 effect expansion board is installed, you can insert effects while you mixdown.

MEMO

While performing a mixdown, it is common to insert an effect such as a parametric equalizer or a compressor. For this example, we will insert the Mastering Tool Kit (EFX1: a newly added algorithm; p. 14) to adjust the overall volume balance as we mixdown.

- Press [MASTER].
- Press [PAGE] so that [F6] indicates “M.Tr,” and then press [F6 (M.Tr)].

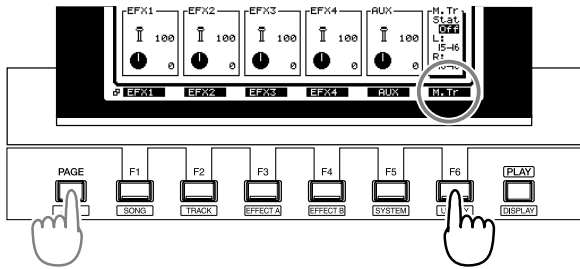

3. Press [ENTER (YES)].
4. Use [▲], [▼], [◀], and [▶] to move the cursor to "Status."

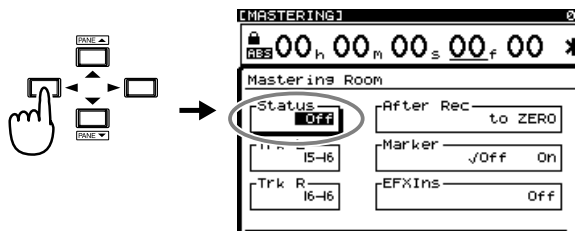

5. Select the "Status" of the mastering tracks. Rotate the TIME/VALUE dial.

Status

Specify the status of the master tracks. For this example select "Off."

- Off:** The mastering tracks will not be used.
- Rec:** Play back tracks 1-16 and record on the mastering tracks.
- Play:** Play back the mastering tracks. The sound of tracks 1-16 will not be output from the MASTER jacks.

MEMO

For details on the signal flow (routing) at this time, refer to **Signal flow (routing)** (p. 13).

6. Use [▲], [▼], [◀], and [▶] to move the cursor to "EFXIns."

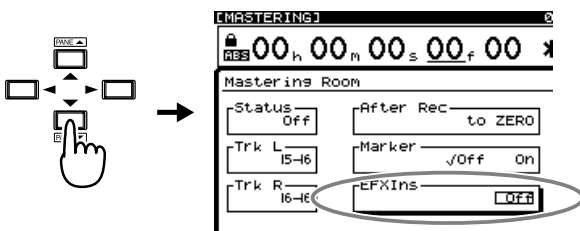

7. Press [ENTER (YES)].

8. Use [▲], [▼], [◀], and [▶] to move the cursor. Use the TIME/VALUE dial to make settings.

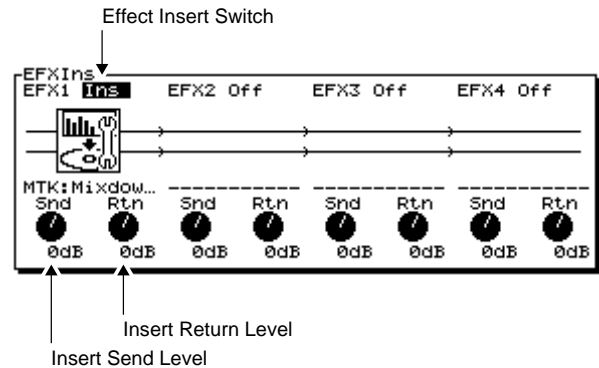

EFX1 (effect insert switch 1)

Select how the effect will be connected.

- Off:** The effect will not be inserted.
- Ins:** The stereo effect will be inserted into both channels. The inserted effects are shown as icons and as patch names (up to ten characters).

Snd (effect send level)

Adjust the volume level of the signal that is sent to the insertion effect (-42-6 dB). By default, this will be "0 dB."

Rtn (effect return level)

Adjust the volume level of the signal that is output from the insertion effect (-42-6 dB). By default, this will be "0 dB."

9. Press [F1 (EFX1)].
10. Press [F2 (Sel)].
11. Use the TIME/VALUE dial to move the cursor to the effect that you wish to use. For this example, select an effect such as "P210 MTK:Mixdown."

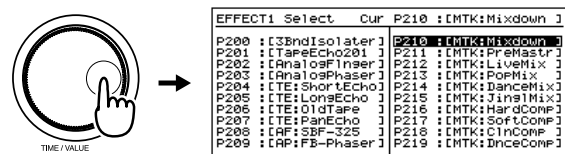

12. After selecting an effect, press [F4 (Exec)].

13. Press [F6 (EXIT)].

- 14.** Hold down [STOP], and press [STATUS] for all tracks (1–15/16) that you wish to mixdown. The STATUS indicator will light in green.

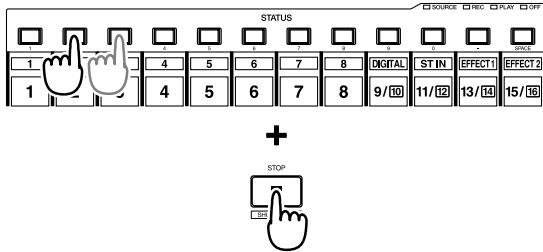

- 15.** Press [FADER] so that the TR (track) indicator lights.

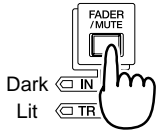

- 16.** Press [PLAY]. The song will play back.
17. Raise and lower the master fader, and verify that the volume of each track changes.



The sound that has passed through the master fader will be recorded on the mastering tracks. **In order to record at the optimal audio quality, you will normally set the master fader to 0 dB.**

- 18.** Use the channel faders (1–15/16) to adjust the volume balance of the tracks. At this time, the sound (volume level and pan) that is output from the MASTER jacks will be recorded “as is” to the mastering tracks. Adjust the volume to as high a level as possible without causing distortion.
19. When you are finished adjusting the volume, press [STOP].
20. Move to the time location at which you wish to begin the mixdown (e.g., 00h00m00s00f).
21. Change the “Status” of the mastering tracks to “Rec.”
22. Press [REC]. The REC indicator will light in red.
23. Press [PLAY]. The PLAY indicator will light in green, and recording will begin.
24. When you finish recording, press [STOP].

Signal flow (routing)

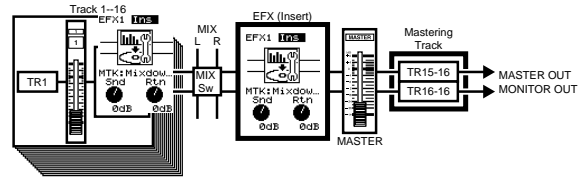

New effects algorithms

When the VS8F-2 effects expansion board is installed, the following effects algorithms will be added.

- Making the volume consistent for each frequency band (Mastering Tool Kit) (p. 14)
- Modeling various speakers (Speaker Modeling) (p. 17)

Making the volume consistent for each frequency band (Mastering Tool Kit)



This is a compressor that can be applied independently to each frequency band (high, mid, and low ranges). When mastering to MD or DAT, or when using a CD-R disc to produce your own original audio CDs, this allows you to master at the optimal level.

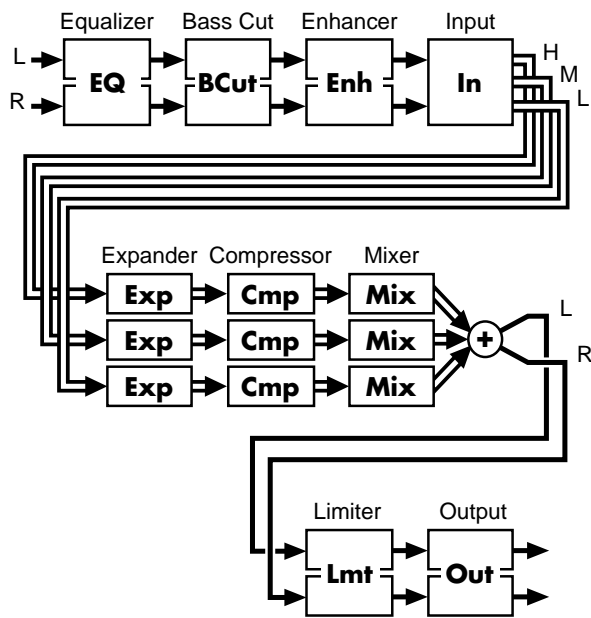

NOTE

The mastering tool kit can be used in either EFX1 or EFX3. When you use it, EFX2/EFX4 will be unavailable.

EQ (Equalizer)

This is a four-band equalizer with low, low-mid, high-mid, and high ranges.

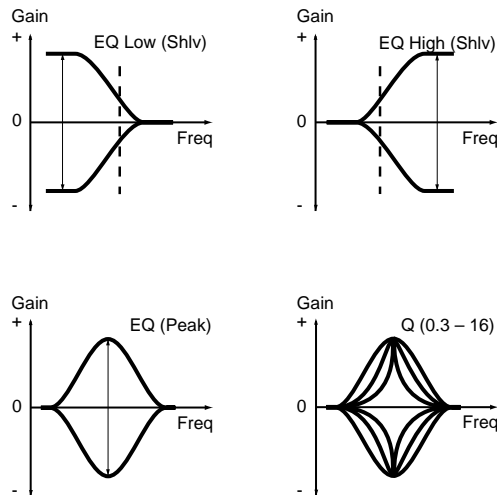

Sw (Switch) Off, On

Turns the equalizer on/off.

InputG (Input gain) -24+12dB

Adjusts the overall volume level of the signal before entering the equalizer.

Low Type Shlv, Peak High Type Shlv, Peak

Selects the type of the low range (Low) and high range (High) equalizer. (Shlv: shelving type, Peak: peaking type).

Low Gain -12+12dB

LoMid Gain (Low middle gain) -12+12dB

HiMid Gain (High middle gain) -12+12dB

High Gain (High gain) -12+12dB

Adjust the gain (the amount of boost or cut) for each equalizer band.

Low Freq (Low frequency) 20-2,000Hz

LoMid Freq (Low middle frequency)

20-8,000Hz

HiMid Freq (High middle frequency)

20-8,000Hz

High Freq (High frequency) 1.4-20kHz

Adjust the center frequency of each equalizer band.

Low Q (Low Q) 0.3-16

LoMid Q (Low middle Q) 0.3-16

HiMid Q (High middle Q) 0.3-16

High Q (High Q) 0.3-16

Adjust the width of the area around the center frequency (Freq) that will be affected by the Gain. As these values are raised, a narrower range will be affected.

Lvl (Level) -24+12dB

Adjusts the overall volume of the signal that has passed through the equalizer.

BCut (Bass-cut filter)

This removes unwanted low-frequency components, such as pop noise.

Sw (Switch) Off, On

Turns the bass-cut filter on/off.

Freq (Frequency) Thru, 20–2,000Hz

Adjusts the cutoff frequency of the bass-cut filter.

Enh (Enhancer)

This effect adds a phase-shifted signal to the original signal, enhancing the presence of the sound, and bringing it to the foreground.

Sw (Switch) Off, On

Turns the enhancer on/off.

Sens (Sensitivity) 0–100

Adjusts the degree to which the enhancer will respond to the volume of the input signal.

Freq (Frequency) 1.0–10.0kHz

Adjusts the frequency at which the enhancer will begin to take effect. The effect is applied at frequencies above the specified value.

MixLvl (Mix level) -24–+12dB

Adjusts the amount of effect sound that will be added to the original sound.

In (Input)

The input signal is divided into three parts by frequency band.

InputG (Input gain) -24–+12dB

Adjusts the overall volume level of the signal before it enters the expander (Exp) and compressor (Cmp).

D-Time (Detect time) 0–10ms

If the original signal is slightly delayed before being input, the expander/compressor will be able to use more processing time, and can adjust the level more appropriately. Adjusts the time by which the original signal is delayed.

The output signal from the Mastering Tool Kit is delayed by the time set here.

L-SplitP (Low split point) 20–800Hz

H-SplitP (High split point) 1.6–16kHz

Specify the frequencies at which the original signal will be split into three parts.

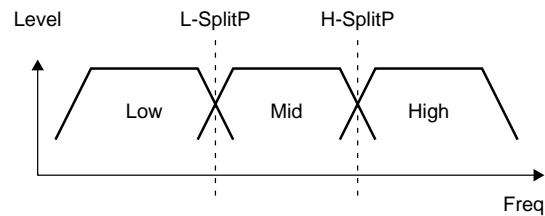

Exp (Expander)

This effect restricts the output by a specific ratio when low-level signals are input.

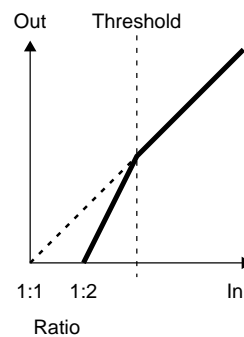

Sw (Switch) Off, On

Turns the expander on/off.

Low Thre (Low threshold) -80–0dB

Mid Thre (Middle threshold) -80–0dB

High Thre (High threshold) -80–0dB

Specify the level at which the expander will begin to take effect.

Low Ratio 1:1–1:16, 1:INF

Mid Ratio 1:1–1:16, 1:INF

High Ratio 1:1–1:16, 1:INF

Adjust the ratio by which the output is restricted when the input level is below the threshold level.

Low Atck (Low attack) 0–100ms

Mid Atck (Middle attack) 0–100ms

High Atck (High attack) 0–100ms

Adjust the time from when the input level falls below the threshold level until the expander begins to take effect.

Low Rel (Low release) 50–5,000ms

Mid Rel (Middle release) 50–5,000ms

High Rel (High release) 50–5,000ms

Adjust the time from when the input level exceeds the threshold level until the expander effect is bypassed.

Cmp (Compressor)

When a high-level signal is input, this effect restricts the output at a specified ratio.

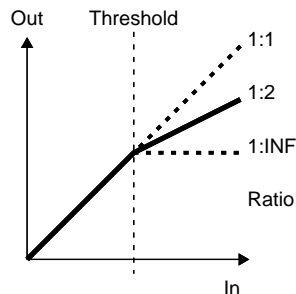

Sw (Switch) Off, On

Turns the compressor on/off.

Low Thre (Low threshold) -24-0dB

Mid Thre (Middle threshold) -24-0dB

High Thre (High threshold) -24-0dB

Specify the level at which the compressor will begin to take effect.

Low Ratio 1:1-1:16, 1:INFINITY

Mid Ratio 1:1-1:16, 1:INFINITY

High Ratio 1:1-1:16, 1:INFINITY

Adjust the ratio by which the output will be restricted when the input level exceeds the threshold level.

Low Atck (Low attack) 0-100ms

Mid Atck (Middle attack) 0-100ms

High Atck (High attack) 0-100ms

Adjust the time from when the input level exceeds the threshold level until the compressor takes effect.

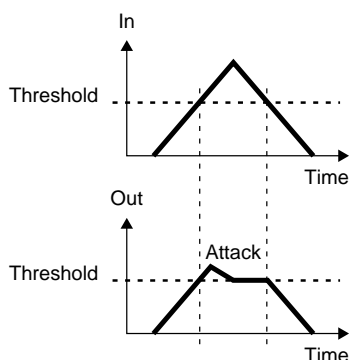

Low Rel (Low release) 50-5,000ms

Mid Rel (Middle release) 50-5,000ms

High Rel (High release) 50-5,000ms

Adjust the time from when the input level falls below the threshold level until the compressor no longer has an effect.

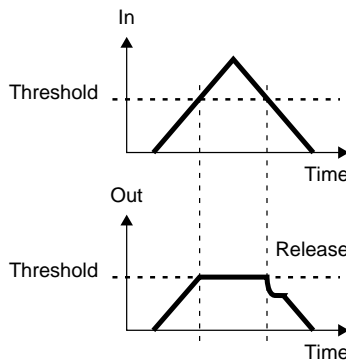

NOTE

The compressor provides threshold (Thre) and Ratio settings that automatically adjust a signal to the optimal level. Since lengthening the attack (Atck) may cause distortion, a -6 dB margin is provided. Adjust the mixer (Mix) level as necessary.

Mix (Mixer)

Adjusts the volume for each of the three frequency bands that were divided.

Low Lvl (Low level) -80-+6dB

Mid Lvl (Middle level) -80-+6dB

High Lvl (High level) -80-+6dB

These adjust, for each band, the volume level of the signal that has passed through the expander (Exp) and compressor (Cmp).

Lmt (Limiter)

This effect restricts excessive input levels.

Sw (Switch) Off, On

Turns the limiter on/off.

Thresh (Threshold) -24-0dB

Specifies the level at which the limiter will begin to operate.

Attack 0-100ms

Adjusts the time from when the input level exceeds the threshold level until when the limiter begins to operate.

Release 50-5,000ms

Adjusts the time from when the input level falls below the threshold level until the limiter no longer has an effect.

Out (Output)

Make settings related to the overall output.

Soft Clip Off, On

This quiets unwanted distortion that occurs when the compressor or limiter effect is applied in an extreme fashion.

Dither Off, 24–8bit

By adding a minute level of noise (dither), this smoothes the transition between playback audio and silence.

Level -80–+6dB

This adjusts the overall volume level of the sound that has passed through the limiter (Lmt).

Modeling various speakers (Speaker Modeling)



You can model the acoustical characteristics of a variety of speakers, ranging from high-level professional monitor speakers used in studios worldwide, to the speakers of small televisions or portable radios.

NOTE

*Speaker modeling has been calibrated so that **the optimal effect will be obtained when Roland DS-90 powered monitors are connected digitally.** If you are using other speakers, you may not be able to obtain the desired effect.*

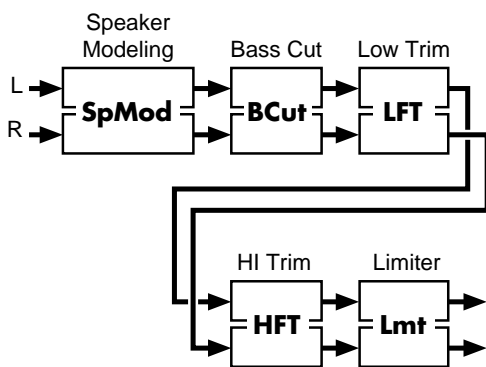

SpMod (speaker modeling)

Model

THRU, Super FLAT, Powered GenBlk, Powered E-Bas, Powered Mack, Small Cube, White Cone, White C +tissue, Small Radio, Small TV, Boom Box, BoomBox LoBoost

Select the speaker whose characteristics will be simulated (modeled).

THRU: Modeling will not be applied, and the sound will be output without change. Use this as a comparison with the speaker-modeled sounds.

Super FLAT: Modeling is used to compensate the DS-90, to produce an even flatter sound with a wider range.

Powered GenBlk: A widely used model of powered monitors (two-way type, with a woofer diameter of 170 mm (6-1/2 inches)).

Powered E-Bas: Powered monitors characterized by a bright tone.

Powered Mack: Powered monitors characterized by an extended low-frequency response.

Small Cube: Small full-range speakers widely used in recording studios.

White Cone: Sealed enclosure two-way speakers known for their white woofers and widely used in recording studios.

White C + tissue: A more mild sound, with tissue paper affixed over the tweeters of the above “White Cone” speakers.

Small Radio: Small pocket-type radio.

Small TV: Speakers built into a 14 inch size television.

Boom Box: Radio cassette recorder.

BoomBox LoBoost: Radio cassette recorder with the Low Boost switched on.

Phase NRM, INV

Specifies the phase of the speakers.

NRM: Same phase as the input.

INV: Opposite phase of the input.

BCut (Bass-cut filter)

This removes unwanted low-frequency components, such as pop noise.

Sw (Switch) Off, On

Switches the bass-cut filter on/off.

Freq (Frequency) Thru, 20–2,000Hz

Adjusts the cutoff frequency of the bass-cut filter.

LFT/HFT (Frequency trimmer)

Sw (Switch) Off, On

Turns the frequency trimmer on/off.

Gain -12–+12dB

For each trimmer, adjusts the gain (amount of boost/cut).

Freq (Frequency) 20–2,000Hz**Freq (Frequency) 1.0–20.0kHz**

Set the center frequency of each trimmer.

Lmt (Limiter)

This effect limits excessive output levels.

Sw (Switch) Off, On

Turns the limiter on/off.

Thresh (Threshold) -60-0dB

Specifies the level at which the limiter will begin to operate.

Release 0-100

Adjusts the time from when the input level falls below the threshold level until the limiter no longer has an effect.

Level -60-+24dB

Adjusts the volume level of the sound that has passed through the limiter.

Effective ways to use speaker modeling

Speaker modeling can be used effectively when you wish to audition how your final production (an original audio CD, or a mixed-down MD or DAT etc.) will sound on a variety of speakers. Here we will explain how speaker modeling can be used when producing an audio CD to audition the final result. Read this section in conjunction with the DS-90 owner's manual.

1. Digitally connect the VS-1680 V-XPANDED to the DS-90 (coaxial or optical.) Set the DS-90's input select switch to the digital input that you are using.
2. Make settings so that the mix bus is output from the digital output connector you connected in step 1.
 - 2-1. Press [MASTER].
 - 2-2. Press [PAGE] so that the function button indicates "DOUT1" or "DOUT2."
 - 2-3. Press [F5 (DOUT1)] (coaxial) or [F6 (DOUT2)] (optical).
 - 2-4. Use the TIME/VALUE dial to select "MST."
3. Make settings so that the mixdown can be performed while inserting effects (p. 11).

4. Select the effect that will be inserted. For this example, select a patch that uses the speaker modeling algorithm.
 - 4-1. Press [PLAY (DISPLAY)].
 - 4-2. Hold down [SHIFT] and press [F4 (EFX B)].
 - 4-3. Press [F1 (EFX3)].
 - 4-4. Press [F2 (Sel)].
 - 4-5. Use the TIME/VALUE dial to select a patch.
 - 4-6. Press [F4 (Exec)].
5. Press [PLAY]. Switch patches, and hear the sound as it would be heard through various speakers.
6. **When you are ready to perform the actual mixdown, turn off the speaker modeling patch that is inserted.**

NOTE

If, for example, you are modeling a set of radio-cassette recorder speakers and perform the mixdown without turning off the inserted speaker modeling patch, the sound as it would be heard on a radio-cassette would be recorded to the mixdown tracks. To avoid this, turn off speaker modeling before you perform the actual mixdown.

7. Select the mixed-down tracks as the tracks for writing, and create an audio CD (p. 25).

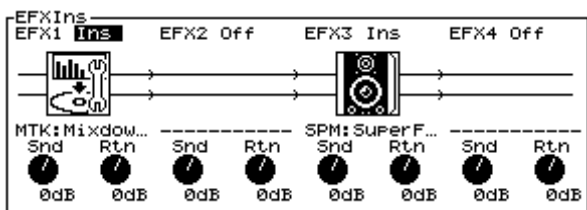

Editing an automix

As part of the new software, select the area to edit. You can now select an area (marker), and edit the automix data in that area. To edit the automix data, you must first select the area to which your editing will apply.

Erasing data from a specific area (Erase)

This operation erases the automix data from a specific area. Markers will not be erased.

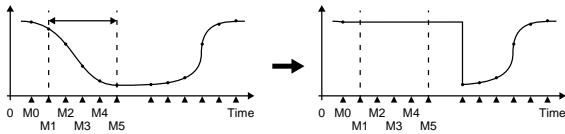

NOTE

Editing of the automix data cannot be cancelled by the Undo function (VS-1680 Owner's Manual, p. 160).

1. Press [PLAY (DISPLAY)].
2. Hold down [SHIFT] and press [F6 (UTIL)].
3. Press [PAGE] so that [F5] indicates "A.Mix," and then press [F5 (A.Mix)].

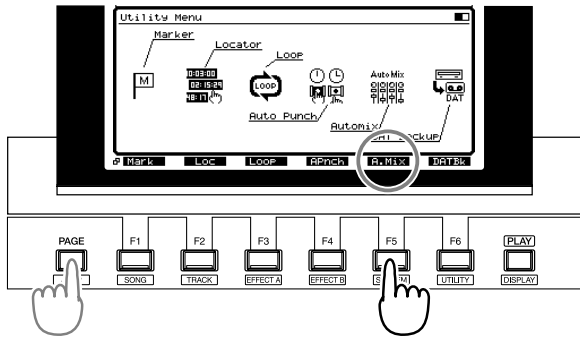

4. Press [F2 (Micro)].
5. Press [PAGE] so that [F1] indicates "In."

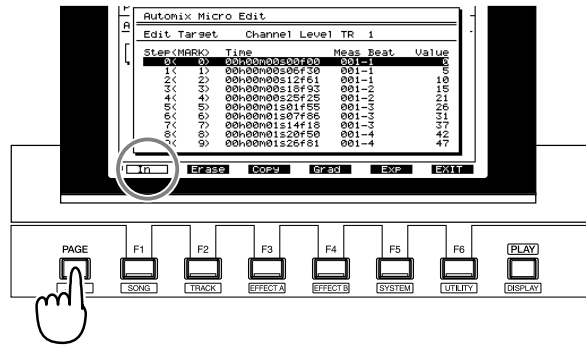

6. Make sure that the cursor is located at "Edit Target," and use the TIME/VALUE dial to select the automix data that you wish to erase.
7. Use [▲][▼] to move to the first marker of the area from which you wish to erase automix data, and press [F1 (In)].
8. Use [▲][▼] to move to the last marker of the area from which you wish to erase automix value, and press [F1 (Out)]. Check marks will be added to the area specified for erasure.

Step(MARK)	Time	Meas Beat	Value
0<	00h00m00s00f00	001-1	0
1<	00h00m00s06f30	001-1	5
2<	00h00m00s12f61	001-1	10
3<	00h00m00s18f93	001-2	15
✓ 4<	00h00m00s25f25	001-2	21
✓ 5<	00h00m01s01f55	001-3	26
6<	00h00m01s07f86	001-3	31
7<	00h00m01s14f18	001-3	37
8<	00h00m01s20f50	001-4	42
9<	00h00m01s26f81	001-4	47

Check marks

NOTE

Even if you wish to erase the automix data for only one marker, press the button in the order of [F1 (In)]→[F1 (Out)] at the same marker location.

MEMO

You can rotate the TIME/VALUE dial to modify the automix setting value at the cursor location. If you wish to re-select the automix value that will be erased, press [◀].

9. Press [F2 (Erase)].

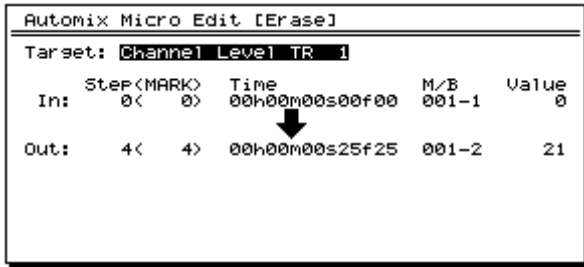

Target

This will indicate the type of automix data that you selected to be erased in step 6. If you wish to erase all automix data, use the TIME/VALUE dial to select "All Level and Pan."

- 10. If you wish to erase the data, press [F4 (Exec)]. If you press [F6 (EXIT)], you will return to step 7 without erasing any data.

- 11. A message will ask you to confirm the operation. Press [YES]. If you press [NO], the erasure will be halted, and you will return to step 10.



- 12. When the data has been erased, the display will indicate "Complete." Press [PLAY (DISPLAY)].

Copying data to another location (Copy)

This operation copies automix data from a specific area, and overwrites it onto another location (specified data/time).

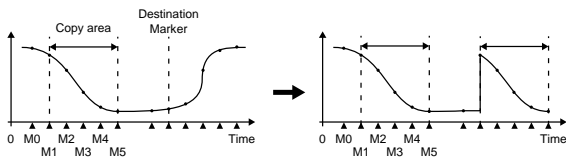

NOTE

Editing of the automix data cannot be cancelled by the Undo function (VS-1680 Owner's Manual, p. 160).

- 1. Press [PLAY (DISPLAY)].
- 2. Hold down [SHIFT] and press [F6 (UTIL)].

- 3. Press [PAGE] so that [F5] indicates "A.Mix," and then press [F5 (A.Mix)].

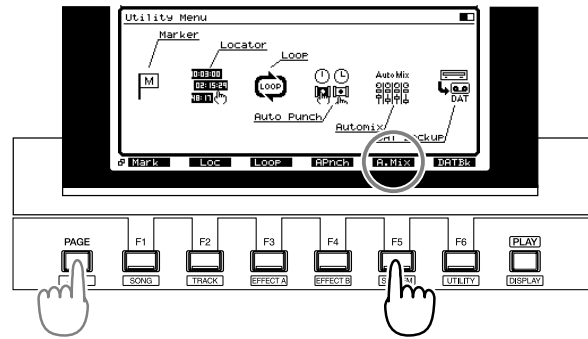

- 4. Press [F2 (Micro)].
- 5. Press [PAGE] so that [F1] indicates "In."

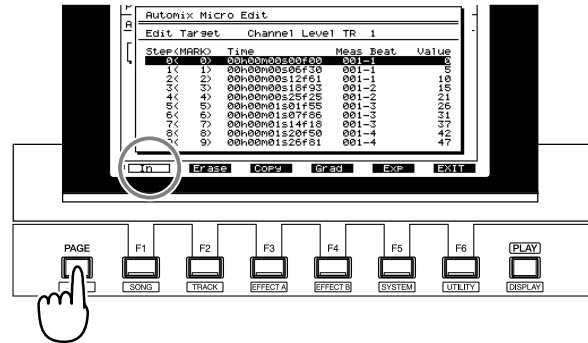

- 6. Make sure that the cursor is located at "Edit Target," and use the TIME/VALUE dial to select the type of automix data that you wish to edit.
- 7. Use [▲][▼] to move the cursor to the first marker of the area from which you wish to copy automix data, and press [F1 (In)].
- 8. Use [▲][▼] to move the cursor to the last marker of the area from which you wish to copy automix data, and press [F1 (Out)]. A check mark will be added to the copy area.

Step<MARK>	Time	Meas Beat	Value
0< 0>	00h00m00s00f00	001-1	0
1< 1>	00h00m00s06f30	001-1	5
2< 2>	00h00m00s12f61	001-1	10
3< 3>	00h00m00s18f93	001-2	15
4< 4>	00h00m00s25f25	001-2	21
5< 5>	00h00m01s01f55	001-3	26
6< 6>	00h00m01s07f86	001-3	31
7< 7>	00h00m01s14f18	001-3	37
8< 8>	00h00m01s20f50	001-4	42
9< 9>	00h00m01s26f81	001-4	47

Check marks

NOTE

Even if there is only one marker for the automix data that you wish to copy, press the button in the order of [F1 (In)]→[F1 (Out)] at the same marker location.

MEMO

You can rotate the TIME/VALUE dial to modify the automix setting value at the cursor location. If you wish to re-select the automix data that will be copied, press [◀].

9. Press [F3 (Copy)].

10. Use [▲]||[▼]||[◀]||[▶] to move the cursor. Rotate the TIME/VALUE dial.

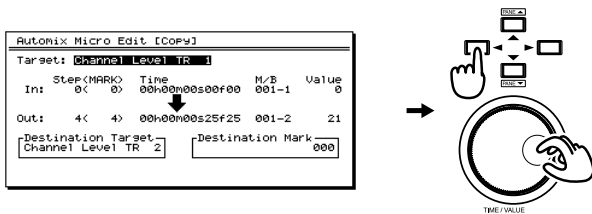

Target

This will indicate the type of automix data that you selected to be copied in step 6. If you wish to copy all automix data, use the TIME/VALUE dial to select "All Level and Pan."

Destination Target

Select the copy destination for the automix data.

MEMO

There is no limitation on the copy-source and copy-destination data. For example you can copy the volume level data (0–127) from a track, and overwrite it onto the pan data (L63–R63). However, if you do so, the results may not be as you expect.

Destination Mark

Select the first marker of the copy destination.

The markers that had originally been assigned to the copy destination will remain, but the data will be rewritten. Also, the markers from the copy source will be added.

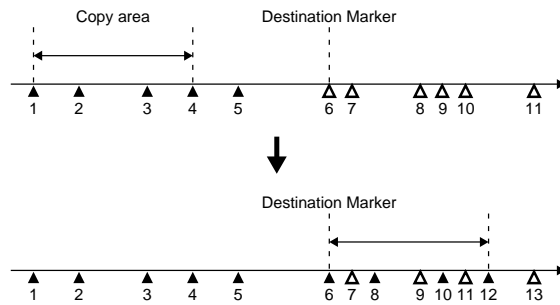

6, 10: The automix data of the copy-destination markers will be rewritten.

7, 9, 11: Since copy-source markers corresponding to the copy-destination markers do not exist, the automix data will be erased.

8, 12: Markers with automix data will be created.

11. To copy the data, press [F4 (Exec)]. If you press [F6 (EXIT)], you will return to step 7 without copying the data.

12. A message will ask for confirmation. Press [YES]. If you press [NO], the data copy operation will be halted, and you will return to step 11.



13. When the data has been copied, the display will indicate "Complete." Press [PLAY (DISPLAY)].

Smooth data transitions (Gradation)

This operation creates auto-mix data that smoothly connects the first automix marker in the specified area with the last marker.

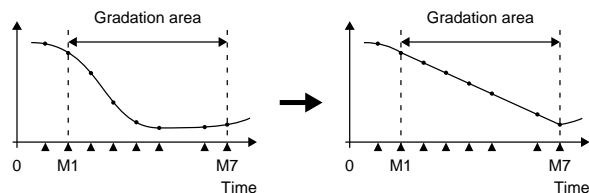

NOTE

Editing of the automix data cannot be cancelled by the Undo function (VS-1680 Owner's Manual, p. 160).

1. Press [PLAY (DISPLAY)].
2. Hold down [SHIFT] and press [F6 (UTIL)].
3. Press [PAGE] so that [F5] indicates "A.Mix," and then press [F5 (A.Mix)].

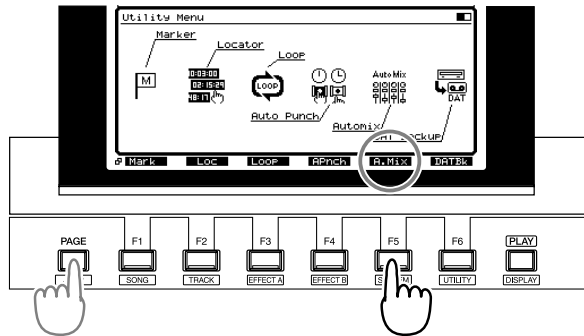

4. Press [F2 (Micro)].
5. Press [PAGE] so that [F1] indicates "In."

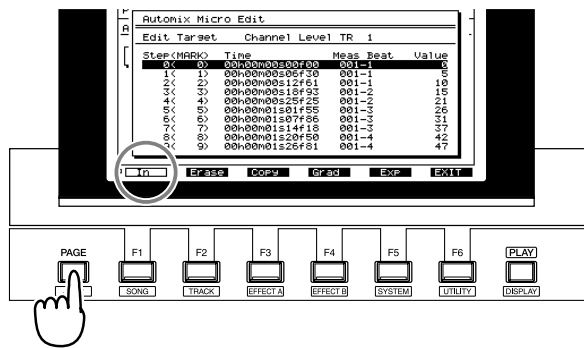

6. Make sure that the cursor is located at "Edit Target," and use the TIME/VALUE dial to select the type of automix data to which you wish to apply the Gradation operation.
7. Use [▲] [▼] to move the cursor to the first marker of the automix data to which you wish to apply the Gradation operation, and press [F1 (In)].
8. Use [▲] [▼] to move the cursor to the last marker of the automix data to which you wish to apply the Gradation operation, and press [F1 (Out)]. Check marks will be added to the range selected for Gradation.

Automix Micro Edit				
Step (MARK)	Time	Meas	Beat	Value
0<	0>	00h00m00s00f00	001-1	0
1<	1>	00h00m00s05f30	001-1	5
2<	2>	00h00m00s12f61	001-1	10
3<	3>	00h00m00s18f93	001-2	15
4<	4>	00h00m00s25f25	001-2	21
5<	5>	00h00m01s01f55	001-3	26
6<	6>	00h00m01s07f86	001-3	31
7<	7>	00h00m01s14f18	001-3	37
8<	8>	00h00m01s20f50	001-4	42
9<	9>	00h00m01s26f81	001-4	47

Check marks



You can rotate the TIME/VALUE dial to modify the automix setting value at the cursor location. If you wish to re-select the type of automix data that will be edited, press [◀].

9. Press [F4 (Grad)].
10. Use [▲] [▼] [◀] [▶] to move the cursor. Rotate the TIME/VALUE dial to set each parameter.

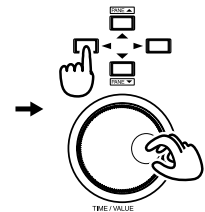
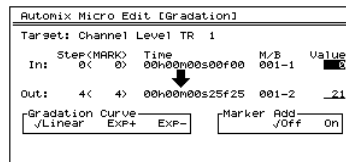

Value

Adjust the beginning (In:) and end (Out:) of the Gradation area.

Gradation Curve

Select the curve by which the gradation will be created.

- Linear:** Linear.
- Exp+:** Convex above (exponential curve).
- Exp-:** Convex below (exponential curve).

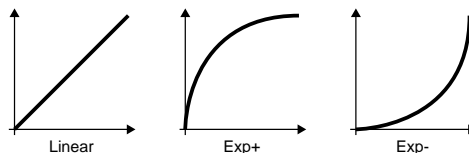

Marker Add

If this is turned "On," markers will automatically be added to the area specified for gradation, in the optimal locations for the curve that you selected in "Gradation Curve." If this is turned "Off," markers will not be added.

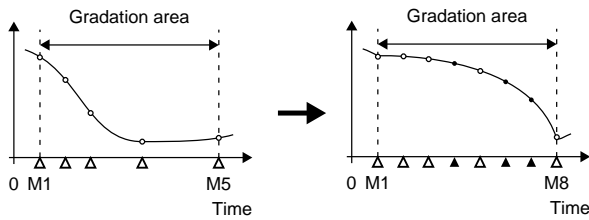

11. To execute the Gradation operation, press [F4 (Exec)]. If you press [F6 (EXIT)], you will return to step 7 without executing the Gradation operation.

12. A message will ask you to confirm the operation. Press [YES]. If you press [NO], the Gradation operation will be halted, and you will return to step 11.



13. When the Gradation operation has been executed, the display will indicate "Complete." Press [PLAY (DISPLAY)].

Increasing or decreasing all data values (Shift/Expand)

This operation increases or decreases the values of the automix data in a specific area. This can be done in two ways:

Shift adds (or subtracts) the same amount to each auto-mix data value, and **Expand** increases or decreases all auto-mix data values by the same proportion relative to a specified standard value.

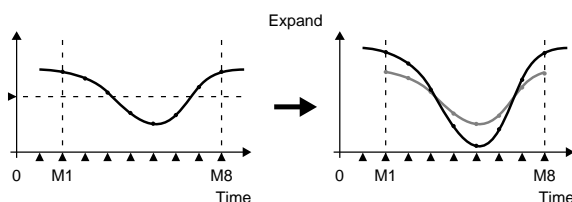
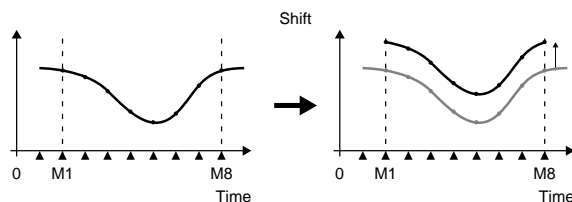

NOTE

Editing of the automix data cannot be cancelled by the Undo function (VS-1680 Owner's Manual, p. 160).

1. Press [PLAY (DISPLAY)].
2. Hold down [SHIFT] and press [F6 (UTIL)].
3. Press [PAGE] so that [F5] indicates "A.Mix," and then press [F5 (A.Mix)].

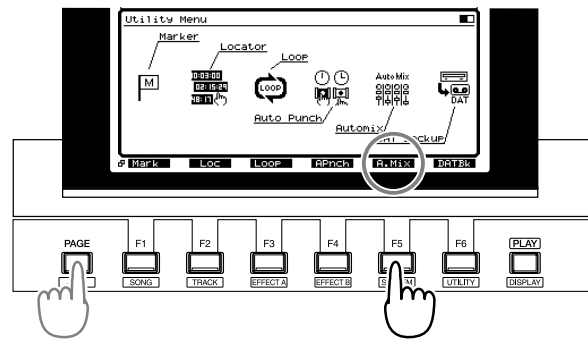

4. Press [F2 (Micro)].
5. Press [PAGE] so that [F1] indicates "In."

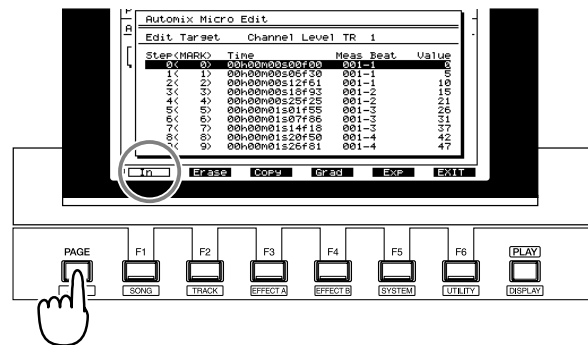

6. Make sure that the cursor is located at "Edit Target," and use the TIME/VALUE dial to select the automix data that will be increased or decreased.
7. Use [▲][▼] to move the cursor to the first marker of the automix data that you wish to increase or decrease, and press [F1 (In)].
8. Use [▲][▼] to move the cursor to the last marker of the automix value that you wish to increase or decrease, and press [F1 (Out)]. Check marks will be added to the selected area.

Automix Micro Edit				
Step<MARK>	Time	Meas Beat	Value	
0<	0>	00h00m00s00f00	001-1	0
1<	1>	00h00m00s06f30	001-1	5
2<	2>	00h00m00s12f61	001-1	10
3<	3>	00h00m00s18f93	001-2	15
4<	4>	00h00m00s25f25	001-2	21
5<	5>	00h00m01s01f55	001-3	26
6<	6>	00h00m01s07f86	001-3	31
7<	7>	00h00m01s14f18	001-3	37
8<	8>	00h00m01s20f50	001-4	42
9<	9>	00h00m01s26f81	001-4	47

Check marks

NOTE

Even if there is only one marker for the automix data that you wish to increase or decrease, press the button in the order of [F1 (In)] → [F1 (Out)] at the same marker location.

MEMO

You can rotate the TIME/VALUE dial to modify the automix setting value at the cursor location. If you wish to re-select the automix data that will be edited, press [◀].

9. Press [F5 (Exp)].

10. Use [▲][▼][◀][▶] to move the cursor.

Operate the TIME/VALUE dial to set the parameters.

Automix Micro Edit [Shift/Expand]				
Target:	Channel	Level	TR	
In:	Step<MARK>	Time	M/B	Value
	0<	0>	00h00m00s00f00	001-1
Out:	4<	4>	00h00m00s25f25	001-2
				21
	Shift		Expand	Threshold
	0		1.0	0

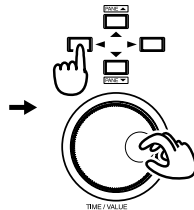

Target

This will indicate the type of automix data whose data will be increased or decreased, as you selected in step 6. If you wish to shift or expand the values of all automix data, use the TIME/VALUE dial to select “All Level and Pan.”

Shift

Specify the actual amount (-50-50) by which the automix data values will be increased or decreased.

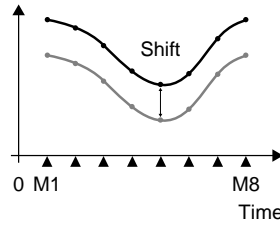

Expand

Specify the ratio (0.5-2.0) by which the automix data values will be increased or decreased relative to the “Threshold.”

Threshold

When using Expand to increase or decrease the automix data values by a specified proportion, this specifies the center value.

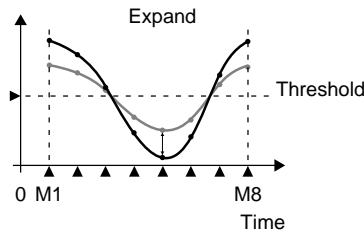

11. To execute the Shift/Expand operation, press [F4 (Exec)].

If you press [F6 (EXIT)], you will return to step 7 without executing the Shift/Expand operation.

12. A message will ask you to confirm. Press [YES]. If you press [NO], you will return to step 11 without executing the Shift/Expand operation.



13. When the Shift/Expand operation has been completed, the display will indicate “Complete.” Press [PLAY (DISPLAY)].

Using the VS-1680 with a CD-R/CD-RW drive

This chapter explains how a CD-R/CD-RW drive connected to the SCSI connector of the VS-1680 can be used to create original audio CD's, or to back up song data. Please also read "Chapter 7 Use with a CD-R Drive" in the VS-1680 Owner's Manual (p.120).

Creating an audio CD

Creating silence between songs (Disc At Once and Track At Once)

When writing two or more songs together to a CD-R disc, you can select how the space between songs will be handled.

Disc At Once

The song data and the track number markers attached to the song data will be written to the CD-R disc without change. However, **additional song data cannot be added later to a CD-R disc that was written using Disc At Once. (It will be in the same condition as if Finalize had been performed.)**

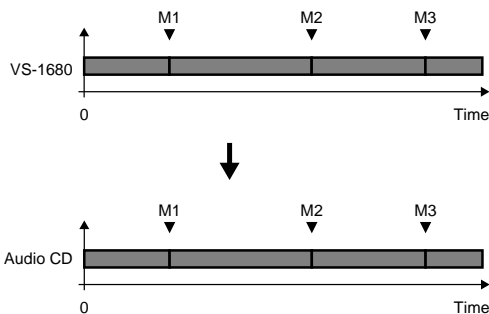

Track At Once

Two seconds of silence will automatically be written to the CD-R disc before each track number marker attached to the song data. (This is the same condition as when additional songs are written to the disc later.) Additional song data can be written to a CD-R disc that was written using Track At Once.

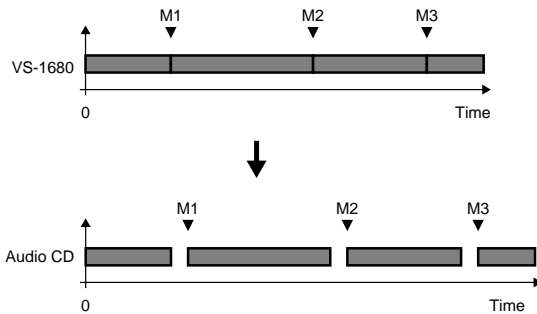

For example, if you have assigned track numbers to a medley of songs, Disc At Once would be the appropriate choice. This is because Track At Once would add approximately two seconds of silence, which would cause the playback to sound fragmented.

Specifying the writing speed (Speed)

When writing songs to a CD-R disc, you can now select the speed at which the data will be written.

Song writing procedure

1. Insert a CD-R disc into the drive.
2. Press [PLAY (DISPLAY)].
3. Hold down [SHIFT] and press [F1 (SONG)].
4. Press [F3 (CD Wt)]. If [F3] does not indicate "CD Wt," first press [PAGE] so that "CD Wt" appears, and then press [F3 (CD Wt)].

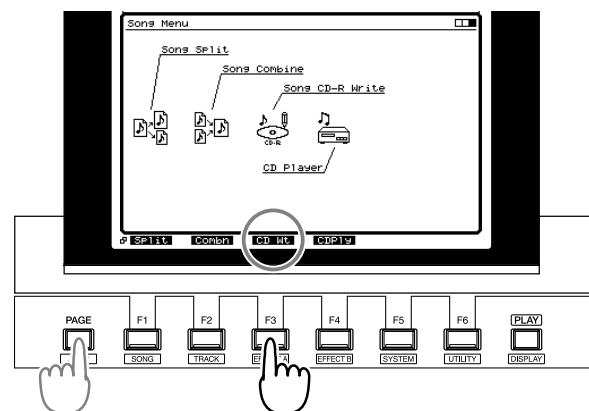

- A message will ask for confirmation. Press [YES].



- The display will ask "STORE Current?" (store the current song?). If you wish to store the current song before writing a song to CD, press [YES]. If not, press [NO].
- The following display will appear. Verify each item.

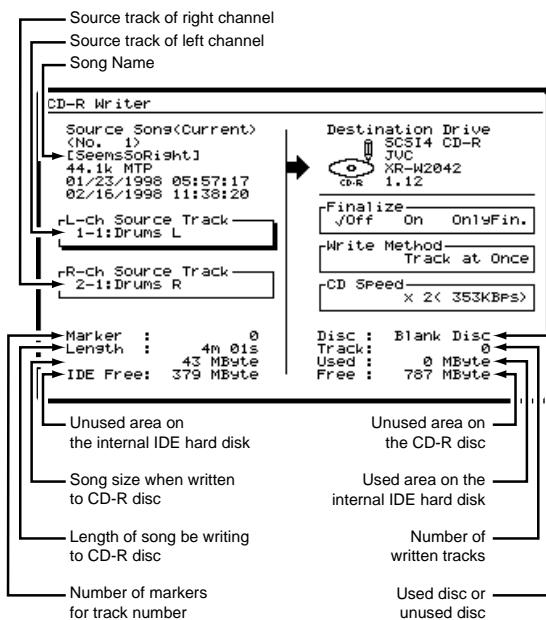

NOTE

If the "Song size when written to CD-R disc" is larger than the "Unused area on the internal IDE hard disk" or the "Unused area on the CD-R disc," it will not be possible to write the song data to the CD-R disc.

MEMO

The song size is displayed in 1 MB = 1,000,000 Byte units. The displayed size is an approximation.

- Use [▲][▼][◀][▶] to move the cursor, and use the TIME/VALUE dial to set the parameters.

Finalize

A TOC (Table Of Contents) will be written so that the audio CD created by the VS-1680 can be played back on a standard CD player. It is not possible to write additional data to an audio CD that has been finalized.

- Off:** Write only the song, and do not finalize.
- On:** Write the song, and then finalize.
- OnlyFin.:** Only finalize without writing the song. Select this if you have inserted a CD-R disc to which you have already written songs, but which has not yet been finalized.



TOC (Appendices p.64)

Write Method

When two or more songs are written to the disc at the same time, select how the data will be written.

Track at Once: Approximately two seconds of silence will be created between each song. Additional songs can be written later as far as the disc capacity allows.

Disc at Once: Silence will not be created between songs. However, no further data can be written on that disc.

MEMO

Even if "Finalize" was set to "Off," no further data can be written on a CD-R disc that was written with "Disc at Once" selected.

CD Speed

Select the speed at which the song will be written to the CD-R disc.

x2 (353 KBps): The song will be written at double speed (353 kilobytes per second).

x1 (176 KBps): The song will be written at normal speed (176 kilobytes per second). This will provide higher reliability.

NOTE

With some CD-R discs, the data may not be written correctly if you select "x2 (353 KBps)." In this case, select "x1 (176 KBps)."

However, if a CD-RW disc is inserted into the CD-RW drive, it will not be possible to select "x1 (176 KBps)" (the song will be written at double speed).

MEMO

Audio data written to a CD-RW disc cannot be played back on a conventional CD player. In such cases, you can listen to the data using the VS-1680's CD Player function.

9. Press [F4 (Exec)].
10. Press [YES]. A message about the license agreement will appear. Read the message carefully, and if you consent to that, press [YES]. The data will begin to write to the CD-R disc. If you do not consent, press [NO]. You will return to step 2.

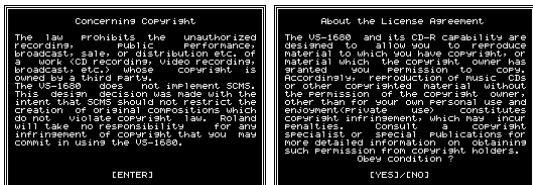

MEMO

The message about the license agreement is the same as “About the License Agreement” on the back cover of the “VS-1680 Owner’s Manual.”

11. When the data has been written successfully, the display will ask “Write Another ?” (write to another disc?). If you wish to write the identical song data to another CD-R disc, insert the new disc into the CD-RW drive, and press [YES]. If you press [NO], you will return to step 2.

Saving a song to a CD-RW disc (Backup)

Checking whether the song was saved correctly (+Verify)

After backing up a song to a CD-RW disc, you can now check whether or not the data was saved correctly (i.e., check the recorded state of the data).

If as a result of the +Verify operation, you are warned that the song data has not been saved correctly, you should back up to a different disc.

NOTE

When backing up to a CD-R, we recommend that you use +Verify to check whether the backup was performed correctly. However, +Verify checks the entire surface of the disc, so it takes a considerable amount of time.

Specifying the speed of saving (Speed)

When backing up a song on a CD-RW disc, you can now specify the speed at which the data will be written.

Backup procedure

1. As the current drive, select the drive (internal IDE hard disk) that contains the song you wish to back up.
2. Insert a CD-RW disc into the drive.
3. Press [PLAY (DISPLAY)].
4. Hold down [SHIFT] and [F6 (UTILITY)].
5. Press [F2 (CDRBk)]. If [F2] does not indicate “CDRBk,” first press [PAGE] so that “CDRBk” is displayed, and then press [F2 (CDRBk)].

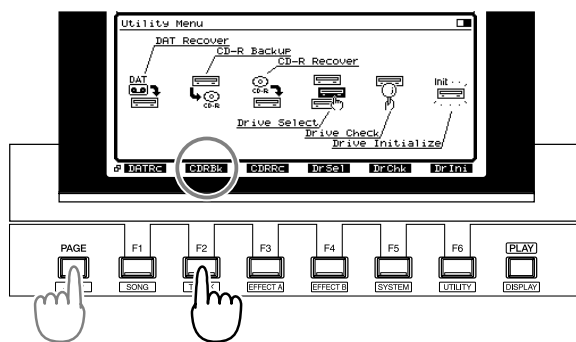

6. Use [▲] [▼] [◀] [▶] to move the cursor, and rotate the TIME/VALUE dial to set the parameters.

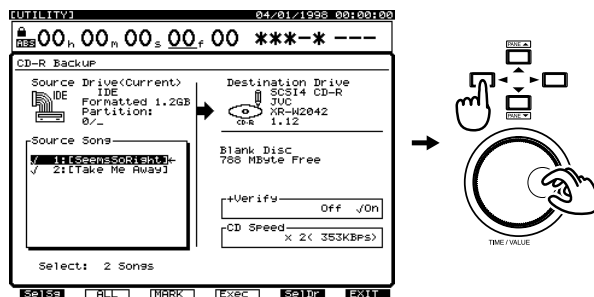

Source Song

The marked songs will be backed up. Move the cursor to a song that you wish to back up, and press [F3 (MARK)]. By pressing [F2 (ALL)] you can mark or unmark all songs at once. By pressing [F1 (SelSg)] you can view a list of the songs. At this time, mark a song and press [F1 (Back)].

+Verify

If this is turned "On," verification will be performed to check whether or not the data was saved correctly after the song data has been backed up.

CD Speed

Select the speed at which the song data will be backed up to the CD-RW disc

- x2 (353 KBps):** Backup at double speed (353 kilobytes per second).
- x1 (176 KBps):** Backup at normal speed (176 kilobytes per second). This will increase the reliability.

NOTE

Depending on the disc, it may not be possible to back up reliably to a CD-R disc with a setting of "x2 (353 KBps)." In such cases, select "x1 (176 KBps)." Also, if you insert a CD-RW disc into a CD-RW drive, it will not be possible to select "x1 (176 KBps)" (backup will occur at double speed).

- 7. If two or more drives are connected, you can press [F5 (SelDr)] to see a list of the drives. After checking the list of drives, press [F1 (Back)].

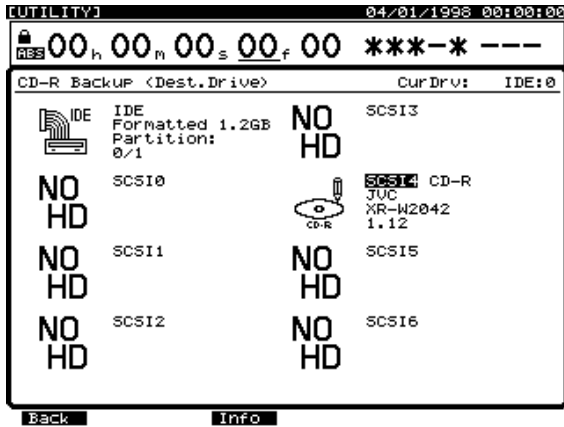

- 8. Press [F4 (Exec)]. A message will ask you to confirm.



- 9. Press [YES]. The display will ask "STORE Current?" (store the current song?)

- 10. If you wish to save the current song, press [YES]. If not, press [NO]. If a protected song (such as a demo song) is selected, press [NO].

- 11. If the amount of song data is too large to back up onto a single CD-RW disc, the CD-RW disc will be ejected, and you will be prompted to "Insert Disc #" (where # is number of each disc in the series), so that the VS-1680 can verify the number of discs that will be required. Insert the next CD-RW disc, and press [YES]. At this time, we recommend that you use a soft-tipped felt marker pen to write the disc number on the disc label so that you can remember the sequence in which each disc should be inserted.



- 12. If the backup extends over two or more discs, the display will prompt you to "Insert Disc #." Insert each disc once again in the correct sequence, and press [YES]. Then, backup will begin.

- 13. When the CD-R backup ends, you are returned to Play condition.

Restoring songs from a CD-RW disc (Recover)

Specifying the speed of recovery (Speed)

Now you can specify the speed at which the data will be read when recovering a song from a CD-RW disc.

Recovery procedure

1. Select the loading destination (recovery destination) drive as the current drive.
2. Insert the CD-RW disc that contains the song backup into the drive.
3. Press [PLAY (DISPLAY)].
4. Hold down [SHIFT] and press [F6 (UTILITY)].

5. Press [F3 (CDRRc)]. If [F3] does not indicate "CDRRc," first press [PAGE] so that "CDRRc" appears, and then press [F3 (CDRRc)].

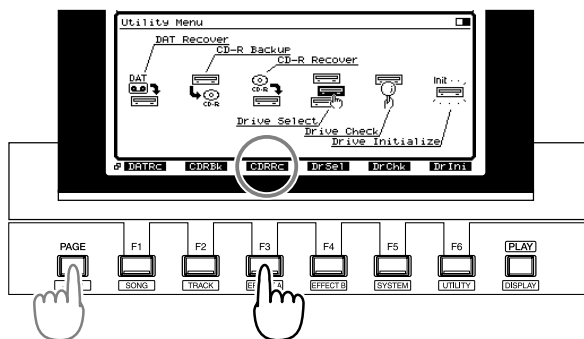

6. Use [▲] [▼] [◀] [▶] to move the cursor, and use the TIME/VALUE dial to set the parameters.

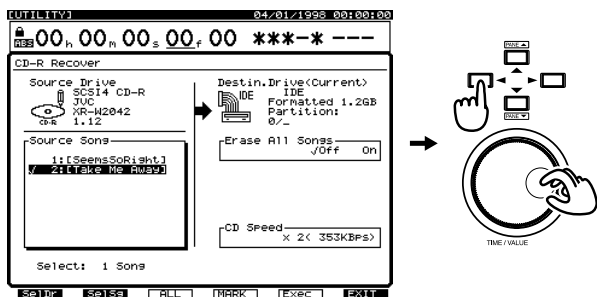

Source Song

Marked songs will be loaded. Move the cursor to a song that you wish to recover, and press [F4 (MARK)]. By pressing [F3 (ALL)] you can mark or unmark all songs at once. By pressing [F2 (SelSg)] you can view a list of the songs. At this time, mark the desired song, and press [F1 (Back)].

Erase All Songs <<ATTENTION>>

If this is "On," the current drive will be initialized before the song data is recovered. If you wish to recover while preserving the songs that are saved on the current drive, set this "Off."

CD Speed

Select the speed at which the song data will be recovered from disc.

- x6 (1058 KBps):** Recover at 6x speed (1058 kilobytes per second).
- x2 (353 KBps):** Recover at double speed (353 kilobytes per second).
- x1 (176 KBps):** Recover at normal speed (176 kilobytes per second). This will allow greater reliability.

NOTE

Depending on the disc, it may not be possible to recover reliably from some CD-R discs at speeds of "x6 (1058 KBps)" or "x2 (353 KBps)." In this case, select "x1 (176 KBps)." Even if the "CD Speed" is set to "x2 (353 KBps)" or "x6 (1058 KBps)" the time it takes for recovery is not always 1/2 or 1/6 of the base. This is because writing to the internal hard disk can take a lot of time, or disc read errors can sometimes occur.

7. Press [F4 (Exec)]. A message will ask you for confirmation.



8. Press [YES]. The display will ask "STORE Current?" (store the current song?).
9. If you wish to store the current song, press [YES]. If not, press [NO]. If a demo song is selected, press [NO].
10. The recovery operation will begin. If the data has been backed up to multiple discs, the disc will be ejected, and you will be prompted to "Insert Disc #" (# is the order number of each disk). Insert the next disc and press [YES].



11. When the CD-R recovery ends, you are returned to Play condition.

Enhancements related to operation

Shortcut to the Phrase Edit window

In Play condition, you can now select the phrase that you wish to edit, and open the editing window directly.

1. Press [PLAY (DISPLAY)].
2. Move the current time so that it falls within the phrase that you wish to edit.
3. Use [▲] [▼] to highlight the phrase that you wish to edit.

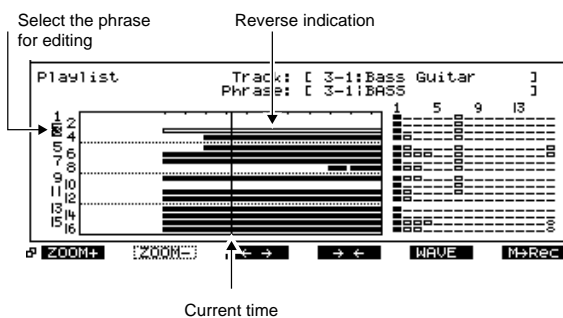

If the bottom line of the display is enclosed in a heavy line, you can also use the TIME/VALUE dial to highlight the phrase that you wish to edit.

4. Press [PAGE] so that the function buttons display the phrase edit menu.

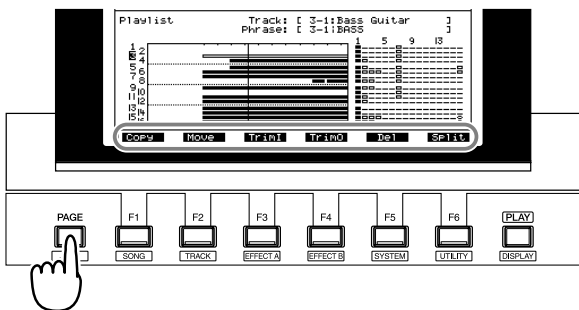

At this time, the function buttons will have the following operations. Press the function button for the desired editing operation.

- [F1 (Copy)]: Opens the Phrase Copy window (VS-1680 Owner's Manual, p. 93).
- [F2 (Move)]: Opens the Phrase Move window (VS-1680 Owner's Manual, p. 96).

- [F3 (TrimI)]: Opens the Trim In window (VS-1680 Owner's Manual, p. 97).
- [F4 (TrimO)]: Opens the Trim Out window (VS-1680 Owner's Manual, p. 98).
- [F5 (Del)]: Opens the Phrase Delete window (VS-1680 Owner's Manual, p. 99).
- [F6 (Split)]: Opens the Phrase Divide/Split window (VS-1680 Owner's Manual, p. 100).

Creating a new phrase (Phrase New)

In the Phrase New window (VS-1680 Owner's Manual, p. 101), you can now sort takes and reassign names.

Sorting the take list (Sort)

1. Press [PLAY (DISPLAY)].
2. Hold down [SHIFT] and press [F2 (TRACK)].
3. Press [F1 (Tr/Ph)] so that the Phrase Edit menu appears.
4. Press [PAGE] so that [F3] indicates "New," and then press [F3 (New)].

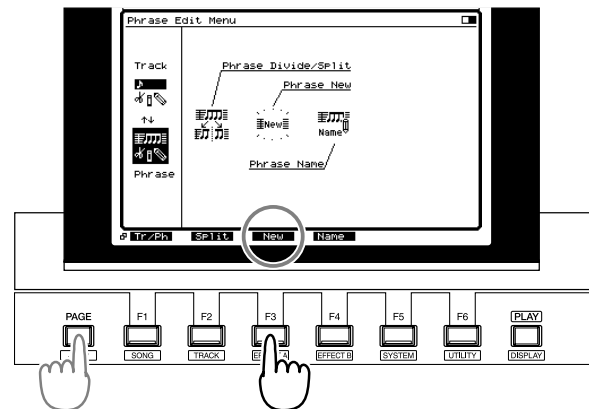

5. Press [F1 (Take)].
6. At this time, pressing [F3 (Sort)] will switch the order in which the takes are sorted, cycling through the following choices.

- HIST:** The order in which the takes were recorded
- V.Tr:** The order of the V-tracks on which the takes are recorded
- NAME:** The alphabetical order of the take names

The order in which the takes were recorded

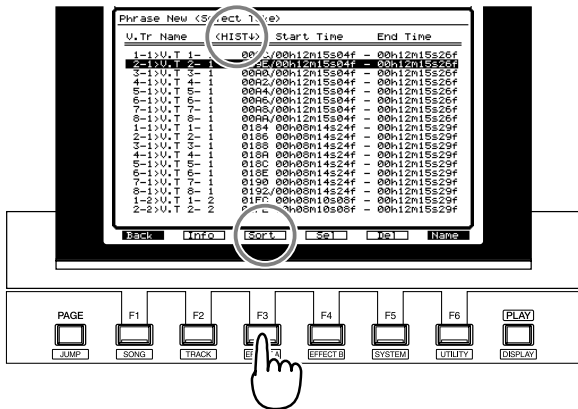

The order of the V-tracks on which the takes are recorded

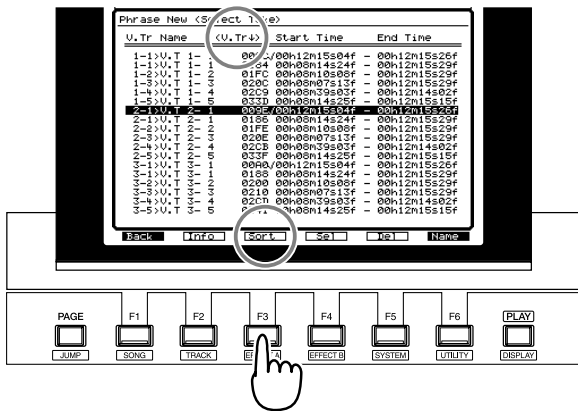

The alphabetical order of the take names

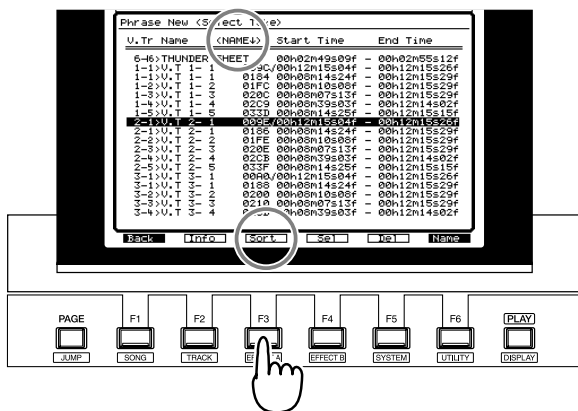

7. Use the TIME/VALUE dial to select the take that will be the basis of the newly created phrase.
8. Press [F4 (Sel)] or [ENTER (YES)].
9. Use [▲] [▼] [◀] [▶] to move the cursor, and use the TIME/VALUE dial to set the parameters.

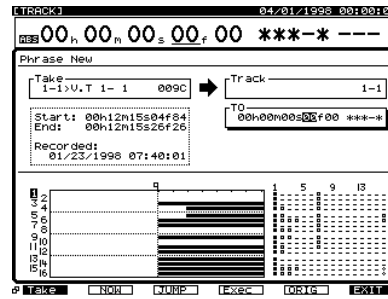

Take

This will show the take that you selected in step 8. You may re-select the take if desired.

Track

Select the track on which you wish to create the new phrase.

To

Specify the time at which you wish to create the new phrase.

10. Press [F4 (Exec)]. The Phrase New command will be executed.

11. When the display indicates “Complete,” press [PLAY (DISPLAY)]. You will return to Play condition.

Deleting a take (Delete)

NOTE

A deleted take cannot be recovered by the Undo function (VS-1680 Owner’s Manual, p. 160).

1. Press [PLAY (DISPLAY)].
2. Hold down [SHIFT] and press [F2 (TRACK)].
3. Press [F1 (Tr/Ph)] so that the Phrase Edit menu appears.
4. Press [PAGE] so that [F3] indicates “New,” and then press [F3 (New)].

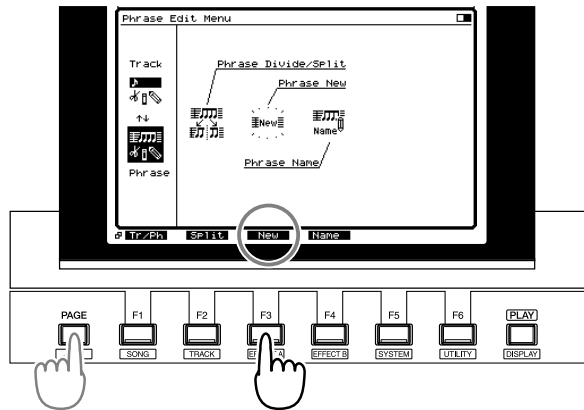

5. Press [F1 (Take)].
6. Use the TIME/VALUE dial to move the cursor to the take that you wish to delete.

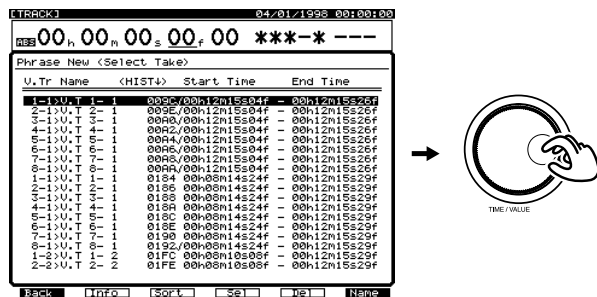

7. Press [F5 (Del)]. A message will ask you to confirm.

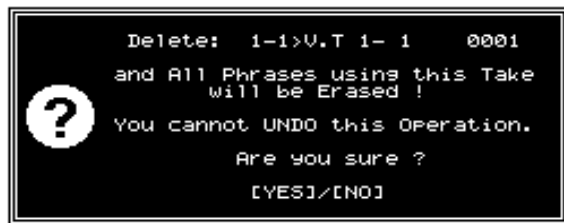

8. If you wish to delete the take, press [YES]. If you press [NO], you will return to step 6 without deleting the take.
9. When the take has been deleted, the display will indicate "Complete." Press [PLAY (DISPLAY)]. You will return to Play condition.

NOTE

When a take is deleted, all phrases used by that take will also be deleted.

MEMO

When you delete a take, the song will be stored automatically.

Naming a take (Name)

You can now assign a name to a take in the Phrase New window.

1. Press [PLAY (DISPLAY)].
2. Hold down [SHIFT] and press [F2 (TRACK)].
3. Press [F1 (Tr/Ph)] to make the Phrase Edit menu appear.
4. Press [PAGE] so that [F3] indicates "New," and then press [F3 (New)].

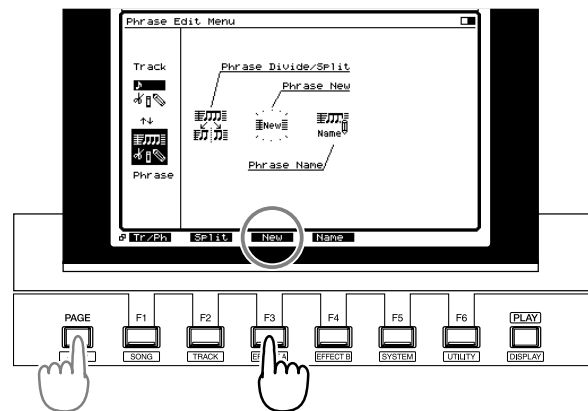

5. Press [F1 (Take)].
6. Use the TIME/VALUE dial to move the cursor to the take whose name you wish to change.
7. Press [F6 (Name)].
8. The Take Name window will appear. Use [▲][▼] [◀][▶] and the TIME/VALUE dial to assign a name to the take.

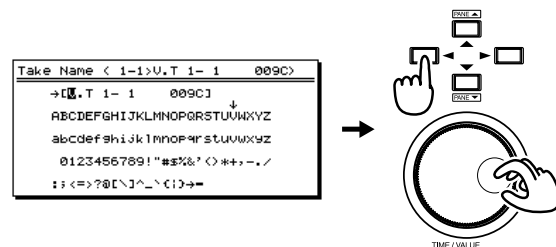

At this time, the function buttons have the following operations.

- [F1 (Hist)]: Each time you press the button, you will cycle backward through the last twenty names that were assigned.
- [F2 (Clr)]: Delete all characters.
- [F3 (Del)]: Delete the character at the cursor location.
- [F4 (Ins)]: Insert a space at the cursor location.
- [F5 (Write)]: Finalize the take name and exit the window.
- [F6 (EXIT)]: Exit the window without finalizing the take name.

9. After assigning the name, press [F5 (Write)]. A message will ask whether you also want to change the names of the phrases used by that take.



10. If you also want to change the phrase names at this time, press [YES]. If you press [NO], the phrase names will remain the same, and only the take name will change.

MEMO

Phrase names will be assigned by adding an incremented number to the end of the take name. For example if the take is named "AcousticGuitarLR," the phrase names will be "AcousticGuitar-1," "AcousticGuitar-2," etc.

11. When the display indicates "Complete," hold down [SHIFT] and press [STORE (ZERO)].
12. Press [YES]. The song will be saved.
13. Press [PLAY (DISPLAY)]. You will return to Play condition.

Dividing a phrase (Phrase Divide/Split)

The Phrase Split function (VS-1680 Owner's Manual, p. 100) has been enhanced. Now, both **Phrase Divide** and **Phrase Split** can divide the selected phrase (or phrases) at the Now Time location on the time axis.

Automatically dividing a phrase (Phrase Divide)

This function automatically detects silent portions of a phrase according to the volume level that you specify (the Threshold Level), and divides the phrase into two or more phrases at these points.

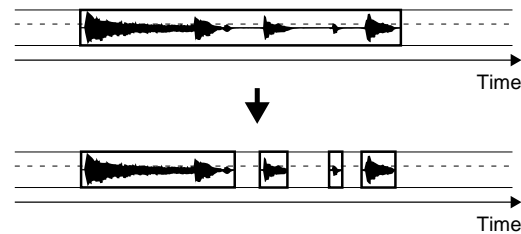

1. Press [PLAY (DISPLAY)].
2. Hold down [SHIFT] and press [F2 (TRACK)].
3. Press [F1 (Tr/Ph)] so that the Phrase Edit menu appears.
4. Press [PAGE] so that [F2] indicates "Split," and then press [F2 (Split)].

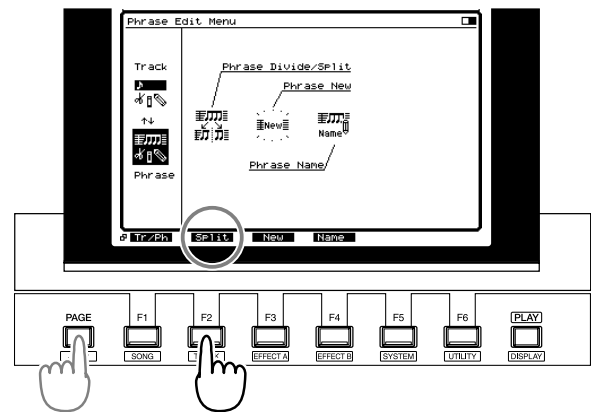

5. Press [F1 (SelPh)].
6. Press the [STATUS] button for the phrase that you wish to divide. The STATUS indicator will light in red. Alternatively, you can use [▲][▼][◀][▶] to move the cursor to the phrase that you wish to divide, and press [F3 (MARK)] or [YES].

MEMO

By pressing [F2 (ALL)], you can mark or unmark all phrases simultaneously.

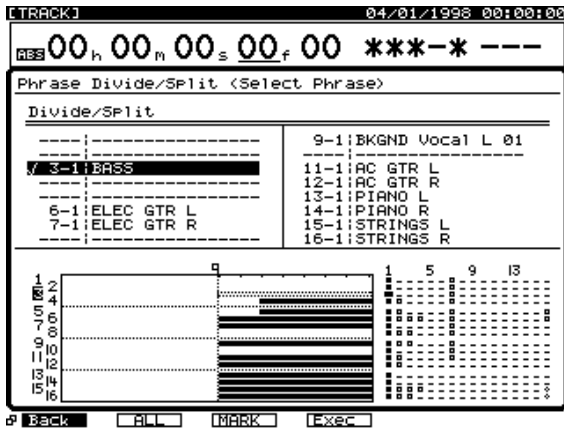

7. Press [F1 (Back)].
8. Use [▲][▼][◀][▶] to move the cursor, and use the TIME/VALUE dial to set the parameters.

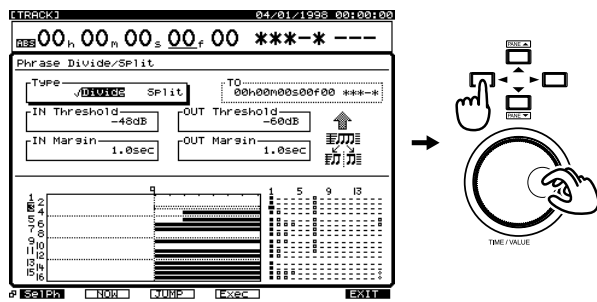

Type

Select how the phrase will be divided. In this case, select “Divide.”

- Divide:** Automatically divide the phrase into two or more phrases.
- Split:** Manually divide the phrase into two parts (the same as Ver. 1.00).

IN Threshold

Specify the volume (-84—6 dB) that will be used when searching for the point at which the phrase begins to sound. The VS-1680 will search for a point that exceeds this level.

IN Margin

Specify the length of time (0.1–9.9 sec) that will be preserved before reaching the “IN Threshold.”

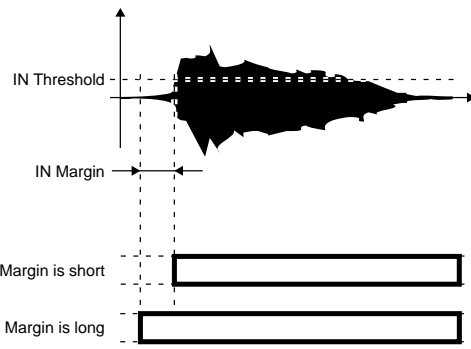

OUT Threshold

Specify the volume (-84—6 dB) that will be used when searching for the point at which the phrase stops sounding. The VS-1680 will search for a point that falls below this level.

OUT Margin

Specify the length of time (0.1–9.9 sec) that will be preserved after reaching the “OUT Threshold.”

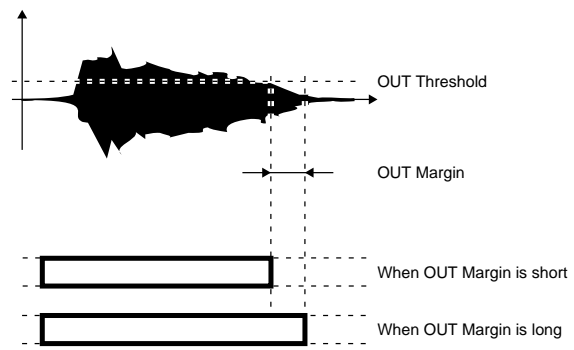

9. Press [F4 (Exec)].
10. When the display indicates “Complete,” press [PLAY (DISPLAY)]. You will return to Play condition.

Dividing a phrase into two parts (Phrase Split)

This operation divides a phrase into two parts at the specified location (time) in the time axis.

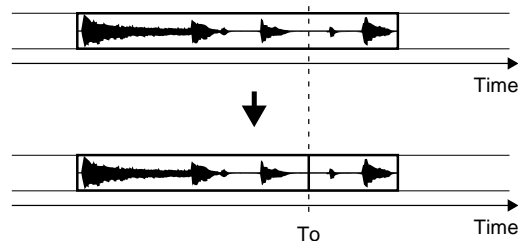

1. Press [PLAY (DISPLAY)].
2. Hold down [SHIFT] and press [F2 (TRACK)].
3. Press [F1 (Tr/Ph)] so that the Phrase Edit menu appears.
4. Press [PAGE] so that [F2] indicates "Split," and then press [F2 (Split)].

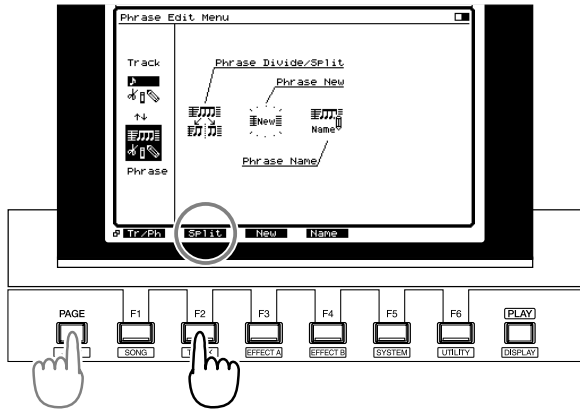

5. Press [F1 (SelPh)].
6. Press the [STATUS] button of the phrase that you wish to split. The STATUS indicator will light in red. Alternatively, you can use [▲] [▼] [◀] [▶] to move the cursor to the phrase that you wish to split, and press [F3 (MARK)] or [YES].

MEMO

By pressing [F2 (ALL)] you can mark or unmark all phrases simultaneously.

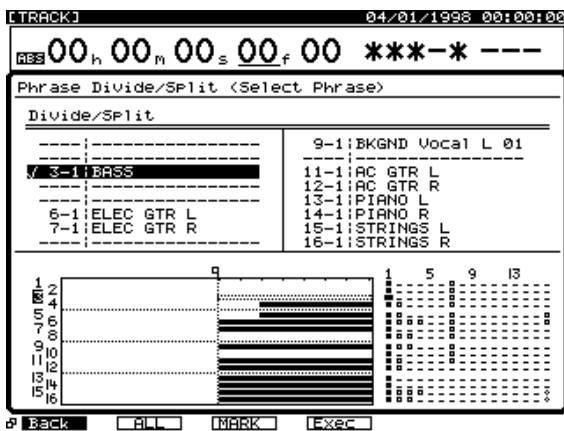

7. Press [F1 (Back)].
8. Use [▲] [▼] [◀] [▶] to move the cursor, and use the TIME/VALUE dial to set the parameters.

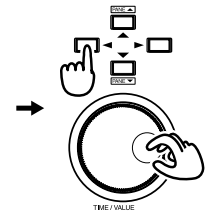
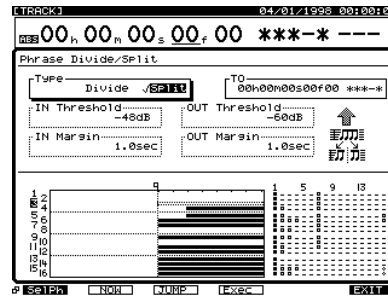

Type

Select how the phrase will be divided. In this case, select "Split."

Divide: Automatically divide the phrase into two or more phrases.

Split: Manually divide the phrase into two parts (the same as Ver. 1.00).

To (to point)

Specify the time location at which the phrase will be split.

9. Press [F4 (Exec)].
10. When the display indicates "Complete," press [PLAY (DISPLAY)]. You will return to Play condition.

Using the MONITOR knob to adjust the pan (MONITOR knob + [SELECT])

You can use the MONITOR knob to directly adjust the pan (or balance) of the specified channel.

1. Press [PLAY (DISPLAY)].
2. Hold down the [SELECT (CH EDIT)] button for the channel whose pan you wish to adjust, and adjust the MONITOR knob.

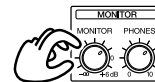

+

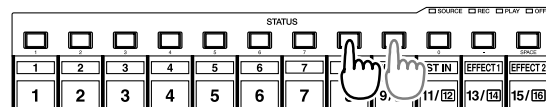

NOTE

If you rotate the MONITOR knob without pressing [SELECT], you will adjust the volume level. If you are attempting to adjust pan and inadvertently rotate the MONITOR knob toward the right without pressing [SELECT], high-volume sound capable of damaging your amp or speakers could be output.

MEMO

When you release [SELECT] after adjusting the pan, the edit screen of that channel may appear, but the MONITOR knob will adjust the pan only for the channel whose [SELECT] button is being pressed. For example even when the edit screen for track 1 is displayed, rotating the MONITOR knob while holding down the track 2 [SELECT] button will adjust the track 2 pan.

Linking the faders of two or more channels (Fader Group)

The faders of two or more channels (inputs/tracks) can now be assigned to groups, so that when the fader of any channel is operated, the fader levels (volume levels) of all channels in that group will be adjusted as well.

When fader group settings have been made, you can adjust the overall volume of a group while preserving the volume balance of the channels included in that group.

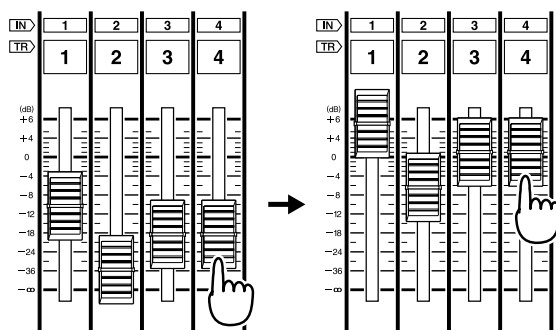

An image of fader group (Faders cannot be moved.)

1. Press [SELECT (CH EDIT)] for the channel (input/track) you wish to assign to a fader group.

2. Press [PAGE] so that [F4] indicates "Group," and then press [F4 (Group)].

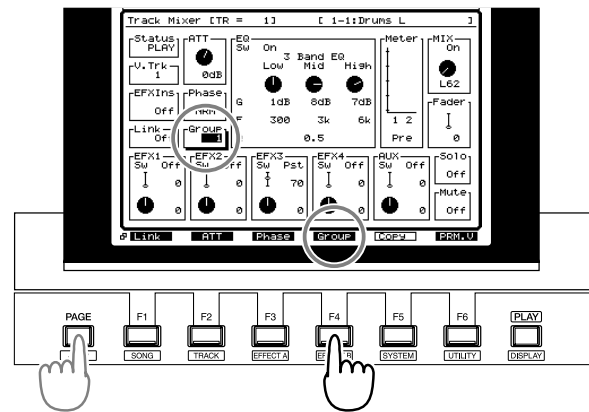

3. Press [F6 (PRM.V)].
4. Use [▲] [▼] [◀] [▶] to move the cursor, and use the TIME/VALUE dial to set the parameters.

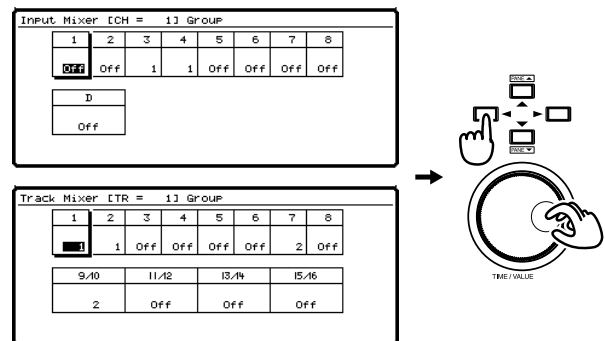

Group

Select the group (1–8) to which you wish to assign the fader. Channels for which the same number is selected will be assigned to the same group. Moving any fader within the group will adjust all faders of that group.

If you select "Off," the fader will not be assigned to any group (normal operation).

5. Press [PLAY (DISPLAY)]. You will return to Play condition.

Copying mixer settings

You can copy mixer settings (equalizer, level) from another channel to the channel currently shown in the Channel Edit page.

The following settings can be copied.

Equalizer

EQ low freq.

EQ low gain

EQ mid freq.

EQ mid gain

EQ mid Q

EQ high freq.

EQ high gain

Level

ATT

Phase

EFX1 insert send level

EFX1 insert return level

EFX2 insert send level

EFX2 insert return level

EFX3 insert send level

EFX3 insert return level

EFX4 insert send level

EFX4 insert return level

Fader

MASTER send pan

EFX1 send level

EFX1 send pan

EFX2 send level

EFX2 send pan

EFX3/AUX1 send level

EFX3/AUX1 send pan

EFX4/AUX2 send level

EFX4/AUX2 send pan

AUX/AUX3 send level

AUX/AUX3 send pan

1. Press [CH EDIT (SELECT)] for the copy-destination channel.

2. Press [PAGE] so that [F5] indicates "Copy," and then press [F5 (Copy)].

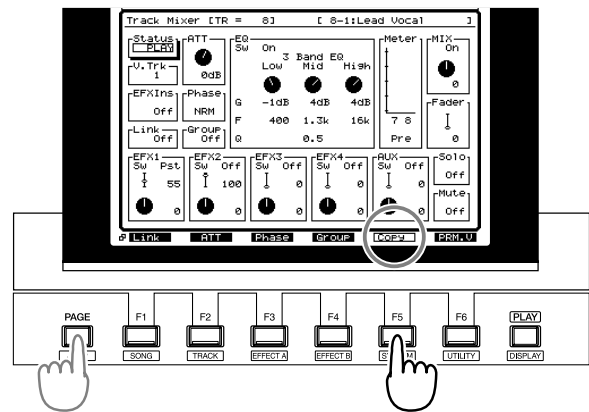

3. Use the TIME/VALUE dial to select the copy-source channel.

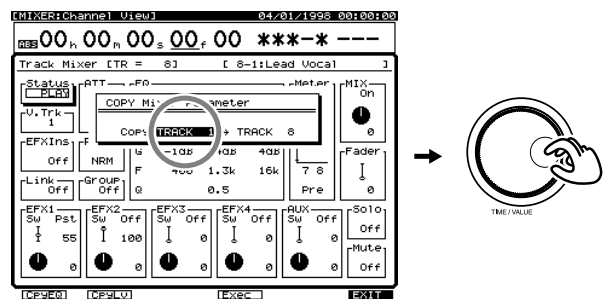

NOTE

If the Channel Link setting is OFF for the copy-destination channel, the Channel Link setting of the copy-source channel will be considered as OFF even though it may actually be ON, and only the settings of individual channels will be copied. Similarly, when Channel Link is ON for the copy-destination channel, Channel Link of the copy-source channel will be considered to be ON even though it may actually be OFF, and the settings of both channels will be copied.

4. Use the function buttons to select the settings that will be copied.

[F1 (CpyEQ)]: Copy only the equalizer settings.

[F2 (CpyLv)]: Copy only the level settings.

[F4 (Exec) or [ENTER (YES)]:

Copy both the equalizer and level settings.

[F6 (EXIT) or [EXIT (NO)]:

Exit the window without copying.

5. When the data has been copied, the display will indicate "Complete." Press [PLAY (DISPLAY)].

Shift Lock on/off ([SHIFT]+[YES])

It is now possible to control the Shift Lock switch (which temporarily keeps [SHIFT] activated while it is not actually pressed) without opening the System Parameter window (VS-1680 Owner's Manual, p. 187).

1. Press [PLAY (DISPLAY)].
2. Hold down [SHIFT] and press [YES].

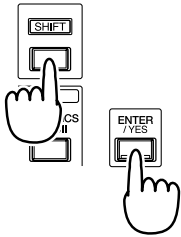

3. Thereafter, each time you hold down [SHIFT] and press [YES], Shift Lock can be toggled on/off.

MEMO

When Shift Lock is OFF, the SHIFT indicator will light only while you continue pressing [SHIFT]. When Shift Lock is ON, the SHIFT indicator will light, or go out each time you press [SHIFT]. [SHIFT] is active when the SHIFT indicator is lit.

Removing direct current offset from the mix bus

Direct current offset on the mix bus can be removed. For example, in some cases the level meters of a device (mixer etc.) connected to the output of the VS-1680 may move even though no sound is being output. This is caused by a direct current offset on the mix bus (MASTER output, etc.). This component can be removed.

1. Press [PLAY (DISPLAY)].
2. Hold down [SHIFT] and press [F5 (SYSTEM)].
3. Make sure that the System menu is displayed. If not, press [F6 (EXIT)].
4. Press [PAGE] so that [F2] indicates "GLOBL," and then press [F2 (GLOBL)].

5. Use [▲][▼][◀][▶] to move the cursor to "DC Cut," and use the TIME/VALUE dial to make the setting.
If "DC Cut" is not shown, press [F2 (Prm2)], and use the TIME/VALUE dial to make the setting.

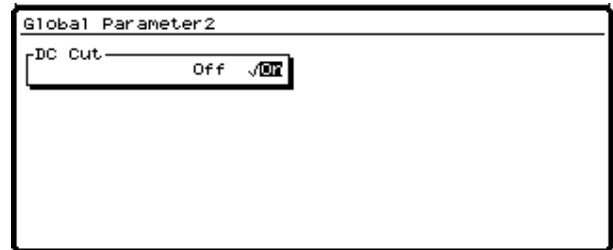

DC Cut

When this is turned "On," any direct current offset on the mix bus will be removed before output.

6. Press [PLAY (DISPLAY)].

Enhancements to the display and specifications

Checking inserted effects (Icon and Patch Name display)

Effects that have been inserted into channels/tracks can now be confirmed through icons and patch names.

1. Press [SELECT] for the channel to which you wish to apply an effect.
2. Press [PAGE] so that [F1] indicates "Ef1In," and then press [F1 (Ef1In)].

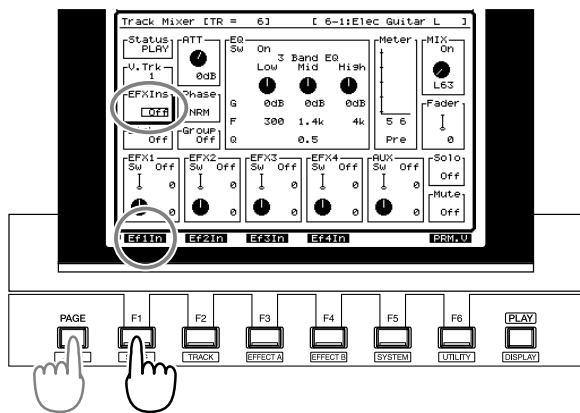

MEMO

If you wish to insert EFX2-4, press [F2 (Ef2In)], [F3 (Ef3In)], or [F4 (Ef4In)] respectively.

3. Press [YES].
4. Use the TIME/VALUE dial to select how the effect will be inserted. At this time you can view the effect as an icon and as a patch name (up to ten characters).

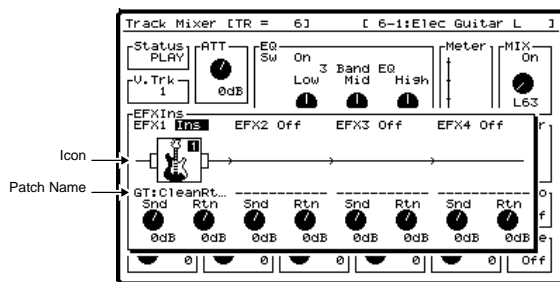

5. Press [PLAY (DISPLAY)]. You will return to Play condition.

Checking effects that cannot be used in other channels (Effect insertion location display)

When there are effects which cannot be used for a channel/track (because they are inserted into another channel/track), the location of the effect inserted is now displayed.

1. Press [SELECT] for the channel to which you wish to apply an effect.
2. Press [PAGE] so that [F1] indicates "Ef1In," and then press [F1 (Ef1In)].

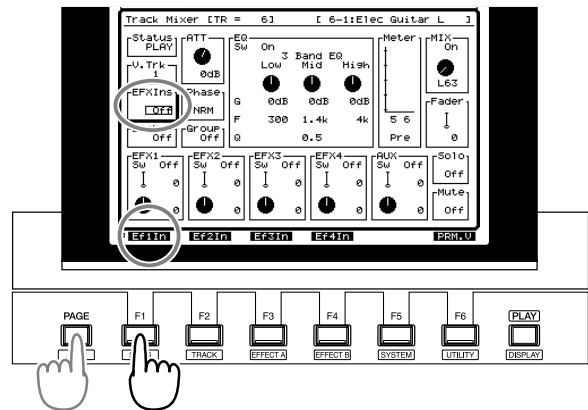

MEMO

If you wish to insert EFX2-4, press [F2 (Ef2In)], [F3 (Ef3In)], or [F4 (Ef4In)] respectively.

3. Press [YES].
4. Use the TIME/VALUE dial to select how the effect will be inserted. At this time, you can view the effects that are inserted into other channels/tracks.

When EFX1 is used in Track 6

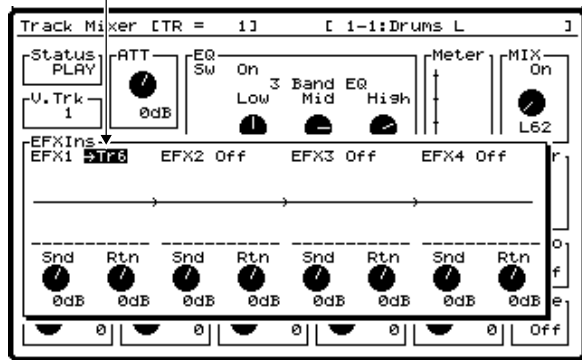

5. Press [PLAY (DISPLAY)]. You will return to Play condition.

Switching the Song Select window (List display)

The Song Select window can now be viewed not only as icons but also as a list. You can also see the size of the song, and the date and time at which it was created.

1. Press [PLAY (DISPLAY)].
2. Hold down [SHIFT] and press [F1 (SONG)].
3. Press [F1 (Sel)].
4. At this time, pressing [F1] will alternate between the icon display and the list display.

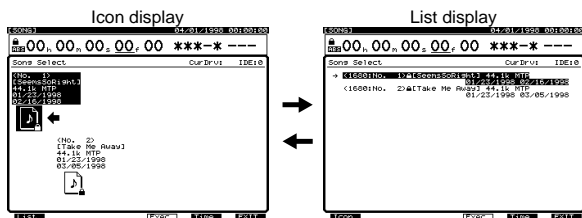

Also, you can press [F5] to cycle the displayed contents between date of creation → time of creation → size.

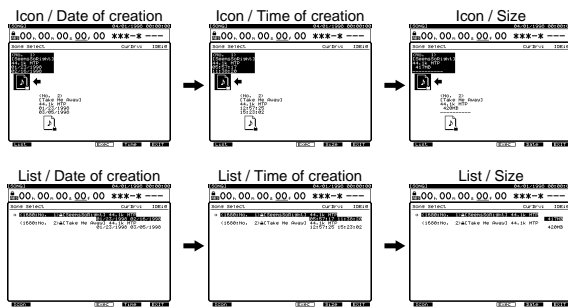

5. Use the TIME/VALUE to move the cursor to the song that you wish to select.
6. Press [F4 (Exec)].
7. Press [YES].
8. The display will ask “STORE Current?” If you wish to save the current song, press [YES]. If not, press [NO].



9. After the song is selected, you are returned to Play condition.

Easy Routing

Additional template (Mastering)

A “Mastering” template for mixdown has been added to the Easy Routing templates.

1. Press [EZ ROUTING].
2. Use [▲][▼][◀][▶] or the TIME/VALUE dial to move the cursor to “Mastering.”

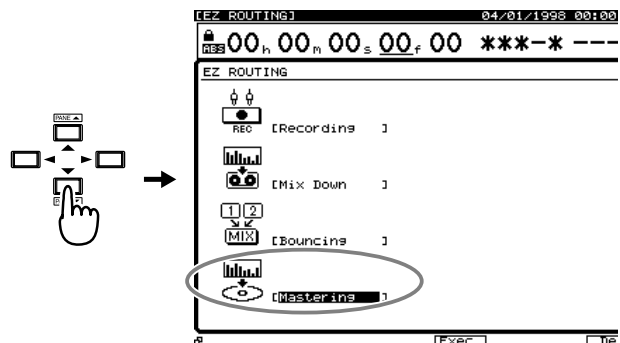

3. Press [F4 (Exec)]. Alternatively, press [PAGE] so that [F4] indicates "Exec," and then press [F4 (Exec)].



4. Press [F4 (Exec)] once again.
5. A message will ask for confirmation. Press [YES]. The mastering template will be recalled. To cancel, press [NO].



At this time, the main settings will be as follows.

- Inputs 1-8** :Master out
- Tracks 1-15/16** :Playback
- Mastering tracks** :Off
- Effect 1** :Mastering tool kit (insert)

6. You are returned to Play condition.

MEMO

If you wish to modify the mastering template, refer to "Storing Routings as a Single List (Template)" (VS-1680 Owner's Manual, p. 41).

Immediate application of step-edited changes

Changes you make to Easy Routing settings by step-editing (recording, mixdown, bouncing) will now be applied immediately to the actual routing.

For example if you raise or lower the level of a channel by step editing, the volume will now change accordingly. The same is true for pan, output destination, effects or AUX levels. This lets you hear the actual result while you set the routing.

MEMO

Previously, you were asked "Apply this Routing?" when you had completed your routing settings, and the routing settings you made were actually applied only when you then pressed [YES].

Settings not stored in a scene (Monitor Level)

Monitor level (the location of the MONITOR knob) is no longer stored in a scene. Even when you recall a stored scene, the monitor level will be determined by the current position of the MONITOR knob.

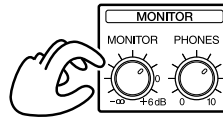

Master Send switch display has been changed (Pan → MIX)

The Master Send switch display has been changed from "Pan" to "MIX." When reading the previous Owner's Manual (including Quick Start and Appendices), please read any reference to [F1 (Pan)] as [F1 (MIX)].

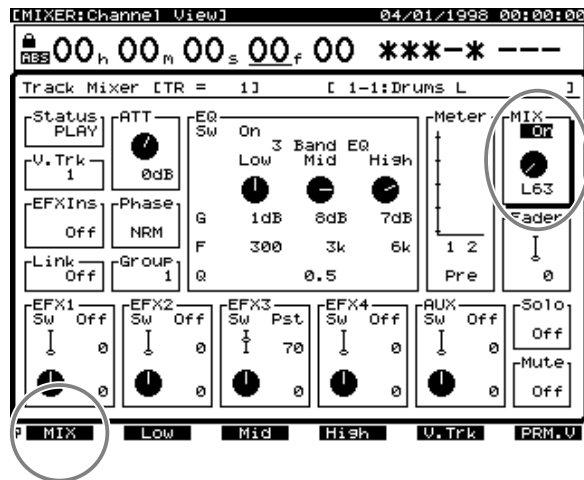

Index

Symbols

+Verify 28

A

After Rec (after recording) 9

Alarm function 6

Automix 19

C

CD Speed 26, 28, 29

Channel Link 37

Copy 20

D

Destination Mark 21

Destination Target 21

Disc At Once 25

E

Easy Routing 6, 40

Effect expansion board 11

EFX1 (effect insert switch 1) 12

Erase 19

Erase All Songs 29

Expand 23, 24

External recorder 8

F

Finalize 25, 26

G

Gradation 21

Gradation Curve 22

Group 36

I

Icon display 40

IN Margin 34

IN Threshold 34

L

License agreement 27

List display 40

M

Marker 9

Marker Add 22

Master Send switch 41

Mastering 40

Mastering Room 8

Mixdown 8

MONITOR knob 35

Monitor level 41

O

OUT Margin 34

OUT Threshold 34

P

Phrase Copy 30

Phrase Delete 30

Phrase Move 30

Phrase New 30

Phrase Split 34

Playlist 11

R

Recording mode 8

Rtn (effect return level) 12

S

Sampling rate 8

Shift 24

Snd (effect send level) 12

Source Song 27, 29

Speed 27, 28

Status 9, 10, 12

Step-editing 41

T

Take 31

Target 20, 21, 24

Threshold 24

To 31

To (to point) 35

Track 31

Track At Once 25

Track number marker 9

Trim In 30

Trim Out 30

Trk L (track L) 9

Trk R (track R) 9

Type 34, 35

U

User patch 6

User setting 6

V

Value 22

VS-1680 V-XPANDED 6

VS8F-2 11

V-XPANDED system program Zip disk 6

W

Write Method 26

Z

Zip drive 6

Information

When you need repair service, call your nearest Roland Service Center or authorized Roland distributor in your country as shown below.

AFRICA

EGYPT

Al Fanny Trading Office
P.O. Box 2904,
El Horrieh Heliopolis, Cairo,
EGYPT
TEL: (02) 4185531

REUNION

Maison FO - YAM Marcel
25 Rue Jules MermanZL
Chaudron - BP79 97491
Ste Clotilde REUNION
TEL: 28 29 16

SOUTH AFRICA

**That Other Music Shop
(PTY) Ltd.**

11 Melle Street (Cnr Melle and
Juta Street)
Braamfontein 2001
Republic of SOUTH AFRICA
TEL: (011) 403 4105

Paul Bothner (PTY) Ltd.
17 Werdmuller Centre Claremont
7700
Republic of SOUTH AFRICA

P.O. Box 23032
Claremont, Cape Town
SOUTH AFRICA, 7735
TEL: (021) 64 4030

ASIA

CHINA

**Beijing Xinghai Musical
Instruments Co., Ltd.**
6 Huangmchang Chao Yang
District, Beijing, CHINA
TEL: (010) 6774 7491

HONG KONG

**Tom Lee Music Co., Ltd.
Service Division**
22-32 Pun Shan Street, Tsuen
Wan, New Territories,
HONG KONG
TEL: 2415 0911

INDIA

Rivera Digitec (India) Pvt. Ltd.
409, Nirman Kendra Mahalaxmi
Flats, Compound
off. Dr. Edwin Moses Road,
Mumbai 400011, INDIA
TEL: (022) 498 3079

INDONESIA

PT Galestra Inti
Kompleks Perkantoran
Duta Merlin Blok E No.6—7
Jl. Gajah Mada No.3—5,
Jakarta 10130,
INDONESIA
TEL: (021) 6335416

KOREA

Cosmos Corporation
Service Station
261 2nd Floor Nak-Won Arcade
Jong-Ro ku, Seoul, KOREA
TEL: (02) 742 8844

MALAYSIA

Bentley Music SDN BHD
140 & 142, Jalan Bukit Bintang
55100 Kuala Lumpur, MALAYSIA
TEL: (03) 2443333

PHILIPPINES

G.A. Yupangco & Co. Inc.
339 Gil J. Puyat Avenue
Makati, Metro Manila 1200,
PHILIPPINES
TEL: (02) 899 9801

SINGAPORE

Swee Lee Company
150 Sims Drive,
SINGAPORE 387381
TEL: 748-1669

CRISTOFORI MUSIC PTE LTD

Blk 3014, Bedok Industrial Park E,
#02-2148, SINGAPORE 489980
TEL: 243 9555

TAIWAN

**ROLAND TAIWAN
ENTERPRISE CO., LTD.**
Room 5, 9fl. No. 112 Chung Shan
N.Road Sec.2, Taipei, TAIWAN,
R.O.C.
TEL: (02) 2561 3339

THAILAND

Theera Music Co., Ltd.
330 Verng NakornKasem, Soi 2,
Bangkok 10100, THAILAND
TEL: (02) 2248821

VIETNAM

Saigon Music
138 Tran Quang Khai St.,
District 1
Ho chi minh City
VIETNAM
TEL: (8) 844-4068

AUSTRALIA/ NEW ZEALAND

AUSTRALIA

**Roland Corporation
Australia Pty. Ltd.**
38 Campbell Avenue
Dee Why West. NSW 2099
AUSTRALIA
TEL: (02) 9982 8266

NEW ZEALAND

Roland Corporation (NZ) Ltd.
97 Mt. Eden Road, Mt. Eden,
Auckland 3, NEW ZEALAND
TEL: (09) 3098 715

CENTRAL/LATIN AMERICA

ARGENTINA

Instrumentos Musicales S.A.
Florida 656 2nd Floor
Office Number 206A
Buenos Aires
ARGENTINA, CP1005
TEL: (54-11) 4-393-6057

BRAZIL

Roland Brasil Ltda.
R. Coronel Octaviano da Silveira
203 05522-010
Sao Paulo BRAZIL
TEL: (011) 843 9377

CHILE

Comercial Fancy S.A.
Avenida Rancagua #0330
Providencia Santiago, CHILE
TEL: 56-2-373-9100

EL SALVADOR

OMNI MUSIC
75 Avenida Notre y Alameda
Juan Pablo 2 No. 4010
San Salvador, EL SALVADOR
TEL: (503) 262-0788

MEXICO

Casa Veerkamp, s.a. de c.v.
Av. Toluca No. 323 Col. Olivar de
los Padres 01780 Mexico D.F.
MEXICO
TEL: (525) 668 04 80

**La Casa Wagner de
Guadalajara s.a. de c.v.**
Av. Corona No. 202 S.J.
Guadalajara, Jalisco Mexico
C.P.44100 MEXICO
TEL: (03) 613 1414

PANAMA

Productos Superiores, S.A.
Apartado 655 - Panama 1
REP. DE PANAMA
TEL: (507) 270-2200

URUGUAY

Todo Musica
Cuareim 1488, Montevideo,
URUGUAY
TEL: 5982-924-2335

VENEZUELA

Musiland Digital C.A.
Av. Francisco de Miranda,
Centro Parque de Cristal, Nivel
C2 Local 20 Caracas
VENEZUELA
TEL: (02) 285 9218

EUROPE

AUSTRIA

Roland Austria GES.M.B.H.
Siemensstrasse 4, P.O. Box 74,
A-6063 RUM, AUSTRIA
TEL: (0512) 26 44 260

BELGIUM/HOLLAND/ LUXEMBOURG

Roland Benelux N. V.
Houtstraat 3 B-2260 Oevel
(Westerlo) BELGIUM
TEL: (014) 575811

DENMARK

Roland Scandinavia A/S
Langebrogade 6 Post Box 1937
DK-1023 Copenhagen K.
DENMARK
TEL: 32 95 3111

FRANCE

Roland France SA
4, Rue Paul Henri SPAAK
Parc de l'Esplanade F 77 462 St.
Thibault Lagny Cedex FRANCE
TEL: 01 600 73 500

FINLAND

**Roland Scandinavia As,
Filial Finland**
Lauttasaarentie 54 B
Fin-00201 Helsinki, FINLAND
TEL: (9) 682 4020

GERMANY

**Roland Elektronische
Musikinstrumente
Handelsgesellschaft mbH.**
Oststrasse 96, 22844 Norderstedt,
GERMANY
TEL: (040) 52 60090

GREECE

V. Dimitriadis & Co. Ltd.
20, Alexandras St. & Bououlinas
54 St. 106 82 Athens, GREECE
TEL: (01) 8227 775

HUNGARY

Intermusica Ltd.
Warehouse Area 'DEPO' Pf.83
H-2046 Torokbalint, HUNGARY
TEL: (23) 511011

IRELAND

Roland Ireland
Audio House, Belmont Court,
Donnybrook, Dublin 4,
Republic of IRELAND
TEL: (01) 2603501

ITALY

Roland Italy S. p. a.
Viale delle Industrie, 8
20020 Arese Milano, ITALY
TEL: (02) 937-78300

NORWAY

**Roland Scandinavia Avd.
Kontor Norge**
Lilleakerveien 2 Postboks 95
Lilleaker N-0216 Oslo
NORWAY
TEL: 273 0074

POLAND

P. P. H. Brzostowicz
UL. Gibraltarska 4.
PL-03664 Warszawa POLAND
TEL: (022) 679 44 19

PORTUGAL

**Tecnologias Musica e Audio,
Roland Portugal, S.A.**
RUA SANTA CATARINA
131 - 4000 Porto -PORTUGAL
TEL: (02) 208 44 56

ROMANIA

FBS LINES
Plata Libertatii 1.
RO-4200 Cheorgheni
TEL: (066) 164-609

RUSSIA

Slami Music Company
Sadajava-Triumfalnaja st., 16
103006 Moscow, RUSSIA
TEL: 095 209 2193

SPAIN

**Roland Electronics
de España, S. A.**
Calle Bolivia 239 08020 Barcelona,
SPAIN
TEL: (93) 308 1000

SWEDEN

**Roland Scandinavia A/S
SWEDISH SALES OFFICE**
Danvik Center 28, 2 tr.
S-131 30 Nacka SWEDEN
TEL: (08) 702 0020

SWITZERLAND

**Roland (Switzerland) AG
Musitronic AG**
Gerberstrasse 5, CH-4410 Liestal,
SWITZERLAND
TEL: (061) 921 1615

UKRAINE

TIC-TAC
Mira Str. 19/108
P.O. Box 180
295400 Munkachevo, UKRAINE
TEL: (03131) 414-40

UNITED KINGDOM

Roland (U.K.) Ltd.
Atlantic Close, Swansea
Enterprise Park SWANSEA
SA7 9FJ,
UNITED KINGDOM
TEL: (01792) 700139

MIDDLE EAST

BAHRAIN

Moon Stores
Bab Al Bahrain Road,
P.O. Box 20077
State of BAHRAIN
TEL: 211 005

CYPRUS

Radex Sound Equipment Ltd.
17 Diagorou St., P.O. Box 2046,
Nicosia CYPRUS
TEL: (02) 453 426

ISRAEL

**Halilit P. Greenspoon &
Sons Ltd.**
8 Retzif Fa'aliya Hashnya St.
Tel-Aviv-Yaho ISRAEL
TEL: (03) 6823666

JORDAN

AMMAN Trading Agency
Prince Mohammed St. P.O. Box
825 Amman 11118 JORDAN
TEL: (06) 4641200

KUWAIT

Easa Husain Al-Yousifi
P.O. Box 126 Safat 13002
KUWAIT
TEL: 5719499

LEBANON

A. Chahine & Fils
P.O. Box 16-5857 Gergi Zeidan St.
Chahine Building, Achrafieh
Beirut, LEBANON
TEL: (01) 335799

OMAN

**OHI Electronics & Trading
Co. LLC**
P.O. Box 889 Muscat
Sultanate of OMAN
TEL: 959085

QATAR

Badie Studio & Stores
P.O. Box 62,
DOHA QATAR
TEL: 423554

SAUDI ARABIA

**aDawlah Universal
Electronics APL**
P.O. Box 2154 ALKHOBAR 31952,
SAUDI ARABIA
TEL: (03) 898 2081

SYRIA

**Technical Light & Sound
Center**
Khaled Ibn Al Walid St.
P.O. Box 13520
Damascus - SYRIA
TEL: (011) 2235 384

TURKEY

**Barkat Muzik aletleri ithalat
ve ihracat limited ireketi**
Siraselvler Cad. Guney Ishani No.
86/6 Taksim, Istanbul TURKEY
TEL: (0212) 2499324

U.A.E.

**Zak Electronics & Musical
Instruments Co.**
Zabeel Road, Al Sherooq Bldg.,
No. 14, Grand Floor DUBAI
U.A.E.
P.O. Box 8050 DUBAI, U.A.E.
TEL: (04) 360715

NORTH AMERICA

CANADA

**Roland Canada Music Ltd.
(Head Office)**
5480 Parkwood Way Richmond
B. C., V6V 2M4 CANADA
TEL: (0604) 270 6626

Roland Canada Music Ltd.

(Toronto Office)
Unit 2, 109 Woodbine Downs
Blvd, Etobicoke, ON
M9W 6Y1 CANADA
TEL: (0416) 213 9707

U. S. A.

Roland Corporation U.S.
7200 Dominion Circle
Los Angeles, CA. 90040-3696,
U. S. A.
TEL: (0323) 685 5141