

PERCUSSION SOUND MODULE **TD-20**

Owner's Manual

We'd like to take a moment to thank you for purchasing the Roland Percussion Sound Module TD-20.

Before using this unit, carefully read the sections entitled: "IMPORTANT SAFETY INSTRUCTIONS" (p. 2), "USING THE UNIT SAFELY" (p. 3), and "IMPORTANT NOTES" (p. 5). These sections provide important information concerning the proper operation of the unit. Additionally, in order to feel assured that you have gained a good grasp of every feature provided by your new unit, Owner's manual should be read in its entirety. The manual should be saved and kept on hand as a convenient reference.





- * CompactFlash and are trademarks of SanDisk Corporation and licensed by CompactFlash association.
- * Roland Corporation is an authorized licensee of the CompactFlash™ and CF logo () trademarks.
- * Fugue © 2004 Kyoto Software Research, Inc. All rights reserved.



Copyright © 2004 ROLAND CORPORATION

All rights reserved. No part of this publication may be reproduced in any form without the written permission of ROLAND CORPORATION.

WARNING: To reduce the risk of fire or electric shock, do not expose this apparatus to rain or moisture.

  
ATTENTION: RISQUE DE CHOC ELECTRIQUE NE PAS OUVRIR
CAUTION: TO REDUCE THE RISK OF ELECTRIC SHOCK, DO NOT REMOVE COVER (OR BACK). NO USER-SERVICEABLE PARTS INSIDE. REFER SERVICING TO QUALIFIED SERVICE PERSONNEL.



The lightning flash with arrowhead symbol, within an equilateral triangle, is intended to alert the user to the presence of uninsulated "dangerous voltage" within the product's enclosure that may be of sufficient magnitude to constitute a risk of electric shock to persons.



The exclamation point within an equilateral triangle is intended to alert the user to the presence of important operating and maintenance (servicing) instructions in the literature accompanying the product.

INSTRUCTIONS PERTAINING TO A RISK OF FIRE, ELECTRIC SHOCK, OR INJURY TO PERSONS.

IMPORTANT SAFETY INSTRUCTIONS SAVE THESE INSTRUCTIONS

WARNING - When using electric products, basic precautions should always be followed, including the following:

1. Read these instructions.
2. Keep these instructions.
3. Heed all warnings.
4. Follow all instructions.
5. Do not use this apparatus near water.
6. Clean only with a dry cloth.
7. Do not block any of the ventilation openings. Install in accordance with the manufacturers instructions.
8. Do not install near any heat sources such as radiators, heat registers, stoves, or other apparatus (including amplifiers) that produce heat.
9. Do not defeat the safety purpose of the polarized or grounding-type plug. A polarized plug has two blades with one wider than the other. A grounding type plug has two blades and a third grounding prong. The wide blade or the third prong are provided for your safety. If the provided plug does not fit into your outlet, consult an electrician for replacement of the obsolete outlet.
10. Protect the power cord from being walked on or pinched particularly at plugs, convenience receptacles, and the point where they exit from the apparatus.
11. Only use attachments/accessories specified by the manufacturer.
12. Unplug this apparatus during lightning storms or when unused for long periods of time.
13. Refer all servicing to qualified service personnel. Servicing is required when the apparatus has been damaged in any way, such as power-supply cord or plug is damaged, liquid has been spilled or objects have fallen into the apparatus, the apparatus has been exposed to rain or moisture, does not operate normally, or has been dropped.

For the U.K.

WARNING: THIS APPARATUS MUST BE EARTHED

IMPORTANT: THE WIRES IN THIS MAINS LEAD ARE COLOURED IN ACCORDANCE WITH THE FOLLOWING CODE.
GREEN-AND-YELLOW: EARTH, BLUE: NEUTRAL, BROWN: LIVE

As the colours of the wires in the mains lead of this apparatus may not correspond with the coloured markings identifying the terminals in your plug, proceed as follows:

The wire which is coloured GREEN-AND-YELLOW must be connected to the terminal in the plug which is marked by the letter E or by the safety earth symbol  or coloured GREEN or GREEN-AND-YELLOW.



The wire which is coloured BLUE must be connected to the terminal which is marked with the letter N or coloured BLACK.

The wire which is coloured BROWN must be connected to the terminal which is marked with the letter L or coloured RED.







USING THE UNIT SAFELY

INSTRUCTIONS FOR THE PREVENTION OF FIRE, ELECTRIC SHOCK, OR INJURY TO PERSONS

About  WARNING and  CAUTION Notices

 WARNING	Used for instructions intended to alert the user to the risk of death or severe injury should the unit be used improperly.
 CAUTION	Used for instructions intended to alert the user to the risk of injury or material damage should the unit be used improperly. * Material damage refers to damage or other adverse effects caused with respect to the home and all its furnishings, as well to domestic animals or pets.

About the Symbols

	The  symbol alerts the user to important instructions or warnings. The specific meaning of the symbol is determined by the design contained within the triangle. In the case of the symbol at left, it is used for general cautions, warnings, or alerts to danger.
	The  symbol alerts the user to items that must never be carried out (are forbidden). The specific thing that must not be done is indicated by the design contained within the circle. In the case of the symbol at left, it means that the unit must never be disassembled.
	The  symbol alerts the user to things that must be carried out. The specific thing that must be done is indicated by the design contained within the circle. In the case of the symbol at left, it means that the power-cord plug must be unplugged from the outlet.

ALWAYS OBSERVE THE FOLLOWING



WARNING

- Before using this unit, make sure to read the instructions below, and the Owner's Manual. 

- Connect mains plug of this model to a mains socket outlet with a protective earthing connection. 

- Do not open or perform any internal modifications on the unit. (The only exception would be where this manual provides specific instructions which should be followed in order to put in place user-installable options; see p. 86, p. 88.) 

- Do not attempt to repair the unit, or replace parts within it (except when this manual provides specific instructions directing you to do so). Refer all servicing to your retailer, the nearest Roland Service Center, or an authorized Roland distributor, as listed on the "Information" page. 

- Never use or store the unit in places that are:
 - Subject to temperature extremes (e.g., direct sunlight in an enclosed vehicle, near a heating duct, on top of heat-generating equipment); or are 
 - Damp (e.g., baths, washrooms, on wet floors); or are 
 - Humid; or are
 - Exposed to rain; or are
 - Dusty; or are
 - Subject to high levels of vibration.

- Make sure you always have the unit placed so it is level and sure to remain stable. Never place it on stands that could wobble, or on inclined surfaces. 



WARNING

- The unit should be connected to a power supply only of the type described in the operating instructions, or as marked on the bottom of unit. 

- Use only the attached power-supply cord. Also, the supplied power cord must not be used with any other device. 

- Do not excessively twist or bend the power cord, nor place heavy objects on it. Doing so can damage the cord, producing severed elements and short circuits. Damaged cords are fire and shock hazards! 

- This unit, either alone or in combination with an amplifier and headphones or speakers, may be capable of producing sound levels that could cause permanent hearing loss. Do not operate for a long period of time at a high volume level, or at a level that is uncomfortable. If you experience any hearing loss or ringing in the ears, you should immediately stop using the unit, and consult an audiologist. 

- Do not allow any objects (e.g., flammable material, coins, pins); or liquids of any kind (water, soft drinks, etc.) to penetrate the unit. 

⚠ WARNING

- Immediately turn the power off, remove the power cord from the outlet, and request servicing by your retailer, the nearest Roland Service Center, or an authorized Roland distributor, as listed on the “Information” page when:
 - The power-supply cord, or the plug has been damaged; or
 - If smoke or unusual odor occurs
 - Objects have fallen into, or liquid has been spilled onto the unit; or
 - The unit has been exposed to rain (or otherwise has become wet); or
 - The unit does not appear to operate normally or exhibits a marked change in performance.
- In households with small children, an adult should provide supervision until the child is capable of following all the rules essential for the safe operation of the unit.
- Protect the unit from strong impact. (Do not drop it!)
- Do not force the unit’s power-supply cord to share an outlet with an unreasonable number of other devices. Be especially careful when using extension cords—the total power used by all devices you have connected to the extension cord’s outlet must never exceed the power rating (watts/ amperes) for the extension cord. Excessive loads can cause the insulation on the cord to heat up and eventually melt through.
- Before using the unit in a foreign country, consult with your retailer, the nearest Roland Service Center, or an authorized Roland distributor, as listed on the “Information” page.
- Always turn the unit off and unplug the power cord before attempting installation of the circuit board (SOUND & SYSTEM EXPANSION BOARD for TD-20).
- Do not put anything that contains water (e.g., flower vases) on this unit. Also, avoid the use of insecticides, perfumes, alcohol, nail polish, spray cans, etc., near the unit. Swiftly wipe away any liquid that spills on the unit using a dry, soft cloth.

⚠ CAUTION

- The unit should be located so that its location or position does not interfere with its proper ventilation.
- Always grasp only the plug on the power-supply cord when plugging into, or unplugging from, an outlet or this unit.
- At regular intervals, you should unplug the power plug and clean it by using a dry cloth to wipe all dust and other accumulations away from its prongs. Also, disconnect the power plug from the power outlet whenever the unit is to remain unused for an extended period of time. Any accumulation of dust between the power plug and the power outlet can result in poor insulation and lead to fire.
- Try to prevent cords and cables from becoming entangled. Also, all cords and cables should be placed so they are out of the reach of children.
- Never climb on top of, nor place heavy objects on the unit.
- Never handle the power cord or its plugs with wet hands when plugging into, or unplugging from, an outlet or this unit.
- Before moving the unit, disconnect the power plug from the outlet, and pull out all cords from external devices.
- Before cleaning the unit, turn off the power and unplug the power cord from the outlet.
- Whenever you suspect the possibility of lightning in your area, pull the plug on the power cord out of the outlet.
- Install only the specified circuit board (SOUND & SYSTEM EXPANSION BOARD for TD-20). Remove only the specified screws (p. 86, p. 88).
- Should you remove screws from the bottom panel of the unit (p. 17, p. 86, p. 88), keep them in a safe place out of children’s reach, so there is no chance of them being swallowed accidentally.

IMPORTANT NOTES

In addition to the items listed under “IMPORTANT SAFETY INSTRUCTIONS” and “USING THE UNIT SAFELY” on pages 2–4, please read and observe the following:

Power Supply

- Do not connect this unit to same electrical outlet that is being used by an electrical appliance that is controlled by an inverter (such as a refrigerator, washing machine, microwave oven, or air conditioner), or that contains a motor. Depending on the way in which the electrical appliance is used, power supply noise may cause this unit to malfunction or may produce audible noise. If it is not practical to use a separate electrical outlet, connect a power supply noise filter between this unit and the electrical outlet.
- Before connecting this unit to other devices, turn off the power to all units. This will help prevent malfunctions and/or damage to speakers or other devices.
- Although the LCD and LEDs are switched off when the POWER switch is switched off, this does not mean that the unit has been completely disconnected from the source of power. If you need to turn off the power completely, first turn off the POWER switch, then unplug the power cord from the power outlet. For this reason, the outlet into which you choose to connect the power cord’s plug should be one that is within easy reach and readily accessible.

Placement

- Using the unit near power amplifiers (or other equipment containing large power transformers) may induce hum. To alleviate the problem, change the orientation of this unit; or move it farther away from the source of interference.
- This device may interfere with radio and television reception. Do not use this device in the vicinity of such receivers.
- Noise may be produced if wireless communications devices, such as cell phones, are operated in the vicinity of this unit. Such noise could occur when receiving or initiating a call, or while conversing. Should you experience such problems, you should relocate such wireless devices so they are at a greater distance from this unit, or switch them off.
- Do not expose the unit to direct sunlight, place it near devices that radiate heat, leave it inside an enclosed vehicle, or otherwise subject it to temperature extremes. Excessive heat can deform or discolor the unit.

- When moved from one location to another where the temperature and/or humidity is very different, water droplets (condensation) may form inside the unit. Damage or malfunction may result if you attempt to use the unit in this condition. Therefore, before using the unit, you must allow it to stand for several hours, until the condensation has completely evaporated.

Maintenance

- For everyday cleaning wipe the unit with a soft, dry cloth or one that has been slightly dampened with water. To remove stubborn dirt, use a cloth impregnated with a mild, non-abrasive detergent. Afterwards, be sure to wipe the unit thoroughly with a soft, dry cloth.
- Never use benzine, thinners, alcohol or solvents of any kind, to avoid the possibility of discoloration and/or deformation.

Repairs and Data

- Please be aware that all data contained in the unit’s memory may be lost when the unit is sent for repairs. Important data should always be backed up on a DATA card, in another MIDI device (e.g., a sequencer), or written down on paper (when possible). During repairs, due care is taken to avoid the loss of data. However, in certain cases (such as when circuitry related to memory itself is out of order), we regret that it may not be possible to restore the data, and Roland assumes no liability concerning such loss of data.

Memory Backup

- This unit contains a battery which powers the unit’s memory circuits while the main power is off. When this battery becomes weak, the message shown below will appear in the display. Once you see this message, have the battery replaced with a fresh one as soon as possible to avoid the loss of all data in memory. To have the battery replaced, consult with your retailer, the nearest Roland Service Center, or an authorized Roland distributor, as listed on the “Information” page.

“Backup Battery Low!”

Additional Precautions

- Please be aware that the contents of memory can be irretrievably lost as a result of a malfunction, or the improper operation of the unit. To protect yourself against the risk of losing important data, we recommend that you periodically save a backup copy of important data you have stored in the unit's memory on a DATA card or in another MIDI device (e.g., a sequencer).
- Unfortunately, it may be impossible to restore the contents of data that was stored in the unit's memory, on a DATA card, or in another MIDI device (e.g., a sequencer) once it has been lost. Roland Corporation assumes no liability concerning such loss of data.
- Use a reasonable amount of care when using the unit's buttons, sliders, or other controls; and when using its jacks and connectors. Rough handling can lead to malfunctions.
- Never strike or apply strong pressure to the display.
- When connecting / disconnecting all cables, grasp the connector itself—never pull on the cable. This way you will avoid causing shorts, or damage to the cable's internal elements.
- A small amount of heat will radiate from the unit during normal operation.
- To avoid disturbing your neighbors, try to keep the unit's volume at reasonable levels. You may prefer to use headphones, so you do not need to be concerned about those around you (especially when it is late at night).
- Since sound vibrations can be transmitted through floors and walls to a greater degree than expected, take care not to allow such sound to become a nuisance to neighbors, especially at night and when using headphones. Although the drum pads and pedals are designed so there is a minimal amount of extraneous sound produced when they're struck, rubber heads tend to produce louder sounds compared to mesh heads. You can effectively reduce much of the unwanted sound from the pads by switching to mesh heads.
- When you need to transport the unit, package it in the box (including padding) that it came in, if possible. Otherwise, you will need to use equivalent packaging materials.
- Use a cable from Roland to make the connection. If using some other make of connection cable, please note the following precautions.
 - Some connection cables contain resistors. Do not use cables that incorporate resistors for connecting to this unit. The use of such cables can cause the sound level to be extremely low, or impossible to hear. For information on cable specifications, contact the manufacturer of the cable.

Before Using Cards

Using DATA Cards

- Carefully insert the DATA card all the way in—until it is firmly in place.

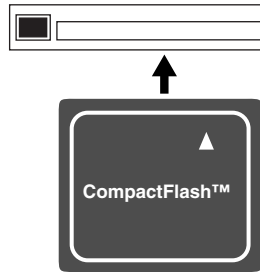

- Never touch the terminals of the DATA card. Also, avoid getting the terminals dirty.
- This unit's memory card slot accepts CompactFlash memory cards. Microdrive storage media are not compatible.
- CompactFlash cards are constructed using precision components; handle the cards carefully, paying particular note to the following.
 - To prevent damage to the cards from static electricity, be sure to discharge any static electricity from your own body before handling the cards.
 - Do not touch or allow metal to come into contact with the contact portion of the cards.
 - Do not bend, drop, or subject cards to strong shock or vibration.
 - Do not keep cards in direct sunlight, in closed vehicles, or other such locations (storage temperature: -25 to 85° C).
 - Do not allow cards to become wet.
 - Do not disassemble or modify the cards.

* The explanations in this manual include illustrations that depict what should typically be shown by the display. Note, however, that your unit may incorporate a newer, enhanced version of the system (e.g., includes newer sounds), so what you actually see in the display may not always match what appears in the manual.

Contents

USING THE UNIT SAFELY	3
IMPORTANT NOTES.....	5
Features	11
Panel Descriptions	13
Top Panel.....	13
Rear Panel	15
Front Panel	16
Setting Up the Kit	17
Mounting the TD-20 on the Stand	17
Connecting the Pads and Pedals.....	18
Connecting Headphones, Audio Equipment, Amps, or Other Gear	19
Turning On/Off the Power	20
Connecting the Hi-Hat (VH-12) and Setting the “VH Offset”	21
Connecting the Hi-Hat.....	21
Adjusting the Offset	21
Adjusting Mesh Head Tension (PD-125/105)	21
Listening to the Demo Song.....	22
Button Operation and Displays.....	23
Saving Your Settings.....	23
Buttons, Sliders, Dial and Knobs	23
Cursor	23
Function Buttons ([F1]–[F5]).....	23
Changing Data Values.....	23
Group Faders	24
Choosing Pads from the TD-20’s Top Panel	24
How to Play Patterns.....	25
How to Turn the Metronome (Click) On/Off.....	25
How to Adjust the Tempo	25
Adjusting the Display Contrast	25
About the Display in the Upper Right of the Screen	25
About the Preset Drum Kits	25
Playing Methods.....	26
Pad (PD-125/105).....	26
Change the Nuance of the Rim Shot.....	26
Hi-Hat (VH-12).....	26
Cymbal (CY-15R/14C)	27
Choke Play	27
Positional Sensing.....	27
Chapter 1. Drum Kit Settings [KIT]	28
Choosing a Drum Kit.....	28
About the “DRUM KIT” Screen	28
Selecting a Drum Kit from the List [F1 (LIST)]	28
Kit Parameters [F2 (FUNC)]	29

Adjusting the Volume [F1 (VOLUME)].....	29
Assigning a Tempo for Each Kit [F2 (TEMPO)]	29
Playing Brushes [F3 (BRUSH)]	29
Output Level Monitor [F5 (MONITOR)].....	29
Naming a Drum Kit [F3 (NAME)].....	30
Playing Cross Stick [F5 (XSTICK)].....	30
Chapter 2. Drum Instrument Settings [INST]	31
Choosing a Pad to Edit.....	31
Choose by Hitting a Pad.....	31
Choose with the Trigger Select Buttons	31
Lock the Pad You are Editing (EDIT LOCK)	31
Assign an Instrument to a Pad.....	31
Selecting an Instrument from the List [F1 (LIST)].....	32
Editing Drum Sounds [F2 (EDIT)].....	32
Editing an Acoustic Drum Kit (V-EDIT)	32
Editing Other Instruments	32
Editing Procedure.....	32
Using Pads/Pedal as Controllers [F3 (CONTROL)].....	35
Playing a Pattern by Hitting a Pad (Pad Pattern) [F1 (PATTERN)].....	35
Changing the Pitch with the Hi-Hat Pedal [F2 (PDLBEND)]	35
MIDI Settings for Each Pad [F3 (MIDI)].....	36
MIDI Note Numbers transmitted by Hi-Hat [F4 (HH MIDI)]	36
MIDI Note Number transmitted by Brush Sweep/Cross Stick [F5 (BR MIDI)].....	36
Chapter 3. Mixer Settings	37
Mixer Parameters [MIXER]	37
Using Group Faders to Edit (MIX EDIT).....	37
Chapter 4. Effect Settings.....	38
Effects On and Off Switches [EFFECTS SWITCH].....	38
Using the Compressor and EQ [COMP/EQ].....	38
Compressor (COMP).....	39
Equalizer (EQ).....	39
Ambience [AMBIENCE]	40
Multi-Effects [MULTI EFFECTS]	40
Multi-Effects Parameters	41
Master Effects [MASTER COMP/EQ].....	43
Chapter 5. Trigger Settings [TRIGGER].....	44
Selecting the Pad Type [F1 (BANK)].....	44
Trigger Inputs and Pad/Playing Methods corresponding chart.....	44
Setting the Pad Sensitivity [F2 (BASIC)].....	45
Pad Sensitivity.....	45
Minimum level for the pad (Threshold).....	45
How Playing Dynamics Changes the Volume (Velocity Curve).....	45
Hi-Hat Settings [F3 (HI-HAT)].....	46
Adjusting the Offset of VH-12 Automatically	46
Adjusting the Offset of VH-11	46
Eliminate Crosstalk Between Pads [F4 (XTALK)].....	47
Advanced Trigger Parameters [F5 (ADVANCE)].....	48
Trigger Signal Detection Time (Scan Time)	48

Detecting Trigger Signal Attenuation (Retrigger Cancel)	48
Double Triggering Prevention (Mask Time).....	49
Rim/Edge Dynamic Response (Rim Gain).....	49
Rim Shots Response (Rim Shot Adjust).....	49
Cross Stick Threshold (XStick Thrshld).....	49
Playing Bow, Bell, and Edge (3-Way Triggering)	50
Naming a Trigger Bank [F5 (Name)]	50
Chapter 6. Sequencer (Playback).....	51
Basic Operation	51
Choosing a Pattern [PATTERN]	52
About the “PATTERN” screen.	52
Select a Pattern from the List [F1 (LIST)].....	52
Playing Back a Pattern [PLAY]	52
Tempo Adjustment.....	53
Setting the Tempo by Hitting a Pad (Tap Tempo).....	53
Synchronizing with an External MIDI Device	53
Part Settings [F2 (PART)]	54
Muting a Specific Part [F1 (MUTE)].....	54
Make Settings for the Backing Part [F2 (BACKING)].....	54
Master Tuning	55
Percussion Part Settings [F3 (PERC)].....	55
Percussion Set Settings.....	55
Volume/Pan Settings for Each Part [F4 (MIXER)]	57
Effect Settings for Backing Parts [F5 (REV/CHO)]	57
Pattern Settings [F3 (FUNC)].....	58
Time Signature/Number of Measures/Tempo Settings [F1 (SETUP)]	58
Choosing a Playback Method [F2 (TYPE)].....	58
Naming a Pattern [F5 (NAME)].....	59
Starting and Stopping the Metronome (Click) On/Off.....	59
Using an Indicator as a Click	59
Setting the Click	60
Chapter 7. Sequencer (Recording/Editing)	61
Recording a Pattern [REC].....	61
How to Record	61
Checking the Tones and Phrases During Recording (Rehearsal)	63
Editing a Pattern [F4 (EDIT)].....	64
Copying a Pattern [F1 (COPY)]	64
Connecting Two Patterns [F2 (APPEND)].....	65
Erasing a pattern [F3 (ERASE)].....	65
Deleting a Pattern [F4 (DELETE)]	66
Saving Patterns to a Memory Card [F5 (CARD)].....	67
Chapter 8. Copy Function [COPY]	69
Chapter 9. Using a CompactFlash Memory Card [CARD]	70
Saving Data to a Memory Card [F1 (SAVE)]	70
Naming a Backup [F4 (NAME)]	71
Loading Data from a Memory Card [F2 (LOAD)]	71
Deleting Data from a Memory Card [F3 (DELETE)]	72
Formatting a Memory Card [F4 (FORMAT)].....	72
Checking the State of a Memory Card [F5 (INFO)]	73

Chapter 10. Settings for the Entire TD-20 [SETUP]	74
MIDI Settings and Operations [F1 (MIDI)]	74
Setting the MIDI Channels for Each Part [F1 (MIDI CH)].....	74
MIDI Settings for the Entire TD-20 [F2 (GLOBAL)]	74
MIDI Messages for Detailed Performance Expressions [F3 (CTRL)].....	76
Switching Drum Kits via MIDI (Program Change) [F4 (PROG)]	76
Saving Data to an external MIDI Device (Bulk Dump) [F5 (BULK)]	77
Selecting Output Destinations [F2 (OUTPUT)]	78
Output Destination for the Drum Instruments	78
Output Destination for the Sequencer Parts/Metronome Click/ Sound Input from MIX IN [F4 (OTHER)]	78
Setting the Switches [F3 (CONTROL)]	79
Using Foot Switches [F1 (FOOT SW)].....	79
Using Pads as Switches [F2 (PAD SW)]	80
Other Settings [F4 (OPTION)].....	80
Preview Button Settings [F1 (PREVIEW)].....	80
Master Effect Mode [F2 (COMP/EQ)].....	80
Adjusting the Display Contrast [F5 (LCD)]	81
Restoring the Factory Settings [F5 (F RESET)].....	81
Chapter 11. Drum Kit Chain [CHAIN]	82
Creating a Drum Kit Chain	82
Naming a Drum Kit Chain [F5 (NAME)].....	83
Playing with a Drum Kit Chain	83
Chapter 12. Other Functions [TOOLS]	84
Output Level Monitor [F1 (MONITOR)].....	84
Checking the Current Status [F2 (INFO)].....	84
Synchronizing Images to a TD-20 Performance [F5 (V-LINK)]	84
What is V-LINK?.....	84
Connection Examples.....	84
Using V-LINK	85
About Expansion Board	86
Cautions When Installing a Expansion Board	86
How to Install a Expansion Board	86
À propos des carte d’extension	88
Précautions à prendre lors de l’installation d’une carte d’extension	88
Installation d’une carte d’extension	88
Messages and Error Messages	90
Drum Instrument List	92
Note Number (Factory Settings)	96
Backing Instrument List	98
MIDI Implementation Chart	100
Specifications	102
Block Diagram	104
Index	106
Preset Drum Kit List	110
Preset Pattern List	110

Features

Everything Is New! Module—Stand—V-Hi-Hat—Pads

The TD-20 follows in the foot steps of the industry standard TD-10, taking advantage of even more powerful COSM technology. Velocity, position, and interval of each hit are detected precisely, providing real and natural dynamics. The new, dual trigger PD-125/105 pads give you superior feel, response and control of the sound. You can play both shallow and deep rim shots. 15 trigger inputs let you use lots of pads, leaving room for advanced Pad Switch applications. (p. 80)

- * *COSM (Composite Object Sound Modeling) is a Roland technology combining multiple sound modeling processes to create new sounds.*
- * *Positional detection is possible on snare drums (head/rim), toms (rim) and ride cymbals (bow).*

560 New Drum Sounds Expanded V-Editing

The onboard sound library was created for the TD-20, and designed to work with enhanced V-Editing. Besides being able to change heads, muffling types, shell depth, etc. you can also place one of two sizzle types on any cymbal, put a tambourine on the hi-hat, add snare buzz to the toms or kick, change the beater type and move the microphone position on all sounds (p. 32).

An Easy User Interface

The interface is very easy to navigate. With the many buttons on the top panel, you won't lose time searching for functions. Clear graphics, icons and menus guide you through the simple and complex operations. No matter where you are inside the TD-20, pushing the KIT button always brings you back to the main kit page. Even still, please read this manual.

High-speed triggering

Advances in trigger technology combined with new pad designs and V-Hi-Hat pads, provide natural response and feel. Even playing with brushes (plastic only) has improved.

Compact Flash Offers Perfect Data Organization

You can back up all of your kits into 8 different, nameable files on the CF card. Each one stores 50 kits, all patterns, percussion sets and global parameters (p. 70). You can copy FROM the card, the individual kits, instruments within a kit and percussion sets (p. 69). You can also save/load up to 100 individual patterns (p. 67).

Audio Signal Routing Stage or Studio

Flexibility of audio routing is important in the professional environment. The TD-20 lets you use all of the outputs in a very efficient way. Each sound of the drum kit can be assigned to one of the 10 individual outs. (Master out can be used as an individual pair. The Effects, Ambience, Backing parts, Click and even audio coming in the MIX input, can be assigned to individual outputs. Perfect for any situation.

Unique V-Hi-Hat VH-12

The VH-12 V-Hi-Hat, which mounts on just about any hi-hat stand on the market, lets you control the technology with the same movements and feel of an acoustic hi-hat. You can do foot splashes, "swish" sounds and even closing it tighter will create changes in the nuance and/or pitch of the sound (p. 26).

Cables Are Easy To Organize

The MDS-20 stand allows you to pass the cables through the pipes, making easy to transport and set up again. It streamlines the look as well.

Top Quality Signal Processing

Each instrument assigned to trigger 1–15 head and rim inputs has an individual three-band equalizer and compressor (p. 38). There is also a multi-effects unit with reverbs, delays, flanger, chorus, pitch shifter, phaser, ring modulator, overdrive, etc. (p. 40) There's also Ambience, with a new room "shape" feature in addition to being able to change wall materials, size, etc. (p. 40) A master Compressor/EQ lets you apply it to individual kits or for all of the kits (p. 43). All effects are simple to understand and use. Via the top panel, you can also turn all the effects on or off individually.

Functions For Stage

The group faders on the top panel let you make quick changes as needed during performance (p. 24). You can play drum kits in any desired order (Drum Kit Chain, p. 82). The +/- buttons are large enough to be pressed with a drum stick. (Don't HIT them!) Another very useful function allows you to send the click sound ONLY to the headphones if desired (p. 78). An audio input (stereo) for custom monitoring (MIX IN jack, p. 19) is also provided. The MIX EDIT function allows immediate editing of volume, Ambience send level, and MFX send level using the group faders (p. 37).

Sequencer

Recording and playing back patterns is very easy. The 6 part backing section, (including drums) can be used for live or recording performances. Recording directly from the pads to the percussion part is a great new feature, too (p. 75).

Advanced Tempo Functions

Each KIT can have its own tempo setting. The visual indicator helps you count off the tempo of a song without needing to hear the click (p. 59). Tap Tempo function allows you to set tempo from all trigger inputs or the preview button (Tap tempo, p. 53).

Expansion Board

The TD-20's bottom panel provides the access for the future Expansion Board, which will not only add new sounds, but provides a system upgrade using Flash ROM (p. 86, p. 88).

MIDI Sound Module Potentials

Percussion sets are accessed on a different MIDI channel than the drums. They can be played from the internal sequencer or external MIDI source (SPD type pad etc.) and feature a 128 note map. And with 262 backing instruments available, there are sounds for all types of music (p. 98).

V-LINK function

V-LINK (**V-LINK**) is a function that allows music and images to be performed together. By using MIDI to connect two or more V-LINK compatible devices, you can easily enjoy performing a wide range of visual effects that are linked to the expressive elements of a music performance. By using the TD-20 and Edirol DV-7PR together, connected pads can be used to switch the Edirol DV-7PR's images (clips/palettes) (p. 84).

Panel Descriptions

Top Panel

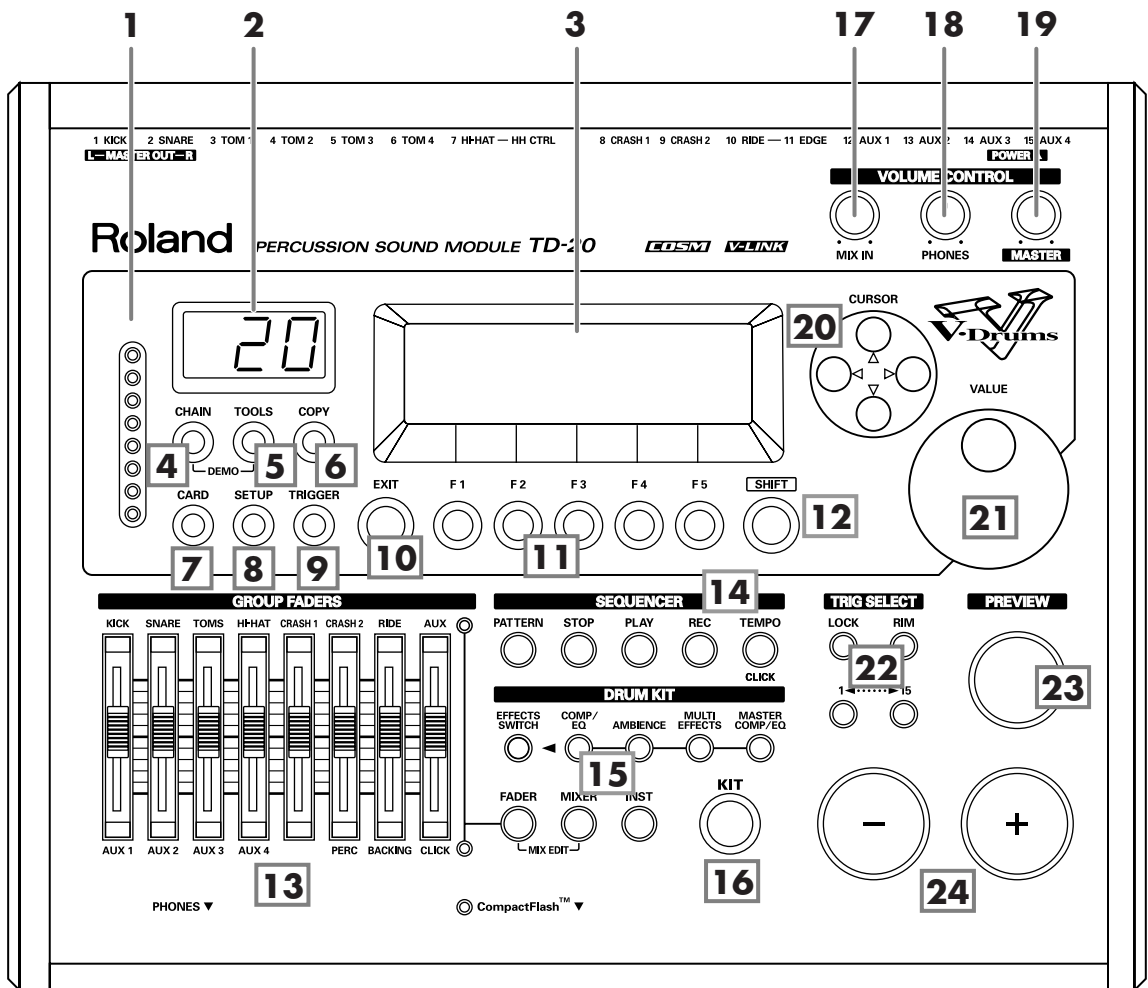

1. Trigger Level Indicator

This lights up and moves each time a trigger signal is received from a pad. It monitors the pad connection and is helpful when customizing trigger parameters.

2. LED Display

Displays the Kit number (currently selected drum kit).

3. Graphic Display

During normal performance, you see the kit name and other information. When editing, relative graphics and text will appear depending on the edit mode you are in.

* In this owner's manual, this will be referred to as "the display."

4. CHAIN Button

A Chain allows you to set up a customized order for playing your kits. There are 16 Chains (32 steps each). Chains can be named also (p. 82).

5. TOOLS Button

Provides access to the Level Monitor, Memory status, and V-LINK on/off (p. 84).

6. COPY Button

Copy or exchange data between drum kits, instruments, etc. (p. 69)

7. CARD Button

For access to (Compact Flash) memory card functions such as saving/loading data etc. (p. 70)

8. SETUP Button

For access to functions that affect the TD-20 globally, such as MIDI parameters etc. (p. 74)

9. TRIGGER Button

For access to trigger parameters (p. 44).

10. EXIT Button

Press this to return to the previous screen. Repeated pressing takes you back to the "DRUM KIT" screen.

11. F1–F5 Buttons

These buttons change their function depending on the contents of the display. The lower part of the display will indicate the function of each button (p. 23).

12. SHIFT Button

Used in combination with other buttons. How this functions is explained in respective parts of this manual.

13. GROUP FADERS

The faders are switchable, allowing you to adjust the volume of the kick, snare, toms, hi-hat, cymbals, percussion and backing instruments, and the click sound (p. 24).

14. SEQUENCER

These provide access to and control of sequencer functions (pattern playback/recording, Percussion set) etc. (p. 51, p. 61)

15. DRUM KIT

These buttons take you to the screens for creating or editing a drum kit. (p. 31, p. 37, p. 38).

16. KIT Button

One touch brings you back to the basic display screen. It works from any Edit mode as well.

17. MIX IN Knob

Adjusts the level of the audio source connected to the MIX IN jack. This sound is output from the MASTER OUT jacks and/or the PHONES jack. Other possibilities (p. 78).

18. PHONES Knob

Adjusts the headphone volume. Plugging in headphones does not affect the master output (like other audio device.)

19. MASTER Knob

Adjusts the volume of the MASTER OUT jacks.

20. CURSOR Buttons

Used to move the cursor in the display (p. 23).

21. VALUE Dial

This dial functions like the + and - buttons. Use it to scroll quickly or make large changes in edited values (p. 23).

22. TRIG SELECT

Use the lower two buttons to select the trigger number (pad) you want to access. Press the RIM button to select the rim of a pad. (RIM button lights.) The PREVIEW button lets you audition the instrument assigned here, or you can hit a pad as well to select (p. 24).

23. PREVIEW Button

This velocity sensitive button allows you to audition an instrument after you have chosen it with the TRIG SELECT buttons or after you have played a pad/pedal (p. 24).

24. + Button, - Button

These buttons are used to switch drum kits or to change values when editing. The + button increases the value, and the - button decreases it (p. 23). You can also use the tip of your drum stick to press them. Never hit them with a stick as this can cause malfunctions.

Rear Panel

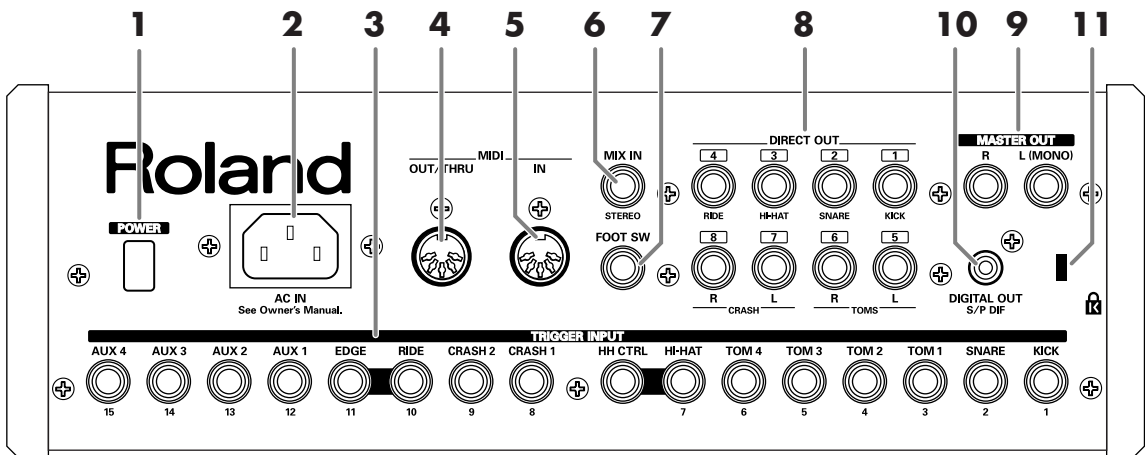
**1. POWER Switch**

This switch turns the power on/off.

* If you need to turn off the power completely, first turn off the POWER switch, then unplug the power cord from the power outlet. Refer to **Power Supply** (p. 5).

2. AC Inlet

Connect the included AC power cable to this inlet.

* For details on the power consumption, refer to p. 103.



The unit should be connected to a power source only of the type marked on the bottom of the unit.

3. TRIGGER INPUT Jacks

Here is where you plug in pads, kick triggers, or acoustic triggers. With dual trigger pads (PD-125/120/105/80R/9/8/7), use a stereo (TRS) cable (p. 18).

4. MIDI IN Connector

To connect an external MIDI source (sequencer, pad controller, keyboard, computer, etc.) to play the TD-20's sounds, or to load data (pp. 74-77).

5. MIDI OUT/THRU Connector

For using the TD-20/pads to play sounds in an external MIDI sound module, or recording/saving data to an external MIDI sequencer (pp. 74-77).

6. MIX IN Jack

Used for connecting any external audio source (p. 19). This audio signal will be output from the MASTER OUT jacks and/or PHONES jack. Other signal routing possibilities (p. 78).

7. FOOT SWITCH Jack

Optional foot switches (such as BOSS FS-5U) give you access to a variety of functions like selecting drum kits, sequencer start/stop, etc. Using an optional PCS-31 cable (standard insert cable), two foot switches can be utilized at the same time (p. 79).

8. DIRECT OUT Jacks

Individual outputs have a variety of uses. The TD-20 offers many options. See the SETUP screen (p. 78).

9. MASTER OUT Jacks

For connecting to your amp/audio system. For monaural output, use the MASTER OUT L (MONO) jack.

10. DIGITAL OUT Connector

This coaxial-type digital out connector sends the same audio signal as is output from MASTER OUT jacks.

11. Security Slot ()

For retail store use.

<http://www.kensington.com/>

Front Panel

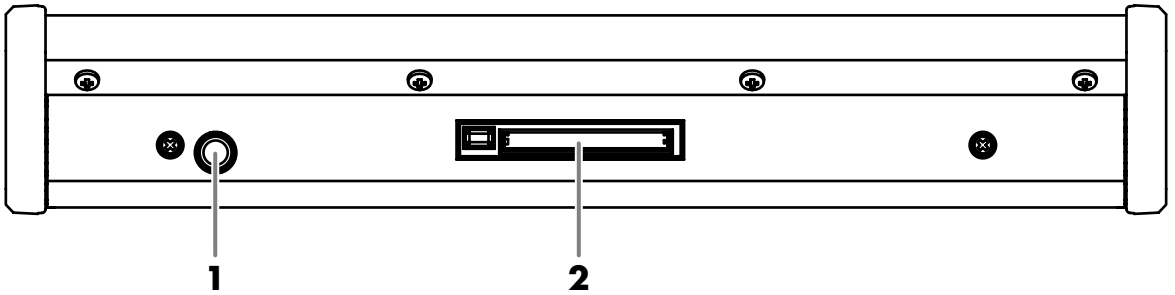

1. PHONES Jack

A pair of stereo headphones can be connected to this jack. Connecting the headphones will not mute the output from the MASTER OUT jacks (p. 19).

2. CompactFlash Card Slot

Accepts a CompactFlash memory card (optional). Each memory card can store all settings of the TD-20, such as drum kits and sequencer performance data, etc. (p. 70)

* *The CompactFlash is the only memory card can be used by the TD-20.*

Setting Up the Kit

Mounting the TD-20 on the Stand

1. Attach the stand holder (included with the optional drum stand) to the TD-20.

Using the screws attached to the bottom panel, attach the holder so the unit is oriented as shown in the diagram.

* ONLY use the 12 mm screws (M5 x 12) provided with the TD-20. Other screws may damage the unit.

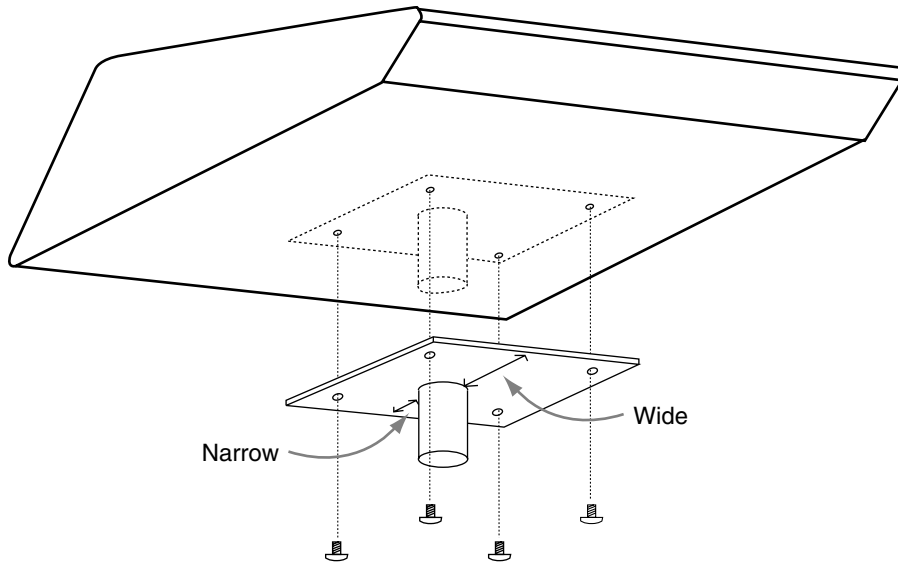

NOTE

- When turning the unit upside-down, get a bunch of newspapers or magazines, and place them under the four corners or at both ends to prevent damage to the buttons and controls. Also, you should try to orient the unit so no buttons or controls get damaged.
- When turning the unit upside-down, handle with care to avoid dropping it, or allowing it to fall or tip over.

2. Attach the TD-20 and stand holder to the drum stand (such as the optional MDS-20BK).

See the owner's manual for the stand for details on assembling the drum stand and attaching the TD-20.



This unit should be used only with a stand that is recommended by Roland.



When using the unit with a stand recommended by Roland, the stand must be carefully placed so it is level and sure to remain stable. If not using a stand, you still need to make sure that any location you choose for placing the unit provides a level surface that will properly support the unit, and keep it from wobbling.



This TD-20 is designed for use only with Roland stand MDS series. Use with other stands is capable of resulting in instability causing possible injury.

MEMO

The optional APC-33 All Purpose Clamp can be attached to a pipe of 10.5–28.6 mm radius in case you want to mount the TD-20 on a cymbal stand or other such stand.

Setting Up the Kit

Connecting the Pads and Pedals

Using the provided cables, connect the pads, cymbals, hi-hat, and kick trigger.

* When mounting a TD-20 on an MDS-20 drum stand, use the built-in connection cables.

Set Up Example

TD-20 Rear Panel

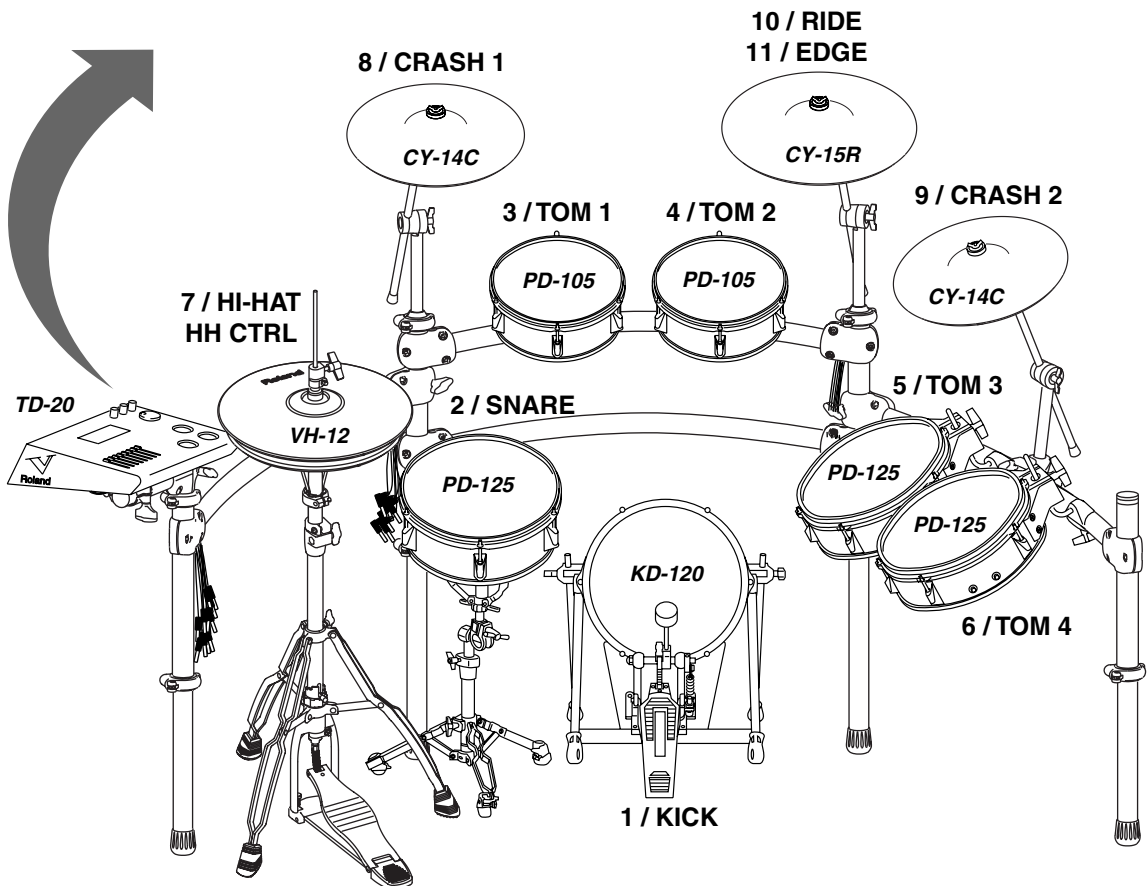
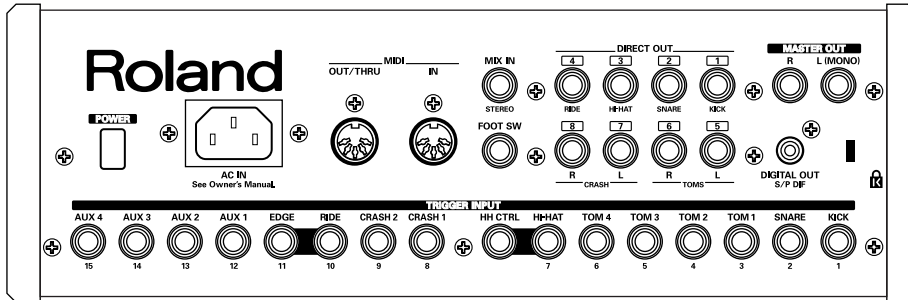

The HI-HAT and RIDE cymbal use two cables each. See p. 21 and p. 50.

Connecting Headphones, Audio Equipment, Amps, or Other Gear

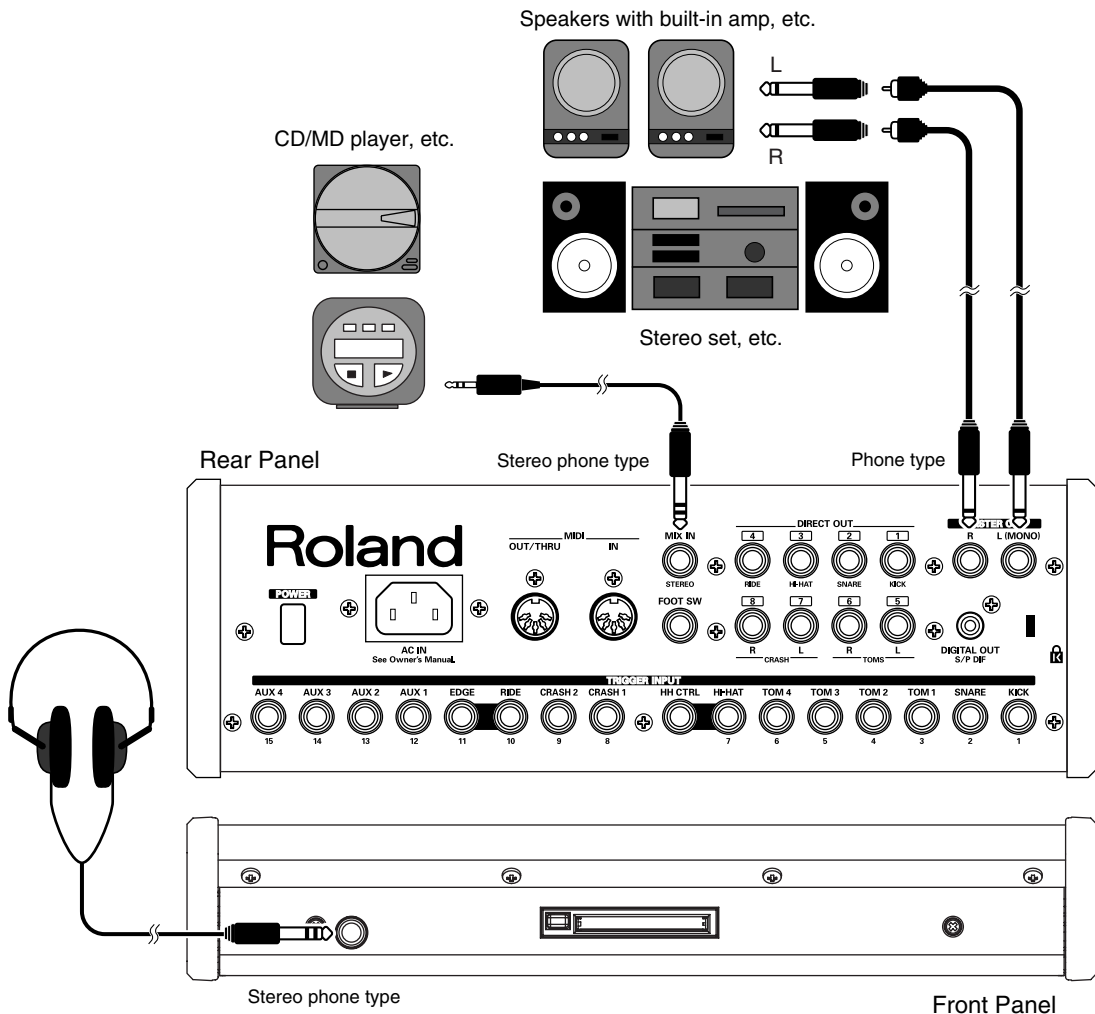

1. Turn off the power of all devices before you make connections.

* To prevent malfunction and/or damage to speakers or other devices, always turn down the volume, and turn off the power on all devices before making any connections.

2. Connect the MASTER OUT L (MONO) and R jacks on the rear panel to your audio system or amp. Headphones should ONLY be connected to the PHONES jack.

3. Connect the supplied power cord to the AC inlet.

4. Plug the power cord plug into a power outlet.

MEMO

The TD-20's MIX IN jack allows you to play along with a CD or other audio sources.

- To adjust the volume of the device connected to the MIX IN jack, turn the [MIX IN] knob on the TD-20's top panel.
- The sound input from the MIX IN jack can be output from the MASTER OUT, PHONES, or DIRECT OUT 5-8 jacks (p. 78).

* When connection cables with resistors are used, the volume level of equipment connected to the MIX IN jack may be low. If this happens, use connection cables that do not contain resistors, such as those from the Roland PCS series.

Turning On/Off the Power

* Once the connections have been completed (p. 18, p. 19), turn on power to your various devices in the order specified. By turning on devices in the wrong order, you risk causing malfunction and/or damage to speakers and other devices.



1. Turn the [MASTER] and [PHONES] completely to the left to lower the volume to “0.”
2. Turn down the volume control on the connected amp or audio system.
3. Push the [POWER] switch on the TD-20’s rear panel to turn on the power.



* This unit is equipped with a protection circuit. A brief interval (a few seconds) after power up is required before the unit will operate normally.

Precautions When Turning on the Power

After the power is turned on, do NOT hit any pads or step on the pedals until the drum kit name (following figure) appears in the display. Doing so can cause triggering problems.



4. Turn on the power to the connected amp or audio system.
5. While hitting a pad, gradually turn [MASTER] (or [PHONES]) to the right to adjust the volume level.

No Sound When Hitting the Pads or Using the Pedals?

Check the following points.

When Using an Amp or Audio System

- Is the amp or audio system connected to the TD-20’s MASTER OUT jacks?
- Is the input of the amp or audio system properly connected?
- Is there a problem with any connection cables?
- Is the volume turned down in the [GROUP FADERS] sliders?
- Is [MASTER] turned completely to the left?
- Have the input select settings of your audio system or amp been made correctly?
- Is the amp or audio system volume setting correct?

When Using Headphones

- Are the headphones connected to the PHONES jack?
- Is [PHONES] turned completely to the left?

Turning Off the Power

1. Completely turn down the volume of the TD-20 and any connected external devices.
2. Turn off the power to all external devices.
3. Push the [POWER] switch on the TD-20’s rear panel to turn off the power.

* If you need to turn off the power completely, first turn off the POWER switch, then unplug the power cord from the power outlet. Refer to **Power Supply** (p. 5).

Connecting the Hi-Hat (VH-12) and Setting the "VH Offset"

Connecting the Hi-Hat

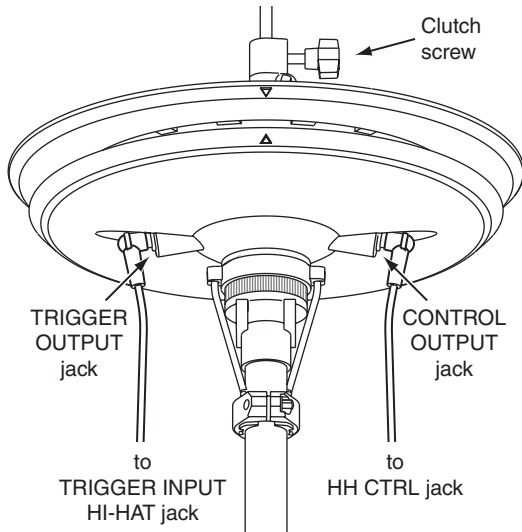

Adjusting the Offset

When using the VH-12, the "VH Offset" needs to be set up.

1. Loosen the clutch of the top hi-hat and let it sit on the bottom hi-hat.

* Do NOT touch the hi-hats or the pedal.

2. Hold down [KIT] and press [TRIGGER].

The "VH offset" parameter is set automatically. (approx. 3 seconds)

[TRIGGER] stops flashing and remains lit.

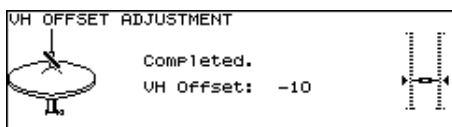

If you need, make further adjustments to the parameters.
Hi-Hat Settings [F3 (HI-HAT)] (p. 46)



If you do not make VH-12's setting correctly, it may cause malfunction. For details, refer to the VH-12 owner's manual.

Adjusting Mesh Head Tension (PD-125/105)

Heads MUST BE TUNED BEFORE PLAYING.

When adjusting, use a tuning key.

Like with an acoustic drum, accurate and equal head tension is needed for correct triggering response.

MEMO

On the PD-125/105, adjusting the head tension affects only the head response, and not the pitch of the sound, as it would on an acoustic drum.

1. Loosen the tuning bolts until a slight gap is produced.
2. Tighten all tuning bolts by fingers, as tightly as you can.

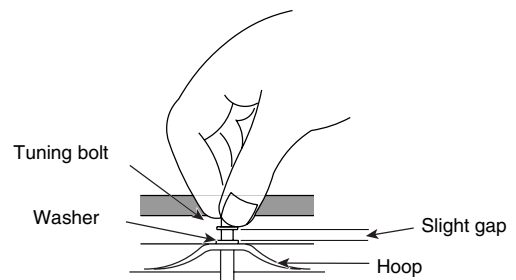

3. Using the tuning key, turn the tuning bolts two full revolutions each, thus tightening them.

Tighten each tuning bolt one by one, observing the numerical order shown in the figure.

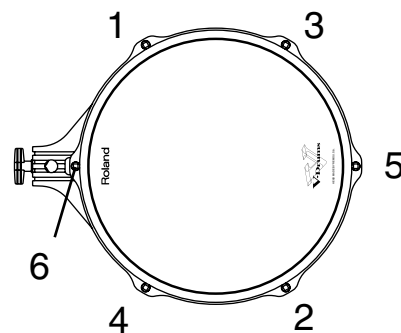

Listening to the Demo Song

The internal demo song features the TD-20's expressive capabilities and top quality sounds. The drums on this song were recorded from the TD-20 system to a sequencer in real time.

1. Press [CHAIN] and [TOOLS] simultaneously.

The "DEMONSTRATION" screen appears.

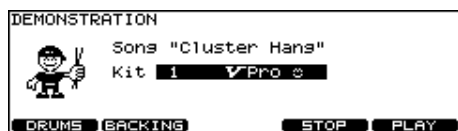

2. Press [F5 (PLAY)].

The demo song is played.

- * Press [F4 (STOP)] to stop the demo song.

MEMO

You can use [+/-] or [VALUE] to switch the kit being used in the song, an easy way to check the sounds.

- * Preset drum kits are always selected to play the demo song.

Function Buttons

[F1 (DRUMS)]

You can MUTE the entire drum track.

[F2 (BACKING)]

You can MUTE all the backing instruments.

MEMO

- You can change the volume balance with [GROUP FADERS] (p. 24).
- Hold down [SHIFT] and press [TEMPO] to turn the metronome click (p. 59) on/off.
The click sounds with the settings which you set before you enter the "DEMONSTRATION" screen.

3. Press [EXIT] or [KIT] to return to the "DRUM KIT" screen.

NOTE

Caution Concerning Volume

When playing back the demo song, turn [MASTER] and [PHONES] to the left (counterclockwise) to bring the volume level down. The sound levels (volume) of the instruments may be louder when the demo song is played back.

Demo Song

Cluster Hang

Copyright (C) 2004, Roland US

- * All rights reserved. Unauthorized use of this material for purposes other than private, personal enjoyment is a violation of applicable laws.

- * No data for the music that is played will be output from MIDI OUT.

Button Operation and Displays

Operations common to all aspects TD-20 operations.

Saving Your Settings

Every time you change a value during the editing process, it's automatically stored in the TD-20's memory. There's no "write/save" process. (except when using a memory card)

Buttons, Sliders, Dial and Knobs

References for top panel buttons, sliders, dial and knobs will be printed in square brackets []; e.g., [SETUP].

Cursor

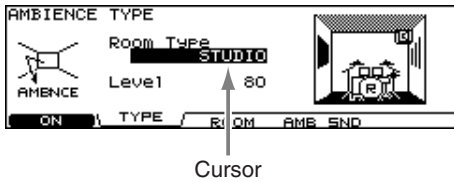

Cursor refers to the highlighted characters indicating an on-screen parameter that can be set. When there is more than one possibility within the screen, use the [CURSOR] buttons to move it.

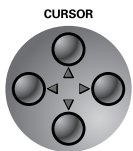

Function Buttons ([F1]–[F5])

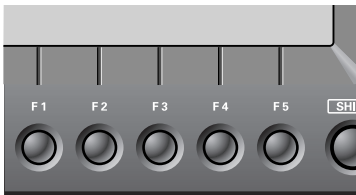

The [F1]–[F5] buttons are called "function buttons." The bottom part of the display will show the names of the functions available for [F1]–[F5]. For example, if this owner's manual makes reference to [INST] - [F2 (EDIT)], press [INST],

and then press [F2] (in this case, "EDIT" is displayed above [F2]).

Changing Data Values

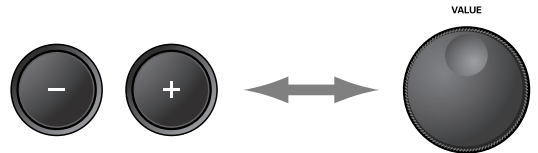

[+] and [-] (referred to in this manual as [+/-]) and the [VALUE] dial are both used to change the values of settings. Both methods have advantages.

[+/-]

- Each time [+] is pressed, the value increases. Each time [-] is pressed, the value decreases. This is convenient for fine adjustments.
- When making an on/off setting, [+] will turn the setting on and [-] will turn it off.
- If you hold down [+] and press [-], the value will increase rapidly. If you hold down [-] and press [+], the value will decrease rapidly.

[VALUE] dial

The dial allows you to make major changes to the value quickly. If you hold down [SHIFT] and turn [VALUE], the value will change even more rapidly.

Group Faders

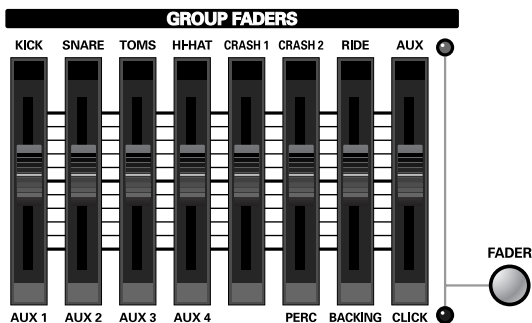

Use [GROUP FADERS] sliders to adjust the volume.

If you press the [FADER] button, the function of the faders will change as is explained in the chart below. An LED will light up at the upper and lower right of the faders to indicate which set of sounds is active.

- When upper indicator is lit, you can adjust the volume of following trigger inputs.

KICK	1 KICK
SNARE	2 SNARE
TOMS	3 TOM 1, 4 TOM 2, 5 TOM 3, 6 TOM 4
HI-HAT	7 HI-HAT
CRASH 1	8 CRASH 1
CRASH 2	9 CRASH 2
RIDE	10 RIDE, 11 EDGE
AUX	12 AUX 1, 13 AUX 2, 14 AUX 3, 15 AUX 4

- When lower indicator is lit, you can adjust the volume of following trigger inputs and sequencer parts.

AUX 1	12 AUX 1
AUX 2	13 AUX 2
AUX 3	14 AUX 3
AUX 4	15 AUX 4
PERC	Percussion part (p. 55)
BACKING	Backing part (p. 54)
CLICK	Metronome click (p. 59)

Example: Adjusting the Snare Volume

1. Press [FADER] so the upper indicator is lit.
2. Move the [GROUP FADERS] [SNARE] slider.

The slider position shows the current snare volume.

* After switching with [FADER], the values for the [GROUP FADERS] sliders may not reflect the actual volume of the sound assigned to that fader. So after switching, be sure to move the faders a bit before making your setting.

* This will NOT affect the independent volume balance for each kit in: Mixer Settings (p. 37).

Choosing Pads from the TD-20's Top Panel

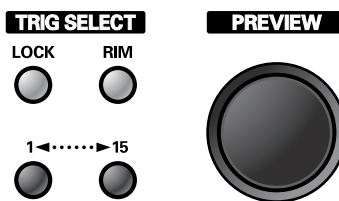

The ([TRIG SELECT]) buttons can be used to select the pad/trigger input to be edited without needing to hit a pad. When you press [1], the next lower-numbered trigger will be selected. When you press [15], the next higher-numbered trigger will be selected. When using a rim capable pad, [RIM] lets you know you're editing the rim. [PREVIEW] plays the sound in the display. So it's easy to edit with only the TD-20 and a pair of headphones.

* When you select the hi-hat (trigger number 7), you can sound the closed hi-hat by holding down [SHIFT] and pressing [PREVIEW].

How to Play Patterns

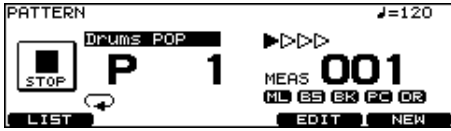

Pressing [PATTERN]. The basic screen for the sequencer appears.

Press [+/-] or turn [VALUE] in this screen to choose a pattern. Or press [F1 (LIST)] to choose from the pattern list.

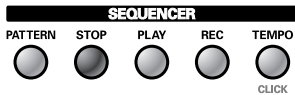

Press [PLAY] to start playback of the pattern.

Press [STOP] to stop playback.

Press [STOP] again to return to the top of the pattern.

How to Turn the Metronome (Click) On/Off

Hold down [SHIFT] and press [TEMPO] to turn ON and OFF.

* The [TEMPO] indicator can also be used as a visual metronome (p. 59).

How to Adjust the Tempo



To adjust the tempo of the sequencer and click, use [+/-] or [VALUE] in the screen displayed by pressing [TEMPO].

Adjusting the Display Contrast

Display contrast can be influenced by location and lighting. When needed, adjust the display contrast by: **holding down [KIT] and turning [VALUE].**

* You can also adjust it in the screen displayed by pressing [SETUP] - [F4 (OPTION)] - [F5 (LCD)] (p. 81).

About the Display in the Upper Right of the Screen

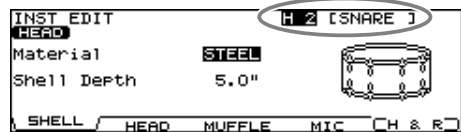

Many edit screens require you to hit a pad or the [PREVIEW] button to access the parameters you want. The upper right of the display will show the number and trigger input jack name of the corresponding pad. The first character ("H" or "R") stands for Head or Rim. ([RIM] lights up when played.) You can use the TRIGGER SELECT buttons and [PREVIEW] to get the same results. In cases where settings for the head and rim can be edited separately, the following characters will also be displayed.



About the Preset Drum Kits

The TD-20 is shipped from the factory with 50 pre-loaded drum kits. After changing the settings, you can restore the factory settings at any time (p. 69). These drum kits are referred to as **Preset Drum Kits**.

Playing Methods

Pad (PD-125/105)

Head Shot

Hit only the head of the pad. With certain snare sounds, playing position will change the nuance of the sound.

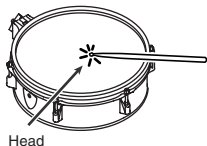

Rim Shot

Strike the head and the rim of the pad simultaneously.

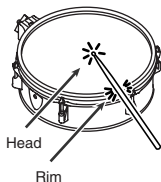

Cross Stick

Only strike the rim of the pad. Depending on the instrument assigned to the rim you can play rim shots and/or cross stick sounds.

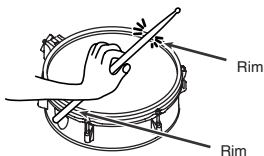

* To play the cross stick, be sure that you only strike the rim of the pad. Placing your hand on the head of the pad might prevent the cross stick sound from being played properly.

Change the Nuance of the Rim Shot

With certain snare and tom sounds, slight changes in the way you play rim shots changes the nuance.

Normal Rim Shot (Open Rim Shot)

Strike the head and rim simultaneously.

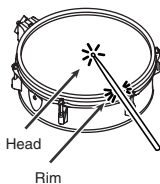

Shallow Rim Shot

Simultaneously strike the head near the rim and the rim itself.

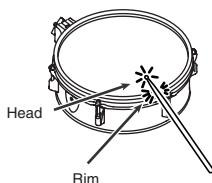

Hi-Hat (VH-12)

Open/Closed

The hi-hat tone changes smoothly and continuously from open to closed in response to how far the pedal is pressed. You can also play the foot closed sound (playing the hi-hat with the pedal completely pressed down) and foot splash sound (playing the hi-hat with the pedal fully pressed and then instantly opening it).

Pressure

When you strike the hi-hat while pressing on the pedal with the hi-hat closed, you can then change the closed tone in response to the pressure you place on the pedal.

Bow Shot

This playing method involves striking the middle area of the top hi-hat. It corresponds to the sound of the "head-side" of the connected trigger input.

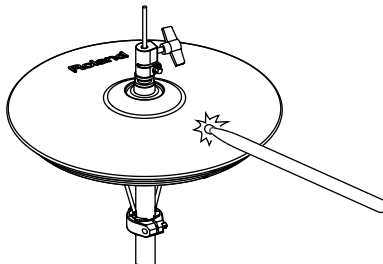

Edge Shot

This playing method involves striking the edge of the top hi-hat with the shoulder of the stick. When played as shown in the figure, the "rim-side" sound of the connected trigger input is triggered.

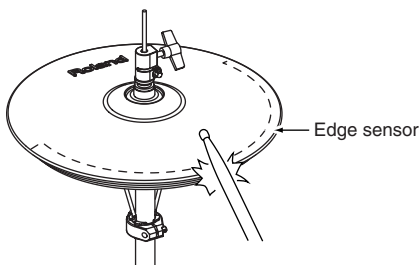

* Do not strike the bottom hi-hat or the underside of the top hi-hat.

Cymbal (CY-15R/14C)

Bow Shot

This is the most common playing method, playing the middle area of the cymbal. It corresponds to the sound of the “head-side” of the connected trigger input.

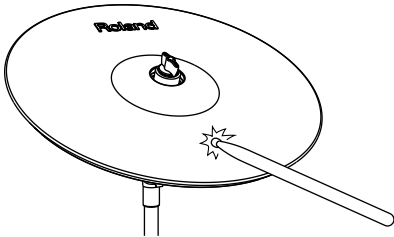

Edge Shot

This playing method involves striking the edge with the shoulder of the stick. When played as shown in the figure, the “rim-side” sound of the connected input is triggered.

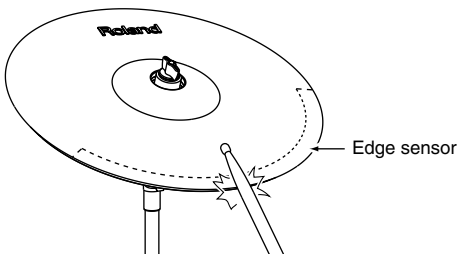

Bell Shot (CY-15R)

This playing method involves striking the bell. On the CY-15R, when played as shown in the figure, the “rim-side” sound of the connected input is triggered.

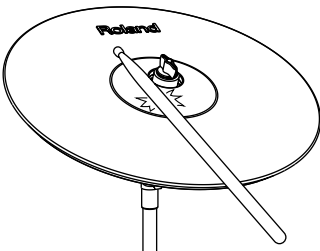

- * Strike the bell somewhat strongly with the shoulder of the stick.
- * On the CY-14C, bell shots are not supported.

Choke Play

Choking (pinching) the cymbal’s edge with the hand immediately after hitting the cymbal makes the sound stop. Choke the location of the edge sensor shown in the figure. If you choke an area where there is no sensor, the sound does not stop.

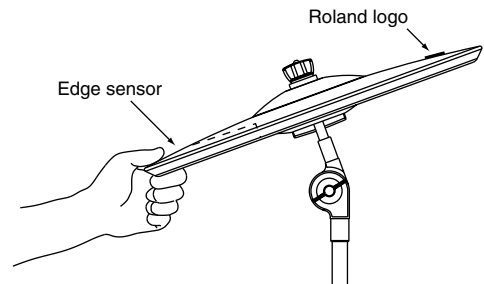

Positional Sensing

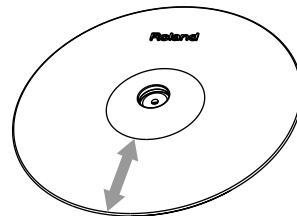

With certain ride sounds, playing position will change the nuance of the sound.

- * Only TRIGGER INPUT 10 RIDE corresponds to the positional sensing.



About the instruments corresponding to each playing method, refer to p. 95.

Chapter 1. Drum Kit Settings [KIT]

Choosing a Drum Kit

1. Press [KIT].

[KIT] lights, and the "DRUM KIT" screen appears.



2. Use [+/-] or [VALUE] to select drum kits.

HINT

Foot switches or pads can be programmed to make selections (p. 79, p. 80).

MEMO

The selected or current kit number is indicated at all times in the LED display at the left of the LCD display.

About the "DRUM KIT" Screen



A: Drum Kit Name

B: Overall Kit Effects On/Off status (p. 38)

MEMO

Pressing [KIT] always takes you back to the "DRUM KIT" screen, from any Edit mode in the TD-20.

Selecting a Drum Kit from the List [F1 (LIST)]

You can select a drum kit by accessing the list of available kits.

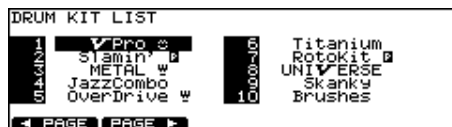

1. Press [KIT] - [F1 (LIST)].

The "DRUM KIT LIST" screen appears.

2. Use [VALUE], [+/-], or [CURSOR] to select a drum kit.

Function Buttons

[F1 (< PAGE)]

The previous page of the list appears.

[F2 (PAGE >)]

The next page of the list appears.

3. Press [EXIT] (or just press [KIT]) to return to the "DRUM KIT" screen.

Kit Parameters [F2 (FUNC)]

1. Press [KIT] - [F2 (FUNC)].
2. Press [F1]–[F3] and [CURSOR (up/down)] to select the parameter.
3. Use [+/-] or [VALUE] to make settings.

Adjusting the Volume [F1 (VOLUME)]

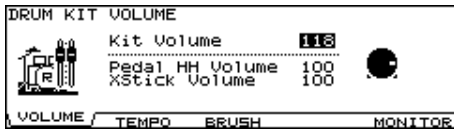

Parameter	Value	Description
Kit Volume	0–127	Volume of the entire drum kit
Pedal HH Volume	0–127	Volume of the hi-hat's foot closed sound
XStick Volume	0–127	Volume of cross stick sound

Assigning a Tempo for Each Kit [F2 (TEMPO)]

Each kit can have an individual tempo setting. When you select a kit of which Kit Tempo is set to “ON,” the tempo you define here will be set automatically.



Parameter	Value	Description
Kit Tempo	OFF, ON	OFF: tempo is not defined ON: tempo is defined
Tempo	20–260	defined tempo

MEMO

When you select a kit of which Kit Tempo is set to “ON,” the defined tempo appears in the upper right of the display.



Playing Brushes [F3 (BRUSH)]

In each kit, you can choose whether sticks or brushes will be used.



Parameter	Value	Description
Brush Switch	OFF, ON	OFF: for using sticks ON: for using brushes

MEMO

When Brush Switch is set to “ON,” the brush icon appears in the “DRUM KIT” screen.



Output Level Monitor [F5 (MONITOR)]

You can check the output level from the selected jacks. Use [+/-] or [VALUE] to choose the jacks. Choose from: Master, Phones, and separate stereo outs.



Naming a Drum Kit [F3 (NAME)]

Each kit's name can use up to 12 characters.



1. Press [KIT] - [F3 (NAME)].
The "DRUM KIT NAME" screen appears.
2. Press [CURSOR (left/right)] to move the cursor to the character to be changed.
3. Use [VALUE], [+/-], or [CURSOR (up/down)] to change the character.

Function Buttons

[F1 (INSERT)]

A blank space is inserted at the cursor position, and characters after this point are moved to the right one space.

[F2 (DELETE)]

Character at the cursor position is deleted, and characters after this point are moved to the left one space.

[F3 (SPACE)]

Character at the cursor position is replaced by a blank space.

[F4 (CHAR)]

Type of character at the cursor position changes between uppercase/lowercase alphabet, or numbers and symbols.

Playing Cross Stick [F5 (XSTICK)]

In each kit, you can choose to use/not use cross stick by pressing [F5 (XStick)] in the "DRUM KIT" screen.

- Cross stick can be played



- Cross stick not possible



Chapter 2. Drum Instrument Settings [INST]

Here's how to select and edit sounds, such as the snare drum and kick drum.

Choosing a Pad to Edit

There are two basic ways to select the sound you want to edit.

Choose by Hitting a Pad

1. Press [INST].

[INST] lights, and the "INST" screen appears.



2. Strike a pad.

The settings screen for the struck pad appears. To select a pad's rim, strike the rim.

Choose with the Trigger Select Buttons

1. Press [INST].

[INST] lights, and the "INST" screen appears.

2. Press TRIG SELECT [1] or [15] to select the trigger input number.

The trigger input number is indicated in the upper part of the screen.

3. Press TRIG SELECT [RIM] to select the head or rim.

Head: [RIM] is unlit.

Rim: [RIM] is lit.



MEMO

When MIDI Note Number corresponding to a pad is received, the pad is selected and shown in the screen.

Lock the Pad You are Editing (EDIT LOCK)

When editing instruments, you can prevent the screen from being switched inadvertently even if you hit another pad.

1. Select the pad to be locked.

The settings screen for the pad appears.

2. Press TRIG SELECT [LOCK] to make it light.

The pad is locked and other pads cannot be selected.

3. To release the lock, press [LOCK] to make it go off.

* You can change the pad to be locked by pressing TRIG SELECT [1] or [15] even if the [LOCK] is lit.

Assign an Instrument to a Pad

All the TD-20 sounds are referred to as instruments (INST).



1. Press [INST].

[INST] lights, and the "INST" screen appears.

"Group": Type of instrument (Inst Group)

"Inst": Name of instrument (Inst Name)

2. Strike a pad.

The settings screen for the struck pad appears.

3. Press [CURSOR (up/down)] to move the cursor to "Group" or "Inst."

4. Use [+/-] or [VALUE] to select the Inst group/instrument.

5. Press [EXIT] to return to the "DRUM KIT" screen.

MEMO

Pressing [F5 (H & R)], you can choose to set the head and rim simultaneously or individually. When you select the head and rim simultaneously, the rim's instrument number is one higher than head.

Selecting an Instrument from the List [F1 (LIST)]

Here you can select from the list of all available instruments.

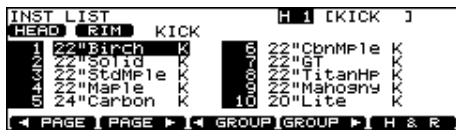

1. Press [INST] - [F1 (LIST)].
The "INST LIST" screen appears.
2. Strike a pad.
The settings screen for the struck pad appears.
3. Use [VALUE], [+/-], or [CURSOR] to select the instrument.

Function Buttons

[F1 (< PAGE)]

The previous page of the list appears.

[F2 (PAGE >)]

The next page of the list appears.

[F3 (< GROUP)], [F4 (GROUP >)]

Selects the Inst Group.

[F5 (H & R)]

Switches to select the head and rim instruments simultaneously or individually.

4. Press [EXIT] to return to the "INST" screen.

About the Display at the Lower of the Instrument Name



POSI: Instrument marked with "*"P" (p. 95)
You can select the effect on/off with pressing [F3 (CONTROL)] - [F3 (MIDI)] "Position Ctrl."
It can be correspond only to some special inputs (p. 44)

INTRVL: Instrument marked with "*"I" (p. 95)

XSTK: Instrument marked with "*"X" (p. 95)

* These appear only when [F5 (H & R)] is off.

Editing Drum Sounds [F2 (EDIT)]

Editing methods differ according to the type of instrument.

Editing an Acoustic Drum Kit (V-EDIT)

V-EDIT allows you to select a head type, shell depth, muffling, etc. Please see the charts on next page.

When V-EDIT Can Be Used

V-EDIT is possible in the following instrument groups "KICK," "SNARE," "TOM," "HI-HAT," "CRASH," "SPLASH," "CHINA," or "RIDE."

The following icon appears to indicate instruments which are V-EDIT compatible.



Editing Other Instruments

Other instruments only allow "Pitch" and "Decay Time" adjustment.

Editing Procedure

1. Press [INST] - [F2 (EDIT)].
The "INST EDIT" screen appears.
2. Strike a pad.
The settings screen for the struck pad appears.
3. Use [F1]–[F4] and [CURSOR (up/down)] to select the parameter.
4. Use [+/-] or [VALUE] to adjust the setting.
5. When finished, press [EXIT] to return to the "INST" screen.

KICK

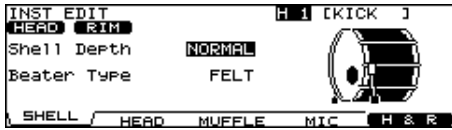

Parameter	Value
[F1 (SHELL)]	
Shell Depth	NORMAL, DEEP1-2
Beater Type	FELT, WOOD, PLASTIC
[F2 (HEAD)]	
Head Type	CLEAR, COATED, PINSTRIPE
Head Tuning	-480+480
[F3 (MUFFLE)]	
Muffling	OFF, TAPE1-2, BLANKET, WEIGHT
Snare Buzz	OFF, 1-8
[F4 (MIC)]	
Mic Position	OUTSIDE2-1, STANDARD, INSIDE1-2

SNARE

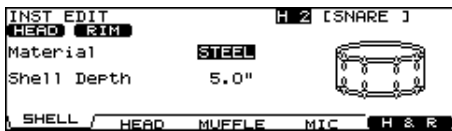

Parameter	Value
[F1 (SHELL)]	
Material	WOOD, STEEL, BRASS
Shell Depth	1.0"-20.0"
[F2 (HEAD)]	
Head Type	CLEAR, COATED, PINSTRIPE
Head Tuning	-480+480
[F3 (MUFFLE)]	
Muffling	OFF, TAPE1-2, DOUGHNUTS1-2
Strainer Adj.	OFF, LOOSE, MEDIUM, TIGHT
[F4 (MIC)]	
Mic Position	OUTSIDE2-1, STANDARD, INSIDE1-2

TOM

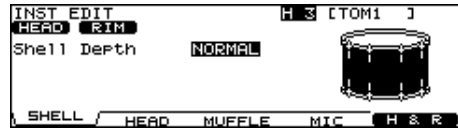

Parameter	Value
[F1 (SHELL)]	
Shell Depth	NORMAL, DEEP1-2
[F2 (HEAD)]	
Head Type	CLEAR, COATED, PINSTRIPE
Head Tuning	-480+480
[F3 (MUFFLE)]	
Muffling	OFF, TAPE1-2, FELT1-2
Snare Buzz	OFF, 1-8
[F4 (MIC)]	
Mic Position	OUTSIDE2-1, STANDARD, INSIDE1-2

* PINSTRIPE is a registered trademark of Remo Inc., U.S.A.

HI-HAT

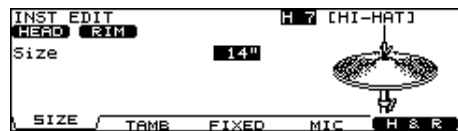

Parameter	Value
[F1 (SIZE)]	
Size	1"-40"
[F2 (TAMB)]	
Add Tambourine	OFF, ON
[F3 (FIXED)]	
Fixed Hi-Hat	NORMAL, FIXED1-4
[F4 (MIC)]	
Mic Position	OUTSIDE2-1, STANDARD, INSIDE1-2

* **NORMAL:** The gap between the top and bottom hi-hat is controlled by the pedal.

FIXED: The gap is fixed.

CRASH/SPLASH/CHINA/RIDE

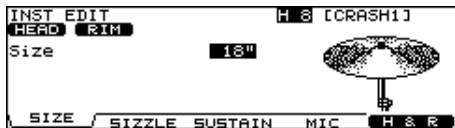

Parameter	Value
[F1 (SIZE)]	
Size	1"–40"
[F2 (SIZZLE)]	
Sizzle Type	OFF, RIVET, CHAIN
[F3 (SUSTAIN)]	
Sustain	-31–+31
[F4 (MIC)]	
Mic Position	OUTSIDE2–1, STANDARD, INSIDE1–2

Other Instruments

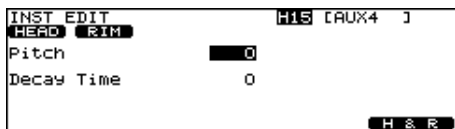

Parameter	Value
Pitch	-480–+480
Decay Time	-31–+31

MEMO

You can edit the instruments of the head and rim simultaneously. Pressing [F5 (H & R)], you can choose to set the head and rim simultaneously or individually.

* When the instruments assigned to the head and rim are not in the same Inst Group, you only can set the head and rim individually even if [F5 (H & R)] is set to ON.

MEMO

You can restore the settings for each instrument to the standard values by pressing [F4 (DEFAULT)] - [F5 (EXECUTE)] in the "INST" screen.

NOTE

For some instruments, raising or lowering the value beyond a certain point may not produce further change.

- KICK/SNARE/TOM: "Head Tuning"
- CRASH/SPLASH/CHINA/RIDE: "Sustain"
- Other Instruments: "Pitch" and "Decay"

NOTE

Some instruments have the parameters cannot be edited.

- SNARE: "Material" and "Strainer Adj."

Using Pads/Pedal as Controllers [F3 (CONTROL)]

1. Press [INST] - [F3 (CONTROL)].
2. Strike a pad.
The settings screen for the struck pad appears.
You can select by using [TRIG SELECT].
3. Press [F1]–[F5] and [CURSOR (up/down)] to select the parameter.
4. Use [+/-] or [VALUE] to adjust settings.
5. When finished, press [EXIT] to return to the “INST” screen.

Parameter	Value	Description
[F1 (PATTERN)]		
Pad Pattern	OFF, P 1–100, U 101–200	Refer to Playing a Pattern by Hitting a Pad (Pad Pattern) [F1 (PATTERN)] (p. 35).
Pad Ptn Velocity	OFF, ON	
Tap Ptn Mute Grp	OFF, 1–8	
[F2 (PDLBEND)]		
Pedal Bend Range	-24–0– +24	Refer to Changing the Pitch with the Hi-Hat Pedal [F2 (PDLBEND)] (p. 35).
[F3 (MIDI)]		
Tx Channel	CH1–CH16, GLOBAL	Refer to MIDI Settings for Each Pad [F3 (MIDI)] (p. 36).
Note No.	0 (C –)–127 (G9), OFF	
Gate Time	0.1–8.0 (s)	
Position Ctrl Sw	OFF, ON	
[F4 (HH MIDI)]		
Note No.	0 (C –)–127 (G9), OFF	Refer to MIDI Note Numbers transmitted by Hi-Hat [F4 (HH MIDI)] (p. 36).
Gate	0.1–8.0 (s)	
[F5 (BR MIDI)]		
Brush Note No.	0 (C –)–127 (G9), OFF	Refer to MIDI Note Number transmitted by Brush Sweep/Cross Stick [F5 (BR MIDI)] (p. 36).
XStick Note No.	0 (C –)–127 (G9), OFF	

Playing a Pattern by Hitting a Pad (Pad Pattern) [F1 (PATTERN)]

This function starts playback of a pattern when a pad is struck. This function provides a very convenient way to use patterns during a live performance.

If different patterns have been assigned to two or more pads, striking another pad while a pattern is playing back will cause pattern playback to switch to the newly selected pattern.

* Performances using the Pad Pattern function cannot be recorded to sequencers.

Pad Pattern: OFF, P 1–100, U 101–200

Selects the played back pattern when the pad is struck.

* If all pads are set to “OFF,”  icon appears.

Pad Ptn Velocity: OFF, ON

OFF:

The pattern plays back at the velocity set for the pattern, regardless of the strength with which the pad is struck.

ON:

The pattern plays back with the velocity changing in response to the strength with which the pad is struck.

Tap Ptn Mute Grp: OFF, 1–8

In Tap playback (p. 58), if one sound (pattern) is set to play before the previous sound (pattern) has finished playing, this setting allows you to either have the previous sound stop and the subsequent sound start playing or have the two sounds layered.

Patterns set to the same number:

The previous sound stops while in progress, and the subsequent sound (pattern) starts playing.

Patterns set to the different numbers:

The previous sound continues to play to the end, while the subsequent sound (pattern) is superimposed on it.

Changing the Pitch with the Hi-Hat Pedal [F2 (PDLBEND)]

This setting allows you use the hi-hat pedal as a pitch bender for sounds assigned to any pad or rim.

Specified in semitone steps.

Pedal Bend Range: -24–0– +24

MIDI Settings for Each Pad [F3 (MIDI)]

Tx Channel: CH1–CH16, GLOBAL

MIDI transmit channel for each pad.

GLOBAL: Transmits on the same channel as the drum kit part (p. 74).

Note No.: 0 (C –)–127 (G 9), OFF

OFF: Note messages are not transmitted.

Gate Time: 0.1–8.0 (s)

See the column.

Position Ctrl: OFF, ON

This can be set for trigger inputs SNARE (Head, Rim), TOM (Rim), RIDE (Bow), and AUX (Rim).

This turns the changing of the sound by strike position/rim shot nuance ON or OFF.

SNARE (Head): Strike position

SNARE (Rim): Rim shot nuance

TOM (Rim): Rim shot nuance

RIDE (Bow): Strike position

AUX (Rim): Rim shot nuance

MIDI Note Numbers transmitted by Hi-Hat [F4 (HH MIDI)]

Open (Bow): Bow shot of open hi-hat

Closed (Bow): Bow shot of closed hi-hat

Open (Edge): Edge shot of open hi-hat

Closed (Edge): Edge shot of closed hi-hat

Pedal: Pedal hi-hat (Foot closed)

Note No.: 0 (C –)–127 (G 9), OFF

OFF: Note messages are not transmitted.

Gate: 0.1–8.0 (s)

See the column.

MIDI Note Number transmitted by Brush Sweep/Cross Stick [F5 (BR MIDI)]

Brush Note No.: 0 (C –)–127 (G 9), OFF

OFF: Note messages are not transmitted.

XStick Note No.: 0 (C –)–127 (G 9), OFF

OFF: Note messages are not transmitted.

When Setting Multiple Pads to the Same Note Number

When the note number is set to be more than one pad received, the instrument assigned to the pad with the lowest TRIGGER INPUT number is played. When note numbers for the head and rim are duplicated, the head instrument is played.



An asterisk (*) appears at the right of the note number for TRIGGER INPUTS that are not sounded.

Example:

Note number “38 (D 2)” is set for the head and rim of TRIGGER INPUT 2 (SNARE) and the head of TRIGGER INPUT 3 (TOM 1). In this case, when Note Number “38” is received, the instrument assigned to the head of TRIGGER INPUT 2 (SNARE) is played.

About the Gate Time

Percussion sound modules normally produce sound only in response to “Note on” messages, and ignore “Note off” messages. However general-purpose sound modules or samplers do receive the note-off messages that are transmitted and respond by turning off the sound.

For example, if you are triggering a “loop” in a sampler, or other sounds then the gate time parameter is very important. With the factory defaults (preset values), the transmitted gate time is set to the minimum value.

Chapter 3. Mixer Settings

Mixer Parameters [MIXER]

Here you can adjust the volume, pan, etc.

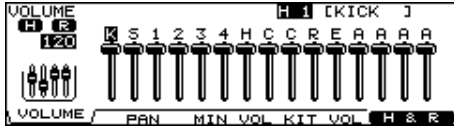

1. Press [MIXER].
[MIXER] lights.
2. Use [F1]–[F5] or [CURSOR (up/down)] to select the parameter.
3. Use TRIG SELECT [1], [15], [RIM], or [CURSOR (left/right)] to select the instrument you wish to set.
You can also select the instrument by striking a pad.
4. Use [+/-], [VALUE], or [CURSOR (up/down)] to make the setting.

Parameter	Value	Description
[F1 (VOLUME)]		
Volume	0–127	Volume of each trigger input
[F2 (PAN)]		
Pan	L15–CTR–R15	Pan of each trigger input
[F3 (MIN VOL)]		
Minimum Volume	0–10	Minimum volume of each trigger input (This is used to narrow the dynamic range.)
[F4 (KIT VOL)]		
Kit Volume	0–127	Volume of the entire drum kit
Pedal HH Volume	0–127	Volume of the hi-hat’s foot closed sound
XStick Volume	0–127	Volume of cross stick sound

* Pressing [F5 (H & R)] in the [F1 (VOLUME)], [F2 (PAN)], or [F3 (MIN VOL)] setting screen, you can choose to set the head and rim simultaneously or individually.

5. Press [EXIT] to return to the “DRUM KIT” screen.

Using Group Faders to Edit (MIX EDIT)

You can use the GROUP FADERS to make adjustments.

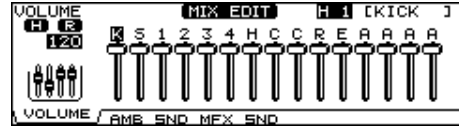

1. Press [MIXER] and [FADER] simultaneously.
[MIXER] lights, and [FADER] flashes.
2. Press [F1]–[F4] to select the parameter.
3. Move the fader which corresponds to the TRIGGER INPUT you wish to adjust.

* You can also use [+/-], [VALUE], or [CURSOR (up/down)].

Parameter	Value	Description
[F1 (VOLUME)]		
Volume	0–127	Volume of each trigger input
[F2 (AMB SND)]		
AMB SEND LEVEL	0–127	Send level to the ambience for each trigger input
[F3 (MFX SND)]		
MFX SEND LEVEL	0–127	Send level to the multi-effects for each trigger input

* These settings are always common to the head and rim.

4. Press [EXIT] or [FADER] to return to the “DRUM KIT” screen.

* After pressing [EXIT] or [FADER], the values for the [GROUP FADERS] sliders may not reflect the actual volume of the sound assigned to that fader. Be sure to move the faders a bit before making your setting.

Chapter 4. Effect Settings

Effects On and Off Switches [EFFECTS SWITCH]

These switches allow you to turn all individual effects and master effects on/off within each drum kit.

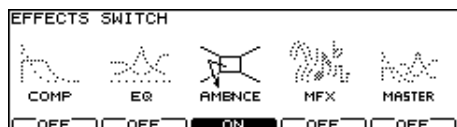

1. Press [EFFECTS SWITCH].
[EFFECTS SWITCH] lights, and the "EFFECTS SWITCH" screen appears.
2. Press [F1]–[F5] to turn the following on/off.
[F1]: Pad Compressor (*1)
[F2]: Pad Equalizer (*1)
[F3]: Ambience
[F4]: Multi-effects
[F5]: Master Effects

3. Press [EXIT] to return to the "DRUM KIT" screen.

* Effect on/off status appears in the "DRUM KIT" screen.



* 1: All pad compressors or pad equalizers are turned on/off simultaneously.

Using the Compressor and EQ [COMP/EQ]

An individual Compressor and EQ can be applied to every sound assigned to a trigger input.

1. Press [COMP/EQ].
[COMP/EQ] lights.
2. Strike the pad you wish to set.
3. Press [F2], [F3], or [CURSOR] to select the parameter.

Function Buttons

[F2 (COMP)]

Pad compressor parameters appear.

[F3 (EQ)]

Pad equalizer parameters appear.

4. Use [+/-] or [VALUE] to adjust the setting.
5. Press [F1] and/or [F4] to turn on the compressor/equalizer for each trigger input.

[F1]: Turns the pad compressor on/off

[F4]: Turns the pad equalizer on/off

[CMP ON], [EQ ON]

COMP/EQ setting is ON, EFFECTS SWITCH is ON
Effect applies.

[CMP ON], [EQ OFF]

COMP/EQ setting is ON, EFFECTS SWITCH is OFF
Effect does not apply.

[OFF]

COMP/EQ setting is OFF
Effect does not apply.

* Pressing [F5 (H & R)], you can choose to set the head and rim simultaneously or individually.

NOTE

The sound may be distorted in a certain setting.

Compressor (COMP)

A compressor adjusts the envelope (changes in the volume over time) and changes the character of the sound in response to playing dynamics.

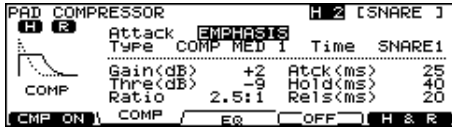

Parameter	Value	Description
Attack	EMPHASIS, CRUSH	EMPHASIS Emphasizes the attack of the sound. CRUSH Press the attack.
Type	COMP SOFT 1-2, COMP MED 1-3, COMP HARD 1-2, LIMITER 1-2, EXPANDER 1-3	This changes Thre and ratio values.
Time	KICK 1-3, SNARE1-3, TOM 1-3, CYM 1-2, OTHER1-3	This changes Atck, Hold, and Rels values.

For more detailed setting, adjust the parameters below.

Parameter	Value	Description
Gain	-15- +20 (dB)	Output level of the compressor
Thre (Threshold)	-30-0 (dB)	Volume level at which compression begins
Ratio	0.5:1-50:1	Compression ratio
Atck (Attack)	0-255 (ms)	Time from when the volume goes up the threshold level until the compressor effect applies
Hold	2-9999 (ms)	Time compression is kept
Rels (Release)	2-9999 (ms)	Time from when the volume falls below the threshold level until the compressor effect no longer applies

About Threshold and Ratio

As shown in the diagram below, these parameters determine how the volume is to be compressed.

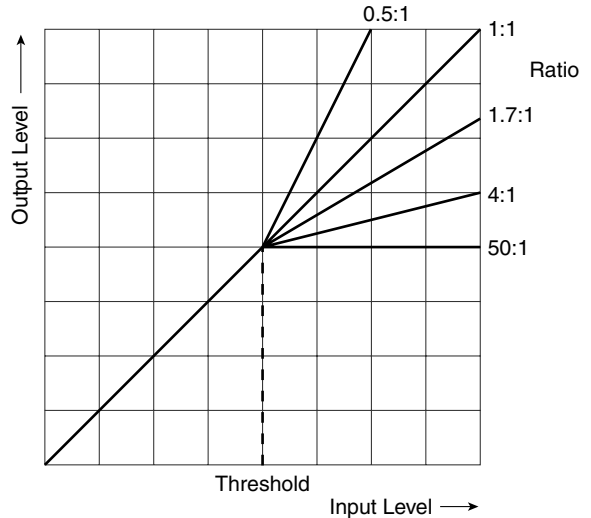

Equalizer (EQ)

You can use three-band equalizers (for high, middle, and low frequency ranges) to adjust the sound.

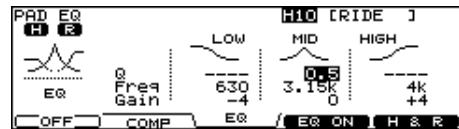

Parameter	Value	Description
Q	0.5-8.0 (only for MID)	Width of the frequency range A higher Q narrows the affected area.
Freq (Frequency)	20-1k (LOW), 20-8k (MID), 1k-8k (HIGH)	Point at which the boost/cut will occur
Gain	-15- +15 (dB)	Amount of boost/cut

Ambience [AMBIENCE]

You can choose the type of room where the drums are to be played and modify the sound.



1. Press [AMBIENCE].
[AMBIENCE] lights.
2. Press [F2]–[F4] or [CURSOR] to select the parameter.
3. Use [+/-] or [VALUE] to adjust the setting.
4. Press [F1] to turn the ambience on.

Parameter	Value	Description
[F2 (TYPE)]		
Room Type	BEACH, LIVING ROOM, BATH ROOM, STUDIO, GARAGE, LOCKER ROOM, THEATER, CAVE, GYMNASIUM, DOME STADIUM	Location where the drums are played
Level	0–127	Total ambience level
[F3 (ROOM)]		
Room Size	TINY, SMALL, MEDIUM, LARGE, HUGE	5 size available
Wall Type	WOOD, PLAS-TER, GLASS	Wall material
Mic Position	LOW, HIGH	Ambience mic position
Room Shape	0–100	Shape of the room
[F4 (AMB SND)]		
Send Level	0–127	Ambience send level for each instrument

* Pressing [F5 (H & R)] in the [F4 (AMB SND)] setting screen, you can choose to set the head and rim simultaneously or individually.

Multi-Effects [MULTI EFFECTS]

The multi-effects allow you to further customize your sound and also provides a choice of output configurations.

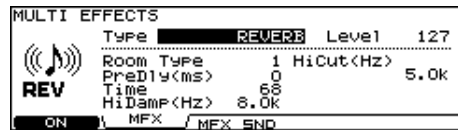

1. Press [MULTI EFFECTS].
[MULTI EFFECTS] lights.
2. Press [F2], [F3], or [CURSOR] to select the parameter.
3. Use [+/-] or [VALUE] to adjust the setting.
4. Press [F1] to turn the multi-effects on.

Parameter	Value	Description
[F2 (MFX)]		
Type	REVERB, GATE REVERB, DELAY, PANNING DELAY, BEAT DELAY, FLANGER, PHASER, CHORUS, ENHANCER, PITCH SHIFT, OVER-DRIVE, DISTORTION, LO-FI, RING MOD	Type of multi-effects
Level	0–127	Total effect level
[F3 (MFX SND)]		
Send Level	0–127	Effect SEND level for each instrument

* Pressing [F5 (H & R)] in the [F3 (MFX SND)] setting screen, you can choose to set the head and rim simultaneously or individually.

Multi-Effects Parameters

REVERB

Adds reverberation to the sound, simulating an acoustic space.

Parameter	Value	Description
Room Type	1–5	Type of reverb 1: Lite 2: Medium 3: Deep 4: Shallow 5: Thin
PreDly	0–100.0 (ms)	Time until the reverb is heard
Time	0–127	Duration of reverberation
HiDamp	4.0k–12.5k (Hz), THRU	Frequency above which the reverb is reduced in level
HiCut	160–12.5k (Hz), THRU	Frequency above which the high-frequency content of the reverb sound is filtered out

GATE REVERB

This is a special type of reverb in which the reverb is cut off without being allowed to decay naturally.

Parameter	Value	Description
Room Type	1–5	Type of reverb 1: Lite 2: Medium 3: Deep 4: Shallow 5: Thin
Time	0–127	Duration of reverberation
HiCut	160–12.5k (Hz), THRU	Frequency above which the high-frequency content of the reverb sound is filtered out
HiDamp	4.0k–12.5k (Hz), THRU	Frequency above which the reverb is reduced in level
Thre (Threshold)	-60– +12 (dB)	Volume level at which the reverb starts to be gated
Hold	0.05–2.00 (s)	Time from when the reverb level falls below the Threshold until the gate starts to close

Parameter	Value	Description
Rels (Release)	0–200 (ms)	Time from the start to the completion of the gate closing process

DELAY

Adds the delay sound.

Parameter	Value	Description
Time	0–2000 (ms)	Time until the delay sound is heard
Feedback	-98–98 (%)	Amount of the delay sound that is fed back into the effect (minus: inverts the phase)

PANNING DELAY

This is a delay effect with echoes that pan left and right.

Parameter	Value	Description
TimeL	0–1500 (ms)	Time until the delay sound is heard
TimeR		
Level L	0–127	Volume level of the delay sound
Level R		
Feedback	-98–98 (%)	Amount of the delay sound that is fed back into the effect (minus: inverts the phase)

BEAT DELAY

This is a delay effect that synchronizes with a tempo in sequencer.

Parameter	Value	Description
Time	32th note–half note	Time until the delay sound is heard
Shift	-half note–0–+half note	Time of shifting the interval between the 1st and 2nd delay
Level 1	0–127	Volume level of the delay sound
Level 2		
Pan 1	L15–CTR–R15	Stereo position of the delay sound
Pan 2		
Feedback	-98–98 (%)	Amount of the delay sound that is fed back into the effect (minus: inverts the phase)

* If you set Tempo, Time, and Shift to make the delay time over 1500 ms, the delay time cannot be more than 1500 ms.

FLANGER

Produces a metallic resonance that rises and falls somewhat like a jet airplane taking off or landing.

Parameter	Value	Description
Delay	0–15.0 (ms)	Tone of the flanger
LFO Rate	1–128	Frequency of modulation
Depth	0–127	Depth of modulation
Feedback	-98–98 (%)	Amount of the flanger sound that is fed back into the effect (minus: inverts the phase)
Phase	0–180	Spatial spread of the sound

PHASER

Adds a phase-shifted sound to the original sound, producing a swirling modulation.

Parameter	Value	Description
Freq	100–8000 (Hz)	Basic frequency at which the sound will be modulated
LFO Rate	1–128	Frequency of modulation
Depth	0–127	Depth of modulation
Resonance	0–127	Amount of feedback

CHORUS

Gives richness and spaciousness to the sound.

Parameter	Value	Description
Delay	8.0–30.0 (ms)	Tone of the chorus
LFO Rate	1–128	Frequency of modulation
Depth	0–127	Depth of modulation
Phase	0–180	Spatial spread of the sound

ENHANCER

Controls the overtone structure of the high frequencies, adding sparkle and brightness to the sound.

Parameter	Value	Description
Sens	0–127	Sensitivity of the enhancer
LF Level	0–127	Volume level of the low frequency range of the direct sound

PITCH SHIFT

Shifts the pitch of the original sound.

Parameter	Value	Description
Mode	1–5	Setting a higher value results in a slower response, but steadier pitch.
Delay	0–100.0 (ms)	Time until the pitch-shifted sound is heard
Coarse	-24–12	Amount of pitch shift (semitone steps)
Fine	-100–100	Amount of pitch shift (2-cent steps)
Feedback	-98–98 (%)	Amount of the pitch-shifted sound that is fed back into the effect (minus: inverts the phase)

OVERDRIVE

Creates a soft distortion similar to that produced by vacuum tube amplifiers.

Parameter	Value	Description
Drive	0–127	Amount of distortion
HF Level	0–127	Level of high frequency range
LF Bypass	OFF, ON	Bypass for the low frequency range When this is set to “OFF,” the low frequency range also has a distortion sound.
Expans	OFF, ON	Adding the spatial spread of the sound

DISTORTION

Produces a more intense distortion than Overdrive.

Parameter	Value	Description
Gain	0–127	Amount of distortion
HF Level	0–127	Level of high frequency range
LF Bypass	OFF, ON	Bypass for the low frequency range When this is set to “OFF,” the low frequency range also has a distortion sound.
Expans	OFF, ON	Adding the spatial spread of the sound

LO-FI

Intentionally degrades the sound quality for creative purposes.

Parameter	Value	Description
Fs Rate	OFF, 1/2-1/32	Sample rate
Bit	OFF, 15-1	Number of bits in data
BPF Cutoff	0-100	Cutoff frequency of the BPF (Band Pass Filter)
BPF Mix	0-127	Amount of mixing the sound that goes through the BPF

RING MOD

Applies amplitude modulation (AM) to the input signal, producing bell-like sounds.

Parameter	Value	Description
Freq	0-127	Frequency at which modulation is applied

Master Effects [MASTER COMP/EQ]

A stereo compressor (limiter)/three-band equalizer provides final audio touches to the total sound of the TD-20. Can be used for each kit and/or all kits.



1. Press [MASTER COMP/EQ].
[MASTER COMP/EQ] lights.
2. Press [F2], [F3], or [CURSOR] to select the parameter.
3. Use [+/-] or [VALUE] to adjust the setting.
4. Press [F1] to turn the master effects on.

Parameter	Value	Description
[F2 (M COMP)]		
Threshold	-60-0 (dB)	Volume level at which compression begins
Ratio	1:1-100:1	Compression ratio
Attack	0-100	Time from when the volume goes up the threshold level until the compressor effect applies

Parameter	Value	Description
Release	0-100	Time from when the volume falls below the threshold level until the compressor effect no longer applies
Gain	-60- +12 (dB)	Output volume of compressor
[F3 (M EQ)]		
Type	SHELV (Shelving), PEAK (MID: fixed to "PEAK")	SHELVE: Entire range above/below the selected frequency range is boosted/cut PEAK: The vicinity of the selected frequency range is boosted/cut
Q	0.5-8.0 (only when Type is set to "PEAK")	Width of the frequency range A higher Q narrows the affected area.
Freq (Frequency)	20-1k (LOW), 20-16k (MID), 1k-16k (HIGH)	Point at which the boost/cut will occur
Gain	-12- +12	Amount of boost/cut

NOTE

The sound may be distorted in a certain setting.



You can use the master effect on "per kit" basis, or as a global one (p. 80).

Chapter 5. Trigger Settings [TRIGGER]

Selecting the Pad Type [F1 (BANK)]

To be sure the TD-20 accurately receives signals sent from the pads, select the **trigger type** (the type of pads being used) for each trigger input.

Trigger Type

A **trigger type** is a group of trigger settings with values optimally adjusted for a particular pad. Indications such as “KD120,” “PD125,” or “VH12,” etc. in the above display correspond to this. When you select a trigger type for a connected pad, each of the parameters is set to the most appropriate values for that pad, allowing you to play it without encountering problems with the settings. Only when factors unrelated to the selection of the proper trigger type prevent you from getting good results in performance should you fine-tune the individual parameters for the pad you are using.

Trigger Bank

Trigger Banks allow you to store the 15 trigger settings as a single unit of information. The large number at the left edge of the above display is the Trigger Bank number. Move the cursor to this area to select the Trigger Bank.

1. Press [TRIGGER] - [F1 (BANK)].

[TRIGGER] lights, and the “TRIGGER BANK” screen will appear.

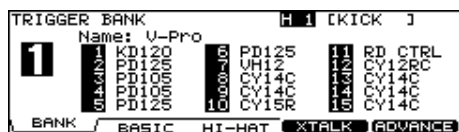

2. Press [CURSOR (left)] to move the cursor to the Trigger Bank number.

3. Use [+/-] or [VALUE] to select the Trigger Bank.

4. Press [CURSOR (right)] to move the cursor to a trigger type.

5. Strike the pad you wish to set.

The cursor will move to the trigger type for the struck pad.

You can also select by using [CURSOR] or [TRIG SELECT].

6. Use [+/-] or [VALUE] to select the trigger type.

Trigger Type	Used Model
PD125	PD-125
PD120	PD-120
PD105	PD-105
PD100	PD-100
PD85	PD-85, PD-80R, PD-80
PD9	PD-9
PD8	PD-8
PD7	PD-7
PD6	PD-6
KD120	KD-120
KD85	KD-85, KD-80
KD8	KD-8
KD7	KD-7
CY15R	CY-15R
CY12RC	CY-12R/C
CY14C	CY-14C
CY8	CY-8
CY6	CY-6
CY12H	CY-12H
VH12	VH-12
VH11	VH-11
PAD1	When using a non-Roland pad
PAD2	
RT7K	RT-7K
RT5S	RT-5S
RT3T	RT-3T

* When you select the trigger type, the trigger parameters (except the crosstalk cancel parameters) are automatically set to the most efficient values for each pad. Make settings for the parameter as needed.

* When 3Way Trigger (p. 50) is set to ON, “RD CTRL” is displayed for the trigger type for TRIGGER INPUT 11 EDGE. It cannot be changed.

Trigger Inputs and Pad/Playing Methods corresponding chart

Trigger Input	Dual Trigger Mesh Pad	Positional Sensing	Rim Shot Nuance
KICK	x	x	x
SNARE	o	o	o
TOM 1-4	o	x	o
HI-HAT	x	x	x
CRASH 1, 2	x	x	x
RIDE	x	o	x
EDGE	x	x	x
AUX 1-4	o	x	o

* Brush sweep and Cross Stick can be used only SNARE.

* Each playing method can be used with the instruments corresponding to it (p. 95).

Setting the Pad Sensitivity [F2 (BASIC)]

When you are using pads made by other manufacturers, try adjusting the following parameters.

1. Press [TRIGGER] - [F2 (BASIC)].

[TRIGGER] lights, and the “TRIGGER BASIC” screen will appear.



2. Use [CURSOR (up/down)] to select the parameter.

3. Strike the pad you wish to set.

The setting screen for the struck pad will appear. You can also select by using [TRIG SELECT].

4. Use [+/-] or [VALUE] to adjust the setting.

5. When you're finished, press [EXIT] to return to the “DRUM KIT” screen.

Parameter	Value	Description
Trig Type	refer to p. 44	
Sensitivity	1-32	Pad sensitivity
Threshold	0-31	Minimum level for the pad
Curve	LINEAR, EXP1, EXP2, LOG1, LOG2, SPLINE, LOUD1, LOUD2	How playing dynamics changes the volume

Pad Sensitivity

You can adjust the sensitivity of the pads to accommodate your personal playing style.

This allows you to have more dynamic control over the sound volume, based on how hard you play.

Sensitivity: 1-32

Higher sensitivity allows the pad to produce a loud volume even when played softly.

Lower sensitivity will keep the pad producing a low volume even when played forcefully.

Minimum level for the pad (Threshold)

This setting allows a trigger signal to be received only when the pad is above a determined force level (velocity). This can be used to prevent a pad from sounding because of vibrations from other pads.

In the following example, B will sound but A and C will not sound.

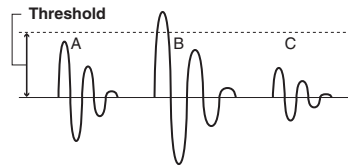

Threshold: 0-31

When set to a higher value, no sound is produced when the pad is struck lightly.

Gradually raise the “Threshold” value while striking the pad. Check this and adjust accordingly. Repeat this process until you get the perfect setting for your playing style.

How Playing Dynamics Changes the Volume (Velocity Curve)

This setting allows you to control the relation between playing velocity (striking force) and changes in volume. Adjust this curve until the response feels as natural as possible.

Curve: LINEAR

The standard setting. This produces the most natural correspondence between playing dynamics and volume change.

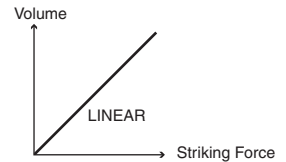

Curve: EXP1, EXP2

Compared to LINEAR, strong dynamics produce a greater change.

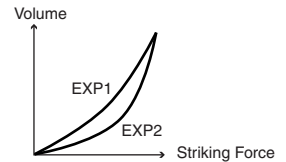

Curve: LOG1, LOG2

Compared to LINEAR, a soft playing produces a greater change.

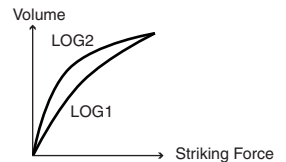

Curve: SPLINE

Extreme changes are made in response to playing dynamics.

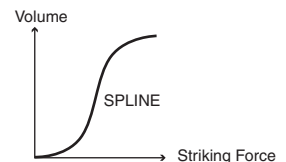

Curve: LOUD1, LOUD2

Very little dynamic response, making it easy to maintain strong volume levels. If using drum triggers, these settings help maintain stable levels.

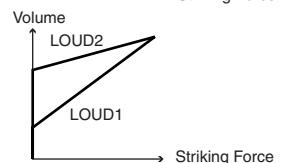

Hi-Hat Settings [F3 (HI-HAT)]

1. Press [TRIGGER] - [F3 (HI-HAT)].

[TRIGGER] lights, and the “TRIGGER HIHAT” screen will appear.



2. Use [CURSOR (up/down)] to select the parameter.

3. Use [+/-] or [VALUE] to adjust the setting.

4. When you're finished, press [EXIT] to return to the “DRUM KIT” screen.

Parameter	Value	Description
Hi-Hat Type	VH12, VH11/FD	Used Hi-Hat Controller VH12: VH-12 VH11/FD: VH-11, FD-8

• When Hi-Hat Type is set to “VH12”

Parameter	Value	Description
Offset	-100- +100	Extent of Opening Hi-Hat The bigger the value is, the wider the opening extent is.
Foot Splash Sens	-10- +10 (Initial Value: +5)	Amount of how easy to make the Foot Splash
Noise Cancel	1-3 (Initial Value: 1)	Amount of strength to cancel the bow and edge noise when you play “Foot Close.” The bigger the value is, the more difficult to have a noise excluding the “Foot Close.”

• When Hi-Hat Type is set to “VH11/FD”

Parameter	Value	Description
Foot Splash Sens	-10- +10 (Initial Value: +8)	Amount of how easy to make the Foot Splash
CC Max	90, 127 (Initial Value: 90)	Amount of Control Change that is transmitted in stepping the pedal down completely.
CC Resolution	NORMAL, HIGH (Initial Value: NORMAL)	Amount of Data Resolu- tion that is transmitted from Hi-Hat Pedal. (*1)

*1: When you control the pitch by Hi-Hat Pedal (p. 35), the pitch can be changed smoothly if you set “High.”

Adjusting the Offset of VH-12 Automatically

1. Press [TRIGGER] - [F3 (HI-HAT)].

2. Press [F5 (OFFSET)].

The “VH OFFSET ADJUSTMENT” screen will appear.

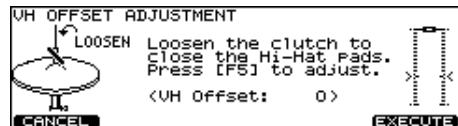

3. Loosen the clutch of the top hi-hat and let it sit on the bottom hi-hat.

* Do NOT touch the hi-hats or the pedal.

4. Press [F5 (EXECUTE)].

[TRIGGER] flashes, and the “VH offset” parameter is set automatically.

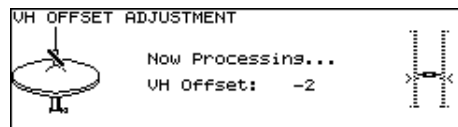

When finished, [TRIGGER] stops flashing and remains lit, and the following screen appears.

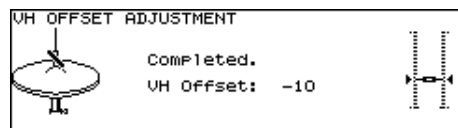

HINT

You can also perform this operation by holding down [KIT] and pressing [TRIGGER] (p. 21).

Adjusting the Offset of VH-11

1. Connect the VH-11 and TD-20.

2. After making the hi-hat settings, release your foot from the pedal, and while keeping your foot off the pedal, turn on the power to the TD-20.

3. Loosen the clutch screw and let the hi-hat rest naturally on the motion sensor unit.

4. Press [TRIGGER] - [F1 (BANK)].

* [TRIGGER] lights, and the “TRIGGER BANK” screen appears.

- Set the trigger type for hi-hat to “VH11” (p. 44).
- Press [TRIGGER] - [F3 (HI-HAT)].
 - * The “TRIGGER HI-HAT” screen appears.
- Set the TD-20’s parameters as described below.

Parameter	Value
Hi-Hat Type	VH11/FD
Foot Splash Sens	+8
CC Max	90
CC Resolution	NORMAL

- While reading the meter displayed on the right side of the TD-20’s screen, adjust the offset with the VH-11’s VH offset adjustment screw.

Adjust the offset so that the black  appear in the meter.



* For detailed descriptions regarding the VH-11, instructions on connections, and other information, refer to the VH-11 Owner’s Manual.

Eliminate Crosstalk Between Pads [F4 (XTALK)]

When two pads are mounted on the same stand, hitting one pad may trigger the sound from another pad unintentionally. (This is called **crosstalk**.) Eliminate this by adjusting Xtalk Cancel on the pad that is sounding inadvertently.

HINT

In some cases, you can prevent crosstalk between two pads by increasing the distance between them.

- Press [TRIGGER] - [F4 (XTALK)].
- Use [F1]–[F3] to select the parameter.
- Strike the pad you wish to set.
 - The cursor will move to the trigger input number for the struck pad.
 - You can also select by using [CURSOR] or [TRIG SELECT].
- Use [+/-] or [VALUE] to adjust the setting.
- When you’re finished, press [EXIT] to return to the “DRUM KIT” screen.

[F1 (XTALK)]: XTALK CANCEL

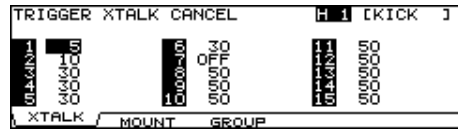

[F2 (MOUNT)]: MOUNT TYPE

Select the pad mount type here.

PAD: Using a pad mount

CYMBAL: Using a cymbal mount



[F3 (GROUP)]: XTALK GROUP

Crosstalk Cancel affects the pads set to the same number.

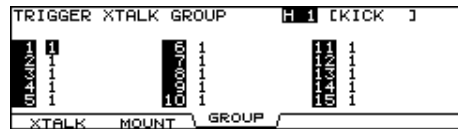

Crosstalk Example: If you hit the snare pad and the tom 1 also sounds

Set the snare and tom 1 to the same group. Raise the “XTALK CANCEL” for the pad being used for the tom 1. The tom 1 pad will be less prone to receive crosstalk from other pads. With a setting “OFF,” crosstalk prevention will not work.

* If the value is set too high, and two pads are played simultaneously, the one that is struck less forcefully may not sound. Be careful and set this parameter to the minimum value required to prevent crosstalk.

Advanced Trigger Parameters [F5 (ADVANCE)]

The following parameters (Advanced Trigger Parameters) are automatically set to the most efficient values for each pad when you select the Trigger Type (p. 44), and don't require adjustment, except if you experience any of the problems that are discussed in the explanation of each parameter.

1. Press [TRIGGER] - [F5 (ADVANCE)].
2. Use [F1]–[F3] and [CURSOR (up/down)] to select the parameter.
3. Strike the pad you wish to set.
The setting screen for the struck pad will appear.
You can also select by using [TRIG SELECT].
4. Use [+/-] or [VALUE] to adjust the setting.
5. When you're finished, press [EXIT] to return to the "DRUM KIT" screen.

Parameter	Value	Description
[F1 (SCAN)]		
Trig Type	refer to p. 44	
Scan Time	0–4.0 (ms)	Trigger signal detection time
Retrig Cancel	1–16	Detecting trigger signal attenuation
Mask Time	0–64 (ms)	Double triggering prevention (p. 49)
[F2 (RIM)]		
Trig Type	refer to p. 44	
Rim Gain	0–3.2	Rim/Edge dynamic response (p. 49)
RimShot Adjust	0–8.0	Rim shots response (p. 49)
XStick Thrshld	0–127	Cross stick response (p. 49)
[F3 (3-WAY)]		
3Way Trigger (Ride & Edge)	OFF, ON	Playing Bow/Bell/Edge (p. 50)
[F5 (NAME)]	Trigger Bank Name (p. 50)	

Trigger Signal Detection Time (Scan Time)

Since the rise time of the trigger signal waveform may differ slightly depending on the characteristics of each pad or acoustic drum trigger (drum pickup), you may notice that identical hits (velocity) may produce sound at different volumes. If this occurs, you can adjust the "Scan Time" so that your way of playing can be detected more precisely.

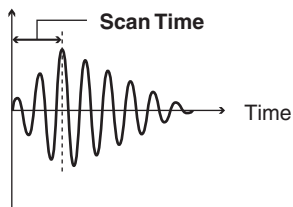

Scan Time: 0–4.0 (ms)

While repeatedly hitting the pad at a constant force, gradually raise the Scan Time value from 0 msec, until the resulting volume stabilizes at the loudest level. At this setting, try both soft and loud strikes, and make sure that the volume changes appropriately.

* As the value is set higher, the time it takes for the sound to be played increases. Set this to the lowest value possible.

Detecting Trigger Signal Attenuation (Retrigger Cancel)

Important if you are using acoustic drum triggers. Such triggers can produce altered waveforms, which may also cause inadvertent sounding at Point A in the following figure (Retrigger).

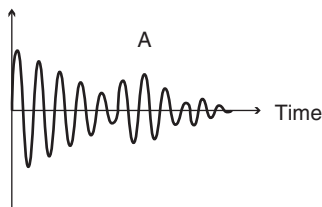

This occurs in particular at the decaying edge of the waveform. Retrigger Cancel detects such distortion in and prevents retriggering from occurring.

Retrig Cancel: 1–16

While repeatedly striking the pad, raise the "Retrig Cancel" value until retriggering no longer occurs.

* Although setting this to a high value prevents retriggering, it then becomes easy for sounds to be omitted when the drums played fast (roll etc.). Set this to the lowest value possible while still ensuring that there is no retriggering.

MEMO

You can also eliminate this problem of retriggering with the Mask Time setting. Mask Time does not detect trigger signals if they occur within the specified amount of time after the previous trigger signal was received. Retrigger Cancel detects the attenuation of the trigger signal level, and triggers the sound after internally determining which trigger signals were actually generated when the head was struck, while weeding out the other false trigger signals that need not trigger a sound.

Double Triggering Prevention (Mask Time)

When playing a kick trigger the beater can bounce back and hit the head a second time immediately after the intended note—with acoustic drums sometimes the beater stays against the head—this causes a single hit to “double trigger” (two sounds instead of one). The Mask Time setting helps to prevent this. Once a pad has been hit, any additional trigger signals occurring within the specified “Mask Time” (0–64 msec) will be ignored.

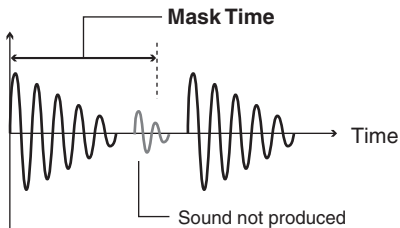

Mask Time: 0–64 (ms)

Adjust the “Mask Time” value while playing the pad.

When using a kick trigger, try to let the beater bounce back and hit the head very quickly, then raise the “Mask Time” value until there are no more sounds made by the beater rebound.

* When set to a high value, it will be difficult to play very quickly. Set this to as low a value as you can.

MEMO

If two or more sounds are being produced when you strike the head just once, then adjust Retrigger Cancel.

Rim/Edge Dynamic Response (Rim Gain)

When a PD-125/120/105, PD-80R, PD-9/8/7, CY series pad, VH-12, or RT-5S (trigger) is connected, you can adjust the relation between your playing velocity (force) on the rim/edge and the resulting volume level.

Rim Gain: 0–3.2

Higher value allows the rim/edge to produce a loud volume even when played softly. Lower value will keep the rim/edge producing a low volume even when played forcefully.

Rim Shots Response (Rim Shot Adjust)

When a PD-125/120/105/80R or RT-5S (trigger) is connected, you can adjust the sensitivity of the rim response.

RimShot Adjust: 0–8.0

There are some cases that you have a rim sound unexpectedly when you hit the head strongly. You can improve this situation with decreasing the value of “RimShot Adjust.”

* When you set the value too small, it might be difficult to play the rim sound.

Cross Stick Threshold (XStick Thrshld)

When a PD-125/120/105/80R or RT-5S (trigger) is connected, you can determine the “cross over point” between the cross stick and a rim shot sounds.

XStick Thrshld: 0–127

Setting this to a higher value makes it easier to get cross stick sounds. When set to “0,” playing a cross stick produces the open rim shot sound.

* Increasing the value excessively may cause the cross stick to sound as well when the open rim shot is played.

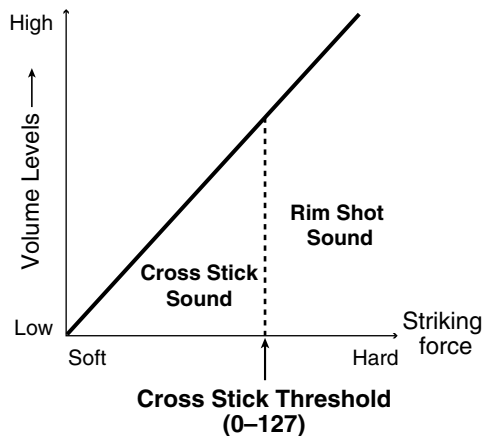

Playing Bow, Bell, and Edge (3-Way Triggering)

When using the CY-15R or CY-12R/C for the RIDE, you can three way triggering (bow, bell, and edge shot) performance are possible.

3Way Trigger: OFF, ON

Connect as shown below, set 3Way Trigger to "ON."

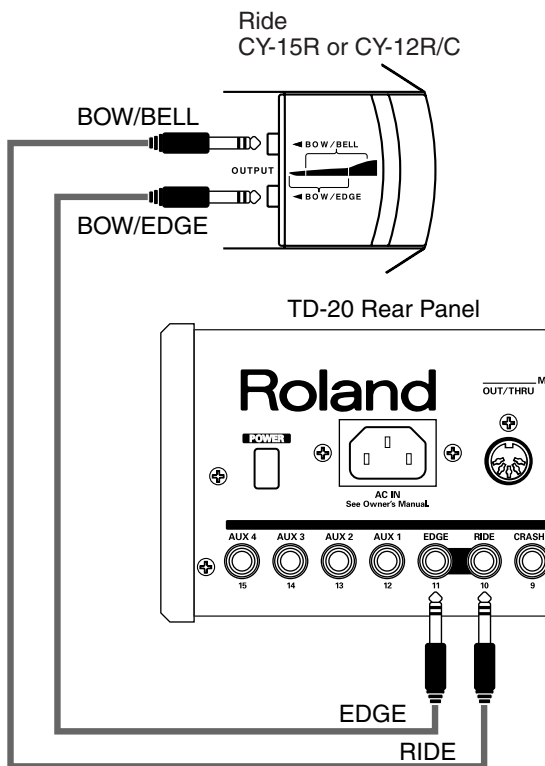

Correspondences Between Playing Method and Trigger Input

Playing Method	TD-20 TRIGGER INPUT
Bow Shot	10 RIDE head
Bell Shot	10 RIDE rim
Edge Shot	11 EDGE rim

* Head-side tone for the TRIGGER INPUT 11 EDGE cannot be sounded.

* When 3Way Trigger is set to "ON," "RD CTRL" is displayed for the trigger type for TRIGGER INPUT 11 EDGE. It cannot be changed.

Naming a Trigger Bank [F5 (Name)]

Each trigger bank can be named (up to 12 characters).



1. In the "TRIGGER BANK" screen, select the trigger bank you want to name.
2. [F5 (ADVANCE)] - [F5 (NAME)].
The "TRIGGER BANK NAME" screen appears.
3. [CURSOR (left/right)] to move the cursor to the character to be changed.
4. Use [VALUE], [+/-], or [CURSOR (up/down)] to change the character.

Function Buttons

[F1 (INSERT)]

A blank space is inserted at the cursor position.

[F2 (DELETE)]

Character at the cursor position is deleted.

[F3 (SPACE)]

Character at the cursor position is replaced by a blank space.

[F4 (CHAR)]

Character at the cursor position changes between uppercase/lowercase alphabet, or numbers and symbols.

5. When finished, Press [EXIT].

Chapter 6. Sequencer (Playback)

The TD-20's sequencer organizes music into six parts. The Drum Kit part is used to record/play back what is played on the pads. Additionally, Melody Part, Bass Part, Backing 1 Part, and Backing 2 Part are the four backing instrument parts, and there is another Percussion part.

The collective performance of these six parts is called a **pattern**.

Preset Patterns (Pattern P 1-100)

Settings in Preset patterns cannot be modified. These patterns are provided for use in practicing or live performances.

User Patterns (Pattern U 101-200)

These are patterns for you to use as you wish. You can record directly from the pads or an external MIDI keyboard in real time (p. 61). User pattern settings are saved automatically.

Using Preset Patterns

As you cannot record over a preset pattern, the following appears in the display if you press [REC].



If you want to change, edit, or record any Preset pattern settings, copy them to a User pattern (p. 64).

About Preset Pattern Copyright

The sounds, phrases and patterns contained in this product are sound recordings protected by copyright. Roland hereby grants to purchasers of this product the permission to utilize the sound recordings contained in this product for the creation and recording of original musical works; provided however, the sound recordings contained in this product may not be sampled, downloaded or otherwise re-recorded, in whole or in part, for any other purpose, including but not limited to the transmission of all or any part of the sound recordings via the internet or other digital or analog means of transmission, and/or the manufacture, for sale or otherwise, of any collection of sampled sounds, phrases or patterns, on CD-ROM or equivalent means.

The sound recordings contained in this product are the original works of Roland Corporation. Roland is not responsible for the use of the sound recordings contained in this product, and assumes no liability for any infringement of any copyright of any third party arising out of use of the sounds, phrases and patterns in this product.

Basic Operation

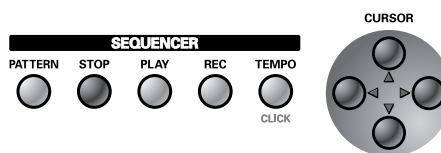

[PATTERN]:

Selects patterns. This displays the basic screen for the sequencer.

[STOP]

Stops playback of the pattern. When pressed while the pattern is stopped, this returns you to the beginning of the pattern.

[PLAY]

Starts playback of the pattern.

[REC]

Enters record-standby mode.

[TEMPO]

Sets the Tempo (p. 53).

[CURSOR (up)]

When pressed while the pattern is stopped, this returns you to the beginning of the pattern.

[CURSOR (left)]

When pressed while the pattern is stopped, this returns you to the previous measure in the pattern.

[CURSOR (right)]

When pressed while the pattern is stopped, this advances you to the next measure in the pattern.

[CURSOR (down)]

When pressed while the pattern is stopped, this advances you to the end of the pattern.

* [CURSOR] cannot be used while the pattern is played back.

Choosing a Pattern [PATTERN]



1. Press [PATTERN].
[PATTERN] lights, and the "PATTERN" screen appears.
2. Use [+/-] or [VALUE] to select the pattern.
** If you press [F5 (NEW)], an empty pattern with the lowest number is called up.*

About the "PATTERN" screen.

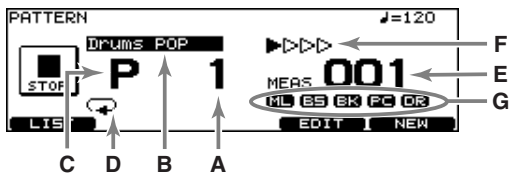

- A:** Pattern Number
Currently selected pattern number.
- B:** Pattern Name
The name of the currently selected pattern.
- C:** Pattern Type
"P" is displayed for preset patterns, and "U" is displayed for user patterns. When choosing an empty pattern, an asterisk (*) appears.
- D:** Pattern Playback Type (p. 58)
- E:** Measure Number
Playback begins from the measure indicated here when [PLAY] is pressed.
- F:** Beat
- G:** Part Mute Status (p. 54)

HINT

When you have finished making the settings, press [PATTERN] to bring up this screen. This prevents data from being overwritten inadvertently during performance.

Select a Pattern from the List [F1 (LIST)]

Here you can select patterns from a list of pattern names. Pattern number, pattern name, beat, measure length, pattern playback type, and tempo are displayed.

No.	Name	Beat	Len	Type	♩=
120	Drums POP	4/4	10	LOOP	120
180	Drums JAZZ	4/4	13	LOOP	180
100	Drums BALLAD	12/8	9	LOOP	100
152	Drums H. ROCK	4/4	9	LOOP	152
95	Rockin' Hard	4/4	18	LOOP	95

1. Press [PATTERN] - [F1 (LIST)].
The "PATTERN LIST" screen appears.
2. Use [VALUE], [+/-], or [CURSOR (up/down)] to select the pattern.

Function Buttons

- [F1 (▲ PAGE)]**
The previous page of the list appears.
 - [F2 (PAGE ▼)]**
The next page of the list appears.
 - [F5 (NEW)]**
An empty pattern with the lowest number is called up.
3. Press [EXIT] to return to the "PATTERN" screen.

Playing Back a Pattern [PLAY]

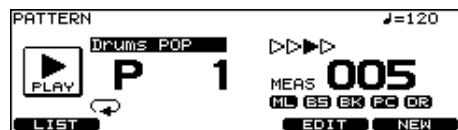

1. Select the pattern to play.
2. Press [PLAY].
[PLAY] lights, and playback of the pattern begins.
3. Press [STOP] to stop playback of the pattern.
[PLAY] goes off, and returns to the beginning of the measure played at that moment.
4. Press [STOP] once again to return to beginning of the pattern.

Tempo Adjustment

1. Press [TEMPO].
2. [TEMPO] lights, and the “TEMPO” screen appears.



3. Use [+/-] or [VALUE] to select the tempo.
4. Press [EXIT] to return to the “DRUM KIT” screen.

Setting the Tempo by Hitting a Pad (Tap Tempo)

You can set the tempo by hitting a pad or [PREVIEW] **two or more times** at **quarter-note intervals** of the desired tempo.

1. Press [TEMPO].
[TEMPO] lights, and the “TEMPO” screen appears.
2. Press [F3 (TAP)].
The “TAP TEMPO” screen appears.

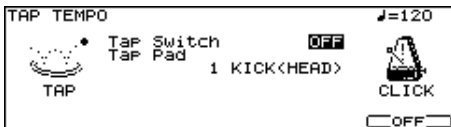

3. Press [CURSOR (up)] to move the cursor to “Tap Switch.”
4. Use [+/-] or [VALUE] to set to “ON.”
5. Press [CURSOR (down)] to move the cursor to “Tap Pad.”
6. Use [+/-] or [VALUE] to select the pad (or [PREVIEW]) to use for Tap Tempo function.
7. Press [KIT] to return to the “DRUM KIT” screen.

When you hit the pad (or [PREVIEW] selected in the step 5, the tempo is displayed at the upper right of the display.



Synchronizing with an External MIDI Device

This section discusses the settings that allow an external MIDI sequencer and the TD-20’s sequencer to be synchronized. The device that is playing back is called the “master” and the device that is synchronizing to the playback is called the “slave.”

1. Press [TEMPO].

[TEMPO] lights, and the “TEMPO” screen appears.

2. Press [F2 (SYNC)].

The “TEMPO SYNC” screen appears.



3. Use [+/-] or [VALUE] to make settings.
4. Press [KIT] to return to the “DRUM KIT” screen.

Parameter	Value	Description
Sync Mode	INTERNAL, EXTERNAL, AUTO, REMOTE	See below.

INTERNAL:

The TD-20’s tempo setting will be used for playback/recording. When shipped from the factory, this setting is selected.

EXTERNAL:

The TD-20’s sequencer will operate in accordance with tempo data (MIDI Clock) from the external device.

AUTO:

This is a convenient setting that combines features of both the INTERNAL and EXTERNAL settings. When no synchronization signal is being received, the TD-20’s tempo setting will be used for playback/recording. When a synchronization signal is being received from an external device, the TD-20 will sync to that signal.

REMOTE:

The TD-20 will obey start/pause/stop messages from an external device, but will playback according to its own tempo setting.

Synchronizing to the playback of an external sequencer

In this case, the TD-20 will be the slave and an external sequencer will be master.

1. Connect the TD-20’s MIDI IN connector with a MIDI cable to the MIDI OUT connector of the external sequencer.
2. Set Sync Mode to “EXTERNAL.”
3. Begin playback on the external sequencer.
Synchronized playback will begin.

Part Settings [F2 (PART)]

PATTERN PART screen (Only for User Pattern)



Muting a Specific Part [F1 (MUTE)]

You can mute specific parts in user patterns.

1. Press [PATTERN] - [F2 (PART)].
The "PATTERN PART" screen appears.
2. Press [F1 (MUTE)].
The "PART MUTE" screen appears.



3. Press [F1]–[F5] to turn each part muted or played.

[F1]: Melody Part
 [F2]: Bass Part
 [F3]: Backing 1 Part + Backing 2 Part
 [F4]: Percussion Part
 [F5]: Drum Kit Part

4. Press [PATTERN] to return to the "PATTERN" screen.

* You can check the part mute status in the "PATTERN" screen.

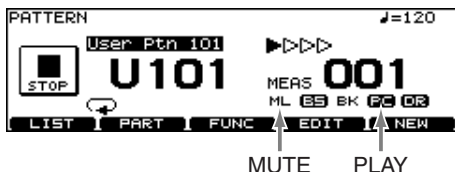

Make Settings for the Backing Part [F2 (BACKING)]

Here you can select the instrument used for the backing parts (other parts than drum kit part and percussion part), etc.

1. Press [PATTERN] - [F2 (PART)].
The "PATTERN PART" screen appears.
2. Press [F2 (BACKING)].
The "MELODY (BASS, BACKING1, BACKING2)PART" screen appears.



3. Press [F1]–[F4] to select the part you wish to set.

[F1]: Melody Part
 [F2]: Bass Part
 [F3]: Backing 1 Part
 [F4]: Backing 2 Part

4. Press [CURSOR (up/down)] to select the parameter.

5. Use [+/-] or [VALUE] to make settings.

Parameter	Value	Description
Inst	Refer to Backing Instrument List (p. 98)	Part Instrument
Key Shift	-24-0- +24	Shifts the overall pitch (in semi-tone steps).
Bend Range	0- +24	Amount of change in pitch with pitch bend at the maximum level (in semitone steps).

Instrument Numbers/Instrument Names

You can change the tone by changing the instrument number. Selecting different variations within each instrument number changes the instrument name, with a different tone being selected.

Instrument numbers correspond to the program numbers (1-128).

Variation Tones

These are slightly varied tone types found in an instrument number. The number of variation tones varies with the instrument number.

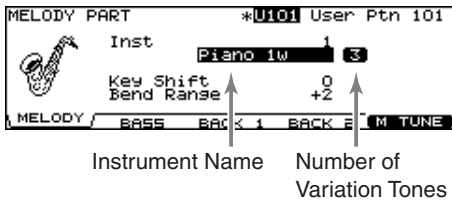

Master Tuning

Here you can adjust the overall tuning for the Melody, Bass, Backing 1, and Backing 2 part.

1. Press [PATTERN] - [F2 (PART)] - [F2 (BACKING)] - [F5 (M TUNE)].

The "MASTER TUNE" screen appears.

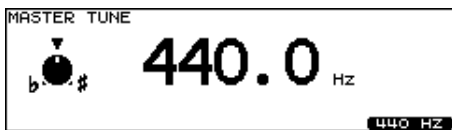

2. Use [+/-] or [VALUE] to make setting.
 Master Tune: 415.3–466.2Hz

* You can set this to 440.0 Hz by pressing [F5 (440 Hz)].

Percussion Part Settings [F3 (PERC)]

Choosing a Percussion Set

An assembled group of different **percussion instruments** is called a **percussion set**. There are 8 percussion sets, with percussion instruments assigned to each note number (128). So multiple instruments can be used at one time. They can be edited and use the effects unit of the backing instruments.

1. Press [PATTERN] - [F2 (PART)].

The "PATTERN PART" screen appears.

2. Press [F3 (PERC)].

The "PERCUSSION PART" screen appears.



3. Use [+/-] or [VALUE] to select the percussion set.

Percussion Set Settings

1. In the "PERCUSSION PART" screen, press [F5 (EDIT)].

The "PERCUSSION SET EDIT" screen appears.



2. Make settings of the percussion set.
3. When finished, press [EXIT] to return to the "PERCUSSION PART" screen.

Selecting a Percussion Instrument

Select an instrument for each note number.

1. Press [CURSOR (up/down)] to select the note number you wish to set.
2. Use [VALUE] or [+/-] to select the instrument.

MEMO

You can listen the sound of instrument by pressing [PREVIEW].

Selecting a Percussion Instrument from the List [F1 (LIST)]

Here you can select from the list of all available instruments.

1. Press [CURSOR (up/down)] to select the note number you wish to set.
2. Press [F1 (LIST)].

The “PERCUSSION SET INST LIST” screen appears.



3. Use [VALUE], [+/-], or [CURSOR] to select the instrument.

Function Buttons

[F1 (< PAGE)]

Previous page of the list appears.

[F2 (PAGE >)]

The next page of the list appears.

[F5 (OFF)]

Selects the instrument #561 (OFF).

4. Press [EXIT] to return to the “PERCUSSION SET EDIT” screen.

Making the Settings for Each Percussion Instrument [F2 (EDIT)]

Set the volume, pan, pitch, decay, etc. for each percussion instrument.

1. Press [F2 (EDIT)].

The “PERCUSSION SET INST EDIT” screen appears.

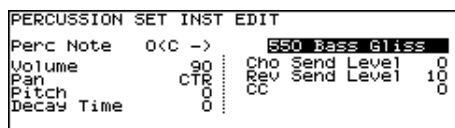

2. Press [CURSOR] to select the parameter.
3. Use [+/-] or [VALUE] to make settings.

Parameter	Value	Description
Perc Note	0 (C -)–127 (G 9)	Note number to be set
(Inst)	Refer to Drum Instrument List (p. 92).	Instrument
Volume	0–127	–

Parameter	Value	Description
Pan	L15–CTR–R15	Stereo position
Pitch	-480–+480	–
Decay Time	-31–+31	–
Cho Send Level	0–127	Amount of chorus
Rev Send Level	0–127	Amount of reverb
CC	0–127	See below.

CC: Specifies how the instrument which changes the tone like a snare (striking position) or hi-hat (pedal position) sounds.

4. Press [EXIT] to return to the “PERCUSSION SET EDIT” screen.

Naming a Percussion Set [F3 (NAME)]

Each percussion set can be named (up to 12 characters).



1. Press [F3 (NAME)].

The “PERCUSSION SET NAME” screen appears.

2. Press [CURSOR (left/right)] to move the cursor to the character to be changed.
3. Use [VALUE], [+/-], or [CURSOR (up/down)] to change the character.

Function Buttons

[F1 (INSERT)]

A blank space is inserted at the cursor position.

[F2 (DELETE)]

Character at the cursor position is deleted.

[F3 (SPACE)]

Character at cursor position is replaced by a blank space.

[F4 (CHAR)]

Character at the cursor position changes between uppercase/lowercase alphabet, or numbers and symbols.

4. Press [EXIT] to return to the “PERCUSSION SET EDIT” screen.

Volume/Pan Settings for Each Part [F4 (MIXER)]

- * Drum part cannot be set here. Set in the MIXER settings (p. 37).
- * To adjust volume/pan settings for each instrument of the percussion part, refer to p. 55.

1. Press [PATTERN] - [F2 (PART)].

The "PATTERN PART" screen appears.

2. Press [F4 (MIXER)].

The "PART VOLUME", "PART PAN", "PART REVERB SEND LEVEL", or "PART CHORUS SEND LEVEL" screen appears.

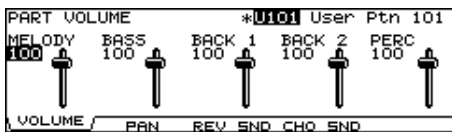

3. Press [F1]–[F4] to select the parameter.
4. Press [CURSOR (left/right)] to select the part you wish to set.
5. Use [+/-], [VALUE], or [CURSOR (up/down)] to make settings.

Parameter	Value
[F1 (VOLUME)]	
PART VOLUME	0–127
[F2 (PAN)]	
PART PAN	L15–CTR–R15
[F3 (REV SND)]	
PART REVERB SEND LEVEL	0–127
[F4 (CHO SND)]	
PART CHORUS SEND LEVEL	0–127

Effect Settings for Backing Parts [F5 (REV/CHO)]

Set the amount of reverb and chorus for each backing part.

1. Press [PATTERN] - [F2 (PART)].

The "PATTERN PART" screen appears.

2. Press [F5 (REV/CHO)].

The "REVERB/CHORUS" screen appears.

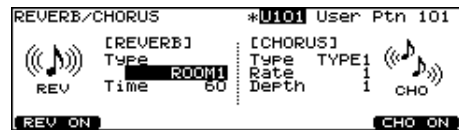

3. Press [CURSOR] to select the parameter.
4. Use [+/-] or [VALUE] to make settings.
5. Press [F1] and/or [F5] to turn the reverb/chorus ON or OFF.
 [F1]: Reverb On/Off
 [F5]: Chorus On/Off

Parameter	Value	Description
REVERB		
Type	ROOM1, ROOM2, STAGE1, STAGE2, HALL1, HALL2, DELAY, PAN-DELAY	Type of reverb
Time	0–127	Reverb Length/Delay Time
CHORUS		
Type	TYPE1–3	Type of chorus
Rate	1–64	Speed of modulation
Depth	1–64	Depth of modulation

Pattern Settings [F3 (FUNC)]

Set various settings for the user patterns.

Time Signature/Number of Measures/Tempo Settings [F1 (SETUP)]

1. Press [PATTERN].
The "PATTERN PART" screen appears.
2. Press [F3 (FUNC)] - [F1 (SETUP)].
The "PATTERN SETUP" screen appears.

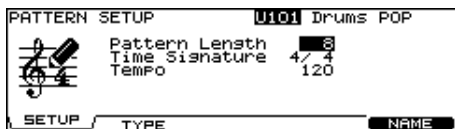

3. Press [CURSOR] to select the parameter.
4. Use [+/-] or [VALUE] to make settings.

Parameter	Value	Description
Pattern Length	1-999	Number of measures
Time Signature	Numerator: 1-15 Denominator: 2, 4, 8, 16	Beat
Tempo	20-260	-



Time Signature can be set on an empty pattern. You cannot set 1/8 and 1/16-3/16.

Choosing a Playback Method [F2 (TYPE)]

1. Press [PATTERN].
The "PATTERN PART" screen appears.
2. Press [F3 (FUNC)] - [F2 (TYPE)].
The "PATTERN TYPE" screen appears.

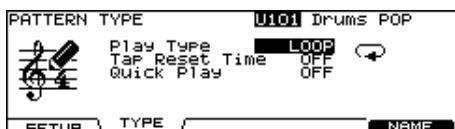

3. Press [CURSOR (up/down)] to select the parameter.
4. Use [+/-] or [VALUE] to make settings.

Parameter	Value	Description
Play Type	LOOP, ONESHOT, TAP, VLINK	See below.
Tap Reset Time	OFF, 0.2-4.0	
Quick Play	OFF, ON	

About Play Type (LOOP, ONESHOT, TAP, VLINK)

LOOP ():

After the pattern is played back all the way to the end, playback then repeats, starting at the beginning of the pattern. Playback continues until [STOP] is pressed. Loop is useful for practicing and live performance.

ONESHOT ():

Playback stops once the end of the pattern is reached. This is a convenient feature to use when assigning patterns to the pads (Pad Pattern; p. 35). Each time you hit the pad to which the pattern is assigned, it will automatically start from the beginning of the pattern.

Supplementary function for LOOP and ONESHOT

Quick Play: OFF, ON

Quick Play starts playback of the pattern from the first note (first event) even if when you recorded the pattern, you left a pause at the beginning. For example if you had just played/recorded freely, ignoring the tempo clock.

TAP ():

When set to Pad Pattern (p. 35), the sounds are played back in sequence each time the pad is pressed. (You can use [PLAY] instead of a pad.)

For example if you specify "TAP" for a pattern which contains a melody line and assign this pattern to a pad, you can play the notes of the melody in order each time you strike the pad. You can set the "Tap Reset Time" so that the pattern will automatically return to the beginning if that time interval elapses without that pad being hit again. You can play a bass line with your kick drum, too.

* When using Realtime Recording (p. 61) to record patterns used for TAP playback, make the Quantize settings (p. 63) before you begin recording.

V-LINK ():

Special "TAP" for the V-LINK function (p. 84).

You can switch the images in order each time you strike the pad (or press [PLAY]).

Supplementary function for TAP and V-LINK

Tap Reset Time: OFF, 0.2–4.0 (sec)

This function automatically returns the pattern to the beginning if the set time interval elapses without the pad being hit again. This is the time interval that resets the pattern being used. If it is set to “OFF,” this function will be disabled.

HINT

You can have the velocity of the pattern being played change according to the force with which the pad is tapped (Pad Pattern Velocity). Refer to p. 35.

Naming a Pattern [F5 (NAME)]

Each pattern can be named (up to 12 characters).



1. Press [PATTERN] - [F3 (FUNC)] - [F5 (NAME)]. [PATTERN] lights, and the “PATTERN NAME” screen appears.
2. Press [CURSOR (left/right)] to move the cursor to the character to be changed.
3. Use [VALUE], [+/-], or [CURSOR (up/down)] to change the character.

Function Buttons

[F1 (INSERT)]

A blank space is inserted at the cursor position.

[F2 (DELETE)]

Character at the cursor position is deleted.

[F3 (SPACE)]

Character at cursor position is replaced by a blank space.

[F4 (CHAR)]

Character at the cursor position changes between upper case/lowercase alphabet, or numbers and symbols.

Starting and Stopping the Metronome (Click) On/Off

1. Press [TEMPO].

[TEMPO] lights, and the “TEMPO” screen appears.

2. Press [F5] to turn the click ON and OFF.

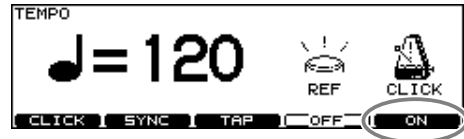

3. Press [EXIT] to return to the “DRUM KIT” screen.

MEMO

You can also turn the click on/off by holding down [SHIFT] and pressing [TEMPO].

Using a Indicator as a Click

You can use the [TEMPO] indicator as a click.

1. Press [TEMPO].

[TEMPO] lights, and the “TEMPO” screen appears.

2. Press [F4] to turn the [TEMPO] indicator flashing (ON) or going off (OFF).



3. Press [EXIT] to return to the “DRUM KIT” screen.

Setting the Click

1. Press [TEMPO] - [F1 (CLICK)].

The "CLICK SETTINGS" screen appears.

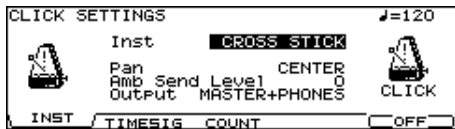

2. Press [CURSOR] to select the parameter.

3. Use [+/-] or [VALUE] to make settings.

Parameter	Value	Description
[F1 (INST)]		
Inst	Refer to right column.	Sound for the click
Pan	L15-CENTER-R15	Stereo position of the click
Amb Send Level	0-127	Amount of ambience for the click You have to turn the ambience on (p. 40).
	When "---" is displayed, this level is set to "0" automatically to prevent the click sound from leaking.	
Output	MASTER +PHONES, PHONES ONLY, DIRECT 5, DIRECT 6, DIRECT 5+6, DIRECT 7, DIRECT 8, DIRECT 7+8	Output destination for the click You can also select by pressing [SETUP] - [F2 (OUTPUT)] (p. 78).
[F2 (TIMESIG)]		
Time Signature	Numerator: 0-13 Denominator: 2, 4, 8, 16	When the numerator is set to "0," no accent is added to the first beat.
Interval	1/2 (half note), 3/8 (dotted quarter note), 1/4 (quarter note), 1/8 (eighth note), 1/12 (eighth-note triplet), 1/16 (16th note)	
[F3 (COUNT)]		
Count In Play	OFF, 1 MEAS, 2 MEAS	Adds a count in before playback.
Count In Rec	OFF, 1 MEAS, 2 MEAS	Adds a count in before recording.
During Play	OFF, ON	Sets the click to play during pattern playback.
During Rec	OFF, ON	Sets the click to play during recording.

MEMO

To adjust the click level, move [GROUP FADERS] - [CLICK] (p. 24).

Click Instruments

VOICE, CLICK, BEEP, METRONOME, CLAVES, WOOD BLOCK, STICKS, CROSS STICK, TRIANGLE, COWBELL, CONGA, TALKING DRUM, MARACAS, CABASA, CUICA, AGOGO, TAMBOURINE, SNAPS, 909 SNARE, 808 COWBELL

Chapter 7. Sequencer (Recording/Editing)

Recording a Pattern [REC]

What is played on the pads or on an external MIDI keyboard can be recorded (Realtime Recording).

Your performance will be recorded exactly as you play it, including hi-hat control pedal movements and Positional Sensing.

NOTE

Please keep in mind that even though there are 100 user patterns, the amount of memory available will be determined by how much data is recorded into TD-20.



You can check the amount of memory available by pressing [TOOLS] - [F2 (INFO)] - [F1 (MEMORY)].

MEMO

Storing performance data that describes every instance where the Hi-Hat Control Pedal is used, and that includes strike position detection rapidly consumes the User memory.

How to Record

The procedure is the same when recording with pads or with a MIDI keyboard.

(1) Select an Empty Pattern

1. Press [PATTERN].

[PATTERN] lights, and the "PATTERN" screen appears.



2. Press [F5 (NEW)].

An empty pattern is automatically selected.



NOTE

If all of the patterns have been used, this can't be selected. Delete an unneeded pattern (p. 66) before you record.

* You can also select by using [+/-] or [VALUE].

(2) Set the Time Signature, the Number of Measures, and the Tempo

1. In the “PATTERN” screen, press [F3 (FUNC)] - [F1 (SETUP)].

The “PATTERN SETUP” screen appears.

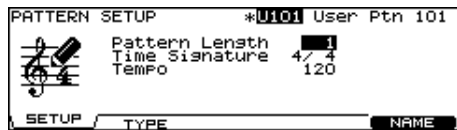

2. Press [CURSOR] to select the parameter.
3. Use [+/-] or [VALUE] to make settings.

Parameter	Value
Pattern Length	1-999
Time Signature	Numerator: 1-15 Denominator: 2, 4, 8, 16
Tempo	20-260

NOTE

Time Signature can be set on an empty pattern. You cannot set 1/8 and 1/16-3/16.

MEMO

If REC Mode (p. 63) is set to “Replace,” it is not necessary to specify the Length. Recording will continue until you press [STOP], and the number of measures recorded will automatically become the “LENGTH” setting.



You can have a count sound (click) inserted before recording begins by pressing [TEMPO] - [F1 (CLICK)] - [F3 (COUNT)] and then setting Count In Rec (p. 60).

If you are recording from the pads, disregard paragraphs (3) and (4) of this section.

(3) Select a MIDI Channel

Be sure that the transmit channel on your keyboard corresponds to the MIDI channel of the part you wish to record.

Each part has its own MIDI channel. The factory preset channels are as follows:

Part	MIDI Channel
Drum Kit part	CH10
Percussion part	CH11
Melody part	CH1
Bass part	CH2
Backing 1 part	CH3
Backing 2 part	CH4



You can change the MIDI channel by pressing [SETUP] - [F1 (MIDI)] - [F1 (MIDI CH)] (p. 74).

MEMO

You can record the percussion part with pads by pressing [SETUP] - [F1 (MIDI)] - [F2 (GLOBAL)] and then setting Local Control to “ON (PERC)” (p. 75).

(4) Part Setting

Follow the procedures described in **Part Settings [F2 (PART)]** (p. 54) to make settings of the parts.

(5) Set the Recording Method

- In the “PATTERN” screen, press [REC].
[PLAY] flashes, and [REC] lights.
The “PATTERN REC STANDBY” screen appears, and the click sound begins to play.

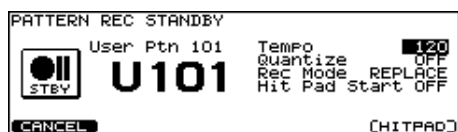

- Press [CURSOR (up/down)] to select the parameter.
- Use [+/-] or [VALUE] to make settings.

Parameter	Value	Description
Tempo	20–260	–
Quantize	8th note–64th note, OFF	See below.
Rec Mode	LOOP ALL, LOOP 1–2, REPLACE	See below.
Hit Pad Start	OFF, ON	When “ON,” recording starts the instant you strike a pad in recording standby mode. Press [F5 (HIT-PAD)] to turn on/off. This function can be used only when Local Control (p. 75) is set to “ON (DRUM).”

Quantize

Quantize is a function that corrects timing inaccuracies while you record. Set the note value before you begin recording and everything you play will be quantized automatically. The value should be set to the shortest note appearing in the phrase. When set to “OFF,” the pattern is recorded exactly as played.

* When using Tap Playback to play back a pattern you have created, first make sure that this is not set to “OFF,” then quantize. If set to “OFF,” then Tap Playback cannot be executed correctly.

Rec Mode

LOOP ALL:

The entire pattern will be repeated in loop mode and you can continually record (like overdubbing).

LOOP 1, LOOP 2:

Recording in a one or two measure loop mode.

REPLACE:

Recording will continue until you press [STOP]. Any previously recorded data for all Parts will be erased.

(6) Recording

- Press [PLAY] to begin recording.
[PLAY] stops flashing and remains lit, and the “PATTERN RECORDING” screen appears.

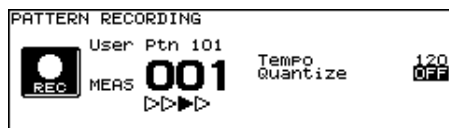

- Play with pads or MIDI keyboards to record.
- Press [STOP] to stop recording.
[PLAY] and [REC] go off.



You can name the recorded pattern (p. 59).

Checking the Tones and Phrases During Recording (Rehearsal)

The Rehearsal function temporarily suspends recording during the recording process, allowing you to rehearse and then quickly resume recording.

- Start recording (p. 61).
- While recording is underway, press [REC].
[REC] flashes, and the REHEARSAL screen appears. Now, data from pads or keyboard cannot be recorded.

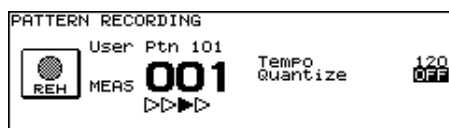

- Press [REC] to resume recording.
[REC] lights.

Editing a Pattern [F4 (EDIT)]

You can edit user patterns.

PATTERN EDIT screen (Preset Pattern)

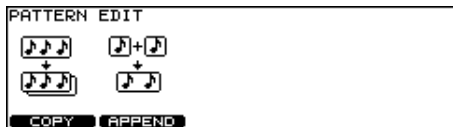

PATTERN EDIT screen (User Pattern)

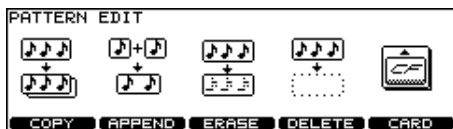

Copying a Pattern [F1 (COPY)]

Copy the pattern as is to the User patterns.

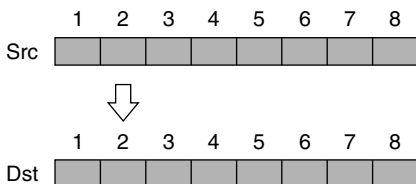

You can copy selected measures of a part or pattern. Unlike copying an entire pattern, settings such as instrument and part volume etc. will not be copied.

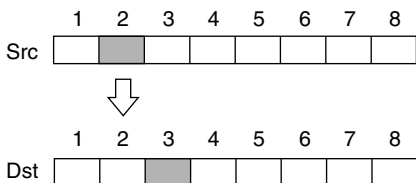

1. Press [PATTERN] - [F4 (EDIT)].

The "PATTERN EDIT" screen appears.

2. Press [F1 (COPY)].

The "COPY PATTERN" screen appears.

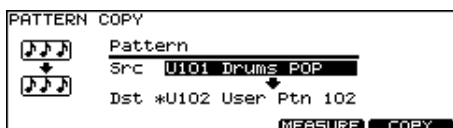

3. When you want to copy selected measures or part, press [F4 (MEASURE)].

The "COPY PATTERN MEASURE" screen appears.

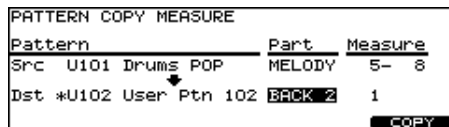

4. Press [CURSOR] to select the parameter.

5. Use [+/-] or [VALUE] to select the pattern, part, and measures.

	Pattern	Part	Measure
Src	Copy-source pattern	Copy-source part	Measures to be copied (First Measure–Last Measure)
Dst	Copy-destination pattern	Copy-destination part	First measure of the copy-destination

6. Press [F5 (COPY)].

The confirmation screen appears.

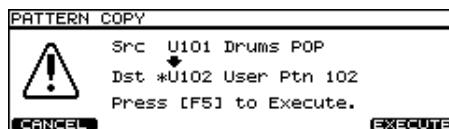

7. Press [F5 (EXECUTE)].

* To cancel, press [F1 (CANCEL)].

MEMO

- If the number of measures in the copy-source pattern and the copy-destination pattern differ, the number of measures in the copy-destination pattern may increase or decrease according to this difference.
- When "ALL" is specified in copy-source part, then only "ALL" may be specified in copy-destination part. Additionally, if other than "ALL" is specified in copy-source part, then "ALL" cannot be specified in copy-destination part.
- When copying between drum kit parts and percussion parts or backing parts, copy takes place in accord with the predetermined correspondence between note numbers and pads. Only note numbers assigned to pads will be copied.

For more on note numbers and trigger inputs, refer to **Note Number (Factory Settings)** (p. 96).

Connecting Two Patterns [F2 (APPEND)]

This connects two patterns to create one pattern. The pattern specified as "Dst" will be first, and the pattern specified as "Src" will be connected to it. The new pattern will be created in "Dst."

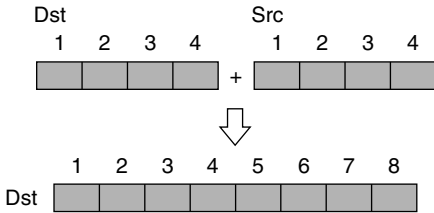

1. Press [PATTERN] - [F4 (EDIT)].

The "PATTERN EDIT" screen appears.

2. Press [F2 (APPEND)].

"APPEND PATTERN" screen appears.

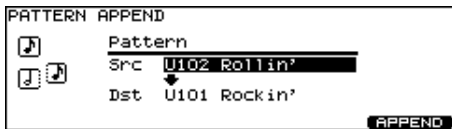

- 3. Press [CURSOR (up)] to move the cursor to "Src."**
- 4. Use [+/-] or [VALUE] to select the pattern that will come later.**
- 5. Press [CURSOR (down)] to move the cursor to "Dst."**
- 6. Use [+/-] or [VALUE] to select the pattern that will come first.**
- 7. Press [F5 (APPEND)].**

The confirmation screen appears.

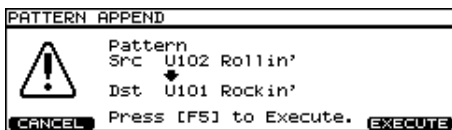

8. Press [F5 (EXECUTE)].

* To cancel, press [F1 (CANCEL)].

Erasing a pattern [F3 (ERASE)]

This erases the pattern. Performance data is erased, while beat, measure length, and other settings are left intact.

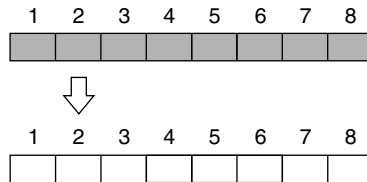

You can erase portions of the pattern, in measure units. The erased portions become blank measures.

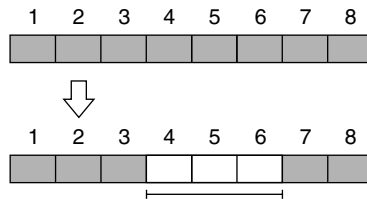

MEMO

Although the data is erased, the pattern length is unchanged.

1. Press [PATTERN] - [F4 (EDIT)].

The "PATTERN EDIT" screen appears.

2. Press [F3 (ERASE)].

The "ERASE PATTERN" screen appears.

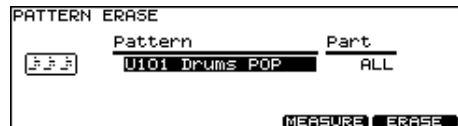

3. When you want to erase selected measures or part, press [F4 (MEASURE)].

The "ERASE PATTERN MEASURE" screen appears.

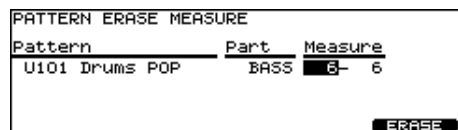

- 4. Press [CURSOR (left/right)] to select the parameter.**
- 5. Use [+/-] or [VALUE] to select the pattern, part, and measures.**

Pattern	Part	Measure
Pattern to be erased	Part to be erased	Measures to be erased (First Measure–Last Measure)

6. Press [F5 (ERASE)].

The confirmation screen appears.

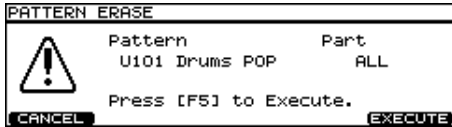

7. Press [F5 (EXECUTE)].

* To cancel, press [F1 (CANCEL)].

Deleting a Pattern [F4 (DELETE)]

This deletes the pattern performance, beat, measure length, part, and all other settings, creating a empty pattern.

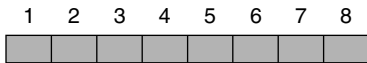

You can delete unneeded measures from the pattern, then connects the portions before and after the resulting gap.

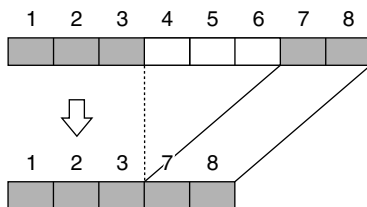

MEMO

- The performance data following the deleted range is moved forward (and the performance data for that part is shortened).
- When all parts in the targeted range are specified, deletion results in the pattern itself becoming shorter.
- When all measures for all parts are deleted, the pattern itself is deleted, resulting in a pattern containing no performance data (an empty pattern). Settings, including beat and measure length, are restored to their initial values as well.

1. Press [PATTERN] - [F4 (EDIT)].

The "PATTERN EDIT" screen appears.

2. Press [F4 (DELETE)].

The "DELETE PATTERN" screen appears.

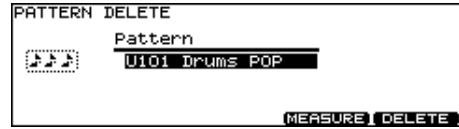

3. When you want to delete selected measures, press [F4 (MEASURE)].

The "DELETE PATTERN MEASURE" screen appears.

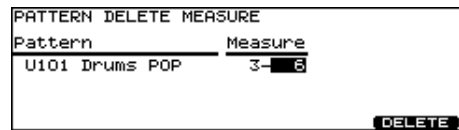

4. Press [CURSOR (left/right)] to select the parameter.

5. Use [+/-] or [VALUE] to select the pattern and measures.

Pattern	Measure
Pattern to be deleted	Measures to be deleted (First Measure–Last Measure)

6. Press [F5 (DELETE)].

The confirmation screen appears.

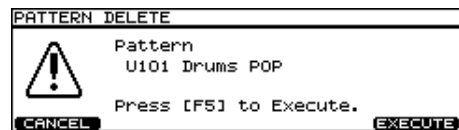

7. Press [F5 (EXECUTE)].

* To cancel, press [F1 (CANCEL)].

Saving Patterns to a Memory Card [F5 (CARD)]

You can use an optional CompactFlash memory card to save pattern data.

PATTER CARD screen



- * Never remove a CompactFlash card while the CompactFlash indicator on the TD-20's top panel is lit. Doing so may corrupt the unit's data or the data on the CompactFlash card.
- * Carefully insert the CompactFlash card all the way in—until it is firmly in place.

Cards supported by TD-20 are 3.3 V CompactFlash cards with the capacity of 16 to 512 MB.



You can check the amount of memory card available by pressing [TOOLS] - [F2 (INFO)] - [F2 (CARD)] (p. 84).

Save/Load and Copy Functions of the TD-20

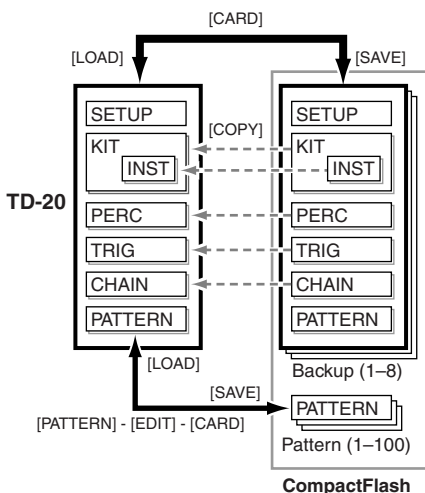

Saving a Pattern to a Memory Card [F1 (SAVE)]

Patterns will be saved up to 100.

1. Insert a CompactFlash card into the CompactFlash card slot on the TD-20's front panel.

2. Press [PATTERN] - [F4 (EDIT)].

The "PATTERN EDIT" screen appears.

3. Press [F5 (CARD)].

The CompactFlash indicator light, and the "PATTERN CARD" screen appears.

* If you insert a card being used for the first time by the TD-20, display shows "Unformatted!" Refer to **Formatting a Memory Card [F4 (FORMAT)]** (p. 72) and initialize it.

4. Press [F1 (SAVE)].

The "PATTERN SAVE" screen appears.



5. Press [CURSOR (up)], and then use [+/-] or [VALUE] to select the pattern you want to save.

6. Press [CURSOR (down)], and then use [+/-] or [VALUE] to select a backup pattern to which you want to save the pattern.

* You can select an empty backup pattern with the lowest number by pressing [F4 (NEW)].

7. Press [F5 (SAVE)].

The confirmation screen appears.

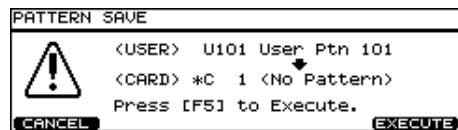

* To cancel, press [F1 (CANCEL)].

8. Press [F5 (EXECUTE)] to save the pattern.

Loading a Pattern from a Memory Card [F2 (LOAD)]

Patterns saved on a memory card can be loaded into the TD-20.

1. Insert a CompactFlash card into the CompactFlash card slot on the TD-20's front panel.

2. Press [PATTERN] - [F4 (EDIT)].

The "PATTERN EDIT" screen appears.

3. Press [F5 (CARD)].

The CompactFlash indicator light, and the "PATTERN CARD" screen appears.

4. Press [F2 (LOAD)].

The "PATTERN LOAD" screen appears.

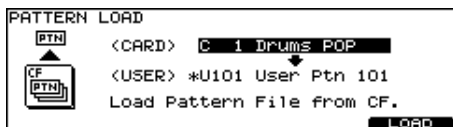

5. Press [CURSOR (up)], and then use [+/-] or [VALUE] to select the backup pattern you want to load.

6. Press [CURSOR (down)], and then use [+/-] or [VALUE] to select the user pattern to which the backup pattern will be copied.

7. Press [F5 (LOAD)].

The confirmation screen appears.

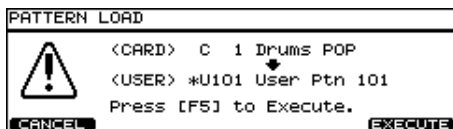

* To cancel, press [F1 (CANCEL)].

8. Press [F5 (EXECUTE)] to load the pattern.

Deleting a Pattern from a Memory Card [F3 (DELETE)]

You can delete the unneeded pattern from a memory card.

1. Insert a CompactFlash card into the CompactFlash card slot on the TD-20's front panel.

2. Press [PATTERN] - [F4 (EDIT)].

The "PATTERN EDIT" screen appears.

3. Press [F5 (CARD)].

The CompactFlash indicator light, and the "PATTERN CARD" screen appears.

4. Press [F3 (DELETE)].

The "PATTERN DELETE" screen appears.

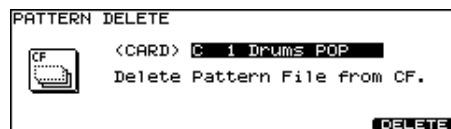

5. Use [+/-] or [VALUE] to select the unneeded backup pattern.

6. Press [F5 (DELETE)].

The confirmation screen appears.

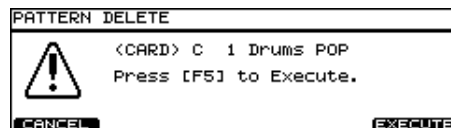

* To cancel, press [F1 (CANCEL)].

7. Press [F5 (EXECUTE)] to delete the backup pattern.

Chapter 8. Copy Function [COPY]

You can copy drum kits, instruments, etc. to the destination of your choice.



Copying will overwrite the data that was in the new destination. So take caution when performing this operation.

1. Press [COPY].

[COPY] lights, and the “COPY” screen appears. If a CompactFlash card is inserted into the CompactFlash card slot, the CompactFlash indicator also lights (p. 70).



2. Press [F1]–[F5] to select what you want to copy.

- [F1 (KIT)]: drum kit
- [F2 (INST)]: drum instrument
- [F3 (PERC)]: percussion set
- [F4 (TRIG)]: trigger bank
- [F5 (CHAIN)]: drum kit chain

3. Use [CURSOR], [+/-], or [VALUE] to select the copy-source and the copy-destination.

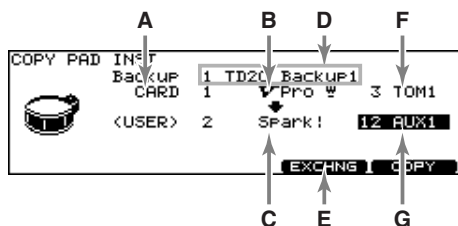

- A:** copy-source type (PRESET, USER, or CARD)
- B:** copy-source
- C:** copy-destination
- D:** backup containing the copy-source
(This appears when “CARD” is selected for the copy-source type.)
- E:** exchange button
(This appears when “USER” is selected for the copy-source type.)
- F:** copy-source pad
(This appears when copying a drum instrument.)
- G:** copy-destination pad
(This appears when copying a drum instrument.)

4. Press [F4] or [F5].

[F4 (EXCHNG)]:

The contents of the copy-source and copy-destination are exchanged. (This can be selected when a “USER” data is used for the copy-source.)

[F5 (COPY)]:

The previous content of the copy-destination is overwritten by the content of the copy-source.

The confirmation screen appears. (Example: Copying a drum kit)

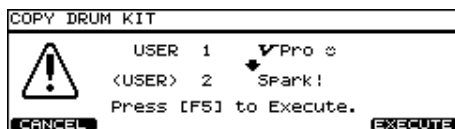

* To cancel, press [F1 (EXIT)].

5. Press [F5 (EXECUTE)] to carry out the procedure.



“EXCHNG” is convenient for changing the order of data in a sequence.



For details on copying a pattern, refer to p. 64.

Chapter 9. Using a CompactFlash Memory Card [CARD]

You can use an optional CompactFlash memory card to save TD-20 settings and sequencer data.

CARD MENU screen



- * Never remove a CompactFlash card while the CompactFlash indicator on the TD-20's top panel is lit. Doing so may corrupt the unit's data or the data on the CompactFlash card.
- * Carefully insert the CompactFlash card all the way in—until it is firmly in place.

Cards supported by TD-20 are 3.3 V CompactFlash cards with the capacity of 16 to 512 MB.



You can check the amount of memory card available by pressing [TOOLS] - [F2 (INFO)] - [F2 (CARD)] (p. 84).

Save/Load and Copy Functions of the TD-20

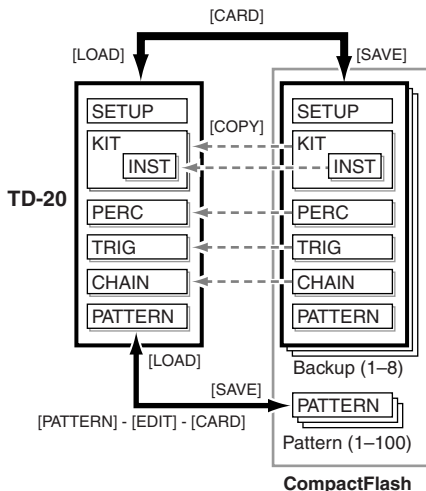

Saving Data to a Memory Card [F1 (SAVE)]

All data (drum kits, percussion sets, patterns, and setup) will be saved up to 8 sets.

1. Insert a CompactFlash card into the CompactFlash card slot on the TD-20's front panel.

2. PRESS [CARD].

[CARD] AND the CompactFlash indicator light, and the "CARD MENU" screen appears.

* If you insert a card being used for the first time by the TD-20, display shows "Unformatted!" Refer to p. 72 and initialize it.

3. Press [F1 (SAVE)].

The "CARD SAVE" screen appears.

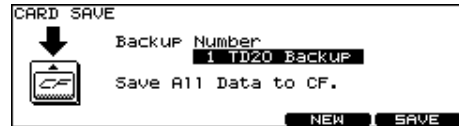

4. Use [+/-] or [VALUE] to select a backup area to which you want to save the data.

* You can select an empty backup area with the lowest number by pressing [F4 (NEW)].

5. Press [F5 (SAVE)].

The confirmation screen appears.

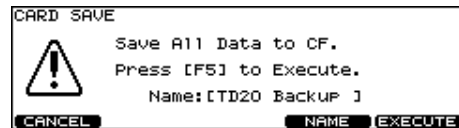

* To cancel, press [F1 (CANCEL)].

6. If you want to change the name of the backup area, press [F4 (NAME)].

7. Press [F5 (EXECUTE)] to save the data.

Naming a Backup [F4 (NAME)]

Each backup area can be given a name of up to 12 characters.

1. In the “CARD SAVE” confirmation screen, press [F4 (NAME)].

The “CARD SAVE NAME” screen appears.



2. Press [CURSOR (left/right)] to move the cursor to the character to be changed.
3. Use [VALUE], [+/-], or [CURSOR (up/down)] to change the character.

Function Buttons

[F1 (INSERT)]

A blank space is inserted at the cursor position, and characters after this point are moved to the right one space.

[F2 (DELETE)]

Character at the cursor position is deleted, and characters after this point are moved to the left one space.

[F3 (SPACE)]

Character at the cursor position is replaced by a blank space.

[F4 (CHAR)]

Type of character at the cursor position changes between upper case/lowercase alphabet, or numbers and symbols.

4. When you're finished, press [F5 (SAVE)] to return to the confirmation screen.

Loading Data from a Memory Card [F2 (LOAD)]

Data saved on a memory card can be loaded into the TD-20.

1. Insert the CompactFlash card into the CompactFlash card slot on the TD-20's front panel.

2. PRESS [CARD].

[CARD] AND the CompactFlash indicator light, and the “CARD MENU” screen appears.

3. Press [F2 (LOAD)].

The “CARD LOAD” screen appears.

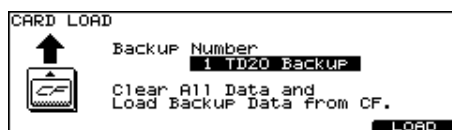

4. Use [+/-] or [VALUE] to select the backup area containing the data you want to load.

5. Press [F5 (LOAD)].

The confirmation screen appears.

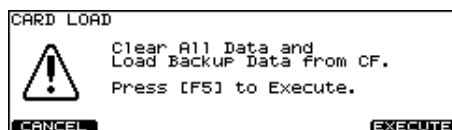

* To cancel, press [F1 (CANCEL)].

6. Press [F5 (EXECUTE)] to load the data.

* You can also load individual kits, percussion sets, etc. from a memory card. To do so, use the Copy function (p. 69).

Deleting Data from a Memory Card [F3 (DELETE)]

You can delete the unneeded data from a memory card.

1. **Insert the CompactFlash card into the CompactFlash card slot on the TD-20's front panel.**

2. **PRESS [CARD].**

[CARD] AND the CompactFlash indicator light, and the "CARD MENU" screen appears.

3. **Press [F3 (DELETE)].**

The "CARD DELETE" screen appears.

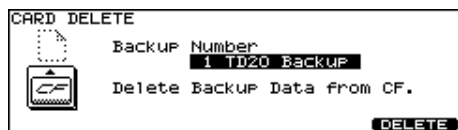

4. **Use [+/-] or [VALUE] to select the backup area containing the unneeded data.**

5. **Press [F5 (DELETE)].**

The confirmation screen appears.

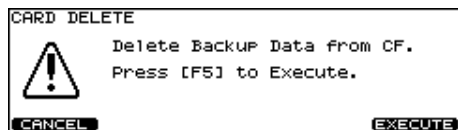

* To cancel, press [F1 (CANCEL)].

6. **Press [F5 (EXECUTE)] to delete the backup.**

Formatting a Memory Card [F4 (FORMAT)]

When a card is being used for the first time by the TD-20, you must execute the following procedure to initialize the card. (This prepares the card for use with the TD-20.)

NOTE

When a card is initialized, all data on that card will be lost. Make sure that it does not contain data you wish to keep.

1. **Insert a CompactFlash card into the CompactFlash card slot on the TD-20's front panel.**

2. **PRESS [CARD].**

[CARD] AND the CompactFlash indicator light, and the "CARD MENU" screen appears.

3. **Press [F4 (FORMAT)].**

The "CARD FORMAT" screen appears.

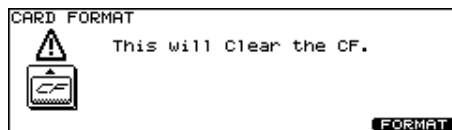

4. **Press [F5 (EXECUTE)].**

The confirmation screen appears.

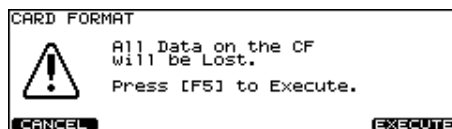



* To cancel, press [F1 (CANCEL)].

5. **Press [F5 (EXECUTE)] again to start formatting.**

Checking the State of a Memory Card [F5 (INFO)]

1. Insert a CompactFlash card into the CompactFlash card slot on the TD-20's front panel.
2. PRESS [CARD].
[CARD] AND the CompactFlash indicator light, and the "CARD MENU" screen appears.
3. Press [F5 (INFO)].
The "CARD INFORMATION" screen appears.

CARD INFORMATION		
	Used / Total	
Backup	2 / 8	
Pattern	1 / 100	
Size <Used>	624 / 31104 KB	

Backup: number of used backup areas

Pattern: number of saved patterns

Size: used memory size/total memory size

4. Press [EXIT] twice (or just press [KIT]) to return to the "DRUM KIT" screen.

The CompactFlash indicator goes off.



For details on saving patterns, refer to **Saving Patterns to a Memory Card [F5 (CARD)]** (p. 67).

Chapter 10. Settings for the Entire TD-20 [SETUP]

MIDI Settings and Operations [F1 (MIDI)]

Setting the MIDI Channels for Each Part [F1 (MIDI CH)]

For each part, you can specify the channel on which the TD-20 will receive and transmit MIDI messages.

1. Press [SETUP].
[SETUP] lights.
2. Press [F1 (MIDI)] - [F1 (MIDI CH)].
The "MIDI CHANNEL" screen appears.



3. Press [CURSOR (up/down)] to select the part you wish to set.
4. Press [CURSOR (left/right)] to select the parameter.
5. Use [+/-] or [VALUE] to make settings.

Parameter	Value	Description
Tx/Rx	OFF, ON	Turns the transmitting and receiving MIDI messages ON or OFF.
Channel	CH1-CH16	transmit and receive channel

* Drum kit part and percussion part can be overlaid and set to "CH10." When a duplicate note number is received, the instrument assigned to the drum kit part (the pad instrument) sounds. Other note number is received, the percussion part instrument is played.

* Other parts and MIDI channels cannot be overlaid.

MIDI Settings for the Entire TD-20 [F2 (GLOBAL)]

1. Press [SETUP].
[SETUP] lights.
2. Press [F1 (MIDI)] - [F2 (GLOBAL)].
The "MIDI GLOBAL" screen appears.

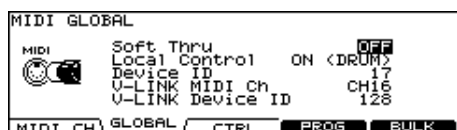

3. Press [CURSOR (up/down)] to select the parameter.
4. Use [+/-] or [VALUE] to make settings.

Parameter	Value
Soft Thru	OFF, ON
Local Control	OFF, ON (DRUM), ON (PERC)
Device ID	1-32
V-LINK MIDI Ch	CH1-CH16
V-LINK Device ID	1-32, 128

Soft Thru

This section explains how you can use the Roland SPD-20 (a MIDI controller) together with the TD-20's pads to play internal sounds and an external sound module.

When Soft Thru is set to "ON," the messages received at MIDI IN will also be transmitted from the MIDI OUT/THRU connector.

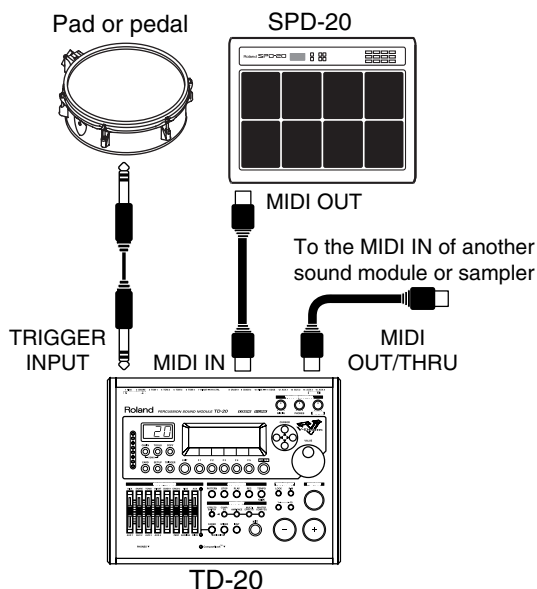

Local Control

This is required when you want to trigger sounds in an external sound module and/or record your performance on an external MIDI sequencer, and NOT use the TD-20's internal sounds. If that is your need, then turn Local Control to "OFF." The trigger signals from the pads go directly to the MIDI OUT/THRU connector.

The TD-20's default mode is with Local Control "ON."

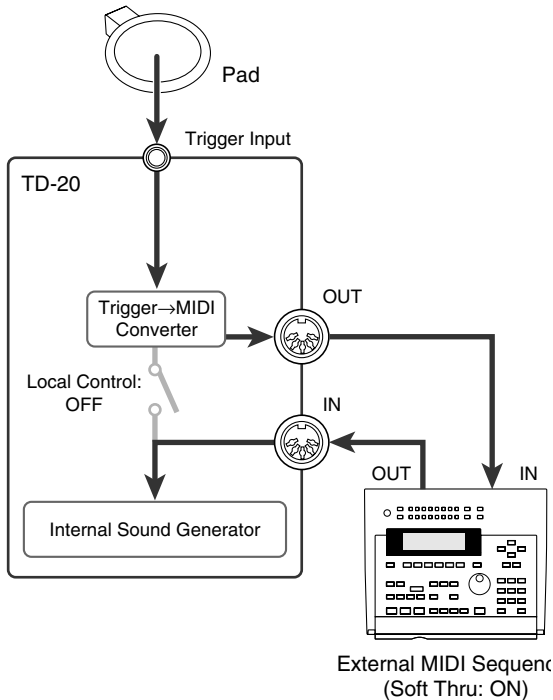

If you make connections and record as shown, with a setting of Local Control "ON," duplicate notes will be re-transmitted to the TD-20 and will not be played correctly.

ON (DRUM):

The performance data from the pad is sent to the drum kit part. Normally set to this.

ON (PERC):

The performance data from the pad is sent to the percussion part and drum kits cannot be played. Select this only when you record the percussion part with pads.

NOTE

When Local Control is set to "ON (PERC)," the sound does not change if you switch drum kits because drum kits cannot be played with pads.

Device ID

The setting described here is necessary only when you wish to transmit separate data to two or more TD-20 units at the same time. Do not change this setting in any other case. (At the factory settings, the device ID is set to "17.")

NOTE

If you lose track of the Device ID setting that was used when saving data via a bulk dump, it will no longer be possible to reload the bulk data that was saved.

Example:

Suppose that when data was saved via bulk dump (p. 77), the TD-20's Device ID was set to "17." When re-transmitting this data back to the TD-20, it won't receive if the Device ID is set to something other than "17."

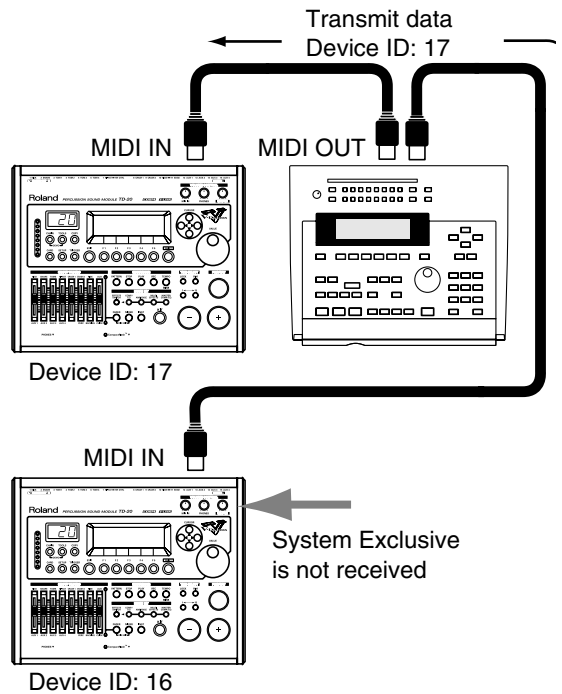

V-LINK MIDI Ch (V-LINK MIDI Channel)

When V-LINK function (p. 84) is on, the performance data recorded in the backing part of the sequencer is transmitted on this channel.

* At the factory settings, this is set to "CH16."

V-LINK Device ID

Set this ID to match the device ID number of the Edirol DV-7PR which is controlled by the TD-20. If this is set to "128," you can control the Edirol DV-7PR regardless of the device ID number of it.

* At the factory settings, this is set to "128."

MIDI Messages for Detailed Performance Expressions [F3 (CTRL)]

1. Press [SETUP].
[SETUP] lights.
2. Press [F1 (MIDI)] - [F3 (CTRL)].
The "MIDI CONTROL" screen appears.

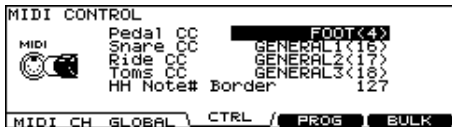

3. Press [CURSOR (up/down)] to select the parameter.
4. Use [+/-] or [VALUE] to make settings.

Parameter	Value	Description
Pedal CC	OFF, MODULATION(1), BREATH(2), FOOT(4), EXPRESSION(11),	Control change used for transmitting/receiving the depth to which the hi-hat pedal pressed
Snare CC	GENERAL1(16)– GENERAL4(19)	Control change used for transmitting/receiving the strike position of the snare, ride, and tom 1–4
Ride CC		
Toms CC		
HH Note# Border	0–127	See below.

* When a control change is set to be more than one parameter, an asterisk (*) appears at the right of the unavailable parameter.

HH Note# Border (Hi-Hat Note Number Border)

The only time you would need to change this setting is when you are triggering an external sound module.

The note number transmitted when you strike the hi-hat will change depending on the amount of pressure on the hi-hat pedal. Hi-Hat Note Number Border allows you to adjust the pedal position at which the note number switches from the open hi-hat to the closed hi-hat.

At the factory default value (127), the closed hi-hat note number will be transmitted only if the hi-hat pad is played with the pedal completely depressed. If you want this note number to be transmitted when the pedal is slightly raised, set this to a value such as 90.

NOTE

If you change the Hi-hat Note Number Border setting, the hi-hat of a pattern that was recorded onto the internal sequencer by playing the pads may play back in a way that is different from the actually recorded performance.

Switching Drum Kits via MIDI (Program Change) [F4 (PROG)]

Each drum kit/percussion set has its own program change number.

1. Press [SETUP].
[SETUP] lights.
2. Press [F1 (MIDI)] - [F4 (PROG)].
The "MIDI PROGRAM CHANGE (DRUM KIT)" or "MIDI PROGRAM CHANGE (PERC SET)" screen appears.



3. Press [F3 (DRM KIT)], [F4 (PRC GRP)], and [CURSOR (up/down)] to select the drum kit or percussion set you wish to set.
[F3 (DRM KIT)]: Drum Kit
[F4 (PRC GRP)]: Percussion Set
4. Use [+/-] or [VALUE] to make settings.

The drum kits/percussion sets will switch when a Program Change message is received from an external MIDI device. When you switch TD-20's drum kits/percussion sets, the Program Change number set here is transmitted.

Turning the Reception/Transmission of Program Changes On/Off

In the "MIDI PROGRAM CHANGE (DRUM KIT)" or "MIDI PROGRAM CHANGE (PERC SET)" screen, pressing [F1] turns the reception of program changes on or off, and pressing [F2] turns the transmission on/off.

Saving Data to an external MIDI Device (Bulk Dump) [F5 (BULK)]

Saving Data

To save data, use the external sequencer as you would when recording musical data, and perform the following steps on the TD-20 as shown in the following diagram.

1. Connect the TD-20's MIDI OUT connector with a MIDI cable to the MIDI IN connector of the external sequencer.

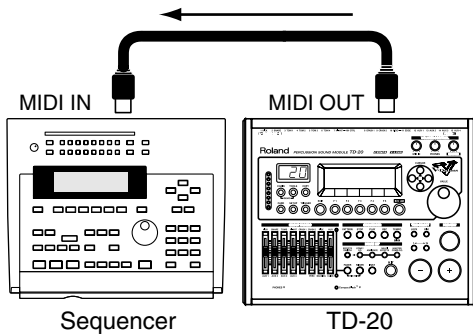

2. Press [SETUP].

[SETUP] lights.

3. Press [F1 (MIDI)] - [F5 (BULK)].

The "MIDI BULK DUMP" screen appears.

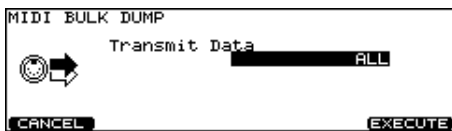

4. Press [+/-], [VALUE], and [CURSOR (up/down)] to select the content to be sent.

Transmit Data	Description
ALL	All data, including setup, drum kits, user percussion sets, user patterns
SETUP	Trigger, pad, and other kinds of settings
ALL DRUM KITS	All data for drum kits 1-50
1 DRUM KIT	Only the data for the selected drum kit
ALL TRIG BANKS	All settings for trigger banks 1-4
1 TRIG BANK	Only the settings for the selected trigger bank
ALL PERC GROUPS	All data for the user percussion sets 1-8
1 PERC GROUP	Only the data for the selected percussion set
ALL PATTERNS	All data for the user patterns 101-200

5. Start the recording process of the external sequencer.
6. Press [F5 (EXECUTE)] to begin sending the data.

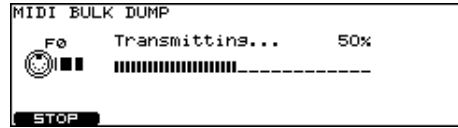

* If you want to stop sending, press [F5 (STOP)].

7. When finished, the following screen appears.



NOTE

Bulk Dump is one kind of System Exclusive message. Be sure to use an external MIDI sequencer that is capable of recording System Exclusive messages. In addition, confirm that the sequencer is not set to "Do not receive System Exclusive messages."

Loading Data to the TD-20

NOTE

At this time, all the TD-20's current data is overwritten. Make sure you have made the needed backup.

1. Connect the TD-20's MIDI IN connector with a MIDI cable to the MIDI OUT connector of the external sequencer.

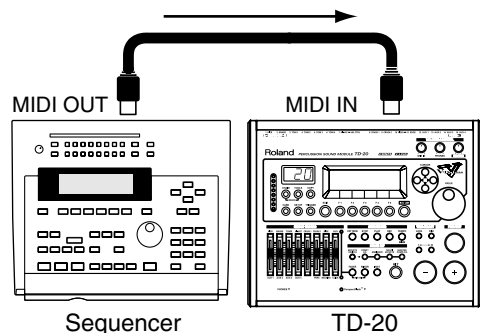

2. Press "PLAY" on the external sequencer to transmit the data to the TD-20.

Received data is written into the TD-20.

Selecting Output Destinations [F2 (OUTPUT)]

Here you can select the output destination for each TRIGGER INPUTs, sequencer parts, and the sound input from the MIX IN jack.

Output Destination for the Drum Instruments

1. Press [SETUP].

[SETUP] lights.

2. Press [F2 (OUTPUT)], and then Press [F1]–[F3] to select the output destination jacks.

The “OUTPUT ASSIGN (MASTER)” or “OUTPUT ASSIGN (DIRECT)” screen appears.

[F1 (MASTER)]: MASTER OUT jacks and PHONES jack

[F2 (DIR 1–4)]: DIRECT OUT 1–4 jacks

[F3 (DIR 5–8)]: DIRECT OUT 5–8 jacks

3. Press TRIG SELECT [1], [15], [RIM], or [CURSOR (left/right)] to select the TRIGGER INPUT.

You can also select by striking the pad.

4. Use [+/-], [VALUE], or [CURSOR (up/down)] to select the output destination.

OUTPUT ASSIGN (MASTER) screen

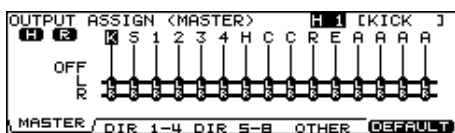

* You can restore all output destinations to factory settings (L+R) by pressing [F5 (DEFAULT)] - [F5 (EXECUTE)].

OUTPUT ASSIGN (DIRECT) screen

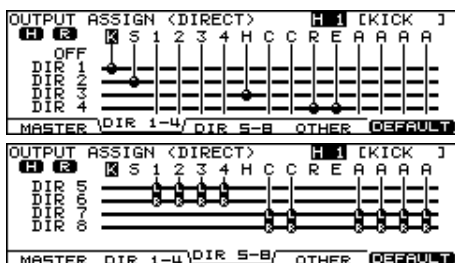

* You can restore all output destinations to factory settings by pressing [F5 (DEFAULT)] - [F5 (EXECUTE)].

Output Destination for the Sequencer Parts/Metronome Click/Sound Input from MIX IN [F4 (OTHER)]

1. Press [SETUP].

[SETUP] lights.

2. Press [F3 (OUTPUT)] - [F4 (OTHER)].

The “OUTPUT ASSIGN (OTHER)” screen appears.



3. Press [CURSOR (left/right)] to select the source.

AMB: Ambience

MFX: Multi-effects

BACK: Backing parts of the sequencer

PERC: Percussion part of the sequencer

CLICK: Metronome click

MIXIN: Sound input from the MIX IN jack

4. Use [+/-], [VALUE], or [CURSOR (up/down)] to select the output destination.

* You can restore all output destinations to factory settings (MASTER and PHONES) by pressing [F5 (DEFAULT)] - [F5 (EXECUTE)].



Block Diagram (p. 104)

Setting the Switches [F3 (CONTROL)]

Using Foot Switches [F1 (FOOT SW)]

Two foot switches (BOSS FS-5U, optional) can be used with an optional cable (PCS-31) to switch drum kits and play back patterns.

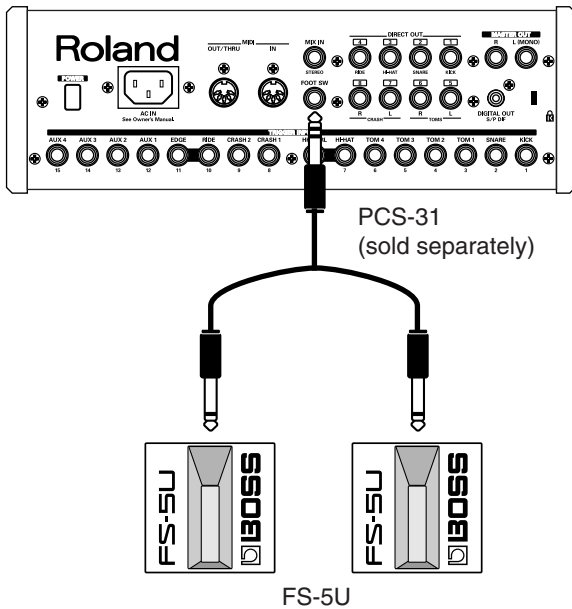

Foot Switch	SW1	SW2
FS-5U x 2 (PCS-31)	o (red plug)	o (white plug)
DP-2	-	o

o: Functions -: Does not function

1. Connect the foot switches to the FOOT SW jack.
2. Press [SETUP].
[SETUP] lights.
3. Press [F3 (CONTROL)] - [F1 (FOOT SW)].
The "FOOT SWITCH" screen appears.

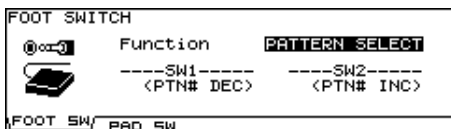

4. Use [+/-] or [VALUE] to select the function for foot switches.

5. When setting to "USER," press [CURSOR] to move the cursor to "SW1" or "SW2."
6. Use [+/-] or [VALUE] to select the functions for SW1 and SW2.

Function	SW1	SW2
KIT SELECT	KIT# DEC	KIT# INC
CHAIN SELECT	CHAIN# DEC	CHAIN# INC
PATTERN SELECT	PTN# DEC	PTN# INC
PATTERN PLAY	PTN# INC	STOP/PLAY
USER	Select from the table below.	

KIT# INC	Calls up the next kit.
KIT# DEC	Calls up the previous kit.
CHAIN# INC	Calls up the next drum kit chain.
CHAIN# DEC	Calls up the previous drum kit chain.
PTN# INC	Calls up the next pattern.
PTN# DEC	Calls up the previous pattern.
PTN PLAY	Plays back the pattern.
PTN STOP	Stops the pattern.
STOP/PLAY	Plays back/stops the pattern.
XSTICK SW	Switches to use/not use cross stick.

HINT

When using foot switches to switch kits in a Drum Kit Chain (p. 82), FUNCTION should be set to "KIT SELECT," and you need to press the [CHAIN], so its indicator is lit. (The Drum Kit Chain settings need to be made beforehand.)

Using Pads as Switches [F2 (PAD SW)]

Pads connected to TRIGGER INPUT 15 (AUX4) and/or 14 (AUX3) can be set to switch drum kits and play back patterns.

1. Connect the pad(s) to the TRIGGER INPUT 15 (AUX 4) and/or 14 (AUX3).

2. Press [SETUP].
[SETUP] lights.

3. Press [F3 (CONTROL)] - [F2 (PAD SW)].
The “PAD SWITCH” screen appears.



4. Use [+/-] or [VALUE] to select the function.

5. When setting to “USER,” press [CURSOR] to move the cursor to “AUX3” and “AUX4.”

6. Use [+/-] or [VALUE] to select the functions for the heads and rims of AUX3 and AUX4.

Function	AUX3		AUX4	
	Head	Rim	Head	Rim
OFF	OFF		OFF	
KIT SELECT1	OFF		KIT# INC	KIT# DEC
KIT SELECT2		KIT# DEC		KIT# INC
CHAIN SELECT1	OFF		CHAIN # INC	CHAIN # DEC
CHAIN SELECT2		CHAIN# DEC		CHAIN# INC
PATTERN SELECT1	OFF		PTN# INC	PTN# DEC
PATTERN SELECT2		PTN# DEC		PTN# INC
USER	Select from the table below.			

OFF	Turns off Pad Switch.
KIT# INC	Calls up the next kit.
KIT# DEC	Calls up the previous kit.
CHAIN# INC	Calls up the next drum kit chain.
CHAIN# DEC	Calls up the previous drum kit chain.
PTN# INC	Calls up the next pattern.
PTN# DEC	Calls up the previous pattern.
XSTICK SW	Switches to use/not use cross stick.

HINT

- If you don't want sound from the pad used as a pad switch, press [MIXER] - [F1 (VOLUME)], and set the volume level for AUX4 and/or AUX3 to “0” (p. 37). Or press [INST] and select “561 Off” for AUX4 and/or AUX3 (p. 31).
- When using pad switches to switch kits in a Drum Kit Chain (p. 82), FUNCTION should be set to “KIT SELECT 1” or “KIT SELECT 2,” and you need to press the [CHAIN], so its indicator is lit. (The Drum Kit Chain settings need to be made beforehand.)

Other Settings [F4 (OPTION)]

Preview Button Settings [F1 (PREVIEW)]

Here, the [PREVIEW] velocity can be set.

1. Press [SETUP].
[SETUP] lights.

2. Press [F4 (OPTION)] - [F1 (PREVIEW)].
The “PREVIEW” screen appears.

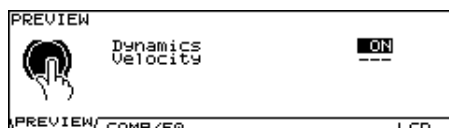

3. Press [CURSOR (up/down)] to select the parameter.

4. Use [+/-] or [VALUE] to make settings.

parameter	Value	Description
Dynamics	OFF, ON	OFF: No velocity. Level is fixed. ON: Button responds to velocity.
Velocity	1–127	Velocity when Dynamics is set to “OFF.”

Master Effect Mode [F2 (COMP/EQ)]

You can specify which is used for the master effect (p. 43), individual settings for each drum kit or common settings to all kits.

1. Press [SETUP].
[SETUP] lights.

2. Press [F4 (OPTION)] - [F2 (COMP/EQ)].

The "MASTER COMP/EQ MODE" screen appears.

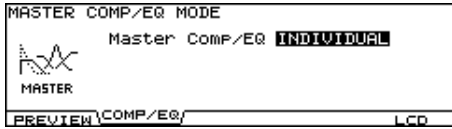

3. Use [+/-] or [VALUE] to make settings.

- INDIVIDUAL:** Master effect for each kit, individually.
- GLOBAL:** Master effect common to other drum kits is used.

When this is set to "GLOBAL," "GLOBAL" appears on the icon at the left part of the master effect setting screen.



Adjusting the Display Contrast [F5 (LCD)]

The display contrast is strongly influenced by the location of the TD-20 and the lighting of the room it's in. Adjust this parameter when needed.

1. Press [SETUP].

[SETUP] lights.

2. Press [F4 (OPTION)] - [F5 (LCD)].

The "LCD CONTRAST" screen appears.

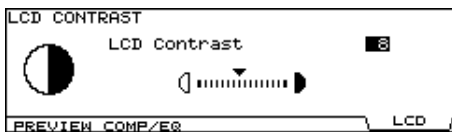

3. Use [+/-] or [VALUE] to adjust.

* You can also adjust it by holding [KIT] and turning [VALUE].

Restoring the Factory Settings [F5 (F RESET)]

This restores the TD-20 to the original factory settings (Factory Reset).



All data and settings stored in the TD-20 are lost in carrying out this operation. So if necessary, save your data to a memory card or an external MIDI device before executing the factory reset (p. 70, p. 77).

1. Press [SETUP] - [F5 (F RESET)].

[SETUP] lights, and the "FACTORY RESET" screen appears.

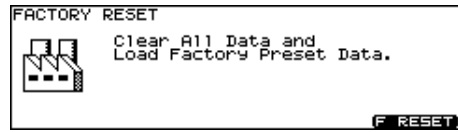

2. Press [F5 (RESET)].

The confirmation screen appears.

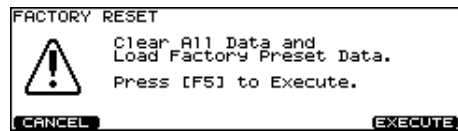

* To cancel, press [F1 (CANCEL)].

3. Press [F5 (EXECUTE)] to execute Factory Reset.

When Factory Reset is finished, the following screen appears.

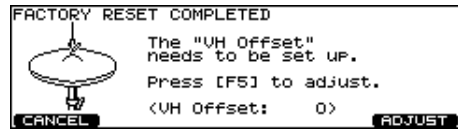

* If you do not want to adjust the VH Offset parameter, press [F1 (CANCEL)].

4. Press [F5 (ADJUST)].

The "VH OFFSET ADJUSTMENT" screen appears.

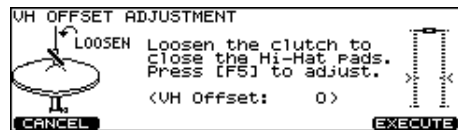

5. Loosen the clutch of the top hi-hat and let it sit on the bottom hi-hat.

* Do NOT touch the hi-hats or the pedal.

6. Press [F5 (EXECUTE)].

The VH Offset parameter is set automatically.

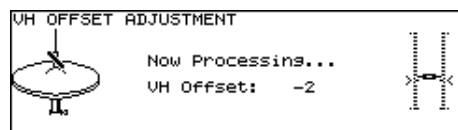

When finished, the "DRUM KIT" screen appears.



When Factory Reset is carried out, the [GROUP FADERS] settings values are set to the maximum volume, regardless of the slider positions.

Chapter 11. Drum Kit Chain [CHAIN]

Drum Kit Chain allows you to step through the drum kits of your choice and in the order you want. The TD-20 lets you create and store 16 different chains of up to 32 steps each.

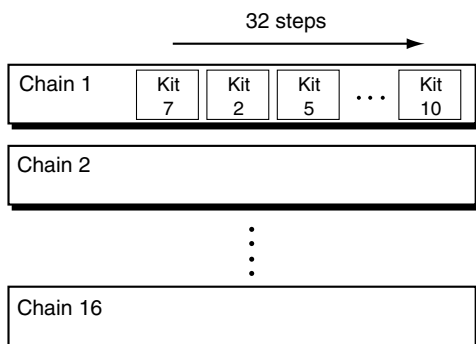

Creating a Drum Kit Chain

1. Press [CHAIN] to switch Drum Kit Chain on.

[CHAIN] lights, and the “DRUM KIT CHAIN” screen appears.



2. Press [F1 (EDIT)].

The “CHAIN EDIT” screen appears.

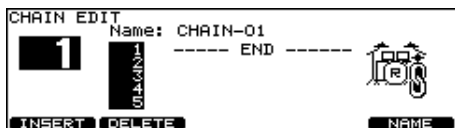

3. Press [CURSOR (left)] to move the cursor to the chain number.
4. Use [+/-] or [VALUE] to select the chain number.
5. Press [CURSOR (right)] to move the cursor to the step (the order in which the drum kits will be selected) in the right area of the display.
6. Press [CURSOR (up/down)] to select the step.
7. Use [+/-] or [VALUE] to select the drum kit.

8. Repeat steps 7 and 8 to create the drum kit chain.

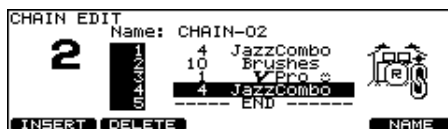

9. Press [EXIT].

The “DRUM KIT CHAIN” screen appears.

Function Buttons

[F1 (INSERT)]

A step with the same kit is inserted at the cursor position, and steps after this point are moved back one place.

[F2 (DELETE)]

Step at the cursor position is deleted, and steps after this point are moved forward one place.

[F5 (NAME)]

You can name a drum kit chain.

Naming a Drum Kit Chain [F5 (NAME)]

Each chain's name can use up to 12 characters.



1. Select the drum kit chain you want to name in the “DRUM KIT CHAIN” screen.
2. Press [F1 (C EDIT)] - [F5 (NAME)].
The “CHAIN NAME” screen appears.
3. Press [CURSOR (left/right)] to move the cursor to the character to be changed.
4. Use [VALUE], [+/-], or [CURSOR (up/down)] to change the character.

Function Buttons

[F1 (INSERT)]

A blank space is inserted at the cursor position, and characters after this point are moved to the right one space.

[F2 (DELETE)]

Character at the cursor position is deleted, and characters after this point are moved to the left one space.

[F3 (SPACE)]

Character at the cursor position is replaced by a blank space.

[F4 (CHAR)]

Type of character at the cursor position changes between upper case/lowercase alphabet, or numbers and symbols.

5. When you're finished, press [EXIT] twice to return to the “DRUM KIT CHAIN” screen.

Playing with a Drum Kit Chain

1. Press [CHAIN] to switch Drum Kit Chain on.

[CHAIN] lights.



2. Press [CURSOR (up/down)] to select the chain number to be used.
3. Use [+/-] or [VALUE] to call up the kits to be used in each selected step in the chain.
4. When the performance is finished, press [CHAIN] or [EXIT] to switch Drum Kit Chain off.
[CHAIN] goes off.



With the Foot Switch and Pad Switch functions, you can use the foot switches and pads to call up drum kit chains. For more details, refer to **Using Foot Switches [F1 (FOOT SW)]** (p. 79) and **Using Pads as Switches [F2 (PAD SW)]** (p. 80).



If differences in volume levels between kits is a problem, press [MIXER] - [F4 (KIT VOL)] and adjust “Kit Volume” (the overall kit volume).

Chapter 12. Other Functions [TOOLS]

Output Level Monitor [F1 (MONITOR)]

1. Press [TOOLS] - [F1 (MONITOR)].
[TOOLS] lights, and the "OUTPUT MONITOR" screen appears.

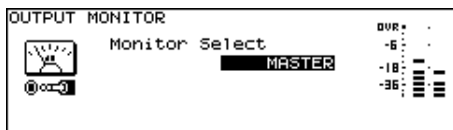

2. Use [+/-] or [VALUE] to select the output.
Choose from: Master, Phones, and separate stereo outs.
3. Press [EXIT] twice (or just press [KIT]) to return to the "DRUM KIT" screen.
[TOOLS] goes off.

Checking the Current Status [F2 (INFO)]

1. Press [TOOLS] - [F2 (INFO)].
2. Press [F1], [F2], or [F5] to display the status you want to see.

[F1 (MEMORY)]: Information of the internal memory

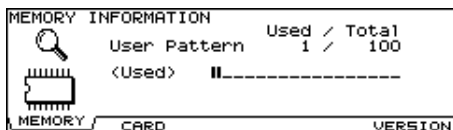

[F2 (CARD)]: Memory card information

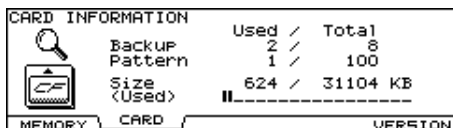

[F5 (VERSION)]: TD-20's internal program version

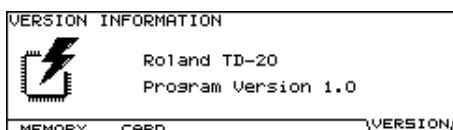

3. Press [EXIT] twice (or just press [KIT]) to return to the "DRUM KIT" screen.

Synchronizing Images to a TD-20 Performance [F5 (V-LINK)]

What is V-LINK?

V-LINK (**V-LINK**) is a function that allows music and images to be performed together. By using MIDI to connect two or more V-LINK compatible devices, you can easily enjoy performing a wide range of visual effects that are linked to the expressive elements of a music performance.

For example, by using the TD-20 and Edirol DV-7PR together, you can use the pads connected to the TD-20 to switch the Edirol DV-7PR's images (clips/palettes).

* In order to use V-LINK with the TD-20 and Edirol DV-7PR, you will need to make connections using an Edirol UM-1X/UM-1SX (sold separately).

Connection Examples

* Before connecting this unit to other devices, turn off the power to all units. This will help prevent malfunctions and/or damage to speakers or other devices.

Use an Edirol UM-1X to connect the TD-20's MIDI OUT connector to the Edirol DV-7PR's remote jack.

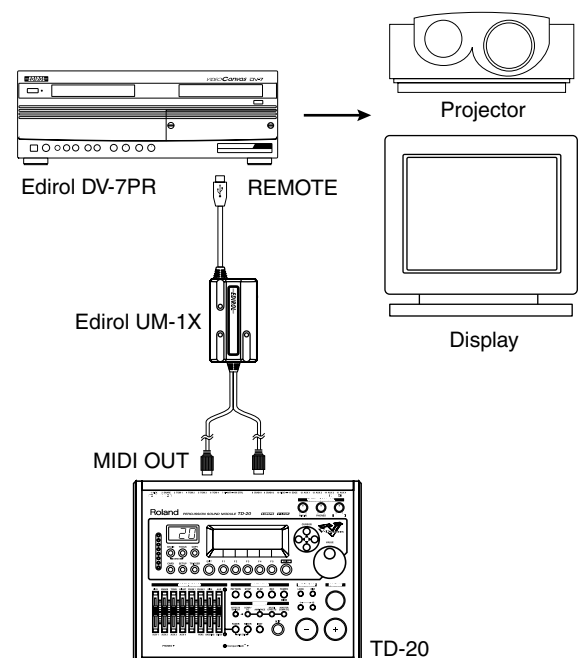

Using V-LINK

Turning V-LINK On/Off

1. Press [TOOLS].

[TOOLS] lights, and the “TOOLS” screen appears.

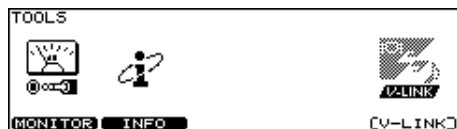

2. Press [F5 (V-LINK)] to turn the V-LINK function ON and OFF.

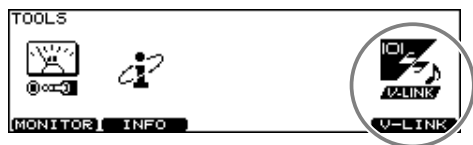

* Before turning V-LINK on, turn the Edirol DV-7PR's power on.

3. Press [KIT] or [EXIT] to display the “DRUM KIT” screen.

When V-LINK is on, the V-LINK icon appears in the “DRUM KIT” screen.



* The V-LINK function will always be OFF when you turn the TD-20's power on.

V-LINK Functions that the TD-20 Can Control and MIDI Messages

When playing a pattern by hitting a pad (Pad Pattern; p. 35), you can assign the following functions to the note messages recorded in the backing parts of the pattern to control the V-LINK-compatible video equipment.

- * The backing parts are the parts other than the drum part and percussion part of the internal sequencer.
- * Set Play Type (p. 58) of the pattern to “V-LINK.”
- * The Performance data recorded in the backing part of the sequencer is transmitted on V-LINK MIDI Ch (p. 75).
- * Set V-LINK Device ID (p. 75) to match the device ID number of the video equipment which is controlled by the TD-20.

V-LINK function		Transmitted MIDI messages
Palette 1–20	Selecting a palette	Note On (*1)
Clip 1–28	Selecting a clip	Note On (*2)
Dissolve Time	Changing the time of the transition between clips	Note On (*2) (Velocity)

*1		*2	
Palette No.	Note No.	Clip No.	Note No.
Palette 1	37 (C#2)	Clip 1	36 (C2)
Palette 2	39 (D#2)	Clip 2	38 (D2)
Palette 3	42 (F#2)	Clip 3	40 (E2)
Palette 4	44 (G#2)	Clip 4	41 (F2)
Palette 5	46 (A#2)	Clip 5	43 (G2)
Palette 6	49 (C#3)	Clip 6	45 (A2)
Palette 7	51 (D#3)	Clip 7	47 (B2)
Palette 8	54 (F#3)	Clip 8	48 (C3)
Palette 9	56 (G#3)	Clip 9	50 (D3)
Palette 10	58 (A#3)	Clip 10	52 (E3)
Palette 11	61 (C#4)	Clip 11	53 (F3)
Palette 12	63 (D#4)	Clip 12	55 (G3)
Palette 13	66 (F#4)	Clip 13	57 (A3)
Palette 14	68 (G#4)	Clip 14	59 (B3)
Palette 15	70 (A#4)	Clip 15	60 (C4)
Palette 16	73 (C#5)	Clip 16	62 (D4)
Palette 17	75 (D#5)	Clip 17	64 (E4)
Palette 18	78 (F#5)	Clip 18	65 (F4)
Palette 19	80 (G#5)	Clip 19	67 (G4)
Palette 20	82 (A#5)	Clip 20	69 (A4)
		Clip 21	71 (B4)
		Clip 22	72 (C5)
		Clip 23	74 (D5)
		Clip 24	76 (E5)
		Clip 25	77 (F5)
		Clip 26	79 (G5)
		Clip 27	81 (A5)
		Clip 28	83 (B5)

* For details on clips/palettes, dissolve time, and retrigger point, refer to the Edirol DV-7PR owner's manual.

NOTE

The TD-20 does not support the Edirol DV-7PR's dual stream mode.

About Expansion Board

Expansion boards (optional) are cards that allow you to upgrade the system and add new instruments and drum kits.

The bottom panel of the TD-20 has a slot that allows expansion boards to be installed.

Install only the specified circuit board (SOUND & SYSTEM EXPANSION BOARD for TD-20).

* *Sound expansion boards for the Roland JV/XP/XV/Fantom series cannot be used.*

Cautions When Installing a Expansion Board

- To avoid the risk of damage to internal components that can be caused by static electricity, please carefully observe the following whenever you handle the board.
 - Before you touch the board, always first grasp a metal object (such as a water pipe), so you are sure that any static electricity you might have been carrying has been discharged.
 - When handling the board, grasp it only by its edges. Avoid touching any of the electronic components or connectors.
 - Save the bag in which the board was originally shipped, and put the board back into it whenever you need to store or transport it.
- Do not touch any of the printed circuit pathways or connection terminals.
- Never use excessive force when installing a circuit board. If it doesn't fit properly on the first attempt, remove the board and try again.
- When circuit board installation is complete, double-check your work.
- Always turn the unit off and unplug the power cord before attempting installation of the circuit board (SOUND & SYSTEM EXPANSION BOARD for TD-20).
- Install only the specified circuit board (SOUND & SYSTEM EXPANSION BOARD for TD-20). Remove only the specified screws.

How to Install a Expansion Board

1. Always turn the TD-20 off and unplug the power cord before attempting installation of the circuit board (SOUND & SYSTEM EXPANSION BOARD for TD-20).
2. Remove only the eight screws as indicated below, and open the cover located on the bottom of the TD-20.

○ Removal screws

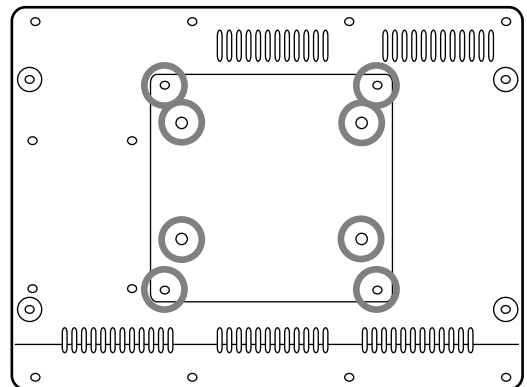

3. Check that the plastic board holders are positioned as shown figure. Rotate them if necessary.

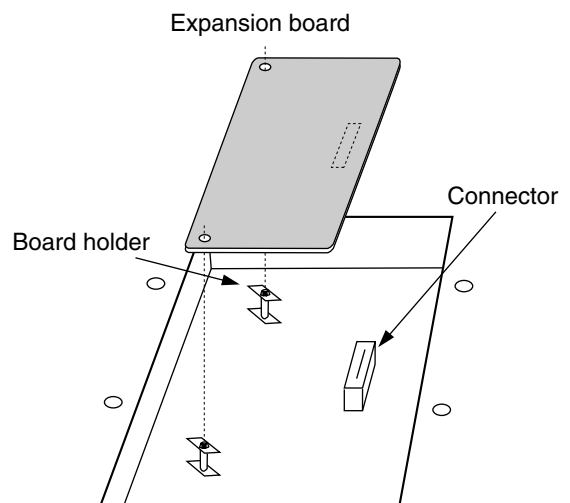

4. While positioning the holes on the board over the board holders, carefully insert the connector on the board into the socket on the TD-20. Make sure the connector is securely connected, and that all three board holders project through the holes.
5. Use the Installation Tool supplied with the Expansion board to turn the holders in the LOCK direction, so the board will be fastened in place.

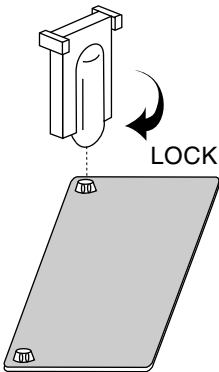

(To remove the Expansion board, turn the board holders in the UNLOCK direction, and lift up the board using the provided tool. Remove the board and secure the cover plate.)

6. Secure the cover plate using the eight screws removed in step 2.

À propos des carte d'extension

(French language for Canadian Standard)

French language
for Canadian Safety Standard

Les cartes d'extension (optionnelles) sont des cartes qui vous permettent d'augmenter la puissance de votre système et d'ajouter de nouveaux instruments ainsi que des batteries.

Le panneau du dessous du TD-20 a un créneau permettant l'installation des cartes d'extension.

N'installez que la ou les carte de circuits imprimés spécifiée. (SOUND & SYSTEM EXPANSION BOARD pour TD-20)

* Les cartes d'extension de son pour les séries JV/XP/XV/Fantom de Roland ne peuvent être utilisées.

Précautions à prendre lors de l'installation d'une carte d'extension

- Veuillez suivre attentivement les instructions suivantes quand vous manipulez la carte afin d'éviter tout risque d'endommagement des pièces internes par l'électricité statique.
 - Toujours toucher un objet métallique relié à la terre (comme un tuyau par exemple) avant de manipuler la carte pour vous décharger de l'électricité statique que vous auriez pu accumuler.
 - Lorsque vous manipulez la carte, la tenir par les côtés. Évitez de toucher aux composants ou aux connecteurs.
 - Conservez le sachet d'origine dans lequel était la carte lors de l'envoi et remettez la carte dedans si vous devez la ranger ou la transporter.
- Ne pas toucher aux circuits imprimés ou aux connecteurs.
- Ne jamais forcer lors de l'installation de la carte de circuits imprimés. Si la carte s'ajuste mal au premier essai, enlevez la carte et recommencez l'installation.
- Quand l'installation de la carte de circuits imprimés est terminée, vérifiez si tout est bien installé.
- Toujours éteindre et débrancher l'appareil avant de commencer l'installation de la carte. (SOUND & SYSTEM EXPANSION BOARD pour TD-20).
- N'installez que les cartes de circuits imprimés spécifiées (SOUND & SYSTEM EXPANSION BOARD pour TD-20). Enlevez seulement les vis indiquées.

Installation d'une carte d'extension

1. Éteignez toujours le TD-20 et débranchez le câble électrique avant toute tentative d'installation de carte de circuits imprimés (SOUND & SYSTEM EXPANSION BOARD pour TD-20).
2. Enlevez seulement les huit vis et ouvrez la plaque située sous le TD-20.

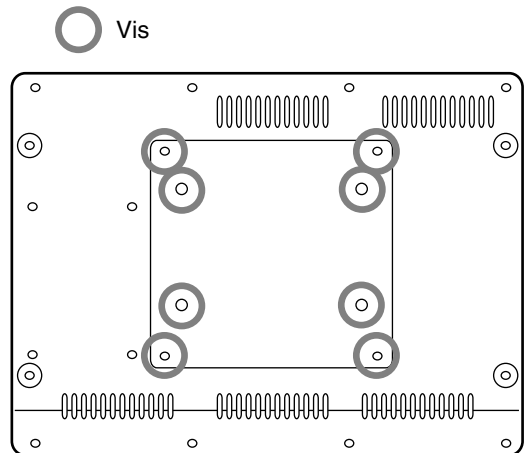

3. Veillez à ce que les supports en plastique pour la carte soient positionnés tel qu'indiqué. Faites-les pivoter si nécessaire.

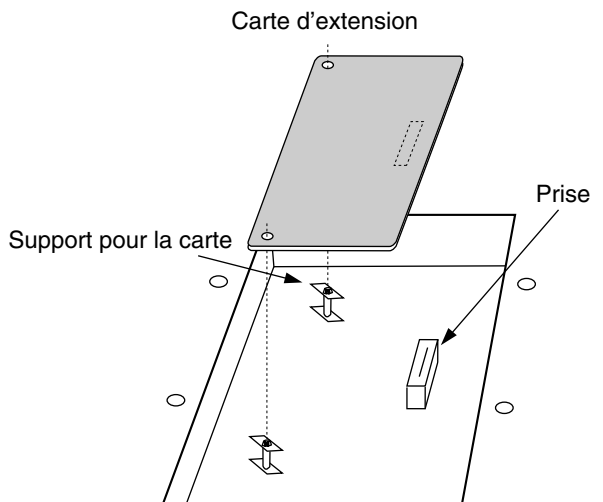

- 4. Pendant que vous alignez les trous de la carte au-dessus des supports, insérez délicatement le connecteur sur la carte dans la prise du TD-20. Assurez-vous que le connecteur est raccordé correctement et que les trois supports s'emboîtent bien dans les trous.**
- 5. Pour tourner les supports en position LOCK (verrouillé), utilisez l'outil d'installation de la carte d'extension fournie à cet effet. De cette façon, la carte sera bien fixée à sa place.**

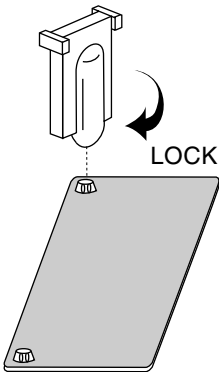

(Pour enlever la carte d'extension, faites tourner les supports dans la direction UNLOCK (déverrouillé) et soulevez la carte en utilisant l'outil à cet effet. Retirez la carte et remettez la plaque .)

- 6. Refermez la plaque en utilisant les huit vis enlevées à l'étape 2.**

Messages and Error Messages

This section lists the messages (error messages) that the TD-20 produces and explains the meaning of each message, giving you the appropriate action to take.

MEMO

When an indication of "ACCEPT" is shown above [F5] as in the figure, pressing that button will close the message window.



Error Messages

Message	Meaning	Action
Backup Battery Low!	The internal backup battery of the TD-20 (a battery that maintains data in the user memory) has run down.	Contact your dealer or a nearby Roland service center to have the battery replaced.
Backup NG!	Data in the TD-20's memory may be corrupted. The TD-20's internal backup battery (the battery used for saving User memory data) is fully drained; internal data has been lost.	Contact your dealer or a nearby Roland service center to have the battery replaced. Follow the messages appearing on the screen to carry out Factory Reset (p. 81); you will then be able to use the unit temporarily.
MIDI Communication Error!	It is possible that the power has been turned off for the MIDI device connected to the TD-20's MIDI IN connector.	Check the power of the connected MIDI device.
System Error!	A problem has occurred with the internal system.	Contact your dealer or a nearby Roland service center.
Measure Maximum!	The maximum number of measures that can be recorded to one pattern has been exceeded; no further recording or editing that adds measures can be carried out.	Delete unneeded measures from the pattern being recorded or edited (p. 66).
Step Maximum!	The maximum number of steps that can be recorded to one chain has been exceeded; no further editing that adds steps can be carried out.	Delete unneeded steps from the chain being edited (p. 82).
Data Overload!	Pattern contained an excessive amount of data, and as a result could not be output successfully from MIDI OUT.	Try eliminating a part that has too much data.
Not Enough Memory!	Pattern recording or editing could not be carried out because there was not enough internal memory.	Try deleting patterns that are no longer needed (p. 66).
No Card!	No card is in the memory card slot.	Insert a memory card.
No Space!	There are no empty space on the memory card.	Delete unneeded data (p. 72).
No Data!	No data you request on the memory card.	–
Unsupported!	A card the size of which is not supported by TD-20 has been inserted.	Cards supported by TD-20 are 3.3 V Compact-Flash cards with the capacity of 16 to 512 MB. Check the card.
Unformatted!	A card the format of which is not supported by TD-20 has been inserted.	Format the card (p. 72).
Card Damaged!	The data stored on the card has been corrupted.	Format the card (p. 72).
BULK DUMP Checksum Error!	The checksum value of a system exclusive message was incorrect.	Correct the checksum value.

Message	Meaning	Action
BULK DUMP Receive Address Error!	The receive address of a system exclusive message was incorrect.	Correct the receive address.
BULK DUMP Receive Data Error!	A MIDI message was received incorrectly.	If the same error message is displayed repeatedly, there is a problem with the MIDI messages that are being transmitted to the TD-20.
BULK DUMP Receive Time Out!	The interval in receiving system exclusive messages were too long.	Make the interval of the data shorter.

Messages

Message	Meaning	Action
BULK DUMP Receiving... Please Wait.	Bulk data is now being received.	–
BULK DUMP Aborted!	Bulk data transmission was halted.	–
Preset Pattern!	You cannot record on the preset pattern.	Copy the pattern onto a user pattern.
Empty Pattern!	This pattern contains no performance data; it cannot be edited.	Select the other pattern that contains performance data.
No Empty Pattern!	There are no empty patterns for recording.	Delete unneeded pattern (p. 66).
MIDI Offline!	A MIDI cable was disconnected. (Or communication with the external MIDI device stopped for some reason.)	Make sure that MIDI cables have not been pulled out or broken.
MIDI Buffer Full!	A large amount of MIDI messages were received in a short time, and could not be processed completely.	Confirm that the external MIDI device is properly connected. If the problem persists, reduce the amount of MIDI messages sent to the TD-20.
No Empty Backup!	There are no empty backup area on the memory card.	Delete unneeded backup (p. 72).
No Empty Backup Pattern!	There are no empty backup pattern on the memory card.	Delete unneeded backup pattern (p. 68).
Power On Too Long. Please Turn Off!	The power remains ON for a long time.	Turn the TD-20's power off, then turn on again.
Auto Shutdown Completed. Please Turn Off!		

Drum Instrument List

No.	Name	Remark	No.	Name	Remark	No.	Name	Remark
KICK			KICK ELEC			SNARE BRUSH		
1	22" Birch	K	58	Cosmic	K	109	Brush1	S *BRUSH
2	22" Solid	K	59	Hi-Q	K	110	Brush1	SR
3	22" StdMple	K	60	Analog1	K	111	Brush2	S *BRUSH
4	22" Maple	K	61	Analog2	K	112	Brush2	SR
5	24" Carbon	K	62	Analog3	K	SNARE PROCESSED		
6	22" CbnMple	K	63	ClascElec1	K	113	Basis	S *X
7	22" GT	K	64	ClascElec2	K	114	Chunk	S *X
8	22" TitanHp	K	65	ClascElec3	K	115	ClapTail	S *X
9	22" Mahogany	K	66	ClascElec4	K	116	ClubDry	S *X
10	20" Lite	K	67	ClascElec5	K	117	Dump	S *X
11	22" RoseWd	K	68	ClascElec6	K	118	HopRim1	S *X
12	22" Oak	K	69	TR808	Kick	119	HopRim2	S *X
13	Recording1	K	70	TR909	Kick	120	HopRim3	S *X
14	Recording2	K	SNARE			121	LzrGate	S *X
15	Universal	K	71	RoundBdge	S *P *I	122	Pick	S *X
16	BigOpen	K	72	RoundBdge	SR *P *I *X	123	Planet	S *X
17	JazzCombo1	K	73	CoolyMple	S *P *I	124	RB	S *X
18	JazzCombo2	K	74	CoolyMple	SR *P *I *X	125	2Step	S *X
19	Cannon	K	75	70'sMetal	S *P *I	126	Lo-Fi	S *X
20	Roto	K	76	70'sMetal	SR *P *I *X	127	Round	XStik
21	Booth	K	77	WoodBrass	S *P *I	128	Cooly	XStik
22	Ballad	K	78	WoodBrass	SR *P *I *X	129	70's	XStik
23	Swing	K	79	13"Hole	S *P *I	130	WoodBr	XStik
24	Heavy	K	80	13"Hole	SR *P *I *X	131	13"	XStik
25	Can	K	81	Aluminum	S *P *I	132	Alumi	XStik
26	Fusion	K	82	Aluminum	SR *P *I *X	133	Titan	XStik
27	Latin	K	83	Titanium	S *P *I	134	Skanky	XStik
28	Meat	K	84	Titanium	SR *P *I *X	135	30's	Xstik
29	Pillow	K	85	Skanky	S *P *I	136	Reggae	XStik
30	DryMed	K	86	Skanky	SR *P *I *X	137	Ballad	XStik
31	Dry	K	87	30'sMaple	S *P *I	138	Studio	XStik
32	Solid	K	88	30'sMaple	SR *P *I *X	139	Swing	XStik
33	Reso	K	89	BrassPico	S *P *I	140	Hard	XStik
34	Raw	K	90	BrassPico	SR *P *I *X	141	Maple	XStik
35	Vintage	K	91	Booth	S *I	SNARE ELEC		
36	OldMple	K	92	Booth	SR *I *X	142	ClascElec1	S
37	Hard	K	93	Studio	S *I	143	ClascElec2	S
38	BigLow	K	94	Studio	SR *I *X	144	ClascElec3	S
39	Hybrid	K	95	Ballad	S *I	145	ClascElec4	S
40	Gabba1	K	96	Ballad	SR *I *X	146	ClascElec5	S
41	Gabba2	K	97	Swing	S *P *I	147	TR808	Snare
42	Gabba3	K	98	Swing	SR *I *X	148	TR808	SnrRim
KICK PROCESSED			99	Street	S *P *I *X	149	TR909	Snare
43	Cartoon	K	100	Lite	S *P *I *X	150	TR909	SnrRim
44	Chicken	K	101	LA Fat	S *I *X			
45	Jive	K	102	Ring	S *I *X			
46	RB	K	103	Whack	S *I *X			
47	Layered	K	104	Impulse	S *I *X			
48	Lazy	K	105	Cruddy1	S *I *X			
49	HardLow	K	106	Cruddy2	S *I *X			
50	Alley	K	107	HotRod	S *I			
51	DaFloor	K	108	HotRod	SR *I *X			
52	Croak	K						
53	Plastic	K						
54	Trip	K						
55	Gokigen	K						
56	FX-Wah	K						
57	Lo-Fi	K						

No.	Name	Remark	No.	Name	Remark	No.	Name	Remark
TOM			207	8"Roto T1		TOM ELEC		
151	12"Birch T1		208	8"Roto T1R		269	ClscElec1 T1	
152	12"Birch T1R	*P	209	10"Roto T2		270	ClscElec1 T2	
153	13"Birch T2		210	10"Roto T2R		271	ClscElec1 T3	
154	13"Birch T2R	*P	211	12"Roto T3		272	ClscElec1 T4	
155	16"Birch T3		212	12"Roto T3R		273	ClscElec2 T1	
156	16"Birch T3R	*P	213	14"Roto T4		274	ClscElec2 T2	
157	18"Birch T4		214	14"Roto T4R		275	ClscElec2 T3	
158	18"Birch T4R	*P	215	16"Roto T5		276	ClscElec2 T4	
159	12"GT T1		216	16"Roto T6		277	ClscElec3 T1	
160	12"GT T1R	*P	217	18"Roto T7		278	ClscElec3 T2	
161	13"GT T2		218	18"Roto T8		279	ClscElec3 T3	
162	13"GT T2R	*P	219	18"RotoExLo1		280	ClscElec3 T4	
163	16"GT T3		220	18"RotoExLo2		281	ClscElec4 T1	
164	16"GT T3R	*P	221	Ballad T1		282	ClscElec4 T2	
165	18"GT T4		222	Ballad T2		283	ClscElec4 T3	
166	18"GT T4R	*P	223	Ballad T3		284	ClscElec4 T4	
167	10"Univ T1		224	Ballad T4		285	TR808 T1	
168	10"Univ T1R	*P	225	Swing T1		286	TR808 T2	
169	12"Univ T2		226	Swing T2		287	TR808 T3	
170	12"Univ T2R	*P	227	Swing T3		288	TR808 T4	
171	14"Univ T3		228	Swing T4		289	TR909 T1	
172	14"Univ T3R	*P	229	Pop1 T1		290	TR909 T2	
173	16"Univ T4		230	Pop1 T2		291	TR909 T3	
174	16"Univ T4R	*P	231	Pop1 T3		292	TR909 T4	
175	12"Clasc T1		232	Pop1 T4				
176	12"Clasc T1R	*P	233	Pop2 T1				
177	13"Clasc T2		234	Pop2 T2				
178	13"Clasc T2R	*P	235	Pop2 T3				
179	16"Clasc T3		236	Pop2 T4				
180	16"Clasc T3R	*P	237	Round T1				
181	18"Clasc T4		238	Round T2				
182	18"Clasc T4R	*P	239	Round T3				
183	12"Fiber T1		240	Round T4				
184	12"Fiber T1R	*P	241	80'sDry T1				
185	14"Fiber T2		242	80'sDry T2				
186	14"Fiber T2R	*P	243	80'sDry T3				
187	16"Fiber T3		244	80'sDry T4				
188	16"Fiber T3R	*P	245	90'sBig T1				
189	18"Fiber T4		246	90'sBig T2				
190	18"Fiber T4R	*P	247	90'sBig T3				
191	12"Maple T1		248	90'sBig T4				
192	12"Maple T1R	*P	249	90'sPower T1				
193	14"Maple T2		250	90'sPower T2				
194	14"Maple T2R	*P	251	90'sPower T3				
195	16"Maple T3		252	90'sPower T4				
196	16"Maple T3R	*P	253	OctaTom C Hi				
197	18"Maple T4		254	OctaTom B				
198	18"Maple T4R	*P	255	OctaTom A				
199	12"Oak T1		256	OctaTom G				
200	12"Oak T1R	*P	257	OctaTom F				
201	14"Oak T2		258	OctaTom E				
202	14"Oak T2R	*P	259	OctaTom D				
203	16"Oak T3		260	OctaTom C				
204	16"Oak T3R	*P	261	Mallet T1		311	16"DarK CrBw	
205	18"Oak T4		262	Mallet T2		312	16"DarK CrEg	*I
206	18"Oak T4R	*P	263	Mallet T3		313	16"Thin CrBw	
			264	Mallet T4		314	16"Thin CrEg	*I
			265	Brush T1		315	16"PaperCrBw	
			266	Brush T2		316	16"PaperCrEg	*I
			267	Brush T3		317	16"FsPwrCrBw	
			268	Brush T4		318	16"FsPwrCrEg	*I
						319	18"PowerCrBw	
						320	18"PowerCrEg	*I
						321	18"Med CrBw	
						322	18"Med CrEg	*I
						323	19"NY CrBw	
						324	19"NY CrEg	*I
						325	18"Fast CrBw	
						326	18"Fast CrEg	*I
						327	18"Fast CrBl	
						328	Brush Cr	
						329	Brush CrEg	*I
						330	Mallet Cr	*I

Drum Instrument List

No.	Name	Remark	No.	Name	Remark	No.	Name	Remark
SPLASH			PERCUSSION			451	Timpani C	
331	6"SplazhSpBw		384	Bongo Hi		452	Timpani G	
332	6"SplazhSpEg		385	Bongo HiSlap		453	ConcertBD	
333	8"Thin SpBw		386	Bongo Lo		454	ConcertBD Mt	
334	8"Thin SpEg		387	Bongo LoSlap		455	HandCymbal	
335	8"Bell SpBw		388	Conga Hi		456	HandCymbalMt	
336	8"Bell SpEg		389	Conga HiMute		457	Triangle	
337	8"Open SpBw		390	Conga HiSlap		458	TriangleCls	
338	8"Open SpEg		391	Conga Lo		459	Triangle2	
339	10"Med SpBw		392	Conga LoMute		460	Triangle2Cls	
340	10"Med SpEg		393	Cajon Bass		461	Crotale	
CHINA			394	Cajon Mute		462	BellTree	
341	12"PgyBack		395	Cajon Slap		463	SleighBell	
342	12"PgyBackEg	*I	396	Cowbell Hi		464	TreeChimes	
343	16"Swish		397	Cowbell Lo		465	ThaiGong	
344	16"Swish Eg	*I	398	Cowbell Mute		466	TinyGong	
345	18"CB Low		399	CowbellMambo		467	Gong	
346	18"CB Low Eg	*I	400	Claves		468	OrchestraHit	
347	20"U-China	*I	401	SquareBlock		469	SnareRoll	
348	China PgBack	*I	402	Block Hi		470	ConcertSnare	
349	Crash PgBack	*I	403	Block Lo		471	SteelDrum	
RIDE			404	Maracas		472	Celesta	
350	18"PRideRd	*P	405	Caxixi		473	Glockenspiel	
351	18"PRideRdB1		406	Shaker		474	Kalimba	
352	18"PRideRdEg	*I	407	Tambourine1		475	Marimba	
353	18"Bop Rd	*P	408	Tambourine2		476	TubularBell	
354	18"Bop RdB1		409	Tambourine3		477	Vibraphone	
355	18"Bop RdEg	*I	410	Guiro Long		478	Xylophone	
356	20"HeavyRd	*P	411	Guiro Short		PERC ANALOG		
357	20"HeavyRdB1		412	Timbale Hi		479	CR78Cowbell	
358	20"HeavyRdEg	*I	413	Timbale HiRm		480	CR78Guiro	
359	20"Med Rd	*P	414	Timbale Lo		481	CR78Maracas	
360	20"Med RdB1		415	TimbalePaila		482	CR78MtlBeat	
361	20"Med RdEg	*I	416	Agogo Hi		483	CR78Tamb	
362	20"TurkyRd	*P	417	Agogo Lo		484	TR808Clap	
363	20"TurkyRdB1		418	Cabasa		485	TR808Claves	
364	20"TurkyRdEg	*I	419	Cuica Hi		486	TR808Cowbell	
365	19"NY Rd	*P	420	Cuica Lo		487	TR808Maracas	
366	19"NY RdB1		421	Cuica Acc		488	TR808XStick	
367	19"NY RdEg	*I	422	Pandeiro		489	TR909Clap	
368	20"Lite Rd	*P	423	PandeiroMute		SFX		
369	20"Lite RdB1		424	PandeiroSlap		490	Hi-Q	
370	20"Lite RdEg	*I	425	Surdo Hi		491	Poa	
371	22"CleanRd	*P	426	Surdo HiMute		492	Pyon	
372	22"CleanRdB1		427	Surdo Lo		493	Picoon	
373	22"CleanRdEg	*I	428	Surdo LoMute		494	Byon	
374	18"FormuRd	*P	429	Whistle		495	Kyun	
375	18"FormuRdB1		430	WhistleShort		496	Psyun	
376	18"FormuRdEg	*I	431	VibraSlap		497	Boom	
377	20"Bell Rd	*P	432	Tabla Na		498	SuperLow	
378	20"Bell RdB1		433	Tabla Te		499	TimeWarp1	
379	20"Bell RdEg	*I	434	Tabla Ti		500	TimeWarp2	
380	Brush Rd		435	Tabla Tin		501	Transform1	
381	Brush RdEg		436	Tabla Tun		502	Transform2	
382	Mallet1 Rd	*I	437	Baya Ge		503	Transform3	
383	Mallet2 Rd	*I	438	Baya Gin		504	Tekno FX1	
			439	Baya Ka		505	Tekno FX2	
			440	Baya Slide		506	Tekno FX3	
			441	PotDrum		507	Ring FX	
			442	PotDrum Acc		508	Drop Out	
			443	PotDrum Mute		509	LaserGun	
			444	Djembe Tone		510	Spiral	
			445	Djembe Slap		511	Emergency	
			446	Djembe Bass		512	Wonderer	
			447	TalkingDr				
			448	TalkingDr Up				
			449	Castanet				
			450	WoodBlock				

No. Name Remark

OTHER

- 513 Click
- 514 Beep
- 515 Sticks
- 516 Sticks2
- 517 MetroBell
- 518 MetroClick
- 519 FingerSnaps
- 520 Clap
- 521 R8Slap
- 522 Motor
- 523 Engine
- 524 Glass
- 525 Burt
- 526 Boing1
- 527 Boing2
- 528 Bounce
- 529 VerbyHit
- 530 AfroStomp
- 531 Bomb!
- 532 TuningTom
- 533 ReverseCrash
- 534 ReverseChina
- 535 PhaseCrash
- 536 PhaseRide
- 537 Scratch1
- 538 Scratch2
- 539 Scratch3
- 540 Scratch4
- 541 TapeStop
- 542 TapeRewind
- 543 Voice OK
- 544 Voice Yeah
- 545 Vocoder1
- 546 Vocoder2
- 547 TeknoHit
- 548 PhillyHit
- 549 FunkHit
- 550 Bass Gliss
- 551 Guitar Gliss
- 552 GuitarScratch
- 553 CutGt Down
- 554 CutGt Up
- 555 WahGt1 Down
- 556 WahGt1 Up
- 557 WahGt2 Down
- 558 WahGt2 Up
- 559 Sine 440Hz
- 560 For PadCheck
- 561 Off

About Remarks

***P (Position):**
Can get various changes of the sound in accordance with the positioning where on the pad you hit with a stick. In rim sounds, can get such various changes of the sound in accordance with the depth of the stick on the rim.

***I (Interval):**
Can make the sound so smooth in accordance with a roll or continuous strokes with sticks.

***X (XStick):**
When the Cross Stick Switch is turned ON, it makes possible to use both "Rim Shot" and "Cross Stick" on the rim.

***BRUSH:**
Can be played using "Brush Sweep."

About Snare/Tom Instruments

The last letter of each instrument name means the sound of head shot, or rim shot.

- (Example)
- S: head sound of Snare
 - SR: rim sound of Snare
 - T1: head sound of Tom 1
 - T1R: rim sound of Tom 1

About Cymbal Instruments

The last letter of each instrument name means the sound of bow shot, edge shot, or bell shot.

- (Example)
- HH: bow sound of hi-hat
 - HHEg: edge sound of hi-hat
 - CrBw: bow sound of crash
 - CrEg: edge sound of crash
 - Rd: bow sound of ride
 - RdB1: bell sound of ride
 - RdEg: edge sound of ride

* Special thanks to Spectrasonics.

Copyright

When you purchase the TD-20 percussion sound module from an authorized Roland dealer, the included sounds are licensed, not sold, to you by Roland Corporation, for commercial use in music production, public performance, broadcast, etc.

You may use any of the included sounds in a commercial or non-commercial recording without paying any additional license fees. However, you must strictly adhere to the following crediting guidelines on any music recording that utilize material from TD-20.

Reproduction or duplication of any of the sound contained in the TD-20, either as they exist on this sound module or by any means of reformatting, mixing, filtering, re-synthesizing, processing or otherwise editing for use in another product or for re-sale, is strictly prohibited without the express written consent of Roland. All unauthorized giving, trading, lending, renting, re-issue, re-distribution or re-sale of the sounds included in the TD-20 are expressly prohibited.

In Plain English: Be creative in your application of the TD-20 sounds, and keep this sounds for your use only. DO NOT COPY IT.

Note Number (Factory Settings)

Percussion Set

1. Latin Toys

Drum Kit

Drum Kit 1-50 (Trigger Inputs)

Note No.			
C-1	0	Bass Gliss	-
	1	GuitarScratch	-
	2	WahGt1 Down	-
	3	WahGt1 Up	-
	4	WahGt2 Down	-
	5	WahGt2 Up	-
	6	CR78Guiro	-
	7	CR78Tamb	-
	8	TR808Clap	-
	9	TR808Cowbell	-
	10	TR808Maracas	-
	11	TR909Clap	-
		HI-O	-
C0	12	R8Slap	-
	13	Scratch2	-
	14	Scratch3	-
	15	Sticks	-
	16	Click	-
	17	MetroClick	-
	18	MetroBell	-
	19	Clap	-
	20	VibraSlap	-
	21	SquareBlock	(7) Closed HH Rim
	22	Off	(for_BrushSweep) (p. 36)
		Beep	-
C1	24	Crotale	(11) Ride-Edge
	25	SquareBlock	(7) Open HH Rim
	26	6"SplazhSpEg	(12) AUX1
	27	6"SplazhSpBw	(12) AUX1 Rim
	28	Guiro Short	(13) AUX2
	29	Guiro Long	(13) AUX2 Rim
	30	Cuica Hi	(14) AUX3
	31	Cuica Lo	(14) AUX3 Rim
	32	Cowbell Hi	(15) AUX4
	33	Cowbell Lo	(15) AUX4 Rim
	34	Cowbell Lo	(1) Kick Rim
	35	Cowbell Mute	(1) Kick
C2	36	Tambourine1	(for_X-Stick) (p. 36)
	37	Tambourine2	(2) Snare
	38	Conga LoMute	(6) Tom4 Rim
	39	Tambourine1	(2) Snare Rim
	40	Conga Lo	(6) Tom4
	41	Claves	(7) Closed HH
	42	Conga Hi	(5) Tom3
	43	Claves	(7) Pedal HH
	44	Bongo Lo	(4) Tom2
	45	Claves	(7) Open HH
	46	Bongo LoSlap	(4) Tom2 Rim
		Bongo Hi	(3) Tom1
C3	48	Triangle	(8) Crash1
	49	Bongo HiSlap	(3) Tom1 Rim
	50	SleighBell	(10) Ride
	51	Agogo Lo	(9) Crash2 Rim
	52	BellTree	(10) Ride Rim
	53	Tambourine1	-
	54	TriangleCls	(8) Crash1 Rim
	55	Cowbell Mute	-
	56	Agogo Hi	(9) Crash2
	57	Conga HiSlap	(5) Tom3 Rim
	58	TreeChimes	(11) Ride-Edge Rim
	59		

Note No.	
C4	60 Bongo Hi
	61 Bongo Lo
	62 Conga Hi
	63 Conga HiSlap
	64 Conga Lo
	65 Timbale Hi
	66 Timbale Lo
	67 Agogo Hi
	68 Agogo Lo
	69 Cabasa
	70 Maracas
	71 WhistleShort
	72 Whistle
C5	73 Guiro Short
	74 Guiro Long
	75 Claves
	76 Block Hi
	77 Block Lo
	78 Cuica Hi
	79 Cuica Lo
	80 TriangleCls
	81 Triangle
	82 Shaker
	83 SleighBell
	84 BellTree
C6	85 Castanet
	86 Surdo LoMute
	87 Surdo Lo
	88 Bongo HiSlap
	89 Bongo LoSlap
	90 Conga HiMute
	91 Conga LoMute
	92 PandeiroMute
	93 Pandeiro
	94 PandeiroSlap
	95 TreeChimes
	96 Crotale
C7	97 Gong
	98 Cajon Bass
	99 Cajon Mute
	100 Cajon Slap
	101 CowbellMambo
	102 SquareBlock
	103 Caxixi
	104 Timbale HiRm
	105 TimbalePaila
	106 Cuica Acc
	107 Surdo Hi
C8	108 Surdo HiMute
	109 PotDrum
	110 PotDrum Acc
	111 PotDrum Mute
	112 Djembe Tone
	113 Djembe Slap
	114 Djembe Bass
	115 TalkingDr
	116 TalkingDr Up
	117 Tabla Na
	118 Tabla Te
	119 Tabla Ti
C9	120 Tabla Tun
	121 Baya Ge
	122 Baya Gin
	123 Baya Ka
	124 Baya Slide
	125 ConcertBD
	126 HandCymbal
	127 Off

- Up to eight percussion sets can be stored.
- You can change the used instruments in each percussion set.
For details, refer to **Percussion Set Settings** (p. 55).

Backing Instrument List

PC	CC0 Name	VOICES
----	----------	--------

PIANO

1	0	PIANO 1	1
	8	PIANO 1W	2
	16	PIANO 1D	1
2	0	PIANO 2	1
	8	PIANO 2W	2
3	0	PIANO 3	1
	8	PIANO 3W	2
4	0	HONKY-TONK	2
	8	HONKY-TONK W	2

E. PIANO

5	0	E.PIANO 1	1
	8	DETUNED EP 1	2
	24	60'S E.PIANO	1
	64	FM+SA EP	2
	65	HARD EP	2
6	0	E.PIANO 2	2
	64	BRIGHT FM EP	2

CLAVI

7	0	HARPSICHORD	1
	8	COUPLED HPS.	2
	16	HARPSI.W	2
	24	HARPSI.O	2
8	0	CLAV.	1
	64	FUNK CLAV.	2

CHROMATIC PERCUSSION

9	0	CELESTA	1
10	0	GLOCKENSPIEL	1
11	0	MUSIC BOX	1
12	0	VIBRAPHONE	1
	8	VIB.W	2
13	0	MARIMBA	1
14	0	XYLOPHONE	1
15	0	TUBULAR-BELL	1
	8	CHURCH BELL	1
	9	CARILLON	1
16	0	SANTUR	1

ORGAN

17	0	ORGAN 1	1
	8	DETUNED OR.1	2
	16	60'S ORGAN 1	1
	32	ORGAN 4	2
	64	SC88 ORGAN 4	1
	65	EVEN BAR	2
18	0	ORGAN 2	1
	8	DETUNED OR.2	2
	32	ORGAN 5	2

19	0	ORGAN 3	2
20	0	CHURCH ORG.1	1
	8	CHURCH ORG.2	2
	16	CHURCH ORG.3	2

21	0	REED ORGAN	1
----	---	------------	---

22	0	ACCORDION FR	2
	8	ACCORDION IT	2

23	0	HARMONICA	1
----	---	-----------	---

24	0	BANDONEON	2
----	---	-----------	---

GUITAR

25	0	NYLON-STR.GT	1
	8	STEEL-STR.GT	1
	64	NYLON+STEEL	2

27	0	JAZZ GT.	1
	8	HAWAIIAN GT.	1

28	0	CLEAN GT.	1
	8	CHORUS GT.	2

29	0	MUTED GT.	1
	64	MUTED GT.2	2
	65	POP GT.	1
	66	FUNK GT.	1 *
	67	FUNK GT.2	1 *

30	0	OVERDRIVE GT	1
	64	FDBK.ODRV.GT	2

31	0	DISTORTIONGT	1
	8	FEEDBACK GT.	2
	64	HEAVY GT.	1
	65	FDBK. HVY.GT	2
	66	MUTED DIS.GT	1
	67	ROCK RHYTHM	2

32	0	GT.HARMONICS	1
	8	GT.FEEDBACK	1

*: VELOCITY SWITCH
The tone switches at velocity 116.

BASS

33	0	ACOUSTIC BS.	2
	64	ELCTRC.AC.BS	2

34	0	FINGERED BS.	1
	64	FUNK BASS	2
	65	REGGAE BASS	2

35	0	PICKED BS.	1
	64	MUTE PICKBS1	1
	65	MUTE PICKBS2	1

36	0	FRETLESS BS.	1
----	---	--------------	---

37	0	SLAP BASS 1	1
	64	SLAP BASS 3	1
	65	RESO SLAP	1
	66	SLAP BASS 4	1

38	0	SLAP BASS 2	1
----	---	-------------	---

SYN. BASS

39	0	SYNTH BASS 1	1
	1	SYNTHBASS101	1
	8	SYNTH BASS 3	1
	64	TB33 BS 1	1
	65	TB33 BS 2	1
	66	TB33 BS 3	1

40	0	SYNTH BASS 2	2
	16	RUBBER BASS	2
	64	SH101 BS 1	1
	65	SH101 BS 2	1
	66	SH101 BS 3	1
	67	MODULAR BASS	2

ORCHESTRA

41	0	VIOLIN	1
	8	SLOW VIOLIN	1

42	0	VIOLA	1
----	---	-------	---

43	0	CELLO	1
----	---	-------	---

44	0	CONTRABASS	1
----	---	------------	---

45	0	TREMOLO STR	1
----	---	-------------	---

46	0	PIZZICATOSTR	1
----	---	--------------	---

47	0	HARP	1
----	---	------	---

48	0	TIMPANI	1
----	---	---------	---

STRINGS

49	0	STRINGS	1
	8	ORCHESTRA	2

50	0	SLOW STRINGS	1
----	---	--------------	---

51	0	SYN.STRINGS1	1
	8	SYN.STRINGS3	2
	64	SYN.STRINGS4	2
	65	OB STRINGS	2

52	0	SYN.STRINGS2	2
----	---	--------------	---

53	0	CHOIR AAHS	1
	32	CHOIR AAHS 2	1

54	0	VOICE OOHS	1
----	---	------------	---

55	0	SYNVOX	1
----	---	--------	---

56	0	ORCHESTRAHIT	2
----	---	--------------	---

BRASS

57	0	TRUMPET	1
----	---	---------	---

58	0	TROMBONE	1
	1	TROMBONE 2	2

59	0	TUBA	1
----	---	------	---

60	0	MUTEDTRUMPET	1
----	---	--------------	---

61	0	FRENCH HORN	2
	1	FR.HORN 2	2

62	0	BRASS 1	1
	8	BRASS 2	2

SYN. BRASS

63	0	SYNTH BRASS1	2
	8	SYNTH BRASS3	2
	16	ANALOGBRASS1	2
	64	SYNTH BRASS5	2
	65	POLY BRASS	2
	66	QUACK BRASS	2
	67	OCTAVE BRASS	2
64	0	SYNTH BRASS2	2
	8	SYNTH BRASS4	1
	16	ANALOGBRASS2	2
	64	SOFT BRASS	2
	65	VELO BRASS 1	2
	66	VELO BRASS 2	2

REED

65	0	SOPRANO SAX	1
66	0	ALTO SAX	1
67	0	TENOR SAX	1
68	0	BARITONE SAX	1
69	0	OBOE	1
70	0	ENGLISH HORN	1
71	0	BASSOON	1
72	0	CLARINET	1

PIPE

73	0	PICCOLO	1
74	0	FLUTE	1
75	0	RECORDER	1
76	0	PAN FLUTE	1
77	0	BOTTLE BLOW	2
78	0	SHAKUHACHI	2
79	0	WHISTLE	1
80	0	OCARINA	1

SYN. LEAD

81	0	SQUARE WAVE	2
	1	SQUARE	1
	8	SINE WAVE	1
82	0	SAW WAVE	2
	1	SAW	1
	8	DOCTOR SOLO	2
	64	BIG LEAD	2
	65	WASPY SYNTH	2
83	0	SYN.CALLIOPE	2
84	0	CHIFFER LEAD	2
85	0	CHARANG	2
	64	DIST. LEAD 1	2
	65	DIST. LEAD 2	2
	66	FUNK LEAD	2
86	0	SOLO VOX	2
87	0	5TH SAW WAVE	2
	64	BIG FIVES	2
88	0	BASS & LEAD	2

64	BIG & RAW	2
65	FAT & PERKY	2

SYN. PAD

89	0	FANTASIA	2
90	0	WARM PAD	1
	64	THICK PAD	2
	65	HORN PAD	2
91	0	POLYSYNTH	2
	64	80'S POLYSYN	2
92	0	SPACE VOICE	1
93	0	BOWED GLASS	2
94	0	METAL PAD	2
	64	PANNER PAD	2
95	0	HALO PAD	2
96	0	SWEEP PAD	1
	64	POLAR PAD	1
	65	CONVERGE	1

SYN. SFX

97	0	ICE RAIN	2
98	0	SOUNDTRACK	2
	64	ANCESTRAL	2
	65	PROLOGUE	2
99	0	CRYSTAL	2
	1	SYN MALLET	1
100	0	ATMOSPHERE	2
101	0	BRIGHTNESS	2
102	0	GOBLIN	2
103	0	ECHO DROPS	1
	1	ECHO BELL	2
	2	ECHO PAN	2
	64	ECHO PAN 2	2
	65	BIG PANNER	2
	66	RESO PANNER	2
104	0	STAR THEME	2

ETHNIC MISC

105	0	SITAR	1
	1	SITAR 2	2
106	0	BANJO	1
107	0	SHAMISEN	1
108	0	KOTO	1
	8	TAISHO KOTO	2
109	0	KALIMBA	1
110	0	BAGPIPE	1
111	0	FIDDLE	1
112	0	SHANAI	1

PERCUSSIVE

113	0	TINKLE BELL	1
114	0	AGOGO	1
115	0	STEEL DRUMS	1

116	0	WOODBLOCK	1
	8	CASTANETS	1

117	0	TAIKO	1
	8	CONCERT BD	1

118	0	MELO. TOM 1	1
	8	MELO. TOM 2	1

119	0	SYNTH DRUM	1
	8	808 TOM	1
	9	ELEC PERC.	1

120	0	REVERSE CYM.	1
-----	---	--------------	---

GUITAR BASS FX

121	0	GT.FRETNOISE	1
	1	GT.CUT NOISE	1
	64	WAH BRUSH GT	1
	65	GT. SLIDE	1
	66	GT. SCRATCH	1
	67	BASS SLIDE	1

SFX

122	0	BREATH NOISE	1
	1	FL.KEY CLICK	1

123	0	SEASHORE	1
	1	RAIN	1
	2	THUNDER	1
	3	WIND	1
	5	BUBBLE	2

124	0	BIRD	2
	1	DOG	1
	3	BIRD 2	1

125	0	TELEPHONE 1	1
	1	TELEPHONE 2	1
	3	DOOR	1
	5	WIND CHIMES	2

126	0	HELICOPTER	1
	2	CAR-STOP	1
	9	BURST NOISE	2
	64	SPACE TRI.	1

127	0	APPLAUSE	2
	3	PUNCH	1

128	0	GUN SHOT	1
	2	LASERGUN	1
	3	EXPLOSION	2

PC: Program number
(Instrument number)

CC0: Value of control
change number 0

VOICES: Number of voices used

* To switch instruments from the external MIDI device, send "0" on the CC32# (Control Change Bank Select) from the external MIDI device to the TD-20.

* The value of the CC32# (Control Change Bank Select) that the TD-20 transmits is always "0."

MIDI Implementation Chart

Function...		Transmitted	Recognized	Remarks
Basic Channel	Default Changed	1-16, OFF 1-16, OFF	1-16, OFF 1-16, OFF	Memorized
Mode	Default Messages Altered	Mode 3 X *****	Mode 3 X *****	
Note Number :	True Voice	0-127 *****	0-127 0-127	
Velocity	Note On Note Off	O 9nH, v = 1-127 O 8nH, v = 64	O O *4	
After Touch	Key's Channel's	O *3 X	O *3 X	
Pitch Bend		X	O *4	
Control Change	0, 32	O	O *4	Bank Select
	1	O (Pad, Pedal) *1 *2 *3	O *1 *2 *3	Modulation
	2	O (Pad, Pedal) *1 *2 *3	O *1 *2 *3	Breath Controller
	4	O (Pad, Pedal) *1 *2 *3	O *1 *2 *3	Foot Controller
	6, 38	X	O *4	Data Entry
	7	X	O	Volume
	10	X	O *4	Panpot
	11	O (Pad, Pedal) *1 *2 *3	O *1 *2 *3	Expression
	16-19	O (Pad, Pedal) *1 *2 *3	O *1 *2 *3	General Purpose Controller 1-4
	64	X	O *4	Hold 1
	91	X	O *4	Effects 1 (Reverb Send Level)
93	X	O *4	Effects 3 (Chorus Send Level)	
100, 101	X	O *4	RPN LSB, MSB	
Program Change :	True Number	O 0-127 *5 *****	O 0-127 *5 0-127	Program No. 1-128
System Exclusive		O	O	
System Common :	Song Position Song Select Tune Request	X X X	X X X	
System Real Time :	Clock Commands	X X	O X	
Aux Messages :	All Sound Off Reset All Controllers Local On/Off All Notes Off Active Sensing System Reset	X X X X O X	O (120, 126, 127) O X O (123-127) O X	
Notes		*1 One is selected as the strike position. *4 Backing part only. *2 One is selected as the hi-hat control pedal. *5 O X is selectable. *3 Drum part only.		

Mode 1 : OMNI ON, POLY
Mode 3 : OMNI OFF, POLY

Mode 2 : OMNI ON, MONO
Mode 4 : OMNI OFF, MONO

O : Yes
X : No

MIDI Implementation Chart

Function...		Transmitted	Recognized	Remarks
Basic Channel	Default Changed	1-16, OFF 1-16, OFF	1-16, OFF 1-16, OFF	Memorized
Mode	Default Messages Altered	Mode 3 X *****	Mode 3 X *****	
Note Number :	True Voice	0-127 *****	0-127 0-127	
Velocity	Note On Note Off	O 9nH, v = 1-127 O 8nH, v = 64	O O	
After Touch	Key's Channel's	O *3 X	O *3 X	
Pitch Bend		O *4	O *4	
Control Change	0, 32	O *6 *7	X	Bank Select
	1	O *1 *2 *3	O	*1 *2 *3 Modulation
	2	O *1 *2 *3	O	*1 *2 *3 Breath Controller
	4	O *1 *2 *3	O	*1 *2 *3 Foot Controller
	6, 38	O *4 *6 *7	X	Data Entry
	7	O *6 *7 *10	X	Volume
	10	O *4 *6 *7	X	Panpot
	11	O *1 *2 *3	O	*1 *2 *3 Expression
	16-19	O *1 *2 *3	O	*1 *2 *3 General Purpose Controller 1-4
	64	O *4	O	*4 Hold 1
	91	O *4 *6 *7	X	Effects 1 (Reverb Send Level)
93	O *4 *6 *7	X	Effects 3 (Chorus Send Level)	
100, 101	O *4 *6 *7	X	RPN LSB, MSB	
Program Change	: True Number	O 0-127 *5 *6 *7 *****	X	Program No. 1-128
System Exclusive		O	O	Only reception/transmission of Bulk Data.
System Common	: Song Position : Song Select : Tune Request	X X X	X X X	
System Real Time	: Clock : Commands	O O	O *8 O *9	
Aux Messages	: All Sound Off : Reset All Controllers : Local On/Off : All Notes Off : Active Sensing : System Reset	X X X X X X	O O X O (123-127) X X	
Notes		*1 One is selected as the strike position. *2 One is selected as the hi-hat control pedal. *3 Drum part only. *4 Backing part only. *5 O X is selectable. *6 Transmits when pattern is selected.		*7 Transmits when modified. *8 Receives when Sync Mode setting is "EXTERNAL" or "AUTO." *9 Receives when Sync Mode setting is "EXTERNAL," "AUTO," or "REMOTE." *10 Except drum part.

Mode 1 : OMNI ON, POLY
Mode 3 : OMNI OFF, POLY

Mode 2 : OMNI ON, MONO
Mode 4 : OMNI OFF, MONO

O : Yes
X : No

Specifications

TD-20: Percussion Sound Module

Sound Generator

Variable Drum Modeling

Maximum Polyphony

64 Voices

Instruments

Drum Instruments: 560

Backing Instruments: 262

Drum Kits

50

Drum Kit Chains

16 chains (32 steps per chain)

Instrument Parameters

V-EDIT (KICK):

Shell Depth, Beater Type, Head Type, Head Tuning, Muffling, Snare Buzz, Mic Position

V-EDIT (SNARE):

Shell Material, Shell Depth, Head Type, Head Tuning, Muffling, Strainer Adjustment, Mic Position

V-EDIT (TOM):

Shell Depth, Head Type, Head Tuning, Muffling, Snare Buzz, Mic Position

V-EDIT (HI-HAT):

Cymbal Size, Add Tambourine, Mic Position, Fixed Hi-Hat

V-EDIT (CYMBAL):

Cymbal Size, Sizzle Type, Sustain, Mic Position

EDIT:

Pitch, Decay

Ambience Parameters

Room Type, Room Size, Wall Type, Mic Position, Room Shape

Mixer Parameters

Volume, Pan, Minimum Volume, Output Assign

Effect Types

Pad Equalizer (each pad)

Pad Compressor (each pad)

Multi-Effects: 14 types

Master Compressor

Master Equalizer

Reverb (for backing part)

Chorus (for backing part)

Percussion Sets

8

Sequencer

User Patterns: 100

Preset Patterns: 100

Parts: 6

Play Type: Oneshot, Loop, Tap

Tempo: 20–260

Resolution: 192 ticks per quarter note

Recording Method: Realtime

Maximum Note Storage: approx. 20,000 Notes

Click Instruments: 20

Display

64 x 240 dots (backlit graphic LCD)

7 segments, 3 characters (LED)

Trigger Level Indicator (LED)

Faders

8

Preview Button

Connectors

Trigger Input Jack x 15
 Hi-Hat Control Jack (VH-12, FD-7, FD-8)
 Master Output Jacks (L/MONO, R)
 Direct Output Jack x 8
 Digital Output Jack (COAXIAL)
 Headphones Jack (Stereo 1/4 inch phone type)
 Mix in Jack (Stereo 1/4 inch phone type)
 MIDI Connectors (IN, OUT/THRU)
 Foot Switch Jack (1/4 inch TRS phone type)
 CompactFlash Card Slot
 AC Inlet

Output Impedance

1.0 k ohms

Power Supply

AC 117 V, AC 230 V, AC 240 V (50/60 Hz)
 AC 220 V (60 Hz)

Power Consumption

16 W

Dimensions

307 (W) x 256 (D) x 105 (H) mm
 12-1/8 (W) x 10-1/8 (D) x 4-3/16 (H) inches

Weight

2.9 kg / 6 lbs 7 oz

Accessories

Owner's Manual
 Power Cord

Options

Pads (PD-7, PD-8, PD-9, PD-80, PD-80R, PD-105BK,
 PD-125BK)
 Cymbals (CY-8, CY-12H, CY-12R/C, CY-14C, CY-15R)
 Kick Triggers (KD-7, KD-8, KD-80, KD-120BK)
 Hi-Hat (VH-12)
 Hi-Hat Control Pedal (FD-8)
 Stands (MDS-20)
 Cymbal Mount (MDY-10U)
 Pad Mount (MDH-10U)

** A separate publication titled "MIDI Implementation" is also available. It provides complete details concerning the way MIDI has been implemented on this unit. If you should require this publication (such as when you intend to carry out byte-level programming), please contact the nearest Roland Service Center or authorized Roland distributor.*

** In the interest of product improvement, the specifications and/or appearance of this unit are subject to change without prior notice.*

Drums

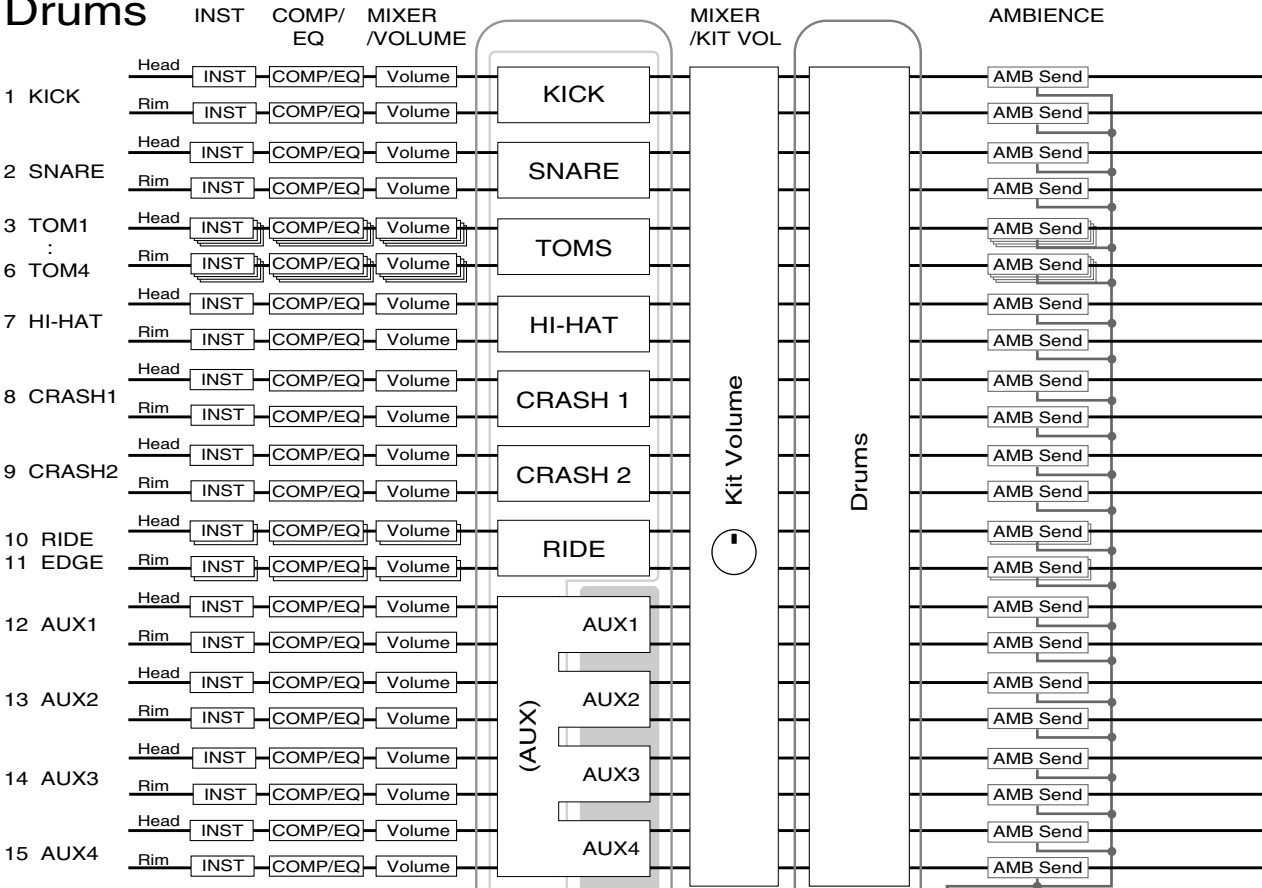

Percussion Set

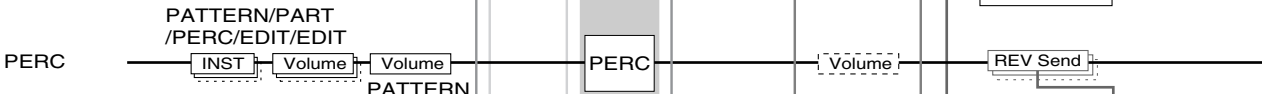

Backing Part

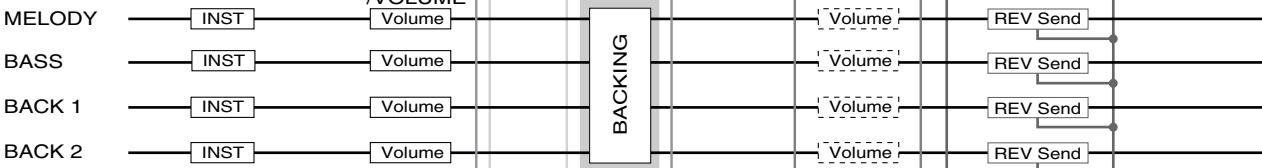

Click

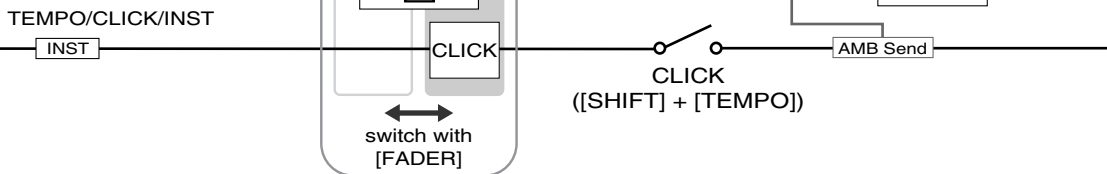

TD-20 Block Diagram

Index

Symbols

+/- 14, 23

Numerics

3-WAY 48

A

Acoustic Drum Kit 32
Add Tambourine 33
ADVANCE 48
AMB SEND LEVEL 37
Amb Send Level 60
APPEND 65

B

Backing Instrument 98
Backing Part 57
BANK 44
BASIC 45
Beater Type 33
Bell Shot 27
Bend Range 54
Block Diagram 104
Bow Shot 26–27
BR MIDI 36
BRUSH 29
Brush 36
Brush Note No. 36
Brush Switch 29
BULK 77
Bulk Dump 77

C

CARD 14, 67, 70, 84
Card 16
CC Max 46
CC Resolution 46
CHAIN 13, 82–83
Channel 74
CHAR 30, 59, 71, 83
CHINA 34
Choke 27
CHORUS 57
Click 25, 59–60, 78
Click Instruments 60
COMP 80
CompactFlash 16, 70

Connection 18–19, 84
CONTROL 35, 79
COPY 13, 64, 69
COUNT 60
Count In Play 60
Count In Rec 60
CRASH 34
Cross Stick 26, 30, 36
crosstalk 47
CTRL 76
CURSOR 14
Cursor 23
Curve 45
CY-15R/14C 27
Cymbal 27, 34

D

Decay Time 34
DELETE 30, 59, 66, 68, 71–72, 82–83
Demo Song 22
Depth 57
Device ID 75
DIGITAL OUT 15
DIRECT OUT 15
Display 13
Display Contrast 25, 81
Drum Instrument 92
DRUM KIT 14
Drum Kit 28, 30
Drum Kit Chain 82–83
During Play 60
During Rec 60
Dynamics 80

E

Edge Shot 26–27
EDIT 32, 56, 64
Edit 32
EDIT LOCK 31
Effect 57
EQ 80
ERASE 65
Error Message 90
EXCHNG 69
EXIT 14
Expansion Board 86

F

F RESET	81
Factory Reset	81
FADER	24, 37
FIXED	33
Fixed Hi-Hat	33
Foot Splash Sens	46
FOOT SW	79
FOOT SWITCH	15
Foot Switch	79
FORMAT	72
FUNC	29
Function Button	23

G

Gate	36
Gate Time	36
GLOBAL	74
GROUP FADERS	14, 24, 37

H

H & R	31, 37–38, 40
HEAD	33
Head Shot	26
Head Tuning	33
Head Type	33
Headphones	19
HH MIDI	36
HH Note# Border	76
HI-HAT	33
Hi-Hat	21, 26, 35–36, 46
Hi-Hat Type	46
Hit Pad Start	63

I

INFO	73, 84
INSERT	30, 59, 71, 82–83
INST	31
Inst	54, 60
Instrument	
Drum	31
Instrument Name	32, 55
Instrument Number	55
Interval	60

K

Key Shift	54
KICK	33
KIT	14, 28
Kit Parameters	29

Kit Tempo	29
KIT VOL	37
Kit Volume	29, 37

L

LCD	81
LED Display	13
LIST	28, 32, 56
LOAD	68, 71
Local Control	75
LOCK	31
LOOP	58, 63

M

Mask Time	49
MASTER	14
Master Effect	80
MASTER OUT	15
Master Tuning	55
Material	33
MEMORY	84
Memory Card	67–68, 70–73
Mesh Head	21
Message	91
Metronome	25, 59
MFx SEND LEVEL	37
MIC	33
Mic Position	33
MIDI	36, 74, 100
MIDI CH	74
MIDI Channel	62
MIDI IN	15
MIDI OUT/THRU	15
MIN VOL	37
Minimum Volume	37
MIX EDIT	37
MIX IN	14–15, 19, 78
MIXER	37, 57
MONITOR	29, 84
MOUNT TYPE	47
MUFFLE	33
Muffling	33

N

NAME	30, 56, 59, 71, 82–83
Noise Cancel	46
Note No.	36
Note Number	36, 96

O

Offset	21, 46
--------------	--------

ONESHOT 58
 Open Rim Shot 26
 OPTION 80
 Other Instruments 34
 OUTPUT 78
 Output 60
 Output Destination 78
 Output Level 29, 84

P

Pad 18, 21, 26
 Pad Pattern 35
 Pad Ptn Velocity 35
 PAD SW 80
 Pad Type 44
 Pan 37, 60
 PART 54
 Part 57
 PART CHORUS SEND LEVEL 57
 PART PAN 57
 PART REVERB SEND LEVEL 57
 PART VOLUME 57
 Pattern 25, 52, 64
 PATTERN EDIT 64
 Pattern Length 58, 62
 PD-125/105 21, 26
 PDLBEND 35
 Pedal 18
 Pedal Bend Range 35
 Pedal CC 76
 Pedal HH Volume 29, 37
 PERC 55
 Percussion Instrument 55–56
 Percussion Part 55
 Percussion Set 55–56
 PHONES 14, 16
 Pitch 34
 Play Type 58
 Playback Method 58
 Playing Method 26
 Position Ctrl 36
 Positional Sensing 27
 POWER 15
 Power 20
 Preset Drum Kit 25
 Preset Pattern 51
 Pressure 26
 PREVIEW 14, 24, 55
 PROG 76
 Program Change 76

Q

Quantize 63
 Quick Play 58

R

Rate 57
 Realtime Recording 61
 REC 61
 Rec Mode 63
 Recording 61–63
 Recording Method 63
 Rehearsal 63
 REPLACE 63
 Retrig Cancel 48
 Retrigger Cancel 48
 REV/CHO 57
 REVERB 57
 RIDE 34
 Ride CC 76
 RIM 24, 48
 Rim Gain 49
 Rim Shot 26
 RimShot Adjust 49

S

SAVE 67, 70
 SCAN 48
 Scan Time 48
 Sensitivity 45
 SEQUENCER 14
 Sequencer 51, 61
 SETUP 14, 58, 74
 Shallow Rim Shot 26
 SHELL 33
 Shell Depth 33
 SHIFT 14
 Size 33–34
 Sizzle Type 34
 SNARE 33
 Snare Buzz 33
 Snare CC 76
 Soft Thru 74
 SPACE 30, 59, 71, 83
 SPLASH 34
 Stand 17
 stand holder 17
 step 82
 Strainer Adj. 33
 Sustain 34
 Sync Mode 53

T

TAMB	33
TAP	58–59
Tap Ptn Mute Grp	35
Tap Reset Time	58–59
TEMPO	29
Tempo	25, 53, 58, 62
Tension	21
Threshold	45
Time	57
Time Signature	58, 60, 62
TIMESIG	60
TOM	33
Toms CC	76
TOOLS	13, 84
TRIG SELECT	14, 24
TRIGGER	14, 44
Trigger Bank	44
TRIGGER INPUT	15
Trigger Level Indicator	13
Trigger Select	31
Trigger Type	44
Tuning	55
Tx Channel	36
Tx/Rx	74

U

User Pattern	51
--------------------	----

V

VALUE	14, 23
Variation	55
V-EDIT	32
Velocity	80
Velocity Curve	45
VERSION	84
VH-11	46
VH-12	21, 26, 46
V-LINK	58–59, 84–85
V-LINK Device ID	75
V-LINK MIDI Ch	75
VOLUME	29
Volume	37

X

XSTICK	30
XStick Note No.	36
XStick Thrshld	49
XStick Volume	29, 37
XTALK	47

XTALK CANCEL	47
XTALK GROUP	47

Preset Drum Kit List

No.	Name	No.	Name	No.	Name	No.	Name	No.	Name
1	VPro	11	Spark!	21	Sploink!	31	WetBooth *1	41	TR-909
2	Slamin' *1	12	>>GT>>	22	Boogaloo	32	70s Record	42	Hex< >Drum *1
3	METAL	13	Antique	23	Zeppy	33	Lite	43	Cosmosis
4	JazzCombo	14	=BreakBeats=	24	Arena	34	Mellow	44	Technology
5	OverDrive	15	Studio	25	Maple	35	Stadium	45	OrchPerc *1
6	Titanium	16	Groover *1	26	Shallow	36	TiteOctas	46	Survivor
7	RotoKit *1	17	Mallet	27	Ballad *1	37	90s Power	47	Latin Toys
8	UNIVERSE	18	Drumline	28	Raspy	38	FxJungle *1	48	African Perc
9	Skanky	19	JazzGig *1	29	PopReggae *1	39	Tekno	49	Tabla/Sitar *1
10	Brushes *2	20	Airtime	30	BrassBiggie	40	TR-808 *1	50	UserKit *3

*1: A Pattern is assigned to CRASH 2. (Pad Pattern; p. 35)

*2: Brushes can be used.

*3: Parameters including volume etc. are set to standard values. Use this when creating a kit from scratch.

Preset Pattern List

No.	Name	T.S	Len	Tempo	No.	Name	T.S	Len	Tempo	No.	Name	T.S	Len	Tempo
1	Drums POP	4/4	10	120	39	Funky Alley	4/4	8	90	77	Shufflin'A8	4/4	8	140
2	Drums JAZZ	4/4	13	180	40	Old Soul	4/4	8	114	78	Shufflin'B10	4/4	10	140
3	Drums BALLAD	12/8	9	100	41	Brown Funk	4/4	18	132	79	4 & 7 A 2bar	15/8	2	115
4	Drums H.ROCK	4/4	9	152	42	Thick Funk	4/4	12	102	80	4 & 7 B 2bar	15/8	2	115
5	Rockin' Hard	4/4	18	95	43	Up Shuffle	4/4	26	130	81	Samba	4/4	1	120
6	Night Groove	4/4	4	88	44	R&B Shuffle	4/4	16	112	82	Sitar Rag	4/4	17	100
7	Fast Track	4/4	4	105	45	Shuffle Grv	4/4	17	96	83	Aco Bass	4/4	4	160
8	Water Fall	4/4	4	80	46	R&B Groove	4/4	12	80	84	BrassSection	4/4	5	160
9	Smooth Sail	4/4	4	89	47	Smooth Grv	4/4	19	73	85	Jazz End	4/4	6	60
10	Bug Juice	4/4	4	74	48	Slow Fusion	4/4	15	85	86	OrchString1	4/4	8	128
11	Strunk	4/4	4	82	49	Country Blld	4/4	8	102	87	OrchString2	4/4	8	128
12	Faced	4/4	4	67	50	6/8 Ballad	6/8	21	50	88	OrchString3	4/4	8	128
13	4 & 7	15/8	4	115	51	Slow	4/4	4	69	89	StrChord	4/4	8	150
14	Swing A	4/4	16	212	52	Reggae	4/4	8	122	90	DiscoTapBass	4/4	1	120
15	Swing B	4/4	8	212	53	Rastamon	4/4	4	86	91	TrashBass	4/4	1	120
16	Latin 4 bars	4/4	4	130	54	Salsa 1	4/4	17	115	92	Applause	4/4	4	120
17	Latin 8 bars	4/4	8	130	55	Salsa 2	4/4	20	102	93	Sweep Pad 1	4/4	8	80
18	Rockin'	4/4	16	100	56	Songo	4/4	16	109	94	Sweep Pad 2	4/4	8	80
19	Rollin'	4/4	24	128	57	Latin Jazz	4/4	26	167	95	Grv Bass	4/4	2	120
20	Shufflin'	4/4	26	140	58	Afro Jazz	4/4	22	194	96	Strings	4/4	8	128
21	Minoplis	4/4	4	118	59	Smooth Jazz	4/4	20	183	97	Pad&Bass	4/4	8	80
22	Grr-unge	4/4	4	111	60	Modern Jazz	4/4	28	136	98	Synchord1	4/4	3	120
23	Rockmay	4/4	8	100	61	Blues12bar A	4/4	12	55	99	7 Notes	4/4	7	128
24	Shoot!	4/4	4	89	62	Blues12bar B	4/4	12	55	100	12 Notes	4/4	12	128
25	Jammin'	4/4	8	113	63	Surfpunk	4/4	4	130					
26	Clap Happy	4/4	8	104	64	Rockabilly	4/4	24	192					
27	Happy R&B	4/4	8	104	65	Funk Hop	4/4	4	102					
28	Holiday	4/4	8	111	66	Funk 5/4A	5/4	2	86					
29	Cruisin'	4/4	4	110	67	Funk 4/4B	4/4	4	86					
30	Festival	6/4	4	164	68	King Strut	4/4	4	84					
31	Let's Roll	4/4	8	148	69	Krunkn'	4/4	4	94					
32	Woa	4/4	8	114	70	Start & Stop	4/4	4	112					
33	Pop X	4/4	8	124	71	Prowl	4/4	4	80					
34	Purploq	4/4	4	112	72	Guttn'	4/4	4	68					
35	Pop'n Love	4/4	4	140	73	Ambient	4/4	8	96					
36	In the House	4/4	4	100	74	Rockin'A8bar	4/4	8	100					
37	Smoove	4/4	2	94	75	Rockin'B8bar	4/4	8	100					
38	Shuffle Bop	4/4	4	92	76	Shufflin'Itr	4/4	8	140					

T.S: Time Signature

Len: Pattern Length

Play Type: 1-80: LOOP

81-98: TAP

99, 100: V-LINK

(See p. 58.)

For EU Countries

Apparatus containing Lithium batteries

ADVARSEL!

Lithiumbatteri - Eksplosionsfare ved fejlagtig håndtering.
Udskiftning må kun ske med batteri af samme fabrikat og type.
Levér det brugte batteri tilbage til leverandøren.

ADVARSEL

Eksplosjonsfare ved feilaktig skifte av batteri.
Benytt samme batteritype eller en tilsvarende type anbefalt av apparatfabrikanten.
Brukte batterier kasseres i henhold til fabrikantens instruksjoner.

CAUTION

Danger of explosion if battery is incorrectly replaced.
Replace only with the same or equivalent type recommended by the manufacturer.
Discard used batteries according to the manufacturer's instructions.

VARNING

Explosionsfara ved felaktigt batteribyte.
Använd samma batterityp eller en ekvivalent typ som rekommenderas av apparattillverkaren.
Kassera använt batteri enligt fabrikantens instruktion.

VAROITUS

Paristo voi räjähtää, jos se on virheellisesti asennettu.
Vaihda paristo ainoastaan laitevalmistajan suosittelemaan tyyppiin. Hävitä käytetty paristo valmistajan ohjeiden mukaisesti.

For EU Countries



This product complies with the requirements of European Directives EMC 89/336/EEC and LVD 73/23/EEC.

For the USA

FEDERAL COMMUNICATIONS COMMISSION RADIO FREQUENCY INTERFERENCE STATEMENT

This equipment has been tested and found to comply with the limits for a Class B digital device, pursuant to Part 15 of the FCC Rules. These limits are designed to provide reasonable protection against harmful interference in a residential installation. This equipment generates, uses, and can radiate radio frequency energy and, if not installed and used in accordance with the instructions, may cause harmful interference to radio communications. However, there is no guarantee that interference will not occur in a particular installation. If this equipment does cause harmful interference to radio or television reception, which can be determined by turning the equipment off and on, the user is encouraged to try to correct the interference by one or more of the following measures:

- Reorient or relocate the receiving antenna.
- Increase the separation between the equipment and receiver.
- Connect the equipment into an outlet on a circuit different from that to which the receiver is connected.
- Consult the dealer or an experienced radio/TV technician for help.

This device complies with Part 15 of the FCC Rules. Operation is subject to the following two conditions:

- (1) This device may not cause harmful interference, and
- (2) This device must accept any interference received, including interference that may cause undesired operation.

Unauthorized changes or modification to this system can void the users authority to operate this equipment.
This equipment requires shielded interface cables in order to meet FCC class B Limit.

For Canada

NOTICE

This Class B digital apparatus meets all requirements of the Canadian Interference-Causing Equipment Regulations.

AVIS

Cet appareil numérique de la classe B respecte toutes les exigences du Règlement sur le matériel brouilleur du Canada.

Information

When you need repair service, call your nearest Roland Service Center or authorized Roland distributor in your country as shown below.

AFRICA

EGYPT

Al Fany Trading Office
9, EBN Hagar A1 Askalany Street,
ARD El Golf, Heliopolis,
Cairo 11341, EGYPT
TEL: 20-2-417-1828

REUNION

Maison FO - YAM Marcel
25 Rue Jules Hermann,
Chaudron - BP79 97 491
Ste Clotilde Cedex,
REUNION ISLAND
TEL: (0262) 218-429

SOUTH AFRICA

That Other Music Shop(PTY)Ltd.
11 Melle St., Braamfontein,
Johannesburg,
SOUTH AFRICA
TEL: (011) 403 4105
FAX: (011) 403 1234

Paul Bothner(PTY)Ltd.
17 Werdmuller Centre,
Main Road, Claremont 7708
SOUTH AFRICA
TEL: (021) 674 4030

ASIA

CHINA

Roland Shanghai Electronics Co., Ltd.
5F, No.1500 Pingliang Road
Shanghai 200090, CHINA
TEL: (021) 5580-0800

Roland Shanghai Electronics Co., Ltd.
(BEIJING OFFICE)
10F, No.18 3 Section Anhuaxili
Chaoyang District Beijing
100011 CHINA
TEL: (010) 6426-5050

Roland Shanghai Electronics Co., Ltd.
(GUANGZHOU OFFICE)
2/F, No.30 Si You Nan Er Jie
Yi Xiang, Wu Yang Xin Cheng,
Guangzhou 510600, CHINA
TEL: (020) 8736-0428

HONG KONG

Tom Lee Music Co., Ltd.
Service Division
22-32 Pun Shan Street, Tsuen
Wan, New Territories,
HONG KONG
TEL: 2415 0911

Parsons Music Ltd.

8th Floor, Railway Plaza, 39
Chatham Road South, T.S.T,
Kowloon, HONG KONG
TEL: 2333 1863

INDIA

Rivera Digitec (India) Pvt. Ltd.
409, Nirman Kendra
Mahalaxmi Flats Compound
Off. Dr. Edwin Moses Road,
Mumbai-400011, INDIA
TEL: (022) 2493 9051

INDONESIA

PT Citra IntiRama
Jl. Cideng Timur No. 15J-150
Jakarta Pusat
INDONESIA
TEL: (021) 6324170

KOREA

Cosmos Corporation
1461-9, Seocho-Dong,
Seocho Ku, Seoul, KOREA
TEL: (02) 3486-8855

MALAYSIA

Roland Asia Pacific Sdn. Bhd.
45-1, Block C2, Jalan PJU 1/39,
Dataran Prima, 47301 Petaling
Jaya, Selangor, MALAYSIA
TEL: (03) 7805-3263

PHILIPPINES

G.A. Yupangco & Co. Inc.
339 Gil J. Puyat Avenue
Makati, Metro Manila 1200,
PHILIPPINES
TEL: (02) 899 9801

SINGAPORE

SWEET LEE MUSIC COMPANY PTE. LTD.
150 Sims Drive,
SINGAPORE 387381
TEL: 6846-3676

CRISTOFORI MUSIC PTE LTD
Blk 3014, Bedok Industrial Park E,
#02-2148, SINGAPORE 489980
TEL: 6243-9555

TAIWAN

ROLAND TAIWAN ENTERPRISE CO., LTD.
Room 5, 9fl. No. 112 Chung
Shan N.Road Sec.2, Taipei,
TAIWAN, R.O.C.
TEL: (02) 2561 3339

THAILAND

Thera Music Co., Ltd.
330 Verng NakomKasem, Soi 2,
Bangkok 10100, THAILAND
TEL: (02) 2248821

VIETNAM

Saigon Music Suite DP-8
40 Ba Huyen Thanh Quan Street
Hochiminh City, VIETNAM
TEL: (08) 930-1969

AUSTRALIA/NEW ZEALAND

AUSTRALIA/NEW ZEALAND

Roland Corporation Australia Pty., Ltd.
38 Campbell Avenue
Dee Why West. NSW 2099
AUSTRALIA

For Australia
TEL: (02) 9982 8266
For New Zealand
TEL: (09) 3098 715

CENTRAL/LATIN AMERICA

ARGENTINA

Instrumentos Musicales S.A.
Av.Santa Fe 2055
(1123) Buenos Aires
ARGENTINA
TEL: (011) 4508-2700

BARBADOS

A&B Music Supplies LTD
12 Webster Industrial Park
Wildely, St.Michael, Barbados
TEL: (246)430-1100

BRAZIL

Roland Brasil Ltda.
Rua San Jose, 780 Sala B
Parque Industrial San Jose
Cofia - Sao Paulo - SP, BRAZIL
TEL: (011) 4615 5666

CHILE

Comercial Fancy II S.A.
Rut.: 96.919.420-1
Natalien Cox #739, 4th Floor
Santiago - Centro, CHILE
TEL: (02) 688-9540

COLOMBIA

Centro Musical Ltda.
Cra 43 B No 25 A 41 Bododega 9
Medellin, Colombia
TEL: (574)3812529

COSTA RICA

JUAN Bansbach Instrumentos Musicales
Ave.1. Calle 11, Apartado 10237,
San Jose, COSTA RICA
TEL: 258-0211

CURACAO

Zeelandia Music Center Inc.
Orionweg 30
Curacao, Netherland Antilles
TEL:(305)5926866

DOMINICAN REPUBLIC

Instrumentos Fernando Giraldez
Calle Proyecto Central No.3
Ens.La Esperilla
Santo Domingo,
Dominican Republic
TEL:(809) 683 0305

ECUADOR

Mas Musica
Rumichaca 822 y Zaruma
Guayaquil - Ecuador
TEL:(593-4)2302364

EL SALVADOR

OMNI MUSIC
75 Avenida Norte y Final
Alameda Juan Pablo II,
Edificio No.4010 San Salvador,
EL SALVADOR
TEL: 262-0788

GUATEMALA

Casa Instrumental
Calzada Roosevelt 34-01, zona 11
Ciudad de Guatemala
Guatemala
TEL:(502) 599-2888

HONDURAS

Almacen Pajaro Azul S.A. de C.V.
BO.Paz Barahona
3 Ave.11 Calle S.O
San Pedro Sula, Honduras
TEL: (504) 553-2029

MARTINIQUE

Musique & Son
Z.I.Les Mangle
97232 Le Lamantin
Martinique F.W.I.
TEL: 596 596 426860

Gigamus SARL

10 Rte De La Folie
97200 Fort De France
Martinique F.W.I.
TEL: 596 596 715222

MEXICO

Casa Veerkamp, s.a. de c.v.
Av. Toluca No. 323, Col. Olivar
de los Padres 01780 Mexico
D.F. MEXICO
TEL: (55) 5668-6699

NICARAGUA

Bansbach Instrumentos Musicales Nicaragua
Altamira D'Este Calle Principal
de la Farmacia 5ta. Avenida
1 Cuadra al Lago.#503
Managua, Nicaragua
TEL: (505)277-2557

PANAMA

SUPRO MUNDIAL, S.A.
Boulevard Andrews, Albrook,
Panama City, REP. DE
PANAMA
TEL: 315-0101

PARAGUAY

Distribuidora De Instrumentos Musicales
J.E. Olear y ESQ. Manduvira
Asuncion PARAGUAY
TEL: (595) 21 492147

PERU

Audionet
Distribuciones Musicales SAC
Juan Fanning 530
Miraflores
Lima - Peru
TEL: (511) 4461388

TRINIDAD

AMR Ltd
Ground Floor
Maritime Plaza
Barataria Trinidad W.I.
TEL: (868)638 6385

URUGUAY

Todo Musica S.A.
Francisco Acuna de Figueroa
1771
C.P.: 11.800
Montevideo, URUGUAY
TEL: (02) 924-2335

VENEZUELA

Instrumentos Musicales Allegro,C.A.
Av.las industrias edf.Guitar
import
#7 zona Industrial de Turumo
Caracas, Venezuela
TEL: (212) 244-1122

EUROPE

AUSTRIA

Roland Elektronische Musikinstrumente HmbH.
Austrian Office
Eduard-Bodem-Gasse 8,
A-6020 Innsbruck, AUSTRIA
TEL: (0512) 26 44 260

BELGIUM/FRANCE/HOLLAND/LUXEMBOURG

Roland Central Europe N.V.
Houtstraat 3, B-2260, Oevel
(Westerlo) BELGIUM
TEL: (014) 575811

CZECH REP.

K-AUDIO
Kardasovska 626,
CZ-198 00 Praha 9,
CZECH REP.
TEL: (2) 666 10529

DENMARK

Roland Scandinavia A/S
Nordhavnsvej 7, Postbox 880,
DK-2100 Copenhagen
DENMARK
TEL: 3916 6200

FINLAND

Roland Scandinavia As, Filial
Finland
Elannontie 5
FIN-01510 Vantaa, FINLAND
TEL: (09) 68 24 020

GERMANY

Roland Elektronische Musikinstrumente HmbH.
Oststrasse 96, 22844
Norderstedt, GERMANY
TEL: (040) 52 60090

GREECE

STOLLAS S.A.
Music Sound Light
155, New National Road
Patras 26442, GREECE
TEL: 2610 435400

HUNGARY

Roland East Europe Ltd.
Warehouse Area 'DEPO' Pf.83
H-2046 Torokbalint,
HUNGARY
TEL: (23) 511011

IRELAND

Roland Ireland
G2 Calmout Park, Calmout
Avenue, Dublin 12
Republic of IRELAND
TEL: (01) 4294444

ITALY

Roland Italy S. p. a.
Viale delle Industrie 8,
20020 Arese, Milano, ITALY
TEL: (02) 937-78300

NORWAY

Roland Scandinavia Adv.
Kontor Norge
Lilleakerveien 2 Postboks 95
Lilleaker N-0216 Oslo
NORWAY
TEL: 2273 0074

POLAND

MX MUSIC SP.Z.O.O.
UL. Gibraltarska 4,
PL-03664 Warszawa POLAND
TEL: (022) 679 44 19

PORTUGAL

Roland Iberia, S.L.
Portugal Office
Cais das Pedras, 8/9-1 Dto
4050-465, Porto, PORTUGAL
TEL: 22 608 00 60

ROMANIA

FBS LINES
Piata Libertatii 1,
535500 Gheorgheni,
ROMANIA
TEL: (266) 364 609

RUSSIA

MuTek
3-Bogatyrskaya Str. 1.k.1
107 564 Moscow, RUSSIA
TEL: (095) 169 5043

SPAIN

Roland Iberia, S.L.
Paseo Garcia Faria, 33-35
08005 Barcelona SPAIN
TEL: 93 493 91 00

SWEDEN

Roland Scandinavia A/S
SWEDISH SALES OFFICE
Danvik Center 28, 2 tr.
S-131 30 Nacka SWEDEN
TEL: (08) 702 00 20

SWITZERLAND

Roland (Switzerland) AG
Landstrasse 5, Postfach,
CH-4452 Itingen,
SWITZERLAND
TEL: (061) 927-8383

UKRAINE

TIC-TAC
Mira Str. 19/108
P.O. Box 180
295400 Munkachevo,
UKRAINE
TEL: (03131) 414-40

UNITED KINGDOM

Roland (U.K.) Ltd.
Atlantic Close, Swansea
Enterprise Park, SWANSEA
SA7 9FJ,
UNITED KINGDOM
TEL: (01792) 702701

MIDDLE EAST

BAHRAIN

Moon Stores
No.16, Bab Al Bahrain Avenue,
P.O.Box 247, Manama 304,
State of BAHRAIN
TEL: 17 211 005

CYPRUS

Radex Sound Equipment Ltd.
17, Diagorou Street, Nicosia,
CYPRUS
TEL: (022) 66-9426

IRAN

MOCO INC.
No.41 Nike St., Dr.Shariyati Ave.,
Roberoye Cerahe Mirdamad
Teheran, IRAN
TEL: (021) 285-4169

ISRAEL

Halilit P. Greenspoon & Sons Ltd.
8 Retziv Ha'aliya Hashnya St.
Tel-Aviv-Yafo ISRAEL
TEL: (03) 6823666

JORDAN

AMMAN Trading Agency
245 Prince Mohammad St.,
Amman 1118, JORDAN
TEL: (06) 464-1200

KUWAIT

EASA HUSAIN AL-YOUSIFI & SONS CO.
Abdullah Salem Street,
Safat, KUWAIT
TEL: 243-6399

LEBANON

Chahine S.A.L.
Gerge Zeidan St., Chahine
Bldg., Achrafieh, P.O.Box: 16-
5857
Beirut, LEBANON
TEL: (01) 20-1441

OMAN

TALENTZ CENTRE L.L.C.
P.O. BOX 37, MUSCAT,
POSTAL CODE 113
TEL: 931-3705

QATAR

Al Emadi Co. (Badie Studio & Stores)
P.O. Box 62, Doha, QATAR
TEL: 4423-554

SAUDI ARABIA

aDawlah Universal Electronics APL
Corniche Road, Aldossary
Bldg., 1st Floor, Alkhobar,
SAUDI ARABIA

P.O.Box 2154, Alkhobar 31952
SAUDI ARABIA
TEL: (03) 898 2081

SYRIA

Technical Light & Sound Center
Rawda, Abdul Qader Jazari St.
Bldg. No. 21, P.O.BOX 13520,
Damascus, SYRIA
TEL: (011) 223-5384

TURKEY

Ant Muzik Aletleri Ithalat Ve Ihracat Ltd Sti
Siraselviler Caddesi
Siraselviler Pasaji No:74/20
Taksim - Istanbul, TURKEY
TEL: (0212) 2449624

U.A.E.

Zak Electronics & Musical Instruments Co. L.L.C.
Zabeel Road, Al Sherooq Bldg.,
No. 14, Grand Floor, Dubai,
U.A.E.
TEL: (04) 3360715

NORTH AMERICA

CANADA

Roland Canada Music Ltd.
(Head Office)
5480 Brockwood Way
Richmond B.C., V6V 2M4
CANADA
TEL: (604) 270 6626

Roland Canada Music Ltd.

(Toronto Office)
170 Admiral Boulevard
Mississauga On L5T 2N6
CANADA
TEL: (905) 362 9707

U. S. A.

Roland Corporation U.S.
5100 S. Eastern Avenue
Los Angeles, CA 90040-2938,
U. S. A.
TEL: (323) 890 3700

As of January 15, 2005 (ROLAND)