



# C110 Dual Band 802.11ac Wall Plate Cable Modem Access Point

## Quick Setup Guide

This Quick Setup Guide provides step-by-step instructions on how to set up your Ruckus Wireless C110 Dual Band 802.11ac Wall Plate Cable Modem Access Point. After completing the steps described in this Guide, you will be able to access the C110 and begin providing wired and wireless network access to users.

The C110 has many options:

- Includes DOCSIS (or EuroDOCSIS) 3.0 cable modem
- It can be mounted on a standard USA- or EU-style single-gang wall outlet box.
- It has bottom cutouts for one or two bypass cables. The mounting bracket has locating hooks to keep the bypass cables aligned with the cutouts when attaching the C110 to the mounting base.
- It can have a low-power (0.5W or less) customer-supplied USB device plugged in.

**NOTE:** The C110 requires a minimum firmware revision of SmartZone 3.4 or later to operate.

### THIS GUIDE IN OTHER LANGUAGES

- 请从以下网站获得该指南的简体中文版 <https://support.ruckuswireless.com>
- Vous trouverez la version française de ce guide à l'adresse suivante <https://support.ruckuswireless.com>
- このガイドの日本語版は <https://support.ruckuswireless.com> をご覧ください
- 이 가이드의 한국어 버전은 웹 사이트 (<https://support.ruckuswireless.com>) 에서 확인하시기 바랍니다
- Veja a versão em português (Brasil) deste guia em <https://support.ruckuswireless.com>
- Puede ver la versión en español (América Latina) de esta guía en <https://support.ruckuswireless.com>

### BEFORE YOU BEGIN

Before deploying Ruckus Wireless products, please check for the latest software and the release documentation.

- User Guides and Release Notes are available at <http://support.ruckuswireless.com/documents>
- Software Upgrades are available at <http://support.ruckuswireless.com/software>
- Open Source information is available at <http://opensource.ruckuswireless.com>
- Software License and Limited Warranty are available at <http://support.ruckuswireless.com/warranty>

### About Peripheral Devices

The C110 can supply power to USB devices through its USB port on the bottom of the unit.

- The USB port is intended for low-power devices such as BLE (Bluetooth low energy) beacons. The maximum power that the USB port can supply is 0.5W.

### PACKAGE CONTENTS

- C110 Cable Modem Access Point
- AC/DC power supply
- Mounting bracket
- Two 10mm M3x0.5 thread Torx flat head machine screws
- Two 1" 6-32 thread Phillips pan head machine screws
- Two 4" long cable ties
- Product warranty statement
- Regulatory flyer
- Declaration of Conformity, if required
- This *Quick Setup Guide*

### CONFIGURING THE C110 (OPTIONAL)

**Note:** The C110 normally receives its latest AP and CM firmware and initial configuration settings from the cable modem termination system (CMTS) high speed data services equipment when it powers up; if this is the case, then skip the following steps and continue with [Step 6: Attaching the Mounting Bracket to an Outlet Box](#).

If the C110 does not receive its latest firmware and initial configuration settings from the CMTS equipment when the AP powers up, then continue with these procedures:

- [Step 1: Collecting Tools and Setup Requirements](#)
- [Step 2: Connecting the Computer to the C110](#)
- [Step 3: Preparing Your Computer for C110 Setup](#)
- [Step 4: Logging Into the C110 Access Point](#)
- [Step 5: Customizing the Wireless Settings](#)

### STEP 1: COLLECTING TOOLS AND SETUP REQUIREMENTS

- No. 2 Phillips screwdriver and T10 Torx driver for the mounting bracket screws
- A standard USA- or EU-style single-gang wall outlet box
- Coaxial cable for backhaul
- A computer with an Ethernet port, wireless card and a web browser
- Cat 5e or better Ethernet cable (for initial software configuration)

### STEP 2: CONNECTING THE COMPUTER TO THE C110

Figure 1: Front view

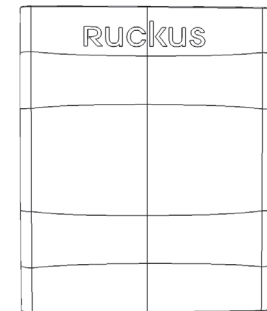

- 1 After removing your C110 from its package, place it next to your computer.
- 2 Using an Ethernet cable, connect your computer's network port to either of the Ethernet ports on the bottom of the C110.
- 3 Using an AC adapter (included), connect the C110 12VDC port to a protected power source.

Figure 2: Rear and bottom view

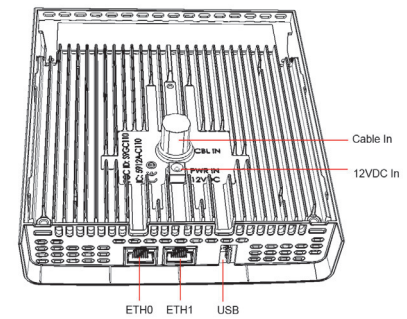

## STEP 3: PREPARING YOUR COMPUTER FOR C110 SETUP

**NOTE:** The following procedures assume Windows 7 as the operating system. Procedures for other OS's are similar.

- 1 On your Windows 7 computer, configure your network adapter from the *Local Area Connection* settings as follows:
  - Start > Control Panel > Network and Sharing Center > Change Adapter Settings
- 2 Edit the TCP/IPv4 address settings as follows:
  - Local Area Connection > Properties > Internet Protocol Version 4 (TCP/IPv4) > PropertiesThe *Internet Protocol Version 4 (TCP/IPv4) Properties* dialog box appears.

**IMPORTANT!** Write down all of the currently active settings so you can restore your computer to its current configuration later, when this process is complete.

- 3 Select Use the following IP address (if it is not already selected) and then make the following entries:
  - IP address: 192.168.0.22 (or any available address in the 192.168.0.x network, except 192.168.0.1)
  - Subnet mask: 255.255.255.0
  - Default gateway: 192.168.0.1Leave the DNS server fields empty.
- 4 Click OK to save your changes.

Your changes are put into effect immediately.

## STEP 4: LOGGING INTO THE C110 ACCESS POINT

As specified in [Step 3: Preparing Your Computer for C110 Setup](#), the C110 should be directly connected to your computer (through the Ethernet port on the bottom of the C110) and powered on, ready for setup.

- 1 On your computer, open a web browser window.
- 2 In the browser, type this URL to connect to the C110:
  - <https://192.168.0.1>
- 3 Press <Enter> to initiate the connection. When a security alert dialog box appears, click OK/Yes to proceed.
- 4 When the *Ruckus Wireless Admin* login page appears, enter the following:
  - Username: super
  - Password: sp-admin
- 5 Click Login.

## STEP 4A: OPERATING THE CABLE MODEM

**Note:** If the C110 CM is going to be managed by a CMTS, then skip this section and continue with [Step 6: Attaching the Mounting Bracket to an Outlet Box](#).

**Note:** The CM and AP each have their own independent firmware load that are each updated independently.

Continue with [Logging Into the CM Web Interface via the Ethernet Port](#) or [Logging Into the CM Web Interface via a Dynamic IP Address](#).

### Logging Into the CM Web Interface via the Ethernet Port

- 1 Complete [Step 1: Collecting Tools and Setup Requirements](#) through [Step 3: Preparing Your Computer for C110 Setup](#).
- 2 On the administrative computer, open a web browser window.
- 3 In the address or location bar, type the CM IP address, for instance:  
192.168.100.1  
--OR--  
<DHCP-assigned CM IP address>
- 4 The CM web interface displays a login prompt.
- 5 Leave *User Name* blank.
- 6 In *Password*, type ADMIN.
- 7 Click **Log In**. The *Connection Status* page appears, indicating that you have successfully logged on to the CM web interface.

### Logging Into the CM Web Interface via a Dynamic IP Address

- 1 Connect the administrative computer to the same subnet as the C110.
- 2 On the administrative computer, start a web browser.
- 3 In the address bar, enter the IP address that is assigned to the CM by the CMTS. The CM web interface displays a login prompt.
- 4 Leave *User Name* blank.
- 5 In *Password*, type ADMIN.
- 6 Click **Log In**. The *Connection Status* page appears, indicating that you have successfully logged on to the CM web interface.

## STEP 5: CUSTOMIZING THE WIRELESS SETTINGS

### Default C110 Access Point Settings (for your reference)

Network Names (SSIDs)	Wireless1-Wireless8 (2.4GHz radio) Wireless9-Wireless16 (5GHz radio)
Security (Encryption method)	Disabled for each wireless interface
Default Management IP Address	192.168.0.1

- 1 On the web interface menu, click Configuration > Radio 2.4G or Configuration > Radio 5G. The *Configure > Wireless > Common* page appears.
- 2 Verify that the following options are active:
  - Channel: SmartSelect.
  - Country Code: If you are not located in the United States of America, select your current country.
- 3 Click Update Settings if you made any changes.
- 4 Click any of the “Wireless #” (Wireless LAN Number) tabs at the top of the page.
- 5 In *Wireless Availability*, click Enabled.
- 6 Delete the text in the SSID field, then type a name for your network that will help your users identify the C110 access point in their wireless network connection applications.
- 7 Click Update Settings to save your changes.
- 8 Repeat Steps 4-7 for each Wireless # (Wireless LAN Number) interface that you want to enable.
- 9 Click Logout to exit the Web interface.

**Optional:** In a default C110 configuration, the C110 uses a DHCP-assigned IP address.

If you anticipate logging into the C110 regularly to perform monitoring or maintenance once it is in place, then you may want to consider switching from DHCP and instead assigning a static IP address to the C110.

- A On the menu, click **Configuration > Internet**.
- B Click the **Static IP** option.
- C Fill in the **IP Address** and **Mask** fields.
- D Click **Update Settings** to save your changes.

- 10 When the *Ruckus Wireless Admin* login page reappears, you can exit your browser.

- 11 Disconnect the C110 from the computer and from the power source, and then restore your computer to its original network connection configuration.

Continue with [Step 6: Attaching the Mounting Bracket to an Outlet Box](#).

## STEP 6: ATTACHING THE MOUNTING BRACKET TO AN OUTLET BOX

- 1 Using a T10 torx screwdriver, remove the two torx locking screws from the sides of the AP.

Figure 3: Remove the torx screws to detach the bracket from the AP

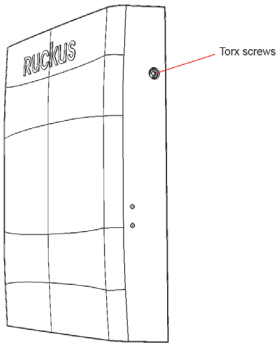

- 2 Remove the mounting bracket from the rear of the AP.

Figure 4: Mounting bracket

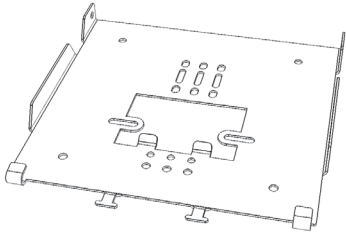

- 3 Use either the original wall outlet box screws or the factory-supplied 1" Phillips pan head machine screws to attach the C110 mounting bracket to a single-gang wall outlet box.

**NOTE:** The C110 mounting bracket has two hooks that face UP. Make sure that the hooks are facing up when attaching the mounting bracket to the wall outlet box.

- 4 Pull the coaxial cable for the C110 through the wall outlet box.
- 5 Pull the power cable from the adapter through the wall outlet box.

- 6 When you have extra bypass cables (up to two) that are to bypass the C110, pull them through the wall outlet box. *Note: The bypass cables can be Ethernet, coax, or any other type of cable, as required.*

## STEP 7: ATTACHING THE C110 TO THE MOUNTING BRACKET

- 1 Make sure that the mounting bracket is securely fastened as described in [Step 6: Attaching the Mounting Bracket to an Outlet Box](#).
- 2 If you are installing a customer-supplied USB device (such as a BLE beacon), then plug it securely into the USB jack on the bottom of the C110.
- 3 Pull the uplink coaxial cable from your network through the outlet box, and plug it into the back of the C110.
- 4 Connect the power adapter cable to the 12VDC in port on the back of the C110.
- 5 The mounting bracket has two lower hooks that fit into slots on the bottom of the C110. Rest the bottom of the C110 on those hooks, and then tilt the C110 toward the wall until it is up against the mounting bracket.  
**Note** that any optional bypass cable(s) should slide smoothly into the slots on the bottom of the C110.

Figure 5: Attaching the C110 to the Mounting Bracket

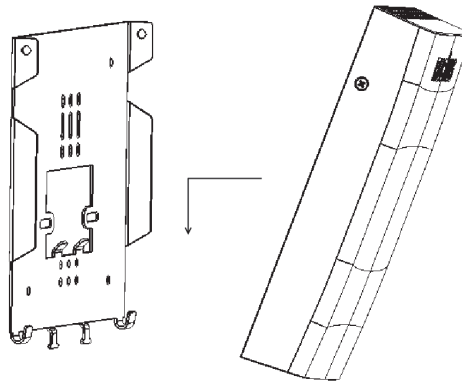

- 6 Use a T10 Torx driver to screw the factory-supplied Torx flat head machine screws through the C110 screw holes into the threaded inserts on the sides of the mounting bracket.

## STEP 8: TESTING THE C110 OPERATION

After a short pause to re-establish the Internet connection, you can test the C110.

- 1 Using any wireless-enabled computer or mobile device, search for and select the wireless network you previously configured.
- 2 If you can connect, open a browser and navigate to any public Web site.
- 3 Using any wired computer or other device and an Ethernet cable, plug into an Ethernet port on the bottom of the C110.
- 4 Open a browser and navigate to any public Web site.
- 5 Repeat [Step 3](#) and [Step 4](#) for the rest of the Ethernet ports on the bottom of the C110.
- 6 Verify that any connected USB devices are working correctly, if applicable.

*Congratulations!* Your C110 is active and ready for use.





## Access Point Getting Started Guide

This Getting Started Guide provides getting started information for version 104.x and later Ruckus Wireless base image access points (APs).

This document assumes familiarity with the Ruckus ZoneFlex (ZF), ZoneDirector (ZD), SmartZone (SZ), and FlexMaster (FM) product lines and the features of earlier releases.

**NOTE:** This document covers Ruckus Wireless APs. For information about ZD and SZ controllers, as well as FM managers, please refer to their respective user documents.

**NOTE:** For Ruckus Wireless APs running version 104.x and later, please be advised that:

- The Ruckus Wireless AP may send a query to Ruckus containing the AP's serial number. The purpose is to enable your AP to autonomously connect with a wireless LAN controller operated by your choice of cloud service provider. Ruckus may transmit back to the AP the Fully Qualified Domain Name (FQDN) or IP address of the controller that the AP will subsequently attempt to join.
- Please be advised that this information may be transferred and stored outside of your country of residence where data protection standards may be different.

### CERTIFICATE CHANGES

Beginning in November 2016, the existing default SSL device certificate on Ruckus APs will expire. Ruckus has been rolling out replacement certificates on APs since 2015. Build 104 makes the new replacement certificate the default SSL device certificate.

All APs shipped from Ruckus with release 104 and later will have the new replacement certificates for SSL authentication with SmartZone controllers.

Due to this change, APs with release 104 may not be able to join some older versions of SZ software. To address this limitation, the SZ has to be upgraded to 3.1.2 or later.

The certificate expiry will require all APs to have the new replacement certificates loaded and made default to be able to join SZ with certificate check beyond November 2016. If, after November 2016, the AP is not able to join SZ, please contact Ruckus Support for assistance.

### STANDALONE OR FLEXMASTER-MANAGED OPERATION

Ruckus Wireless APs are shipped from the factory with a single firmware image, referred to as the "base image." APs with the base image can only operate in standalone mode with or without a FlexMaster manager.

Controller-specific features (such as Smart Mesh networking) are unavailable when the AP is running a standalone AP base image.

Refer to the *Ruckus Wireless Indoor Access Point User Guide* or the *Ruckus Wireless Outdoor Access Point User Guide* for instruction on how to configure the AP for standalone and/or FlexMaster-managed operation.

### CONTROLLER MANAGEMENT

In addition to standalone and FlexMaster management, ZoneFlex APs can also be managed by Ruckus Wireless ZoneDirector or SmartZone controller platforms. When the AP discovers one of these controllers on the network, the AP downloads the associated controller-specific image and replaces the base image with the controller-compatible AP firmware.

### "Island" SSID

Beginning with AP base image release 104.0, the "island-xxxxxx" SSID that is broadcast when an AP starts up in factory default state can be accessed using the AP's serial number as the PSK passphrase. This change makes it easier to configure an AP that has already been installed.

### Ruckus Cloud Discovery

Ruckus Cloud Wi-Fi is WLAN Management-as-a-Service that enables enterprises with limited IT resources to easily set-up, monitor, and manage a high-performance multi-site WLAN of any size, without compromising on Wi-Fi performance.

Beginning with Release 104.0, all Ruckus 802.11ac APs have the ability to discover and register with a Ruckus Cloud controller (note that 802.11n APs do not have this capability). 11ac APs with 104 image will use secure HTTPS to query the AP Registrar to discover the remote/cloud controller. If found, the AP will utilize secure mechanisms (e.g., SSH port 22 and HTTPS port 11443) to communicate with the remote vSZ/Cloud controller to connect, and download firmware.

The AP will probe the AP Registrar more often in the first 14 days after initial power-up, and after that, less frequently. Once the AP finds a controller (ZD, SZ, or Cloud), it will no longer look for the AP Registrar.

**NOTE:** If APs are intended for management by Ruckus Cloud controller, and you have any other Ruckus controller on your local network, you must disable the option to "Automatically approve all AP join requests" from the controller UI before connecting the AP to the network. If not, the AP will register with the local controller first and will be unable to discover Ruckus Cloud.

### SmartZone AP Discovery Process

SmartZone controllers running version 2.5 and later include an LWAPP2SCG utility for migrating Ruckus APs to SmartZone control.

Ruckus APs running version 104.x and later can discover SmartZone controllers without the need to enable the LWAPP2SCG service on the controller and open ports 12223 and 21 on any firewalls or NAT devices between the controller and the APs.

**NOTE:** Some older APs may not be able to discover an SZ controller using this discovery process. If you encounter this issue, you have two options:

- First upgrade the AP to base image 104 or later.
- Enable LWAPP2SCG service on the SZ, and open ports 12223 and 21 (if needed).

## CONTROLLER DISCOVERY METHODS

There are four methods by which an AP can discover a (ZD or SZ) controller:

- [Method 1: Controller Discovery Using L2 Subnet](#)
- [Method 2: Controller Discovery Using DHCP](#)
- [Method 3: Controller Discovery Using DNS](#)
- [Method 4: Manually Setting the Controller IP Address in the AP Web Interface](#)

### Method 1: Controller Discovery Using L2 Subnet

When the AP is powered on and connected to the same Layer 2 IP subnet as a controller, the AP looks for any SZ or ZD controller. It continues searching for a controller until it finds one, until the Ruckus Wireless AP Registrar service assigns it a controller, or until the installer logs into the AP web interface and configures the controller IP address manually, or until the discovery agents are disabled on the AP.

- **SZ:** When the AP finds an SZ controller on the same subnet and the controller is configured to automatically approve APs, the AP automatically updates the base image with the controller-compatible firmware image.
- **ZD:** When the AP finds a ZD controller on the same subnet and the ZD controller is configured to add APs with the base image, the AP automatically downloads the ZD-compatible firmware image.

**NOTE:** Ensure that "Automatically approve all join requests" is enabled on the **Configure > Access Points > Access Point Policies** page.

**NOTE:** If multiple SZ and ZD controllers exist on the network, the AP will attempt to associate with an SZ controller first before associating with a ZD controller. If it does not discover an SZ controller, it will begin searching for a ZD controller after a pause of about 30 seconds.

### Method 2: Controller Discovery Using DHCP

If your APs will be deployed on different subnets from the controller, you can use DHCP (Option 43) or DHCPv6 (Option 17 or 52) to allow the AP to discover the controller when it boots up, upon requesting an IP address from the DHCP server.

- **SZ:** Enter DHCP Option 43 Code 6, DHCPv6 Option 17 Code 6, or DHCPv6 Option 52.
- **ZD:** Enter DHCP Option 43 Code 3, DHCPv6 Option 17 Code 3, or DHCPv6 Option 52.

Refer to the SZ or ZD user documents for instructions on how to configure your DHCP server to automatically provide the controller address to the AP using DHCP.

**NOTE:** For SmartZone, IPv6 discovery takes priority if both options are configured.

### Method 3: Controller Discovery Using DNS

If your APs will be deployed on different subnets from the controller, you can also use DNS to allow the AP to discover the controller when it boots up.

Refer to the SZ or ZD user documents for instructions on how to configure your DNS server to automatically provide the controller address using DNS.

- **SZ:** ruckuscontroller.<domain>
- **ZD:** zonedirector.<domain>

### Method 4: Manually Setting the Controller IP Address in the AP Web Interface

- 1 Go to **Administration > Management** page in the AP web interface.
- 2 Click **Set Controller Address Enabled**, then enter a primary controller IP address and optionally, a secondary controller IP address, and then click **Update Settings**.

Figure 1: Sample Administration > Management Page

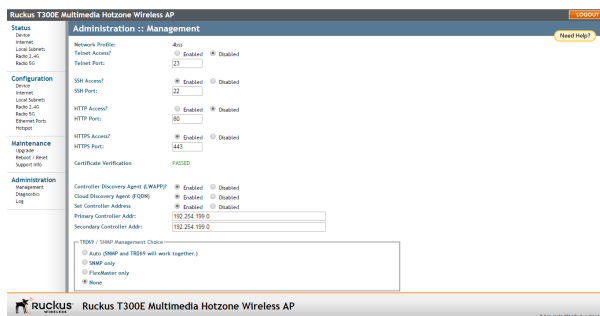

## RETURNING THE AP TO THE BASE IMAGE

After an AP has been upgraded to a controller-specific image as described above, you can return it to standalone/FlexMaster operation by upgrading the firmware back to a standalone AP base image.

## UPGRADE INFORMATION

To manually upgrade/downgrade the AP firmware, go to **Maintenance > Upgrade** in the AP web interface. Refer to the *Ruckus Wireless Outdoor Access Point User Guide* or the *Ruckus Wireless Indoor Access Point User Guide* for instructions on how to upgrade the AP firmware.

Figure 2: Sample Maintenance > Upgrade Page

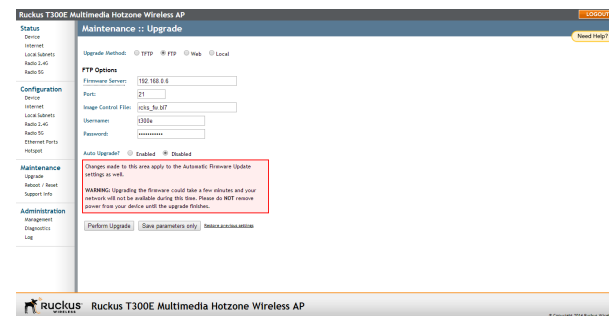

**NOTE:** Once the upgrade (or downgrade) is complete, you must reset the AP to factory defaults, and log in again using the factory default user name and password (un: super; pw: sp-admin, IP address: 192.168.0.1) to configure the AP for standalone operation.

## Federal Communications Commission Notices

This product complies with Part 15 of the FCC Rules. Operation is subject to the following two conditions: (1) this device may not cause harmful interference, and (2) this device must accept any interference received, including interference that may cause undesired operation.

Caution: Changes or modifications to this equipment that have not been approved by Ruckus Wireless may void the user's authority to operate this equipment.

This device is restricted for indoor use.

### IMPORTANT NOTE:

#### FCC Radiation Exposure Statement:

This equipment complies with FCC radiation exposure limits set forth for an uncontrolled environment. This equipment should be installed and operated with minimum distance 20cm between the radiator & your body.

Note: This equipment has been tested and found to comply with the limits for a Class B digital device, pursuant to part 15 of the FCC Rules. These limits are designed to provide reasonable protection against harmful interference in a residential installation. This equipment generates, uses and can radiate radio frequency energy and, if not installed and used in accordance with the instructions, may cause harmful interference to radio communications. However, there is no guarantee that interference will not occur in a particular installation. If this equipment does cause harmful interference to radio or television reception, which can be determined by turning the equipment off and on, the user is encouraged to try to correct the interference by one or more of the following measures:

- Reorient or relocate the receiving antenna.
- Increase the separation between the equipment and receiver.
- Connect the equipment into an outlet on a circuit different from that to which the receiver is connected.
- Consult the dealer or an experienced radio/TV technician for help.

## Industry Canada Statement

Under Industry Canada regulations, this radio transmitter may only operate using an antenna of a type and maximum (or lesser) gain approved for the transmitter by Industry Canada. To reduce potential radio interference to other users, the antenna type and its gain should be so chosen that the equivalent isotropically radiated power (e.i.r.p.) is not more than that necessary for successful communication.

Conformément à la réglementation d'Industrie Canada, le présent émetteur radio peut fonctionner avec une antenne d'un type et d'un gain maximal (ou inférieur) approuvé pour l'émetteur par Industrie Canada. Dans le but de réduire les risques de brouillage radioélectrique à l'intention des autres utilisateurs, il faut choisir le type d'antenne et son gain de sorte que la puissance isotrope rayonnée équivalente (p.i.r.e.) ne dépasse pas l'intensité nécessaire à l'établissement d'une communication satisfaisante.

This device complies with Industry Canada licence-exempt RSS standard(s). Operation is subject to the following two conditions: (1) this device may not cause interference, and (2) this device must accept any interference, including interference that may cause undesired operation of the device.

Le présent appareil est conforme aux CNR d'Industrie Canada applicables aux appareils radio exempts de licence. L'exploitation est autorisée aux deux conditions suivantes : (1) l'appareil ne doit pas produire de brouillage, et (2) l'utilisateur de l'appareil doit accepter tout brouillage radioélectrique subi, même si le brouillage est susceptible d'en compromettre le fonctionnement.

The device for operation in the band 5150-5250 MHz is only for indoor use to reduce the potential for harmful interference to co-channel mobile satellite systems; the maximum antenna gain permitted for devices in the bands 5250-5350 MHz and 5470-5725 MHz shall comply with the e.i.r.p. limit; and the maximum antenna gain permitted for devices in the band 5725-5825 MHz shall comply with the e.i.r.p. limits specified for point-to-point and non point-to-point operation as appropriate.

Le dispositif de fonctionnement dans la bande 5150-5250 MHz est réservé à une utilisation en intérieur pour réduire le risque d'interférences nuisibles à la co-canal systèmes mobiles par satellite, le gain d'antenne maximal autorisé pour les appareils dans les bandes 5250-5350 MHz et 5470-5725 MHz doit se conformer à la pire limite, et le gain d'antenne maximal autorisé pour les appareils dans la bande 5725-5825 MHz doivent être conformes avec le pire limites spécifiées à point-à-ponctuelles et non point-à-point de fonctionnement selon qu'il convient.

Operation in the 5600-5650 MHz band is not allowed in Canada. High-power radars are allocated as primary users (i.e. priority users) of the bands 5250-5350 MHz and 5650-5850 MHz and that these radars could cause interference and/or damage to LE-LAN devices.

Opération dans la bande 5600-5650 MHz n'est pas autorisée au Canada. Haute puissance radars sont désignés comme utilisateurs principaux (c.-à-utilisateurs prioritaires) des bandes 5250-5350 MHz et 5650-5850 MHz et que ces radars pourraient causer des interférences et / ou des dommages à des dispositifs LAN-EL.

## Radiation Exposure Statement

The device has been found to be compliant to the requirements set forth in CFR 47 Sections 2.1091 and Industry Canada RSS-102 for an uncontrolled environment. The antenna(s) used for this transmitter must be installed to provide a separation distance of at least 20 cm from all persons and must not be co-located or operating in conjunction with any other antenna or transmitter.

Le dispositif a été jugé conforme aux exigences énoncées dans les articles 47 CFR 2.1091 et Industrie Canada RSS-102 pour un environnement non contrôlé. L'antenne (s) utilisée pour ce transmetteur doit être installé pour fournir une distance de séparation d'au moins 20 cm de toutes les personnes et ne doit pas être co-localisés ou fonctionner en conjonction avec une autre antenne ou transmetteur.

For indoor use only.

Pour une utilisation en intérieur uniquement.

## Mexico Statement

"La operación de este equipo está sujeta a las siguientes dos condiciones: (1) es posible que este equipo o dispositivo no cause interferencia perjudicial y (2) este equipo o dispositivo debe aceptar cualquier interferencia, incluyendo la que pueda causar su operación no deseada."

## Professionally Installed Products

The product is to be installed according to the installation instructions. The Use/Operator does not have access to the device once the device is installed and in use. Provisions for permanent grounding are provided.

1. Installation personal: This product is designed for specific application and needs to be installed by a qualified personal who has RF and related rule knowledge. The general user shall not attempt to install or change the setting.
2. Installation location: The product shall be installed at a location where the radiating antenna can be kept 20 cm from nearby person in normal operation condition to meet regulatory RF exposure requirement. Additionally, installation locations with 35km of Terminal Doppler Weather Radar locations shall follow instructions below.
  - a. Any installation of either a master or a client device within 35 km of a TDWR location shall be separated by at least 30 MHz center-to-center) from the TDWR operating frequency.
  - b. A voluntary WISPA sponsored database has been developed that allows operators and installers to register the location information of the UNII devices operating outdoors in the 5470 – 5725 MHz band within 35 km of any TDWR location (see <http://www.spectrumbridge.com/udia/home.aspx> ). This database may be used by government agencies in order to expedite resolution of any interference to TDWRs.
  - c. Addition information can be obtained from the FCC Knowledge Database, Publication Number 443999. <https://apps.fcc.gov/oetcf/kdb/index.cfm>
3. External antenna: Use only the antennas which have been approved by Ruckus Wireless. The non-approved antenna(s) may produce unwanted spurious or excessive RF transmitting power which may lead to the violation of FCC limit and is prohibited.
4. Installation procedure: Please refer to user's manual for the detail.
5. Warning: Please carefully select the installation position and make sure that the final output power does not exceed the limit set force in US Rule CFR 47 part 15 section 15.247 & 15.407. The violation of the rule could lead to serious federal penalty.

## External Antenna Notice

This radio transmitter has been approved by the FCC and Industry Canada to operate with the antenna types listed below with the maximum permissible gain and required antenna impedance for each antenna type indicated. Antenna types not included in this list, having a gain greater than the maximum gain indicated for that type, are strictly prohibited for use with this device.

Le présent émetteur radio (identifier le dispositif par son numéro de certification ou son numéro de modèle s'il fait partie du matériel de catégorie I) a été approuvé par Industrie Canada pour fonctionner avec les types d'antenne énumérés ci-dessous et ayant un gain admissible maximal et l'impédance requise pour chaque type d'antenne. Les types d'antenne non inclus dans cette liste, ou dont le gain est supérieur au gain maximal indiqué, sont strictement interdits pour l'exploitation de l'émetteur.

**Model: ZoneFlex 7441** [ZF7441]: This device has been designed to operate with an antenna having maximum gain of 2dBi. Other antenna types or having greater gain are strictly prohibited for use with this device. The required antenna impedance is 50 ohms.

**Model: ZoneFlex 7372E** [ZF7372E]: This device has been designed to operate with an antenna having maximum gain of 7dBi. Other antenna types or having greater gain are strictly prohibited for use with this device. The required antenna impedance is 50 ohms.

## Products intended to be powered by an external power supply:

Caution –This product is intended to be supplied by a Listed Direct Plug-In Power Unit marked Class 2 or LPS (sub-clause 2.5 of standard EN 60950-1). Available Ruckus power supplies intended for product operation are identified in the product datasheet. The last two digits of the power supply part number represent the country code. For additional applicable power supplies/options, see user instructions and product datasheet.

## Medical Statement

Ruckus Wireless Access Points shall only be used in ME systems where the intended EM ENVIRONMENT does NOT does not rely on the WLAN radio link for BASIC SAFETY or ESSENTIAL PERFORMANCE of the ME SYSTEM.

## Australia Statement

This device complies with the ACMA requirements for a Wi-Fi device namely Radio Communications (Low Impact Potential Devices) Class Licence 2000 Amd. 1:2007 and Radiocommunications (Compliance Labelling – Electromagnetic Radiation) Notice 2003. The equipment complies with the ACMA requirements for radiation exposure for a "general user/non-aware user". This equipment should be installed and operated with a minimum distance of 20 cm between the radiator and your body. This equipment complies with the Australian safety requirements and should only used with the specified power adapter according to the product datasheet.

## Brazil Statement

For Brazil, those products are designed for specific application and needs to be installed by a qualified personal who has RF and related rule knowledge. Regarding the operation on range of 5150 MHz to 5350 MHz, the average output power of the equipments must be adjusted to the maximum limit of - 0,48 dBm and for 5470 MHz to 5725 MHz, the average output power of the equipments must be adjusted to the maximum limit of 6,44 dBm.

Para o Brasil, esses produtos são projetados para aplicações específicas e necessidades a serem instalados por um pessoal qualificado que tenha conhecimento regra RF e afins. Em relação à operação em série de 5150 MHz a 5350 MHz, a potência média de saída dos equipamentos deve ser ajustado para o limite máximo de - 0,48 dBm e para 5470 MHz a 5725 MHz, a potência média de saída dos equipamentos deve ser ajustada ao limite máximo de 6,44 dBm.

## Taiwan Statement

本產品為5.25-5.35 GHz頻帶內操作之UNII設備，僅限於室內使用

The frequency band 5250 – 5350 MHz is restricted to indoor use.

經型式認證合格之低功率射頻電機，非經許可，公司、商號或使用者均不得擅自變更頻率、加大功率或變更原設計之特性及功能。

低功率射頻電機之使用不得影響飛航安全及干擾合法通信；經發現有干擾現象時，應立即停用，並改善至無干擾時方得繼續使用。前項合法通信，指依電信法規定作業之無線電通信。低功率射頻電機須忍受合法通信或工業、科學及醫療用電波輻射性電機設備之干擾。



The control, adjustment and on/off operation of this device does not violate the "Administrative regulations on low power radio waves radiated devices". Any adjustments to the device should be carried out or be monitored by a specialist who has expertise on radio frequency devices. Replacement of components which may lead to the violation to the regulations is not allowed. Without permission granted by the NCC, any company, enterprise, or user is not allowed to change frequency, enhance transmitting power or alter original characteristic as well as performance to an approved low power radio-frequency devices. The low power radio-frequency device shall not influence aircraft security and interfere with legal communications; if found, the user shall cease operating immediately until no interference is achieved. The said legal communications means radio communications is operated in compliance with the Telecommunications Act. The low power radio-frequency devices must not be susceptible with the interference from legal communications or ISM radio wave radiated devices.

## European Union Notices and National Restrictions

The frequency band 5150 – 5350 MHz is restricted to indoor use



AT	FI	IT	PL	GB	RO
BE	FR	LV	PT	IS	TR
CY	DE	LT	SK	LI	
CZ	GR	LU	SI	NO	
DK	HU	MT	ES	CH	
EE	IE	NL	SE	BG	

### Italy

This product meets the National Radio Interface and the requirements specified in the National Frequency Allocation Table for Italy. Unless operating within the boundaries of the owner's property, the use of this 2.4 GHz Wireless LAN product requires a 'general authorization'. Please check with <http://www.comunicazioni.it/> for more details.

*Questo prodotto è conforme alla specifiche di Interfaccia Radio Nazionali e rispetta il Piano Nazionale di ripartizione delle frequenze in Italia. Se non viene installato all'interno del proprio fondo, l'utilizzo di prodotti Wireless LAN a 2.4 GHz richiede una "Autorizzazione Generale". Consultare <http://www.comunicazioni.it/> per maggiori dettagli.*

### Belgium

The Belgian Institute for Postal Services and Telecommunications (BIPT) must be notified of any outdoor wireless link having a range exceeding 300 meters. Please check <http://www.bipt.be> for more details. / *Draadloze verbindingen voor buitengebruik en met een reikwijdte van meer dan 300 meter dienen aangemeld te worden bij het Belgisch Instituut voor postdiensten en telecommunicatie (BIPT). Zie <http://www.bipt.be> voor meer gegevens. / Les liaisons sans fil pour une utilisation en extérieur d'une distance supérieure à 300 mètres doivent être notifiées à l'Institut Belge des services Postaux et des Télécommunications (IBPT). Visitez <http://www.ibpt.be> pour de plus amples détails.*

Česky [Czech]	Ruckus Wireless tímto prohlašuje, že tento Radio LAN je ve shodě se základními požadavky a dalšími příslušnými ustanoveními směrnice 1999/5/ES.
Dansk [Danish]	Undertegnede Ruckus Wireless erklærer herved, at følgende udstyr Radio LAN overholder de væsentlige krav og øvrige relevante krav i direktiv 1999/5/EF.
Deutsch [German]	Hiermit erkläre Ruckus Wireless, dass sich das Gerät Radio LAN in Übereinstimmung mit den grundlegenden Anforderungen und den übrigen einschlägigen Bestimmungen der Richtlinie 1999/5/EG befindet.
Eesti [Estonian]	Käesolevaga kinnitab Ruckus Wireless seadme Radio LAN vastavust direktiivi 1999/5/EÜ põhinõuetele ja nimetatud direktiivist tulenevatele teistele asjakohastele sätetele.
English	Hereby, Ruckus Wireless declares that this Radio LAN is in compliance with the essential requirements and other relevant provisions of Directive 1999/5/EC.
Español [Spanish]	Por medio de la presente Ruckus Wireless declara que el Radio LAN cumple con los requisitos esenciales y cualesquiera otras disposiciones aplicables o exigibles de la Directiva 1999/5/CE.
Ελληνική [Greek]	ΜΕ ΤΗΝ ΠΑΡΟΥΣΑ Ruckus Wireless ΔΗΛΩΝΕΙ ΟΤΙ Radio LAN ΣΥΜΜΟΡΦΩΝΕΤΑΙ ΠΡΟΣ ΤΙΣ ΟΥΣΙΩΔΕΙΣ ΑΠΑΙΤΗΣΕΙΣ ΚΑΙ ΤΙΣ ΛΟΙΠΕΣ ΣΧΕΤΙΚΕΣ ΔΙΑΤΑΞΕΙΣ ΤΗΣ ΟΔΗΓΙΑΣ 1999/5/ΕΚ.
Français [French]	Par la présente Ruckus Wireless déclare que l'appareil Radio LAN est conforme aux exigences essentielles et aux autres dispositions pertinentes de la directive 1999/5/CE.
Italiano [Italian]	Con la presente Ruckus Wireless dichiara che questo Radio LAN è conforme ai requisiti essenziali ed alle altre disposizioni pertinenti stabilite dalla direttiva 1999/5/CE.
Latviski [Latvian]	Ar šo Ruckus Wireless deklarē, ka Radio LAN atbilst Direktīvas 1999/5/EK būtiskajām prasībām un citiem ar to saistītajiem noteikumiem.
Lietuvių [Lithuanian]	Šiuo Ruckus Wireless deklaruoją, kad šis Radio LAN atitinka esminius reikalavimus ir kitas 1999/5/EB Direktyvos nuostatas.
Nederlands [Dutch]	Hierbij verklaart Ruckus Wireless dat het toestel Radio LAN in overeenstemming is met de essentiële eisen en de andere relevante bepalingen van richtlijn 1999/5/EG.
Malti [Maltese]	Hawnhekk, Ruckus Wireless, jiddikjara li dan Radio LAN jikkonforma mal-ftigijiet essenzjali u ma provvedimenti oħrajn rilevanti li hemm fid-Direttiva 1999/5/EC.
Magyar [Hungarian]	Alulírott, Ruckus Wireless nyilatkozom, hogy a Radio LAN megfelel a vonatkozó alapvető követelményeknek és az 1999/5/EC irányelv egyéb előírásainak.
Polski [Polish]	Niniejszym Ruckus Wireless oświadcza, że Radio LAN jest zgodny z zasadniczymi wymogami oraz pozostałymi stosownymi postanowieniami Dyrektywy 1999/5/EC.
Português [Portuguese]	Ruckus Wireless declara que este Radio LAN está conforme com os requisitos essenciais e outras disposições da Directiva 1999/5/CE.

Slovensko [Slovenian]	Ruckus Wireless izjavlja, da je ta Radio LAN v skladu z bistvenimi zahtevami in ostalimi relevantnimi določili direktive 1999/5/ES.
Slovensky [Slovak]	Ruckus Wireless týmto vyhlasuje, že Radio LAN spĺňa základné požiadavky a všetky príslušné ustanovenia Smernice 1999/5/ES.
Suomi [Finnish]	Ruckus Wireless vakuuttaa täten että Radio LAN tyyppinen laite on direktiivin 1999/5/EY oleellisten vaatimusten ja sitä koskevien direktiivin muiden ehtojen mukainen.
Svenska [Swedish]	Härmed intygar Ruckus Wireless att denna Radio LAN står i överensstämmelse med de väsentliga egenskapskrav och övriga relevanta bestämmelser som framgår av direktiv 1999/5/EG.
Íslenska [Icelandic]	Hér með lýsir Ruckus Wireless yfir því að Radio LAN er í samræmi við grunnkröfur og aðrar kröfur, sem gerðar eru í tilskipun 1999/5/EC.
Norsk [Norwegian]	Ruckus Wireless erklærer herved at utstyret Radio LAN er i samsvar med de grunnleggende krav og øvrige relevante krav i direktiv 1999/5/EF.