



INSTALLATION/OPERATION MANUAL

*LightStyle*TM

LS-12HBd

High-Brightness, Active 3D Home Theater Projection System

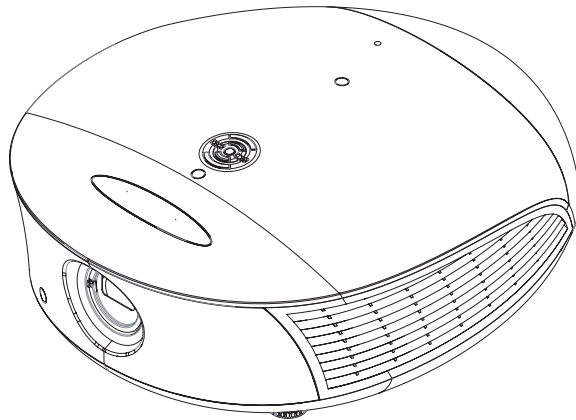

THE WORLD'S FINEST HOME THEATER PRODUCTSTM

RuncoCare™ Standard Two Year Limited Warranty

Congratulations on your purchase of a Runco® product! With proper installation, setup and care, you should enjoy many years of unparalleled video performance.

This Limited Warranty is provided free of charge by Runco International, LLC (“Runco”) with the purchase of a covered Runco product. This Limited Warranty is applicable to all Runco projectors, processors, LCD display and plasma display products, with the exception of the following models: XP-103DHD, SC-1 and SC-1a¹. This Limited Warranty applies to purchases of covered Runco products occurring on or after **June 1, 2011**.

RuncoCare™ Limited Warranty Coverage

Runco warrants its products to be free from defects in material and workmanship during the warranty period provided below. If a product proves to be defective in material or workmanship during the warranty period, Runco will repair the product, replace the product with a substantially similar new or like-new product, or refund a prorated share of the purchase price (calculated based on the remainder of the warranty period and the then-current, most-recent MSRP² of a similar product), if repair or replacement of the product is determined by Runco to not be feasible.

Length of RuncoCare™ Warranty Period

Runco products are warranted for two (2) years from the date of shipment from Runco. Lamps are warranted six (6) months from the date of shipment or 1000 hours of use, whichever comes first. A replacement lamp is warranted for the remaining portion (if any) of the original warranty period or ninety (90) days from the date it was shipped to you, whichever is longer. All other accessories, which include but are not limited to cables, remotes, carrying cases, lens cap and other peripherals sold with the Runco product, are warranted for ninety (90) days from the date of shipment.

RuncoCare™ Eligibility

This Limited Warranty is valid only in the country where the Product was originally purchased and for the buyer who originally purchased the covered product from the authorized Runco dealer or distributor. This warranty is not transferable; it is not valid for any subsequent buyer (if any). You may be required to provide proof of purchase in order to receive warranty services.

-
1. Runco may update this list of products excluded from this warranty from time to time at Runco’s sole discretion, but updates will not apply on a retroactive basis.
 2. MSRP is defined as the most recent product price listed on Runco’s price list.

RuncoCare™ Standard Claim Procedure

- In the event of a product defect, please follow the claim procedure provided below:
 - A. Register your product if you have not yet done so. Visit <http://www.runco.com/support/product-registration/> to register the product.
 - B. Contact your original authorized dealer or distributor who sold the product.
 - C. The dealer/distributor will contact Runco Technical Support via email at support@runco.com or via phone at 1-800-23-RUNCO (1-800-237-8626).
- The dealer/distributor will provide to Runco proof of purchase, serial number, product model number, description of the problem and any troubleshooting steps already attempted.
- Runco's technical support staff will attempt to assist the dealer/distributor in troubleshooting any technical issues that might be causing the product to malfunction. If Runco is unable to resolve the problem through troubleshooting, a Return Material Authorization (RMA) number will be issued for the exchange of the defective product if it is determined that the claim is covered by the warranty. Once an RMA has been created, RMA status is available at serviceorders@runco.com.
- If an RMA is issued, the dealer or customer will need to return the defective product to the Runco repair depot location specified by the Runco technical support representative. The dealer or customer will need to properly package the defective product in a suitable shipping container consisting of the product only, and not include any accessories (e.g., cables, remotes, carrying cases, lens, lens cap and other peripherals). Boxes may be purchased from a Runco technical support representative.
- The dealer or customer is responsible for paying freight charges and insurance to ship the defective product to the Runco repair depot location. If there are any shipping damages, the dealer or customer will need to address and resolve any shipping damage claims directly with the shipping company.
- Runco will not accept a returned product unless an RMA has been issued by Runco.
- For in-warranty repairs, Runco will pay freight charges to return the repaired/replacement product to the dealer/distributor from the Runco repair depot. For select countries or geographies Runco will ship via an economy express service. Return delivery time and availability may vary based on origin and destination, and Runco is unable to deliver to PO Box and FPO Box addresses.
- Note: in the 48 contiguous United States, other options for on-site service or advance exchange for the product may apply, if you purchased the Runco PremierCare™ Service Plan.

What to Include with Your Return

1. Return only the defective product with the lamp (if applicable).
2. Runco will not be responsible for returning or replacing any accessories (e.g., cables, remotes, carrying cases, lens, lens cap and other peripherals sold with the Runco product) that are returned with the defective product.
3. Repaired or replacement products will be shipped with a lamp (if applicable) but without any accessories.

RuncoCare™ Warranty Exclusions

This Limited Warranty does not include and is limited by the following:

1. Products not purchased from an authorized Runco dealer
2. Rental costs incurred by the customer in the event of product defect or failure
3. Any product with a defaced, modified, or removed serial number

-
4. Damage, deterioration, or malfunction resulting from:
 - A. Accident, abuse, misuse, neglect, improper ventilation, fire, water, disaster, lightning, or other acts of nature, smoke exposure (cigarette or otherwise), unauthorized product modification (including use of an unauthorized mount), or failure to follow instructions supplied with the product
 - B. Repair or attempted repair by anyone not authorized by Runco
 - C. Any damage to the product due to shipment
 - D. Removal or installation of the product
 - E. Causes external to the product, such as electric power fluctuations or failure
 - F. Use of supplies or parts (including lamps) that are not purchased from Runco or do not meet Runco's specifications
 - G. Normal wear and tear
 - H. Expected lamp degradation and normal decrease in lamp output over a period of time or as the lamp is consumed
 - I. Customer caused defects, including but not limited to, scratched/defaced/altered plastics
 - J. Failure to follow maintenance procedures as outlined in the product's user guide where a schedule is specified for regular cleaning of the product
 - K. Opening the product and/or tampering with internal circuitry
 - L. Products lost, stolen or discarded
 - M. Any damage or dissatisfaction associated with latent images, "burnin," or any other damage determined by Runco to be the result of customer use patterns
 - N. Any other cause, which does not relate to a product defect in material or workmanship
 5. Removal, installation, and set-up service charges are excluded from the warranty.
 6. Black uniformity issues or other LCD issues associated with usage outside the Runco recommended guidelines and specifications for the product.
 7. Bright or dark sub pixels that are characteristic of LCD technology and considered by Runco to be acceptable and within Runco's manufacturing specifications.

Specifically, it is not uncommon for one or more sub pixels to become bright or dark during or after the manufacturing process. A bright sub pixel is one that remains in the on position, and a dark sub pixel is one that appears black or off. The sub pixels are usually hard to see and will not detract from the display quality or usability at normal viewing distance. The following are Runco's criteria for identifying bright or dark sub pixels that would be considered unacceptable: a) the number of bright or dark sub pixels; b) the location of the bright or dark sub pixels; c) the color of the bright sub pixels; and d) the Runco model size. If sub pixels have been identified as unacceptable by Runco the LCD will be deemed faulty and will be replaced if reported within the warranty period.

Other Terms and Conditions

1. If the defective product is not properly packaged and is damaged in transit during its return to Runco, you may be invoiced for either the repair costs, if repairable, or the MSRP of a replacement product and shipping costs incurred by Runco.
2. The repaired or replaced product will assume the remainder of your original product's warranty term or 90 days from the date the repaired or replaced product is shipped, whichever is longer.
3. If a replacement product is sent, the replacement becomes the property of the customer and the defective product becomes the property of Runco.

RuncoCare™ Extended Service Options

Runco offers extended and expanded service plans. For information on additional product protection, please ask your authorized Runco dealer, email serviceorders@runco.com or call (toll free) (800) 23RUNCO (800-237-8626).

Exclusion of Implied Warranties

RUNCO PROVIDES NO WARRANTIES, EXPRESS OR IMPLIED, EXCEPT THOSE EXPRESSLY PROVIDED IN THIS DOCUMENT. RUNCO EXPRESSLY DISCLAIMS AND EXCLUDES ALL OTHER WARRANTIES, INCLUDING THE IMPLIED WARRANTIES OF TITLE, NONINFRINGEMENT, MERCHANTABILITY AND FITNESS FOR A PARTICULAR PURPOSE.

Limitation of Liability; Exclusion of Damages

RUNCO'S MAXIMUM AGGREGATE LIABILITY IS LIMITED TO THE COST OF REPAIR, REPLACEMENT OR REFUND OF THE PRODUCT.

RUNCO WILL NOT BE LIABLE FOR DAMAGE TO OTHER PROPERTY OR FOR DAMAGES BASED UPON INCONVENIENCE, LOSS OF USE OF THE PRODUCT, LOSS OF TIME, LOSS OF PROFITS, LOSS OF BUSINESS OPPORTUNITY, LOSS OF GOODWILL, INTERFERENCE WITH BUSINESS RELATIONSHIPS, OR OTHER COMMERCIAL OR FINANCIAL LOSS, EVEN IF RUNCO IS AWARE OF THE POSSIBILITY OF SUCH DAMAGES AND EVEN IF A REMEDY HAS FAILED OF ITS ESSENTIAL PURPOSE.

RUNCO WILL NOT BE LIABLE FOR ANY CONSEQUENTIAL, INCIDENTAL, INDIRECT, EXEMPLARY, SPECIAL, PUNITIVE OR ANY OTHER TYPE OF DAMAGES, WHETHER THE CLAIM IS BASED ON CONTRACT, TORT, PRODUCT LIABILITY, NEGLIGENCE, STRICT LIABILITY OR ANY OTHER LEGAL OR EQUITABLE THEORY.

RUNCO WILL NOT BE LIABLE FOR ANY CLAIM AGAINST THE CUSTOMER BY ANY OTHER PARTY.

Effect of Local Law

This Limited Warranty gives you specific legal rights, and you may have other rights, which vary from locality to locality. Some localities do not allow limitations on implied warranties and/or do not allow the exclusion of incidental or consequential damages, so the above limitations and exclusions may not apply to you.

COPYRIGHT AND TRADEMARKS:

© Copyright 2013 Runco International, LLC ("Runco"). This document contains proprietary information protected by copyright, trademark and other intellectual property laws. All rights are reserved. No part of this manual may be reproduced by any mechanical, electronic or other means, in any form, without prior written permission of Runco.

The trademarks reproduced in this Runco Owner's Manual and used on the Runco Products are either owned by Runco or are licensed by Runco. You may not reproduce or use the trademarks without the prior written consent of Runco.

Runco Products are manufactured under one or more of the following patents: US. Patent 6755540 and Other Patents Pending.

Important Safety Instructions

Thank you for your purchase of this quality Runco video product! For the best performance, please read this manual carefully as it is your guide through the menus and operation.

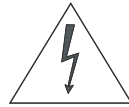
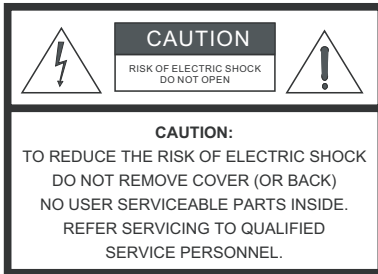

WARNING

This symbol is intended to alert the user to the presence of uninsulated “dangerous voltage” within the product’s enclosure that may be of sufficient magnitude to constitute a risk of electric shock.



This symbol is intended to alert the user to the presence of important operating and maintenance (servicing) instructions in the literature accompanying the appliance.

1. Read these instructions.
2. Keep these instructions.
3. Heed all warnings.
4. Follow all instructions.
5. Do not use this apparatus near water.
6. Clean only with a dry cloth.
7. Do not block any of the ventilation openings. Install in accordance with the manufacturer’s instructions.
8. Do not install near any heat sources such as radiators, heat registers, stoves, or other apparatus (including amplifiers) that produce heat.
9. Do not defeat the safety purpose of the polarized or grounding type plug. A polarized plug has two blades with one wider than the other. A grounding type plug has two blades and a third grounding prong. The wide blade or the third prong is provided for your safety. When the provided plug does not fit into your outlet, consult an electrician for the replacement of the obsolete outlet.
10. Protect the power cord from being walked on or pinched particularly at plugs, convenience receptacles and the point where they exit from the apparatus.
11. Only use the attachments/accessories specified by the manufacturer.
12. Use only with a cart, stand, tripod, bracket or table specified by the manufacturer or sold with the apparatus. When a cart is used, use caution when moving the cart/apparatus to avoid injury from tip-over.
13. Unplug this apparatus during lightning storms or when unused for long periods of time.
14. Refer all servicing to qualified service personnel. Servicing is required when the apparatus has been damaged in any way, such as power supply cord or plug is damaged, liquid has been spilled or objects have fallen into the apparatus, the apparatus has been exposed to rain or moisture, does not operate normally, or has been dropped.
15. The +12V trigger only outputs 12Vdc signal for triggering. Do not connect to any other power input or output. This could cause damage to this unit.
16. Keep the packing material in case the equipment should ever need to be shipped.
17. The lamp becomes extremely hot during operation. Allow the projector to cool down for approximately 45 minutes prior to removing the lamp assembly for replacement.
18. Do not operate lamps beyond the rated lamp life. Excessive operation of lamps beyond rated life could cause them to explode in rare occasions.
19. Never look directly into the lens when the lamp is on.



IMPORTANT HEALTH AND SAFETY INFORMATION FOR 3D VIEWING:

Please read and make sure you understand the following safety information before using the product for viewing 3D content. Provide this information to the end users of this product and ensure that they understand it.



It is widely recognized that stereographic display devices can cause discomfort, including, without limitation, dizziness, nausea, headaches, eye fatigue and eye-strain, in some individuals. The 3D effect and experience will vary by individual, depending on a variety of factors, including his or her health and vision. Runco recommends that users take regular breaks when watching 3D video or playing games using stereoscopic displays. Discontinue use if any discomfort occurs. Parents of young children should ensure their children avoid extensive exposure to electronic stereographic entertainment.

The quality and appropriateness of the 3D screen materials onto which the image is projected and the quality of the 3D content being displayed both have a significant and noticeable impact on the overall 3D experience. A properly-calibrated projection system, including glasses and an optimized third-party screen, displaying high-quality 3D content is the best formula for immersive and comfortable 3D experiences in the home. Please refer to the remainder of this manual for proper projector installation and usage instructions.

The glasses that accompany this product are not safe to use as sunglasses, protective eyewear or any use outdoors or other than only in conjunction with the proper operation of the Runco product with which they are sold. It is common to dim the lights in a home theater. Using 3D glasses and the immersive imagery of stereoscopic imagery can increase the risk of tripping or falling the dark. Special care should be taken.

Do not tilt your head while using the 3D glasses.

Compliance Information

DECLARATION OF CONFORMITY:

Manufacturer's Name: Runco International, LLC

Manufacturer's Address: 1195 NW Compton Drive, Beaverton, OR 97006-1992

hereby declares that the Products' Model Numbers:

LS-12HBd

conform with the provisions of:

Council Directive 2004/108/EC on Electromagnetic Compatibility;

EN 55022 "Limits and methods of measurements of radio interference characteristics of information technology equipment" 1998;

EN 55024 "Limits and methods of measurements of immunity characteristics of information technology equipment" 1998;

Including:

- EN 61000-4-2 "Electromagnetic compatibility (EMC) Part 4: Testing and measurement techniques Section 2: Electrostatic discharge immunity test"
- EN 61000-4-3 "Electromagnetic compatibility (EMC) Part 4: Testing and measurement techniques Section 3: Radiated, Radio-Frequency, Electromagnetic Field Immunity Test"
- EN 61000-4-4 "Electromagnetic compatibility (EMC) Part 4: Testing and measurement techniques Section 4: Electrical fast transient/burst immunity test"
- EN 61000-4-5 "Electromagnetic compatibility (EMC) Part 4: Testing and measurement techniques Section 5: Surge immunity test"
- EN 61000-4-6 "Electromagnetic compatibility (EMC) Part 4: Testing and measurement techniques Section 6: Conducted disturbances induced by radio-frequency fields immunity test"
- EN 61000-4-8 "Electromagnetic compatibility (EMC) Part 4: Testing and measurement techniques Section 8: Conducted disturbances induced by power frequency magnetic fields immunity test"
- EN 61000-4-11 "Electromagnetic compatibility (EMC) Part 4: Testing and measurement techniques Section 11: Voltage dips, short interruptions and voltage variations immunity tests"

And:

- EN 61000-3-2 "Electromagnetic compatibility (EMC) Part 3, Section 2: Limits for harmonic current emissions (equipment input current up to and including 16 A per phase)" 2000;
- EN 61000-3-3 "Electromagnetic compatibility (EMC) Part 3, Section 3: Limitations of voltage changes, voltage fluctuations and flicker in public low-voltage supply systems, for equipment with rated current up to and including 16 A and not subject to conditional connection" 1995;

Council Directive 2006/95/EC and amended by M1 and C1 on Low Voltage Equipment Safety;

EN 60950 "Safety of information technology equipment, including electrical business equipment"

The Technical Construction file required by this Directive is maintained at the corporate headquarters of Runco International, LLC, located at 1195 NW Compton Drive, Beaverton, OR 97006-1992.

Date of Declaration: September 2013

FCC PART 15:

NOTE: This equipment has been tested and found to comply with the limits for a Class B digital device, pursuant to Part 15 of the FCC Rules. These limits are designed to provide reasonable protection against harmful interference in a residential installation.

This equipment generates, uses and can radiate radio frequency energy and, if not installed and used in accordance with the instructions, may cause harmful interference to radio communications. However, there is no guarantee that interference will not occur in a particular installation. If this equipment does cause harmful interference to radio or television reception, which can be determined by turning the equipment off and on, the user is encouraged to try to correct the interference by one or more of the following measures:

- Reorient or relocate the receiving antenna.
- Increase the separation between the equipment and receiver.
- Connect the equipment into an outlet on a circuit different from that to which the receiver is connected.
- Consult the dealer or an experienced radio/TV technician for help.

INDUSTRY CANADA (ICES-003):

This Class B digital apparatus complies with Canadian ICES-003.

Cet appareil numérique de la classe B est conforme à la norme NMB-003 du Canada.

PRODUCT DISPOSAL:

The Product contains small amounts of tin, lead and/or mercury. Disposal of these materials may be regulated due to environmental considerations.

IMPORTANT RECYCLE INSTRUCTIONS



Lamp(s) inside this product contain mercury. This product may contain other electronic waste that can be hazardous if not disposed of properly. Recycle or dispose in accordance with local, state, or federal Laws.

For more information, contact the Electronic Industries Alliance at WWW.EIAE.ORG.

For lamp specific disposal information check WWW.LAMPRECYCLE.ORG.

DISPOSAL OF OLD ELECTRICAL AND ELECTRONIC EQUIPMENT (Applicable throughout the European Union and other European countries with separate collection programs)



This symbol found on your product or on its packaging, indicates that this product should not be treated as household waste when you wish to dispose of it. Instead, it should be handed over to an applicable collection point for the recycling of electrical and electronic equipment. By ensuring this product is disposed of correctly, you will help prevent potential negative consequences to the environment and human health, which could otherwise be caused by inappropriate disposal of this product. The recycling of materials will help to conserve natural resources. This symbol is only valid in the European Union. If you wish to discard this product, please contact your local authorities or dealer and ask for the correct method of disposal.

Table of Contents

RuncoCare™ Standard Two Year Limited Warranty	iii
Important Safety Instructions	vii
Compliance Information	ix
1. Introduction	1
About This Manual	1
Target Audience	1
If You Have Comments About This Manual.....	1
Textual and Graphic Conventions	1
Using This Manual	2
Description, Features and Benefits	3
Key Features and Benefits	4
Parts List	4
2. System Overview	5
Projector	6
LS-12HBd Rear Panel	9
DC-300 Dimension Digital Controller	10
Front Panel Layout.....	10
Rear Panel Layout	12
LS-12HBd Remote Control Unit	14
3. Installation	19
Remote Control	19
Notes on Batteries	19
Notes on Remote Control Operation	19
Quick Setup	20
Installation Considerations	21
Pre-Wiring for 3D: Run Dual HDMI Cables	21
Installation Type.....	21
Ambient Light	21
Throw Distance.....	22
Vertical and Horizontal Position.....	23
Vertical and Horizontal Lens Shift.....	24
Folded Optics	26
Audio/Video Synchronization Issues.....	27

Other Considerations	27
Installing the Optional Anamorphic Lens Mount	28
Package Contents	28
Mounting the LS-12HBd	33
Floor Mounting (Upright)	33
Ceiling Mounting (Inverted).....	33
Installing the Projector in an Enclosure.....	33
Adjusting the Projection Angle	34
Mounting the Dimension Digital Controller	35
System Interconnections	36
Connecting the Dimension Digital Controller to the Projector.....	36
Connecting an Audio Processor or Secondary Display Device to the Dimension Digital Controller (Optional)	38
Additional Connections to the Dimension Digital Controller (Optional).....	39
Connecting Source Components to the Dimension Digital Controller	43
Connecting the Active 3D Emitter to the Dimension Digital Controller.....	49
Connecting to AC Power	49
Turning on the Power	50
Primary Lens Adjustments: Focus, Zoom and Position	51
Focus	51
Zoom.....	51
Vertical and Horizontal Lens Shift.....	51
Adjusting the Picture Orientation	51
Adjusting the Image Geometry	52
Installing and Adjusting the Anamorphic Lens	54
4. Operation	57
Using the On-Screen Menus	57
Main Menu.....	59
Input Source	59
Aspect Ratio	60
Screen.....	62
Picture	63
Input Position.....	68
Memory Presets	70
3D Processing	71
Sleep Timer	72
Information	72

Calibration	73
Service	81
Using the 3D Glasses	94
Key Features.....	94
Functional Overview.....	94
Charging the Battery.....	95
Turning On the Glasses	96
Auto Power-Off.....	96
5. Maintenance and Troubleshooting	97
Lamp Replacement	97
Troubleshooting Tips	98
6. External Control	101
Serial Communications	101
RS-232 Connection and Port Configuration	101
Command Format	101
Response Format	102
Command and Response Examples.....	103
Serial Command List.....	103
Using Discrete IR Codes	117
IR Command Protocol	117
IR Command List (Standard Mode).....	118
IR Command List (Extended Mode)	121
Using HDMI CEC Messages	122
CEC Command List.....	122
7. Specifications	125
LS-12HBd Projector Specifications	125
Dimension Digital Controller Specifications	127
Supported Timings	129
LS-12HBd Dimensions	133

Notes:

List of Figures

2-1. LightStyle™ Series LS-12HBd Active 3D Projection System Block Diagram	5
2-2. LS-12HBd Front/Side View	6
2-3. LS-12HBd Rear/Bottom/Top View	8
2-4. LS-12HBd Rear Panel	9
2-5. Dimension Digital Controller Front Panel	10
2-6. DC-300 Dimension Digital Controller Rear Panel.....	12
2-7. Dimension Digital Controller Remote Control Unit for LS-12HBd.....	14
3-1. Estimating Throw Distance	22
3-2. Projector Placement	24
3-3. Vertical Lens Shift (EXAMPLE ONLY)	24
3-4. Horizontal Lens Shift (EXAMPLE ONLY).....	25
3-5. Folded Optics.....	26
3-6. Mounting Angle Ranges (Front-to-Back and Side-to-Side).....	34
3-7. Attaching the Rack Mounting Hardware	35
3-8. RS-232 Connection from the Dimension Digital Controller to the Projector	36
3-9. Connecting the Dimension Digital Controller to the Projector	37
3-10. Audio Processor Connection to Dimension Digital Controller	38
3-11. RS-232 Control System Connection to Dimension Digital Controller	39
3-12. Connecting 12-volt Trigger Outputs.....	40
3-13. External IR Receiver Connection.....	41
3-14. Ethernet Network Connection to Dimension Digital Controller.....	42
3-15. DisplayPort Source Connection	43
3-16. HDMI Source Connections	44
3-17. Component Video Source Connections.....	45
3-18. RGBHV Source Connections.....	46
3-19. SCART RGBS Source Connections.....	47
3-20. Composite Video Source Connections	48
3-21. Active 3D Emitter Connection.....	49
3-22. Keystone and Pincushion Distortion	52
3-23. Image Alignment Controls	53
3-24. Attaching the Anamorphic Lens to the Lens Mount	54
4-1. LS-12HBd OSD Menu Structure	57
4-2. Typical PLUGE Pattern for Adjusting Brightness	64
4-3. Typical Gray Bar Pattern for Adjusting Contrast.....	65

4-4. Typical Color Bar Pattern for Adjusting Color Saturation and Tint.....	65
4-5. Typical Test Pattern for Adjusting Sharpness.....	67
4-6. Overscan Modes	69
4-7. CIE 1931 Chromaticity Diagram	74
6-1. NEC Protocol Message Format	117
7-1. LS-12HBd Dimensions	133

1. Introduction

This Owner's Manual describes how to install, set up and operate the Runco LightStyle™ Series LS-12HBd Active 3D Projection System.

Throughout this manual, the Runco LightStyle™ Series LS-12HBd Active 3D Projection System is referred to as the "LS-12HBd."

Runco has prepared this manual to help installation personnel and end users get the most out of the LS-12HBd.

Runco has made every effort to ensure that this manual is accurate as of the date it was printed. However, because of ongoing product improvements and customer feedback, it may require updating from time to time. You can always find the latest version of this and other Runco product manuals on-line, at www.Runco.com.

Runco welcomes your comments about this manual. Send them to support@Runco.com.

Text Conventions: The following conventions are used in this manual, in order to clarify the information and instructions provided:

- Remote and built-in keypad button identifiers are set in upper-case bold type; for example, "Press **EXIT** to return to the previous menu."
- Computer input (commands you type) and output (responses that appear on-screen) is shown in monospace (fixed-width) type; for example: "To change the aspect ratio to Letterbox, type `LETTERBOX <Enter>`."
- All keys with functional names are initial-capped, set in bold type and enclosed in angle brackets. These keys are the following: **<Enter>**, **<Spacebar>**, **<Control>**, **<Esc>** and **<Tab>**.
- **<Enter>** indicates that you may press either the RETURN or ENTER key on your keyboard if it has both keys.

In addition to these conventions, underlining, boldface and/or italics are occasionally used to highlight important information, as in this example:



Note

*A carriage return **must** be used after each command or string.*

1.1 About This Manual

◀ Target Audience

◀ If You Have Comments About This Manual...

◀ Textual and Graphic Conventions

Graphic Conventions: These symbols appear in numerous places throughout the manual, to emphasize points that you must keep in mind to avoid problems with your equipment or injury:



Tip

TIPS highlight time-saving short cuts and helpful guidelines for using certain features.



Note

NOTES emphasize text with unusual importance or special significance. They also provide supplemental information.



Caution

CAUTIONS alert users that a given action or omitted action can degrade performance or cause a malfunction.



WARNING

WARNINGS appear when a given action or omitted action can result in damage to the equipment, or possible non-fatal injury to the user.



DANGER!

DANGER appears when a given action can cause severe injury or death.

1.2 Using This Manual

Use the following table to locate the specific information you need in this manual.

If you need...	... Turn to page:
Information about obtaining service	iv
General information about the LightStyle™ Series LS-12HBd Active 3D Projection System	3
Installation instructions	19
First-time configuration instructions	51
Advanced configuration instructions	73
Troubleshooting tips	98
Specifications for the LightStyle™ Series LS-12HBd Active 3D Projection System	125

Runco's LightStyle™ Series LS-12HBd Active 3D Projection System delivers exceptional 3D and 2D performance, sharing many of the technical attributes of the award-winning LightStyle™ projector series. The LS-12HBd combines a powerful, three-chip DLP® engine and a wide array of lens options with Runco's elegant LightStyle chassis design. With the addition of the LS-12HBd to Runco's 3D projection offerings, clients now have a variety of exceptional 3D options to choose from based on their individual needs.

The LS-12HBd is a high-bright DLP® projector that delivers stunning, flawless video at a scale unattainable by other display types, opening up new projector possibilities in the home and excelling outside of the dedicated home theater, where environmental factors such as lighting are not easily controlled.

Custom paint and print options with a myriad of color options are available with the LS-12HBd, including an option to design your own one-of-a-kind projector with Runco FinishPalette™. Beyond beautiful on the outside, the Runco LS-12HBd is feature-rich, including advanced connectivity and the latest-generation video processing and scaling. Rounding out this impressive projector are discrete input source, aspect ratio and power on/off, as well as an RS-232 interface for seamless integration with automation control systems.

Impressive and unique and unlike single-chip DLP implementations, no color wheel is used in the LS-12HBd projectors. Instead, it harnesses the power of three advanced full 1080p HD 16:9 DMD's™ and 12-degree mirror tilt for the finest black level performance. The impressive brightness is further bolstered by the improved contrast capabilities of the stylish LS-12HBd. Designed to excel in both the dedicated theater as well "Flex-Theaters," spaces where big screen entertainment is only a portion of the room's purpose and aesthetics and placement are as crucial as video performance.

For uncompromised widescreen reproduction of movies originally filmed in the CinemaScope™ 2:35:1 format, the LS-12HBd can also be paired with one of Runco's award-winning anamorphic lens solutions. Through an ingenious combination of software, electronics and precision anamorphic optics, the Runco anamorphic lens system maintains constant image height on the screen just as in a movie theater. When a viewer transitions from 1.78:1 (16:9) program material to superwide 2.35:1, the image simply gets wider while image height is maintained. The projection system is able to use the full pixel array, thereby producing a 2.35:1 image with enhanced resolution and increased brightness. No resolution or image area is lost to those black bars that contain no picture information.

**Note**

An anamorphic lens requires the use of a 2.35:1 (or similar aspect ratio), "superwide" format screen.

1.3 Description, Features and Benefits

- Key Features and Benefits** ➤ The LS-12HBd offers these key features and benefits:
- Native Resolution: 1920 x 1080 (16:9 Native Aspect Ratio)
 - Three-chip Digital Light Processing (DLP™) system
 - DisplayPort 1.1a Input (on Dimension Digital Controller) with High-bandwidth Digital Content Protection (HDCP)
 - Eight (8) HDMI Inputs (on Dimension Digital Controller) with HDCP, 3D and Deep Color
 - CinOptx™ *Proteus* lens options for stunning sharpness and throw distance flexibility
 - Bundled with two years of Runco PremierCare™ service program providing on-site calibration and two years of ongoing support from Runco

Parts List ➤ Your LS-12HBd is shipped with the following items. If any items are missing or damaged, please contact your Runco dealer or Runco Customer Service at (800) 23RUNCO.

- LightStyle™ Series LS-12HBd Active 3D Projection System:
 - Projection Unit
 - Dimension Digital Controller unit
- Remote Control Unit and batteries
- AC Power Cords (2)
- RJ-11 Telephone Cable, 50 feet (15.24 meters)
- Serial Port Adapter, RJ-11 Female to DB-9 Male
- Active 3D Emitter and projector interface cable, 3.28 feet (1.0 meters)
- Active 3D Glasses (3 pairs)
- HDMI-to-HDMI Cables (2), sold separately (refer to **Optional Accessories**, below)
- Rack-mount hardware for the Dimension Digital Controller
- Runco LS-12HBd Quick Setup Guide

Optional Accessories:

- Secondary anamorphic lens and lens mount
- Replacement Lamp (part number 997-5268-00)
- Ceiling mount kit (part number 997-4214-00)
- HDMI-to-HDMI Cable, length specified at time of order:
 - 16.4 feet (5.0 meters) (part number 903-1010-00)
 - 24.6 feet (7.5 meters) (part number 903-1011-00)
 - 32.8 feet (10.0 meters) (part number 903-1012-00)
 - 49.2 feet (15.0 meters) (part number 903-1013-00)
 - 65.6 feet (20.0 meters) (part number 903-1014-00)

2. System Overview

A LightStyle™ Series LS-12HBd Active 3D Projection System consists of the following components:

- The projector (equipped with dual digital video inputs) with optional anamorphic lens and lens transport assembly.
- The DC-300 Dimension Digital Controller™ unit that provides “left-eye” and “right-eye” video signals and the on-screen display (OSD) menu to the projector. In addition, the Dimension Digital Controller controls the projector in response to user input via its infrared (IR) remote control unit or front-panel keypad, an external control system or HDMI Consumer Electronics Control (CEC) messages.
- An Active 3D Emitter that receives a left/right synchronization signal from the projector and transmits it to the Active 3D Glasses worn by the viewers. This signal precisely controls when left and right fields are visible through the glasses.

Figure 2-1 shows how these components connect to and interact with each other. The following sections describe each one in detail.

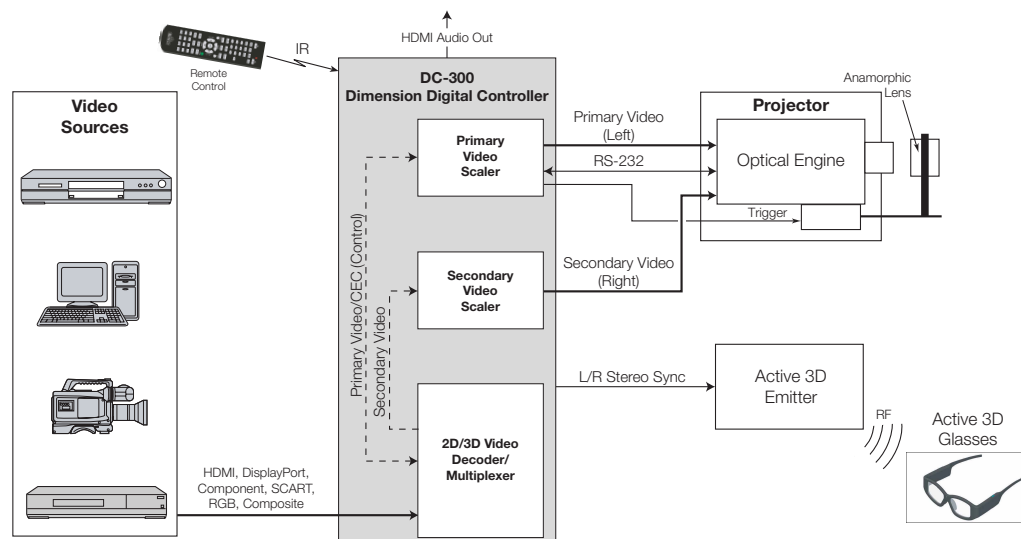

Figure 2-1. LightStyle™ Series LS-12HBd Active 3D Projection System Block Diagram

2.1 Projector

A LightStyle™ Series LS-12HBd Active 3D Projection System can display both traditional 2D and stereoscopic 3D video content.

An active 3D presentation requires a specialized video signal source configuration and content to be displayed correctly. Images from a stereo 3D video source consist of a series of images (called **frames** or **fields**) that alternate quickly between two slightly different view points, corresponding to a viewer's left and right eyes.

When these frames are displayed fast enough and viewed with special stereo glasses synchronized to the left/right changes, the resulting image appears with the same depth and perspective that is sensed in the real world.

Figure 2-2 and Figure 2-3 show the key LS-12HBd components.

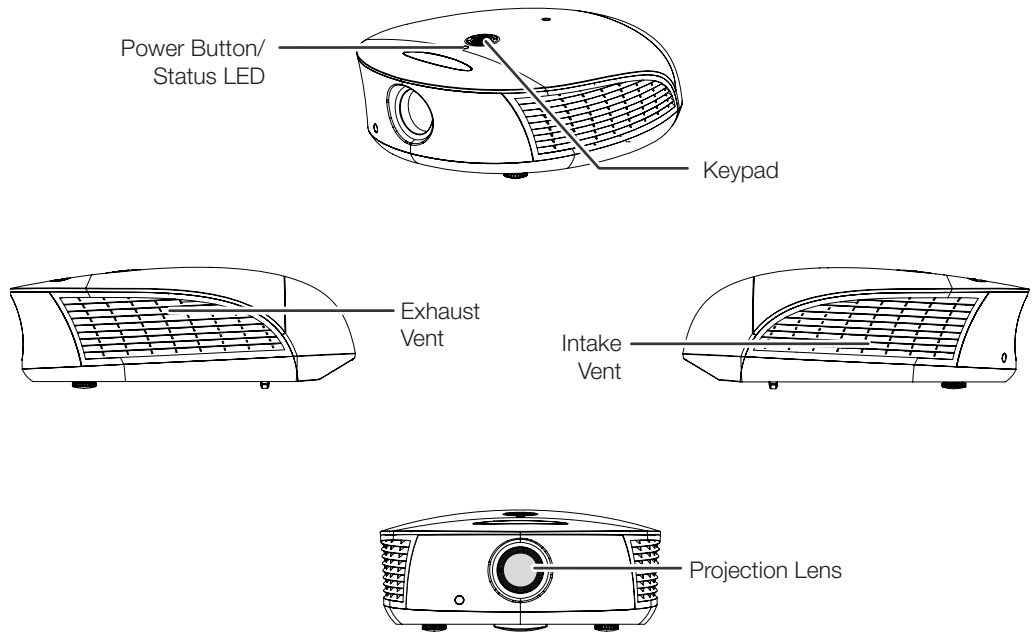

Figure 2-2. LS-12HBd Front/Side View



- **POWER BUTTON/STATUS LED**

Indicates projector status as follows:

- Solid green = AC power present, ready to turn on (lamp not lit)
- Flashing green = lamp is warming up or cooling down; keypad functions not allowed
- Off = Lamp lit, projector functioning normally
- Alternating green/red = Lamp problem (door open, unable to strike, end of life), user intervention likely to fix problem
- Flashing red = Over temperature, user intervention (clear vents, turn on AC) may fix problem
- Solid red = Error that requires servicing (fan fail, Power-on self-test fail etc.)

- **KEYPAD**

Provides an alternative to using the remote control unit to perform primary lens adjustments (focus, zoom and position).

- **FOCUS, H/V, ZOOM**

Use these buttons to select the type of lens adjustment you wish to make. The default function (following a power cycle) is **FOCUS**.

- **Cursor Buttons (▲, ◀, ▼, ▶)**

Use these buttons to perform the selected lens adjustment. These buttons operate as follows:

- When adjusting focus, the up (▲) or left (◀) button focuses closer; the down (▼) or right (▶) button focuses farther.
 - When adjusting zoom, the up (▲) or left (◀) button zooms in (enlarges the projected image); the down (▼) or right (▶) button zooms out (makes the projected image smaller).
 - When adjusting lens position (H/V), the cursor buttons move the image in the specified direction, assuming the projector is upright. If the projector is inverted (ceiling-mounted), the cursor button functions are reversed.

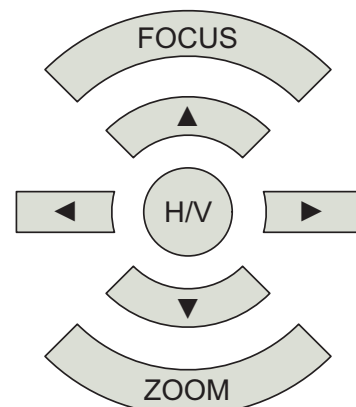

- **EXHAUST VENT**

Warm air exits the projector through this vent. Ensure that it is not blocked.

- **INTAKE VENT**

Internal fans draw cool air into the projector through this vent.

- **PROJECTION LENS**

If needed, a light shield accessory is provided with the lens to minimize stray light emissions. (Use it only when the vertical offset is 50% of the screen height or greater.) The light shield attaches to the end of the lens.

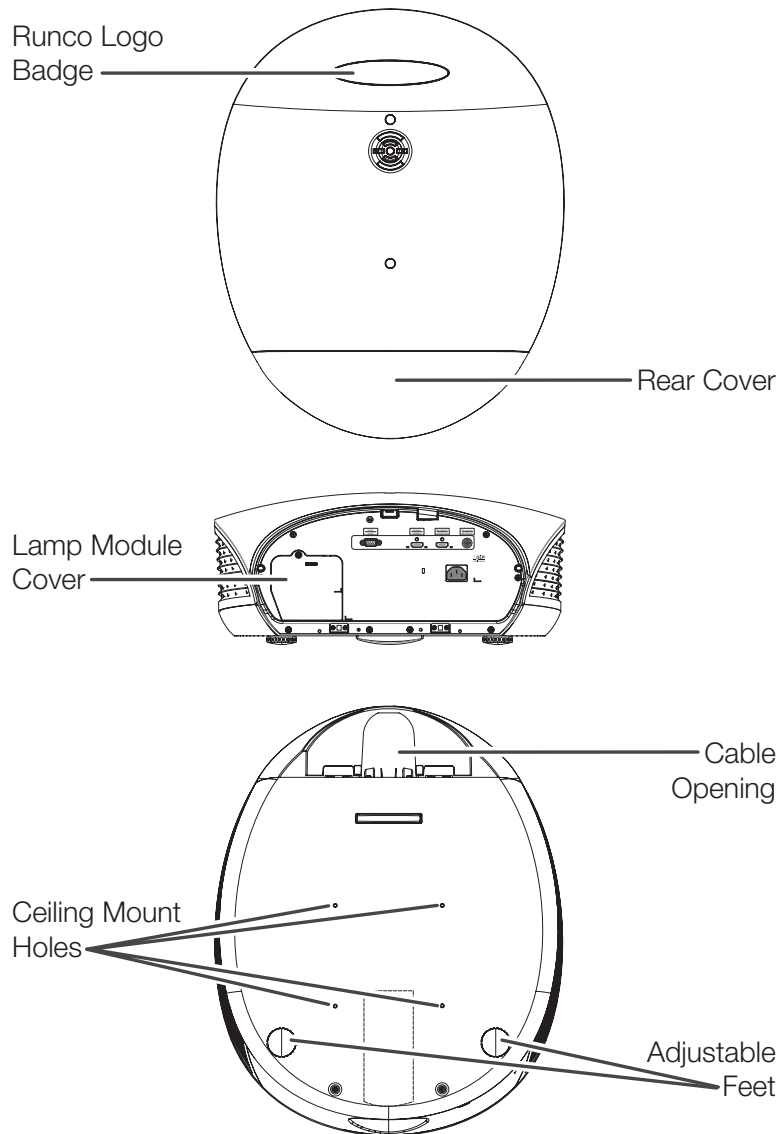

Figure 2-3. LS-12HBd Rear/Bottom/Top View

- **RUNCO LOGO BADGE**
- **REAR COVER**
Remove to access connectors.
- **LAMP MODULE COVER**
Remove this cover to access the lamp compartment.
- **CABLE OPENING**
Pass cables through this opening.
- **CEILING MOUNT HOLES**
Use these to attach the ceiling bracket to the projector. Use M4 screws with a maximum screw depth of 10 mm (0.39 inch).
- **ADJUSTABLE FEET**
Use these when the projector is installed in a table-top configuration to level the image and/or adjust the projection angle.

Figure 2-4 shows the LS-12HBd rear panel.

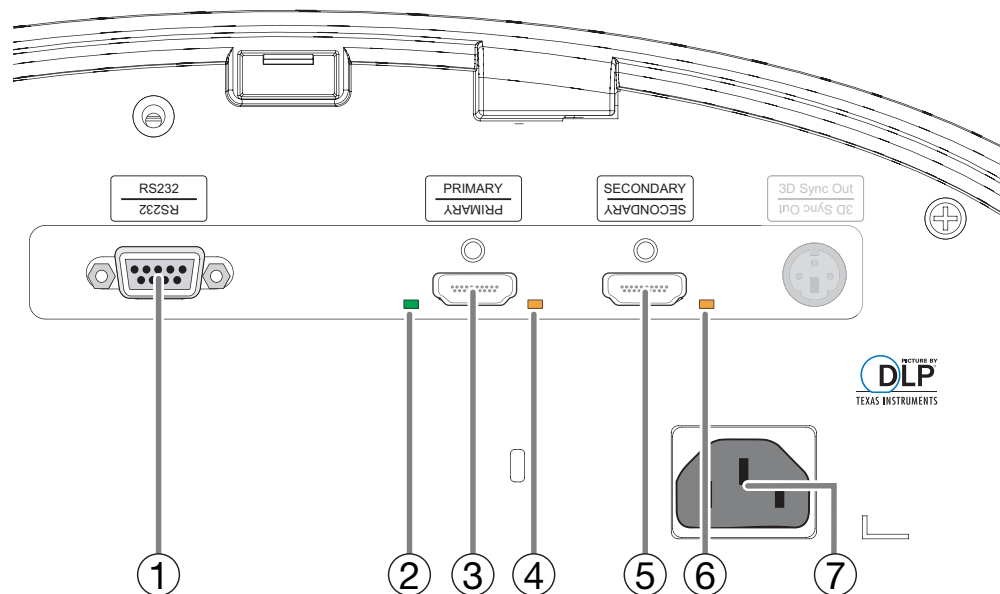

Figure 2-4. LS-12HBd Rear Panel

1. RS232 (Control)

A female, 9-pin D-sub connector that provides a serial communication link to the Dimension Digital Controller, via its **Pri. Display Control** output (see Figure 2-6).

2. 3D LED

Lights green when the projector is displaying 3D content.

3. PRIMARY VIDEO INPUT

Connect the **HDMI Out To Primary Display** connector from the Dimension Digital Controller to this input (see Figure 2-6).

4. PRIMARY SOURCE LED

Lights amber when the projector detects a valid primary video signal from the Dimension Digital Controller.

5. SECONDARY VIDEO INPUT

Connect the **HDMI Out To Sec. Display** connector from the Dimension Digital Controller to this input (see Figure 2-6).

6. SECONDARY SOURCE LED

Lights amber when the projector detects a valid secondary video signal from the Dimension Digital Controller.

7. POWER INPUT (100 to 240 VAC)

Connect the LS-12HBd to power here.

2.2 LS-12HBd Rear Panel

2.3 DC-300 Dimension Digital Controller

The Dimension Digital Controller provides “left-eye” and “right-eye” video signals and the OSD menu to the projector. It controls the other system components in response to user input via the following interfaces:

- Front-panel keypad
- IR remote control unit
- HDMI CEC messages
- RS-232 serial commands
- Ethernet

Front Panel Layout ➤

Figure 2-5 shows the controls and indicators on the Dimension Digital Controller front panel; the paragraphs that follow describe them.

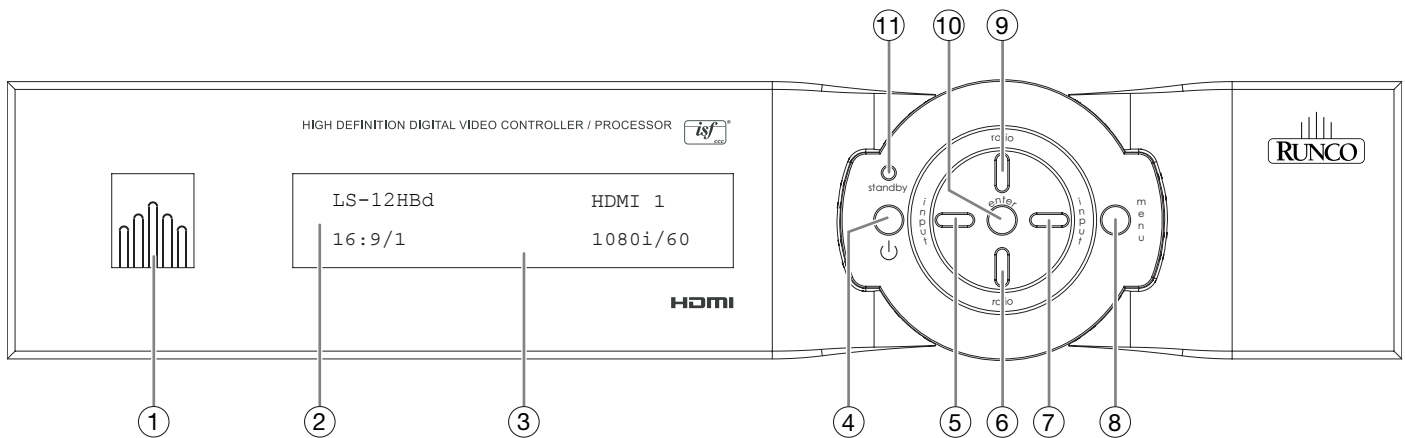

Figure 2-5. Dimension Digital Controller Front Panel

1. **RUNCO ICON**
Lights blue to indicate that the controller is on or powering up.
2. **IR SENSOR**
Receives IR commands from the remote control.
3. **VACUUM FLUORESCENT DISPLAY**
Can be used instead of the On-Screen Display (OSD). Displays currently-selected menu or – if no menu is selected – the connected display device model, current source, input resolution and aspect ratio/screen.
4. **ON/STANDBY BUTTON**
Press once to toggle from standby mode to on mode. Press it again to return to standby mode. For a discrete on or off command, you can use the direct access buttons on the remote control.
5. **LEFT BUTTON**
Used to direct-select inputs or move the menu cursor left in the OSD. When no menu is present on-screen, the **LEFT** button toggles through the different sources, in this order:
DisplayPort - HDMI 8 - HDMI 7 - HDMI 6 - HDMI 5 - HDMI 4 - HDMI 3 - HDMI 2 - HDMI 1 - SCART - HD 2 - HD 1 - Component - Composite 3 - Composite 2 - Composite 1

6. DOWN BUTTON

Use to direct-select aspect ratios or move the menu cursor down in the OSD. When no menu is present on-screen, this button toggles through aspect ratios in the following order:

16:9 - 4:3 - Letterbox - VirtualWide - Cinema - Virtual Cinema - Native

7. RIGHT BUTTON

Used to direct-select inputs or move the menu cursor right in the OSD. When no menus are present on-screen, the **RIGHT** button toggles through the different sources, in this order:

Composite 1 - Composite 2 - Composite 3 - Component - HD 1 - HD 2 - SCART - HDMI 1 - HDMI 2 - HDMI 3 - HDMI 4 - HDMI 5 - HDMI 6 - HDMI 7 - HDMI 8 - DisplayPort

8. MENU BUTTON

Press the **MENU** button to bring up the main menu, or to exit the current menu and return to the previous one.

9. UP BUTTON

Use to direct-select aspect ratios or move the menu cursor up in the OSD. When no menus are present on-screen, the **UP** button toggles through aspect ratios in the following order:

Native - Virtual Cinema - Cinema - VirtualWide - Letterbox - 4:3 - 16:9

10. ENTER BUTTON

When an item is highlighted on the OSD, the **ENTER** button selects the item.

11. STANDBY LED

Lights amber when the Dimension Digital Controller is in standby mode; otherwise it is off.

Rear Panel Layout ➤ Figure 2-6 shows the rear connector panel on the Dimension Digital Controller.

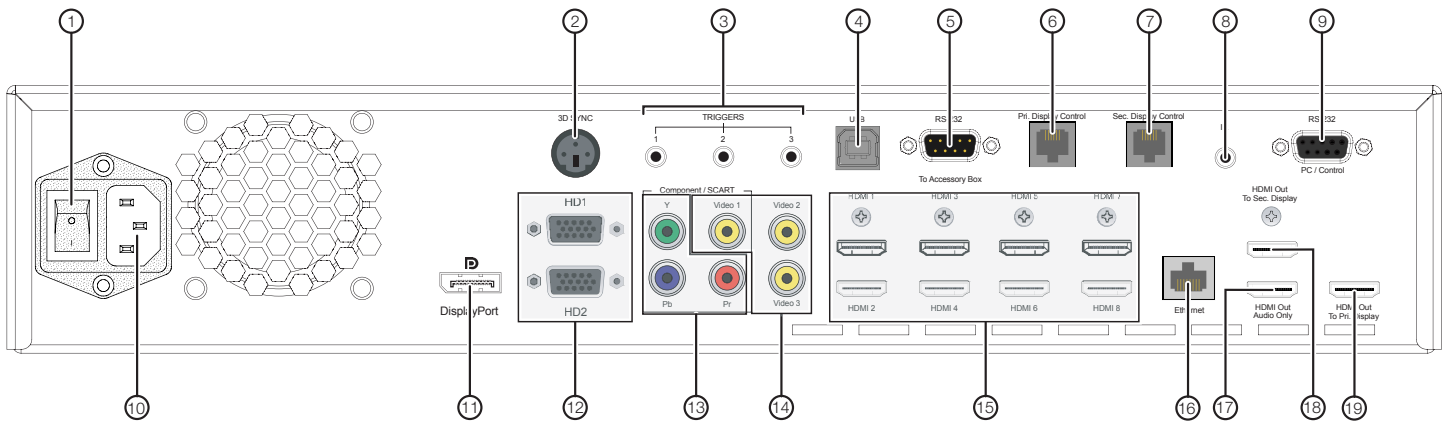

Figure 2-6. DC-300 Dimension Digital Controller Rear Panel

1. **MAIN POWER SWITCH**
Disconnects or applies power to the Dimension Digital Controller.
2. **3D Sync Out**
A 3-pin, VESA standard mini-DIN connector for connecting the Runco Active 3D Emitter to the Dimension Digital Controller.
3. **TRIGGERS**
Connection for up to three (3), 12-volt trigger-controlled devices such as retractable screens or screen masks. Output current is limited to 250 milliamperes (mA).
4. **USB**
A standard, USB Series “B” connection to a personal computer, for performing software upgrades and other service procedures.
5. **RS-232 (To Accessory Box)**
Reserved for future use.
6. **Pri. Display Control**
Connect this to the RS-232 input on the projector.
7. **Sec. Display Control**
Not used.
8. **IR**
Wired input from a Niles- or Xantech-compatible, infrared (IR) repeater system. It is a 3.5-mm, mini phono jack, wired as follows:
Ring = No connection
Tip = IR Input
Sleeve = Ground
9. **RS-232 (PC / Control)**
A female, 9-pin D-sub connector for interfacing with a PC or automation/control system.
10. **POWER INPUT (100 to 240 VAC)**
Connect the Dimension Digital Controller to power here.

11. DisplayPort

DisplayPort 1.1a and DisplayPort-HDCP 1.1 compliant, SD/HD input for connecting SDTV, EDTV or HDTV component video sources.

12. HD1 / HD2 In (15-pin VGA)

Two inputs for connecting standard-definition (SD = 480i/576i), enhanced-definition (ED = 480p/576p) or high-definition (HD = 720p/1080i/1080p) component video sources, or RGBHV sources such as personal computers.

13. Component / SCART In (3 x RCA connectors)

SD/HD input for connecting SDTV, EDTV or HDTV component video sources. Also provides RGB input for SCART RGBS sources.

14. Video 1 / Video 2 / Video 3 In

Standard, composite video inputs for connecting a VCR, camcorder or other composite video source. The Video 1 input also provides composite sync input for SCART RGBS sources.

15. HDMI 1 ... HDMI 8 In (Digital)

Eight (8), HDCP-compliant digital video inputs for connecting HDMI or DVI sources.

16. Ethernet

A female RJ-45 connector for wired network communications.

17. HDMI Out (Audio Only)

Connect this output to an audio control system to pass through HDMI audio.

**Note**

The Dimension Digital Controller does not transmit HDMI CEC control messages from the "HDMI Audio Out" connector.

18. HDMI Out (To Secondary Display)

Connect this to the SECONDARY video input on the projector.

19. HDMI Out (To Primary Display)

Connect this to the PRIMARY video input on the projector.

2.4 LS-12HBd Remote Control Unit

Figure 2-7 shows the LS-12HBd remote control, and the paragraphs that follow describe its functionality.



Note

The LS-12HBd remote control unit supports an “extended” key code mode that allows certain buttons to perform alternate functions. The following list identifies those buttons that have both standard and extended-mode functions.

For more information, refer to **Remote Control** on page 83 and **IR Command List (Extended Mode)** on page 121.

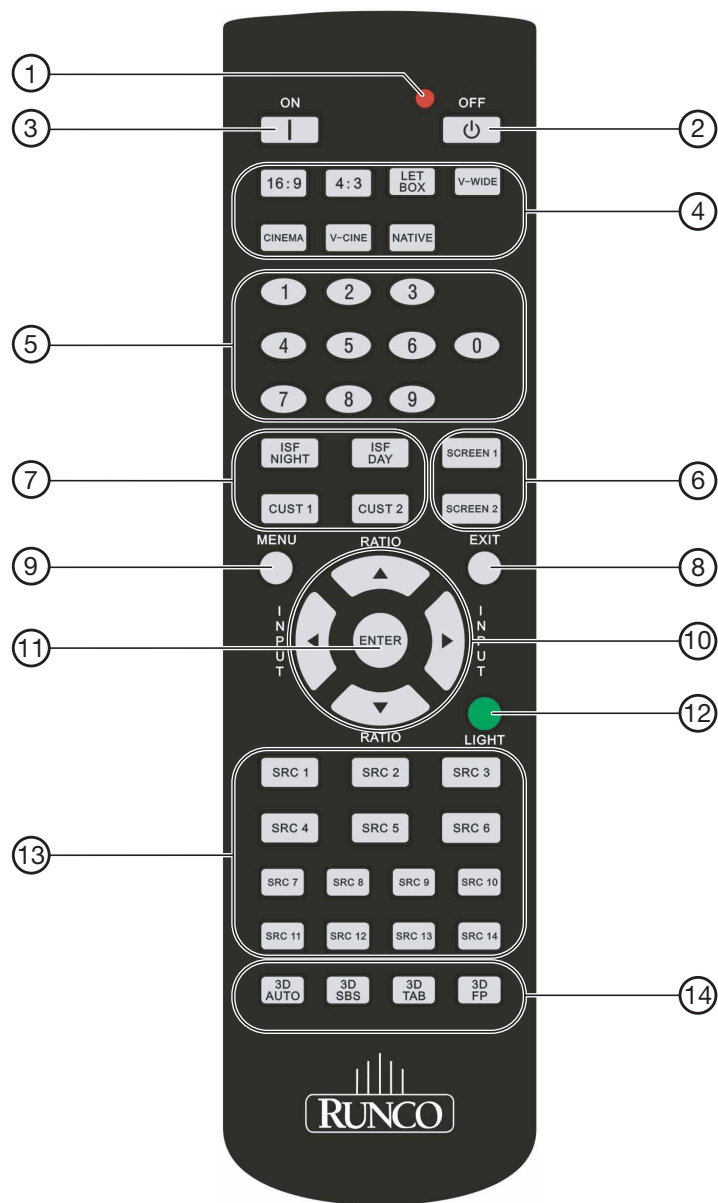

Figure 2-7. Dimension Digital Controller Remote Control Unit for LS-12HBd

1. IR OUTPUT INDICATOR

Lights when a button is pressed to indicate that an IR signal is being transmitted.

2. OFF (Standard) / Sleep Timer = 30 Minutes (Extended)

Press to turn off the Dimension Digital Controller and projector. In extended mode, press to set the Sleep Timer to 30 minutes.

3. ON (Standard) / Sleep Timer = Off (Extended)

Press to turn on the Dimension Digital Controller and projector. In extended mode, press to disable the Sleep Timer.

4. Aspect Ratio Selection Buttons

Use these buttons to select an aspect ratio directly, as follows:

16:9 (Standard) / Sleep Timer = 60 Minutes (Extended)

For viewing 16:9 DVDs or HDTV programs in their native aspect ratio. In extended mode, press to set the Sleep Timer to 60 minutes.

4:3 (Standard) / Sleep Timer = 90 Minutes (Extended)

Scales the input signal to fit 4:3 display mode in the center of the screen. In extended mode, press to set the Sleep Timer to 90 minutes.

LETBOX (Letterbox - Standard) / Sleep Timer = 2 Hours (Extended)

For viewing non-anamorphic ("full-screen") DVDs on a 16:9 screen. In extended mode, press to set the Sleep Timer to 2 hours.

V-WIDE (VirtualWide - Standard) / Sleep Timer = 4 Hours (Extended)

Enlarges a 4:3 image horizontally in a non-linear fashion to fit 16:9 full screen display. In extended mode, press to set the Sleep Timer to 4 hours.

CINEMA (Standard) / Video 1 Input (Extended)

For viewing 2.35:1 source material. In extended mode, press to select the Video 1 (Composite 1) input.

V-CINE (Standard) / Component Input (Extended)

Selects the Virtual Cinema aspect ratio, used for viewing 16:9 source material on a 2.35:1 screen. In extended mode, press to select the Component input.

NATIVE (Standard) / HD 1 Input (Extended)

Displays the source signal in its native resolution, centered in the display area. In extended mode, press to select the HD 1 input.

5. **Numeric Buttons (Standard)**

Use these buttons to enter numeric characters (0 ... 9), such as when changing remote control codes (refer to **Remote Control** on page 83).

Numeric Buttons (Extended)

In extended mode, press a numbered button to select a video source, as follows:

Remote Control Button	Source Assignment in Extended Key Code Mode
1	HD 2
2	HDMI 1
3	HDMI 2
4	HDMI 3
5	HDMI 4
6	HDMI 5
7	HDMI 6
8	HDMI 7
9	HDMI 8
0	DisplayPort

6. **SCREEN 1 (Standard) / Video 3 Input (Extended) SCREEN 2**

Use these buttons to select a screen profile. For more information, refer to **Screen** on page 62.

In extended mode, press **SCREEN 1** to select the Video 3 (Composite 3) input.

7. **Memory Preset Buttons:**

ISF NIGHT (Standard) / SCART (Extended)

Press to recall settings for the current input from the "ISF Night" memory preset. In extended mode, press to select the SCART input.

ISF DAY (Standard) / Video 2 (Extended)

Press to recall settings for the current input from the "ISF Day" memory preset. In extended mode, press to select the Video 2 (Composite 2) input.

CUST 1 (Standard) / 3D Mode = Off (Extended)

Press to recall settings for the current input from the "Custom 1" memory preset. In extended mode, press to set the 3D Mode to Off (for 2D content).

CUST 2

Press to recall settings for the current input from the "Custom 2" memory preset.

8. **EXIT**

Press this button to exit the current menu and return to the previous one.

9. **MENU**

Press this button to access the OSD controls, or to exit the current menu and return to the previous one.

10. Cursor Buttons (▲, ◀, ▼, ▶)

Use these buttons to select items or settings, adjust settings or switch display patterns.

When no menu is present on-screen, the **UP** and **DOWN** buttons toggle through the available aspect ratios, in this order:

UP Button = Native - Virtual Cinema - Cinema - VirtualWide - Letterbox - 4:3 - 16:9

DOWN Button = 16:9 - 4:3 - Letterbox - VirtualWide - Cinema - Virtual Cinema - Native



Note

For more information about aspect ratios, refer to Table 4-1.

Likewise, the **LEFT** and **RIGHT** buttons toggle through the different source inputs, in this order:

LEFT Button = DisplayPort - HDMI 8 - HDMI 7 - HDMI 6 - HDMI 5 - HDMI 4 - HDMI 3 - HDMI 2 - HDMI 1 - SCART - HD 2 - HD 1 - Component - Composite 3 - Composite 2 - Composite 1

RIGHT Button = Composite 1 - Composite 2 - Composite 3 - Component - HD 1 - HD 2 - SCART - HDMI 1 - HDMI 2 - HDMI 3 - HDMI 4 - HDMI 5 - HDMI 6 - HDMI 7 - HDMI 8 - DisplayPort

11. ENTER

Press to select a highlighted menu item or confirm a changed setting.

12. LIGHT

Press to illuminate the buttons.

13. SRC 1, SRC 2 ... SRC 14

Use these buttons to select a video source. You can assign each button to any source you wish. By default, these buttons are assigned as follows:

Remote Control Button	Default Source Assignment
SRC 1 ... SRC 8	HDMI 1 ... HDMI 8
SRC 9	DisplayPort
SRC 10	Component
SRC 11	HD 1
SRC 12	HD 2
SRC 13	Composite 1
SRC 14	Composite 2

For instructions on how to change these assignments, refer to **SRC 1-7 Keys / SRC 8-14 Keys** on page 84.

14. **3D Mode Selection Buttons:**

3D AUTO

Press to set the 3D Mode to **Auto**.

3D SBS (Side-by-Side)

Press to set the 3D Mode to **3D Side-by-Side**.

3D TAB (Top-and-Bottom)

Press to set the 3D Mode to **3D Top-and-Bottom**.

3D FP (Frame Packing)

Press to set the 3D Mode to **3D Frame Packing**.



Note

*For more information about 3D modes, refer to **3D Mode** on page 71.*

3. Installation

**Note**

Installation **must** be performed by a qualified custom video installation specialist.

To install batteries in the remote control:

1. Press down the tab on the cover and pull the cover in the direction of the arrow.
 2. Insert the included batteries. Ensure that the polarities correctly match the ⊕ and ⊖ markings inside the battery compartment.
 3. Insert the lower tab of the cover into the opening, and press down the cover until it clicks in place.
- Make sure that the battery polarities are correct when installing the batteries.
 - Do not mix an old battery with a new one or different types of batteries.
 - If you will not use the remote control for a long time, remove the batteries to avoid damage from battery leakage.
 - Do not expose batteries to excessive heat such as from sunshine, fire or the like.
 - Make sure that there is nothing obstructing the infrared beam between the remote control and the IR receiver on the Dimension Digital Controller.
 - If the effective range of the remote control decreases, or it stops working, replace the batteries with new ones.
 - The remote control may fail to operate if the infrared remote sensor is exposed to bright sunlight or fluorescent lighting.
 - Ambient conditions may possibly impede the operation of the remote control. If this happens, point the remote control at the Dimension Digital Controller, and repeat the operation.

3.1 Remote Control

◀ Notes on Batteries**◀ Notes on Remote Control Operation**

3.2 Quick Setup

Table 3-1 gives a quick overview of the LS-12HBd installation process. The sections following this one provide detailed instructions.

Table 3-1. Installation Overview

Step	Procedure	For Details, Refer to page...
1	Choose a location for the projector	21
2	Install anamorphic lens mounting assembly (optional)	28, 40
3	Mount the projector	33
4	Mount the Dimension Digital Controller	35
5	Connect the Dimension Digital Controller to the projector	36
6	Connect other external equipment to Dimension Digital Controller (optional): <ul style="list-style-type: none"> • Audio processor or secondary display device • Control system interface (RS-232) • 12-volt trigger-activated equipment (retractable screens or screen masking) • External IR repeater • Network hub, router or gateway (Ethernet) 	38
7	Connect signal sources to the Dimension Digital Controller	43
8	Connect the Active 3D Emitter to the Dimension Digital Controller	49
9	Connect system components to AC power	49
10	Apply power to the projector	50
11	Adjust primary lens: projected image size (zoom), position (shift) and focus	24, 51
12	For rear-screen and/or ceiling-mount installations, select the proper picture orientation	51
13	Use Image Alignment controls to fine-tune image geometry	52
14	Install and adjust secondary anamorphic lens (optional)	54
15	Display calibration: adjust the following for each Dimension Digital Controller input and display mode (resolution/frame rate) ; save settings when finished: <ul style="list-style-type: none"> • Aspect ratio • Brightness • Contrast • Color temperature and white balance • Color level • Tint • Input position 	60 through 79
16	Prepare Runco Active 3D Glasses for use and test with 3D source material	94

Proper installation of your projector will ensure the quality of your display. Whether you are installing a projector temporarily or permanently, you should take the following into account to ensure your projector performs optimally.

It is a common practice in custom audio/video installations to conceal cables by running them through walls.

If you plan to do this with your LS-12HBd installation, you will need to run three cables from the projector to the other projection system components: two (2) HDMI cables and a serial control cable (typically Category 5 or 4-wire telephone cable).

Choose the installation type that best suits your needs: front or rear screen, floor mount or inverted mount. Table 3-2 compares these various installation methods.

Table 3-2. Projector Installation Options

Advantages	Considerations
Front Screen, Floor Mount Installation	
<ul style="list-style-type: none"> • Easy to set up • Can be moved or changed quickly • Easy to access 	<ul style="list-style-type: none"> • Shares floor space with audience
Front Screen, Inverted Mount (ceiling) Installation	
<ul style="list-style-type: none"> • Does not take up audience space • Projector is unobtrusive • Projector cannot be accidentally moved 	<ul style="list-style-type: none"> • Installation is more permanent • Projector access is more difficult
Rear Screen, Floor Mount Installation	
<ul style="list-style-type: none"> • Projector is completely hidden • Projector is easily accessed • Usually good ambient light rejection 	<ul style="list-style-type: none"> • Requires separate room • Installation cost is usually higher
Rear Screen, Inverted Mount (ceiling) Installation	
<ul style="list-style-type: none"> • Projector is completely hidden • Usually good ambient light rejection 	<ul style="list-style-type: none"> • Requires separate room • Installation cost is usually higher
Rear Screen, Floor Mount with Mirror	
<ul style="list-style-type: none"> • Projector is completely hidden • Usually good ambient light rejection • Requires less space behind screen than other rear screen installations 	<ul style="list-style-type: none"> • Requires separate room • Installation cost is usually higher

In general, minimize or eliminate light sources directed at the screen. Contrast ratio in your images will be noticeably reduced if light directly strikes the screen, such as when a shaft of light from a window or floodlight falls on the image. Images may then appear washed out and less vibrant.

3.3 Installation Considerations

◀ **Pre-Wiring for 3D: Run Dual HDMI Cables**

◀ **Installation Type**

◀ **Ambient Light**

Throw Distance ➤ Throw distance is the distance measured from the front of the projector to the screen. This is an important calculation in any projector installation as it determines whether or not you have enough room to install your projector with a desired screen size and if your image will be the right size for your screen.

You can quickly estimate the throw distance by taking the width of the screen and multiplying it by the lens throw ratio; see Figure 3-1. The result of this calculation tells you roughly how far back the projector should be positioned from the screen in order to project a focused image large enough to fill the screen.

Estimating Throw Distance

$$\text{Throw Distance (TD)} = \text{Screen Width (w)} \times \text{Lens Throw Ratio}$$

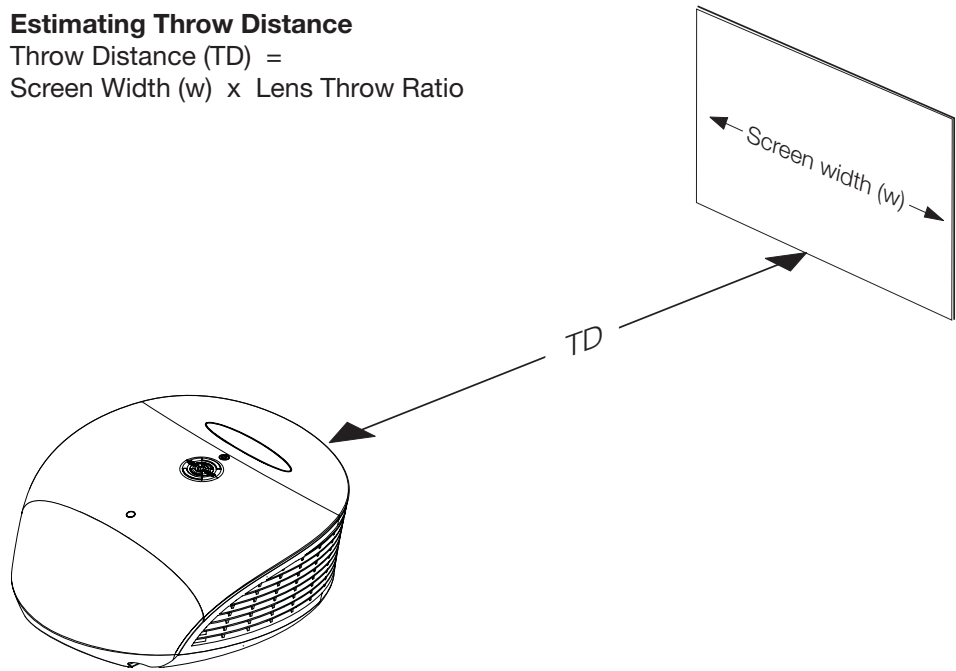

Figure 3-1. Estimating Throw Distance

Table 3-3 lists the available lens options for the LS-12HBd and their associated throw ratios.

Table 3-3. LS-12HBd Lens Options and Throw Ratios (Note 1)

Lens Option	Throw Ratio with Primary Lens Only	Throw Range in inches, with 117x65.8-inch (1.78:1) Screen		Throw Ratio with Primary Lens and Anamorphic Lens	Throw Range in inches, with 156x65.8-inch (2.35:1) Screen	
		Minimum	Maximum		Minimum	Maximum
Proteus 1	0.77 (Fixed)	For rear-screen installations only. Contact Runco Technical Support for more information.		Not Applicable (Note 2)		
Proteus 2	1.45 - 1.74	169.65	203.58	1.09 - 1.30	170.04	202.80
Proteus 3	1.74 - 2.17	203.58	253.89	1.30 - 1.63	202.80	254.28
Proteus 4	2.17 - 2.90	253.89	339.30	1.63 - 2.17	254.28	338.52
Proteus 5	2.90 - 4.34	339.30	507.78	2.17 - 3.26	338.52	508.56
Proteus 6	4.34 - 6.76	507.78	790.92	3.26 - 5.07	508.56	790.92

Notes:

- Due to normal manufacturing variances, throw distance can vary by up to +/- 5 percent from these specifications.*
- Only the Proteus 2, 3, 4, 5 and 6 lenses can be used with the optional anamorphic lens. Doing so affects the throw distances as shown here.*

Proper placement of the projector relative to the screen will yield a rectangular, perfectly-centered image that completely fills the screen.

Ideally, the projector should be positioned perpendicular to the screen and in such a way that the lens center is aligned with either the top or bottom edge of the screen area, and centered horizontally. See Figure 3-2.

◀ **Vertical and Horizontal Position**

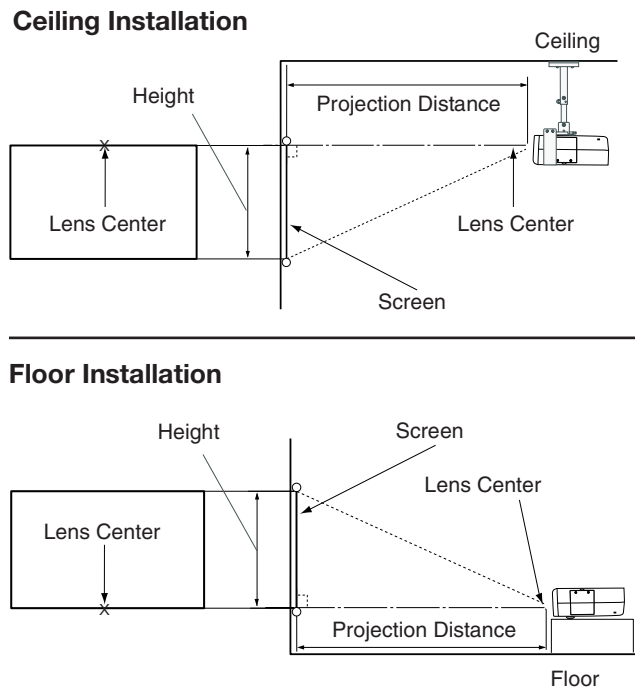
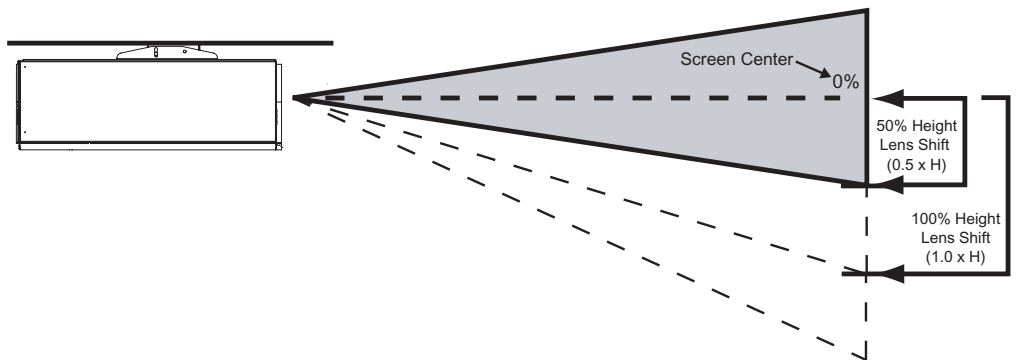

Figure 3-2. Projector Placement

Vertical and Horizontal Lens Shift

You can use the lens shift controls to center the image on the screen. Lens shift is generally expressed as a percentage of the screen height or width, as shown in Figure 3-3 and Figure 3-4.



Note: This is a general example of lens shift. Lenses vary in their shift capabilities. **No particular lens or projector is used in this example.**

Figure 3-3. Vertical Lens Shift (EXAMPLE ONLY)

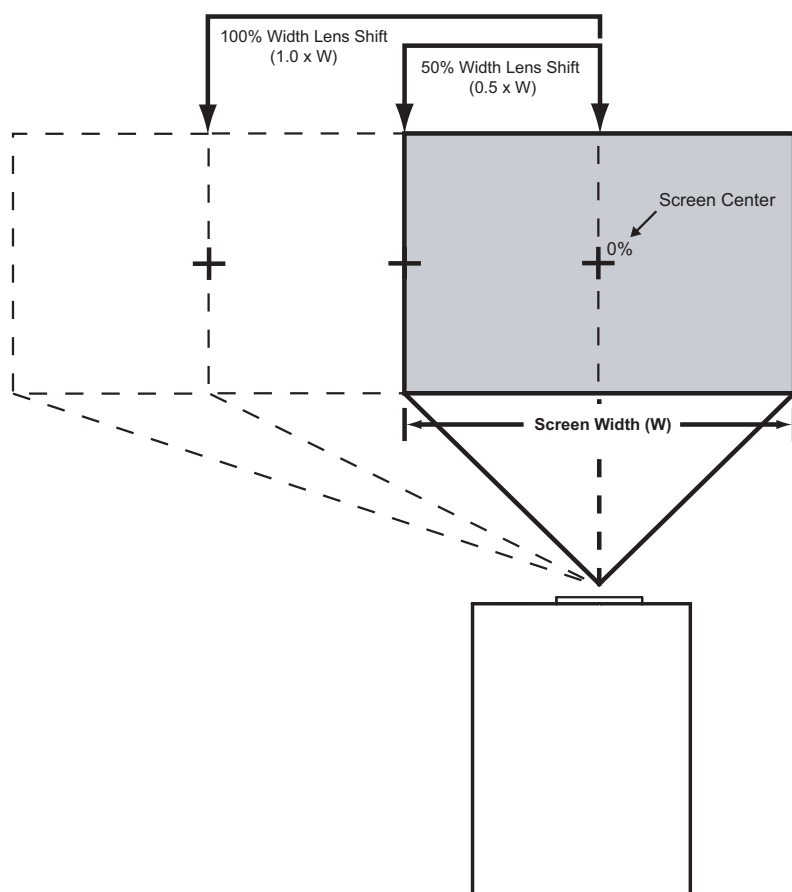

Note: This is a general example of lens shift. Lenses vary in their shift capabilities. **No particular lens or projector is used in this example.**

Figure 3-4. Horizontal Lens Shift (EXAMPLE ONLY)

Vertical Lens Shift: The LS-12HBd zoom lenses (Proteus 2 through 6) provide up to 65% of vertical lens shift in either direction (up or down). For example, with a 96 x 54-inch (16:9) screen, you can shift the image up to 35.10 inches (0.89 meters) below the screen center. (Vertical lens shift is not possible with the Proteus 1 lens.)

Horizontal Lens Shift: The LS-12HBd zoom lenses (Proteus 2 through 6) allow up to 30% of horizontal lens shift in either direction (left or right). For example, with a 96 x 54-inch (16:9) screen, you can shift the image up to 28.80 inches (73.15 cm) left or right of the screen center. (Horizontal lens shift is not possible with the Proteus 1 lens.)

Folded Optics ➤ In rear-screen applications where space behind the projector is limited, a mirror may be used to fold the optical path, as shown in Figure 3-5. The position of the projector and mirror must be accurately set. If you are considering this type of installation, contact your dealer for assistance.

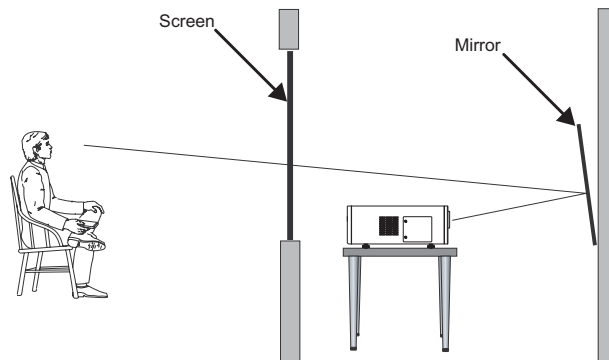

Figure 3-5. Folded Optics



Tip

For best performance, always use “first-surface” mirrors in your rear-projection installation (as opposed to conventional, “second-surface” mirrors with the reflective surface behind a transparent substrate such as glass or acrylic).

First-surface mirrors provide a strict reflection without the “ghosting” effect seen with a second surface mirror, where a faint secondary reflection could be observed coming from the front surface of the glass.

This is especially critical for 3D viewing; with a conventional second-surface mirror, the resulting image quality may be unacceptable.

Due to its extraordinarily high level of video processing performance, the Dimension Digital Controller may distribute video signals with a perceptible level of audio latency. In order to easily solve this issue, Runco recommends using the Dimension Digital Controller with a high-quality audio receiver that has the ability to effectively synchronize audio and video signals.

Most mainstream audio receiver/switchers have the ability to synchronize the audio and video to the Advanced Television Systems Committee (ATSC) prescribed tolerances. According to the ATSC, the sound program should never lead the video program by more than 15 milliseconds, and should never lag behind the video program by more than 45 milliseconds.

In addition, many video displays and A/V receivers introduce additional latency that needs to be compensated for during the installation.

Table 3-4 shows the amount of possible audio latency given different signal input timings.

Table 3-4. Possible Audio Latency for Various Input Timings

Input Timing	Possible Audio Latency (milliseconds)
480i	133
480p	83
576i	160
576p	100
720p/50	100
720p/60	83
1080i/25	160
1080i/30	133
1080p/24	125
1080p/50	80
1080p/60	67

Other considerations and tips that can help improve your installation:

- Keep the ambient temperature constant and below 35°C (95°F). Keep the projector away from heating and/or air conditioning vents. Changes in temperature may cause drifts in the projector circuitry, which may affect performance.
- Keep the projector away from devices that radiate electromagnetic energy such as motors and transformers. Common sources of these include slide projectors, speakers, power amplifiers and elevators.

◀ **Audio/Video Synchronization Issues**

◀ **Other Considerations**

3.4 Installing the Optional Anamorphic Lens Mount

If you are installing a standard LS-12HBd (without an anamorphic lens), skip this step and proceed with **Mounting the LS-12HBd** (page 33).

If you are installing an LS-12HBd with an anamorphic lens, proceed as follows to install the lens mount and transport assembly.



Note

1. Do not install the anamorphic lens yet, only the lens mount and transport assembly. You will install the anamorphic lens after you install the projector and adjust the primary lens.

2. Some components shipped with your projector may differ slightly from what is shown in these instructions.

Package Contents ➤

The LS-12HBd Anamorphic lens mount kit consists of the following items. Some components shipped with your projector may differ slightly from what is shown in these instructions. If any items are missing or damaged, please contact your Runco dealer or Runco Customer Service at (800) 23RUNCO.

- Transport Assembly Attachment Plate
- Attachment plate hardware (screws, washers and spacers)
- Attachment plate security hooks and related hardware (chain, chain ends, nuts and washers)



- Transport Assembly
- Transport mounting hardware
- Lens bracket mounting hardware
- Power supply
- Remote control unit and batteries



- Anamorphic lens and mounting bracket



Attaching the Transport Assembly Attachment Plate:

1. Place the projector upside down on a blanket or other soft surface.
2. Position the attachment plate as shown here.

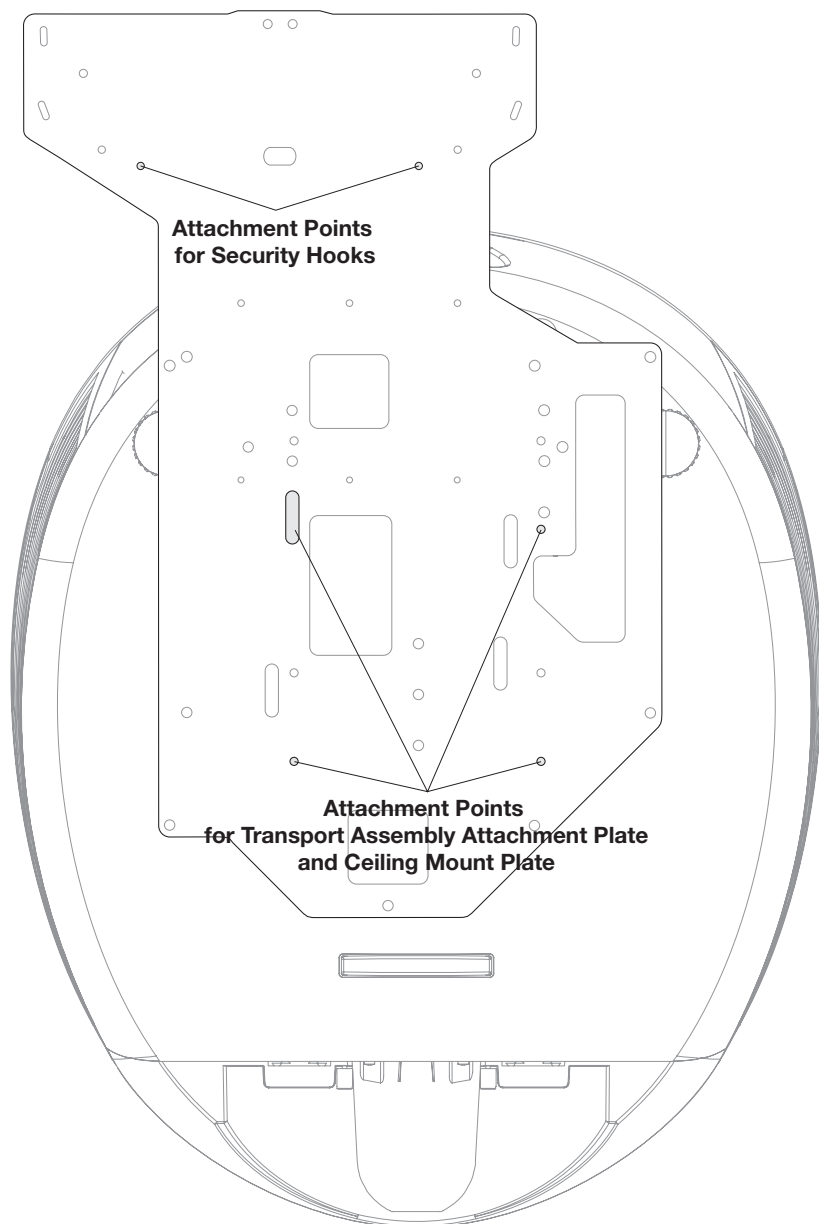

3. **If you are mounting the projector on a ceiling:** Line up the holes on the Ceiling Mount Plate (included with the projector ceiling mount kit) with those on the bottom of the projector and attachment plate.
4. Secure the Transport Assembly Attachment Plate and Ceiling Mount Plate to the projector using the hardware provided with the attachment plate, as shown.



Caution

1. **Do not use the mounting screws provided with the ceiling mounting kit.** Use only the hardware provided with the Transport Assembly Attachment plate.

2. **DO NOT OVER-TIGHTEN THE SCREWS.**

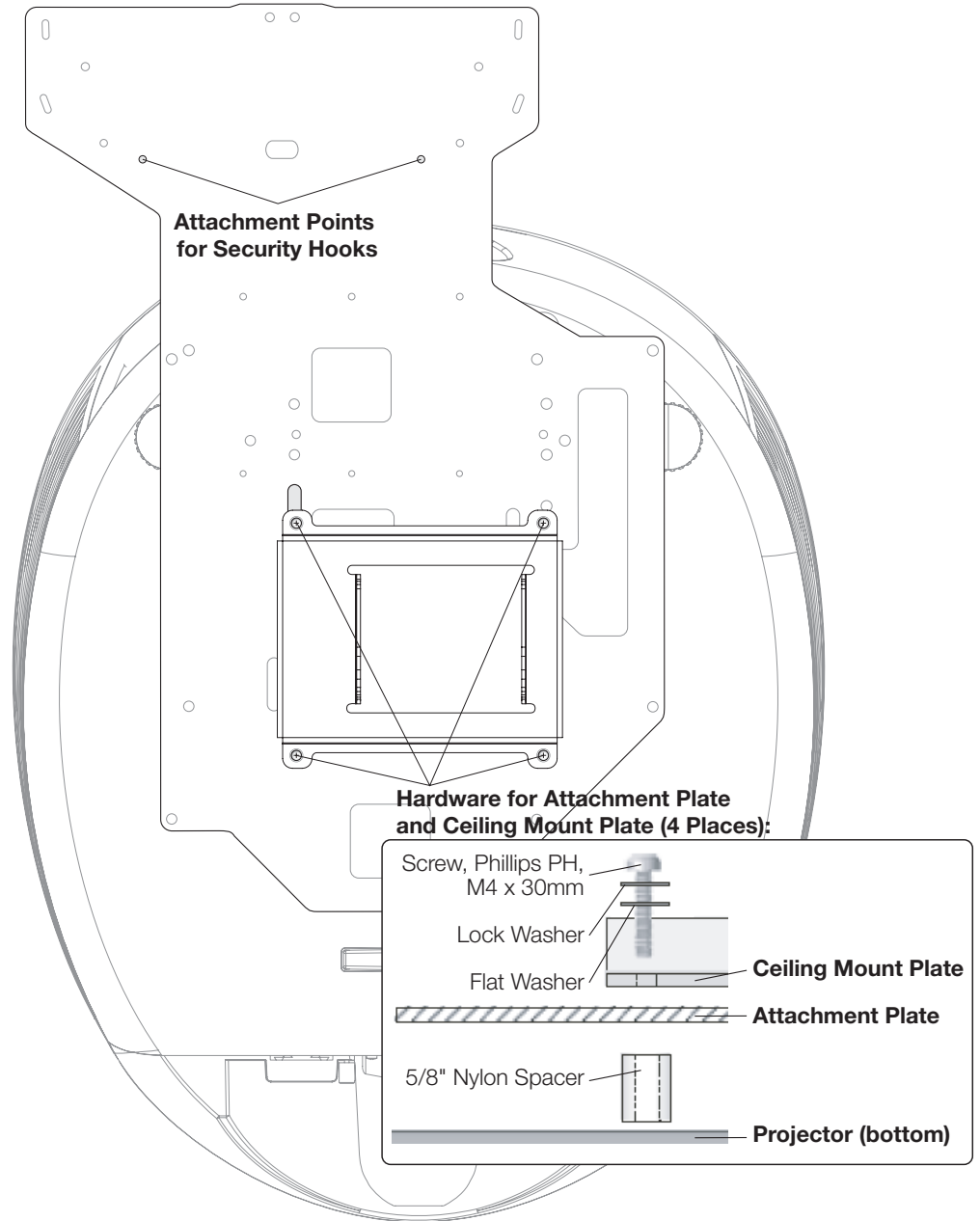

Installing the Anamorphic Lens Transport Assembly: After installing the Transport Assembly Attachment Plate and Ceiling Mount Plate, proceed as follows to install the Anamorphic Lens Transport Assembly.

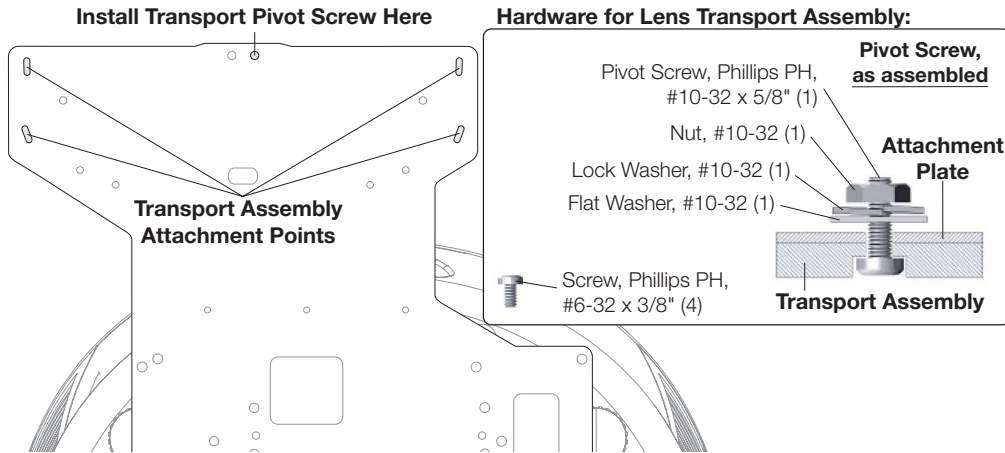

1. Position the flat side of the motorized transport against the bottom side of the Attachment Plate so that the center "M" hole in the Attachment Plate is aligned with the front recessed transport hole.
2. Insert the #10-32 pivot screw up through the transport and Attachment Plate and loosely complete the assembly with the corresponding washer, lock washer and nut.
3. Loosely insert the four small 3/8" screws through the four remaining "M" slots through the top of the Attachment Plate and down into the transport.
4. Separate the Anamorphic Lens and lens bracket. Locate the lens bracket mounting screws and use them to attach the bracket to the transport assembly. Observe the sticker on the plate showing the correct sequence for installing and tightening the screws.

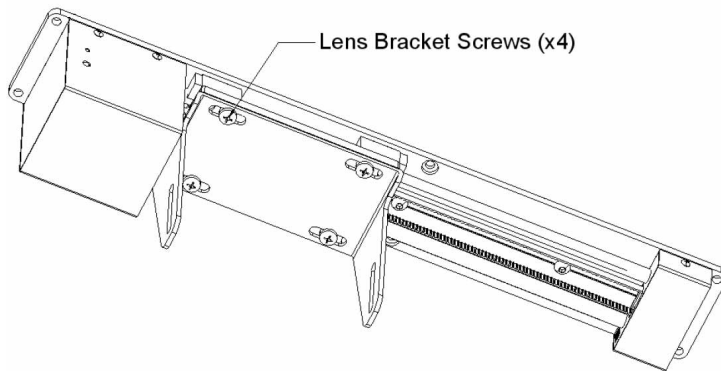

Attaching the Security Hooks: To help stabilize and support the added weight of the Anamorphic Lens and Lens Transport Assembly, the attachment plate includes two security hooks and related hardware for attaching the front part of the plate to the ceiling above.

Proceed as follows to attach the security hooks. This requires the following tools and materials:

- Pliers
- Scissors
- Ceiling Hooks (not supplied)

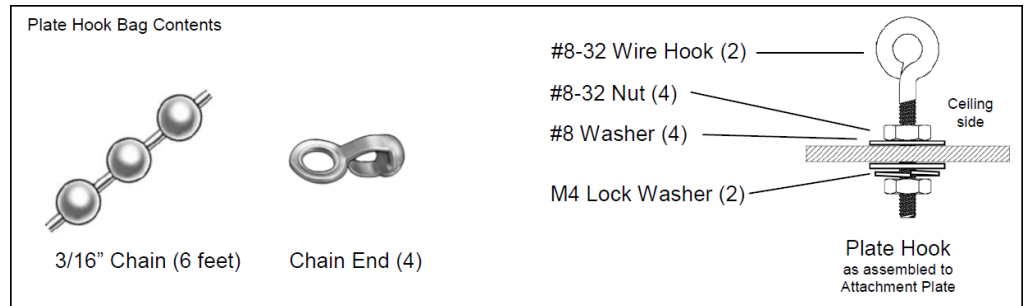

1. Install the Plate Hook Assemblies in the two "H" holes of the Attachment Plate (see diagram on page 29) with the hook ends on the ceiling side as shown above.
2. Use pliers to bend the closed hooks apart just enough to install a Chain End at a later time.
3. Attach the plate hooks to the ceiling as described in the section entitled **Ceiling Mounting (Inverted)**, on the next page.



There are several methods for mounting the projector. Depending on your chosen installation, one method may be more suitable than another.

In typical front and rear screen installations, the projector can be mounted to a secure and level surface such as a table or cart. Carts are useful when moving a projector during a presentation or from site to site. If possible, lock the wheels when it's in position to prevent it from being moved during a presentation.

For fixed installations, and for those that want the projector out of sight or have a limited space for projector and audience, you can invert the LS-12HBd and suspend it from the ceiling using a specially-designed ceiling mount fixture.



Note

Use only the Runco-approved ceiling mount kit designed for your projector.

Install the ceiling mount kit according to the instructions provided with it.

If you are ceiling-mounting an LS-12HBd with an anamorphic lens, perform these additional steps to secure the plate Security Hooks to the ceiling (refer to **Attaching the Security Hooks** on the previous page).

1. Install ceiling hooks (not supplied) into the ceiling directly above the Plate Hooks. The ceiling hooks should be small enough to accept a Chain End but strong enough when installed to each support 40 pounds or more.
2. Attach a Chain End to the Chain and then connect it to one of the ceiling hooks.
3. Cut the Chain to a length equal to or slightly greater than the distance between the ceiling hook and the corresponding Plate Hook.
4. Attach a Chain End to the other end of the Chain. Then, use the Chain to connect the ceiling hook and the Plate Hook.
5. Repeat Steps 2 through 4 for the other ceiling hook/Plate Hook pair.

The projector can also be inverted and placed in an enclosure above and behind the viewing area. Install four feet on the inside bottom surface of the enclosure on which the projector can rest. A variety of materials can be used for this purpose (for example, rubber crutch tips or turntable feet).

3.5 Mounting the LS-12HBd

◀ **Floor Mounting (Upright)**

◀ **Ceiling Mounting (Inverted)**

◀ **Installing the Projector in an Enclosure**

Adjusting the Projection Angle ➤

If the LS-12HBd is ceiling-mounted and the screen is significantly lower than the projector, you can tilt the projector at a slight angle by adjusting the ceiling mount.

The projector can be rotated (side-to-side) up to 360 degrees and mounted without it affecting performance. However, to ensure optimal performance of the lamp, limit the front-to-back tilt of the projector to ± 20 degrees; see Figure 3-6.

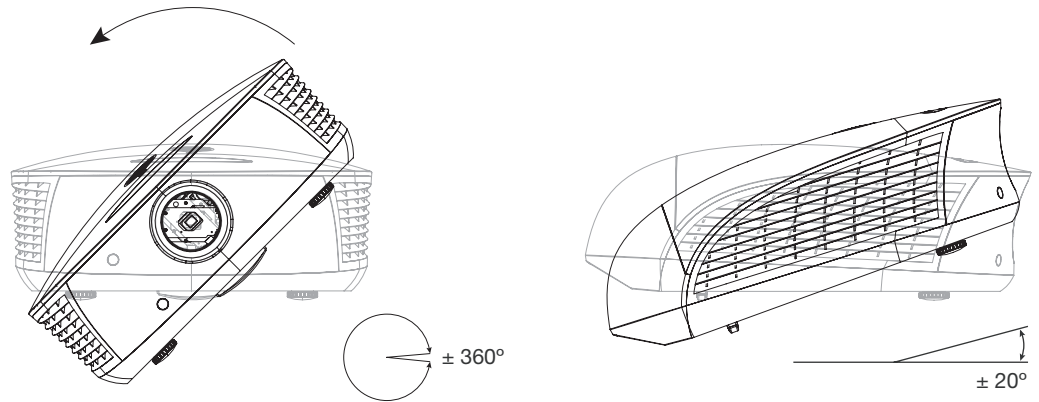

Figure 3-6. Mounting Angle Ranges (Front-to-Back and Side-to-Side)

If you do this, you may need to shift the image using the on-screen display (OSD) controls, to compensate. For detailed instructions, refer to **Primary Lens Adjustments: Focus, Zoom and Position** on page 51.

The Dimension Digital Controller unit can be placed on any flat, stable surface such as a shelf or table, or it can be rack-mounted using the supplied mounting hardware. Place it in a location that provides easy access to the power connectors.

The Dimension Digital Controller unit requires 2U (3.5 inches) or more of vertical rack space.

To mount the Dimension Digital Controller in a standard, 19-inch equipment rack, install the mounting ears on either side of the chassis using the supplied screws; see Figure 3-7. Then, secure the mounting ears to the rack.

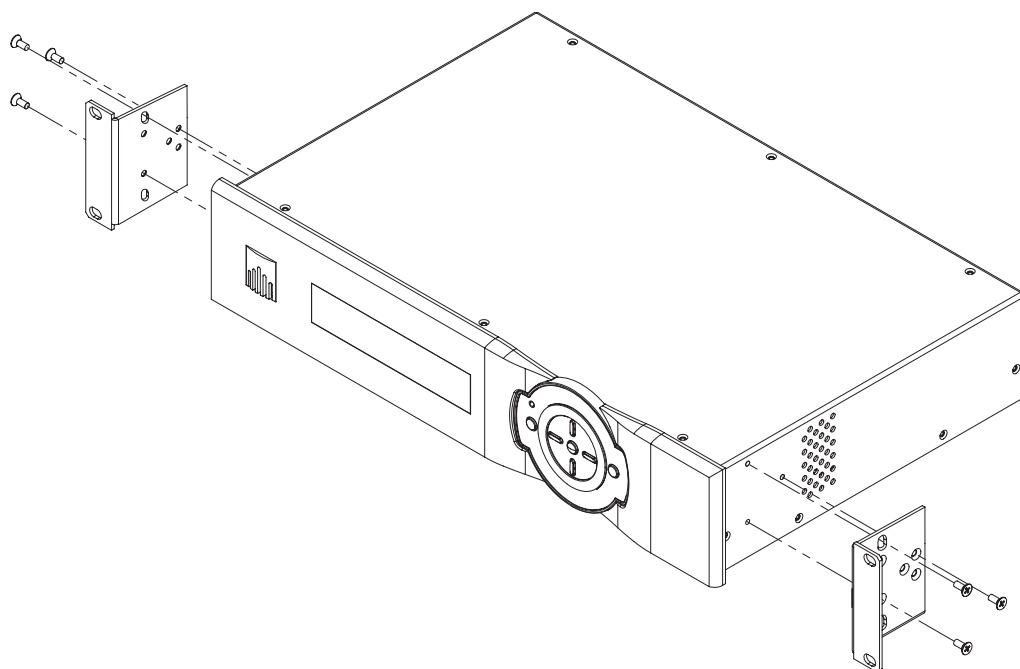

Figure 3-7. Attaching the Rack Mounting Hardware

3.6 Mounting the Dimension Digital Controller

3.7 System Interconnections

Proceed as follows to connect the LS-12HBd system components to each other and to AC power.

When connecting your equipment:

- Turn off all equipment before making any connections.
- Use the correct signal cables for each source.
- For best performance and to minimize cable clutter, use high-quality cables that are only as long as necessary to connect two devices. (Don't use a 20-foot cable when a 6-foot cable will suffice.)
- Ensure that the cables are securely connected. Tighten the thumbscrews on connectors that have them.

Connecting the Dimension Digital Controller to the Projector

Digital Video Connection: Connect the **HDMI Out To Pri. Display** connector on the Dimension Digital Controller to the **PRIMARY** input on the projector. Similarly connect the **HDMI Out To Sec. Display** connector on the Dimension Digital Controller to **SECONDARY** input on the projector.

RS-232 Connection: Connect the **Pri. Display Control** output from the Dimension Digital Controller to the **RS232** input on the projector.

Use a standard, modular telephone cable with RJ11 plugs at both ends. On the projector end, use the provided RJ11-to-DB9 adapter. This adapter is wired as shown in Figure 3-8.

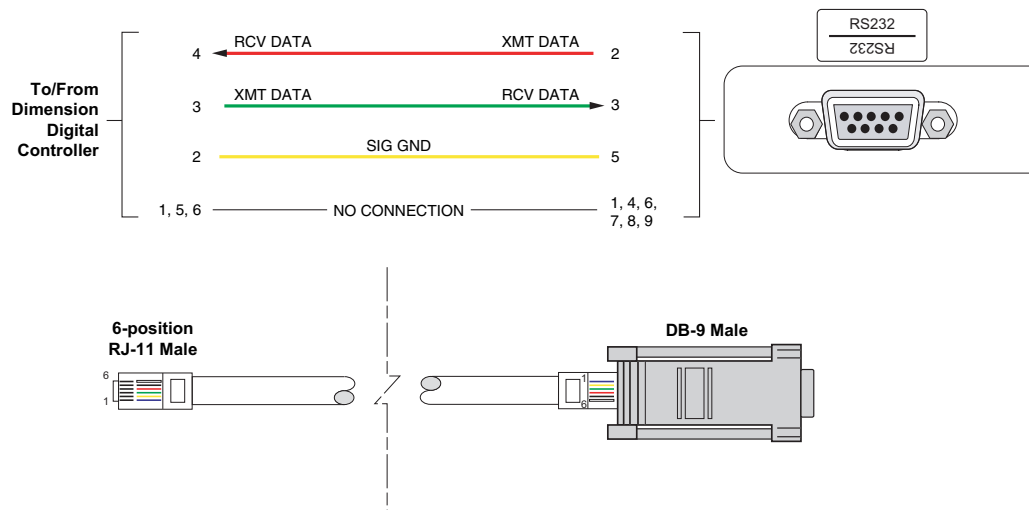

Figure 3-8. RS-232 Connection from the Dimension Digital Controller to the Projector



Note

Runco recommends using the RS-232 communication link between the LS-12HBd projector and the Dimension Digital Controller. However, display control using HDMI CEC control messages is also possible. For more information on this capability, please contact Runco Technical Support.

Figure 3-9 shows how to connect the Dimension Digital Controller to the projector.

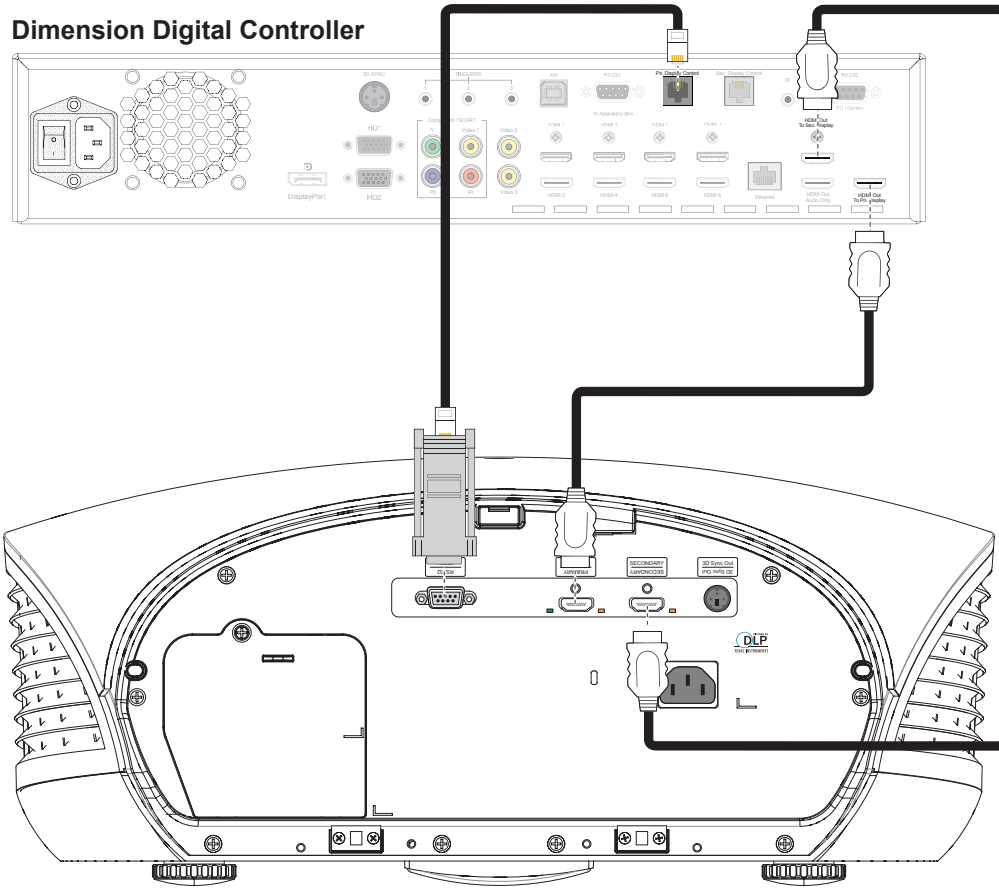

Figure 3-9. Connecting the Dimension Digital Controller to the Projector

Connecting an Audio Processor or Secondary Display Device to the Dimension Digital Controller (Optional)

The Dimension Digital Controller provides a second HDMI output (labeled **HDMI Out (Audio Only)**) for connection to an audio receiver/switching system or secondary display device for monitoring purposes. See Figure 3-10.



Note

The Dimension Digital Controller does not transmit HDMI CEC control messages from the "HDMI Audio Out" connector.

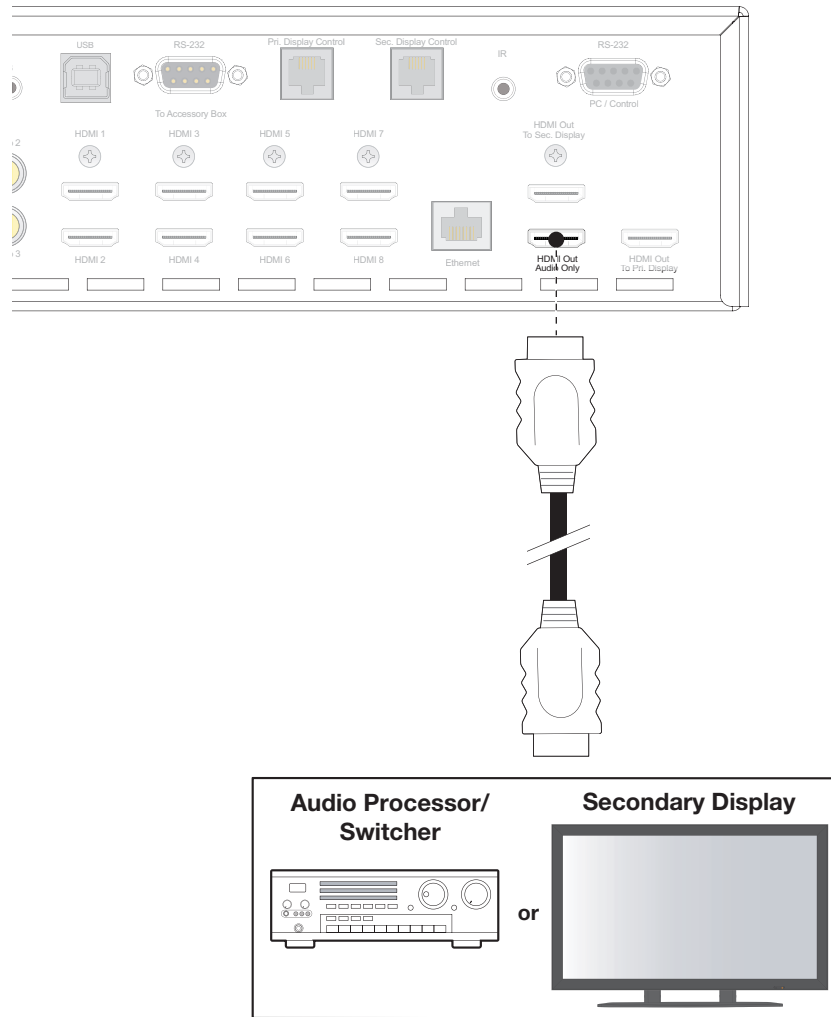

Figure 3-10. Audio Processor Connection to Dimension Digital Controller

The Dimension Digital Controller provides the following interfaces to external equipment that allow it to control or be controlled by that equipment:

- An RS-232 interface to a PC or control/automation system;
- Three (3), 12-volt trigger outputs;
- An infrared (IR) repeater input;
- An Ethernet network interface for firmware updates and maintenance notifications.

The following sections describe how to make these interface connections.

RS-232 Controller Connection: Use a straight-through, 9-pin RS-232 cable to connect a PC or control/automation system (if present) to the RS-232 port on the Dimension Digital Controller; see Figure 3-11.

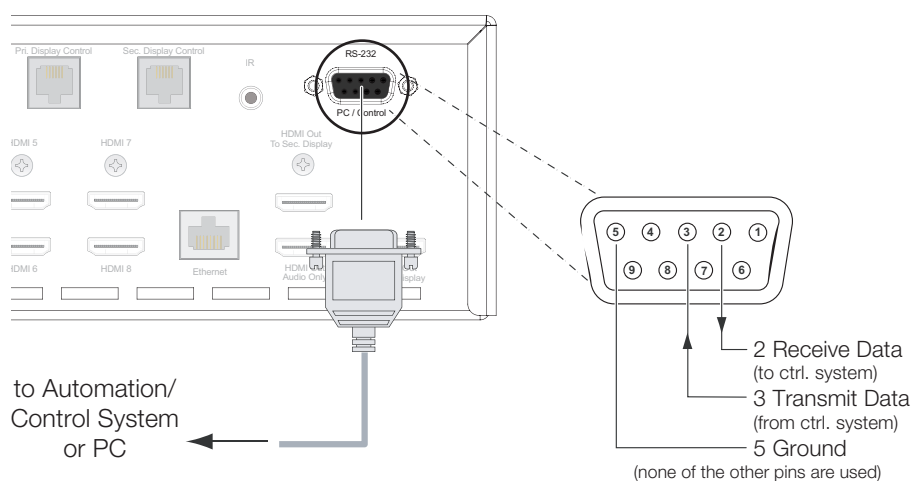

Figure 3-11. RS-232 Control System Connection to Dimension Digital Controller

◀ **Additional Connections to the Dimension Digital Controller (Optional)**

Connecting 12-volt Trigger Outputs to External Equipment: If your LS-12HBd is equipped with an anamorphic lens, connect the **+12V Trigger Input** on the lens transport to a 12-volt trigger output on the Dimension Digital Controller; see Figure 3-12.

Similarly connect other 12-volt trigger-activated equipment (such as retractable screens or screen masks) to the other trigger outputs.

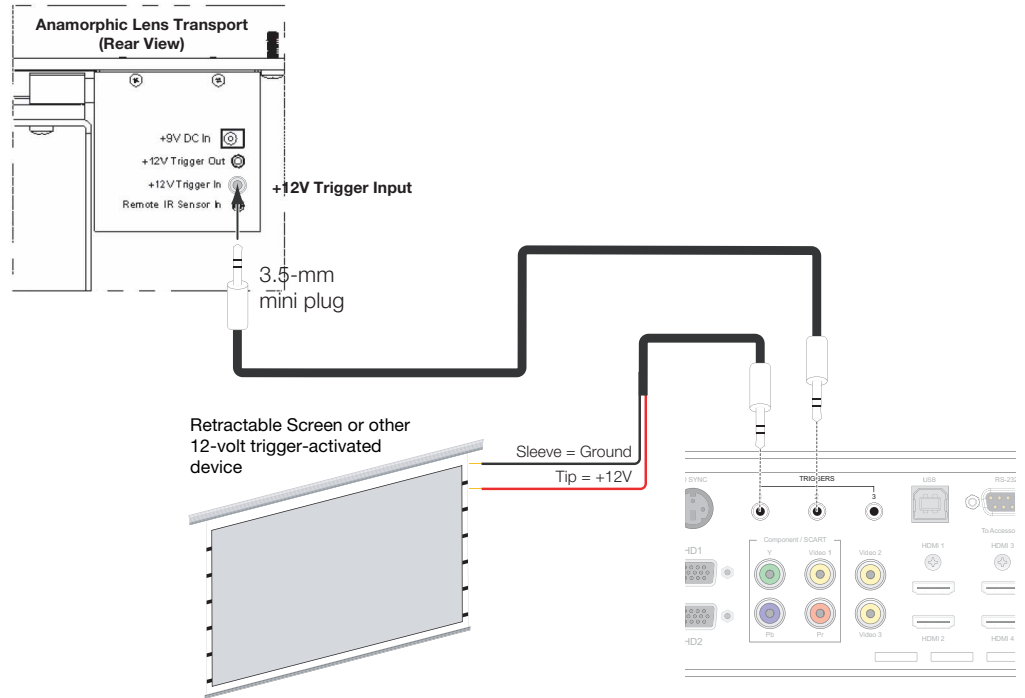

Figure 3-12. Connecting 12-volt Trigger Outputs

Connecting an External IR Receiver to the Dimension Digital Controller: If infrared signals from the remote control cannot reach the Dimension Digital Controller due to excessive distance or obstructions such as walls or cabinet doors, you can connect an external IR receiver to extend the range of the remote control. See Figure 3-13.

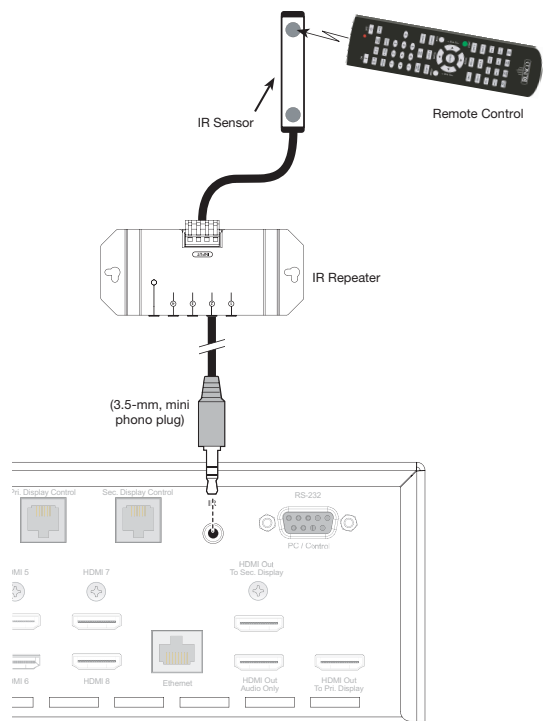

Figure 3-13. External IR Receiver Connection

Ethernet Network Connection: Use a standard, Category 5 network cable with an RJ-45 plug to connect a network hub, router or gateway to the Ethernet port on the Dimension Digital Controller; see Figure 3-14.

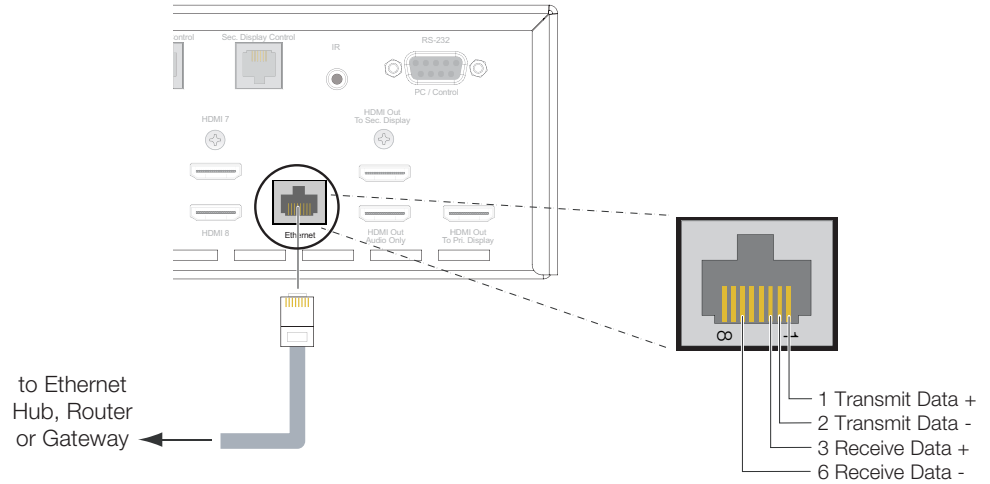

Figure 3-14. Ethernet Network Connection to Dimension Digital Controller

Connect your video sources to the Dimension Digital Controller as shown and described in the sections that follow.

◀ **Connecting Source Components to the Dimension Digital Controller**

DisplayPort Source Connection: See Figure 3-15.

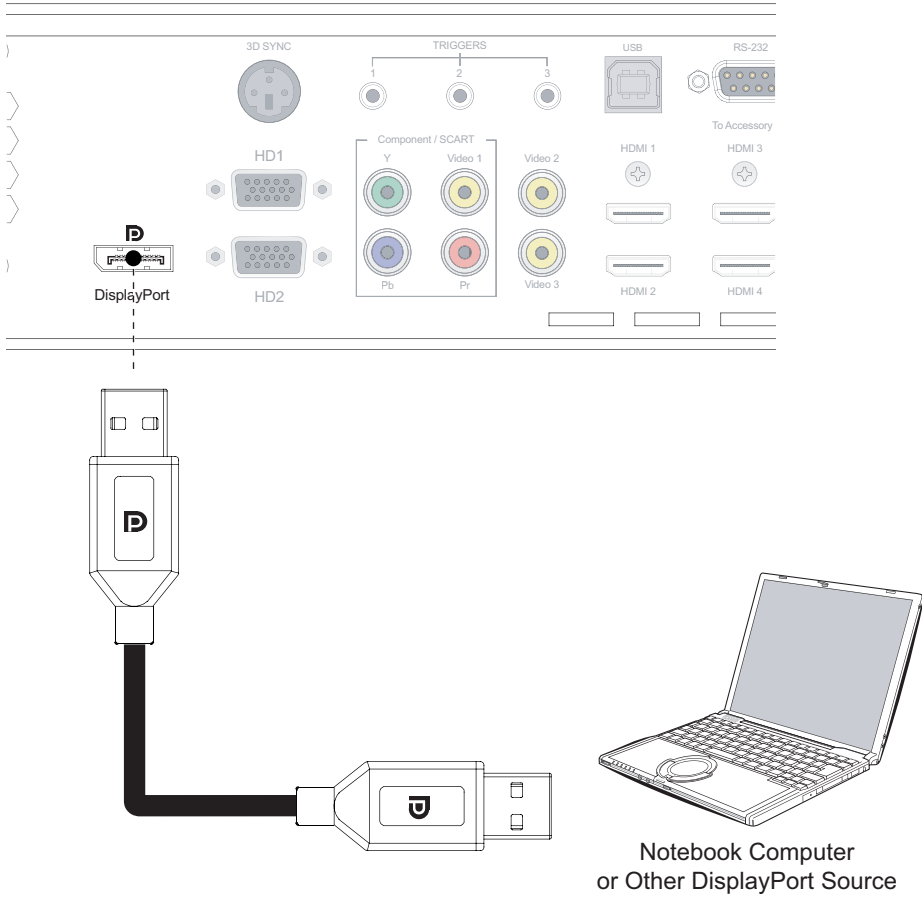

Figure 3-15. DisplayPort Source Connection

HDMI Source Connections: See Figure 3-16.



Tip

Use the HDMI inputs whenever possible. This ensures the highest video quality because the signal is carried in the digital domain throughout the entire signal path, from source component output into the projector.



Note

You can also connect computers with DVI output to these inputs. Refer to **Supported Timings** on page 129 for a list of compatible input signals.

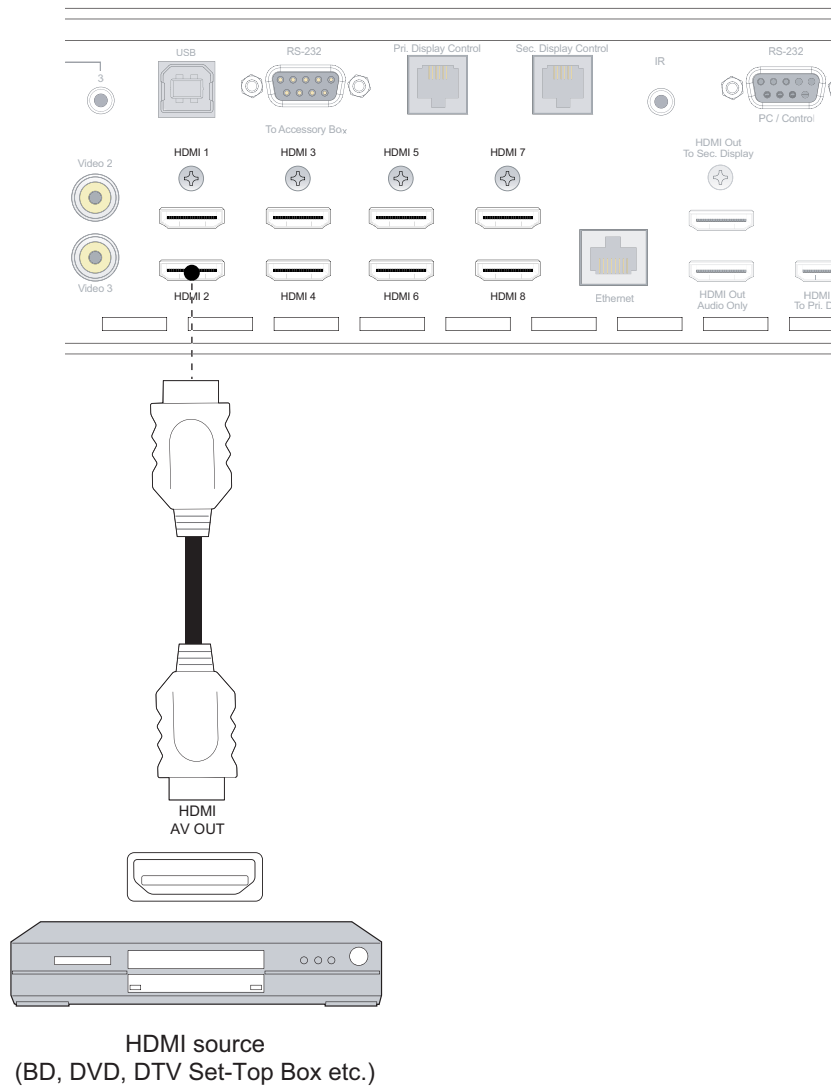

Figure 3-16. HDMI Source Connections

Component Video Source Connections: Connect your component video sources to the HD1, HD2 and/or Component/SCART inputs as shown in Figure 3-17.

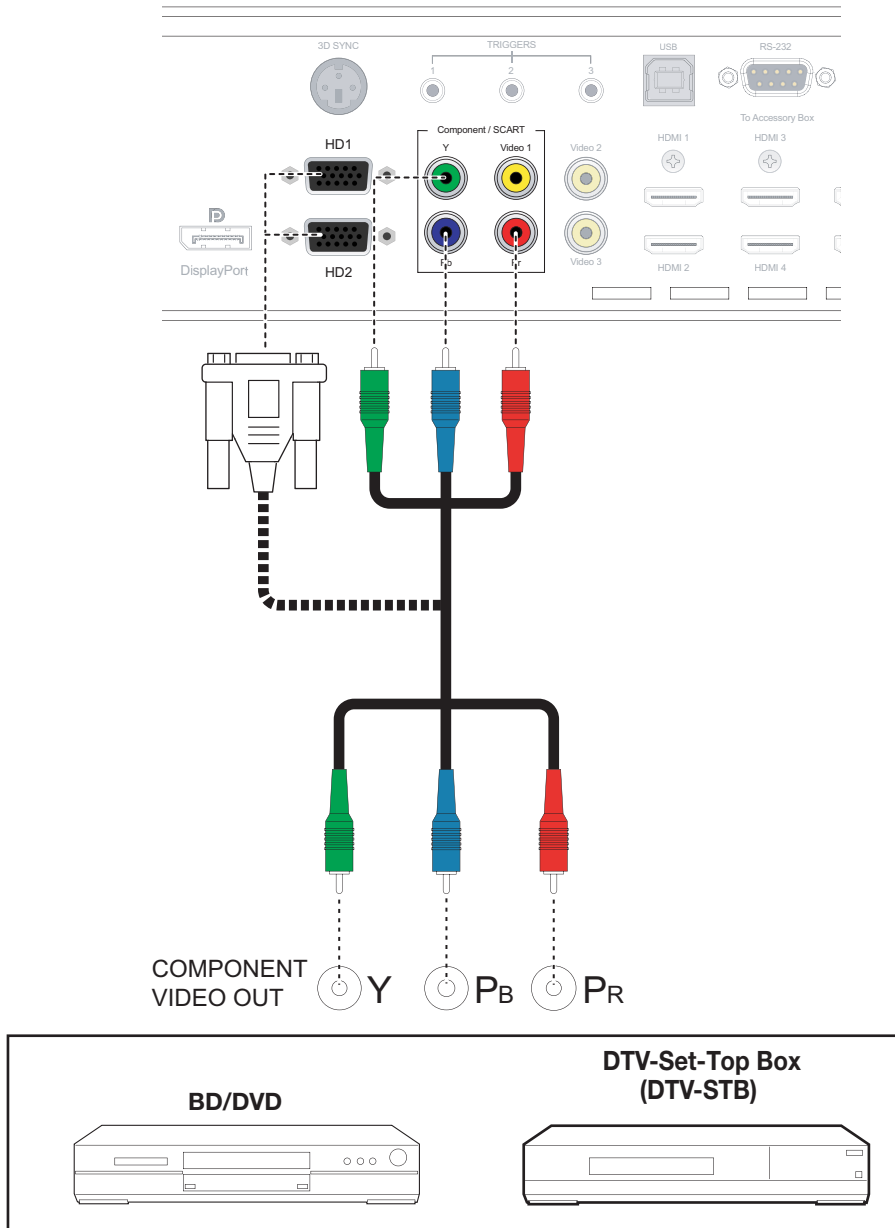

Figure 3-17. Component Video Source Connections

RGBHV Source Connections: Connect personal computers and/or other RGB sources to the HD1 and/or HD2 inputs as shown in Figure 3-18.

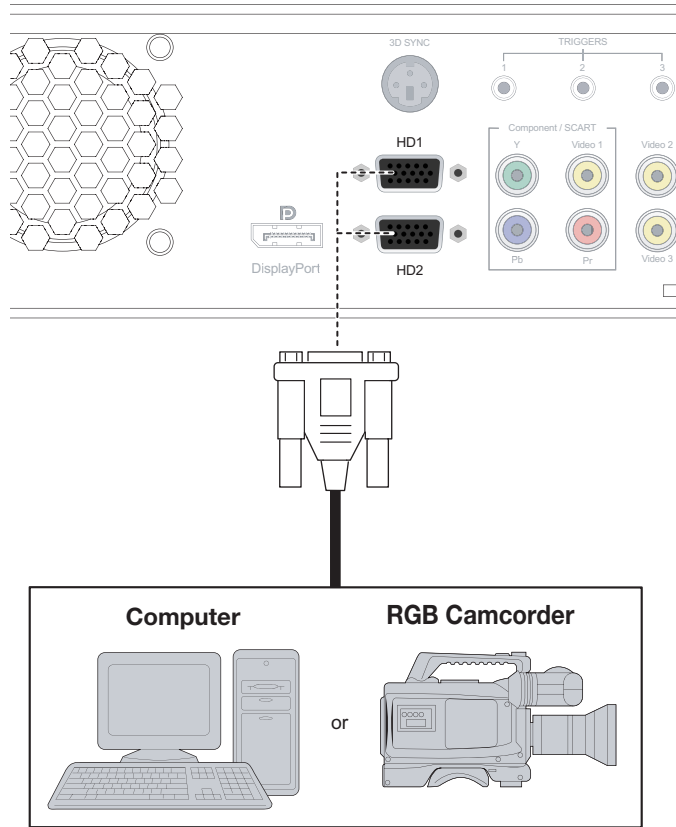

Figure 3-18. RGBHV Source Connections

SCART RGBS Source Connections: Connect the green, blue and red outputs from your SCART source to the Component/SCART input on the Dimension Digital Controller. Connect the sync output from your SCART source to the **Video 1** input on the Dimension Digital Controller. See Figure 3-19.

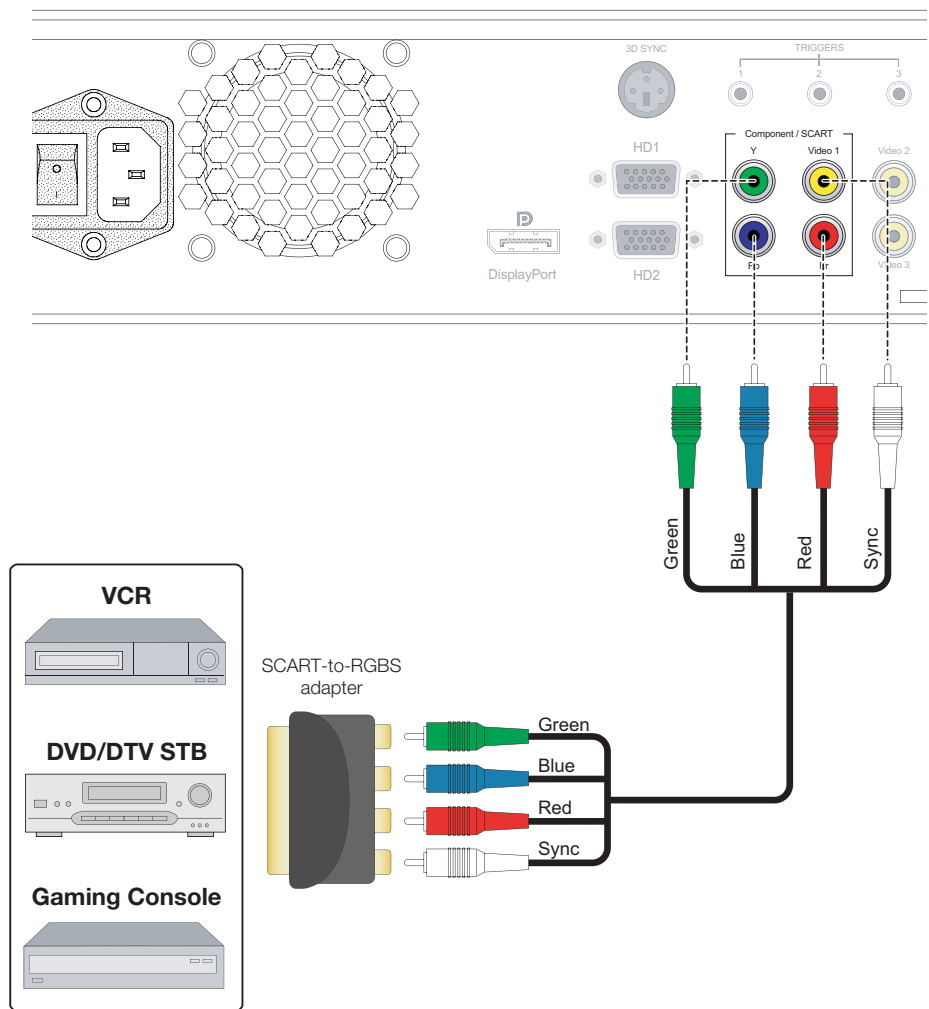

Figure 3-19. SCART RGBS Source Connections

Composite Source Connections: See Figure 3-20.

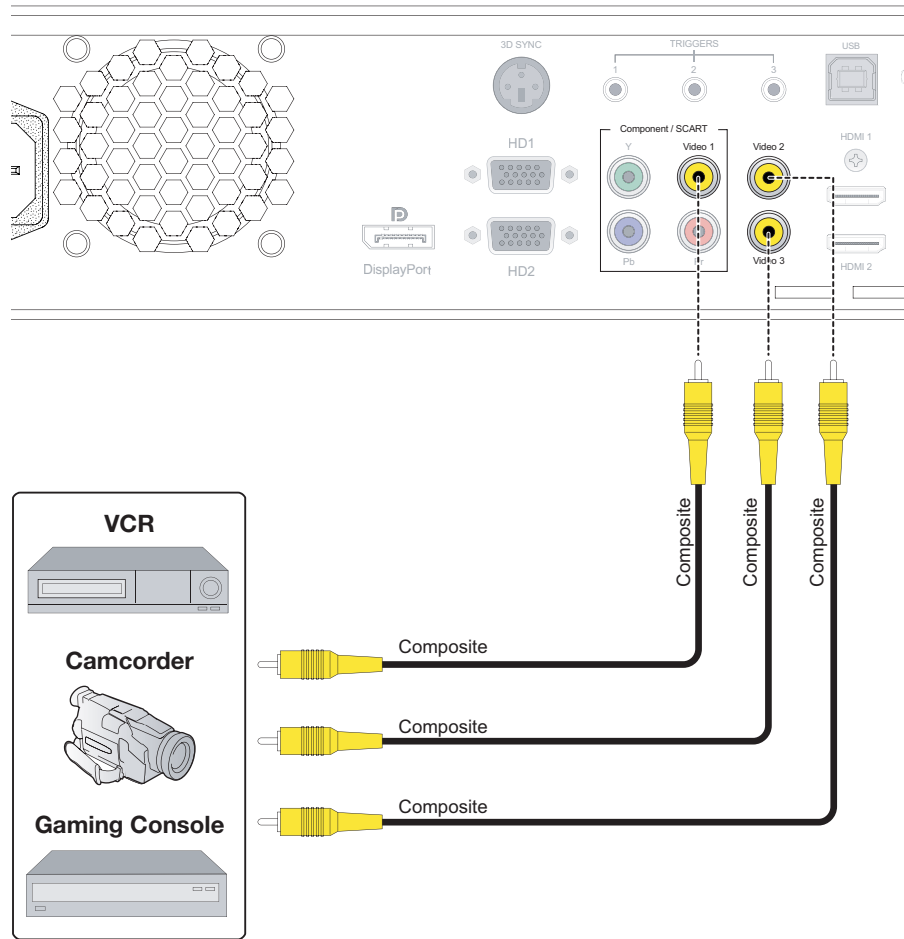

Figure 3-20. Composite Video Source Connections

Connect the **3D SYNC Out** port on the emitter to the **3D Sync Out** connector on the Dimension Digital Controller, as shown in Figure 3-21. Mount the emitter in a location that provides a clear line of sight between it and the viewing area.

◀ **Connecting the Active 3D Emitter to the Dimension Digital Controller**



Tip

Secure the emitter in the desired location using double-sided tape or a similar adhesive material.

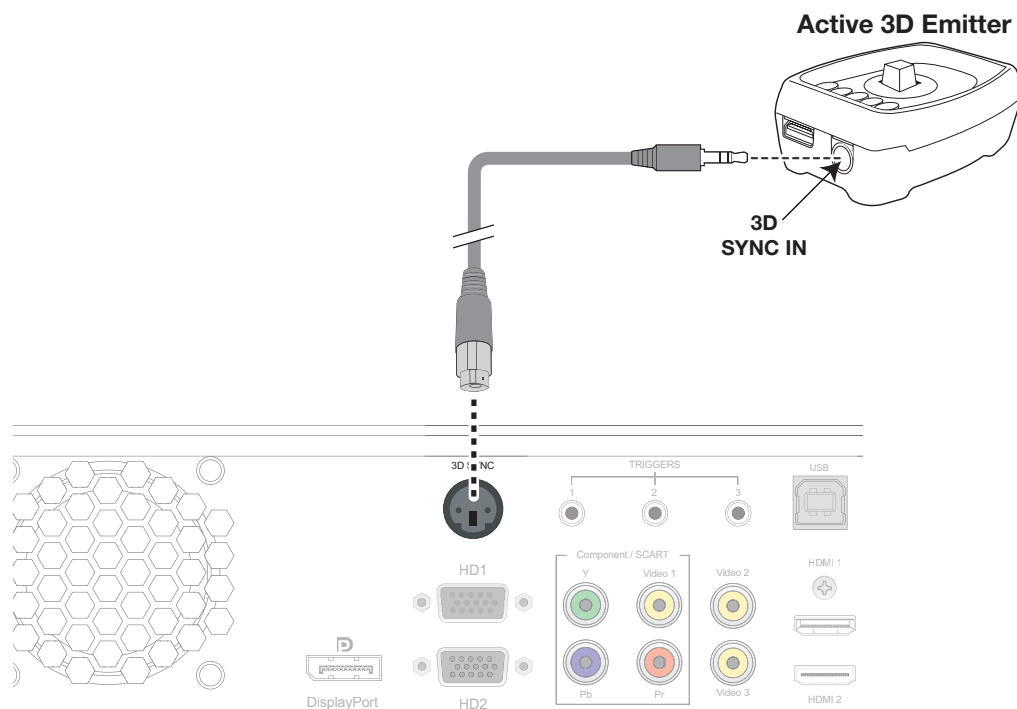
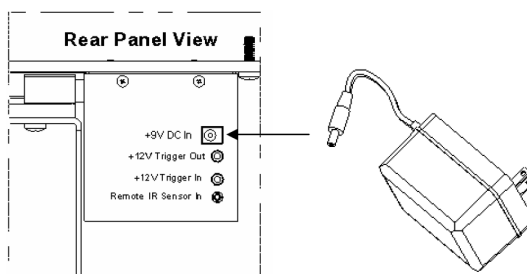

Figure 3-21. Active 3D Emitter Connection

Projector: Plug the female end of one power cord into the AC receptacle on the rear of the LS-12HBd (AC 100V ~ 240V). Then, connect the other end to your AC power source.

◀ **Connecting to AC Power**

Anamorphic Lens Transport: An AC-to-DC power adapter is provided for the lens transport. Connect the power adapter to the **+9V DC In** jack on the rear of the lens transport assembly. Connect the other end to an AC power source.



Similarly connect the Dimension Digital Controller to a nearby AC outlet.

3.8 Turning on the Power

1. Power up your source components.
2. Turn on the main power switch at the rear of the Dimension Digital Controller.
3. Press the **ON** button on the remote control (or the **ON/STANDBY** (⏻) button on the Dimension Digital Controller front panel) to turn on the system. The vacuum fluorescent display on the Dimension Digital Controller front panel briefly displays “Initializing System,” followed by “Starting LS-12HBd.”
4. When the display is ready for use, the fluorescent display indicates the active source, input resolution/frame rate and aspect ratio/screen; for example:

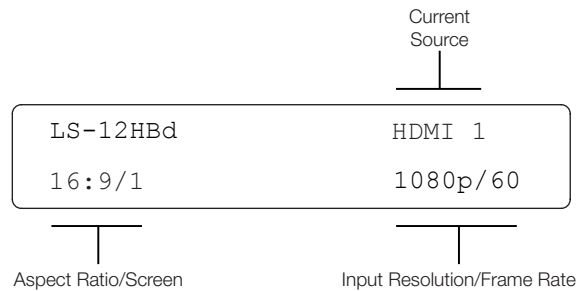

5. When the projector is turned on, the Active 3D Emitter turns on as well. The LEDs display a red moving pattern while the emitter attempts to acquire a 3D signal and until a signal is found.

If the emitter searches for a signal for longer than 60 seconds, a signal is assumed to not be present.

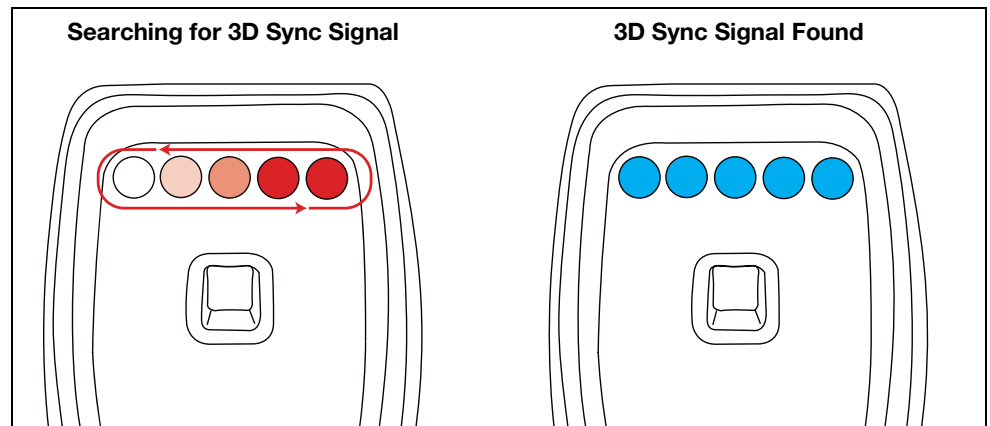

6. Upon finding a 3D signal, all LEDs turn blue. Once the LEDs indicate a 3D signal, the 3D glasses can be used to experience 3D. For more information on using the Active 3D Glasses, refer to **Using the 3D Glasses** on page 94.

Lens zoom, focus and position are motorized adjustments that are adjustable using the remote control (Figure 2-7). This allows you to adjust the focus and image size while at the screen for more accurate results.

**Note**

*If you prefer, you can also perform lens adjustments from the projector using the built-in keypad. For detailed instructions, refer to **KEYPAD** on page 7.*

To access the motorized lens controls:

1. On the Dimension Digital Controller remote control or front panel, press **MENU**.
2. Select **Service** from the Main Menu and enter the Service Menu passcode.

**Note**

You must enter a passcode to access the Service menu.

3. Select **Display Device** from the Service Menu.
4. Select **Configure** from the Display Device menu, then select **Lens**.

The Lens menu controls operate as described below.

To focus the projected image, use the cursor buttons to highlight “In” or “Out.” Then, press and hold the **ENTER** button.

◀ **Focus**

To make the picture smaller (zoom out), use the cursor buttons to highlight the minus sign (-). Then, press and hold the **ENTER** button.

◀ **Zoom**

To enlarge the picture (zoom in), use the cursor buttons to highlight the plus sign (+). Then, press and hold the **ENTER** button.

To change the lens position, use the cursor buttons to highlight “Left,” “Right,” “Up” or “Down” in the Lens menu. Then, press and hold the **ENTER** button to shift the lens in that direction.

◀ **Vertical and Horizontal Lens Shift**

To return the lens to its home position (no horizontal or vertical shift), use the cursor buttons to highlight “Home” in the Lens menu. Then, press the **ENTER** button.

By default, the LS-12HBd is configured for a “floor/front” installation, in which the projector is installed upright and in front of the screen. If it is installed behind the screen and/or mounted on a ceiling, you must change the picture orientation. To do this:

1. On the Dimension Digital Controller remote control or front panel, press **MENU**.
2. Select **Service** from the Main Menu and enter the Service Menu passcode.

**Note**

You must enter a passcode to access the Service menu.

3. Select **Display Device** from the Service Menu.
4. Select **Configure** from the Display Device menu, then select **Installation**.
5. Select **Orientation**, then choose Floor/Rear, Ceiling/Front or Ceiling/Rear, to match the installation method.

3.9 Primary Lens Adjustments: Focus, Zoom and Position

3.10 Adjusting the Picture Orientation

3.11 Adjusting the Image Geometry

Projector and/or screen placement — among other things — can cause geometric distortion in the projected image.

To correct this, the Dimension Digital Controller provides precise, nine-point control over the projected image geometry. Use these controls as (and **only if**) needed to re-position the image corners, mid-points and center to eliminate “keystoning” (mis-aligned corners) or “pincushion” distortion (mid-points not aligned with corners). See Figure 3-22.

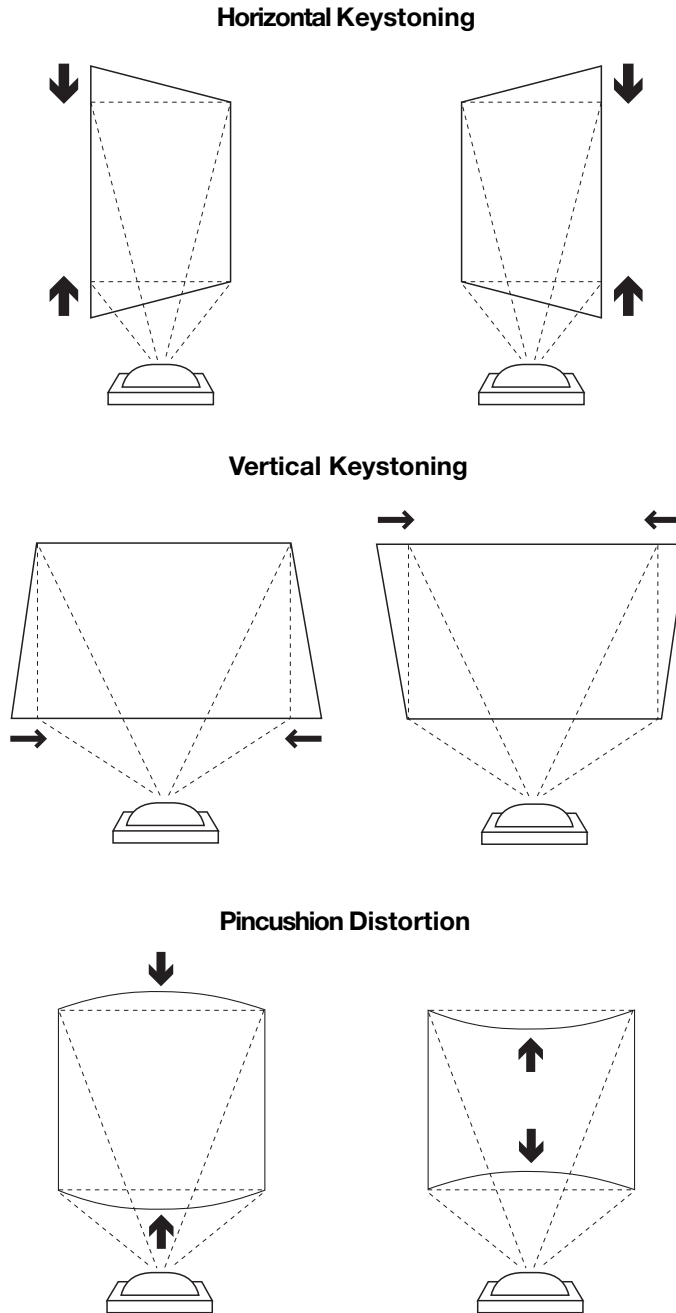

Figure 3-22. Keystone and Pincushion Distortion

“Keystoning” usually occurs when the projector is tilted relative to the screen. “Pincushion” distortion can sometimes occur if the throw distance is very short and/or the projector is equipped with an anamorphic lens.

To correct keystoning or pincushion distortion:

1. On the Dimension Digital Controller remote control or front panel, press **MENU**.
2. Select **Calibration** from the Main Menu and enter the Calibration Menu passcode.

**Note**

You must enter a passcode to access the Calibration menu.

3. Select **Image Alignment** from the Calibration Menu.
4. Select **Corner Alignment** to correct a “keystoned” image by adjusting the image corner positions. Select **Midpoint Alignment** to correct pincushion distortion by adjusting the image edge mid-points. See Figure 3-23.

**Tip**

*Use the built-in test pattern when adjusting the image corners or midpoints. To access it, check the **Test Pattern** box in the Corner Alignment or Midpoint Alignment menu.*

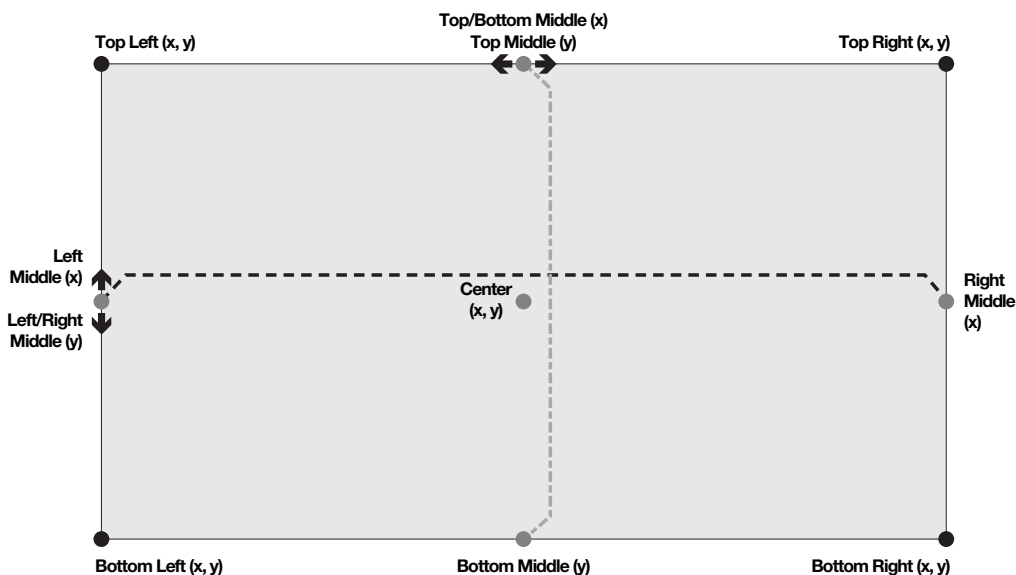
**Notes:**

1. Smaller “x” values move a point to the left; larger values move it to the right.
2. Smaller “y” values move a point up; larger values move it down.

Figure 3-23. Image Alignment Controls

3.12 Installing and Adjusting the Anamorphic Lens

If you are installing an LS-12HBd with an anamorphic lens, proceed as follows to install and adjust the lens.



Note

It is extremely important that the primary lens is properly adjusted before you install the anamorphic lens. Ensure that the image from the primary lens is perfectly centered on the screen.

Attach the anamorphic lens to the bracket using the plastic knobs supplied with the lens. See Figure 3-24.

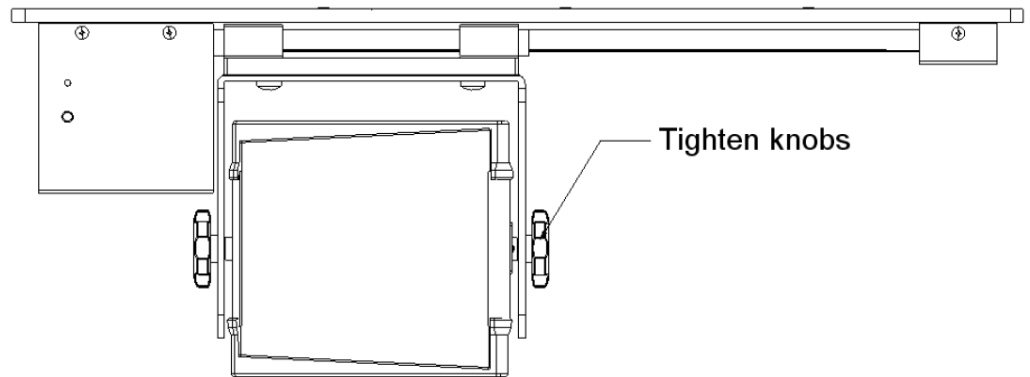
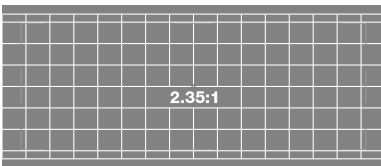

Figure 3-24. Attaching the Anamorphic Lens to the Lens Mount

Configure Lens Motor Trigger on Dimension Digital Controller: The anamorphic lens solution for the LS-12HBd maintains constant image height independent of the aspect ratio, while using the full display resolution of the projector. It accomplishes this by moving the anamorphic lens in front of the primary lens when widescreen material is being viewed. When the viewer transitions back to 16:9 or 4:3 source material, the anamorphic lens moves out of the light path.

Proceed as follows to configure the 12-volt trigger output for proper operation.



1. Project a 2.35:1 aspect ratio test pattern or other image on the screen.
2. On the Dimension Digital Controller remote control or front panel, press **MENU**.
3. Select **Service** from the Main Menu and enter the Service Menu passcode.



Note

You must enter a passcode to access the Service menu for the first time after turning on the system.

4. Select **Triggers** from the Service menu.
5. Assign the trigger output to which the lens motor is connected to the Cinema and Virtual Cinema aspect ratios. This enables the lens motor to move the anamorphic lens into position (in front of the primary lens) when either aspect ratio is selected.

6. Select the Cinema aspect ratio to move the anamorphic lens into position, if it isn't already. To do this, press **CINEMA** on the Dimension Digital Controller remote control (Figure 2-7), or press ▲ or ▼ repeatedly with no menus visible on-screen.

Adjusting the Lens Position:

1. Adjust the vertical position and tilt of the lens so that the projector beam is passing through the center of the lens and any residual pincushion distortion is about the same at the top and bottom of the image. This typically results in the anamorphic lens being below the center of the primary lens and tilted slightly downward.
2. Tighten the knobs.



Note

There may be some pincushion distortion even after the lens is properly adjusted, especially at shorter throw distances. If this is the case, Runco recommends that you slightly over-scan the image into the screen frame area to mask the distortion.

3. Adjust the rotation of the Lens Transport Assembly so that the left and right sides of the image are an equal distance from their respective screen borders.
4. Tighten the Pivot Screw and the four mounting screws holding the transport to the Attachment Plate.
5. For optimum multiple aspect ratio performance, adjust the projector's zoom so that a 1.85:1 aspect ratio movie is just masked by the top and bottom of the screen border when the anamorphic lens is not in front of the primary lens. This way 1.85:1, 16:9 and 2.35-2.4:1 aspect ratio movies are all presented to fill the screen at a constant height.
6. Remove the protective film from the front of the anamorphic lens.



Notes:

4. Operation

To display the Main Menu, press the **MENU** button on the remote control or Dimension Digital Controller front panel (Figure 2-5).

To select a menu item, use the **▲** and **▼** buttons on the remote control or Dimension Digital Controller front panel to highlight it. Then, to confirm your selection, press **ENTER** on the remote control or Dimension Digital Controller front panel.

The LS-12HBd OSD menus are arranged hierarchically, as shown in Figure 4-1. Some menu options apply only to certain input signal types. For example, Phase and Tracking can only be adjusted for RGB, Component video or SCART signals.

4.1 Using the On-Screen Menus

Input Source	Composite 1	HDMI 1
	Composite 2	HDMI 2
	Composite 3	HDMI 3
	Component	HDMI 4
	HD 1	HDMI 5
	HD 2	HDMI 6
	SCART	HDMI 7
	DisplayPort	HDMI 8
Aspect Ratio	16:9	
	4:3	
	Letterbox	
	VirtualWide	
	Cinema	
	Virtual Cinema	
	Native	
Auto Cinema		
Screen	Screen 1 / Screen 2	
Picture	Brightness	
	Contrast	
	Color	
	Tint	
	Sharpness	
	Noise Filter	
Input Position	Left/Right	
	Up/Down	
	Width	
	Height	
	Overscan	
	Overscan Mode (Zoom/Crop)	
	Phase (RGB/Component/SCART signals only)	
	Tracking (RGB/Component/SCART signals only)	
Memory Presets	Recall ISF Night or ISF Day	
	Recall/Save Custom 1 or Custom 2	
	Reset Custom 1 and Custom 2 to Factory Default	
3D Processing	3D Mode (Auto, Off, Side-by-Side, Top-and-Bottom or Frame Packing)	
	Reverse Eyes (On/Off)	
Sleep Timer	Off, 30 Minutes, 60 Minutes, 90 Minutes, 2 Hours or 4 Hours	
Information	Signal	
	System	
	Network	
	Field Service	
	Manufacturing	

Calibration	Display Color - Common Settings	Gain		
		Offset	-100, -99... 0 ... 99, 100 (Red, Green, Blue)	
		Gamma	Mode (Simple / Advanced)	Simple (1.8, 2.0, 2.2 , 2.35, 2.5)
			Advanced	0 (2.2 gamma curve), 1, 2, 3 ... 20 (custom gamma tables)
			Color Temp	Simple (5500K, 6500K , 7500K or 9300K)
			Color Gamut*	Auto , REC709, SMPTE-C, EBU, Native or PCE
		PCE*	Red x, y / Green x, y / Blue x, y / White x, y / Yellow x, y / Cyan x, y / Magenta x, y	
		Display Color - Projector Settings	Lamp	Power (230W or 260W)
		Input Image	Brightness	
			Contrast	
	Color		-50, -49 ... 0 ... 49, 50	
	Sharpness			
	Input Color	Gain	-32, -31... 0 ... 31, 32 (HD 1, HD 2 and Component inputs only)	
		Offset		
		Chroma Delay	0 , 1, 2 ... 7 (Composite inputs only)	
		Noise Filter	0 , 1, 2 ... 63	
	Save ISF Night	Back / Confirm		
	Save ISF Day			
	Copy/Paste	Memory Preset	Copy Settings	
			Paste Settings	
		Aspect Ratio	Copy Settings	
	Output Shift	Left/Right	-50, -49 ... 0 ... 49, 50	
		Up/Down		
		Width	-50, -49, 48 ... 0	
		Height		
		Screen Masking	0 , 1, 2 ... 100 (Top / Bottom / Left / Right / Test Pattern Enable)	
	Image Alignment	Corner Alignment	Top Left / Top Right / Bottom Left / Bottom Right / Test Pattern Enable	
		Midpoint Alignment	Center / Top Middle / Left Middle / Right Middle / Bottom Middle / Test Pattern Enable	
Adjustment Mode	Both , Primary or Secondary			
Splash Configure	Owner Name			
	ISF Calibrated			
	ISF Other			
	Splash Timer	5, 6, 7 ... 15 ... 59, 60		
	Splash Enable	On/Off		
OSD Position	Hor. / Ver.	0 , 1, 2 ... 100		

Note: Default settings appear in **bold type**. Settings marked with an asterisk (*) apply to 2D content only.

Figure 4-1. LS-12HBd OSD Menu Structure

Service	Test Video	Color Bars 1	
		Color Bars 2	
		Focus	
		Grey Bars	
		Full White	
		Primary / Secondary / Dual Alignment	
		3D	
	Input Names	Rename/Restore	
	Remote Control	Remote Code	00000 ... 08209 ... 65535 or 88999 (extended mode)
		SRC 1-7 Keys	(select a key, then choose a source to assign to it)
		SRC 8-14 Keys	
	Display Device - Configure	Installation - Picture Orientation	Auto, Floor Front , Ceiling Front, Floor Rear or Ceiling Rear
		Lens	Focus
			Zoom
			Shift
		Display Info. (read-only)	Projector Serial Number Lamp Hours
		Lamp Hours Reset	Yes / No
		Diagnostics	White, Red, Green, Blue, Yellow, Cyan, Magenta
		Altitude	Auto / High
		Display 3D Settings	(n/a)
		Internal 3D Settings	Sync Delay Test Pattern Enable
	24Hz 3D Mode	120 Hz 6:4 or 120 Hz 5:5	
	Network	IP Configuration	DHCP (On / Off), IP Address, Subnet Mask, Default Gateway, Communication Test
		Auto Firmware Upgrade	Auto Check for New Firmware, Auto Perform Upgrade, Check for New Firmware
		E-Mail Notification	E-Mail Address, Error Notification, Error Notification to Runco, Periodic Service Notification, Lamp Life Notification, Customer Information, E-Mail Calibration Data
		Remote Network Control	On / Off
	Color Space	Auto , REC601, REC709, RGB-PC or RGB-Video	(Not available on Composite 1, Composite 2 or Composite 3 inputs)
	Triggers	1 / 2 / 3	
	Miscellaneous	Language	English , Français, Deutsch, Italiano, Español, Svenska, 简体中文 (Simplified Chinese), 繁體中文 (Traditional Chinese), Português, Русский (Russian), 日本語 (Japanese) or 한국어 (Korean)
		OSD Timer	0 (no timeout) or 5, 6, 7 ... 30 ... 60 sec.
		OSD Messages	On / Off
		Blank Screen Color	Red/Green/Blue = 0 , 1, 2, 3 ... 255
		Sidebar Color	
Film Mode (SD sources only)		On / Off	
CUE (Chroma Upsampling Error)		On / Off	
Sync Threshold	0, 1, 2 ... 15 (HD 1, HD 2 and Component inputs only)		
HDMI	HDMI EDID Extension	On / Off (per HDMI and DisplayPort input)	
	Audio Format	Combined / HDMI Out (Pri. Display) / HDMI Out (Sec. Display) / HDMI Out (Audio Only)	
	CEC	On / Off	
	HPD Toggle Rejection	Auto / On / Off	
Front Panel Brightness	Logo LED	0 (off), 1, 2 ... 31	
	Standby LED	On / Off	
	LCD	0 (off), 1, 2, 3 or 4	
Auto Power Off	Enable	On / Off / No Signal	
	Hours	1 , 2, 3, 4, ... 23, 24	
Standby Mode	Low Power / Fast Startup		
System Reset			

Figure 4-1. LS-12HBd OSD Menu Structure (continued)

The Main Menu is the starting point for accessing all Dimension Digital Controller functions.

(You must enter a passcode to access the Calibration and Service menus.)

◀ **Main Menu**

Runco Video	
→	Input Source
	Aspect Ratio
	Screen
	Picture
	Input Position
	Memory Presets
	3D Processing
	Sleep Timer
	Information
	Calibration
	Service

From the Main Menu, select Input Source to choose a video signal source.

The active source is indicated by an arrow (→) to its left; in this example, Composite is the active source.

◀ **Input Source**

Input Source	
→	Composite 1
	Composite 2
	Composite 3
	Component
	HD 1
	HD 2
	SCART
	HDMI 1
	HDMI 2
	HDMI 3
	HDMI 4
	HDMI 5
	HDMI 6
	HDMI 7
	HDMI 8
	DisplayPort

Aspect Ratio ➤

Aspect Ratio	
<input checked="" type="checkbox"/>	16:9
<input type="checkbox"/>	4:3
<input type="checkbox"/>	Letterbox
<input type="checkbox"/>	VirtualWide
<input type="checkbox"/>	Cinema
<input type="checkbox"/>	Virtual Cinema
<input type="checkbox"/>	Native
<input type="checkbox"/>	Auto Cinema

To change the aspect ratio (size and shape) of the projected image, select Aspect Ratio from the Main Menu and press **ENTER**. Select the appropriate aspect ratio for your screen size and the type of program material being viewed; refer to Table 4-1.

The currently-selected aspect ratio is indicated by a “☒” to its left; in this example, 16:9 is selected.

Note that some aspect ratios are unavailable and/or not useful with certain types of source material. The optimal setting depends on a number of factors, such as:

- The aspect ratio of the source material, as broadcast or encoded on the playback medium.
- The “display type” (16:9 or 4:3) and output resolution settings at the source component. Most modern DVD/BD players and set-top boxes have such controls.
- Viewer preference (original aspect ratio with “black bars,” or a full-screen presentation with some distortion or cropping).



Note

The aspect ratio selection is automatically saved for each input and resolution.

Table 4-1. Aspect Ratio Settings

Aspect Ratio	Remote Control Key	Description
16:9	16:9	 
4:3	4:3	

Table 4-1. Aspect Ratio Settings (continued)



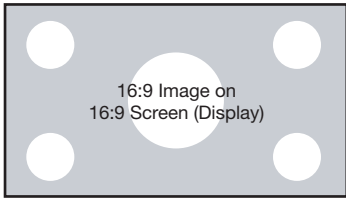
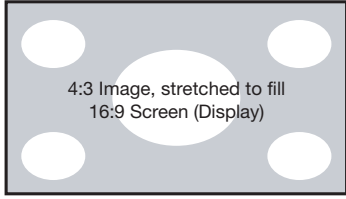
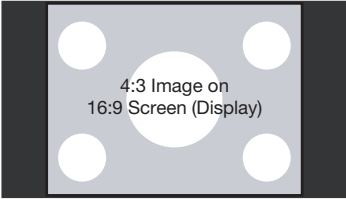

Aspect Ratio	Remote Control Key	Description	
Letterbox	LET BOX		<p>Letterbox mode scales (zooms in on) a 4:3 image linearly (by the same amount on all sides) to fill a 16:9 display. Letterbox is best suited for viewing LaserDisc movies or non-anamorphic DVDs on a 16:9 screen.</p>
VirtualWide	V-WIDE	  	<p>VirtualWide scales a 4:3 image NON-linearly (more on the sides than in the center) to fit a 16:9 screen.</p> <p>On a 2.35:1 screen, the image is centered between black bars on either side.</p>
Cinema	CINEMA	 	<p>Select Cinema to view 2.35 source material in its native aspect ratio.</p> <p>With a 16:9 screen and a standard LS-12HBd (without an anamorphic lens), the upper and lower portions of the screen are masked, but the geometry of the active image area is unchanged.</p> <p>With a 2.35:1 screen and an anamorphic lens, the Dimension Digital Controller scales the 2.35:1 image so that the active image area fills the 16:9 chip surface, eliminating the black bars. The secondary, anamorphic lens then restores the proper geometry to the 2.35:1 image.</p>

Table 4-1. Aspect Ratio Settings (continued)

Aspect Ratio	Remote Control Key	Description	
Virtual Cinema	V-CINE	 <p>16:9 Image on 2.35:1 Screen</p>  <p>16:9 Image on 2.35:1 Screen with Virtual Cinema</p>	<p>A 16:9 image is scaled NON-linearly (more on the sides than in the center) to fit a 2.35:1 screen.</p>
Native	NATIVE	 <p>1080i HDTV Image</p>  <p>720p HDTV Image</p>	<p>Select Native to display the source signal in its native resolution, centered in the display area with no re-sizing or overscan.</p> <p>This means, for example, that 720p HDTV programs will display with unused pixels on all sides: 320 on the left and right sides and 180 above and below.</p> <p>With SDTV and EDTV sources, the Dimension Digital Controller scales the image horizontally to achieve a 16:9 aspect ratio.</p>
Auto Cinema	--	<p>Select Auto Cinema to have the Dimension Digital Controller apply the Cinema aspect ratio to 2.35:1 source material automatically, when detected. To all other content, Auto Cinema applies the 16:9 aspect ratio.</p>	

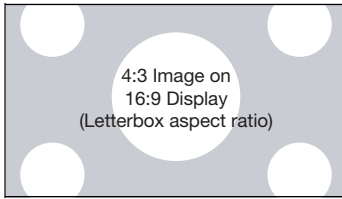
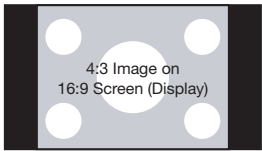
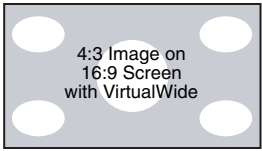
Screen ➤

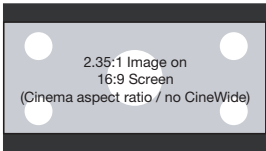
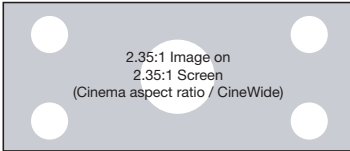
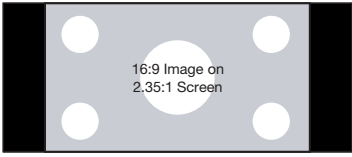
Screen
Screen 1
Screen 2

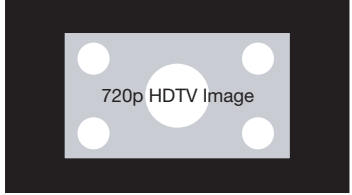
The Screen Menu allows you to recall multiple sets of stored values for certain controls (Output Shift, Image Alignment and Screen Masking) that are saved for each aspect ratio. Such settings are also saved “per screen.” To recall the Output Shift and Image Alignment settings associated with “Screen 1” or “Screen 2,” make that selection here.

Use the controls in the Picture Menu to calibrate each Dimension Digital Controller input to achieve optimum picture quality.

The Dimension Digital Controller has been designed to incorporate setup and calibration standards established by the Imaging Science Foundation (ISF). The ISF has developed carefully crafted, industry-recognized standards for optimal video performance and has implemented a training program for technicians and installers to use these standards to obtain optimal picture quality from Runco video display devices. Accordingly, Runco recommends that setup and calibration be performed by an ISF certified installation technician.

All signal types require separate processing. Therefore, you need to calibrate each Dimension Digital Controller input separately.

◀ **Picture**

Picture
Brightness
Contrast
Color
Tint
Sharpness
Noise Filter



Note

*When you change a picture quality setting, save the change to a preset afterwards. Otherwise, the change will be lost when a different input is selected. (Picture quality settings are saved for each input and display mode separately.) For information about saving settings, refer to **Memory Presets** on page 70.*

Although it may be possible to obtain satisfactory picture quality using the naked eye and regular program material, Runco recommends using an external test pattern source (Ovation Multimedia, Digital Video Essentials or AVIA test DVD or equivalent) for best results.

Connect your test pattern source to the input that you are calibrating and proceed as follows. **Perform the adjustments in the order listed here.**

Brightness: On your external test pattern source, select a PLUGE pattern. (PLUGE is an acronym for “Picture Line-Up Generation Equipment.”) Figure 4-2 shows a typical PLUGE pattern.

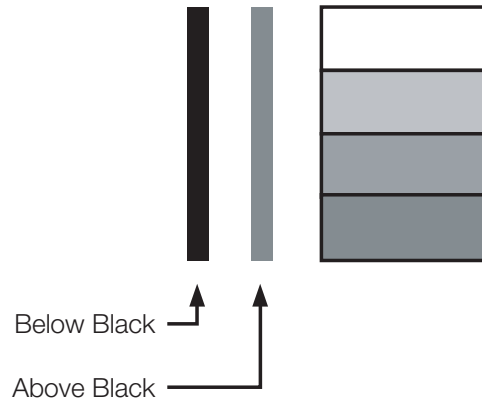

Figure 4-2. Typical PLUGE Pattern for Adjusting Brightness

PLUGE patterns vary but generally consist of some combination of black, white and gray areas against a black background. The example above includes two vertical bars and four shaded boxes.

Select Brightness from the Picture menu and press **ENTER**. Adjust the brightness so that:

- The darkest black bars disappear into the background.
- The dark gray areas are barely visible.
- The lighter gray areas are clearly visible.
- The white areas are a comfortable level of true white.
- The image contains only black, gray and white (no color).

Contrast: On your external test pattern source, select a stepped, gray-bar pattern like the one shown in Figure 4-3.

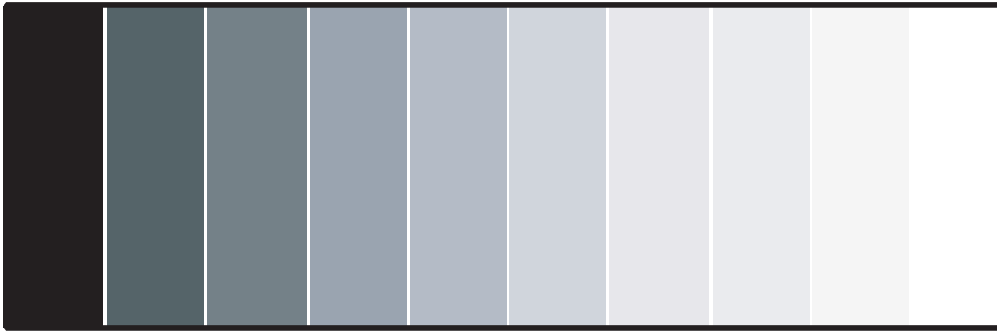

Figure 4-3. Typical Gray Bar Pattern for Adjusting Contrast

Select Contrast and press **ENTER**. Adjust the contrast to a point just below which the white rectangle starts to increase in size.



Note

Brightness and contrast controls are interactive. A change to one may require a subtle change to the other in order to achieve the optimum setting.

Color Saturation: On your external test pattern source, select a color bar pattern like the one shown in Figure 4-4.

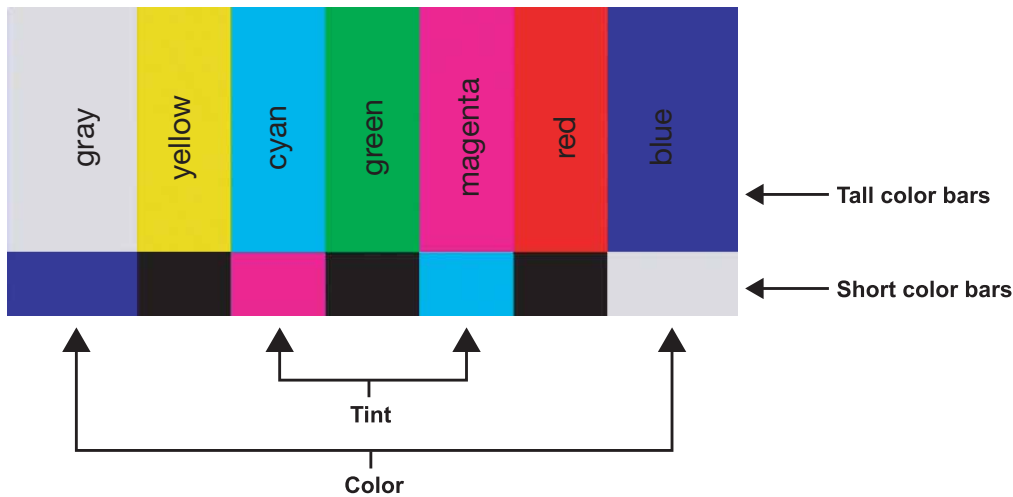
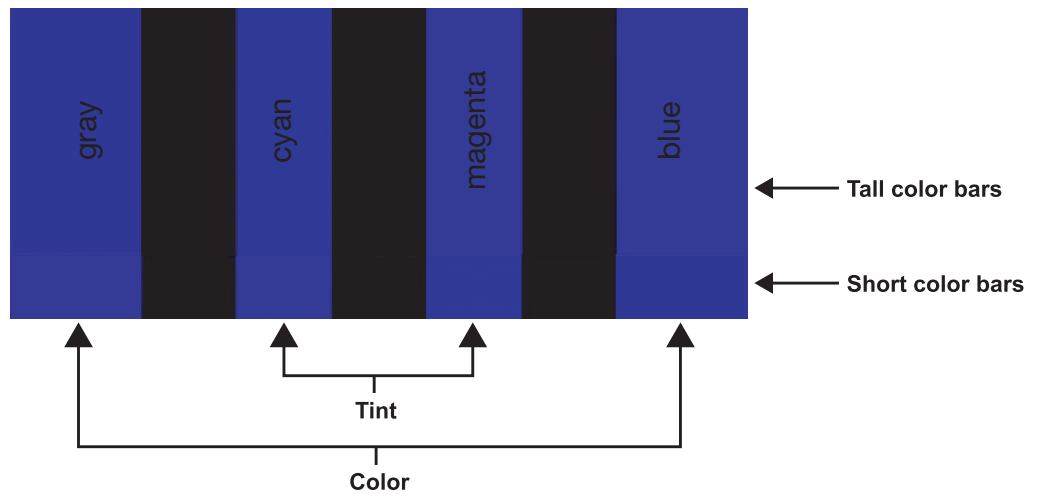

Figure 4-4. Typical Color Bar Pattern for Adjusting Color Saturation and Tint

1. Press the **MENU** button on the remote control or Dimension Digital Controller front panel.
2. Select Service from the Main Menu and press **ENTER**.
3. Enter the Service menu passcode.
4. Select Display Device from the Service menu and press **ENTER**.

5. Press **ENTER** again to select Configure.
6. Select Diagnostics and press **ENTER**.
7. Select Blue from the Diagnostics menu, then press **ENTER** to display only the blue color channel.
8. Press **EXIT** (or **MENU**) repeatedly to return to the Main Menu.
9. Select Picture from the Main Menu and press **ENTER**.
10. Select Color from the Picture menu and press **ENTER**.
11. Adjust the color saturation level until the outermost (gray and blue) color bars appear to be a single shade of blue:



Tint: Tint or “hue” is essentially the ratio of red to green in the color portion of the image. When tint is decreased, the image appears redder; when it is increased the image appears greener.

To adjust the tint, enable “blue only” display mode in the Diagnostics menu, as you would for adjusting color saturation (refer to the previous section, **Color Saturation**).

Select Tint from the Picture menu and press **ENTER**. Adjust the tint level until the cyan and magenta color bars (on either side of the green bar) appear to be a single shade of blue.



Note

Like the brightness and contrast controls, the color and tint controls are interactive. A change to one may require a subtle change to the other in order to achieve the optimum setting.

Sharpness: “Sharpness” is the amount of high-frequency detail in the image. To adjust sharpness, select Sharpness from the Picture menu and press **ENTER**. On your external test pattern source, select a pattern like the one shown in Figure 4-5. Adjust as needed, looking for white edges around the transitions from black to gray and differently-sized lines in the “sweep” patterns at the top and bottom. Lower the sharpness setting to eliminate them.

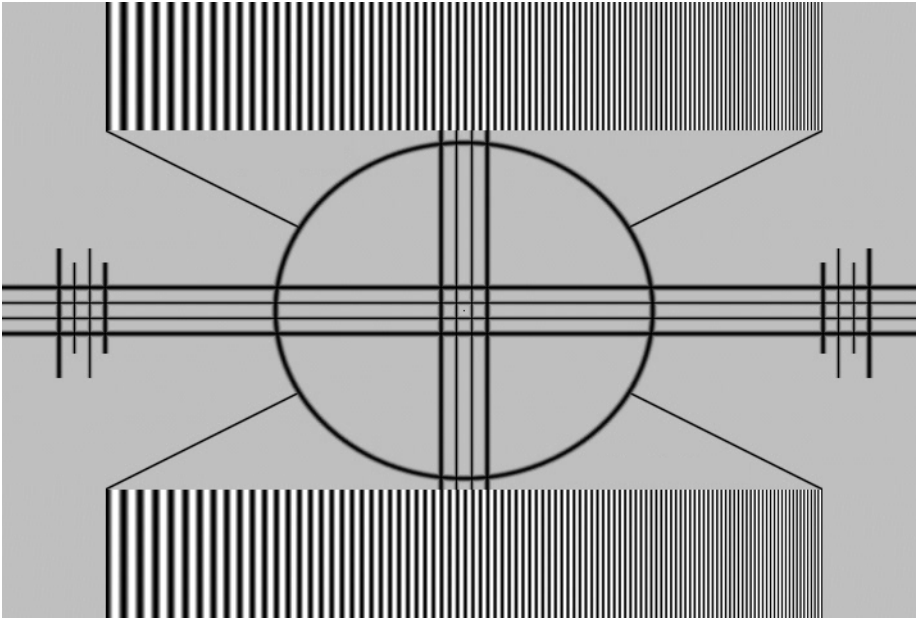

Figure 4-5. Typical Test Pattern for Adjusting Sharpness

Noise Filter: To apply noise filtering to the input signal, select Noise Filter from the Picture menu. The Noise Filter is useful for clearing up noisy images from 480i video sources.

Use the left- or right-arrow buttons to select the desired amount of noise reduction, keeping in mind that higher settings (which reduce high frequencies) may also “soften” the image.

Input Position ►

Use the controls in the Input Position Menu to fine-tune the aspect ratio and image position for the current source.

Input Position
Left/Right
Up/Down
Width
Height
Overscan
Overscan Mode
Phase
Tracking



Note

The input position settings are automatically saved for each input and resolution.

Left/Right: Select Left/Right from the Input Position menu to shift the projected image horizontally. Press ► to shift the image to the right; press ◀ to shift it to the left.

Up/Down: Select Up/Down from the Input Position menu to shift the projected image vertically. Press ► to shift the image upward; press ◀ to shift it downward.

Width: Select Width from the Input Position menu to change the projected image width. Press ► to increase the width; press ◀ to decrease it.

Height: Select Height from the Input Position menu to change the projected image height. Press ► to increase the height; press ◀ to decrease it.

Overscan/Overscan Mode: Overscan pushes the outside edge of the active picture area of the video signal out beyond the edge of the display area.

Some television programs are produced based on the assumption that older television sets may not display the outer edges of the broadcast picture area. Overscan effectively trims away these inactive, outer edges and enlarges the remaining portion of the image to fill the display area.

For HDTV, DVDs and other video sources, Overscan is generally not necessary or desirable.

This control defines the amount of overscan applied to the image. The range is from 0 to 20. There are two overscan modes:

- In **Crop** mode, each increment adds a mask at the top, bottom, left and right edges of the source image equal to 0.5% of the displayed horizontal resolution (1% total). A setting of 10, for example, crops the image 5% on all sides or 10% total.
- In **Zoom** mode, each increment adds a factor to the scaling of the source image so that the vertical and horizontal resolutions are 100% plus 1% increments of the size determined by the aspect ratio function. A setting of 10, for example, zooms in on the image 5% on all sides or 10% total.

Figure 4-6 illustrates the effect of each overscan mode setting.

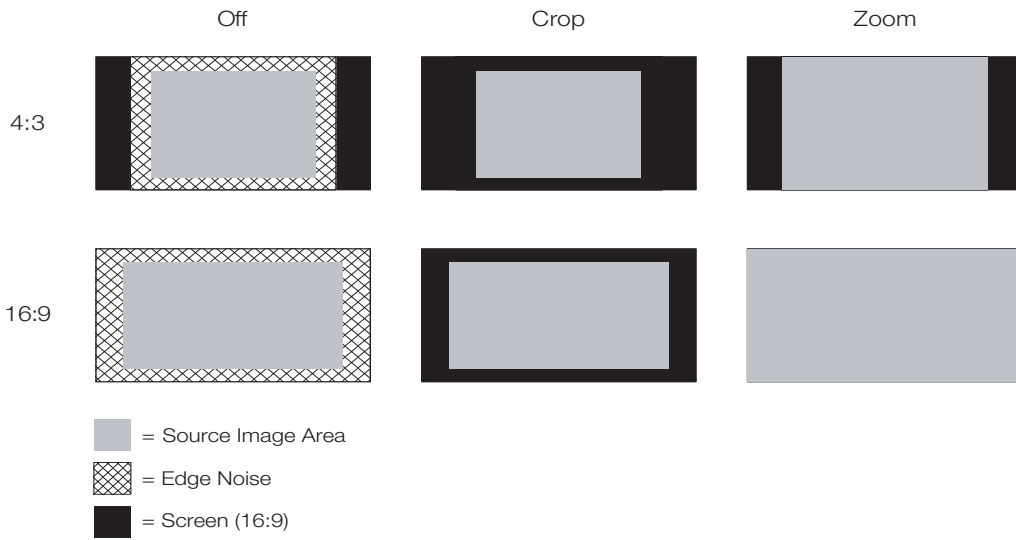

Figure 4-6. Overscan Modes

Phase (RGB, Component or SCART sources): This control adjusts the phase of the pixel sampling clock relative to the incoming signal. Adjust the phase when an RGB, Component or SCART image still shows shimmer or “noise” after Tracking has been optimized.



Tip

Adjust the Phase after adjusting Tracking (see below).

For best results, use a good test pattern such as a smooth gray consisting of a clear pattern of black and white pixels, or a similar “half on, half off” graphic image. Adjust the slider until the image stabilizes and each pixel is clearly defined. You may notice that you can stabilize the image at more than one point. Use either setting in such cases.

Tracking (RGB, Component or SCART sources): Tracking determines the frequency of the pixel sampling clock, indicated by the number of incoming pixels per line, so that all pixels generated by a particular source are sampled.

Steady flickering or several soft vertical stripes or bands across the entire image indicates poor pixel tracking. Proper pixel tracking helps ensure that the image quality is consistent across the screen, that aspect ratio is maintained and that pixel phase (see above) can be optimized.

Memory Presets ➤

Memory Presets		
➔	ISF Night	
	ISF Day	
	Custom 1	Save Reset
	Custom 2	Save Reset

For each input, the Dimension Digital Controller lets you save image quality settings as presets that you can recall at a later time. You can create up to four presets per input and display mode (resolution and frame rate).

The Dimension Digital Controller stores the following display modes in each memory preset:

- 480i
- 480p
- 576i
- 576p
- 720p/24 Hz
- 720p/25 Hz
- 720p/30 Hz
- 720p/50 Hz
- 720p/60 Hz
- 1080i/50 Hz
- 1080i/50 Hz (Australia)
- 1080i/60 Hz
- 1080p/24 Hz
- 1080p/25 Hz
- 1080p/30 Hz
- 1080p/50 Hz
- 1080p/60 Hz

Use the Memory Presets menu to recall saved image presets, or to save image settings in the “Custom 1” or “Custom 2” memory location. The currently-selected preset is indicated by a “➔” to its left; in the example shown here, ISF Night is selected.

You should save changes to any of the following settings to a preset; otherwise they will be lost when a new input source or resolution is selected:

- Brightness
- Contrast
- Color saturation
- Tint
- Sharpness
- Gamma
- Lamp Settings
- Color temperature and white balance

To select a memory preset, press ▲ or ▼ to highlight it and press **ENTER**.

To save the settings for the current input and display mode to the Custom 1 or Custom 2 memory preset, select it, press ◀ or ▶ to highlight Save and press **ENTER**.



Note

To save the settings for the current input and display mode to the ISF Night or ISF Day memory preset, select Save ISF Night or Save ISF Day from the Calibration menu (refer to **Save ISF Night/Save ISF Day** on page 78).

To reset the Custom 1 or Custom 2 memory preset to its factory-default state, select it, press ◀ or ▶ to highlight Reset and press **ENTER**.

Select 3D Processing from the Main Menu to set the following options related to formatting and delivery of HDMI 3D content.

3D Mode: Select 3D Mode from the 3D Processing menu to specify how the Dimension Digital Controller processes the “left eye” and “right eye” image components respectively.

- Choose **Auto** to have the Dimension Digital Controller determine the appropriate 3D mode based on the HDMI vendor-specific InfoFrame data. This is the default setting.
- Choose **Off** for 2D content.
- Choose **Side-by-Side** to have the Dimension Digital Controller scale the left and right image halves respectively to fill the screen.

Side-by-Side multiplexing is used with 1080i source material.

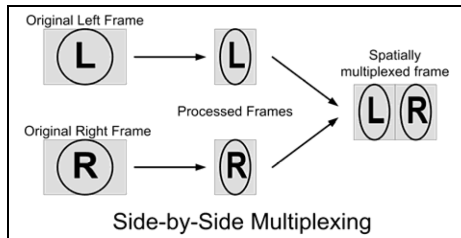

- Choose **Top-and-Bottom** to have the Dimension Digital Controller scale the top and bottom image halves respectively to fill the screen.

Top-and-Bottom multiplexing is used with 720p or 1080p source material.

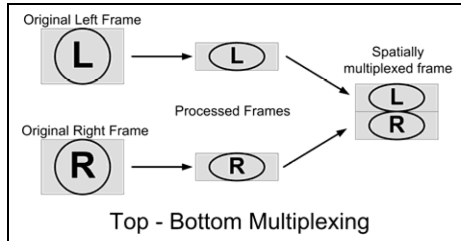

- Choose **Frame Packing** to have the input FPGA decode frame packed data into left and right eye data.

Reverse Eyes: By default, the Primary and Secondary video scalers in the Dimension Digital Controller are dedicated to “left eye” and “right eye” image processing respectively. To reverse this relationship, choose Reverse Eyes from the 3D Processing menu and set it to **On**.

◀ **3D Processing**

3D Processing
3D Mode
Reverse Eyes

Sleep Timer ➤

Select Sleep Timer from the Main Menu to turn off the LS-12HBd after a specified interval. Press ▲ or ▼ to select Off, 30 Minutes, 60 Minutes, 90 Minutes, 2 Hours or 4 Hours. Then, press **ENTER**.

Sleep Timer	
➔	Off
	30 Minutes
	60 Minutes
	90 Minutes
	2 Hours
	4 Hours

Information ➤

Signal / System: Select Information from the Main Menu, then choose either Signal or System to display information about the current input signal (resolution, frequency, type et cetera) and installed firmware versions, as well as other information that uniquely identifies your Dimension Digital Controller and display device.

Information	
	Signal
	System
	Network
	Field Service
	Manufacturing

Should you ever need to contact Runco Technical Support, this information will help them answer your questions or resolve product performance issues.

Signal	
Input Source	HDMI 1
Signal Format	1080p/60
Input Resolution	1920x1080
Vertical Freq	59.94 Hz
Horizontal Freq	67.500 kHz
Pixel Clock	148.500 MHz
Color Space	REC709
Sync Type	Separate
3D Mode	Side-by-Side
Memory Preset	ISF Night

System	
Model	DC-300
Display Name	LS-12HBd
Output Resolution	1920x1080
Serial Number	00000000
Boot Version	1.0
Firmware Version	1.5
Micro Version	1.2
Input FPGA Version	1.0
Output FPGA Version	1.0

Network: Select Information from the Main Menu, then choose Network to display information about the Ethernet network connection.

Network	
MAC Address	1A:2B:3C:4D:5E:6F
IP Address	192.168.0.150
Subnet Mask	255.255.0.0
Default Gateway	192.168.1.1
DHCP	Enabled
Network Status	Connected

To enable network communication via Ethernet, refer to **IP Configuration** on page 86.

Field Service / Manufacturing: The Field Service and Manufacturing menus are password-protected and intended for use only by Runco service personnel and factory technicians.

Use the Calibration menu to perform advanced picture quality adjustments. **This menu should be used by ISF-certified technicians only.**

◀ **Calibration**



Note

You must enter a passcode to access the Calibration menu.

To recall the ISF Night or ISF Day settings, select “ISF Night” or “ISF Day” from the Memory Presets menu (see page 70) or use the corresponding remote control buttons.

Display Color - Common Settings: Use the Display Color - Common Settings menu to adjust the color balance at the Dimension Digital Controller output. These settings are saved independently for each input and display mode.

- **Gain:** Use the Gain controls to correct color imbalances in the bright areas of the image. A good way to do this is to use a test pattern consisting mostly of solid white areas, such as an 80 IRE “window” pattern. If the white areas contain traces of red (Pr), green (Y) or blue (Pr), decrease the Gain for that color.
- **Offset:** Use the Offset controls to correct color imbalances in the dark areas of the image. A good way to do this is to use a test pattern consisting mostly of dark gray areas, such as a 30 IRE “window” pattern. If the gray areas contain traces of red (Pr), green (Y) or blue (Pr), decrease the Offset for that color.
- **Gamma:** Select Gamma from the Display Color - Common Settings menu to choose a de-gamma curve. Used correctly, the Gamma control can improve contrast while maintaining good details for blacks and whites. If excess ambient light washes out the image and it becomes difficult or impossible to see details in dark areas, lower the gamma setting to compensate. This improves contrast while maintaining good details for blacks. Conversely, if the image is washed out and unnatural, with excessive detail in black areas, increase the setting.
- **Mode:** With the LS-12HBd, two Gamma adjustment modes are available: Simple or Advanced. The two modes are mutually exclusive; when you select the Simple mode, the Advanced selection in the Gamma menu is grayed out. Likewise, when you select Advanced, the Simple selection is grayed out.
- **Simple:** Use the Simple Gamma control to perform gamma correction at the display according to a simple power law gamma function. The value chosen here corresponds to the power variable in this equation:

$$\text{Output} = \text{Input}^{\text{Power}}$$

The Dimension Digital Controller applies this gamma curve to all three primary color channels (red, green and blue).

- **Advanced:** To select a custom gamma curve, select Mode from the Gamma menu and set it to Advanced. Then, select Advanced from the Gamma menu to select one of up to 20 pre-programmed gamma tables. Custom gamma tables provide the ability to perform complex, non-linear gamma correction on each primary color channel independently of the others.

Calibration	
ISF Settings	
Display Color	
Input Image	
Input Color	
Save ISF Night	
Save ISF Day	
Copy/Paste	
Output Shift	
Image Alignment	
Adjustment Mode	
Splash Configure	
OSD Position	

- **Color Temp:** Select Color Temp from the Display Color - Common Settings menu to adjust the color temperature. Color temperature establishes the “color of gray” by adjusting the 75% white point to various color points.

What are “color points?” A “color point” is an x/y coordinate pair that defines a color’s location on the standard CIE chromaticity graph, shown in Figure 4-7. (CIE stands for “Commission Internationale de l’Éclairage” (International Commission on Illumination), the organization responsible for color measurement and management standards.)

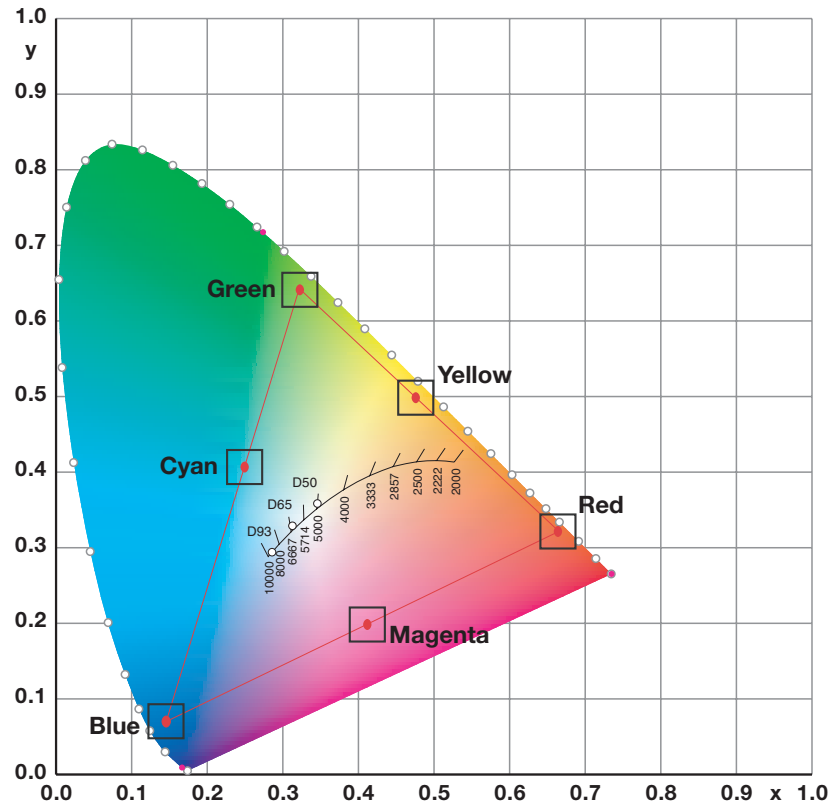

Figure 4-7. CIE 1931 Chromaticity Diagram

- **Simple:** Select Simple mode from the Color Temp menu (with the LS-12HBd, this is the only choice) to choose one of five color temperature presets: 3200K, 5500K, 6500K, 7500K and 9300K. The default setting, 6500K, is appropriate for most situations. Higher settings produce a “bluer” picture; lower ones impart a reddish hue to the image.

Table 4-2 lists the x- and y-coordinates for each color temperature preset in “Simple” mode.

Table 4-2. Color Temperature Presets and Associated Color Points

Color Temperature Preset	Associated x/y Values	
	x	y
3200K	0.423	0.404
5500K	0.332	0.348
6500K	0.313	0.329
7500K	0.299	0.315
9300K	0.284	0.298

- **Color Gamut:** Select Color Gamut from the Display Color - Common Settings menu to select a color gamut (range) that may be different from the default color gamut.

Each setting defines the precise hue of each primary (red, green and blue) and secondary (yellow, cyan and magenta) color component used to generate the millions of colors produced in displays. Changing this setting relocates the “triangle” for possible colors (see Figure 4-7). For example, changing the x/y coordinates for red moves the color closer to either orange or violet, which in turn affects all displayed colors having a red component.



Note

1. The Color Gamut setting only affects 2D content.
2. The Dimension Digital Controller uses the Color Gamut settings for all display modes on a given input.

- The default setting, **Auto**, automatically chooses the appropriate color gamut:
 - **SMPTE C** for NTSC, 480i and 480p sources.
 - **EBU** for PAL, SECAM, 576i and 576p sources.
 - **REC709** for all other sources.
- Select **REC709** to use the color gamut defined in ITU-R BT.709-5.
- Select **SMPTE-C** to use the color gamut defined in SMPTE 170M-1999.
- Select **EBU** to use the color gamut defined in EBU Tech. 3213-E.
- Select **Native** to use REC709 for cyan, magenta, and yellow and uncorrected values for red, green, and blue.
- Select **PCE** to use the Personal Color Equalizer feature of the LS-12HBd. PCE lets you define a custom color gamut. Refer to the next section, **PCE**, for instructions on how to do this.

Table 4-3 lists the Color Gamut settings and associated x- and y-coordinates for each primary and secondary color component.

Table 4-3. x/y Color Gamut Values

Primary Color	Color Gamut Settings and Associated x/y Values					
	REC709		SMPTE "C"		EBU	
	x	y	x	y	x	y
Red	0.640	0.330	0.630	0.340	0.640	0.330
Yellow	0.419	0.505	0.421	0.507	0.418	0.502
Green	0.300	0.600	0.310	0.595	0.290	0.600
Cyan	0.225	0.329	0.231	0.326	0.220	0.329
Blue	0.150	0.060	0.155	0.070	0.150	0.060
Magenta	0.321	0.154	0.314	0.161	0.328	0.158

- **PCE:** To use the Personal Color Equalizer to define a custom color gamut, choose the "PCE" Color Gamut setting (refer to **Color Gamut** on page 75). Then, choose PCE from the Display Color - Common Settings menu and press **ENTER**.



Note

1. The PCE setting only affects 2D content.
2. The Dimension Digital Controller uses the PCE settings for all display modes on a given input.

PCE provides the ability to define a custom color gamut in terms of a "white point" and primary (red, green, blue) color points; see Figure 4-7.

- **RGBW (Red, Green, Blue, White):** To precisely adjust the primary color points and white point associated with the custom color gamut, choose RGBW from the PCE sub-menu. Each control operates only on the color specified. Surrounding colors are linearly interpolated based on their distance from each of these colors.

Display Color

RGBW

Red x 0.640

Red y 0.330

Green x 0.300

Green y 0.600

Blue x 0.150

Blue y 0.060

White x 0.313

White y 0.329

Auto Color Enable

Test Pattern Enable

The **Auto Color Enable** and **Test Pattern Enable** checkboxes let you choose what to display on-screen while making these adjustments. These controls work together as follows:

Auto Color Enable Setting	Test Pattern Enable Setting	Description
Off	Off	When both boxes are unchecked, the input signal (normal picture) appears on the display.
Off	On	When only the Test Pattern Enable box is checked, a white "curtain" test pattern appears instead of the input signal.
On	Off	When only the Auto Color Enable box is checked, the input signal appears on the display. When you select a red, green, blue, yellow, cyan or magenta color point to adjust, the Dimension Digital Controller displays only that color channel. When you select a white point x- or y-value, all colors are visible (normal picture).
On	On	When both boxes are checked, the Dimension Digital Controller automatically displays a red, green, blue, yellow, cyan, magenta or white "curtain" test pattern when you select an x- or y-value for that color point to adjust.

- **YCM (Yellow, Cyan, Magenta):** To precisely adjust the secondary color points associated with the custom color gamut, choose YCM from the PCE sub-menu. Each control operates only on the color specified. Surrounding colors are linearly interpolated based on their distance from each of these colors.

Display Color

YCM

Yellow x 0.419

Yellow y 0.505

Cyan x 0.225

Cyan y 0.329

Magenta x 0.321

Magenta y 0.154

Auto Color Enable

Test Pattern Enable

- **Lamp:** Select Lamp from the Display Color - Projector Settings menu to adjust the projector lamp brightness.
- **Power (230W or 260W):** To supply a constant wattage to the lamp, select Power (230W or 260W) from the Lamp menu to set the lamp power level. You can choose to run the lamp as bright as possible (this is the default setting) or you can choose a lower setting. Generally, lower lamp output prolongs the life of a lamp, but decreases brightness.

Input Image: The Input Image controls are functionally similar to those in the Picture menu (refer to page 63), but are accessible only by entering the Calibration menu passcode.



Note

The Input Image settings establish the “zero point” for the Picture menu settings, whose values represent offsets from the Input Image settings. For example, if you set Brightness to 10 in this menu, setting Brightness to 10 in the Picture menu results in an actual setting value of 20 (10+10).

Input Color: The Input Color controls are similar to those in the Display Color menu (see above), but adjust the color balance of the incoming signal. These settings are also saved independently for each input and display mode.

- **Gain/Offset (HD1, HD2 and Component/SCART inputs only):** These controls operate similarly to those in the **Display Color - Common Settings** menu (described on page 73), but affect the Y, Pb and Pr signal components rather than the red, green and blue channels.
- **Chroma Delay:** use the Chroma Delay control to correct a mis-aligned image from a composite video source. Chroma delay in an image causes color shifts to occur to the left of the vertical edge transitions, producing artificial shadows or a “halo” effect. If necessary, adjust this setting to eliminate them.
- **Noise Filter:** To apply noise filtering to the input signal, select Noise Filter from the Input Color menu. The Noise Filter is useful for clearing up noisy images from 480i video sources.

Use the left- or right-arrow buttons to select the desired amount of noise reduction, keeping in mind that higher settings (which reduce high frequencies) may also “soften” the image.

Save ISF Night/Save ISF Day: Whenever you make a change to the ISF settings, you should always save it. Select Save ISF Night or Save ISF Day from the Calibration menu to do this.

Copy/Paste - Memory Preset: You can copy and paste settings from one memory preset to another. This gives you a convenient starting point for creating a new preset based on an existing one, to make the calibration process less time-consuming.

For example, you can use the Copy/Paste Memory Preset feature to:

- Apply settings from HDMI 1 to HDMI 2, or from HD1 to HD2.
- Calibrate an input for 720p source signals, then use those settings for 1080i sources.
- Duplicate ISF Night settings for a given source and signal format and save them in the Custom 1 memory preset.

To use this feature, select Copy/Paste from the Calibration menu, then select Memory Preset.

- **Memory Preset - Copy Settings:** Select Copy Settings from the Copy/Paste Memory Preset menu to place the settings for the current input source, signal format (resolution and frame rate) and memory preset onto a “clipboard,” which is a temporary memory location. When you do, the message “Settings Copied” briefly appears on-screen. The Copy/Paste menu then re-appears, indicating the source of the copied settings.

Copy/Paste	
Memory Preset	
Aspect Ratio	

Memory Preset	
Copy Settings	
Paste Settings	
Copied From:	
Input Source	HDMI 1
Signal Format	1080p/60
Memory Preset	ISF Night



Copied settings are not retained after a power cycle.

- **Memory Preset - Paste Settings:** To apply the settings on the clipboard to a different input source, signal format and/or memory preset, do **any or all** of the following:
 - Switch to another input (for example, from HD1 to HD2).
 - Change the output signal format at the source (for example, from 720p/60 to 1080i/60).
 - Switch to another Memory Preset (for example, from ISF Night to Custom 1).

Then, select Paste Settings from the Copy/Paste Memory Preset menu. **If you want to keep these new settings, you must save them!** (Refer to **Save ISF Night/Save ISF Day** on page 78 or **Memory Presets** on page 70.)

Copy/Paste - Aspect Ratio: You can also copy and paste certain settings, such as those for Output Shift, Image Alignment (refer to page 80) or Screen Masking (refer to page 80) from one aspect ratio or “screen” (refer to **Screen** on page 62) to another.

To do this, select Copy/Paste from the Calibration menu, then select Aspect Ratio.

- **Aspect Ratio - Copy Settings:** Select Copy Settings from the Copy/Paste Aspect Ratio menu to place the Output Shift, Image Alignment and Screen Masking settings for the current aspect ratio onto a “clipboard,” which is a temporary memory location. When you do, the message “Settings Copied” briefly appears on-screen. The Copy/Paste menu then re-appears, indicating the source of the copied settings.

Copy/Paste	
Memory Preset	
Aspect Ratio	

Aspect Ratio	
Copy Settings	
Paste Settings	
Copied From:	
Aspect Ratio	16:9
Screen	Screen 1



Copied settings are not retained after a power cycle.

- **Aspect Ratio - Paste Settings:** To apply the Output Shift, Image Alignment and Screen Masking settings on the clipboard to a different aspect ratio and/or screen, do **either** of the following:
 - Switch to another aspect ratio (for example, from 16:9 to Cinema).
 - Switch from Screen 1 to Screen 2 or vice versa.

Then, select Paste Settings from the Copy/Paste Aspect Ratio menu. The new settings are saved automatically.

Output Shift: The Left/Right, Up/Down, Width and Height controls in the Output Shift menu are similar to those in the Input Position menu, except that they change the characteristics of the output signal. These settings are saved independently **for each aspect ratio and screen selection** (refer to **Screen** on page 62).

- **Screen Masking:** This control adjusts the amount of cropping on each edge of the output image. This differs from the regular Overscan control in two ways:
 - It allows separate adjustments on each edge; and
 - It is saved per aspect ratio, per screen (as opposed to per connector, per mode).

This is useful for installations where the aspect ratio of the screen doesn't exactly match the aspect ratio of the display.

Image Alignment: Use the controls in the Image Alignment menu to ensure proper image geometry; that is, a perfectly rectangular projected image with no keystone or pincushion. For detailed instructions, refer to **Adjusting the Image Geometry** on page 52.

Adjustment Mode (during 3D Operation): By default, any command or control message you send using the remote control, front-panel keypad or RS-232 interface is acted upon by **both** the Primary and Secondary scalers in the Dimension Digital Controller. In some cases — for example, when using the lens controls or aligning the “left eye” or “right eye” output images — you may need to address a command to only the Primary or Secondary scaler. To do this, select Adjustment Mode from the Calibration menu and set it to **Primary** or **Secondary**. The Main Menu title changes to “Runco Video (Pri.)” or “Runco Video (Sec.)” when you do this.



Note

The Secondary OSD menus are only visible during 3D operation. In 2D mode, you will only see the image from the Primary scaler, regardless of this setting. If you want to adjust the Secondary scaler while in 2D mode, you must use the built-in keypad and VFD on the Dimension Digital Controller.

Splash Configure: Use the Splash Configure menu to control the appearance and behavior of the “splash” screen that appears on the display upon power-up.

- **Owner Name/ISF Calibrated/ISF Other:** You can have the LS-12HBd display the owner's name, your name, the phrase “ISF Calibrated” and/or any other string, up to 30 characters in length.

Use the up or down cursor button to select a character. Use the right and left cursor buttons to change the cursor position. Press **MENU** when you have finished entering text.

- **Splash Timer:** When you turn on the LS-12HBd, it projects a welcome screen with the Runco and ISF logos, along with the personalized information you enter as described above. Select Splash Timer from the Splash Configure menu to set the amount of time for which this screen appears. The range is from 5 to 60 seconds, in one-second increments. Press ◀ or ▶ to set the timer, then press **MENU**.

- **Splash Enable:** When you have finished customizing the splash screen, select Splash Enable from the Splash Configure menu. Then, select On and press **ENTER**.

OSD Position: To adjust the position of the OSD, select OSD Position from the Calibration menu and press **ENTER**.

Press ▲ or ▼ to select “Hor.” or “Ver.” Then, press ◀ or ▶ to change the position.

Use the Service menu to access advanced projector configuration settings. **This menu should be used by ISF-certified technicians only.**

◀ **Service**



Note

You must enter a passcode to access the Service menu.

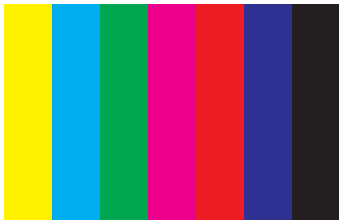
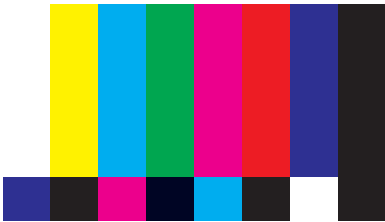
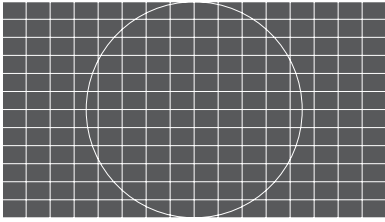

Test Video: Select Test Video from the Service Menu to access the internal test patterns on the Dimension Digital Controller. Table 4-4 lists the available test patterns and describes their suggested usage.

Table 4-4. Test Patterns and Their Suggested Usage

Pattern	Suggested Usage
<p>Color Bars 1</p> 	<p>Use this pattern when making color saturation and tint adjustments.</p>
<p>Color Bars 2</p> 	<p>Use this pattern when making color saturation and tint adjustments.</p>
<p>Focus</p> 	<p>Use this pattern when adjusting the focus.</p>

Service
Test Video
Input Names
Remote Control
Display Device
Network
Color Space
Triggers
Miscellaneous
HDMI
Front Panel Brightness
Auto Power Off
Standby Mode
System Reset

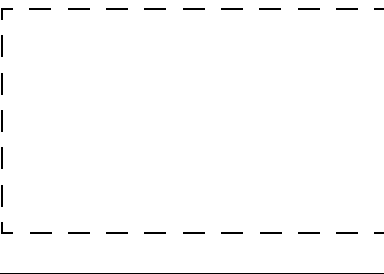
Table 4-4. Test Patterns and Their Suggested Usage (continued)

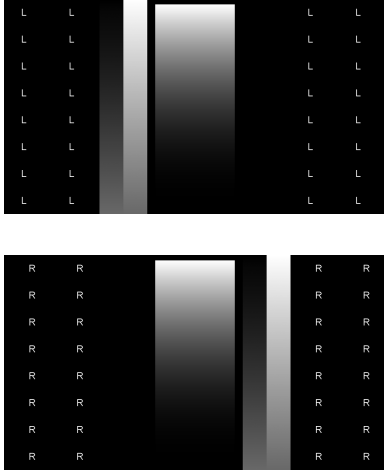
	Pattern	Suggested Usage
<p>Grey Bars</p>		<p>Use this pattern when making brightness, contrast or white balance (gain/offset) adjustments.</p>
<p>Full White</p>		<p>Use this pattern when measuring or adjusting brightness, contrast or white balance (gain/offset).</p>
<p>Primary Alignment Secondary Alignment Dual Alignment</p>		<p>Use this pattern when aligning the output from the projector's primary or secondary optical engines (refer to Adjusting the Image Geometry on page 52). Select Dual Alignment to have both optical engines output this pattern.</p>
<p>3D</p>		<p>Use these patterns to confirm that the left-eye and right eye images are being processed correctly. To do this, close your right eye while viewing this test pattern through the 3D glasses. If you see only the left-eye portion, then the system is correctly configured for 3D.</p> <p>Normally, the Primary scaler processes the left-eye image; the Secondary, the right-eye image. To change this, use the Reverse Eyes control in the 3D Processing menu (refer to Reverse Eyes on page 71).</p>

Press **MENU** to exit test pattern mode.

Input Names: You can give each input a descriptive name. For example, you may want to change the default input name to the type of source component connected to it: “VCR,” “DVD,” “Laptop” et cetera. Input names can be up to 12 characters long.

To edit an input name, select Input Names from the Service menu. Press ▲ or ▼ to select an input and press **ENTER**. Use the ▲ or ▼ buttons to change a character; press ◀ or ▶ to select a character to change. When you have finished editing the input name, press **ENTER** or **MENU**.

To restore the default input name, press ▼ repeatedly to highlight that input name in the “Restore” column. Then, press **ENTER**.

Input Names	
	Restore
Composite 1	Composite 1
Composite 2	Composite 2
Composite 3	Composite 3
Component	Component
HD 1	HD 1
HD 2	HD 2
SCART	SCART
HDMI 1	HDMI 1
HDMI 2	HDMI 2
HDMI 3	HDMI 3
HDMI 4	HDMI 4
HDMI 5	HDMI 5
HDMI 6	HDMI 6
HDMI 7	HDMI 7
HDMI 8	HDMI 8
DisplayPort	DisplayPort

Remote Control: Select Remote Control from the Service menu to set the following options:

- **Remote Code:** Select Remote Code from the Remote Control menu to set the infrared (IR) custom code (address) that the Dimension Digital Controller will accept as valid IR data. By default, it is set to 08209 (0x2011). You can change this setting if:
 - Another device in the theater (a DVD player, for example) is responding to commands from the Dimension Digital Controller remote control (Figure 2-7) in ways that are unpredictable or undesirable; or
 - You have multiple Dimension Digital Controllers and want to control them independently, as opposed to broadcasting commands from a single remote to all of them. In this scenario, you can use multiple remotes programmed to use different IR codes. Or, you can use a single remote and change the IR code as needed to address a specific Dimension Digital Controller.



Tip

Use the Dimension Digital Controller front-panel keypad to change the IR code to which the controller will respond. Then, change the code sent by the remote to match as described below.

After changing the Remote Code, press **EXIT** to have the new code take effect.

When you change the Remote Code on the Dimension Digital Controller, you must re-program the Dimension Digital Controller remote control to send that same code. To enable “extended” key code mode, you must re-program the Dimension Digital Controller remote control with a special five-digit code reserved for that purpose.

To do this:

1. Press and hold the **LIGHT** button on the remote control for approximately five seconds, or until the LED on the remote lights solid red.
2. Enter a new five-digit code between **00000** and **65535** inclusive;

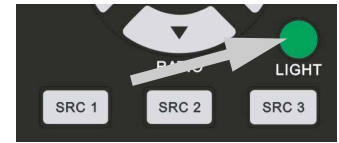

— OR —

To enable extended key code mode, enter **88999**. This mode allows certain buttons to perform alternate functions; refer to **LS-12HBd Remote Control Unit** on page 14. (To switch from extended mode back to standard mode, enter any valid code other than 88999.)

Include leading zeros for codes with four or fewer digits; for example, enter 255 as **00255**.

3. The LED turns off to confirm the code change. If you enter an invalid code, the LED flashes for three or four seconds. Try again, entering a valid code.

For more information on using standard and extended remote control key codes, refer to **Using Discrete IR Codes** on page 117.

- **SRC 1-7 Keys / SRC 8-14 Keys:** Select SRC 1-7 Keys or SRC 8-14 Keys from the Remote Control menu to assign the source selection buttons to the source inputs on the Dimension Digital Controller (refer to **SRC 1, SRC 2 ... SRC 14** on page 17). By default, these buttons are assigned as follows:

Remote Control Button	Default Source Assignment
SRC 1 ... SRC 8	HDMI 1 ... HDMI 8
SRC 9	DisplayPort
SRC 10	Component
SRC 11	HD 1
SRC 12	HD 2
SRC 13	Composite 1
SRC 14	Composite 2

To change a button assignment, select the corresponding entry in the SRC 1-7 Keys or SRC 8-14 Keys sub-menu. Then, choose the source input you wish to assign to that button.

SRC 1 Key	
	Composite 1
	Composite 2
	Composite 3
	Component
	HD 1
	HD 2
	SCART
➔	HDMI 1
	HDMI 2
	HDMI 3
	HDMI 4
	HDMI 5
	HDMI 6
	HDMI 7
	HDMI 8
	DisplayPort

Display Device - Configure: The options in the Display Device - Configure menu allow you to change the picture orientation, perform lens adjustments or access other, display-device specific functions.

- **Installation – Orientation:** Select Installation from the Display Device - Configure menu, then select Orientation to change the picture orientation to suit the method of installation (Floor Front, Floor Rear, Ceiling Front or Ceiling Rear). Or, for front-projection installations, use the **Auto** setting to have the projector automatically determine the orientation (floor or ceiling) using an internal sensor.
- **Lens:** Select Lens from the Display Device - Configure menu to access the motorized lens controls. Refer to **Primary Lens Adjustments: Focus, Zoom and Position** on page 51.
- **Display Info.:** Select Display Info. from the Display Device - Configure menu to see the projector serial number and lamp usage information (number of hours in service).
- **Lamp Hours Reset:** When you replace a projector lamp (refer to **Lamp Replacement** on page 97), you should also reset its lamp hour counter to zero so that the lamp usage information in the Display Info. window is accurate. To do this, select Lamp Hours Reset from the Display Device - Configure menu. Then, select Lamp Hours Reset. A confirmation dialog box appears. Select “Yes” to continue with the reset or “No” to cancel the operation.
- **Diagnostics:** Select Diagnostics from the Display Device - Configure menu, then select Red, Green, Blue, Yellow, Cyan or Magenta to display only that color channel (simulating a filter of that color). This can be useful for calibration or measurement purposes.

To restore the normal picture (all colors), select White.

- **Altitude:** Select Altitude from the Display Device - Configure menu to control the operation of the projector’s cooling fan.

In most cases, the default setting (**Auto**) will maintain the correct operating temperature. If the lamp frequently turns off due to overheating, or in certain high-altitude operating environments, you may need to change this setting to **High**.

- **Display 3D Settings:** The Display 3D Settings menu is not applicable to the LS-12HBd.
- **Internal 3D Settings:** Select Internal 3D Settings from the Display Device - Configure menu to adjust the following timing settings for the Dimension Digital Controller's 3D Sync output (see Figure 2-6 and Figure 3-21), to optimize performance of the glasses, emitter and projector, for realistic simulation and 3D images.
 - **Sync Delay:** This control adjusts the output 3D emitter delay to match the active glasses to the left/right frames of the projector. Proper adjustment of this delay will eliminate crosstalk and odd colors caused by timing differences between the glasses and the projected image.
 - **Test Pattern Enable:** To display the 3D test pattern (refer to **Test Video** on page 81) while adjusting these settings, check the **Test Pattern Enable** box.
- **24Hz 3D Mode:** This control selects how 24Hz 3D content will be processed in an active 3D system. Lower frame rates can lead to excessive flickering, creating a need for frame rate conversion (FRC) to 60Hz in each eye (120Hz total). The FRC modes are as follows:
 - **120Hz 6:4 (default)** – Perform FRC using a 3:2 cadence for each eye (3 frames of A followed by 2 frames of B), resulting in 60Hz per eye, or 120Hz total.
 - **120Hz 5:5** – Perform FRC using a 3:2 cadence for the left eye (3 frames of A followed by 2 frames of B) and a 2:3 cadence for the right eye (2 frames of A followed by 3 frames of B), resulting in 60Hz per eye, or 120Hz total. This mode is intended to help reduce judder created in the FRC process.

Network: The options in the Network menu allow you to configure the network communication features.

- **IP Configuration:** Select IP Configuration from the Network menu to either set the IP address, subnet mask and default gateway of the Dimension Digital Controller manually or obtain these settings automatically, from a DHCP (Dynamic Host Configuration Protocol) server. (Most broadband routers and gateways support DHCP.) You can also test the network connection from this menu.
- **DHCP:** To enable the DHCP client in the Dimension Digital Controller, select DHCP from the IP Configuration menu and set it to **On**. With this setting, the Dimension Digital Controller's IP address, subnet mask and default gateway are assigned by the local DHCP server.

To manually configure these values, set DHCP to **Off**.



Note

The IP Address, Subnet Mask and Default Gateway items in the IP Configuration menu are disabled (grayed out) when DHCP is enabled.

- **IP Address:** Select IP Address from the IP Configuration menu to manually configure the IP Address of the Dimension Digital Controller, as follows:
 1. Press ▲ or ▼ to select the first, second, third or fourth byte of the address.
 2. Press ► or ◀ to set the value of that byte. The range is from 0 to 255 inclusive.
 3. Repeat Steps 1 and 2 for all four bytes of the address.
 4. Press **MENU** when you have finished setting the address.
- **Subnet Mask:** Select Subnet Mask from the IP Configuration menu to manually configure the IP subnet mask. The procedure is similar to that for setting the IP address.

-
- **Default Gateway:** Select Default Gateway from the IP Configuration menu to manually configure the default IP gateway. The procedure is similar to that for setting the IP address.
 - **Communication Test:** Select Communication Test from the IP Configuration menu to verify proper operation of the network communication link.

To start the test, select Start Test from the Communication Test menu. The Dimension Digital Controller displays the message “Performing Communication Test.” When the test completes, the Dimension Digital Controller displays either “Failed” (along with the error that occurred) or “Succeeded.”

- **Auto Firmware Upgrade:** Select Auto Firmware Upgrade from the Network menu to enable automatic detection of a newer version of the Dimension Digital Controller firmware. If one is found, you can configure the Dimension Digital Controller to install it automatically. These features make it easier to keep your Dimension Digital Controller firmware up-to-date.
- **Auto Check For New Firmware:** To have the Dimension Digital Controller automatically check for firmware updates at periodic intervals, select Auto Check for New Firmware from the Auto Firmware Upgrade menu and set it to **On**. If you prefer to do this manually, set it to **Off** and use the Check For New Firmware sub-menu (described below).
- **Auto Perform Upgrade:** If the “Auto Check For New Firmware” process determines that a newer firmware version than the one currently installed is available, you can have the Dimension Digital Controller automatically download and install it. To do this, select Auto Perform Upgrade from the Auto Firmware Upgrade menu and set it to **On**. The upgrade will occur the next time the Dimension Digital Controller is “power-cycled” (powered off, then on again). If you prefer to do this manually, set it to **Off**. The Dimension Digital Controller will ask if you want to perform the upgrade the next time it is power-cycled.
- **Check For New Firmware:** To have the Dimension Digital Controller check for new firmware on demand (and perform an upgrade if it finds a new version), select Check For New Firmware from the Auto Firmware Upgrade menu. If the Dimension Digital Controller finds a new firmware version, select **Yes** to perform the upgrade or **No** to return to the previous menu.

- **E-Mail Notification:** Select E-Mail Notification from the Network menu to specify when and to whom the Dimension Digital Controller sends error and service notification messages via e-mail.

The notification messages are in the following format:

To: [E-Mail Address; see below]
From: do-not-reply@runco.com
Subject: [Type of notification] from Runco DC-300
Body:

This is an automated message sent from the Runco DC-300:

Notification: [One of the following:
"DC-300 Error" / "Display Error"
"Periodic Service Notification"
"Lamp Life Notification" / "Calibration Data"]

Detailed Description: [**If a DC-300 Error**, one of the following:
"Fan Failure 1" / "Fan Failure 2"
"Overtemp 1" / "Overtemp 2"
"Initialization Failure"

If a Display Error, a device-specific error message such as "Lamp Door Open"

If a Periodic Service Notification, the elapsed time since the last notification

If a Lamp Life Notification, the number of hours the lamp has been in service

If a Calibration Data message,
"See Attached File"]

Serial Number: [Dimension Digital Controller serial number]
Customer Information: [From "Customer Information" sub-menu; see below]

Best Regards,

Runco International, LLC
1195 NW Compton Drive
Beaverton, OR 97006
1-800-237-8262

- **E-Mail Address:** To specify the destination e-mail address for error and service notifications, select E-Mail Address from the E-Mail Notification menu. The procedure is similar to that for setting the IP address (refer to **IP Configuration** on page 86). Enter up to 45 alphanumeric characters.
- **Error Notification:** To have the Dimension Digital Controller send a message to the destination e-mail address when a "DC-300 Error" or "Display Error" occurs, select Error Notification from the E-Mail Notification menu and set it to **On**.
- **Error Notification to Runco:** To have the Dimension Digital Controller send an e-mail message to Runco Customer Support when a "DC-300 Error" or "Display Error" occurs, select Error Notification to Runco from the E-Mail Notification menu and set it to **On**.

-
- **Periodic Service Notification:** You can have the Dimension Digital Controller send periodic reminders via e-mail to perform regular maintenance tasks. To do this:
 1. Select Periodic Service Notification from the E-Mail Notification menu.
 2. Highlight **Enable** and press **ENTER**.
 3. Highlight **On** and press **ENTER**.
 4. Press **MENU**.
 5. Highlight **Timer** and press **ENTER**.
 6. Press **▶** or **◀** to set the notification interval in months. The range is from 1 to 255 inclusive; the default is 12 months.
 7. Press **MENU**.
 - **Lamp Life Notification:** To have the Dimension Digital Controller send a message to the destination e-mail address when the lamp hour counter reaches a certain threshold, select Lamp Life Notification from the E-Mail Notification menu. Then:
 1. Highlight **Enable** and press **ENTER**.
 2. Highlight **On** and press **ENTER**.
 3. Press **MENU**.
 4. Highlight **Lamp Hours** and press **ENTER**.
 5. Press **▶** or **◀** to set the notification threshold in hours. The range is from 100 to 10,000 hours; the default is 1,000 hours.
 6. Press **MENU**.
 - **Customer Information:** Select Customer Information from the E-Mail Notification menu to supply this information to the Dimension Digital Controller, which includes it in all e-mail notification messages. Six lines (up to 30 characters per line) of text are provided; use them however you wish.
 1. Press **▲** or **▼** repeatedly to select a line of text to edit.
 2. Press **ENTER**.
 3. Press **▲** or **▼** repeatedly to set the highlighted character.
 4. Press **▶** (or **◀**) to select the next (or previous) character. Use the **▲** and **▼** buttons to change it.
 5. Press **ENTER** when you have finished editing that line of text.
 6. Repeat Steps 1 through 5 for each line of text you want to edit.
 7. Press **MENU** when you have finished entering customer information.
 - **E-Mail Calibration Data:** To have the Dimension Digital Controller collect all calibration data, attach it to a message and send it to the destination e-mail address, select E-Mail Calibration Data from the E-Mail Notification menu. To confirm this action, select **Yes** and press **ENTER**.
- To cancel and return to the previous menu, select **No**.

- **Remote Network Control:** Select Remote Network Control from the Network menu to enable or disable control of the Dimension Digital Controller via an IP connection (typically using a web browser). Set it to **On** to allow all incoming remote network connectivity. Set it to **Off** to disable any incoming network communication that was not initiated by the Dimension Digital Controller.

**Note**

This setting has no effect on the E-Mail Notification or Auto Firmware Upgrade functions.

Color Space: Select Color Space from the Service menu to choose the color space of the source signal for HDMI, RGB, and component connections.

- The default setting, **Auto**, functions as follows:
 - **HDMI:** If the Auxiliary Video Information (AVI) infoframe contains color space and/or range data, the Dimension Digital Controller uses that information. Otherwise, for RGB sources, the Dimension Digital Controller uses the **RGB-Video** color space. For component SDTV and EDTV resolutions, **REC601** is used. For other component video resolutions, **REC709** is used.
 - **RGB:** If Hsync or Vsync signals are present, the Dimension Digital Controller uses the **RGB-PC** color space. Otherwise, **REC601** is used for SDTV and EDTV sources, and **REC709** for all other sources.
 - **Component:** For SDTV and EDTV resolutions, the Dimension Digital Controller uses the **REC601** color space. For all other resolutions, REC709 is used.

In most cases, the **Auto** setting determines the correct color space to use. If it does not, you can force the Dimension Digital Controller to use a specific color space. Choose one of the following:

- **REC709** sets the color space matrix to that defined in ITU-R BT.709.
- **REC601** sets the color space matrix to that defined in ITU-R BT.601.
- **RGB-PC** uses RGB color space and sets black at 0,0,0 RGB and white at 255,255,255 RGB, assuming an 8-bit image.
- **RGB-Video** uses RGB color space and sets black at 16,16,16 RGB and white at 235,235,235, assuming an 8-bit image, to correspond to the luminance values defined in digital component standards.

Triggers: Select Triggers from the Service menu to configure the 12-volt trigger outputs. You can assign one or more trigger outputs to each aspect ratio. Those triggers are then activated by selecting that aspect ratio.

Miscellaneous: Select Miscellaneous from the Service menu to set the following options:

- **Language:** Select Language from the Miscellaneous menu and press the up- or down-arrows to select the OSD Language (English, Français, Deutsch, Italiano, Español, Svenska, 简体中文 (Simplified Chinese), 繁體中文 (Traditional Chinese), Português, Русский (Russian), 日本語 (Japanese) or 한국어 (Korean)).
- **OSD Timer:** Select OSD Timer from the Miscellaneous menu to set the OSD Timer, which controls how long the menus remain on-screen after selecting them. Select from 5 to 60 seconds, in one-second increments. Or, set the timer to 0 (disabled) if you want the menus to remain on-screen indefinitely.
- **OSD Messages:** When you select a new aspect ratio, input source or memory preset, the Dimension Digital Controller briefly displays an on-screen message confirming your new selection. To prevent the display of these messages, select OSD Messages from the Miscellaneous menu to and set it to **Off**.
- **Blank Screen Color:** Select Blank Screen Color from the Miscellaneous menu to select the color that appears when no incoming signal is present. The range is from 0 to 255 inclusive for each color component (red, green and blue).
- **Sidebar Color:** Select Sidebar Color from the Miscellaneous menu to change the color of the inactive image area. The range is from 0 to 255 inclusive for each color component (red, green and blue). The inactive image area is on either side of the active image area when using the 4:3 aspect ratio.
- **Film Mode:** Use Film Mode to smooth out moving images from interlaced, standard-definition (SD) sources. In most cases, the Dimension Digital Controller detects the proper “pull-down” rate and vertical frequency. However, if your source is jittery and/or tearing you may want to enable Film Mode to ensure stable processing for that source.
- **CUE (Chroma Upsampling Error) Correction:** Some DVD players use MPEG decoders that do not correctly “upsample” the 4:2:0 format chroma information on the DVD to the 4:2:2 or 4:4:4 format required by the video encoder of the display device.

This so-called “chroma bug” sometimes causes streaky or spiky horizontal lines running through the chroma channel. It is most noticeable in static, interlaced scenes and on diagonal edges (especially red ones). Set CUE to **On** to correct this issue.

- **Sync Threshold:** Select Sync Threshold to adjust the threshold at which negative pulses on the component video green/luma channel are interpreted to be sync pulses.

Sync Threshold adjustment is occasionally necessary when a DVD player or HDTV source signal drops “below black” (for example, during scenes with explosions or when subtitles are present) and causes the projector to temporarily lose sync. If the sync level from the source is persistently too low, the display device won’t sync with the source at all.

The range is from 0 (approximately 60 millivolts (mV)) to 15 (approximately 300 mV).

HDMI: Select HDMI from the Service menu to set the following options affecting communication between HDMI sources, the Dimension Digital Controller and the LS-12HBd.

- **HDMI EDID Extension:** Extended display identification data (EDID) is a data structure provided by a display device to describe its capabilities to a graphics card. It is what enables a modern personal computer to know what kind of monitor is connected.

Some modern display devices provide more information via EDID than others, in the form of “extensions.” Some computer graphics cards do not recognize or properly interpret this extended EDID information.

Select HDMI EDID Extension from the HDMI menu to specify whether or not the EDID extensions from the display device are passed through to the sources connected to the HDMI and/or DisplayPort inputs. By default, the extensions are on. Change these settings only if HDMI EDID incompatibility issues arise.

- **Audio Format:** Select Audio Format from the HDMI menu to choose an option for routing the audio signal from an HDMI source. With the LS-12HBd, the recommended setting is **HDMI Out (Audio Only)**. (This is also the default setting.)
- **CEC:** This control chooses whether or not the Dimension Digital Controller responds to HDMI CEC control messages from a disc player, set-top box or other HDMI source.

The default setting is **On**. For more information about CEC, refer to **Using HDMI CEC Messages** on page 122.



Note

The Dimension Digital Controller does not transmit HDMI CEC control messages from the “HDMI Audio Out” connector, regardless of the CEC setting.

- **HPD Toggle Rejection:** Select HPD Toggle Rejection from the HDMI menu to specify whether or not the Dimension Digital Controller ignores extraneous Hot Plug Detect (HPD) signal state changes from a downstream HDMI device (third-party display or audio/video receiver).

The default setting, **Auto**, disables HPD toggle rejection on the LS-12HBd. Use the other settings to troubleshoot compatibility issues or reduce the amount of time needed to lock to an incoming signal.

Front Panel Brightness: Select Front Panel Brightness from the Service menu to adjust the brightness of the front-panel LED and LCD status indicators.

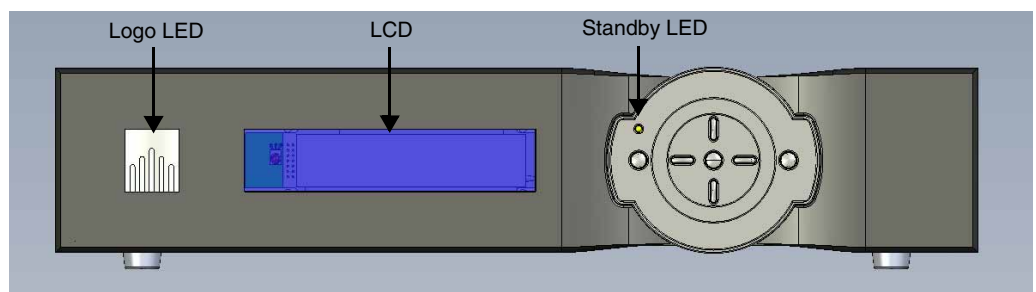

- **Logo LED:** Select Logo LED from the Front Panel Brightness menu to adjust the brightness of the large, illuminated logo on the left side of the display. The range is from 0 (off) to 31.

**Note**

During a firmware upgrade, this LED lights at full brightness regardless of the Logo LED setting.

- **Standby LED:** Select Standby LED from the Front Panel Brightness menu to change the behavior of the front-panel STANDBY indicator LED. When set to ON, the LED lights amber when the system is in standby mode; otherwise, it is off. When set to OFF, the LED is always off.

**Note**

During a firmware upgrade, this LED lights at full brightness regardless of the Standby LED setting.

- **LCD:** Select LCD from the Front Panel Brightness menu to adjust the brightness of the front-panel LCD. The range is from 0 (off) to 4.

Auto Power Off: Select Auto Power Off from the Service menu to have the LS-12HBd turn itself off after a specified period of time.

- **Enable:** By default, Auto Power Off is set to **No Signal**. With this setting, the LS-12HBd powers off after a specified period of inactivity (no source signal present). To change this behavior, select Enable from the Auto Power Off sub-menu. Then, set it to **On** to have the LS-12HBd power off after the specified time period whether a source signal is present or not. Or, set it to **Off** to disable this feature altogether.
- **Hours:** Select Hours from the Auto Power Off sub-menu to specify the number of hours after which the LS-12HBd should power off. The default time-out period is one hour; the range is from 1 to 24 hours.

Standby Mode: Select Standby Mode from the Service menu to control the Dimension Digital Controller's power management feature.

- Choose **Low Power** (the default setting) to have the Dimension Digital Controller shut down completely when it is turned off. This conserves power but increases the amount of time required by the Dimension Digital Controller to start up when it is turned on.
- **Fast Startup** is a "quick-start" mode that keeps the Dimension Digital Controller running when it is turned off, even though it appears to be in standby mode. This results in much quicker startup times but consumes more power.

System Reset: To reset ALL controller settings (including image settings) back to their factory defaults, choose System Reset from the Service menu.

A confirmation message appears. Select Yes to continue with the reset or select No to cancel.

**Caution**

This action is not undoable. Proceed with caution! Before you perform a System Reset, save your "Custom" Memory Presets (page 70) and ISF Day/Night Memory Presets (page 78).

4.2 Using the 3D Glasses

The 3D LCD Shutter Glasses function with the Runco Active 3D Emitter and the projector to provide unsurpassed 3D stereoscopic viewing. This section describes the features, connection, setup and operation of the 3D LCD Shutter Glasses.

Key Features ➤

- RF synchronization for uninterrupted 3D performance
- Supports refresh rates from 50 to 240 Hz for compatibility with both current and future 3D technology
- High contrast ratio, high uniformity and fast response time for an excellent 3D experience
- Rechargeable battery provides up to 15 hours of 3D viewing per charge
- Battery charge indicator lets you know remaining operating time

Functional Overview ➤

The 3D LCD Shutter Glasses have the following key functional components:

- **Battery Status LED**
Indicates battery charge state as described in the following sections, **Charging the Battery** and **Turning On the Glasses**.
- **Power Button**
Press to turn the glasses on or off.
- **Power Input**
To charge the glasses, connect this input to your PC or other USB power source, using the included charging cable.

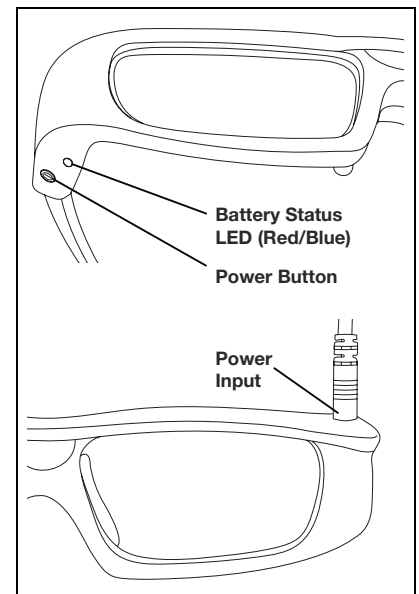

The glasses must be fully charged before first use and whenever the Battery Status LED flashes red once every couple of seconds. The glasses will charge a completely dead battery in approximately five hours. You may use the glasses while the battery is being charged.

◀ **Charging the Battery**

To charge the 3D Glasses:

1. Attach one end of the supplied charging cable to the Power Input above the left lens on the glasses.
2. Attach the other end of the cable to any USB "A" port on a USB hub, personal computer or display device. The Battery Status LED lights solid red while the battery is charging.

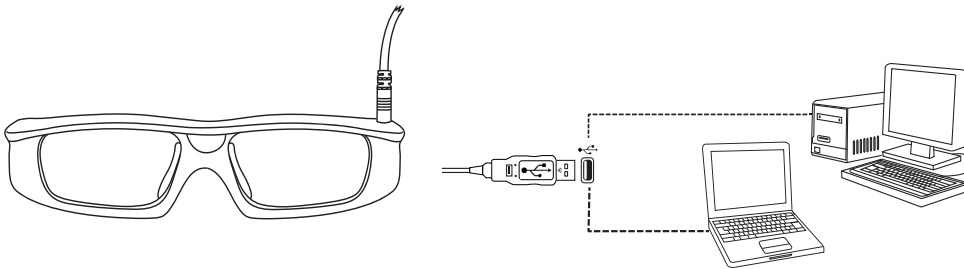

Note

When attached to a computer, the Runco Active 3D Glasses use the computer only to receive power; the glasses do not appear as a device visible to Windows or any other operating system.

3. When the Battery Status LED lights solid blue, the battery is fully charged. You can disconnect the glasses from the power source.

The battery in the 3D glasses is designed to operate approximately 15 hours on a full charge. The glasses consume more power as needed to maximize reliability. As a result, battery life is a function of many factors, including how much interference from 2.4-GHz devices like wireless routers must be compensated. Under worst-case conditions, fully-charged glasses should operate flawlessly for a minimum of about 12 hours.

- Turning On the Glasses** ➤
1. Ensure that the projector is powered on and displaying 3D content.
 2. Press and hold the Power Button for about two seconds, then release the button. The LED will then blink in a pattern that indicates the battery charge state. In general, the more slowly and less frequently the LED blinks, the more charged (and less in need of charge) the glasses are. Refer to Table 4-5.

Table 4-5. Battery Charge State Indications

Blink Activity After Power-on	Battery Charge State
Three (3) blue blinks (one second on, one second off)	Battery is fully charged; 12 to 15 hours remaining.
Six (6) blue blinks	Battery is 50% charged; approximately 4 hours remaining.
Nine (9) blue blinks	Battery is 30% or more charged; approximately 2 hours remaining.
Red blink	Battery charge is 10% or less; glasses must be charged before further use.

3. The glasses will sync with the emitter and the 3D content will be visible through the glasses.
4. Repeat Step 2 for each pair of glasses you wish to sync to the emitter.

- Auto Power-Off** ➤
- If the glasses do not detect an emitter, the LED blinks on and off once per second for five minute. Then, to preserve battery life, the glasses automatically turn off. If the emitter is activated (the emitter is only active when the projector is in 3D mode) before the five-minute period ends, the glasses stop blinking and remain on.

If the glasses automatically turn off, press the Power button to turn them back on.

5. Maintenance and Troubleshooting

The lamp should be replaced when it reaches the end of its life (typically 2,000 hours), or sooner if a noticeable degradation in brightness occurs.

Keep track of the number of hours the lamp has been in use and be aware of any changes to brightness. These indicators will help you effectively maintain operation of the projector. To find out how long the currently-installed lamp has been in service, select Display Info. from the Display Device - Configure menu (available by selecting **Service -> Display Device -> Configure -> Display Info.**, in sequence).

For lamp or filter replacement, please contact your nearest Runco authorized service center or Runco dealer. Do not attempt to replace the lamp yourself!

1. Turn off the projector and unplug the power cord. **Allow the projector to cool down for approximately 60 minutes prior to removing the lamp assembly for replacement.**
2. Using a flat-blade screwdriver, loosen the two screws holding the rear compartment cover in place.
3. Remove the rear compartment cover by tilting it upward.
4. Loosen the screw on the lamp cover and pull the lamp cover out.

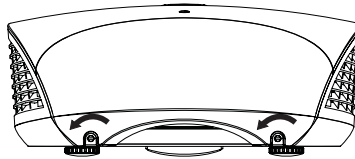

5. Loosen the two screws on the lamp module.
6. Pull the lamp module handle firmly to remove the lamp module.

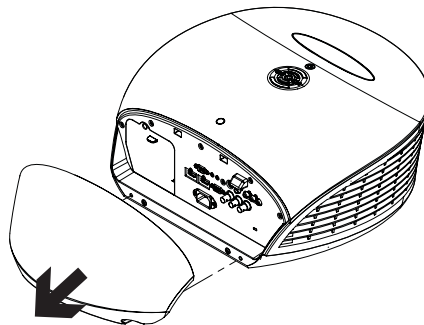

7. Perform Steps 6 through 2 (in reverse order) to install the new lamp module.
8. Turn on the Dimension Digital Controller and projector.
9. Reset the Lamp Hour counter. To do this, select Lamp Hours Reset from the Display Device - Configure menu. A confirmation dialog box appears. Select "Yes," then press **ENTER** to continue with the reset or "No" to cancel the operation.

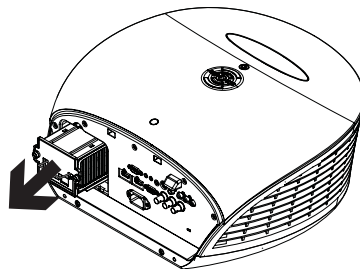
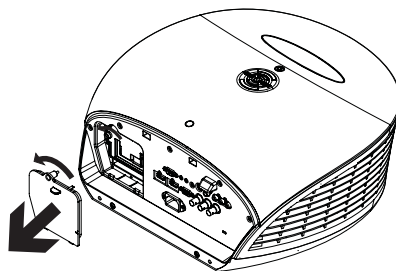

5.1 Lamp Replacement

5.2 Troubleshooting Tips

Table 5-1 provides some general guidelines for troubleshooting problems you may encounter with the LS-12HBd. If the suggested solutions fail to resolve the problem or if you encounter an issue not described here, please contact Runco Technical Support.

Table 5-1. Troubleshooting Chart

Symptom	Possible Cause(s)	Solution
The projector does not turn on.	<ul style="list-style-type: none"> The LS-12HBd is not plugged in and switched on, or the AC outlet is not active. The Dimension Digital Controller is not plugged in and switched on, or the AC outlet is not active. The remote control batteries have run out. The serial connection from the Dimension Digital Controller to the LS-12HBd is incorrect. 	<ul style="list-style-type: none"> Ensure that the LS-12HBd is plugged in and switched on, and that the AC outlet is active. Ensure that the Dimension Digital Controller is plugged in and switched on, and that the AC outlet is active. Replace the batteries. Ensure that the Pri. Display Control output from the Dimension Digital Controller is properly connected to the RS-232C input on the LS-12HBd (see Figure 3-9).
The projector and Dimension Digital Controller are both on, but there is no picture and on-screen menus do not appear.	<ul style="list-style-type: none"> Lens cover is on. Lamp failed to ignite. Faulty or incorrect video connection between the Dimension Digital Controller and the LS-12HBd. 	<ul style="list-style-type: none"> Ensure that the lens cover is off. Ensure that the lamp door is closed. If it is and the problem persists, replace the lamp. Ensure that the HDMI output from the Dimension Digital Controller is properly connected to the PRIMARY input on the LS-12HBd (see Figure 3-9).
The display is on and menus appear, but there is no picture.	<ul style="list-style-type: none"> Incorrect source selection. Source component is not turned on. Source component is connected incorrectly or not at all. 	<ul style="list-style-type: none"> Select the correct source. Turn on the source component. Check connections from source component to Dimension Digital Controller.
A projected image from a DVD is split or otherwise scrambled.	<ul style="list-style-type: none"> DVD player is connected to the Component input and set to progressive scan mode. 	<ul style="list-style-type: none"> Turn off progressive scan on the DVD player. Or, connect the DVD player to the HD1 or HD2 input.
Image geometry is incorrect.	<ul style="list-style-type: none"> Incorrect aspect ratio selection. 	<ul style="list-style-type: none"> Select a different aspect ratio.

Table 5-1. Troubleshooting Chart (continued)

Symptom	Possible Cause(s)	Solution
The display is jittery or unstable.	<ul style="list-style-type: none"> Poor-quality or improperly connected source. The horizontal or vertical scan frequency of the input signal may be out of range for the projector. 	<ul style="list-style-type: none"> Ensure that the source is properly connected and of adequate quality for detection. Correct at the source.
Image is too bright and/or lacks definition in the bright areas of the image.	<ul style="list-style-type: none"> Contrast is set too high. 	<ul style="list-style-type: none"> Lower the contrast setting.
Image appears “washed out” and/or dark areas appear too bright.	<ul style="list-style-type: none"> Brightness is set too high. 	<ul style="list-style-type: none"> Lower the brightness setting.
Colors in the image from a Component video source are swapped; for example, reds appear blue or vice versa.	<ul style="list-style-type: none"> The Red/Pr, Green/Y or Blue/Pb outputs from the source are connected to the wrong inputs on the Dimension Digital Controller. 	<ul style="list-style-type: none"> Ensure that the source outputs are connected to the correct Dimension Digital Controller Component input connector (see Figure 3-17).
The display freezes suddenly.	<ul style="list-style-type: none"> Excessive voltage noise on the AC or ground input has interrupted the projector’s ability to lock on to a signal. 	<ul style="list-style-type: none"> Power down the projector and disconnect from AC. Then, plug in again and power up as usual.
The projector will not turn back on after it was powered down, or the image disappears during operation.	<ul style="list-style-type: none"> The projector will not turn on for two minutes after power-down, to protect the lamp. The lamp has failed. 	<ul style="list-style-type: none"> Wait until the STANDBY LED at the front of the Dimension Digital Controller turns on (see Figure 2-5). Replace the lamp.
Anamorphic lens transport does not work.	<ul style="list-style-type: none"> The motor is not plugged in or the AC outlet is not active. The motor is not connected to a trigger output on the Dimension Digital Controller. Incorrect trigger assignment. 	<ul style="list-style-type: none"> Ensure that the motor is plugged in and that the AC outlet is active. Check the trigger connection between the lens motor and Dimension Digital Controller (see Figure 3-11). Correct the trigger assignment (refer to Installing and Adjusting the Anamorphic Lens on page 54).

Table 5-1. Troubleshooting Chart (continued)

Symptom	Possible Cause(s)	Solution
<p>The projector does not turn on or respond to user commands. The vacuum fluorescent display on the Dimension Digital Controller front panel displays the following message:</p> <p>Primary Display Error Communication Failure</p>	<ul style="list-style-type: none"> The serial connection from the Dimension Digital Controller to the display is incorrect or the cable is faulty. 	<ul style="list-style-type: none"> Ensure that the Pri. Display Control (RS-232) output from the Dimension Digital Controller is properly connected to the display (see Figure 3-9).
<p>When displaying 3D content, crosstalk or “ghosting” can be seen — that is, the left eye is perceiving some of what the right eye should be seeing or vice versa.</p>	<ul style="list-style-type: none"> Primary and Secondary images are not properly aligned. Rear-projection installation uses second-surface mirrors that are producing faint, secondary reflections. 	<ul style="list-style-type: none"> Refer to Adjusting the Image Geometry on page 52. Always use first-surface mirrors in your rear-projection installation.
<p>With 3D glasses, image perspective is reversed — that is, “left-eye” frames appear in the right lens and vice versa.</p>	<ul style="list-style-type: none"> Incorrect Reverse Eyes setting. 	<ul style="list-style-type: none"> Change the Reverse Eyes setting (refer to Reverse Eyes on page 71).

6. External Control

In addition to using the Dimension Digital Controller front-panel keypad or remote control unit, there are three methods of controlling the LS-12HBd and Dimension Digital Controller externally:

- Using a serial (RS-232) link to send ASCII commands and receive responses to those commands.
- Using discrete infrared (IR) codes to program a third-party remote control unit.
- Using an HDMI connection to send Consumer Electronics Control (CEC) commands from a BD player or other source component that supports CEC.

The following sections describe these methods.

The Dimension Digital Controller uses a simple text-based control protocol to take requests from control devices and to provide responses to such devices. This section describes how to send control messages over a serial link between the Dimension Digital Controller and an automation/control system or a PC running terminal emulation software.



Note

The serial communication protocol described here replaces the serial protocol used by legacy Runco products (manufactured prior to September 2011) that include the DHD Controller.

Runco recommends using this new protocol, as it is more concise and provides greater control than the old one. However, to maintain backward compatibility with existing automation/control system modules, the legacy Runco serial protocol is also supported.

To interface the LS-12HBd with an automation/control system or a PC running terminal emulation software, connect it to the Dimension Digital Controller as shown in Figure 3-9. Connect your control system or PC to the RS-232 input of the Dimension Digital Controller; see Figure 3-11.

Configure the RS-232 controller or PC serial port as follows: no parity, 8 data bits, 1 stop bit and no flow control. Set the baud rate to 19200, to match that of the Dimension Digital Controller RS-232 port.

Commands sent from an automation/control system or PC to the Dimension Digital Controller must have the following format:

`(www:xyz) [CR]`

Where:

- (and) indicate the start and end of the command data. If these characters are present, the Dimension Digital Controller assumes that valid command data is present in the command string. Otherwise, the Dimension Digital Controller ignores the command.
- `www` indicates the command code. This field is case insensitive; for example, `PWR`, `pwr` and `PwR` are all equivalent.
- `:x` is the destination parameter. This is an optional parameter that indicates which memory the command is referencing. This parameter is reserved for future use.

6.1 Serial Communications

◀ RS-232 Connection and Port Configuration

◀ Command Format

- y is the operand, which can have one of the following values:

? = "Get" operand	+ = "Increment" operand
= = "Set" operand	- = "Decrement" operand
- z is the value to set for this parameter. It can have one of two formats:
 - **Integer value:** Any positive or negative number; for example, 100.
 - **String value:** Any string surrounded by double quotes; for example, "This is a string."
- [CR] is the ASCII carriage return key (0x0D).

Response Format ➤ Responses sent from the follower to the initiator shall have the following format:

`(u;www:x=z) [CR]`

Where:

- (and) indicate the start and end of the command data. If these characters are present, the Dimension Digital Controller assumes that valid command data is present in the command string. Otherwise, the Dimension Digital Controller ignores the command.
- "u;" indicates the response code. This is only used by followers responding to a valid CLI command received. For any response code other than 0, the follower echoes back the command received rather than filling in the fields listed below.

The response code can be one of the following:

- 0 = Command successfully processed
- 1 = Unknown command code
- 2 = Invalid operator
- 3 = Destination parameter not supported
- 4 = Setting not available
- 5 = Setting value not available
- 6 = Setting value not supported
- 7 = String too long
- 8 = Command not supported in standby mode
- 9 = Invalid parameter
- 10 = Error processing command
- 11 = Password not entered
- `www` indicates the command code. This field is case insensitive; for example, PWR, `pwr` and `PwR` are all equivalent.
- `:x` is the destination parameter. This is an optional parameter that indicates which memory the command is referencing. This parameter is reserved for future use.
- z is the new value (for Set, Increment or Decrement commands) or the current value (for Get commands) for this parameter. It can have one of two formats:
 - **Integer value:** Any positive or negative number; for example, 100.
 - **String value:** Any string surrounded by double quotes; for example, "This is a string."
- [CR] is the ASCII carriage return key (0x0D).

Here are some examples of serial commands and their responses:

◀ **Command and Response Examples**

Command	Command Data	Response
Power query when unit is powered on	(PWR?) [CR]	(0;PWR=1) [CR]
Set power to 0 (off)	(PWR=0) [CR]	(0;PWR=0) [CR]
Increment brightness from 24 to 25	(BRT+) [CR]	(0;BRT=25) [CR]
Invalid command	(ZZZ=0) [CR]	(1;ZZZ=0) [CR]
Invalid parameter (received string, expected integer)	(CON="Some string") [CR]	(9;CON="Some string") [CR]

Table 6-1 lists all supported commands.

◀ **Serial Command List**

Table 6-1. Serial Commands

Setting	Command Code	Read/Write	Inc/Dec	Min Value	Max Value	String?	Notes
PCE Auto Color Enable	AAC	R/W	No	0	1	No	0 = Off; 1 = On
PCE Diagnostic Color	AAD	R/W	No	0	6	No	0 = White 1 = Red 2 = Green 3 = Blue 4 = Yellow 5 = Cyan 6 = Magenta
PCE Blue x	ABX	R/W	Yes	-100	100	No	
PCE Blue y	ABY	R/W	Yes	-100	100	No	
Adjustment Mode	ADJ	R/W	No	0	2	No	0 = Both 1 = Left 2 = Right
PCE Green x	AGX	R/W	Yes	-100	100	No	
PCE Green y	AGY	R/W	Yes	-100	100	No	
Apply Image Alignment Values	AIA	R/W	No	0	1	No	0 = Off; 1 = On
Altitude	ALT	R/W	No	0	1	No	0 = Auto 1 = High
Advanced Color Temp Mode Enable	AME	R/W	No	0	1	No	0 = Off; 1 = On
Auto New Firmware Check	ANF	R/W	No	0	1	No	0 = Off; 1 = On
Auto Power Off Enable	APE	R/W	No	0	2	No	0 = Off; 1 = On; 2 = No Signal
Auto Power Off Timer	APT	R/W	Yes	1	24	No	
Auto Perform Upgrade	APU	R/W	No	0	1	No	0 = Off; 1 = On

Table 6-1. Serial Commands (continued)

Setting	Command Code	Read/Write	Inc/Dec	Min Value	Max Value	String?	Notes
Aspect Ratio Copy	ARC	W	No	N/A	N/A	No	Action will be performed on any setting value
Aspect Ratio Paste	ARP	W	No	N/A	N/A	No	
PCE Red x	ARX	R/W	Yes	-100	100	No	
PCE Red y	ARY	R/W	Yes	-100	100	No	
Aspect Ratio	ASP	R/W	No	0	6	No	0 = 4:3 1 = 16:9 2 = Letterbox 3 = VirtualWide 4 = Cinema 5 = Virtual Cinema 6 = Native 7 = Auto Cinema
PCE Test Pattern Enable	ATP	R/W	No	0	1	No	0 = Off; 1 = On
PCE White x	AWX	R/W	Yes	-100	100	No	
PCE White y	AWY	R/W	Yes	-100	100	No	
Image Alignment Bottom Left x	BLX	R/W	Yes	-100	100	No	
Image Alignment Bottom Left y	BLY	R/W	Yes	-100	100	No	
Image Alignment Bottom Middle y	BMY	R/W	Yes	-100	100	No	
Brightness Offset	BRO	R/W	Yes	-50	50	No	Picture menu
Brightness	BRT	R/W	Yes	-50	50	No	Calibration -> Input Image menu
Image Alignment Bottom Right x	BRX	R/W	Yes	-100	100	No	
Image Alignment Bottom Right y	BRY	R/W	Yes	-100	100	No	
Blank Screen Blue	BSB	R/W	Yes	0	255	No	
Blank Screen Green	BSG	R/W	Yes	0	255	No	
Blank Screen Red	BSR	R/W	Yes	0	255	No	
CEC Enable	CEC	R/W	No	0	1	No	0 = Off; 1 = On
Chroma Delay	CHR	R/W	Yes	0	7	No	
Color Gamut	CLG	R/W	Yes	0	6	No	0 = Auto 1 = REC709 2 = SMPTE C 3 = EBU 4 = Native 6 = PCE
Color Offset	CLO	R/W	Yes	-50	50	No	Picture menu
Color	CLR	R/W	Yes	-50	50	No	Calibration -> Input Image menu
Color Space	CLS	R/W	No	0	4	No	0 = REC601 1 = REC709 2 = RGB 3 = RGB Video 4 = Auto

Table 6-1. Serial Commands (continued)

Setting	Command Code	Read/Write	Inc/Dec	Min Value	Max Value	String?	Notes
Image Alignment Center x	CNX	R/W	Yes	-100	100	No	
Image Alignment Center y	CNY	R/W	Yes	-100	100	No	
Contrast	CON	R/W	Yes	-50	50	No	Calibration -> Input Image menu
Contrast Offset	COO	R/W	Yes	-50	50	No	Picture menu
Color Temp Simple	CTS	R/W	No	0	4	No	1 = 5500K 2 = 6500K 3 = 7500K 4 = 9300K
CUE	CUE	R/W	No	0	1	No	0 = Off; 1 = On
Display Blue Gain	DBG	R/W	Yes	-100	100	No	
Display Blue Offset	DBO	R/W	Yes	-100	100	No	
Default Gateway Byte 1	DE1	R/W	Yes	0	255	No	
Default Gateway Byte 2	DE2	R/W	Yes	0	255	No	
Default Gateway Byte 3	DE3	R/W	Yes	0	255	No	
Default Gateway Byte 4	DE4	R/W	Yes	0	255	No	
DisplayPort EDID Extension	DEE	R/W	No	0	1	No	0 = Off; 1 = On
Diagnostic Color	DGC	R/W	No	0	6	No	0 = White 1 = Red 2 = Green 3 = Blue 4 = Yellow 5 = Cyan 6 = Magenta
Display Green Gain	DGG	R/W	Yes	-100	100	No	
Display Green Offset	DGO	R/W	Yes	-100	100	No	
DHCP	DHC	R/W	No	0	1	No	0 = Off; 1 = On
Display Red Gain	DRG	R/W	Yes	-100	100	No	
Display Dark Interval	DRK	R/W	Yes	Var.	Var.	No	
Display Red Offset	DRO	R/W	Yes	-100	100	No	
Error Notification	ERN	R/W	No	0	1	No	0 = Off; 1 = On

Table 6-1. Serial Commands (continued)

Setting	Command Code	Read/Write	Inc/Dec	Min Value	Max Value	String?	Notes
Error Code	ERR	R	No	0		No	0 = None 1 = Display Lamp Overtemp 2 = Display Ballast Overtemp 3 = Display Fan Init Failure 4 = Display Fan 1 Failure 5 = Display Fan 2 Failure 6 = Display Fan 3 Failure 7 = Display Fan 4 Failure 8 = Display Fan 5 Failure 9 = Display Fan 6 Failure 10 = Display Fan 7 Failure 11 = Display Fan 8 Failure 12 = Display DMD Failure 13 = Display Lamp Strike Failure 14 = Display Lamp Went Out 15 = Display Ballast UART Failure 16 = Display GPIO Failure 17 = Display Lamp Door Open 18 = Display Processor Failure 19 = Display Hardware I2C Failure 20 = Display Software I2C Failure 21 = Display Lamp Error 22 = Display Communication Error 25 = DC-300 Fan 1 Failure 26 = DC-300 Fan 2 Failure 27 = DC-300 Overtemp 1 28 = DC-300 Overtemp 2 56 = DC-300 Fan 3 Failure 58 = DC-300 Overtemp 3 60 = DC-300 Input FPGA Failure 61 = DC-300 Output FPGA Failure
Focus	FCS	W	Yes	0	0	No	Send (FCS+) or (FCS-) to adjust incrementally
Film Mode	FLM	R/W	No	0	1	No	0 = Off; 1 = On
24Hz 3D Mode	FRC	R/W	No	1	2	No	1 = 120Hz 6:4 2 = 120Hz 5:5
Firmware Upgrade	FWU	W	No	N/A	N/A	No	Action will be performed on any setting value
Gamma Advanced	GMA	R/W	Yes	0	20	No	
Gamma Mode	GMM	R/W	No	0	1	No	0 = Simple 1 = Advanced
Gamma Simple	GMS	R/W	No	0	4	No	0 = 2.0 1 = 1.8 2 = 2.2 3 = 2.35 4 = 2.5

Table 6-1. Serial Commands (continued)

Setting	Command Code	Read/Write	Inc/Dec	Min Value	Max Value	String?	Notes
HDMI Audio Format	HAF	R/W	No	0	3	No	0 = Combined 1 = HDMI Out (Pri. Display) 2 = HDMI Out (Sec. Display) 3 = HDMI Out (Audio Only)
HDMI EDID Extension 1 HDMI EDID Extension 2 HDMI EDID Extension 3 HDMI EDID Extension 4 HDMI EDID Extension 5 HDMI EDID Extension 6 HDMI EDID Extension 7 HDMI EDID Extension 8	HE1 HE2 HE3 HE4 HE5 HE6 HE7 HE8	R/W	No	0	1	No	0 = Off; 1 = On
HPD Toggle Rejection	HPD	R/W	No	0	1	No	0 = Off; 1 = On
Horizontal Shift	HSH	W	Yes	0	0	No	Send (HSH+) or (HSH-) to adjust incrementally
Input Name 1 Input Name 2 Input Name 3 Input Name 4 Input Name 5 Input Name 6 Input Name 7 Input Name 8 Input Name 9 Input Name 10 Input Name 11 Input Name 12 Input Name 13 Input Name 14 Input Name 15 Input Name 16	I01 I02 I03 I04 I05 I06 I07 I08 I09 I10 I11 I12 I13 I14 I15 I16	R/W	No	N/A	N/A	Yes	12 characters maximum
Input Blue Gain	IBG	R/W	Yes	-32	32	No	
Input Blue Offset	IBO	R/W	Yes	-32	32	No	
Information Boot Version	IBV	R	No	N/A	N/A	Yes	
Information Copied Aspect Ratio	ICA	R	No	N/A	N/A	Yes	
Information Current Color Space	ICC	R	No	0	3	Yes	0 = REC601 1 = REC709 2 = RGB 3 = RGB Video
Information Copied Input Source	ICI	R	No	N/A	N/A	Yes	
Information Copied Memory Pre-set	ICM	R	No	N/A	N/A	Yes	
Information Copied Screen	ICR	R	No	N/A	N/A	Yes	
Information Copied Signal Format	ICS	R	No	N/A	N/A	Yes	
Information Display Name	IDN	R	No	N/A	N/A	Yes	

Table 6-1. Serial Commands (continued)

Setting	Command Code	Read/Write	Inc/Dec	Min Value	Max Value	String?	Notes
Information Firmware Version	IFV	R	No	N/A	N/A	Yes	
Input Green Gain	IGG	R/W	Yes	-32	32	No	
Input Green Offset	IGO	R/W	Yes	-32	32	No	
Information Horizontal Frequency	IHF	R	No	N/A	N/A	Yes	
Information Input Resolution	IIR	R	No	N/A	N/A	Yes	
Information Input FPGA Version	IIV	R	No	N/A	N/A	Yes	
information Micro Version	IMV	R	No	N/A	N/A	Yes	
Input Source	INS	R/W	No	0	15	No	0 = Composite 1 1 = Composite 2 2 = Composite 3 3 = Component 4 = HD 1 5 = HD 2 6 = SCART 7 = HDMI 1 8 = HDMI 2 9 = HDMI 3 10 = HDMI 4 11 = HDMI 5 12 = HDMI 6 13 = HDMI 7 14 = HDMI 8 15 = DisplayPort
Information Output Resolution	IOR	R	No	N/A	N/A	Yes	
Information Output FPGA Version	IOV	R	No	N/A	N/A	Yes	
IP Address Byte 1	IP1	R/W	Yes	0	255	No	
IP Address Byte 2	IP2	R/W	Yes	0	255	No	
IP Address Byte 3	IP3	R/W	Yes	0	255	No	
IP Address Byte 4	IP4	R/W	Yes	0	255	No	
Information Pixel Clock	IPC	R	No	N/A	N/A	Yes	
Input Position Height	IPH	R/W	Yes	0	20	No	
Input Position Left Right	IPL	R/W	Yes	-50	50	No	
Input Position Up Down	IPU	R/W	Yes	-50	50	No	
Input Position Width	IPW	R/W	Yes	0	50	No	
Input Red Gain	IRG	R/W	Yes	-32	32	No	
Input Red Offset	IRO	R/W	Yes	-32	32	No	
Internal 3D Sync Delay	ISD	R/W	Yes	Var.	Var.	No	
Information Signal Format	ISF	R	No	N/A	N/A	Yes	
Information Serial Number	ISN	R	No	N/A	N/A	Yes	

Table 6-1. Serial Commands (continued)

Setting	Command Code	Read/Write	Inc/Dec	Min Value	Max Value	String?	Notes
Information Sync Type	IST	R	No	0	3	No	0 = None 1 = Separate 2 = Composite 3 = Sync-on-green
Information Vertical Frequency	IVF	R	No	N/A	N/A	Yes	
Remote Key	KEY	W	No	0	85	No	1 = On 2 = Off 3 = Menu 4 = Enter 5 = Up 6 = Down 7 = Left 8 = Right 9 = 16:9 10 = 4:3 11 = Letterbox 12 = VirtualWide 13 = Video 1 14 = Component 17 = HD 1 18 = HD 2 19 = HDMI 1 20 = HDMI 2 21 = HDMI 3 22 = HDMI 4 23 = SCART 24 = Video 2 25 = Video 3 32 = Sleep Timer Off 33 = Sleep Timer 30 Mins 34 = Sleep Timer 60 Mins 35 = Sleep Timer 90 Mins 36 = Sleep Timer 2 Hours 37 = Sleep Timer 4 Hours 38 = Screen 1 39 = Screen 2 44 = Cinema 45 = Virtual Cinema 46 = Native 48 = ISF Night 49 = ISF Day 50 = Custom 1 51 = Custom 2 52 = Exit
Remote Key Repeat	KRT	W	No	0	85	No	

Table 6-1. Serial Commands (continued)

Setting	Command Code	Read/Write	Inc/Dec	Min Value	Max Value	String?	Notes
Remote Key Repeat (cont.)	KRT	W	No	0	85	No	64 = Keypad Menu (used internally) 65 = Power Toggle (used internally) 66 = Enter Key Up (used internally) 67 = SRC 1 68 = SRC 2 69 = SRC 3 70 = SRC 4 71 = SRC 5 72 = SRC 6 73 = SRC 7 74 = SRC 8 75 = SRC 9 76 = SRC 10 77 = SRC 11 78 = SRC 12 79 = SRC 13 80 = SRC 14 81 = HDMI 5 82 = HDMI 6 83 = HDMI 7 84 = HDMI 8 85 = DisplayPort 86 = Auto Cinema
Language	LAN	R/W	No	0	9	No	0 = English 1 = French 2 = German 3 = Italian 4 = Spanish 5 = Portuguese 6 = Simplified Chinese 7 = Traditional Chinese 8 = Swedish 9 = Russian 10 = Japanese 11 = Korean
Lens Home Position	LHP	W	No	N/A	N/A	No	Action will be performed on any setting value
Lamp Hours Reset	LHR	W	No	N/A	N/A	No	Action will be performed on any setting value
Lamp Hours	LHS	R	No	0	(Note)	No	Max = 2,147,483,647
Image Alignment Left Middle x	LMX	R/W	Yes	-100	100	No	
Image Alignment Left Middle y	LMY	R/W	Yes	-100	100	No	
Lamp Life Notification Enable	LNE	R/W	No	0	1	No	0 = Off; 1 = On
Lamp Life Notification Hours	LNH	R/W	Yes	100	10,000	No	
Logo LED Brightness	LOG	R/W	Yes	0	31	No	
Lamp Power	LPW	R/W	Yes	-1	0	No	-1 = 230W; 0 = 260W

Table 6-1. Serial Commands (continued)

Setting	Command Code	Read/Write	Inc/Dec	Min Value	Max Value	String?	Notes
Display Serial Number	LSN	R	No	N/A	N/A	Yes	
Model Name	MDL	R	No	N/A	N/A	Yes	
Memory Preset	MMP	R/W	No	0	3	No	0 = ISF Night 1 = ISF Day 2 = Custom 1 3 = Custom 2
Memory Preset Copy	MPC	W	No	N/A	N/A	No	Action will be performed on any setting value
Memory Preset Paste	MPP	W	No	N/A	N/A	No	
Memory Preset Reset	MPR	W	No	0	3	No	0 = ISF Night 1 = ISF Day 2 = Custom 1 3 = Custom 2
Memory Preset Save	MPS	W	No	0	3	No	
Noise Filter	NFL	R/W	Yes	0	10	No	Calibration -> Input Color menu
Noise Filter Offset	NFO	R/W	Yes	0	10	No	Picture menu
Orientation	ORI	R/W	No	0	4	No	0 = Floor Front 1 = Ceiling Front 2 = Floor Rear 3 = Ceiling Rear 4 = Auto
OSD Position Horizontal	OSD	R/W	Yes	0	100	No	
Output Shift Height	OSH	R/W	Yes	-50	0	No	
Output Shift Left Right	OSL	R/W	Yes	-300	300	No	
OSD Message Enable	OSM	R/W	No	0	1	No	0 = Off; 1 = On
OSD Timer	OST	R/W	Yes	0	60	No	Values from 1-4 are not allowed; if increment or decrement is used, these values will be skipped.
Output Shift Up Down	OSU	R/W	Yes	-200	200	No	
OSD Position Vertical	OSV	R/W	Yes	0	100	No	
Output Shift Width	OSW	R/W	Yes	-50	0	No	
Overscan Mode	OVM	R/W	No	0	1	No	0 = Zoom 1 = Crop
Overscan	OVS	R/W	Yes	0	20	No	

Table 6-1. Serial Commands (continued)

Setting	Command Code	Read/Write	Inc/Dec	Min Value	Max Value	String?	Notes
Programmable Source Key [1 ... 14]	P01 P02 P03 P04 P05 P06 P07 P08 P09 P10 P11 P12 P13 P14	R/W	No	0	15	No	0 = Composite 1 1 = Composite 2 2 = Composite 3 3 = Component 4 = HD 1 5 = HD 2 6 = SCART 7 = HDMI 1 8 = HDMI 2 9 = HDMI 3 10 = HDMI 4 11 = HDMI 5 12 = HDMI 6 13 = HDMI 7 14 = HDMI 8 15 = DisplayPort
PCE Cyan X	PCX	R/W	Yes	-100	100	No	
PCE Cyan Y	PCY	R/W	Yes	-100	100	No	
Phase	PHS	R/W	Yes	0	31	No	
PCE Magenta X	PMX	R/W	Yes	-100	100	No	
PCE Magenta Y	PMY	R/W	Yes	-100	100	No	
Periodic Notification Enable	PNE	R/W	No	0	1	No	0 = Off; 1 = On
Periodic Notification Months	PNM	R/W	Yes	1	255	No	
Power	PWR	R/W	No	0	1	No	0 = Off; 1 = On
PCE Yellow X	PYX	R/W	Yes	-100	100	No	
PCE Yellow Y	PYY	R/W	Yes	-100	100	No	

Table 6-1. Serial Commands (continued)

Setting	Command Code	Read/Write	Inc/Dec	Min Value	Max Value	String?	Notes
Input Name 1 Restore	R01	W	No	N/A	N/A	No	Action will be performed on any setting value
Input Name 2 Restore	R02	W	No	N/A	N/A	No	
Input Name 3 Restore	R03	W	No	N/A	N/A	No	
Input Name 4 Restore	R04	W	No	N/A	N/A	No	
Input Name 5 Restore	R05	W	No	N/A	N/A	No	
Input Name 6 Restore	R06	W	No	N/A	N/A	No	
Input Name 7 Restore	R07	W	No	N/A	N/A	No	
Input Name 8 Restore	R08	W	No	N/A	N/A	No	
Input Name 9 Restore	R09	W	No	N/A	N/A	No	
Input Name 10 Restore	R10	W	No	N/A	N/A	No	
Input Name 11 Restore	R11	W	No	N/A	N/A	No	
Input Name 12 Restore	R12	W	No	N/A	N/A	No	
Input Name 13 Restore	R13	W	No	N/A	N/A	No	
Input Name 14 Restore	R14	W	No	N/A	N/A	No	
Input Name 15 Restore	R15	W	No	N/A	N/A	No	
Input Name 16 Restore	R16	W	No	N/A	N/A	No	
Remote Code	RMN	R/W	Yes	0	65535	No	
Image Alignment Right Middle x	RMX	R/W	Yes	-100	100	No	
Remote Network Control	RNC	R/W	No	0	1	No	0 = Off; 1 = On
Standby LED Enable	SBL	R/W	No	0	1	No	0 = Off; 1 = On
Splash Configure String 1	SC1	R/W	No	N/A	N/A	Yes	30 characters max
Splash Configure String 2	SC2	R/W	No	N/A	N/A	Yes	
Splash Configure String 3	SC3	R/W	No	N/A	N/A	Yes	
Sidebar Color Blue	SCB	R/W	Yes	0	255	No	
Sidebar Color Green	SCG	R/W	Yes	0	255	No	
Screen	SCN	R/W	No	0	1	No	0 = Screen 1 1 = Screen 2
Sidebar Color Red	SCR	R/W	Yes	0	255	No	
Send Errors to Runco	SER	R/W	No	0	1	No	0 = Off; 1 = On
Sharpness Offset	SHO	R/W	Yes	-50	50	No	
Sharpness	SHP	R/W	Yes	-50	50	No	
Screen Masking Bottom	SMB	R/W	Yes	0	200	No	
Screen Masking Test Pattern Enable	SME	R/W	No	0	1	No	0 = Off; 1 = On

Table 6-1. Serial Commands (continued)

Setting	Command Code	Read/Write	Inc/Dec	Min Value	Max Value	String?	Notes
Screen Masking Left	SML	R/W	Yes	0	200	No	
Screen Masking Test Pattern Mode Enable	SMM	R/W	No	0	1	No	0 = Off; 1 = On
Screen Masking Right	SMR	R/W	Yes	0	200	No	
Screen Masking Top	SMT	R/W	Yes	0	200	No	
Splash Enable	SPE	R/W	No	0	1	No	0 = Off; 1 = On
Splash Timer	SPT	R/W	Yes	5	60	No	
Status	STA	R	No	0	4	No	
Sync Threshold	STH	R/W	Yes	0	15	No	
Sleep Timer	STM	R/W	No	0	5	No	0 = Off 1 = 30 Minutes 2 = 60 Minutes 3 = 90 Minutes 4 = 2 Hours 5 = 4 Hours
Subnet Mask Byte 1	SU1	R/W	Yes	0	255	No	
Subnet Mask Byte 2	SU2	R/W	Yes	0	255	No	
Subnet Mask Byte 3	SU3	R/W	Yes	0	255	No	
Subnet Mask Byte 4	SU4	R/W	Yes	0	255	No	
System Reset	SYS	W	No	N/A	N/A	No	Action will be performed on any setting value

Table 6-1. Serial Commands (continued)

Setting	Command Code	Read/Write	Inc/Dec	Min Value	Max Value	String?	Notes
Trigger 1 16:9	T11	R/W	No	0	1	No	0 = Off; 1 = On
Trigger 1 4:3	T12	R/W	No	0	1	No	
Trigger 1 Letterbox	T13	R/W	No	0	1	No	
Trigger 1 VirtualWide	T14	R/W	No	0	1	No	
Trigger 1 Cinema	T15	R/W	No	0	1	No	
Trigger 1 Virtual Cinema	T16	R/W	No	0	1	No	
Trigger 1 Native	T17	R/W	No	0	1	No	
Trigger 2 16:9	T21	R/W	No	0	1	No	
Trigger 2 4:3	T22	R/W	No	0	1	No	
Trigger 2 Letterbox	T23	R/W	No	0	1	No	
Trigger 2 VirtualWide	T24	R/W	No	0	1	No	
Trigger 2 Cinema	T25	R/W	No	0	1	No	
Trigger 2 Virtual Cinema	T26	R/W	No	0	1	No	
Trigger 2 Native	T27	R/W	No	0	1	No	
Trigger 3 16:9	T31	R/W	No	0	1	No	
Trigger 3 4:3	T32	R/W	No	0	1	No	
Trigger 3 Letterbox	T33	R/W	No	0	1	No	
Trigger 3 VirtualWide	T34	R/W	No	0	1	No	
Trigger 3 Cinema	T35	R/W	No	0	1	No	
Trigger 3 Virtual Cinema	T36	R/W	No	0	1	No	
Trigger 3 Native	T37	R/W	No	0	1	No	
3D Test Pattern Enable	TDE	R/W	No	0	1	No	0 = Off; 1 = On
3D Mode	TDM	R/W	No	0	4	No	0 = Auto 1 = Off 2 = Side-by-Side 3 = Top-and-Bottom 4 = Frame Packing
3D Reverse Eyes	TDR	R/w	No	0	1	No	0 = Off; 1 = On
Image Alignment Top Left x	TLX	R/W	Yes	-100	100	No	
Image Alignment Top Left y	TLY	R/W	Yes	-100	100	No	
3D Test Pattern Enable	TME	R/W	No	0	1	No	0 = Off; 1 = On
Image Alignment Top Middle x	TMX	R/W	Yes	-100	100	No	
Image Alignment Top Middle y	TMY	R/W	Yes	-100	100	No	
Tint Offset	TNO	R/W	Yes	-50	50	No	Picture menu
Tint	TNT	R/W	Yes	-50	50	No	Calibration -> Input Image menu

Table 6-1. Serial Commands (continued)

Setting	Command Code	Read/Write	Inc/Dec	Min Value	Max Value	String?	Notes
Test Pattern Enable	TPE	R/W	No	0	1	No	0 = Off; 1 = On
Primary Test Pattern	TPP	R/W	No	0	1	No	0 = Off; 1 = On
Secondary Test Pattern	TPS	R/W	No	0	1	No	0 = Off; 1 = On
Tracking	TRK	R/W	Yes	-100	100	No	
Image Alignment Top Right x	TRX	R/W	Yes	-100	100	No	
Image Alignment Top Right y	TRY	R/W	Yes	-100	100	No	
Display 3D Sync Delay	TSD	R/W	Yes	Var.	Var.	No	
Display 3D Sync Invert	TSI	R/W	No	0	1	No	0 = Not Inverted; 1 = Inverted
Test Video	TST	R/W	No	0	4	No	1 = Color Bars 1 2 = Full White 11 = Color Bars 2 12 = Gray Bars 13 = Focus 14 = Off 15 = Off (Restore OSD) 16 = Primary Alignment 17 = Secondary Alignment 18 = Dual Alignment 19 = 3D
VFD Text Line 1	VF1	W	No	N/A	N/A	Yes	24 characters max
VFD Text Line 2	VF2	W	No	N/A	N/A	Yes	24 characters max
VFD Brightness	VFD	R/W	Yes	0	4	No	0 = 0% 1 = 25% 2 = 50% 3 = 75% 4 = 100%
Vertical Shift	VSH	W	Yes	0	0	No	Send (VSH+) or (VSH-) to adjust incrementally
Zoom	ZOM	W	Yes	0	0	No	Send (ZOM+) or (ZOM-) to adjust incrementally

The Dimension Digital Controller accepts commands in the form of IR signals that conform to the NEC protocol. Each Dimension Digital Controller remote control button has an NEC control code associated with it.

You can use these codes to program a third-party, “universal” remote control unit to work with the Dimension Digital Controller. These third-party products usually come with a computer software application for this purpose. For more information, consult the documentation provided with the remote control unit.

The IR control codes have the following characteristics:

- Each code consists of the following:
 - A **leader pulse** (a modulated pulse of 9 ms followed by a non-modulated pulse of 4.5 ms);
 - 16 **address bits**. The default address is **82 09** (0x2011, binary 00100000 00010001). To change it, select Remote Control from the Service menu and follow the steps given on page 83;
 - 16 **data bits**: eight (8) bits for the command followed by the logical inverse of the command; and
 - An **end pulse** (a modulated pulse of 0.56 ms, similar to the modulated pulse in the ‘0’ and ‘1’ bits). The end of the modulated pulse constitutes the end of the data transmission.
- The carrier frequency is 38 kHz, with the modulated pulses having a 33% duty cycle.
- Commands are sent at a maximum rate of 9 Hz.

For example, here is the NEC control code for the **ON** button on the Dimension Digital Controller remote control unit (assuming the default address is used):

Hex	20	11	01	FE
Binary	00100000	00010001	00000001	11111110
Function	Address Byte 1	Address Byte 2	Command	Command (Logical Inverse)

Figure 6-1 shows the pulse train for this command.

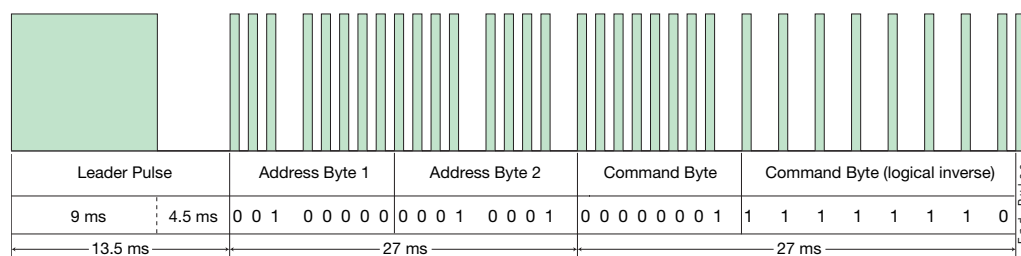

Figure 6-1. NEC Protocol Message Format

6.2 Using Discrete IR Codes

◀ IR Command Protocol

IR Command List ➤
(Standard Mode)

Table 6-2 lists the NEC control codes for the Dimension Digital Controller.

Table 6-2. NEC Control Codes for the Dimension Digital Controller (Standard Mode)

Remote Control Button Name	Address	Data	NEC Data From Remote (Note)	Description
ON	8209	1	0x201101FE	Power on
OFF (standby)	8209	2	0x201102FD	Power off
16:9	8209	3	0x201103FC	16:9 aspect ratio
4:3	8209	4	0x201104FB	4:3 aspect ratio
LETBOX	8209	5	0x201105FA	Letterbox aspect ratio
V-WIDE	8209	6	0x201106F9	VirtualWide aspect ratio
CINEMA	8209	7	0x201107F8	Cinema aspect ratio
V-CINE	8209	8	0x201108F7	Virtual Cinema aspect ratio
NATIVE	8209	9	0x201109F6	Native aspect ratio
1	8209	10	0x20110AF5	Number Button 1
2	8209	11	0x20110BF4	Number Button 2
3	8209	12	0x20110CF3	Number Button 3
4	8209	13	0x20110DF2	Number Button 4
5	8209	14	0x20110EF1	Number Button 5
6	8209	15	0x20110FF0	Number Button 6
7	8209	16	0x201110EF	Number Button 7
8	8209	17	0x201111EE	Number Button 8
9	8209	18	0x201112ED	Number Button 9
0	8209	19	0x201113EC	Number Button 0
ISF DAY	8209	20	0x201114EB	ISF Day memory preset
ISF NIGHT	8209	21	0x201115EA	ISF Night memory preset
SCREEN 1	8209	22	0x201116E9	Selects "Screen 1"
CUST 1	8209	23	0x201117E8	Custom 1 memory preset
CUST 2	8209	24	0x201118E7	Custom 2 memory preset
SCREEN 2	8209	25	0x201119E6	Selects "Screen 2"
MENU	8209	26	0x20111AE5	MENU
EXIT	8209	27	0x20111BE4	EXIT
Up	8209	28	0x20111CE3	Up-Arrow (▲)

Note: These codes assume that the default address of 8209 is used. If you change it to something other than 8209, you will need to modify these codes accordingly.

Table 6-2. NEC Control Codes for the Dimension Digital Controller (Standard Mode) (continued)

Remote Control Button Name	Address	Data	NEC Data From Remote (Note)	Description
Right	8209	29	0x20111DE2	Right-Arrow (▶)
Down	8209	30	0x20111EE1	Down-Arrow (▼)
Left	8209	31	0x20111FE0	Left-Arrow (◀)
ENTER	8209	32	0x201120DF	ENTER
SRC 1	8209	33	0x201121DE	Video Source 1
SRC 2	8209	34	0x201122DD	Video Source 2
SRC 3	8209	35	0x201123DC	Video Source 3
SRC 4	8209	36	0x201124DB	Video Source 4
SRC 5	8209	37	0x201125DA	Video Source 5
SRC 6	8209	38	0x201126D9	Video Source 6
SRC 7	8209	39	0x201127D8	Video Source 7
SRC 8	8209	40	0x201128D7	Video Source 8
SRC 9	8209	41	0x201129D6	Video Source 9
SRC 10	8209	42	0x20112AD5	Video Source 10
SRC 11	8209	43	0x20112BD4	Video Source 11
SRC 12	8209	44	0x20112CD3	Video Source 12
SRC 13	8209	43	0x20112BD4	Video Source 13
SRC 14	8209	46	0x20112ED1	Video Source 14
3D AUTO	8209	47	0x20112FD0	3D Mode = Auto
3D SBS	8209	48	0x201130CF	3D Mode = Side-by-Side
3D TAB	8209	49	0x201131CE	3D Mode = Top-and-Bottom
3D FP	8209	50	0x201132CD	3D Mode = Frame Packing
STOFF	8209	65	0x201141BE	Sets the sleep timer to Off
ST30MIN	8209	66	0x201142BD	Sets the sleep timer to 30 minutes
ST60MIN	8209	67	0x201143BC	Sets the sleep timer to 60 minutes
ST90MIN	8209	68	0x201144BB	Sets the sleep timer to 90 minutes
ST2HRS	8209	69	0x201145BA	Sets the sleep timer to 2 hours
ST4HRS	8209	70	0x201146B9	Sets the sleep timer to 4 hours
VIDEO 1	8209	71	0x201147B8	Composite video input 1

Note: These codes assume that the default address of 8209 is used. If you change it to something other than 8209, you will need to modify these codes accordingly.

Table 6-2. NEC Control Codes for the Dimension Digital Controller (Standard Mode) (continued)

Remote Control Button Name	Address	Data	NEC Data From Remote (Note)	Description
COMP	8209	72	0x201148B7	Component video input
HD 1	8209	73	0x201149B6	HD1 video input
HD 2	8209	74	0x20114AB5	HD2 video input
HDMI 1	8209	75	0x20114BB4	HDMI1 video input
HDMI 2	8209	76	0x20114CB3	HDMI2 video input
HDMI 3	8209	77	0x20114DB2	HDMI3 video input
HDMI 4	8209	78	0x20114EB1	HDMI4 video input
HDMI 5	8209	79	0x20114FB0	HDMI5 video input
HDMI 6	8209	80	0x201150AF	HDMI6 video input
HDMI 7	8209	81	0x201151AE	HDMI7 video input
HDMI 8	8209	82	0x201152AD	HDMI8 video input
DisplayPort	8209	83	0x201153AC	DisplayPort video input
SCART	8209	84	0x201154AB	SCART video input
VIDEO 2	8209	85	0x201155AA	Composite video input 2
VIDEO 3	8209	86	0x201156A9	Composite video input 3
3D OFF	8209	87	0x201157A8	3D Mode = Off
Auto Cinema	8209	88	0x201158A7	Auto Cinema aspect ratio

Note: These codes assume that the default address of 8209 is used. If you change it to something other than 8209, you will need to modify these codes accordingly.

Table 6-3 lists the Extended-mode NEC control codes for the Dimension Digital Controller. To use the remote control unit in extended mode, set the address code to **88999** (refer to **Remote Control** on page 83).

◀ **IR Command List
(Extended Mode)**

**Table 6-3. NEC Control Codes for the Dimension Digital Controller
(Extended Mode)**

Remote Control Button Name	Address	Data	NEC Data From Remote (Note)	Description
ON	8209	65	0x201141BE	Sets the sleep timer to Off
OFF (standby)	8209	66	0x201142BD	Sets the sleep timer to 30 minutes
16:9	8209	67	0x201143BC	Sets the sleep timer to 60 minutes
4:3	8209	68	0x201144BB	Sets the sleep timer to 90 minutes
LETBOX	8209	69	0x201145BA	Sets the sleep timer to 2 hours
V-WIDE	8209	70	0x201146B9	Sets the sleep timer to 4 hours
CINEMA	8209	71	0x201147B8	Composite video input 1
V-CINE	8209	72	0x201148B7	Component video input
NATIVE	8209	73	0x201149B6	HD1 video input
1	8209	74	0x20114AB5	HD2 video input
2	8209	75	0x20114BB4	HDMI1 video input
3	8209	76	0x20114CB3	HDMI2 video input
4	8209	77	0x20114DB2	HDMI3 video input
5	8209	78	0x20114EB1	HDMI4 video input
6	8209	79	0x20114FB0	HDMI5 video input
7	8209	80	0x201150AF	HDMI6 video input
8	8209	81	0x201151AE	HDMI7 video input
9	8209	82	0x201152AD	HDMI8 video input
0	8209	83	0x201153AC	DisplayPort video input
ISF DAY	8209	84	0x201154AB	SCART video input
ISF NIGHT	8209	85	0x201155AA	Composite video input 2
SCREEN 1	8209	86	0x201156A9	Composite video input 3
CUST 1	8209	87	0x201157A8	3D Mode = Off
CUST 2	8209	88	0x201158A7	Auto Cinema aspect ratio

Note: These codes assume that the default address of 8209 is used. If you change it to something other than 8209, you will need to modify these codes accordingly.

6.3 Using HDMI CEC Messages

The Dimension Digital Controller accepts and can respond to CEC command messages from a disc player, satellite receiver or DVR/set-top box via an HDMI connection. Using CEC, the Dimension Digital Controller can perform the following actions:

- Turn itself and the projector on and select the correct input when the source component initiates playback of a disc or recorded program.
- Turn the source component on when you switch to its corresponding input on the Dimension Digital Controller.
- Turn the source component off when the LS-12HBd system is turned off (unless the source component is in playback mode).
- Change its OSD language when a similar change is made at the source.

To use CEC, connect your CEC-compatible sources to the HDMI inputs on the Dimension Digital Controller. Set the CEC option to **On** (refer to **CEC** on page 92). Additional steps may be needed to enable CEC at the source. Refer to the documentation for your source device for more information.

CEC Command List ➤ Table 6-4 lists the CEC commands supported by the Dimension Digital Controller.

Table 6-4. CEC Commands Supported by the Dimension Digital Controller

Opcode	Value	Supported? (√ = Yes, – = No)	
		Initiator	Follower
Feature Abort	0x00	√	√
Standby	0x36	√	√
Routing Change	0x80	√	√
Routing Information	0x81	√	√
Active Source	0x82	√	√
Request Active Source	0x85	√	√
Device Vendor ID	0x87	√	√
Give Device Vendor ID	0x8C	√	√
Vendor Command With ID	0xA0	√	√
Polling Message	N/A	√	√
Text View On	0x0D	√	–
Report Physical Address	0x84	√	–
Inactive Source	0x9D	√	–
CEC Version	0x9E	√	–
Set OSD Name	0x47	√	–
Menu Status	0x8E	√	–
Report Power Status	0x90	√	–

Table 6-4. CEC Commands Supported by the Dimension Digital Controller (continued)

Opcode	Value	Supported? (√ = Yes, – = No)	
		Initiator	Follower
Set Menu Language	0x32	–	√
Give Physical Address	0x83	–	√
Set Stream Path	0x86	–	√
Get CEC Version	0x9F	–	√
Abort Message	0xFF	–	√
User Control Pressed	0x44	–	√
User Control Released	0x45	–	√
Give OSD Name	0x46	–	√
Menu Request	0x8D	–	√
Give Device Power Status	0x8F	–	√

**Note**

The Dimension Digital Controller does not transmit HDMI CEC control messages from the “HDMI Audio Out” connector.

Notes:

7. Specifications

Table 7-1 lists the LS-12HBd projector specifications.

Table 7-1. LS-12HBd Projector Specifications

Projector Type:	Digital Light Processing™ (DLP), 3-chip, 16:9 SuperOnyx™ DMD™
Native Resolution:	Full HD 1920 x 1080 (1080p)
Estimated Lamp Life:	2000 hours, typical (260W power setting) 3000 hours, typical (230W power setting)
Aspect Ratios:	4:3, Letterbox, 16:9, VirtualWide, Cinema, Virtual Cinema, Native
DTV Compatibility:	Refer to Table 7-2
Picture Size (16:9 Screen):	Recommended Width: 80 - 117 in. Maximum Width: 175 in.
Processing:	Runco Dimension Digital Controller with ViVix IV™ technology and BRiC (Backup, Recovery and Clone) tool
Control Options:	<ul style="list-style-type: none"> • Serial commands via RS-232 • Discrete infrared (IR) remote • Consumer Electronics Control (CEC) protocol support via HDMI • Ethernet
Inputs and Outputs:	<ul style="list-style-type: none"> • Digital Video x 2 (from Dimension Digital Controller) • RS-232 (female DB9) for serial communications • 3D Sync Out (female 3-pin, VESA standard mini-DIN) to IR Emitter
Video Standards:	NTSC, PAL, SECAM, GEA-861D
Calibration:	ISF Certified Calibration Configuration
Throw Distance (Factor x Screen Width):	Refer to Table 3-3
Horizontal & Vertical Offset:	Proteus 1: None Proteus 2, 3, 4, 5, 6: Horizontal: 30% of screen width left or right Vertical: 65% of screen height up or down
Light Output (2D):	CSMS Specifications* – Home Theater Calibration: 2,592 ANSI Lumens; 94 Foot-Lamberts (fL) Uncalibrated: 3,780 ANSI Lumens *Measured on a 1.0 gain, 84" wide 16:9 screen
Contrast Ratio:	CSMS Contrast Ratio: >250:1 (ANSI); 10,000:1 full-on, full-off
Illumination System:	230W HPM lamp

7.1 LS-12HBd Projector Specifications

Table 7-1. LS-12HBd Projector Specifications (continued)

Lens System:	Motorized focus, zoom and position controls
Refresh Rate:	24 Hz, 50 Hz or 60 Hz (2D content) 100 Hz or 120 Hz (3D content)
3D Technology:	Frame sequential, active shutter
Power Requirements:	100 to 240 VAC (auto-sensing), 50/60 Hz, 400 Watts (1365.2 BTUs/hour)
Operating Temperature:	10°C to 40°C, up to 7,500' altitude 10°C to 35°C, 7,500' to 10,000' altitude
Operating Humidity:	10 - 80% humidity (non-condensing)
Dimensions:	See Figure 7-1
Weight (without lens):	40.8 lbs. (18.50 kg)
Regulatory Approvals:	FCC Part 15, Subpart B Class B, UL 60950, IEC60950, RoHS
Limited Warranty:	Two (2)-year PremierCare™ warranty; lamp warranty 1000 hours or (6) six months, whichever comes first (US and Canada only)
Specifications are subject to change without notice.	

Table 7-2 lists the Dimension Digital Controller specifications.

Table 7-2. Dimension Digital Controller Specifications

Aspect Ratios:	4:3, Letterbox, 16:9, VirtualWide, Cinema, Virtual Cinema, Native
Video Standards:	<ul style="list-style-type: none"> • DisplayPort with HDCP • HDMI and DVI with HDCP for digital video • Component and RGB HDTV (1080p, 1080i, 720p) • Component and RGB EDTV (576p, 480p) • Component and Composite SDTV (576i, 480i) • RGB SCART with adaptor • NTSC (M, 4.43) • PAL (B, G, H, I, N, M) • SECAM (M)
Inputs:	<ul style="list-style-type: none"> (1) DisplayPort 1.1a (8) HDMI with 3D Support, CEC and Deep Color (1) Component/SCART (3 x RCA) (2) Component/RGBHV (15-pin VGA) (3) Composite
Outputs:	<ul style="list-style-type: none"> (2) HDMI with 3D Support and Deep Color to LS-12HBd (1) HDMI with Deep Color to second display or audio processor
Control Options:	<ul style="list-style-type: none"> • Front panel vacuum fluorescent display and keypad • Discrete infrared (IR) remote • RS-232 (female DB9) for serial commands • USB (type B female) for firmware upgrade • RS-232 (male DB9) for accessories • 3.5-mm wired IR input for Nilès/Xantech-compatible IR systems • Consumer Electronics Control (CEC) protocol support via HDMI • Ethernet
Ethernet Communication:	RJ45 (female) for web server, e-mail, auto firmware upgrade and Telnet
RS-232 Communication Parameters:	19200 bps, no parity, 8 data bits, 1 stop bit, no flow control
Trigger Outputs:	(3) +12 VDC, each rated at 250 mA and thermal fuse-protected
Accessory Applications:	Runco Firmware Upgrader, Runco BRIC (backup, restore, clone), CalMAN by SpectraCal for automatic calibration
Power Requirements:	100-240V~, 47-63Hz, 0.85 Amps
Operating Environment:	41°F to 104°F (5°C to 40°C), 0% to 90% humidity (non-condensing); up to 10,000 feet (3,048 meters) altitude
Dimensions:	<ul style="list-style-type: none"> Width = 17.50 inches (444.5 mm) Depth = 17.68 inches (449.0 mm) Height = 3.75 inches (95.3 mm)

7.2 Dimension Digital Controller Specifications

Table 7-2. Dimension Digital Controller Specifications (continued)

Weight:	17.6 lbs. (8.00 kg)
Regulatory Approvals:	cTUVus, FCC class B, CE, RoHS, China RoHS, WEEE, C-Tick, CCC, local conformances as required
Limited Warranty:	Two (2) years parts and labor from the date of shipment from Runco.

Specifications are subject to change without notice.

Table 7-3 lists the signal types supported by each input on the Dimension Digital Controller.

7.3 Supported Timings

Table 7-3. Supported Signal Timings by Input

Format	Resolution	Refresh Rate (Hz)	Horizontal Frequency (kHz)	Pixel Frequency (MHz)	Supported? (√ = Yes, – = No)					
					HD 1 HD 2	HDMI [1 ... 8]	DisplayPort	Component	SCART	Composite 1 Composite 2 Composite 3
Supported 3D Modes										
1080i SBS (Side-by-Side)	1920x1080	50.00	28.125/31.250	74.250/72.000	–	√	–	–	–	–
		59.94	33.716	74.175	–	√	–	–	–	–
		60.00	33.750	74.250	–	√	–	–	–	–
720p TAB (Top-and-Bottom)	1280x720	50.00	37.500	75.250	–	√	–	–	–	–
		59.94	44.715	74.406	–	√	–	–	–	–
		60.00	45.000	74.250	–	√	–	–	–	–
720p SBS (Side-by-Side)	1280x720	50.00	37.500	75.250	–	√	–	–	–	–
		59.94	44.715	74.406	–	√	–	–	–	–
		60.00	45.000	74.250	–	√	–	–	–	–
720p FP (Frame Packing)	1280x720	23.98	17.982	59.341	–	√	–	–	–	–
		24.00	18.000	59.400	–	√	–	–	–	–
		29.97	22.478	74.175	–	√	–	–	–	–
		30.00	22.500	74.250	–	√	–	–	–	–
		50.00	37.500	75.250	–	√	–	–	–	–
		59.94	44.715	74.406	–	√	–	–	–	–
		60.00	45.000	74.250	–	√	–	–	–	–
1080p SBS (Side-by-Side)	1920x1080	23.98	26.978	74.175	–	√	–	–	–	–
		24.00	27.000	74.250	–	√	–	–	–	–
		29.97	33.716	74.175	–	√	–	–	–	–
		30.00	33.750	74.250	–	√	–	–	–	–
		50.00	56.250	148.500	–	√	–	–	–	–
		59.94	67.433	148.350	–	√	–	–	–	–
		60.00	67.500	148.500	–	√	–	–	–	–

Table 7-3. Supported Signal Timings by Input (continued)

Format	Resolution	Refresh Rate (Hz)	Horizontal Frequency (kHz)	Pixel Frequency (MHz)	Supported? (√ = Yes, – = No)					
					HD 1 HD 2	HDMI [1 ... 8]	DisplayPort	Component	SCART	Composite 1 Composite 2 Composite 3
Supported 3D Modes (continued)										
1080p TAB (Top-and-Bottom)	1920x1080	23.98	26.978	74.175	–	√	–	–	–	–
		24.00	27.000	74.250	–	√	–	–	–	–
		29.97	33.716	74.175	–	√	–	–	–	–
		30.00	33.750	74.250	–	√	–	–	–	–
		50.00	56.250	148.500	–	√	–	–	–	–
		59.94	67.433	148.350	–	√	–	–	–	–
1080p FP (Frame Packing)	1920x1080	23.98	26.978	74.175	–	√	–	–	–	–
		24.00	27.000	74.250	–	√	–	–	–	–
		29.97	33.716	74.175	–	√	–	–	–	–
		30.00	33.750	74.250	–	√	–	–	–	–
Supported 2D Modes										
640x480	640x480	60.00	31.469	25.175	√	√	√	√	–	–
		66.59	35.892	29.862	√	√	√	√	–	–
		72.00	37.861	31.500	√	√	√	√	–	–
		75.00	37.500	31.500	√	√	√	√	–	–
		85.00	43.269	36.000	√	√	√	√	–	–
800x600	800x600	60.00	37.879	40.000	√	√	√	√	–	–
		72.00	48.077	50.000	√	√	√	√	–	–
		75.00	46.875	49.500	√	√	√	√	–	–
		85.00	53.674	56.250	√	√	√	√	–	–
832x624	832x624	74.54	52.849	60.036	√	√	√	√	–	–
848x480	848x480	47.95	25.270	27.089	√	√	√	√	–	–
		60.00	31.020	33.750	√	√	√	√	–	–
1024x768	1024x768	60.00	48.363	65.000	√	√	√	√	–	–
		70.00	56.476	75.000	√	√	√	√	–	–
		75.00	60.023	78.750	√	√	√	√	–	–
		85.00	68.677	94.500	√	√	√	√	–	–

Table 7-3. Supported Signal Timings by Input (continued)

Format	Resolution	Refresh Rate (Hz)	Horizontal Frequency (kHz)	Pixel Frequency (MHz)	Supported? (√ = Yes, – = No)					
					HD 1 HD 2	HDMI [1 ... 8]	DisplayPort	Component	SCART	Composite 1 Composite 2 Composite 3
Supported 2D Modes (continued)										
1152x864	1152x864	75.00	67.500	108.000	√	√	√	√	–	–
1280x720	1280x720	47.95	37.833	64.769	√	√	√	√	–	–
1280x768	1280x768	60.00	47.396	68.250	√	√	√	√	–	–
		60.00	47.776	79.500	√	√	√	√	–	–
		75.00	60.289	102.250	√	√	√	√	–	–
		85.00	68.633	117.500	√	√	√	√	–	–
1280x960	1280x960	60.00	60.000	108.000	√	√	√	√	–	–
		85.00	85.938	148.500	√	√	√	√	–	–
1280x1024	1280x1024	60.00	63.981	108.000	√	√	√	√	–	–
		75.00	79.976	135.000	√	√	√	√	–	–
		85.00	91.146	157.500	√	√	√	√	–	–
1360x768	1360x768	60.00	47.712	85.500	√	√	√	√	–	–
1400x1050	1400x1050	60.00	64.744	101.000	√	√	√	√	–	–
		60.00	65.317	121.750	√	√	√	√	–	–
		75.00	82.278	156.000	√	√	√	√	–	–
1600x1200	1600x1200	60.00	75.000	162.000	√	√	√	√	–	–
1680x1050	1680x1050	60.00	64.674	119.000	√	√	√	√	–	–
1920x1080	1920x1080	47.95	56.821	150.007	√	√	√	√	–	–
1920x1200	1920x1200	60.00	74.038	154.000	√	√	√	√	–	–

Table 7-3. Supported Signal Timings by Input (continued)

Format	Resolution	Refresh Rate (Hz)	Horizontal Frequency (kHz)	Pixel Frequency (MHz)	Supported? (√ = Yes, – = No)					
					HD 1 HD 2	HDMI [1 ... 8]	DisplayPort	Component	SCART	Composite 1 Composite 2 Composite 3
Supported 2D Modes (continued)										
SCART RGBS	–	50.00	–	–	–	–	–	–	√	–
480/60i	720x487	59.94	15.734	13.500	√	√	√	√	–	–
480/60p	720x483	59.94	31.469	27.000	√	√	√	√	–	–
576/50i	720x576	50.00	15.625	14.750	√	√	√	√	–	–
576/50p	720x576	50.00	31.250	29.000	√	√	√	√	–	–
720/24p	1280x720	23.98/ 24.00	17.982/18.000	59.341/59.400	√	√	√	√	–	–
720/25p	1280x720	25.00	18.750	74.250	√	√	√	√	–	–
720/30p	1280x720	29.97/ 30.00	22.478/22.500	74.175/74.250	√	√	√	√	–	–
720/50p	1280x720	50.00	37.500	75.250	√	√	√	√	–	–
720/60p	1280x720	60.00	45.000	74.250	√	√	√	√	–	–
1080/50i	1920x1080	50.00	28.125/31.250	74.250/72.000	√	√	√	√	–	–
1080/60i	1920x1080	59.94/ 60.00	33.716/33.750	74.175/74.250	√	√	√	√	–	–
1080/24p	1920x1080	23.98/ 24.00	26.978/27.000	74.175/74.250	√	√	√	√	–	–
1080/50p	1920x1080	50.00	56.250	148.500	√	√	√	√	–	–
1080/60p	1920x1080	59.94/ 60.00	67.433/67.500	148.350/148.500	√	√	√	√	–	–
NTSC 3.58	–	59.94/ 60.00	15.734/15.750	3.580	–	–	–	–	–	√
NTSC 4.43	–	59.94/ 60.00	15.734/15.750	4.430	–	–	–	–	–	√
PAL-B/G/H/I	–	50.00	15.625	4.430	–	–	–	–	–	√
PAL-M	–	59.94/ 60.00	15.734/15.750	3.580	–	–	–	–	–	√
PAL-N	–	50.00	15.625	3.580	–	–	–	–	–	√
SECAM	–	50.00	15.625	13.500	–	–	–	–	√	√

Figure 7-1 shows the LS-12HBd dimensions, in [millimeters] and inches.

7.4 LS-12HBd Dimensions

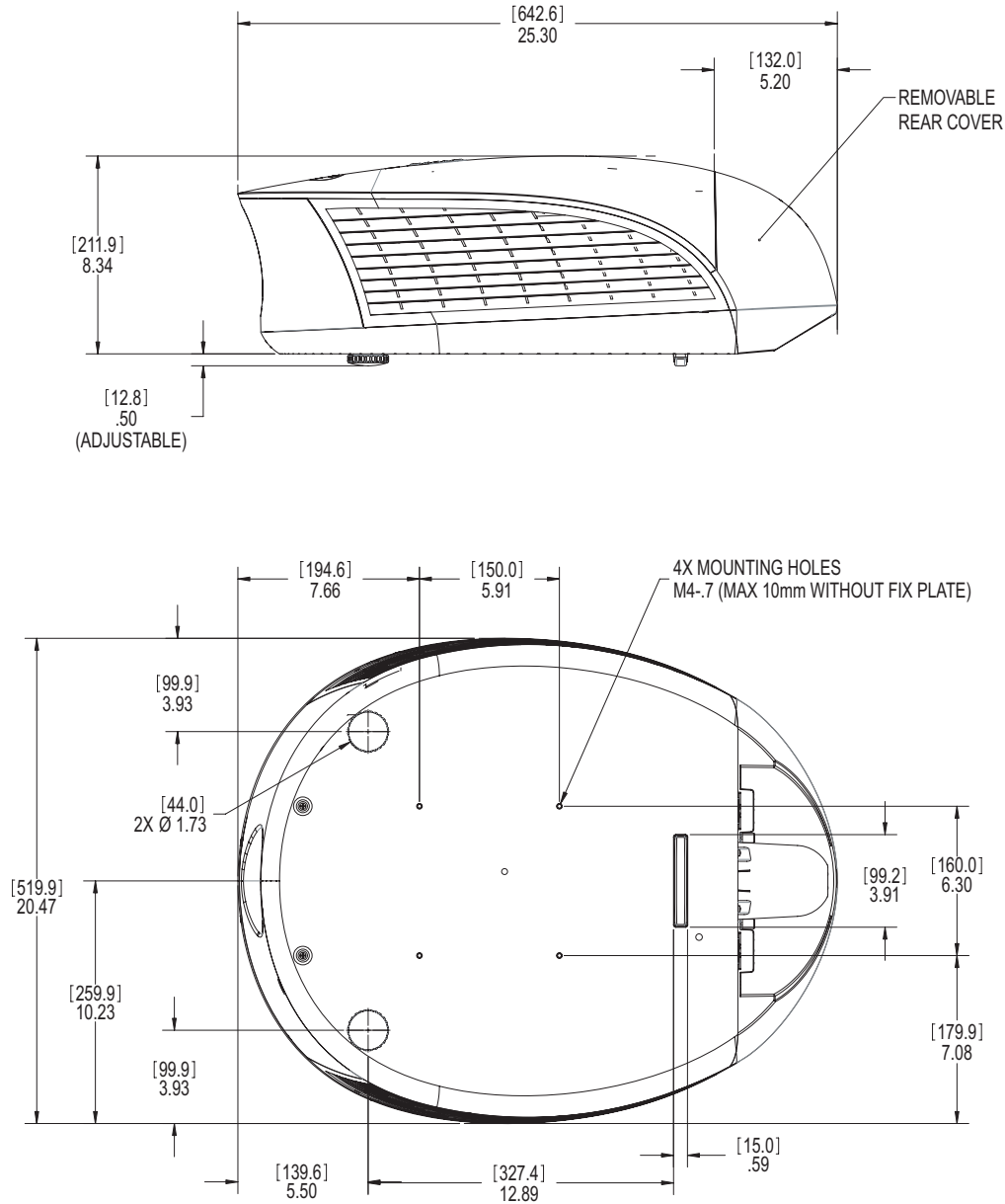

Figure 7-1. LS-12HBd Dimensions

Notes:

020-1251-00 Rev. A
September 2013