



OWNER'S OPERATING MANUAL



CL-810 Series

Digital Light Processing™ Projectors

CL-810

CL-810 Ultra

CL-810 CineWide

CL-810 / SDC-1



THE WORLD'S FINEST HOME THEATER PRODUCTS™

TWO YEAR LIMITED WARRANTY

For Projectors, Video Processors and Controllers

Congratulations on your purchase of a Runco video product and welcome to the Runco family! We believe Runco produces "The World's Finest Home Theater Products." With proper installation, setup and care, you should enjoy many years of unparalleled video performance.

This is a LIMITED WARRANTY as defined in the Magnuson-Moss Warranty Act. Please read it carefully and retain it with your other important documents.

WHAT IS COVERED UNDER THE TERMS OF THIS LIMITED WARRANTY:

SERVICE LABOR: Runco will pay for service labor by Runco Authorized Service Center when needed as a result of manufacturing defect for a period of two (2) years from the effective date of delivery to the end user (excluding the lamp).

PARTS: (Not including the lamp) Runco will provide new or rebuilt replacement parts for the parts that fail due to defects in materials or workmanship for a period of two (2) years from the effective date of delivery to the end user. Such replacement parts are then subsequently warranted for the remaining portion (if any) of the original warranty period.

PROJECTOR LAMP: Runco will pay for service labor by a Runco Authorized Service Center when needed as a result of a manufacturing defect for a period of six (6) months or 1000 hours, which ever comes first, from the effective date of delivery to the end user. In addition, Runco will provide a new or rebuilt replacement lamp for the lamp that fails due to defects in materials or workmanship for a period of six (6) months or 1000 hours, which ever comes first, from the effective date of delivery to the end user. Such replacement lamps are then subsequently warranted for the remaining portion (if any) of the original warranty period.

WHAT IS NOT COVERED UNDER THE TERMS OF THIS LIMITED WARRANTY:

This Limited Warranty only covers failure due to defects in materials and workmanship that occur during normal use and does not cover normal maintenance. This Limited Warranty does not cover cabinets or any appearance items; failure resulting from accident, misuse, abuse, neglect, mishandling, misapplication, faulty or improper installation or setup adjustments; improper maintenance, alteration, improper use of any input signal; damage due to lightning or power line surges, spikes and brownouts; damage that occurs during shipping or transit; or damage that is attributed to acts of God. In the case of remote control units, damage resulting from leaking, old, damaged or improper batteries is also excluded from coverage under this Limited Warranty.

CAUTION: THIS LIMITED WARRANTY ONLY COVERS RUNCO PRODUCTS PURCHASED FROM RUNCO AUTHORIZED DEALERS. ALL OTHER PRODUCTS ARE SPECIFICALLY EXCLUDED FROM COVERAGE UNDER THIS LIMITED WARRANTY. MOREOVER, DAMAGE RESULTING DIRECTLY OR INDIRECTLY FROM IMPROPER INSTALLATION OR SETUP IS SPECIFICALLY EXCLUDED FROM COVERAGE UNDER THIS LIMITED WARRANTY.

RIGHTS, LIMITS AND EXCLUSIONS:

Runco limits its obligations under any implied warranties under state laws to a period not to exceed the warranty period. There are no express warranties. Runco also excludes any obligation on its part for incidental or consequential damages related to the failure of this product to function properly. Some states do not allow limitations on how long an implied warranty lasts, and some states do not allow the exclusion or limitation of incidental or consequential damages. So the above limitations or exclusions may not apply to you. This warranty gives you specific legal rights, and you may also have other rights that vary from state to state.

EFFECTIVE WARRANTY DATE:

This warranty begins on the effective date of delivery to the end user. For your convenience, keep the original bill of sale as evidence of the purchase date.

IMPORTANT -- WARRANTY REGISTRATION:

Please fill out and mail your warranty registration card. It is imperative that Runco knows how to reach you promptly if we should discover a safety problem or product update for which you must be notified.

CONTACT A RUNCO AUTHORIZED SERVICE CENTER TO OBTAIN SERVICE:

Repairs made under the terms of this Limited Warranty covering your Runco video product will be performed at the location of the product, during usual working hours, providing location of product is within normal operating distance from a Runco Authorized Service Center. In some instances it may be necessary for the product to be returned to the Runco factory for repairs. If, solely in Runco's judgment, location of product to be repaired is beyond normal operating distance of the closest Runco Authorized Service Center, or the repair requires the unit be returned to the Runco factory, it is the owner's responsibility to arrange for shipment of the product for repair. These arrangements must be made through the selling Runco Dealer. If this is not possible, contact Runco directly for a Return Authorization number and shipping instructions. Runco will return product transportation prepaid in the United States, unless no product defect is discovered. In that instance, shipping costs will be the responsibility of the owner.

COPYRIGHT AND TRADEMARKS:

© Copyright 2006 Runco International. This document contains proprietary information protected by copyright. All rights are reserved. No part of this manual may be reproduced by any mechanical, electronic or other means, in any form, without prior written permission of the manufacturer.

All trademarks and registered trademarks are the property of their respective owners.

ADDITIONAL INFORMATION:

To locate the name and address of the nearest Runco Authorized Service Center, or for additional information about this Limited Warranty, please call or write:

RUNCO INTERNATIONAL, INC.
Attn: Customer Service Department
2900 Faber Street
Union City, CA 94587
Ph: (510) 324-7777
Fax: (510) 324-9300
Toll Free: (800) 23-RUNCO

RUNCO VIDEO-PRODUCT INFORMATION
RETAIN THIS INFORMATION FOR YOUR RECORDS

Model Purchased _____ Date _____

Serial Number _____

Runco Authorized Dealer Name _____

Address _____

City _____ State/Province _____ Postal Code _____

Phone _____ Fax _____

Safety Precautions

Thank you for your purchase of this quality Runco video projector! It has been designed to provide you with the quality of video that is expected in a home theater. For the best performance, please read this manual carefully as it is your guide through the menus and operation.

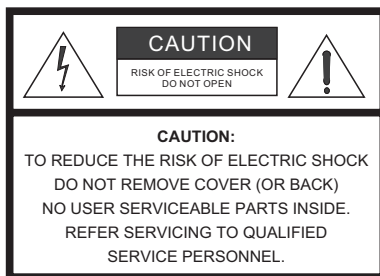

WARNING

This symbol is intended to alert the user to the presence of uninsulated “dangerous voltage” within the product’s enclosure that may be of sufficient magnitude to constitute a risk of electric shock.



This symbol is intended to alert the user to the presence of important operating and maintenance (servicing) instructions in the literature accompanying the appliance.

This equipment has been tested and found to comply with the limits for a Class B digital device, pursuant to Part 15 of the FCC Rules. These limits are designed to provide reasonable protection against harmful interference in a residential installation.

1. Read these instructions.
2. Keep these instructions.
3. Heed all warnings.
4. Do not use this equipment near water, outdoors or otherwise exposed to the elements.
5. Clean only with a dry cloth.
6. Do not block any ventilation openings.
7. Do not install near any heat sources such as radiators, heat registers, stoves, or other apparatus (including amplifiers) that produce heat.
8. Do not defeat the safety feature of the polarized or grounding type plug. A polarized type plug has two blades with one wider than the other. A grounding type plug has two blades and a third grounding prong. The third prong is provided for your safety. If the provided plug does not fit into your outlet, consult an electrician for the replacement of the obsolete outlet.
9. The 12V trigger only outputs DC 12V signal for triggering. Do not connect to any other power input or output. This could cause damage to this unit.
10. Only use accessories specified by Runco International.
11. Keep the packing material in case the equipment should ever need to be shipped.
12. Unplug this projector during lightning storms or when it will not be used for an extended period of time.
13. The lamp becomes extremely hot during operation. Allow the projector to cool down for approximately 45 minutes prior to removing the lamp assembly for replacement. Do not operate lamps beyond the rated lamp life. Excessive operation of lamps beyond rated life could cause them to explode in rare occasions.
14. Refer all servicing to qualified service personnel. Servicing is required when the projector has been damaged in any way, objects have fallen or spilled into the projector, the projector has been exposed to rain or moisture, does not operate normally, or has been dropped.

Table of Contents

TWO YEAR LIMITED WARRANTY	iii
Safety Precautions	vi
1. Introduction	1
About This Manual	1
Target Audience	1
If You Have Comments About This Manual.....	1
Textual and Graphic Conventions	1
Using This Manual	2
Related Documents	2
Description, Features and Benefits	3
Key Features and Benefits	4
Parts List	4
2. Controls and Functions	5
CL-810 at a Glance	5
CL-810 Rear Panel	7
CL-810 Remote Control	9
3. Installation	13
Remote Control	13
Notes on Batteries	13
Notes on Remote Control Operation.....	13
Quick Setup	14
Installation Considerations	15
Installation Type.....	15
Ambient Light	15
Throw Distance.....	16
Vertical and Horizontal Position.....	18
Vertical and Horizontal Lens Shift.....	18
Folded Optics	21
Other Considerations.....	21
Installing the Optional CineWide Lens	21

Mounting the CL-810	22
Floor Mounting.....	22
Ceiling Mounting	22
Adjusting the Projector Height or Projection Angle	22
Connections to the CL-810	23
Connector Panel Access.....	23
Connecting the SDC-1 System Expansion Device to the CL-810.....	23
Connecting Source Components to the CL-810	24
RS-232 Controller Connection	27
Connecting 12-Volt Trigger Output to External Theater Components.....	28
Connecting to AC Power	28
4. Operation	29
Turning on the Power	29
Changing the OSD Language	29
Adjusting the Picture Orientation	29
Lens Adjustments	30
Focus	30
Zoom.....	30
Vertical and Horizontal Lens Shift.....	30
Selecting Video Memory	30
Selecting an Aspect Ratio	30
Adjusting the Picture	30
Selecting An Input Source	31
Using Picture-In-Picture/Picture-By-Picture (PIP/PBP)	31
Using the On-Screen Menus	31
Main Menu.....	33
Picture Adjustment	33
Aspect Ratio	38
Installation.....	40
Option	41
Set Up.....	42
ISF Calibration	46
5. Maintenance and Troubleshooting	49
Lamp Replacement	49
Troubleshooting Tips	50

6. Serial Communications	53
RS-232 Connection and Port Configuration	53
Serial Command Syntax	53
7. Specifications	57
CL-810 Specifications	57
CL-810 Dimensions	60
CL-810 Ultra Dimensions	61

Notes:

List of Figures

2-1. CL-810 Front/Side/Top View	5
2-2. CL-810 Rear/Bottom/Side View	6
2-3. CL-810 Rear Panel.....	7
2-4. CL-810 Remote Control	9
3-1. Estimating Throw Distance	16
3-2. Projector Placement	18
3-3. Vertical Lens Shift.....	18
3-4. Horizontal Lens Shift.....	19
3-5. Folded Optics.....	21
3-6. Connecting the CL-810 to the SDC-1	23
3-7. HDMI/DVI Source Connections	24
3-8. RGB Connections	25
3-9. Progressive Component Video Connections.....	25
3-10. Composite, S-Video and Component Video Connections.....	26
3-11. RS-232 Control System Connection.....	27
3-12. Connecting 12-Volt Trigger Outputs	28
4-1. CL-810 OSD Menu Structure	32
4-2. Typical PLUGE Pattern for Adjusting Brightness	34
4-3. Typical Gray Bar Pattern for Adjusting Contrast	35
4-4. Typical Color Bar Pattern for Adjusting Color Saturation and Tint.....	35
4-5. Typical Test Pattern for Adjusting Sharpness	37
7-1. CL-810 Dimensions.....	60
7-2. CL-810 Ultra Dimensions	61

Notes:

Introduction

This Owner's Manual describes how to install, set up and operate the Runco CL-810 Series Digital Light Processing (DLP™) Projectors. This product family consists of the CL-810 and the CL-810 Ultra Projectors, each of which are available with a variety of optional upgrades.

Throughout this manual, the Runco CL-810 Series DLP Projectors are referred to collectively as the "CL-810." Except where noted, the features and functions described in this manual are common to all versions of this product.

Runco has prepared this manual to help home theater installers and end users get the most out of the CL-810.

Runco has made every effort to ensure that this manual is accurate as of the date it was printed. However, because of ongoing product improvements and customer feedback, it may require updating from time to time. You can always find the latest version of this and other Runco product manuals on-line, at www.runco.com.

Runco welcomes your comments about this manual. Send them to techpub@runco.com.

Text Conventions: The following conventions are used in this manual, in order to clarify the information and instructions provided:

- Remote and built-in keypad button identifiers are set in upper-case bold type; for example, "Press **EXIT** to return to the previous menu."
- All keys with functional names are initial-capped, set in bold type and enclosed in angle brackets. These keys are the following: **<Enter>**, **<Spacebar>**, **<Control>**, **<Esc>** and **<Tab>**.
- **<Enter>** indicates that you may press either the RETURN or ENTER key on your keyboard if it has both keys.
- Computer input (commands you type) and output (responses that appear on-screen) is shown in monospace (fixed-width) type; for example: "To change the aspect ratio to Letterbox, type x063x **<Enter>**."

In addition to these conventions, underlining, boldface and/or italics are occasionally used to highlight important information, as in this example:



Note

*A carriage return **must** be used after each command or string.*

1.1 About This Manual

◀ *Target Audience*

◀ *If You Have Comments About This Manual...*

◀ *Textual and Graphic Conventions*

Graphic Conventions: These symbols appear in numerous places throughout the manual, to emphasize points that you must keep in mind to avoid problems with your equipment or injury:

TIPS highlight time-saving short cuts and helpful guidelines for using certain features.

NOTES emphasize text with unusual importance or special significance. They also provide supplemental information.

CAUTIONS alert users that a given action or omitted action can degrade performance or cause a malfunction.

WARNINGS appear when a given action or omitted action can result in damage to the equipment, or possible non-fatal injury to the user.

DANGER appears when a given action can cause severe injury or death.

1.2 Using This Manual

Use the following table to locate the specific information you need in this manual.

1.3 Related Documents

The following are related Runco documents:

- Runco SDC-1 System Expansion Device Owner's Operating Manual

The CL-810 Series DLP Projectors offer the astounding picture quality and versatility heretofore associated with more expensive projectors. Their 1280 x 720 native resolution DLP light engine features Runco's powerful SuperOnyx™ technology for bright, pristine high-definition images.

Contrast ratio and dynamic range extend to new heights with Runco's exclusive Reflectance Volume Regulation™ (RVR), an electronically-controlled iris system.

The CL-810 is equipped with a precision optics package offering a power zoom control and a throw range of 1.80:1 to 2.43:1. The CL-810 Ultra provides even greater installation flexibility, with six lens options from which to choose offering throw distances ranging from 1.22:1 to 5.68:1. For rear-projection applications, a fixed, short-throw lens is also available with the CL-810 Ultra.

The CL-810's illumination system incorporates Runco's exclusive Selectable Lamp Intensity Control™ (SLIC™), which provides two light intensity levels to allow maximum flexibility for screen size, ambient light conditions, brightness and contrast balance, and lamp life preservation. It also has a newly refined cooling system, which increases efficiency and reduces noise levels.

The CL-810 has been engineered to comply with Imaging Science Foundation™ (ISF) standards for maximum home theater image quality. Runco's sophisticated parameters for white balance and color gamut control have also been implemented for precise balance of gray scale and color. The CL-810 incorporates Runco-proprietary de-interlacing technology that provides exceptional scaling and film-to-video (3:2 pulldown) conversion for the most artifact-free images possible.

For uncompromising widescreen reproduction of movies originally filmed in the "scope" (2.35:1) format, the CL-810 can be equipped with Runco's CineWide™ technology, a combination of software, electronics and high-quality anamorphic optics. CineWide maintains constant vertical height on the screen just as in a movie theater. When a viewer transitions from 1.78:1 (16:9) program material to 2.35:1, the image simply gets wider while full height is maintained. Also available with the CL-810 Ultra is CineWide with AutoScope™, an enhanced, remote-controlled motorized version of CineWide.

The CL-810 is available with or without the SDC-1, a versatile, high-performance digital video switcher. By providing a single, convenient connection point for home theater components that is separate from the projector, the SDC-1 gives designers and installers greater flexibility in terms of projector placement. It also simplifies the task of adding components after the projector has been installed.

Discrete IR and RS-232 control make custom installation seamless, while discrete source and aspect ratio selection accommodate any automation control system.

1.4 Description, Features and Benefits

- Key Features and Benefits** ➤ The CL-810 offers these key features and benefits:
- Native Resolution: 1280 x 720 (16:9 Native Aspect Ratio)
 - DLP system using SuperOnyx™ Digital Micromirror Device (DMD)
 - 8-segment, 5x color wheel produces wide dynamic range and rich grayscale
 - Reflectance Volume Regulation (RVR™) provides for infinitely variable adjustment of the light path through the optics, enabling the perfect balance of black and white levels for each individual installation
 - Picture in Picture / Picture by Picture functions allow you to display two inputs on the screen at the same time
 - HDMI Input with High-bandwidth Digital Content Protection (HDCP)
 - HDTV Compatible
 - CinOptx™ Proteus lens options for stunning sharpness and throw distance flexibility (CL-810 Ultra only)

- Parts List** ➤ Your CL-810 is shipped with the following items. If any items are missing or damaged, please contact your Runco dealer or Runco Customer Service at (800) 23-RUNCO.
- CL-810 or CL-810 Ultra DLP Projector
 - Remote Control Unit and two (2), AAA-size batteries
 - AC Power Cords (North America, Europe, Asia)
 - Source Connection Cables:
 - Composite Video
 - S-Video
 - Component Video
 - RGB (DB15HD-to-5 x BNC)
 - HDMI to HDMI
 - HDMI to DVI
 - (1) Warranty information and registration card
 - Runco CL-810 Series Owner's Operating Manual (this document)

Optional Accessories - CL-810 and CL-810 Ultra:

- CineWide™ technology (fixed, secondary anamorphic lens)
- SDC-1 System Expansion Device
- Ceiling mount kit

Optional Accessories - CL-810 Ultra Only:

- CinOptx™ Proteus lens options
- CineWide™ with AutoScope™ system (secondary anamorphic lens and motorized mount)

2. Controls and Functions

Figure 2-1 and Figure 2-2 show the key CL-810 components.

2.1 CL-810 at a Glance

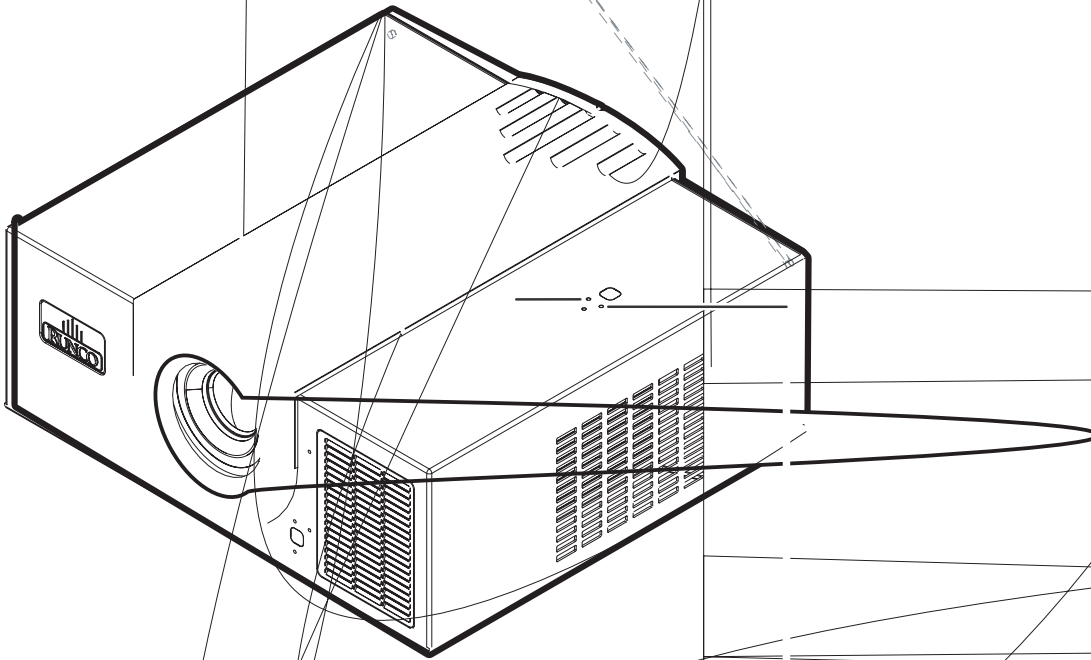

Figure 2-1. CL-810 Front/Side/Top View

- 1. RUNCO LOGO**
The logo can be rotated to match the projector orientation: inverted (ceiling-mounted) or upright. To rotate the logo, grip it at its sides, pull away from the projector and rotate it 180 degrees.
- 2. PROJECTION LENS**
- 3. TOP IR SENSOR**
- 4. TEMP LED**
Indicates fan status as follows:
 - Off during normal operation
 - Red when internal temperature is too high
 - Flashes red when the fans are not working or the lamp cover is open
- 5. INTAKE VENT**

6. **POWER/STANDBY LED**

Indicates power status as follows:

- Orange when the projector is in standby mode
- Flashes orange for 45 seconds after the projector is turned on to indicate that the lamp is warming up
- Green during normal operation
- Flashes green for 110 seconds after the projector is turned off to indicate that the lamp is cooling down

7. **LAMP LED**

Indicates lamp status as follows:

- Off during normal operation
- Red when the lamp has exceeded its usage life or developed a problem.
- Flashes red when the fans are not working or the lamp cover is open

8. **EXHAUST VENT**

9. **FRONT IR SENSOR**

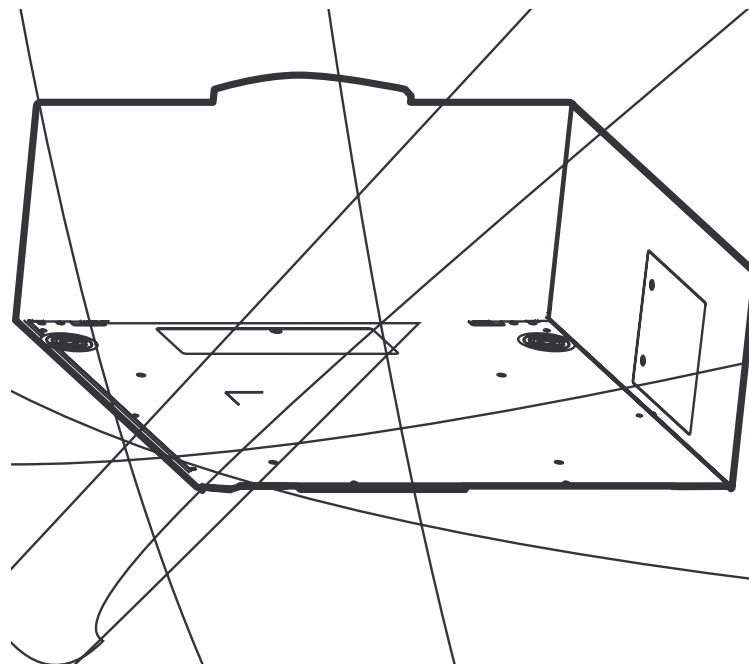

Figure 2-2. CL-810 Rear/Bottom/Side View

1. **RUNCO LOGO**

The logo can be rotated to match the projector orientation: inverted (ceiling-mounted) or upright. To rotate the logo, grip it at the sides, pull it away from the projector and rotate it 180 degrees.

2. **CABLE OPENING**

Pass cables through this opening.

3. **CABLE ACCESS DOOR**

Open to access connectors.

2 3 4 5 6 7

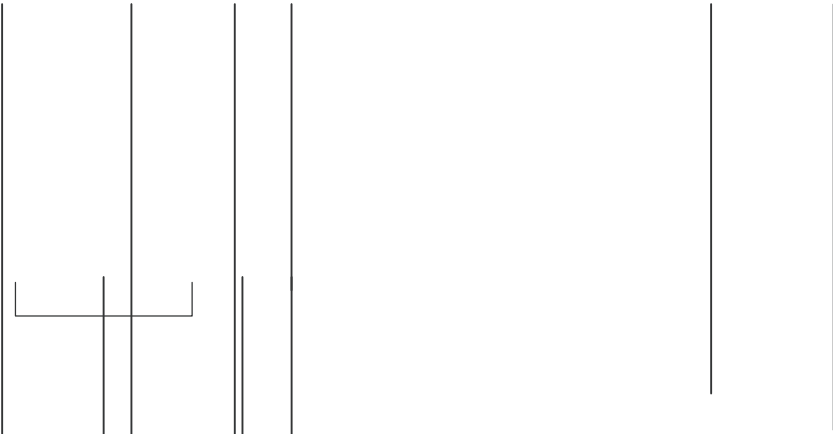

Note

Connect ONLY an SDC-1 to the R-Link input! Although the R-Link looks like a DVI input, it does not function like one and should not be used as an additional video input.

3. **COMP 1 (RCA connectors)**

Standard Definition (480i/576i) Component (YPrPb) input. This is the input for component video from sources such as DVD players.



Tip

For best results, do not run your DVD player in progressive mode.

4. **COMPOSITE VIDEO INPUT**

Standard composite video input for connecting a VCR, laser disc player or other composite video source.

5. **S-VIDEO**

A standard S-Video input for connecting a DVD player, satellite receiver or Super VHS (S-VHS) VCR.

6. **POWER INPUT (100 to 240 VAC)**

Connect the CL-810 to power here.

7. **MAIN POWER SWITCH**

Disconnects or applies power to the CL-810.

8. **RS-232 CONTROL PORT**

A female, RJ-11 connector for interfacing with a PC or home theater automation/control system.

9. **12-VOLT (250 mA) TRIGGER OUTPUT(3.5-mm, mini phono jack)**

Connection for a 12-volt trigger-controlled device. This can be a retractable screen, screen mask or the Runco CineWide with AutoScope system.

10. **COMP 2 / RGB**

Five, BNC connectors for connecting either RGB or component (YPbPr) high-definition television signals. (The CL-810 automatically detects the signal format.)

Figure 2-4 shows the CL-810 remote control, and the paragraphs that follow describe its functionality.

2.3 CL-810 Remote Control

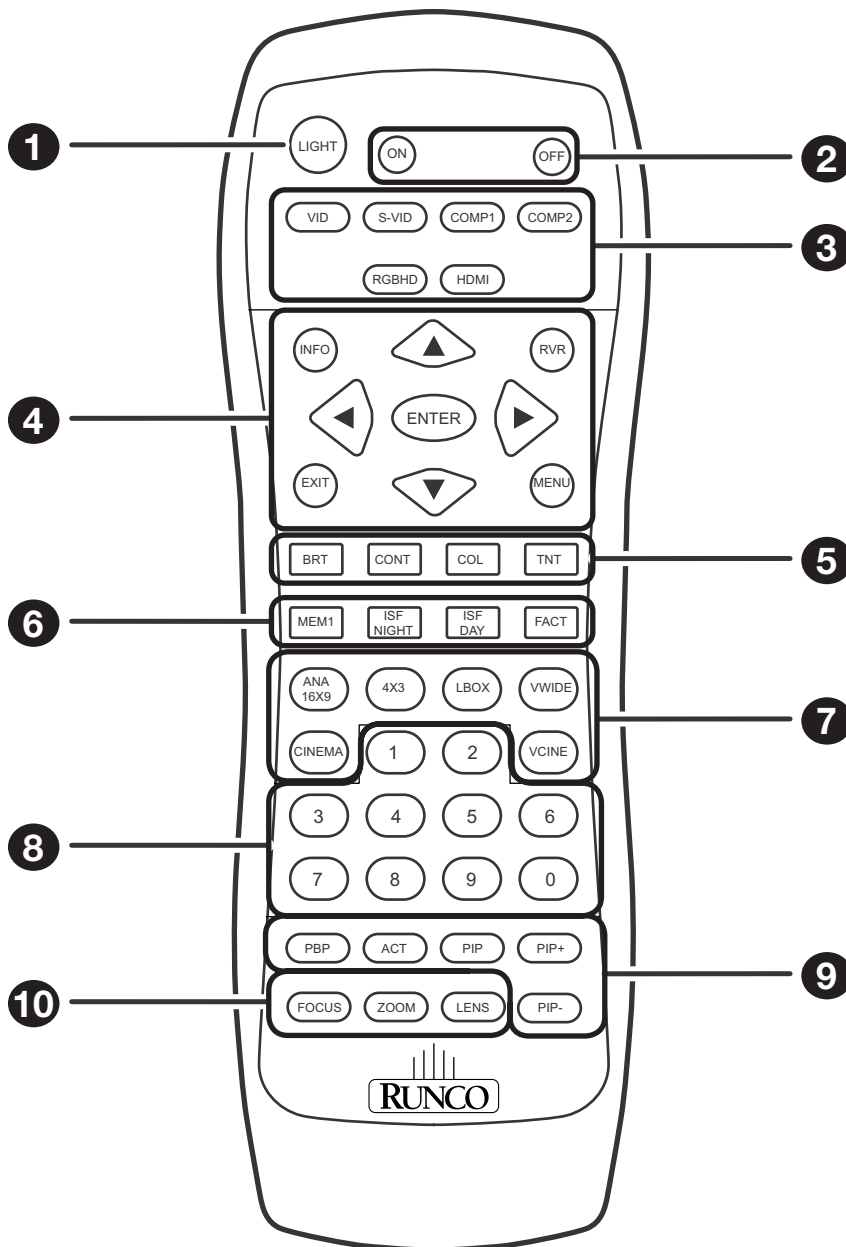

Figure 2-4. CL-810 Remote Control

1. **LIGHT**

Press to illuminate the buttons.

2. **ON / OFF**

Use these buttons to turn the projector on or off.

3. **Source Selection Buttons:**

VID

Press to select Composite video input as the source.

S-VID (S-Video)

Press to select the S-Video input as the source.

COMP1 (SD Component)

Press to select Component 1 (SD 480i/576i) video input as the source.

COMP2 (HD Component)

Press to select Component 2 (HD 480p/576p/720p/1080i) video input as the source.

RGBHD

Press to select the Component 2 RGB input.

HDMI

Press to select the HDMI input.

4. **INFO**

Displays active source and aspect ratio information.

Cursor Keys (▲, ◀, ▼, ▶)

Use these buttons to select items or settings, adjust settings or switch display patterns.

RVR (Reflectance Volume Regulation)

Adjusts the lens aperture (iris) setting according to the ambient light level in the viewing area.

EXIT

Press to save menu item setting(s), exit the current menu and return to the previous one.

ENTER

Press to select a highlighted menu item or confirm a changed setting.

MENU

Press this button to show or hide the on-screen display (OSD) controls.

5. Picture Adjustment Buttons:**BRT (Brightness)**

Press to adjust black level.

CONT (Contrast)

Press to adjust white level.

COL (Color)

Press to adjust color intensity.

TNT (Tint)

Press to adjust color hues.

6. Memory Preset Buttons:**MEM1**

Press to recall settings for the current input from the "Memory 1" memory preset.

ISF NIGHT

Press to recall settings for the current input from the "ISF Night" memory preset.

ISF DAY

Press to recall settings for the current input from the "ISF Day" memory preset.

FACT

Press to recall the factory-default settings for the current input.

7. Aspect Ratio Selection Buttons

Use these buttons to select an aspect ratio directly, as follows:

ANA 16:9 (Anamorphic)

For viewing 16:9 DVDs or HDTV programs in their native aspect ratio.

4X3 (Standard 4:3)

Scales the input signal to fit 4:3 display mode in the center of the screen.

LBOX (Letterbox)

For viewing LaserDisc movies or non-anamorphic DVDs on a 4:3 screen.

VWIDE (VirtualWide)

Enlarges a 4:3 image horizontally in a NON-linear fashion to fit 16:9 full screen display.

CINEMA

For viewing 2.35:1 source material on a 1.78:1 (16:9) screen. The upper and lower portions are masked.

VCINE (CineWide-equipped projectors only)

Selects the Virtual Cinema aspect ratio, which anamorphically compresses a 2.35:1 image to fill a 16:9 image area. (The secondary anamorphic lens then "stretches" the image back to 2.35:1.)

8. 0 - 9

Use these keys to enter menu passcodes.

9. **Picture-In-Picture (PIP) / Picture-By-Picture (PBP) Controls:**



Note

PIP and PBP are not available when the CL-810 is used with the SDC-1 System Expansion Device.

PBP

Press to activate PBP mode.

ACT

Press to switch to the active window in PIP or PBP mode.

PIP

Press to activate PIP mode.

PIP+

Press to enlarge the PIP window.

PIP-

Press to shrink the size of the PIP window.

10. **Motorized Lens Controls:**

FOCUS

Press to focus the image.

ZOOM

Press to reduce or enlarge the projected image size.

LENS

Press to access the lens shift controls.

Installation

To install batteries in the remote control, push the battery cover and slide it off. Install the two AAA batteries with the correct polarity and then replace the cover.

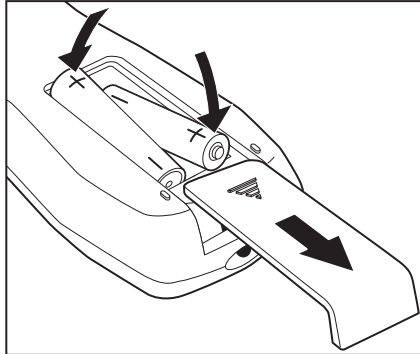

3.1 Remote Control

- Make sure that the battery polarities are correct when installing the batteries.
- Do not mix an old battery with a new one or different types of batteries.
- If you will not use the remote control for a long time, remove the batteries to avoid damage from battery leakage.
- Make sure that there is nothing obstructing the infrared beam between the remote control and the IR receiver on the projector.
- If the effective range of the remote control decreases, or it stops working, replace the batteries with new ones.
- The remote control may fail to operate if the infrared remote sensor is exposed to bright sunlight or fluorescent lighting.
- Ambient conditions may possibly impede the operation of the remote control. If this happens, point the remote control at the projector, and repeat the operation.
- The Ø icon appears on the screen when you press a button for an unavailable function.

◀ *Notes on Batteries*

◀ *Notes on Remote Control Operation*

		...s, Refer to page...
		21
		22
	DC-1 ions to the	24
	ct signal sources to	
	S-232 port (optional)	27
	er components to 12-volt trigger	28
	projector	28, 29
	SD Language (optional)	29
	screen and/or ceiling-mount installations, select per picture orientation	29
	ens adjustments: projected image size (zoom), position (shift) and focus	18, 30
11	Projector calibration: adjust the following for each input , starting with Component 1; save settings when finished: <ul style="list-style-type: none"> • Aspect ratio • Brightness • Contrast • Color level • Tint • Input position 	38 through 43

Proper installation of your projector will ensure the quality of your display. Whether you are installing a projector temporarily or permanently, you should take the following into account to ensure your projector performs optimally.

Choose the installation type that best suits your needs: front or rear screen, floor mount or inverted mount. Table 3-2 compares these various installation methods.

Table 3-2. Projector Installation Options

Advantages	Considerations
Front Screen, Floor Mount Installation	
<ul style="list-style-type: none"> • Easy to set up • Can be moved or changed quickly • Easy to access 	<ul style="list-style-type: none"> • Shares floor space with audience
Front Screen, Inverted Mount (ceiling) Installation	
<ul style="list-style-type: none"> • Does not take up audience space • Projector is unobtrusive • Projector cannot be accidentally moved 	<ul style="list-style-type: none"> • Installation is more permanent • Projector access is more difficult
Rear Screen, Floor Mount Installation	
<ul style="list-style-type: none"> • Projector is completely hidden • Projector is easily accessed • Usually good ambient light rejection 	<ul style="list-style-type: none"> • Requires separate room • Installation cost is usually higher
Rear Screen, Inverted Mount (ceiling) Installation	
<ul style="list-style-type: none"> • Projector is completely hidden • Usually good ambient light rejection 	<ul style="list-style-type: none"> • Requires separate room • Installation cost is usually higher
Rear Screen, Floor Mount with Mirror	
<ul style="list-style-type: none"> • Projector is completely hidden • Usually good ambient light rejection • Requires less space behind screen than other rear screen installations 	<ul style="list-style-type: none"> • Requires separate room • Installation cost is usually higher

In general, minimize or eliminate light sources directed at the screen. Contrast ratio in your images will be noticeably reduced if light directly strikes the screen, such as when a shaft of light from a window or floodlight falls on the image. Images may then appear washed out and less vibrant.

3.3 Installation Considerations

◀ Installation Type

◀ Ambient Light

Throw Distance ➤ Throw distance is the distance measured from the front of the projector to the screen. This is an important calculation in any projector installation as it determines whether or not you have enough room to install your projector with a desired screen size and if your image will be the right size for your screen.

You can quickly estimate the throw distance by taking the width of the screen and multiplying it by the lens throw ratio; see Figure 3-1. The result of this calculation tells you roughly how far back the projector should be positioned from the screen in order to project a focused image large enough to fill the screen.

Estimating Throw Distance

$$\text{Throw Distance (TD)} = \text{Screen Width (w)} \times \text{Lens Throw Ratio}$$

CL-810 Throw Ratio: 1.80 to 2.43

CL-810 Ultra Throw Ratio: refer to Table 3-3

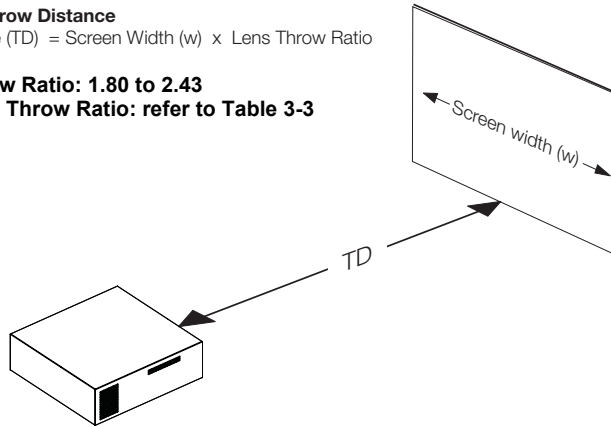

Figure 3-1. Estimating Throw Distance

Throw Ratio - CL-810 Ultra: Table 3-3 lists the available lens options for the CL-810 Ultra and their associated throw ratios.

Table 3-3. CL-810 Ultra Lens Options

Lens Option (Note 2)	Throw Ratio (Throw Dist. ÷ Screen Width)	Throw Distance Range (in inches, with 100-inch Wide Screen)	
		Minimum	Maximum
Proteus A	0.67 (Fixed)	For rear-screen installations only. Contact Runco Technical Support for more information.	
Proteus B	1.22 - 1.44	122	144
Proteus C	1.45 - 1.75	145	175
Proteus D	1.82 - 2.38	182	238
Proteus D with CineWide	1.38 - 1.79	138	179
Proteus E	2.42 - 3.57	242	357
Proteus E with CineWide	1.84 - 2.70	184	270
Proteus F	3.65 - 5.68	365	568
Proteus F with CineWide	2.77 - 4.29	277	429

Notes:

1. Throw distance does not affect image quality, provided these ranges are taken into account.
2. Only the Proteus D, E and F lenses can be used with the optional CineWide (secondary anamorphic) lens. Doing so affects the throw distances as shown here.

Throw Ratio - CL-810: The CL-810 offers a throw ratio of between 1.80 and 2.43.

Throw Ratio - CL-810 CineWide: The CineWide version of the CL-810 also offers a throw ratio of between 1.80 and 2.43. It uses a prismatic-style anamorphic lens that compresses the image height (as opposed to the cylindrical anamorphic lenses used with the CL-810 Ultra, which stretch the image width). Using this lens type does not change the projector throw ratio.

Vertical and Horizontal Position

Proper placement of the projector relative to the screen will yield a rectangular, perfectly-centered image that completely fills the screen.

Ideally, the projector should be positioned perpendicular to the screen and in such a way that the lens center and screen center are aligned with each other, as shown in Figure 3-2.

Ceiling Installation

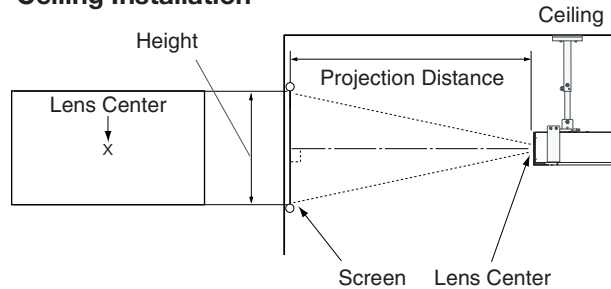

Floor Installation

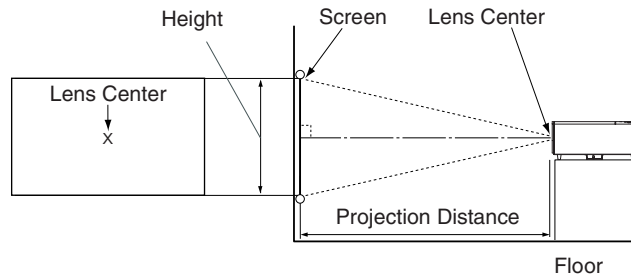
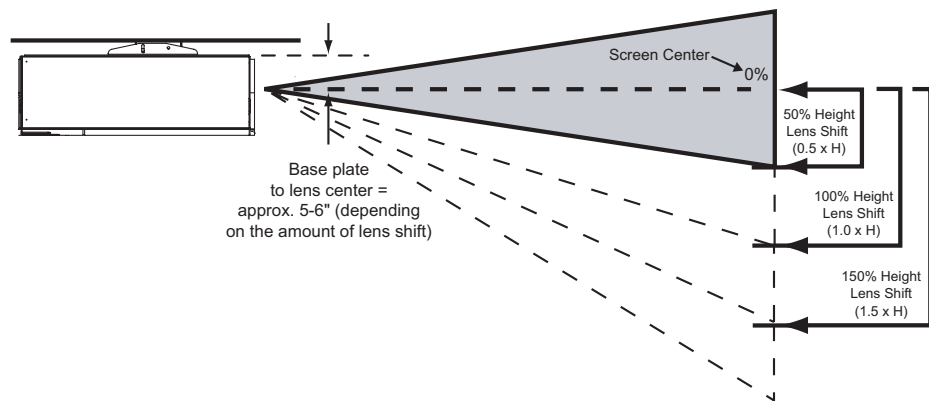

Figure 3-2. Projector Placement

Vertical and Horizontal Lens Shift

If it is not possible to align the projector and screen as shown in Figure 3-2, you can use the lens shift (LENS) controls on the projector remote to center the image on the screen. Lens shift is generally expressed as a percentage of the screen height or width, as shown in Figure 3-3 and Figure 3-4.



Note: This is a general example of lens shift. Lenses vary in their shift capabilities. No particular lens is used in this example.

Figure 3-3. Vertical Lens Shift

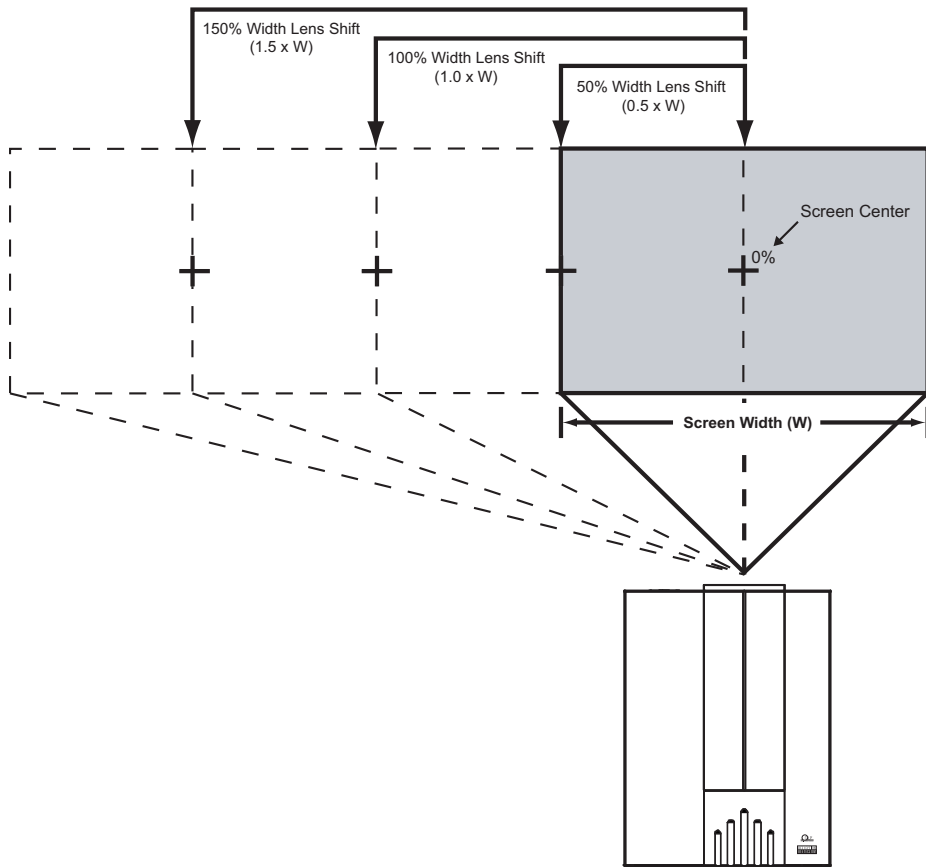

Note: This is a general example of lens shift. Lenses vary in their shift capabilities. No particular lens is used in this example.

Figure 3-4. Horizontal Lens Shift

Table 3-4 lists the lens shift limits for each available CL-810 lens, as percentages and absolute measurements with a 100 x 56 inch (1.78:1) screen.

Table 3-4. Vertical and Horizontal Lens Shift Limits

		Lens Option						
		CL-810	CL-810 Ultra					
		--	Proteus A	Proteus B	Proteus C	Proteus D	Proteus E	Proteus F
Lens Shift Limits, as Percentages of Screen Height or Width (Notes 1 and 2)								
Vertical (Note 2)	Up	50%	2%	11%	10%	13%	14%	20%
	Down	50%	2%	72%	70%	70%	71%	63%
Horizontal (Note 2)	Left	0%	0%	13%				
	Right	0%	0%	13%				
Lens Shift Limits in Inches, with a 100-by-56 inch (1.78:1) Screen								
Vertical	Up	28.00	1.12	6.16	5.60	7.28	7.84	11.20
	Down	28.00	1.12	40.32	39.20	39.20	39.76	35.28
Horizontal	Left	0	0	13.00				
	Right	0	0	13.00				
<p>Notes:</p> <ol style="list-style-type: none"> 1. With no vertical or horizontal lens shift, the lens center and screen center are aligned with each other. 2. Vertical shift limits are percentages of the screen height. Horizontal shift limits are percentages of the screen width. 3. Vertical lens shift figures apply to ceiling mount configurations. For floor installations (where the projector is upright), reverse the up/down vertical offset percentages. 								



3.5 Mounting the CL-810

There are several methods for mounting the projector. Depending on your chosen installation, one method may be more suitable than another.

Floor Mounting ➤ In typical front and rear screen installations, the projector can be mounted to a secure and level surface such as a table or cart. Carts are useful when moving a projector during a presentation or from site to site. If possible, lock the wheels when it's in position to prevent it from being moved during a presentation.

Ceiling Mounting ➤ The projector can also be inverted and suspended from the ceiling using a specially-designed ceiling mount fixture. This type of mounting is recommended for fixed installations and for those that want the projector out of sight or have a limited space for projector and audience.



Note

Use only the Runco-approved ceiling mount kit designed for your projector. Install the mount kit according to the instructions provided with it.

Adjusting the Projector Height or Projection Angle ➤

If the screen is significantly higher or lower than the projector, you can also tilt the projector at a slight angle. In a ceiling installation, you do this by adjusting the ceiling mount.

For a floor installation, turn the four adjustable feet on the bottom of the projector to adjust the projector height and/or projection angle.

If you do this, you may need to make keystone adjustments or vertically shift the image using the on-screen display (OSD) controls, to compensate. For detailed instructions, refer to **Using the On-Screen Menus** on page 31.

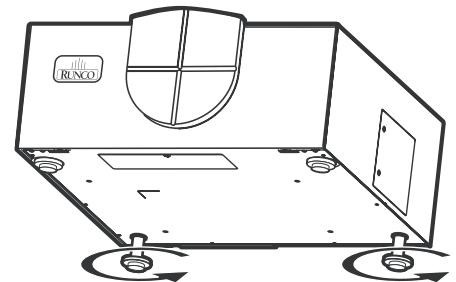

Proceed as follows to connect the CL-810 to the SDC-1 controller(s) -- if present -- and AC power.

When connecting your equipment:

- Turn off all equipment before making any connections.
- Use the correct signal cables for each connection.
- Ensure that the cables are securely connected to the connectors that have them.

To access the connector panel, pull the cover off the front of the projector firmly on the cable access cover to open it.

If (and ONLY if) your installation includes the SDC-1 Expansion Device

Use a Runco R-Link cable to connect the SDC-1 to the CL-810. See Figure 3-6.

All signal sources should then be connected to the SDC-1. The signal from the SDC-1 is sent to the CL-810 via the R-Link cable. For detailed instructions, refer to the SDC-1 Expansion Device manual.

3.6 Connections to the CL-810

Connector Panel Access

Connections to the SDC-1 Expansion Device



Note

Connect ONLY an R-Link cable to the R-LINK IN connector. An R-Link looks like a DVI-D connector and cannot be used as a video input.

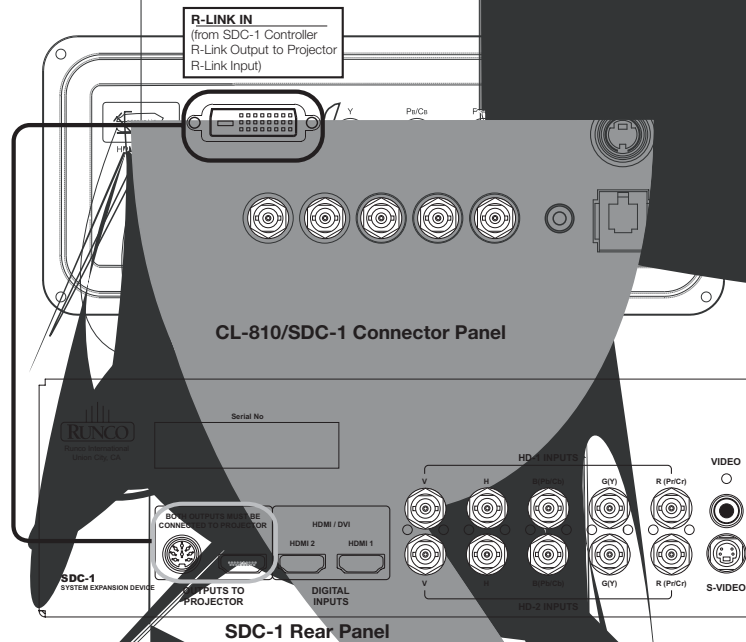

Figure 3-6. Connecting the SDC-1 Expansion Device to the CL-810

Connecting Source Components to the CL-810 ➤

If your installation does not include an SDC-1: Connect your video sources to the CL-810 as shown and described in the sections that follow.

HDMI/DVI Connections: See Figure 3-7. With an HDMI source, use the included HDMI-to-HDMI cable; with a DVI source, use the included DVI-to-HDMI cable.



Tip

Use the HDMI input whenever possible. This ensures the highest video quality because the signal is carried in the digital domain throughout the entire signal path, from source component output into the projector.

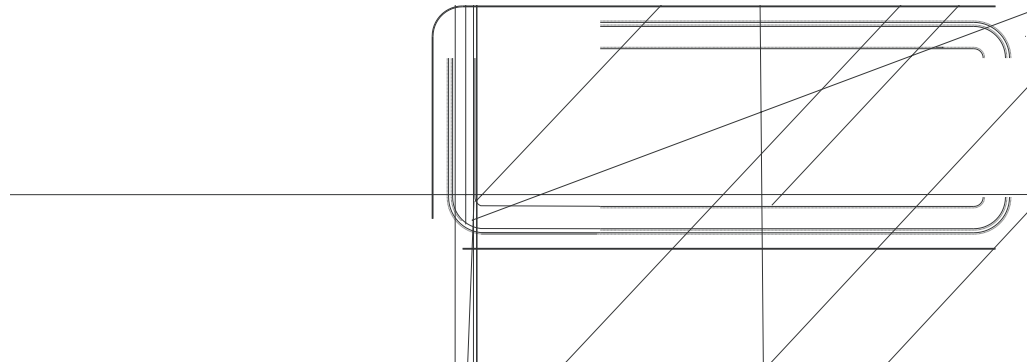

Figure 3-7. HDMI/DVI Source Connections

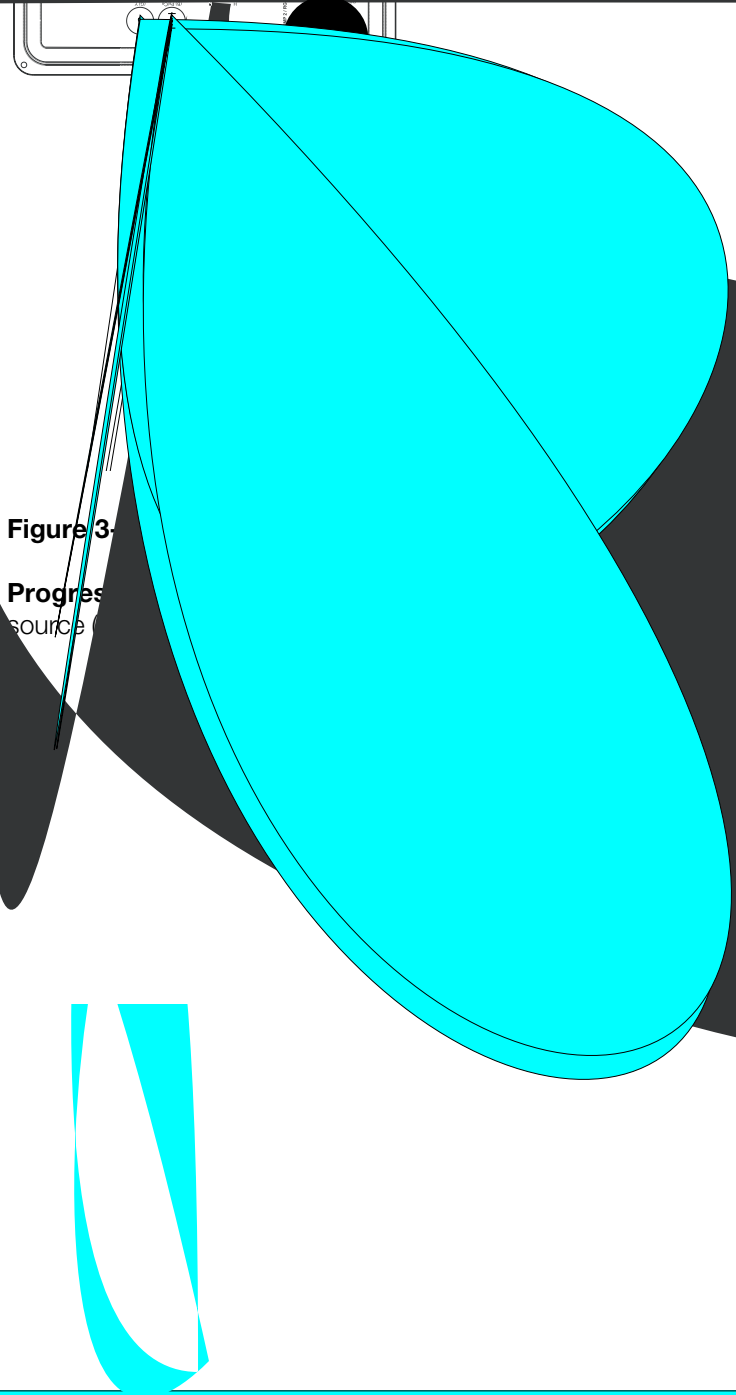

Figure 3-9.
Progressive
source (

Figure 3-9. Progressive Component Video Connections

Connect a PC or home theater control/automation system (if present) to the RS-232 port on the CL-810; see Figure 3-11. Use a standard, 4-wire RJ-11 telephone cable, wired straight-through.

◀ **RS-232 Controller Connection**

For more information about using this connection, refer to **Serial Communications** on page 53.

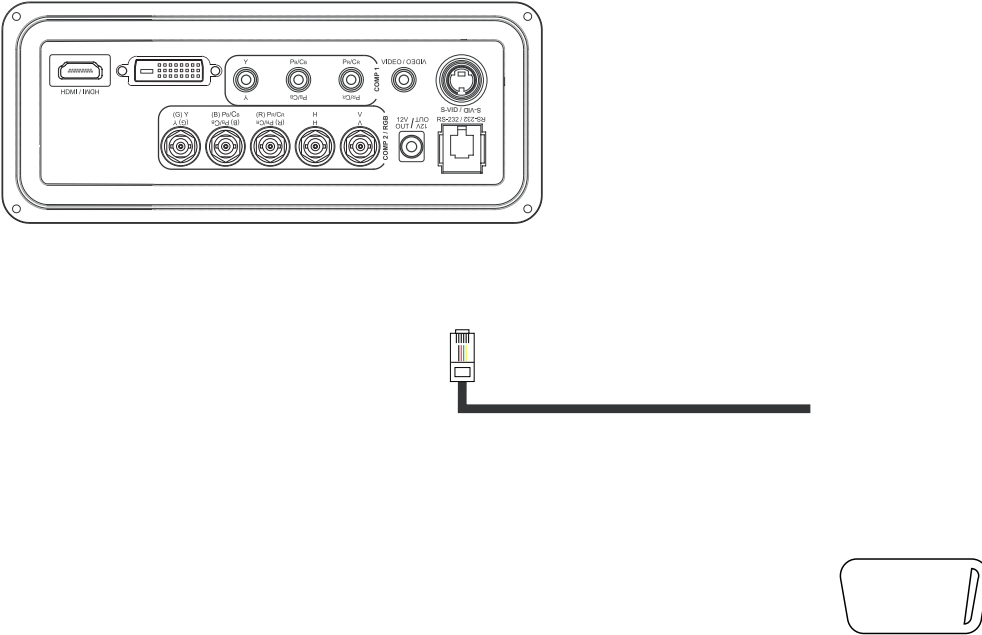

Figure 3-11. RS-232 Control System Connection

Connecting 12-Volt Trigger Output to External Theater Components

If your CL-810 is equipped with a CineWide with AutoScope system, or if your home theater contains other devices that respond to 12-volt triggers (such as a retractable screen or screen mask), connect it to the 12-volt trigger output as shown in Figure 3-12.

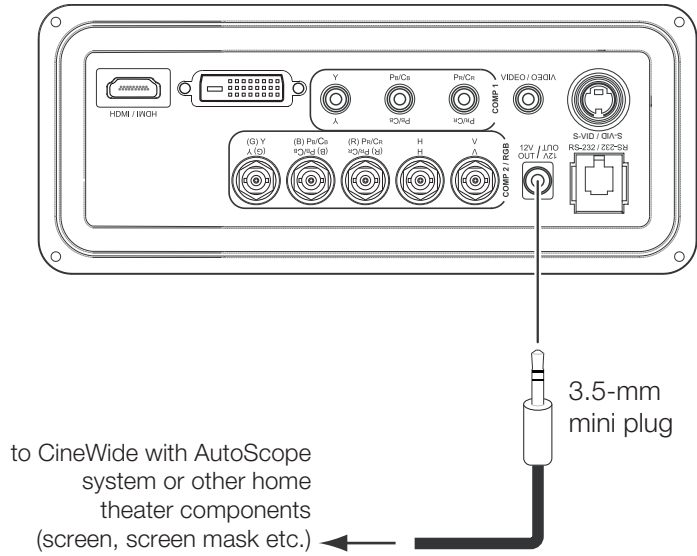
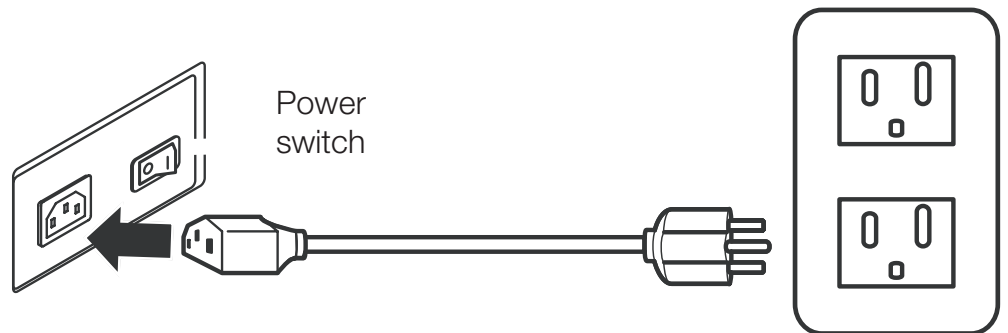

Figure 3-12. Connecting 12-Volt Trigger Outputs

Connecting to AC Power

The CL-810 ships with various types of AC power cords. Choose the one that is appropriate to your locale.

Plug the female end of the power cord into the AC receptacle on the rear of the projector (AC 100V ~ 240V). Then, connect the other end to your AC power source.



Operation

1. Turn on your source components.
2. Turn on the main power switch at the rear of the projector. The POWER LED lights orange. The LAMP and TEMP LEDs light red briefly, then go out.
3. Press the **ON** button on the remote control to turn on the CL-810. The POWER LED flashes orange to indicate that it is warming up.
4. When the projector is ready for use, the POWER LED lights green.
5. "Searching..." appears on the screen before the CL-810 identifies the input signal and remains there until a valid signal is detected.
6. If an incompatible input signal exceeds the range of the projector, a "No signal supported" message appears on the screen. This message remains on the screen until you change the input signal.

The CL-810 OSD language is initially set to English, but can also display the menus in French, Spanish, Italian or German. To change the OSD language:

1. Press **MENU**.
2. Select Installation from the Main Menu and press **ENTER**.
3. Select Language from the Installation Menu and press **ENTER**.
4. Press **▲** or **▼** to highlight the desired language. (The change takes effect immediately.)

By default, the CL-810 is configured for a "floor/front" installation, in which the projector is installed upright and in front of the screen. If it is installed behind the screen and/or mounted on a ceiling, you must change the picture orientation. To do this:

1. Press **MENU** on the remote control.
2. Select Installation from the Main Menu and press **ENTER**.
3. Select Picture Orientation from the Installation Menu and press **ENTER**.
4. Choose Floor Rear, Ceiling Front or Ceiling Rear to match the installation method.

4.1

Turning on the Power

4.2

Changing the OSD Language

4.3

Adjusting the Picture Orientation

4.4 Lens Adjustments

The CL-810 gives you a great deal of control over the picture size, position and focus. To access the motorized lens controls, use the **FOCUS**, **ZOOM** and **LENS** buttons on the remote control.

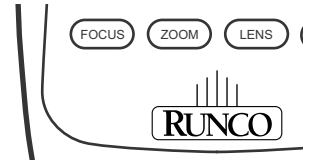

- Focus** ➤ To focus the projected image, press the **FOCUS** button, then use the left- and right-arrow buttons to adjust the focus.
- Zoom** ➤ To make the picture smaller (zoom out), press the **ZOOM** button, then use the left-arrow (◀) button.
To enlarge the picture (zoom in), press the **ZOOM** button, then use the right-arrow (▶) button.

Vertical and Horizontal Lens Shift ➤ **Vertical Lens Shift:** To shift the projected image vertically, press the **LENS** button, then use the up and/or down-arrow (▲, ▼) buttons.

Horizontal Lens Shift (CL-810 Ultra Only): To shift the projected image horizontally, press the **LENS** button, then use the right and/or left-arrow buttons.

4.5 Selecting Video Memory

- Press the **MEM1** button on the remote control to recall settings for the current input from the “Memory 1” memory preset.
- Press **ISF NIGHT** to recall settings for the current input from the “ISF Night” memory preset.
- Press **ISF DAY** to recall settings for the current input from the “ISF Day” memory preset.
- Press **FACT** to recall the factory-default settings for the current input.



4.6 Selecting an Aspect Ratio

Use these buttons to select the appropriate aspect ratio for the type of program material being viewed. For more information on aspect ratios, refer to Table 4-1.

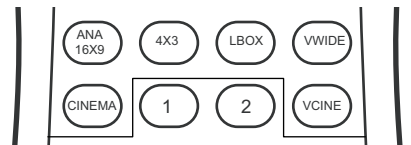

4.7 Adjusting the Picture

- Press the **BRT** button on the remote control to adjust the image brightness.
- Press **CONT** to adjust the image contrast.
- Press **COL** to adjust the image color level.
- Press **TNT** to adjust the hue of the image.



For more information about these controls, refer to **Picture Adjustment** on page 33.

When you turn on the CL-810, it switches to the last selected input and looks for a valid signal.

Use these buttons on the remote control to select an input source directly.

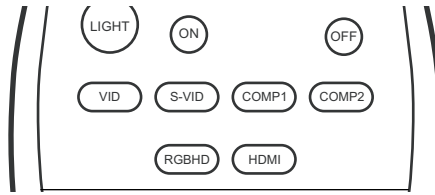

4.8 Selecting An Input Source



Note

PIP and PBP are not available when the CL-810 is used with the SDC-1 System Expansion Device.

For PIP and PBP purposes, there are two groups of inputs separated by their display modes:

- **Video (SD) group:** Video, S-Video and Component 1 inputs.
- **Graphic (HD) group:** HDMI and Component 2/RGB inputs.

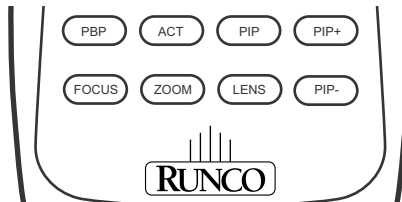

4.9 Using Picture-In-Picture/ Picture-By-Picture (PIP/PBP)

PIP / PBP shows one input from the Graphic group within or beside one input from the Video group.

- Press **PBP** to enable the PBP function. Press **PBP** again to switch the screens left to right. Press **PBP** again to turn PBP off.
- Press **ACT** (Active) to switch to the active window. (You can only switch inputs in the active window.)
- Press **PIP** to enable the PIP function. Press **PIP** again to switch the main window. Press **PIP** again to turn PIP off.
- To adjust the size of the PIP window, press **PIP+** or **PIP-**.
- Adjust the position of the PIP window with the arrow buttons (▲, ◀, ▼, ▶).

- Press the **MENU** button on the remote control to display the Main Menu. To select a menu item, use the UP and DOWN buttons on the remote control to highlight it. Press **ENTER** or ▶ to confirm your selection.
- Use the arrow buttons to select menu items or change settings.
- Press **EXIT** to return to the previous menu.
- Press **MENU** to turn off the OSD menu. (When the Main Menu is displayed, pressing **EXIT** also turns off the menu.)

The CL-810 OSD menus are arranged hierarchically, as shown in Figure 4-1. Depending on the selected input source and signal characteristics, some menu options may not be available.

4.10 Using the On-Screen Menus

Video S-Video Component1 Component2 RGB-HD HDMI	Brightness	0 ... 60	Option	Reset Image Settings	Yes / No	
	Contrast	0 ... 32		Sleep Timer	0, 10, 20, 30 ... 180 minutes	
	Color	0 ... 64		Lamp Hours	(read only)	
	Tint	0 ... 30		OSD Timer	0, 3, 6, 9 ... 60 seconds	
	Sharpness	-14 ... 0 ... +20		OSD Position	Horizontal	
	Filter	0, 1, 2 or 3			Vertical	
	Color Temperature	0, 1 (5400 K), 2 (6500K), 3 (8500 K), 4 or 5 (Custom)		PC & HD Adjust (480p and higher-res. signals only)	Auto	
	ICC Selection	Standard, NTSC, HDTV or PAL			Frequency	0, +1, +2, +3 ... +17
	Store Image Settings	Memory 1			Phase	0, +1, +2, +3 ... +31
	Restore Image Settings	Memory 1, ISF Night or ISF Day			H. Position	-30, -29 ... 0 ... +29, +30
Aspect Ratio	Anamorphic (16:9)			V. Position	-28, -27 ... 0 ... +29, +30	
	Standard (4:3)		PIP/PBP Set Up (not available when used with the SDC-1)	PIP/PBP Enable	On / Off	
	Letterbox			PIP Set Up	PIP Off	
	Virtual Wide				Graphic in Video	
	Cinema			PBP Set Up	Video in Graphic	
	Virtual Cinema	(available only on CL-810 projectors equipped with the CineWide option)			PBP Off	
Installation	Language	English, French, Spanish, German or Italian			Graphic by Video	
	Picture Orientation	Floor Front, Floor Rear, Ceiling Front or Ceiling Rear			Video by Graphic	
	Keystone Adjust	-14, -13 ... 0 ... +13, +14		DNR	0, +1, +2, +3 ... +15	
	Background Color	Blue or White		White Balance	Gamma	Red / Green / Blue
	RS-232 Baud Rate	9600, 38400 or 115200			Gain	
	Blue Image	On / Off			Offset	
					Store Color Temp. 4	
				Store Color Temp. 5		
				Gamma Selection	2.8, 2.5, 2.2, 1.0, RUNCO Enhance 1, RUNCO Enhance 2 or ISF Day	
				SD Enhance	H Enhance	0, +1, +2, +3 ... +127
					V Enhance	
					Chroma Enhance	
					H Threshold	
					V Threshold	
				RVR Adjust	0, 1, 2 ... 19	
					Chroma Threshold	
				Image Over Scan	Total	0, +1, +2, +3 ... +15
					Horizontal	
					Vertical	
				Image Shift	Horizontal	-30, -29, ... 0 ... +29, +30
					Vertical	
				Amplitude Adjust	Horizontal	-60, -59 ... 0 ... +59, +60
					Vertical	
				Horizontal Masking	0, +1, +2, +3 ... +100	(CineWide versions only)
				Video Black Level	0 IRE or 7.5 IRE	
				Lamp Power	250W or 200W	
				Remote Control	Primary	
					Secondary	
				Reset Lamp Timer	Yes / No	
				Fan Control	Mode	Auto Normal, Auto Hi. Altitude or Manual
					Fan Speed (Manual Mode)	
				Screen Trigger Mode	Normal or AutoScope	(CineWide versions only)
				Return to User OSD		
				Reset Picture Adjust	Yes / No	
				Picture Adjust	Brightness, Contrast, Color etc.	(see above)
				White Balance	Gamma, Gain, Offset etc.	(see above)
				Gamma Selection	2.8, 2.5, 2.2, 1.0, RUNCO Enhance 1, RUNCO Enhance 2 or ISF Day	
				Blue Image	On / Off	
				ICC Adjust	NTSC / HDTV / PAL	R / G / B / Y / C / M Intensity / Sat. / Hue
				Store Settings	Memory 1, ISF Night or ISF Day	
				Splash Screen Timer	+5, +6, +7 ... +60 seconds	
				ISF Enable	On / Off	
				Return to User OSD		

Figure 4-1. CL-810 OSD Menu Structure

The Main Menu is the starting point for accessing all projector functions.

(The Set Up and ISF Calibration menus are hidden and not accessible until you enter a passcode.)

The active source is indicated by an arrow (>) to its left; in the example at left, Video is the active source. To select a different source, use the ▲ or ▼ button to highlight it and press **ENTER** or ►.

◀ **Main Menu**

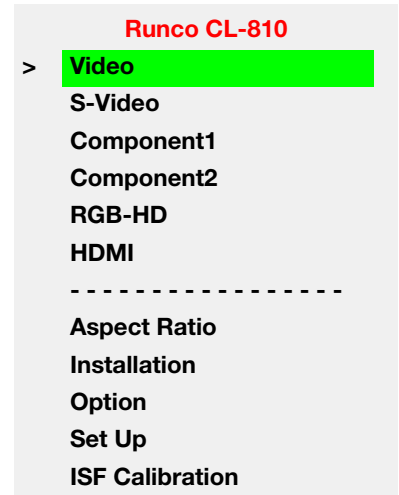

Use the controls in the Adjustment Menu to calibrate your CL-810 for optimum picture quality. To access the Adjustment menu, press **MENU**, highlight the active source and press **ENTER** or ►.

To adjust a setting, use the ▲ or ▼ button to highlight it and press **ENTER**. Use the ◀ or ► button to change the setting. When finished, press **EXIT**.

The CL-810 has been designed to incorporate setup and calibration standards established by the Imaging Science Foundation (ISF). The ISF has developed carefully crafted, industry-recognized standards for optimal video performance and has implemented a training program for technicians and installers to use these standards to obtain optimal picture quality from Runco video display devices. Accordingly, Runco recommends that setup and calibration be performed by an ISF certified installation technician.

All signal types require separate processing. Therefore, you need to calibrate each input separately. Runco recommends calibrating the CL-810 inputs in the following order:

1. Component 1
2. RGB-HD / Component 2
3. S-Video
4. Composite
5. HDMI

◀ **Picture Adjustment**

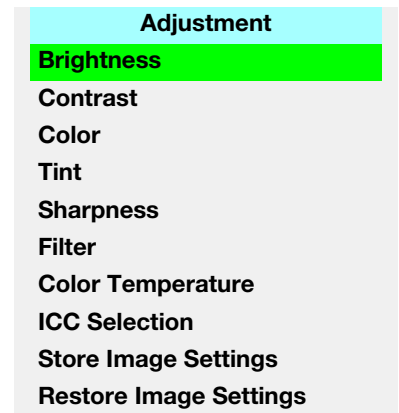

Note

*When you change a picture quality setting, save the change to a preset afterwards. Otherwise, the change will be lost when a different input is selected. (Picture quality settings are saved for each input and resolution separately.) For information about saving settings, refer to **Store Image Settings** on page 38.*

Although it may be possible to obtain satisfactory picture quality using the naked eye and regular program material, Runco recommends using the following calibration tools for best results:

- External test pattern source -- Sencore VP401 Multimedia Video Generator, Ovation Multimedia test DVD or equivalent.
- A blue filter (provided with many test DVDs), for color level and tint adjustments.

Connect your test pattern source to the input that you are calibrating and proceed as follows. **Perform the adjustments in the order listed here.**

Brightness: On your external test pattern source, select a PLUGE pattern. (PLUGE is an acronym for "Picture Line-Up Generation Equipment.") Figure 4-2 shows a typical PLUGE pattern.

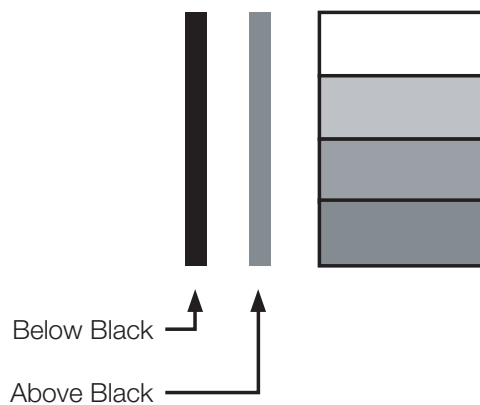

Figure 4-2. Typical PLUGE Pattern for Adjusting Brightness

PLUGE patterns vary but generally consist of some combination of black, white and gray areas against a black background. The example above includes two vertical bars and four shaded boxes.

Select Brightness from the Adjustment menu and press **ENTER**. Adjust the brightness so that:

- The darkest black bars disappear into the background.
- The dark gray areas are barely visible.
- The lighter gray areas are clearly visible.
- The white areas are a comfortable level of true white.
- The image contains only black, gray and white (no color).

Contrast: On your external test pattern source, select a stepped, gray-bar pattern like the one shown in Figure 4-3.

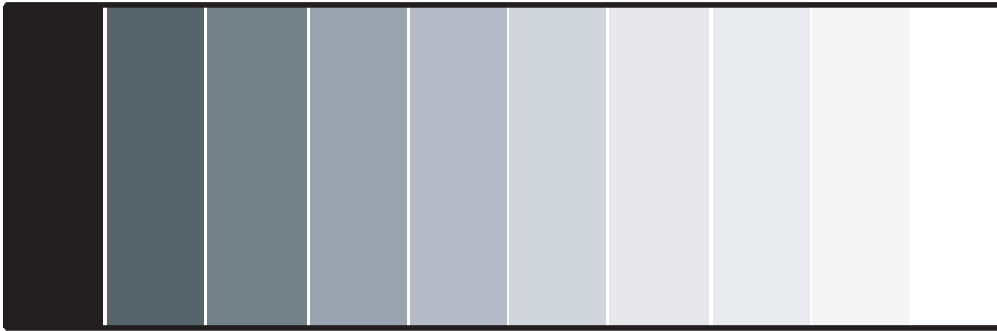

Figure 4-3. Typical Gray Bar Pattern for Adjusting Contrast

Select Contrast from the Adjustment menu and press **ENTER**. Adjust the contrast to a point just below which the white rectangle starts to increase in size.



Note

Brightness and contrast controls are interactive. A change to one may require a subtle change to the other in order to achieve the optimum setting.

Color Saturation: On your external test pattern source, select a color bar pattern like the one shown in Figure 4-4.

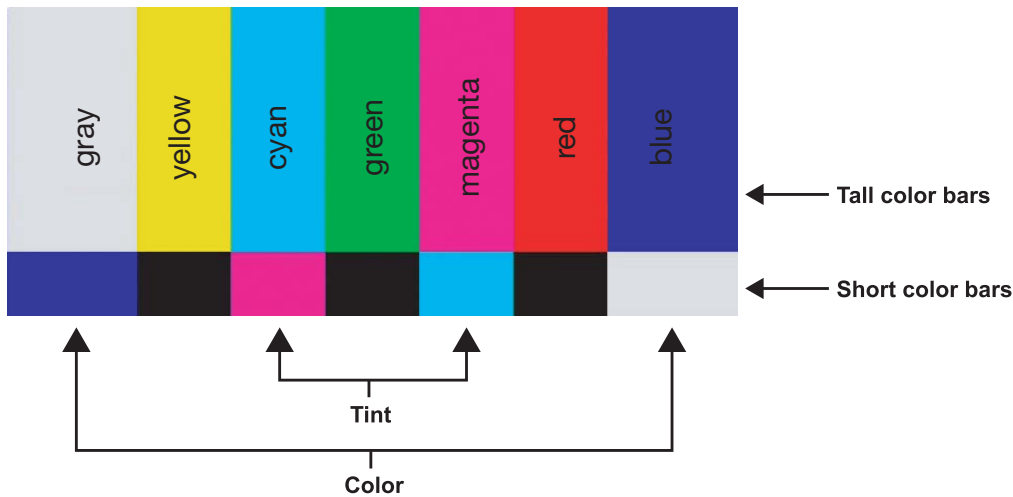
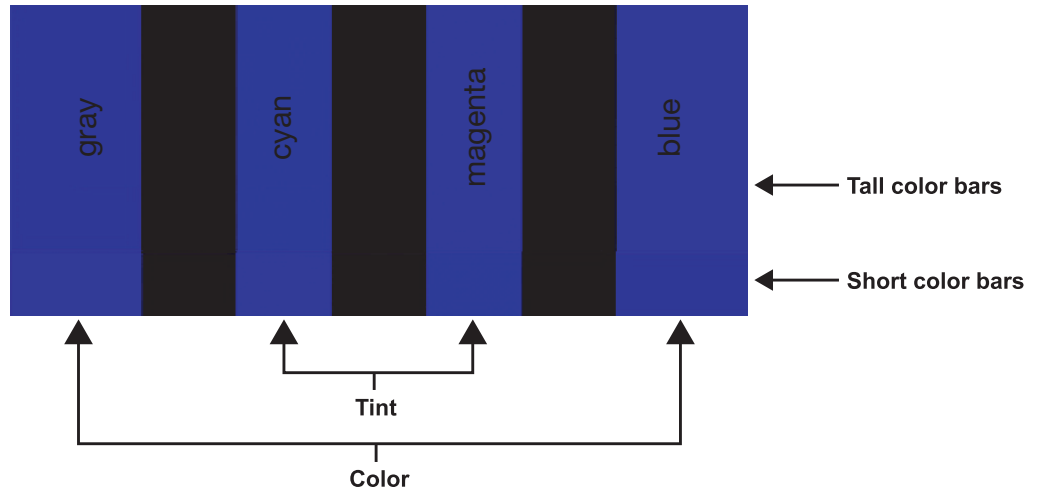

Figure 4-4. Typical Color Bar Pattern for Adjusting Color Saturation and Tint

Select Color from the Adjustment menu and press **ENTER**. While looking at the color bar pattern through a blue filter, adjust the color saturation level until the outermost (gray and blue) color bars appear to be a single shade of blue:



Tint: Tint or “hue” is essentially the ratio of red to green in the color portion of the image. When tint is decreased, the image appears redder; when it is increased the image appears greener. To set the tint, select Tint from the Adjustment menu and press **ENTER**. While looking at the color bar pattern through a blue filter, adjust the tint level until the cyan and magenta color bars (on either side of the green bar) appear to be a single shade of blue.



Note

Like the brightness and contrast controls, the color and tint controls are interactive. A change to one may require a subtle change to the other in order to achieve the optimum setting.

Sharpness: “Sharpness” is the amount of high-frequency detail in the image. To adjust sharpness, select Sharpness from the Adjustment menu and press **ENTER**. On your external test pattern source, select a pattern like the one shown in Figure 4-5. Adjust as needed, looking for white edges around the transitions from black to gray and differently-sized lines in the “sweep” patterns at the top and bottom. Lower the sharpness setting to eliminate them.

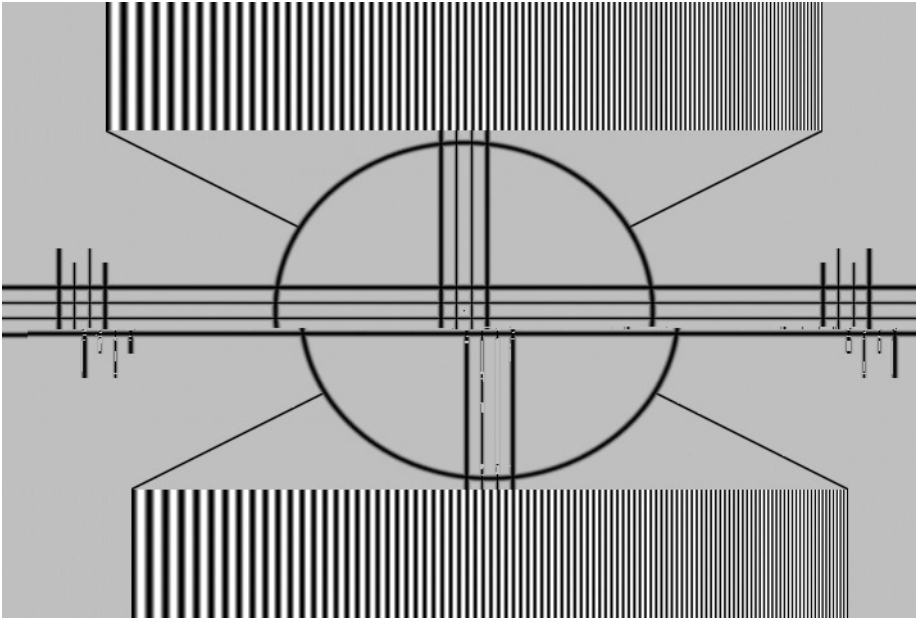

Figure 4-5. Typical Test Pattern for Adjusting Sharpness



Note

The Sharpness setting has no effect if the Sharpness Filter (see below) is set to 0.

Filter: The **Filter** setting controls the behavior of the Sharpness control. The available settings depend on the vertical resolution of the input signal, as follows:

- **With a 480i signal**, you can apply the sharpness control to either the input signal (1), the output signal (2), both (3) or neither (0).
- **With a 480p or higher-resolution signal**, the sharpness control is applied only to the output signal and only when you set the Sharpness Filter to “on” (1).

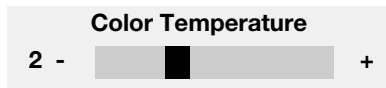

Color Temperature: The CL-810 has six memory settings for Color Temperature. Four of these settings are factory set to default as follows:

- 0 -- Original lamp color temperature
- 1 -- 5400 kelvins
- 2 -- 6500 kelvins
- 3 -- 8500 kelvins
- 4 -- Custom
- 5 -- Custom

Custom 4 and 5 memory are installer-adjustable and can be used to create custom settings. There are nine adjustable “white balance” parameters available for the Custom 4 and 5 settings (three each for red, green and blue). These are described later in this section; refer to **Set Up** on page 42.



Note

You must enter a passcode in order to enter the Set Up menu.

ICC Selection: Use the ICC Selection menu to select the color space that is appropriate for the source signal, to achieve optimal color balance.



Note

The International Color Consortium (ICC) is a group of imaging product vendors that promotes and develops cross-platform, vendor-neutral color measurement and management standards.

If you select NTSC, HDTV or PAL, you can make further adjustments to individual color space characteristics in the ICC Adjust sub-menu under the ISF Calibration menu, described later in this section. (The Standard color space is factory-set and not adjustable.)

Store Image Settings: Once the desired adjustments have been entered, select Store Image Settings to save these settings into the “Memory 1” memory location.

Restore Image Settings: To recall stored custom image quality settings, select Restore Image Settings and choose “Memory 1,” “ISF Night” or “ISF Day.”

Aspect Ratio ➤

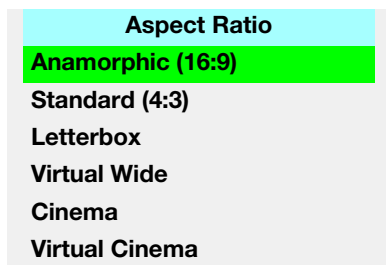

To change the aspect ratio (size and shape) of the projected image, select Aspect Ratio from the Main Menu and press **ENTER**. Select the appropriate aspect ratio for your screen size and the type of program material being viewed; refer to Table 4-1.



Note

When you change the aspect ratio, save the change to a preset afterwards. Otherwise, the change will be lost when a different input is selected. (The aspect ratio is saved for each input and resolution separately.)

Table 4-1. Aspect Ratio Settings



Aspect Ratio	Remote Control Key	Description	
Anamorphic	ANA	 <p>16:9 Image on 16:9 Screen</p> <p>4:3 Image on 16:9 Screen</p>	<p>Select Anamorphic to view 16:9 DVDs and HDTV programs in their native aspect ratio. 4:3 images are stretched horizontally to fit a 16:9 screen.</p>
Standard 4:3	4X3	 <p>Active Image Area (4:3)</p>	<p>Standard 4:3 scales the input signal to fit in the center of the 16:9 screen. 4:3 is the aspect ratio used by computer monitors, standard television programming and most VHS video cassettes.</p>
Letterbox	LBOX	 <p>Letterbox Image on 16:9 Screen</p>	<p>In Letterbox mode, the image is stretched vertically; the top and bottom portions are “blacked off.” Letterbox is best suited for viewing LaserDisc movies or non-anamorphic DVDs on a 4:3 screen.</p>
VirtualWide	VWIDE		<p>A 4:3 image is scaled NON-linearly (more on the sides than in the center) to fit a 16x9 screen.</p>
Cinema	CINEMA	 <p>2.35:1 Image on 16:9 Screen</p>	<p>Select Cinema to view 2.35 source material on a 16:9 screen. The upper and lower portions of the screen are masked, but the geometry of the active image area is not changed.</p>

Table 4-1. Aspect Ratio Settings (continued)

Aspect Ratio	Remote Control Key	Description	
Virtual Cinema	VCINE	 <p>The diagrams illustrate the Virtual Cinema process. The top diagram shows a 2.35:1 image (a circle) on a 16:9 screen, which is stretched horizontally to fill the screen. The middle diagram shows the same 2.35:1 image on a 16:9 screen with Virtual Cinema enabled, where the image is stretched vertically to fill the screen. The bottom diagram shows the 2.35:1 image on a 2.35:1 screen with Virtual Cinema enabled, where the image is stretched vertically to fill the screen.</p>	<p>A 2.35 image is stretched anamorphically in both directions to fill a 16:9 image. (The secondary anamorphic lens then “stretches” the image back to 2.35:1.)</p> <p>Virtual Cinema is available only on CL-810 projectors equipped with the CineWide option.</p>

Installation ➤

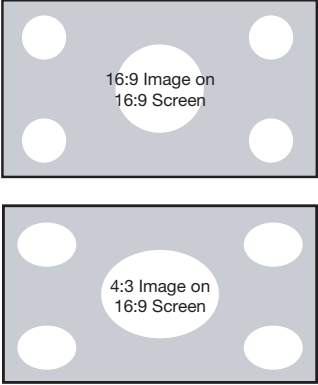
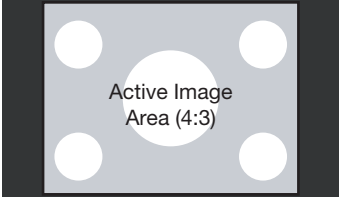
- Installation
- Language
- Picture Orientation
- Keystone Adjust
- Background Color
- RS-232 Baud Rate
- Blue Image

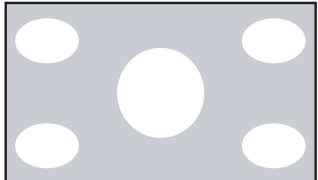
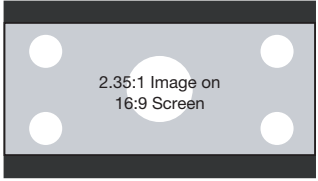
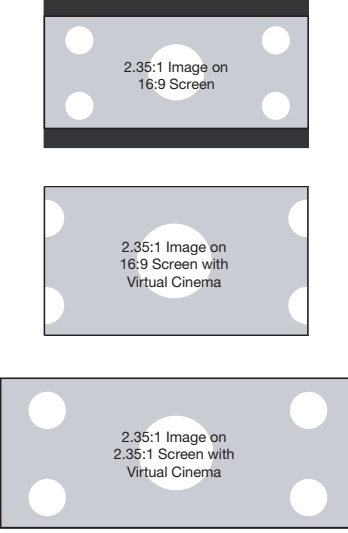
To access the Installation adjustments, press **MENU**, then press the ▲ or ▼ button to highlight Installation and press **ENTER**. The Installation sub-menu, shown at left, appears. Press **EXIT** to return to the previous menu or press **MENU** to close all menus.



Note

*When you change a setting in the Installation menu, the change takes effect immediately; you do not need to press **ENTER** afterwards. (Press **EXIT** to return to the previous menu or **MENU** to exit.)*

Language: Press the ▲ or ▼ button to select from the available languages: English, French, Spanish, German and Italian.

Picture Orientation: Press the ▲ or ▼ button to change the orientation of the projected image. The CL-810 can be installed on a ceiling or in a rear-screen configuration with one or more mirrors. There are four settings: Floor Front, Ceiling Front, Floor Rear and Ceiling Rear.

Keystone Adjust: To correct distortion resulting from the angle of projection, select Keystone Adjust and use the ◀ or ▶ button to make the image rectangular.



Tip

Runco recommends that the keystone feature not be used unless absolutely necessary, as it may cause artifacts in the image.

Background Color: Press the ▲ or ▼ button to select the image Background Color (blue or white). The Background Color appears when no incoming signal is present.

RS-232 Baud Rate: Press the ▲ or ▼ button to select the projector’s RS-232 Baud Rate. This function is used to change the transfer rate of the RS-232 connection. (This setting must match the data rate of the device connected to the RS-232 input.)

Blue Image: Press the ▲ or ▼ button to turn the Blue Image Off or On. This feature removes all red and green color information from the image (simulating a blue filter), and is useful for color-calibrating the projector or other video components.

To access the Option adjustments, press **MENU**, then press the ▲ or ▼ button to highlight Option and press **ENTER**. The Installation sub-menu will then appear (see above). Press **EXIT** to return to the previous menu or press **MENU** to close all menus.

Reset Image Settings: To restore the default image settings for the current input source ONLY, press the ► button to highlight “Yes,” then press **ENTER**.

Sleep Timer: The Sleep Timer automatically puts the projector into standby mode after the amount of time you specify here. (A warning appears on-screen one minute before this is to occur.)

Use the ◀ or ▶ button to set the timer for anywhere from 10 minutes to 3 hours, in 10-minute increments. To disable the Sleep Timer, set it to 0.

Lamp Hours: To find out how long the projector lamp has been in use, select Lamp Hours and press **ENTER**.

OSD Timer: Use the ◀ or ▶ button to set the OSD Timer. This timer controls how long the menus remain on-screen after selecting them. Select from 0 to 60 seconds, in 3-second increments. When you set the OSD to 0, the menus remain on-screen until you hide them by pressing **MENU**.

To adjust the horizontal and vertical position of the OSD, select OSD Position and press **ENTER**. Then, press the ▲ or ▼ button to select Horizontal or Vertical and use the ◀ or ▶ button to adjust.

PC & HD Adjust: Use the settings in the PC & HD Adjust menu to fine-tune 480p and higher-resolution signals for optimum picture quality.

- **Auto:** Adjusts the phase, frequency and position automatically.
- **Freq.** Adjusts the frequency of the signal.
- **Phase:** Adjust the phase if the image (usually from an RGB source) shows shimmer or “noise.” Pixel phase adjusts the phase of the pixel sampling clock relative to the incoming signal. The effect of this control is similar to that of a tracking control on a VCR.

For best results, use a good test pattern such as a smooth gray consisting of a clear pattern of black and white pixels, or a similar “half on, half off” graphic image. (You may find that you can stabilize the image at more than one point. Use either setting in this case.)

- **H. Pos.:** Adjusts the horizontal position of the image.
- **V. Pos.:** Adjusts the vertical position of the image.

◀ Option

Option
Reset Image Settings
Sleep Timer
Lamp Hours
OSD Timer
OSD Position
PC & HD Adjust
DNR



Note

To adjust the image position with a 480i source, use the Image Shift controls in the Set Up menu (see page 43).

PIP/PBP Set Up: Select PIP/PBP Set Up from the Option menu to change the PIP/PBP settings.

- **PIP/PBP Enable:** Press the or button to select PIP/PBP Enable, then press **ENTER**. Press the or button to select Off or On, then press **ENTER**.
- **PIP Set Up:** Press the or button to select PIP Set Up, then press **ENTER**. Press the or button to select PIP Off, Graphic in Video or Video in Graphic, then press **ENTER**.
- **PBP Set Up:** Press the or button arrows to select PBP Set Up, then press **ENTER**. Press the or button to select PBP Off, Graphic by Video or Video by Graphic, then press **ENTER**.

DNR: Use the or button to adjust the Digital Noise Reduction (DNR). DNR is useful for clearing up noisy images from interlaced SD sources. Adjust as desired, keeping in mind that reducing noise (which reduces high frequencies) may also soften the image.

Set Up

To access advanced picture quality adjustments, use the up- or down-arrow keys to highlight Set Up and press **ENTER**. Use the number buttons on the remote to enter the Set Up menu passcode when prompted and press **ENTER** again. Then, press **MENU** on the remote control.

White Balance: To remove any trace of color from the white areas of the projected image, choose White Balance from the Set Up menu and press **ENTER**.

- **Gamma:** “Gamma” is a global setting that determines how gray shades are displayed between minimum input (black) and maximum input (white) for all signals. A good gamma setting helps to optimize blacks and whites while ensuring smooth transitions for the “in-between” values utilized in other grays. Unlike “Brightness” and “Contrast” controls, the overall tone of your images can be lightened or darkened without changing the extremes and all images will be more vibrant while still showing good detail in dark areas.

In all but the most unusual situations, the appropriate “Gamma Selection” (see below) will produce accurate colors and a satisfying contrast level. However, it is sometimes necessary to adjust the red, blue and green gamma curves individually. To do this, select Gamma from the White Balance sub-menu and use the left- and right-arrow buttons to manipulate the on-screen slidebars.

- **Gain:** Use the Gain controls to correct color imbalances in the bright areas of the image. A good way to do this is to use a test pattern consisting mostly of solid white areas, such as an 80 IRE “window” pattern. If the white areas contain traces of red, green or blue, decrease the Gain for that color.
- **Offset:** Use the Offset controls in the White Balance sub-menu to correct color imbalances in the dark areas of the image. A good way to do this is to use a test pattern consisting mostly of dark gray areas, such as a 30 IRE “window” pattern. If the gray areas contain traces of red, green or blue, decrease the Offset for that color.
- **Store Color Temp.4/Store Color Temp.5:** When you are finished adjusting the o Ga Gaoain

Gamma Selection: The normal gamma setting of 2.2 is correct for almost all signals and conditions. If excess ambient light washes out the image and it becomes difficult or impossible to see details in dark areas, lower the gamma setting to compensate. This will improve contrast while maintaining good details for blacks. Conversely, if the image is washed out and unnatural, with excessive detail in black areas, increase the setting. Again, good gamma improves contrast while maintaining good details for blacks and whites.

SD Enhance: The SD Enhance menu gives you options for improving the quality of standard-definition, 480i images. (For 480p and higher-definition images, the controls in this menu are disabled.) Keep in mind that these controls add frequencies that are not present in the original signal, and may make images appear “noisy” if misused.

- **H Enhance/V Enhance:** These controls can improve the apparent horizontal and/or vertical resolution of the image.
- **Chroma Enhance:** This control adds chroma (color information) to the input signal and can make colors appear more vibrant and saturated.
- **H Threshold/V Threshold/Chroma Threshold:** Set these to +11 or higher to activate the enhancement controls described above. Generally, the higher the threshold, the more noticeable the enhancements you make will be.

RVR Adjust: Use the RVR Adjust control to increase or decrease the Reflectance Volume Regulation setting. RVR lets you control the aperture or iris size (the physical opening through the lens; similar to an “f-stop” on a camera). Doing so allows you to optimize brightness and contrast according to the amount of ambient light in the viewing area.

Use a higher setting for rooms with lots of ambient light. Use a lower setting for more “theater-like” viewing conditions (little or no ambient light).

Image Over Scan: Image Over Scan pushes the outside edge of the active picture area of the video signal out beyond the edge of the display area.

Some television programs are produced based on the assumption that older television sets may not display the outer edges of the broadcast picture area. Over scan effectively trims away these inactive, outer edges and enlarges the remaining portion of the image to fill the display area.

Use the on-screen slidebar to select the desired amount of over scan.

For HDTV, DVDs and other video sources, Image Over Scan is generally not necessary or desirable.

Image Shift: The Image Shift menu allows you to precisely center the image on the screen. (These controls are available only with a 480i source signal.)

- **Horizontal:** This control moves the image right or left within the area of available pixels.
- **Vertical:** This option moves the image up or down within the area of available pixels.



Note

1. To adjust the image position with a 480p or higher-resolution source, use the PC & HD Adjust controls in the Option menu, described on page 41.
2. The values shown represent where the approximate center of the image lies in relation to the total number of pixels available horizontally or vertically. This varies widely according to the signal; watch the image while adjusting.

Amplitude Adjust: The Amplitude Adjust menu allows you to fine-tune the currently-selected image aspect ratio by stretching it horizontally or vertically, in small increments. This can be useful if your projector is equipped with an anamorphic lens.

The Horizontal control adjusts the image width while keeping the height constant. Similarly, the Vertical control adjusts the image height while keeping the width constant.

Horizontal Masking (CineWide CL-810 versions only): To achieve the proper image geometry with the secondary anamorphic lens, select Horizontal Masking from the Set Up menu. Then, use the ◀ or ▶ button to change the native aspect ratio of the display, in small increments.

Video Black Level: This control compensates for incoming elevated black levels present in certain video signals, and ensures that blacks in the display are neither “crushed” (where dark grays appear black) nor excessively elevated (where blacks appear dark gray). By default, the projector automatically determines the best setting according to the type of incoming video signal:

- **0 IRE:** Used for DVD output with “enhanced black,” SECAM, most PAL standards and Japanese NTSC.
- **7.5 IRE:** Used for most NTSC video signals.

For some types of video, you may want to override the setting. Generally, if black appears crushed when brightness = 30, choose “0 IRE.” If black appears excessively elevated, use “7.5 IRE.”

Lamp Power: Select Lamp Power from the Set Up Menu to adjust the lamp output level. You can choose to run the lamp as bright as possible (250W; this is the default setting) or you can choose the lower (200W) setting. Generally, lower lamp output can prolong the life of the lamp, but decreases brightness.

Remote Control: The Remote Control menu shows you the primary and secondary infrared (IR) codes to which the CL-810 will respond. The Primary IR code is permanently set to +20. The secondary IR code is also +20.

You can change the secondary IR code if either:

- Another device in the theater (a DVD player, for example) is responding to commands from the CL-810 remote control in ways that are unpredictable or undesirable.
- You have multiple CL-810 projectors and want to control them independently, as opposed to broadcasting commands from a single remote to all of them. In this scenario, you can use multiple remotes programmed to use different IR codes. Or, you can use a single remote and change the IR code as needed to address a specific projector.

When you change the secondary IR code, the remote sends that code instead of the primary IR code.



Note

The Remote Control menu is read-only and need not be visible in order to change the secondary IR code.

To simultaneously change the secondary IR code and synchronize that remote with a projector, *point the remote at the projector*, then press and hold ◀ and ▶ simultaneously for five seconds. The Remote Control edit window, shown at right, appears. Type a new, two-digit code.

The procedure for changing the secondary IR code on the remote *only* is the same, except that you point the remote away from the projector.

Reset Lamp Timer: When you replace the projector lamp (refer to **Lamp Replacement** on page 49), you should also reset the lamp timer. To do this, select Reset Lamp Timer from the Set Up menu. Press the right-arrow key on the remote to highlight “Yes,” then press **ENTER** to confirm the reset.

**Note**

Reset the Lamp Timer ONLY after you replace the lamp. Otherwise, the reported “Lamp Hours” will be inaccurate.

**WARNING**

Do not exceed the recommended lamp life of 2000 hours. An old lamp becomes increasingly fragile and prone to sudden failure.

Fan Control: Select Fan Control from the Set Up Menu to control the operation of the projector’s cooling fan.

- **Mode:** In most cases, the default Fan Control Mode (Auto Normal) will maintain the correct operating temperature. If the lamp frequently turns off due to overheating, or in certain high-altitude operating environments, you may need to change this setting to Auto Hi, Altitude or Manual.
- **Fan Speed:** If you set the Fan Mode to Manual, select Fan Speed and use the on-screen slidebar to adjust the speed.

After changing either of these settings, press **EXIT** to return to the previous menu.

Screen Trigger Mode: Select Screen Trigger Mode from the Set Up menu to configure the 12-volt trigger output.

- Set the Screen Trigger Mode to Normal if you want the trigger to activate when the projector is turned on (for instance, if the trigger is controlling a retractable screen).
- Set the Screen Trigger Mode to AutoScope if you want the trigger to activate when the Cinema or Virtual Cinema aspect ratio is selected. Choose this setting if your CL-810 is equipped with the Runco CineWide with AutoScope system.

**Note**

If your CL-810 installation includes an SDC-1 System Expansion Device, you can also use the SDC-1 to trigger the AutoScope lens motor. Refer to the SDC-1 manual for more information.

Return to User OSD: To exit the Set Up menu, use the up- or down-arrow keys to highlight Return to User OSD and press **ENTER**.

To return to the Set Up menu, select it from the Main Menu, press **ENTER** twice, then press **MENU** on the remote control. (You do not need to re-enter the passcode.)

ISF Calibration ►**ISF Calibration****Reset Picture Adjust**

Picture Adjust

White Balance

Gamma Selection

Blue Image

ICC Adjust

Store Settings

Splash Screen Timer

ISF Enable

Return to User OSD

To access the ISF Calibration menu, select ISF Calibration from the Main Menu and press **ENTER**. Use the number buttons on the remote control to enter the ISF Calibration menu passcode when prompted and press **ENTER** again. Then, press **MENU** on the remote control.

**Note**

This menu should be used by ISF-certified technicians only.

Reset Picture Adjust: To restore the ISF default image settings for the current input source ONLY, press the ► button to highlight “Yes” then press **ENTER**.

Picture Adjust: These settings are described in the **Picture Adjustment** section (page 33).

White Balance / Gamma Selection: These settings are described in the previous section, **Set Up**.

Blue Image: This setting is described in the Installation section (refer to page 41).

ICC Adjust: Use the ICC Adjust controls to customize the stored NTSC, HDTV and/or PAL color space characteristics. To do this, select the color space to modify. Then, select a component color (Red, Green, Blue, Yellow, Cyan or Magenta).

For each component color, you can adjust the following:

- **Intensity:** This slider adjusts the intensity -- also known as *luminance* -- of a given color.
- **Sat.** This slider adjusts the color saturation level -- the amount of that color in a video image. Lower settings produce less saturated colors; a setting of “0” removes that color from the image entirely. If the saturation is too high, that color will be overpowering and unrealistic.
- **Hue:** This slider adjusts the red/green color hue for true color reproduction of video signals. For best results, adjust tint while displaying an external color bars test pattern (see Figure 4-4). Otherwise, it is recommended that Hue remain at its default setting.

When you have finished customizing the color space, select Store Setting and press **ENTER**.

Store Settings: For each input, the CL-810 lets you store image quality settings as presets that you can recall at a later time. You can create up to three presets per input and resolution.

**Note**

When you change a setting, save the change to a preset afterwards. Otherwise, the change will be lost when a different input is selected. (Most settings are saved for each input and resolution separately.)

When you have finished calibration, select Store Settings and choose “Memory 1,” “ISF Night” or “ISF Day” to store your settings.

To recall stored custom image quality settings, select Restore Image Settings from the Adjustment menu (refer to **Picture Adjustment** on page 33) and choose “Memory 1,” “ISF Night” or “ISF Day.” Or, simply use the corresponding buttons on the remote control.

Splash Screen Timer: Use the ◀ or ▶ button to set the Splash Screen Timer. This timer controls how long the startup (ISF and Runco logo) image stays on-screen after you turn on the projector. Select from 5 to 60 seconds, in 1-second increments. When finished, press **EXIT**.

ISF Enable: Use ISF Enable to control the display of the ISF logo on the CL-810 splash screen upon power-up.

Return to User OSD: To exit the ISF Calibration menu, use the up- or down-arrow keys to highlight Return to User OSD and press **ENTER**.

To return to the ISF Calibration menu, select it from the Main Menu, press **ENTER** twice, then press **MENU** on the remote control. (You do not need to re-enter the passcode.)

Notes:



5.2 Troubleshooting Tips

Table 5-1 provides some general guidelines for troubleshooting problems you may encounter with the CL-810. If the suggested solutions fail to resolve the problem or if you encounter an issue not described here, please contact Runco Technical Support.

Table 5-1. Troubleshooting Chart

Symptom	Possible Cause(s)	Solution
The projector does not turn on.	<ul style="list-style-type: none"> The CL-810 is not plugged in or the AC outlet is not active. The main power switch (at the rear of the projector) is off. Lamp cover is not securely attached. 	<ul style="list-style-type: none"> Ensure that the CL-810 is plugged in and that the AC outlet is active. Turn on the power switch. Securely attach the lamp cover.
The projector does not turn back on after it was powered off.	<ul style="list-style-type: none"> The projector will not turn on for two minutes after power-off, to protect the lamp. 	<ul style="list-style-type: none"> Wait until the CL-810 completes its cool-down (POWER LED lights solid orange).
The remote control does not work correctly.	<ul style="list-style-type: none"> The batteries have run out. 	<ul style="list-style-type: none"> Replace the batteries.
The projector is on and OSD menus appear, but there is no video image on-screen.	<ul style="list-style-type: none"> Incorrect source selection. Source component is not turned on. Source component is connected incorrectly or not at all. 	<ul style="list-style-type: none"> Select the correct source. Turn on the source. Check cable connection from source component to projector.
A projected image from a DVD is split or otherwise scrambled.	<ul style="list-style-type: none"> DVD player is connected to the Component input and set to progressive scan mode. 	<ul style="list-style-type: none"> Turn off progressive scan on the DVD player.
Image is blurred.	<ul style="list-style-type: none"> The lens is not correctly focused. 	<ul style="list-style-type: none"> Adjust the focus with the remote control.
Image is too bright and/or lacks definition in the bright areas of the image.	<ul style="list-style-type: none"> Contrast is set too high. 	<ul style="list-style-type: none"> Lower the contrast setting.
Image appears "washed out" and/or dark areas appear too bright.	<ul style="list-style-type: none"> Brightness is set too high. 	<ul style="list-style-type: none"> Lower the brightness setting.
Colors in the image are swapped; for example, reds appear blue or vice versa.	<ul style="list-style-type: none"> The Red/Pr, Green/Y or Blue/Pb outputs from the source are connected to the wrong inputs on the CL-810. 	<ul style="list-style-type: none"> Ensure that the source outputs are connected to the correct CL-810 input.

Table 5-1. Troubleshooting Chart (continued)

Symptom	Possible Cause(s)	Solution
TEMP and LAMP LEDs are both flashing red.	<ul style="list-style-type: none"> • The lamp cover is open. • Fans are not working properly. 	<ul style="list-style-type: none"> • Close the lamp cover. • Please contact your Runco dealer for assistance.
LAMP LED lights solid red.	<ul style="list-style-type: none"> • The lamp has failed or exceeded its usage life. 	<ul style="list-style-type: none"> • Replace the lamp with a new one.
TEMP LED lights solid red.	<ul style="list-style-type: none"> • CL-810 internal temperature is too high. 	<ul style="list-style-type: none"> • Power off the CL-810 and allow it to cool down. Ensure that the intake and exhaust vents are not blocked. Turn the projector back on. If the problem persists, please contact your Runco dealer for assistance.

Notes:

Serial Communications

To interface the CL-810 with a home theater automation/control system or a PC running terminal emulation software:

1. Connect it to your control system or PC as shown in Figure 3-11.
2. Start a terminal session on your PC using a terminal-emulation program, such as HyperTerminal.
3. Configure the RS-232 controller or PC serial port as follows: no parity, 8 data bits, 1 stop bit and no flow control. Set the baud rate to match that of the projector (115200, 38400 or 9600).
4. Press **<Enter>**. You should see a command prompt (>) in the terminal window.
5. Type a command from among those listed in Table 6-1 and press **<Enter>**. For example, to change the aspect ratio to Letterbox, type `x063x` **<Enter>**.

Serial commands to the CL-810 take the following form:

- Commands are in ASCII format.
- Commands are not case-sensitive; `x001X` and `x001x` are equivalent.
- A carriage return MUST follow each command.



Note

The CL-810 will not accept serial commands for 20 seconds after it is turned on or off.

6.1 RS-232 Connection and Port Configuration

6.2 Serial Command Syntax

Table 6-1. Serial Commands

Code	Function
x001x	Power On
x002x	Power Off
x003x	Menu
x004x	Enter
x005x	Exit
x006x	Up (arrow key)
x007x	Down (arrow key)
x008x	Left (arrow key)
x009x	Right (arrow key)
x011x	Show active source and aspect ratio information
x021x	Keypad 1
x022x	Keypad 2

Table 6-1. Serial Commands (continued)

Code	Function
x023x	Keypad 3
x024x	Keypad 4
x025x	Keypad 5
x026x	Keypad 6
x027x	Keypad 7
x028x	Keypad 8
x029x	Keypad 9
x030x	Keypad 0
x031x	Store image settings to Memory 1
x032x	Store image settings to ISF Night
x033x	Store image settings to ISF Day
x046x	Restore image settings from Memory 1
x047x	Restore image settings from ISF Night
x048x	Restore image settings from ISF Day
x049x	Load default of current source
x051x	Single source, full-screen
x052x	PIP - graphics on video
x053x	PIP - video on graphics
x054x	PBP - graphics by video
x055x	PBP - video by graphics
x056x	PIP - increase sub-window size
x057x	PIP - decrease sub-window size
x058x	Set PIP/PBP active window
x061x	Anamorphic (16:9) aspect ratio
x062x	Standard (4:3) aspect ratio
x063x	Letterbox aspect ratio
x064x	VirtualWide aspect ratio
x065x	Cinema aspect ratio
x066x	Virtual Cinema aspect ratio
x071x	RS-232 baud rate = 9600
x072x	RS-232 baud rate = 38400
x073x	RS-232 baud rate = 115200

Table 6-1. Serial Commands (continued)

Code	Function
x081x	Image orientation = floor front
x082x	Image orientation = ceiling front
x083x	Image orientation = floor rear
x084x	Image orientation = ceiling rear
x091x	Lamp Power = 200W
x092x	Lamp Power = 250W
x121x	OSD Language = English
x122x	OSD Language = French
x123x	OSD Language = Spanish
x124x	OSD Language = German
x125x	OSD Language = Italian
x131x	Switch to Composite input
x132x	Switch to S-Video input
x133x	Switch to RGB-HD input
x134x	Switch to DVI input (HDMI)
x135x	Switch to Component 1 input
x136x	Switch to Component 2 input
x156x	Background Color = Blue
x157x	Background Color = White
x181x	Toggle Blue Image on/off
x281x	Vertical Lens Shift = Up
x282x	Vertical Lens Shift = Down
x283x	Zoom In
x284x	Zoom Out
x285x	Focus (rotate lens to right)
x286x	Focus (rotate lens to left)
x287x	RVR = Full On (open)
x288x	RVR = Full Off (closed)

Notes:

Specifications

Table 7-1 lists the CL-810 specifications.

Table 7-1. CL-810 Specifications

Projector Type:	Digital Light Processing (DLP), Single-Chip SuperOnyx DMD
Native Resolution:	1280 x 720 (16:9)
Aspect Ratios:	4:3, Letterbox, 16:9 Anamorphic, VirtualWide, Cinema, Virtual Cinema
Video Standards:	NTSC, PAL, SECAM
DTV Compatibility:	480p, 576p, 720p, 1080i
Scan Frequency:	Horizontal: 15 - 80 kHz Vertical: 50 - 100 Hz
Picture Size (16:9 Screen):	Recommended Width: 72 in. (1.83 m) to 96 in. (2.44 m) Capable of screen widths between 48 in. (1.22 m) and 200 in. (5.08 m)
Throw Distance (Factor x Screen Width):	CL-810: 1.80 to 2.43 CL-810 Ultra: Refer to Table 3-3
Horizontal and Vertical Offset:	Refer to Table 3-4

7.1 CL-810 Specifications

Table 7-1. CL-810 Specifications (continued)

Brightness and Contrast:

Cinema Standards Measurement System (CSMS) Specifications

- Brightness*: 14.5 to 21.6 foot-Lamberts (fL)
- Contrast Ratio*: 200:1 to 220:1

*Variable depending on RVR setting

These measurements are taken from the projector in a controlled, home theater environment. All measurements are made to ANSI/NAPM IT7.228-1997 specifications using the Photo Research PR-650 SpectraColorimeter and Minolta LS-100 Luminance Meter, Video Essentials test DVD and a 1.3 gain, 72-inch wide screen. The projector is calibrated to a color temperature of 6,500K and has a minimum of 150 hours of usage.

The foot-Lambert (fL) is the unit of measurement used in commercial movie theaters to express image brightness at the screen surface. The Society of Motion Picture and Television Engineers (SMPTE) specifies 16 fL as the target image brightness for film-based projectors using an open gate (without film in the projector). More importantly, today SMPTE specifies 12 fL as the target image brightness in Digital Cinema theaters. The foot-Lambert measurement is dependent on screen size, screen gain and projector light output.

Home Theater Calibration Specifications

- Light Output: 442 to 587 ANSI Lumens
- Contrast Ratio*: 200:1 to 220:1

These specifications are obtained by calibrating the projector as described above for CSMS measurements.

Industry-Standard Specifications

- Light Output: 1250 ANSI Lumens
- Contrast Ratio: 1500:1 to 3100:1

These are typical projector brightness and contrast specifications found in most companies' sales literature. Runco includes these measurements in its literature to allow for direct comparison with other manufacturers' projectors. These measurements are typically taken at 9,000K to 13,000K to get expected performance data when the projector is used in professional, commercial and industrial displays.

Lamp:	250 Watts
Estimated Lamp Life:	2000 hours
Video Inputs:	(1) Composite Video, (1) S-Video, (1) RGB/Component Video (BNC connectors), (1) RCA Component Video, (1) HDMI
Control Options:	<ul style="list-style-type: none"> - Discrete IR remote - Serial commands via RS-232
RS-232 Communication Parameters:	9600, 38400 or 115200 bps, no parity, 8 data bits, 1 stop bit, no flow control
12V Output:	Max. 0.25 Amps, active when Cinema or Virtual Cinema Aspect Ratio is selected (CineWide versions only) or when projector is turned on
Power Requirements:	100 to 240 VAC (auto-sensing), 50/60 Hz, 310 Watts
Operating Environment:	41°F to 95°F (5°C to 35°C), 20% to 80% humidity (non-condensing)
Dimensions:	<p>CL-810: See Figure 7-1</p> <p>CL-810 Ultra: See Figure 7-2</p>

Table 7-1. CL-810 Specifications (continued)

Weight (without lens):	CL-810: 34 lbs. (15.42 kg) CL-810 Ultra: 36 lbs. (16.33 kg)
Regulatory Approvals:	Complies with FCC, CE C-Tick
Limited Warranty:	Projector: Two (2) years parts and labor from the date of delivery to the end user. Lamp: 1000 hours or six (6) months, whichever comes first.
Specifications are subject to change without notice.	

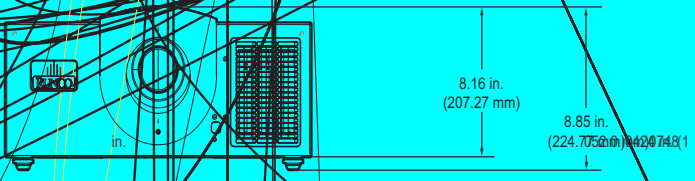
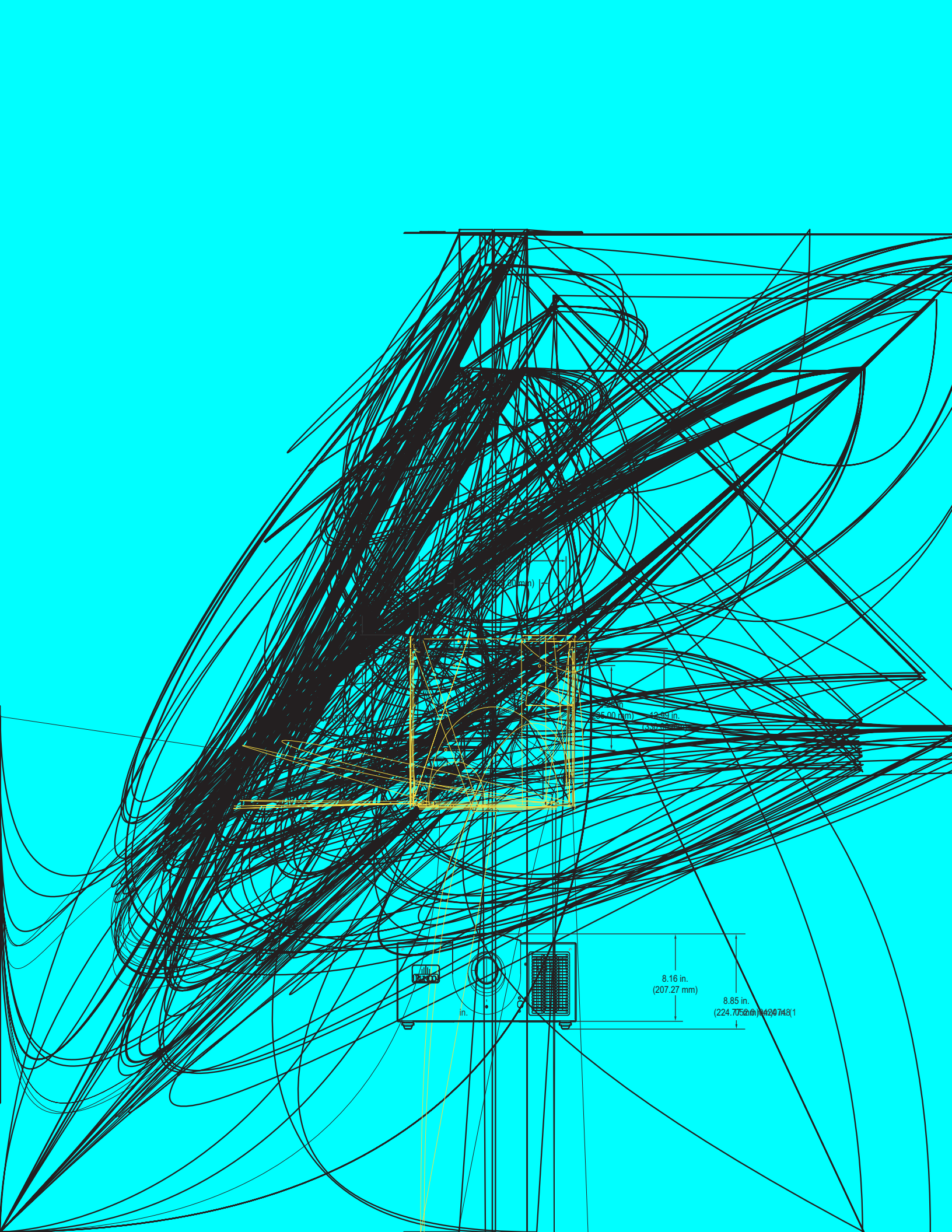

8.00 in.
(203.18 mm)

20.00 in.
(508.00 mm)

Figure 7-2 shows the CL-810 Ultra dimensions.

7.3 CL-810 Ultra Dimensions

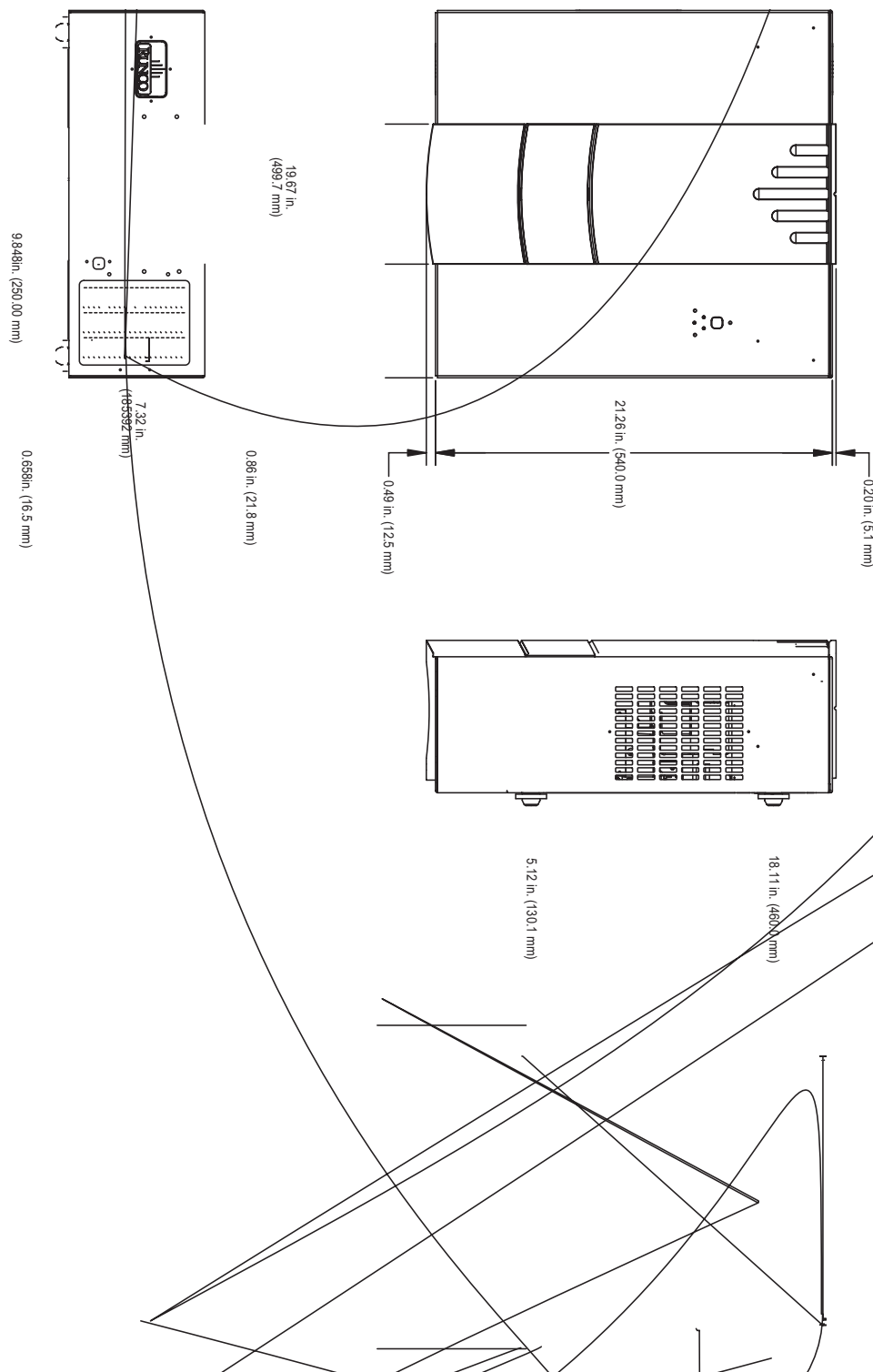

Figure 7-2. CL-810 Ultra Dimensions

Notes:



SERIAL NUMBER
RUMA-011135
rev 02-14-06 v2.0