



WiMAX

# RNU4000BS Base Station

## User Manual

**Doc: Runcom RNU4000BS User Manual RN-PMG-151112 V-3.6**

## About this Guide

This User Manual describes the procedures for commissioning, mounting, installing and managing the RNU4000BS Base Station.

## Notice

This document contains proprietary and confidential material of Runcom Ltd. Any unauthorized reproduction, use or disclosure of this material, or any part thereof, is strictly prohibited. This document is solely for the use of Runcom Ltd. employees and authorized Runcom Ltd. customers.

The material furnished in this document is believed to be accurate and reliable. However, no responsibility is assumed by Runcom Ltd. for the use of this material. Runcom Ltd. reserves the right to make changes to the material at any time and without notice.

All other trademarks are the property of their respective owners. Other company and brand products and service names are trademarks or registered trademarks of their respective holders.

## Safety Precautions

To avoid injury and to prevent equipment damage, observe the safety precautions below.

- Only qualified personnel should be allowed to install, replace, and service the equipment. The device cannot be sold retail, to the general public or by mail order. It must be sold to dealers. Installation must be controlled. Installation must be performed by licensed professionals. Installation requires special training. The Runcom radios and antennas should be installed **ONLY** by experienced installation professionals who are familiar with local building and safety codes and, wherever applicable, are licensed by the appropriate government regulatory authorities. Failure to do so may void product warranty and may expose the end user or the service provider to legal and financial liabilities.
- Always observe standard safety precautions during installation, operation and maintenance of this product.
- This equipment must be installed according to country national electrical codes.
- Any changes and modifications to the device and the accessories must be approved by Runcom.
- All equipment and accessories must be installed in a restricted access area.
- Observe all the labels on the equipment, providing operation details and warnings.
- Read and follow the installation instructions provided in this manual.
- The outdoor base station should be positioned more than 2 meters from humans.
- In case of using cables that are not provided with the equipment package, ensure these cables comply with the regulatory inspection authorities and are the responsibility of the customer.
- Do not move or ship equipment unless it is properly packed in its original wrapping and shipping containers.

### Electrical Shock Prevention

- When connecting equipment to the AC and DC voltage supplies, ensure proper polarity.
- Disconnect the power source before installing or maintaining the power wiring.
- Do not operate the equipment if there is any failure or damage to electrical components.
- Do not touch exposed connections, components or wiring when power is on.

- Install the equipment and the grounded DC supply circuits in adjacent cabinets.
- Protect the DC power source with an adjacent circuit breaker.
- The equipment must be properly grounded before attempting to operate or perform any repairs.

### **RF Exposure**

To avoid RF exposure - Installation of antennas must comply with the FCC RF exposure requirements.

### **Radio Interference**

This equipment generates and radiates radio frequency energy and if not installed and used in accordance with the instruction manual, may cause interference to radio communications.

To avoid interferences:

- Avoid conjunction with any other antenna or transmitter.
- In case of Radio Interference: Relocate the antenna and Increase separation between the equipment and the receiver (e.g. connect to a separate circuit or outlet).
- When using an external antenna, the external antenna must not be co-located or operating in conjunction with any other antenna or transmitter

*NOTE: This equipment has been tested and found to comply with the limits for a Class B digital device, pursuant to part 15 of the FCC Rules. These limits are designed to provide reasonable protection against harmful interference in a residential installation. This equipment generates uses and can radiate radio frequency energy and, if not installed and used in accordance with the instructions, may cause harmful interference to radio communications. However, there is no guarantee that interference will not occur in a particular installation. If this equipment does cause harmful interference to radio or television reception, which can be determined by turning the equipment off and on, the user is encouraged to try to correct the interference by one or more of the following measures:*

*-Reorient or relocate the receiving antenna.*

*-Increase the separation between the equipment and receiver.*

*-Connect the equipment into an outlet on a circuit different from that to which the receiver is connected.*

*-Consult the dealer or an experienced radio/TV technician for help.*

*Note:* Contention Based Protocol (CBP) MUST be activated for the specified band (3.675-3.700GHz) wherever FCC rules and regulations are enforced. Failure to comply makes the operation of this device illegal.



## Table of Contents

---

<b>1</b>	<b>Introducing the RNU4000BS BS</b> .....	<b>1</b>
1.1	Coverage Configurations .....	3
1.2	RNU4000BS Interfaces and Accessories.....	5
1.2.1	GPS, Power and Communication Interfaces .....	5
1.2.2	BS RF Antenna Interfaces .....	7
1.3	Supported Antennas.....	7
1.3.1	RF Antennas .....	7
1.3.1.1	Internal Antennas.....	7
1.3.1.2	External Antenna.....	7
1.4	Optional Accessories .....	8
<b>2</b>	<b>WEB GUI description</b> .....	<b>9</b>
2.1	WEB GUI Menu description.....	10
2.2	WEB GUI working screens description .....	10
<b>3</b>	<b>Commissioning Procedure</b> .....	<b>24</b>
3.1	Overview.....	24
3.2	Connect BS to Power and Computer.....	25
3.2.1	Configure the Computer's Network Parameters .....	25
3.2.1.1	Configure Computer IP Address.....	25
3.2.1.2	Disable Firewall .....	28
<b>4</b>	<b>Installing the RNU4000BS BS</b> .....	<b>29</b>
4.1	Mounting the Base Station.....	29
4.1.1	BS Installation Location.....	29
4.1.2	Mounting Bracket Description.....	30
4.1.3	Mounting On a Pole .....	32
4.1.4	Mounting On a Wall .....	34
4.2	Overview of the Cable and Power Connections .....	36
4.3	Mounting the RF Antennas .....	38
4.3.1	Mounting the RF Antenna .....	38
4.3.1.1	RF Antenna Location Criteria .....	38
4.3.1.2	RF Antenna Mounting .....	38
4.3.1.3	4x4 antennas Outdoor Connection Requirements .....	39
4.4	Pole Mounted GPS Antenna .....	40
4.4.1	GPS Antenna Installation.....	41
4.4.2	Criteria for selecting the GPS antenna location .....	41
4.4.3	GPS antenna mounted to the RNU4000BS body .....	41

4.4.4	Multi-sector Daisy-chained GPS Antennas.....	42
4.4.4.1	Hardware Interconnections.....	42
4.4.4.2	Configuration Parameters.....	42
4.5	End-to-End Traffic Test .....	42
4.5.1	Performing a PING Test .....	43
<b>5</b>	<b>Field Test Performance Evaluation.....</b>	<b>44</b>
5.1	Field Test Overview.....	44
5.2	Field Test Setup.....	45
5.3	Field Test Procedure .....	47
<b>6</b>	<b>Technical Specifications .....</b>	<b>49</b>
6.1	RNU4000BS BS Specifications .....	49
6.2	External Dual-Slant RF Antennas Specifications.....	51
6.2.1	Dual-Slant Antenna 2.3-2.7 GHz; 17 dBi; 65° (MT-364054/ND) .....	51
6.2.2	Double-dual Slant 2300-2700 MHz Remote Tilt-Panel Antenna .....	54
6.2.3	Dual-Slant Antenna 2.3-2.7 GHz; 16 dBi; 60° (SP2327-16XP60NUF).....	55
6.2.4	Dual-Slant Antenna 2.3-2.7 GHz; 15 dBi; 90° (SP2327-15XP90NUF).....	56
6.2.5	Dual-Slant Antenna 3.3-3.8 GHz; 17 dBi; 65° (MT-404067/ND) .....	57
6.2.6	Dual-Slant Antenna 3.3-3.8 GHz; 17 dBi; 65° (SP3338-17XP65) .....	58
6.2.6.1	Radiation Patterns .....	59
SP3338-17XP65	elevation plane .....	59
6.2.7	Dual-Slant Antenna 3.3-3.8 GHz; 17 dBi; 90° (SP3338-17XP90) .....	60
6.2.7.1	Radiation Patterns .....	61
SP3338-16XP90	elevation plane .....	61
6.2.8	Dual-Slant Antenna 4.9-5.95 GHz; 16 dBi;90° (MT- 464018/ND) .....	62
6.3	RNU4000BS Internal Antenna Specifications .....	63
6.4	GPS Antenna Specifications .....	64

# **1 Introducing the RNU4000BS BS**

---

Runcom's RNU4000BS fully integrated outdoor WiMAX BS provides flexible, cost-effective WiMAX network deployment solutions where increased capacity and coverage is required.

'All-in-one' architecture combined with simple, single-handed installation and fast rollout make these BSs an ideal solution for operators that want to get in on the ground floor of WiMAX deployment at significant CAPEX reductions and maximum return on their network deployment.

The RNU4000BS is designed for coverage flexibility: depending on the required scenario, the same BS can be configured to cover more sectors with relatively sparse concurrent user requirements or fewer sectors with higher needs.

RNU4000BS BSs provide adaptable solutions, allowing interoperability with other MSS devices as well as ASN-GW vendors.

## Features

- All-in-one integrated packaging of RF and Baseband components.
- Full compliance with IEEE802.16e-2005 according to the WiMAX Forum profiles.
- Frequency Bands (model dependent): 705–745MHz, 1.6-1.8GHz, 2.3-2.7GHz, 3.3-3.8GHz (**CBP capability for band 3.675-3.700GHz is required**), 4.9-5.0GHz other bands are optional.
- Supports MIMO 2x2, HARQ, and other state of the art features which increase performance.
- 4 channels ready unit – 2 channels supplied by default can be license-key activated for 4 channels.
- Transition Power – 2 or 4 x Tx, 28dBm each.
- Antenna support - model dependent: either four external or internal antennas.
- Integrated GPS receiver for time and clock synchronization with holdover for satellite signal loss.
- Flexible coverage capabilities – greater coverage area or greater penetration capabilities
- Small footprint, single-handed quick installation and simple provisioning
- Fast roll-out for service providers
- Seamless and cost-effective integration with a Backhaul network
- Optional integrated backhaul link via WiMAX **R1** interface
- High performance with Quality of Service (QoS) settings, according to WiMax standards.
- Support for the latest **R6** interface and GRE tunneling to ASN-GW
- Remote NMS management via Runcom's NMS application



## 1.1 Coverage Configurations

---

RNU4000BS supports either two or four RF channels and can provide coverage for either one, two or four sectors depending on the sector density (throughput capacity) and radio performance requirements (note that internal antenna can be used for single sector coverage only):

- Single-Sector solution of 4x4 – (for internal and external antennas) – used for higher density sites: four channels for Tx and four channels for Rx MRC. This configuration improves coverage through diversity and improve throughput through MIMO 4x2.
- Dual-Sector solution of 2x2 (only relevant for external antennas) – used for lower populated sites: two channels for Tx channels and two channels for Rx MRC. MIMO of 2x2 can be perform if signal to noise ratio is good.
- Quad-Sector solution of 1x4 (only relevant for external antennas) – used for more sparsely populated sites: single channel for Tx and single channel for Rx. This configuration is highly cost effective but suffer from lower performance and coverage area per sector (totally it covers more space)

The overall capacity, of single base station unit, with respect to the maximum number of connected users, supported bands and throughput is constant; however, in a dual-sector installation, the BS will transmit to two separate sectors in a cell, where each sector is serviced by two antennas. In quad sector installation the BS will transmit to four sectors in a cell (Usually covers the entire cell 360<sup>0</sup>), where each sector is serviced by one antenna. These two configurations reduce CAPEX and OPAX for operators by covering cells with relatively low density or sparsely populations, which have low requirements for concurrent user's and / or lower data traffic.

The following figure shows a single sector covered by 4x Tx/Rx channels. Several of these sectors (within the same site) should be installed, using the corresponding number of RNU4000BSs, to complete site coverage. Each site can use single GPS antenna, installed on one of the BS, daisy-chained from BS to

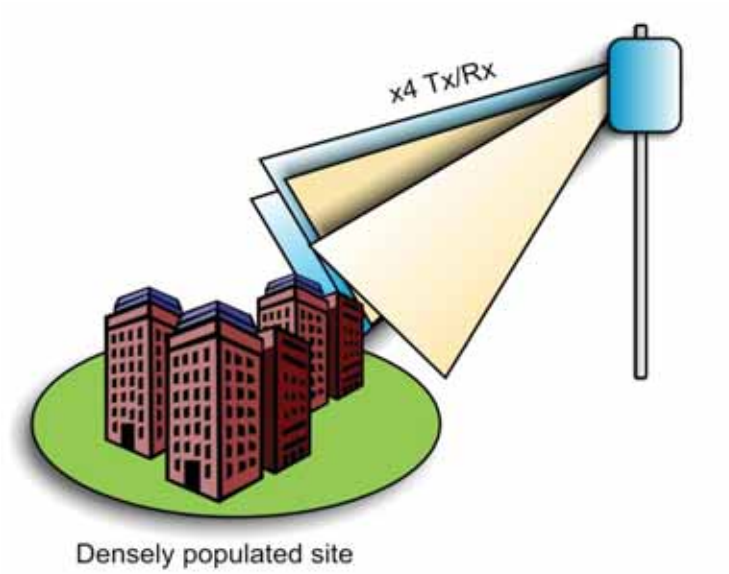

another, to perform

Figure 1 Single Sector Coverage

- The following figure illustrates dual-sector coverage of two sites by a single RNU4000BS unit.

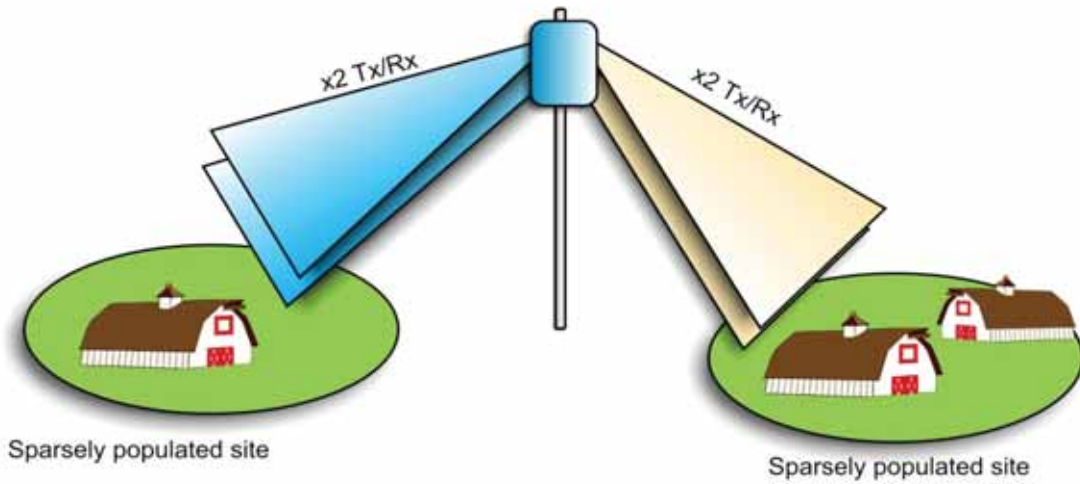

Figure 2 **Dual Sector Coverage**

## 1.2 RNU4000BS Interfaces and Accessories

---

The interfaces of the RNU4000BS BS are distributed over two panels. Each of these panels is referred to according to the corresponding interfaces.

Note: Install the BS so the power, GPS and communication interfaces face DOWN.

---

### 1.2.1 GPS, Power and Communication Interfaces

---

Note: Install the BS on the wall or pole with this panel facing DOWN.

---

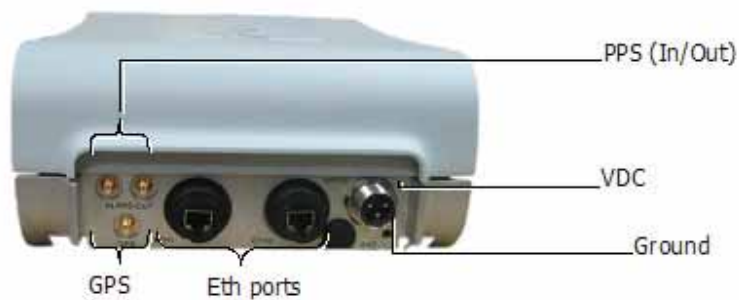

Connector	Description
<b>GPS</b>	Connects to an external (optional) GPS antenna. The GPS antenna is ordered separately. Connector Type: ITT CANNON APD DIN 72585
<b>ETH1</b>	Primary Fast Ethernet connector. Used for initial setup (and standalone tests), and for connection to the backhaul network (in normal installations). Connector Type: RJ-45 TYCO part no 1546907-1
<b>ETH2</b>	<p>Second Ethernet port for local and out-of-band management.</p> <p>In future versions, you will be able to daisy-chain this port to ETH1 in an adjacent Base Station (located in the same BS site) in order to allow a single Ethernet connection to the Backhaul.</p> <p>ETH2 port can also function as a serial port (connection through the cable supplied in the kit). This function is useful if the unit is not accessible via an IP address connection.</p>
<b>PPS</b>	<p><b>PPS In</b> and <b>PPS Out</b> can be used for synchronization of multiple sectors, where the <b>PPS Out</b> of one sector is connected to the <b>PPS In</b> of the next BS (daisy chained). This is relevant only for adjacent sectors at the same BS site. See "Multi - Sector Daisy - Chained GPS antennas" section</p> <p>Connector Type: SMA sealed Industrial</p>
<b>48VDC</b>	Power connector. External DC power connector (48VDC) for outdoor deployment. Connector Type: RJ-45
<b>GND</b>	Ground blind hole connector. In normal installations, connect to the pole on which the unit is mounted. (The BS unit does not include a lightning arrester.)

## 1.2.2 BS RF Antenna Interfaces

- RNU4000BS supports **either** four external **or** four internal antennas. The unit below shows a model supporting four external antennas.
- All antennas (internal and external) are 1W each



Connector	Description
ANT1/2/3/4	External RF connector for the Main external antenna. Connector Type: RJ-45 TYCO part no 1546907 1

## 1.3 Supported Antennas

---

Depending on the model, the RNU4000BS is supplied with four external or four internal dependent.

### 1.3.1 RF Antennas

#### 1.3.1.1 Internal Antennas

Four internal antennas: 12dBi each at an azimuth beam-width of 90 degrees. Refer to specifications in section 6.3.

#### 1.3.1.2 External Antenna

Four external antennas: 15 to 18dBi, azimuth beam-width dependent.

---

Note: Specs for dual-slant antennas described in section 5.2.

---

You may use any other antenna type or model, keeping in mind that the antenna type or model should be based on the RF planning that was performed in preparation for deployment at the specific site and is dependent upon the coverage and throughput requirements of the site.

## 1.4 Optional Accessories

---

The following accessories are **not** provided with the basic kit, and can be ordered as an option.

<b>Element</b>	<b>Description</b>
Power Supply	110-220v AC/DC converter for 48VDC power supply
RF Antenna	External directional antenna with pole mounting kit

## 2 WEB GUI description

Follow by the next steps for BS WEB GUI menu access:

- Open Internet Explorer for access to BS WEB GUI using the BS IP address path

Figure 3 **BS WEB GUI access path**



- Use the BS WEB GUI credential (user name and password) to obtain the BS WEB GUI menu

User name	Password
user	password

Figure 4 **BS WEB GUI ID**



This section describes the WEB GUI RNU 4000 Base Station management options and theirs functionalities indented to provide to user the next necessary abilities:

- General information (BS HW/SW info, IP status)
- Monitoring (Synchronization and BS Sector operation status, CPE Connection list info and their link status)
- Configuration (General RF parameters settings, max. MCS settings and IP settings)
- Maintenance (Upgrade, Recovery and Default)

## 2.1 WEB GUI Menu description

The table below describes the WEB GUI Menu options and their functionalities

Menu		Section	Description
<b>General Information</b>		<b>General</b>	Provides BS related HW/SW info
		<b>IP Status</b>	Provides BS ETH interface IP addresses status
<b>Configuration</b>	<b>General</b>	<b>General</b>	Provides RF parameters and MCS settings
	<b>IP Configuration</b>	<b>IP Configuration</b>	Provides BS related IP addresses settings
<b>Monitoring</b>	<b>Status</b>	<b>Synchronization</b>	Provides BS synchronization status
		<b>BS Status</b>	Provides BS sector configuration status
	<b>Connection</b>	<b>Connection</b>	Provides BS RF parameters configuration status
		<b>Antenna Status</b>	Provides BS antenna configuration status
	<b>CPE Info</b>	<b>CPE Info Query</b>	Provides ability to obtain fast link status connection parameters of specific CPE
<b>CPE List</b>		Provides list of connected CPE's and theirs ID and more detailed connection parameters as link status parameters and theirs SF connection	
<b>Maintenance</b>	<b>Upgrade</b>	<b>SW Upgrade</b>	Provides BS SW upgrade including all SW components
	<b>Recovery</b>	<b>Change Version</b>	Provides swap between BS SW version (current running and the previous one)
	<b>Default</b>	<b>Reset to Default</b>	Provides ability to set the BS to default parameters related to the SW version
		<b>Erase Configuration File</b>	Provides ability to erase the configuration file in case if such file was downloaded to BS

## 2.2 WEB GUI working screens description

**General Information Screen** – The figure below represent the “**General Information**” working screen and provides the next info as described in the table below:

Menu	Section	Description
<b>General Information</b>	<b>General</b>	Provides BS ID related info: <ul style="list-style-type: none"> <li>• HW – Product Type</li> <li>• SW – FW /FPAGA version</li> <li>• BS ID – BS MAC address</li> </ul>
	<b>IP Status</b>	Provides BS ETH interface IP addresses status: <ul style="list-style-type: none"> <li>• BS ETH interface LAN configuration – IP /subnet/ GW address</li> <li>• ASN GW interface configuration - GW IP and Authentication address for connection with BS</li> <li>• ASN BS DHCP client – ENB/DSB</li> </ul>



Figure 5 General Information –working screen

The screenshot displays the Runcom Technologies Ltd. web interface. At the top left is the Runcom logo. The top right corner features a 'Logout' link. A navigation menu on the left includes 'MENU' and 'General Information' (highlighted). Below the menu, there are sections for 'Monitoring', 'Configuration', and 'Maintenance'. The 'STATUS' section provides the following information:

- BS IP : 192.168.0.23
- BS MAC : 00:25:37:F0:05:84
- BS ID : 00:25:37:F0:05:84
- Ext 1PPS lock status : **LOCK**
- Modem status : Running
- Frequency : 2560000 kHz
- BW profile : 32:15 10 MHz
- Tx Power : -15 dBm
- Initial noise : -125 dB
- Temperature : 54.5 C
- Connected CPEs : 1
- Sys uptime : 0 days 0h:3m:6s

A 'Reset' button is located at the bottom of the status section. The main content area is divided into two sections:

**General**

SW bin Version	Release 03.29.64.01
FPGA Version	0x10121417, (SVN: 2493)
MAC address	00:25:37:F0:05:84
Product type	RNU4000PB
RF Type	Wakonda 2.5GHz
HTML bundle version	12011016
Boofter version	Release 03.00.28.01 IEEE BS BOOT

**IP Status**

IP Address	192.168.0.23
Subnet Mask	255.255.255.0
Gateway IP Address	192.168.0.100
ASN Gateway IP	192.168.0.3
Authenticator IP	192.168.0.3
DHCP client	Disable

**Monitoring screen** –The figures below represent the “Monitoring” working screens and provides the next info as described in the table below:

Menu		Section	Description
Monitoring	Status	Synchronization	<p>Provides the BS synchronization operational and configuration status:</p> <ul style="list-style-type: none"> <li>• 1PPS lock status– “Lock” or “Unlock” indicates the 1PPS BS GPS synchronization status</li> <li>• Modem status – indicates the BS RF status: <ul style="list-style-type: none"> <li>- “running” BS RF activated / normal BS operation</li> <li>- “Not running” BS RF inactivated / BS is not operational, management is available</li> </ul> </li> <li>• 1PPS source – indicates the 1PPS source configuration (see figure “1PPS synchronization source configuration” below) <ul style="list-style-type: none"> <li>- “GPS via Antenna” default configuration</li> </ul> </li> <li>• Physical connection status – “Connected” or “Not Connected”- indicates physical connection status of BS external connectors “1PPS input” or “GPS”</li> <li>• GPS lock status – “Lock” or “Unlock” indicates the BS GPS lock status</li> <li>• GPS initialization status – “Initialized” or “Failed” indicates the BS GPS initialization status</li> <li>• Hold over time – “0sec to 14400sec indicates the time of Hold over timer. The timer starts once the BS GPS loss the 1PPS synchronization “Unlock” <ul style="list-style-type: none"> <li>- “14400 sec” default</li> </ul> </li> <li>• Hold over time expired – “Not expired” or “expired” indicates the Hold over timer status</li> </ul> <p>- Once the timer is expired (14400sec), the BS RF becomes inactivated and that is in order to prevent interference to other BS’s.</p> <ul style="list-style-type: none"> <li>• Sync change state counter – counting indicates the BS GPS 1PPS synchronization “unlock” states number “</li> </ul>
		Radio Status	<p>Provides BS sector configuration status info:</p> <ul style="list-style-type: none"> <li>• Max DL Modulation</li> <li>• Max DL Modulation</li> <li>• Initial Noise – BS receiver initial noise indicates spectrum radio channel quality of the BS working frequency</li> </ul> <p>Note: Desirable is to obtain initial noise figure less than - 117dbm</p> <ul style="list-style-type: none"> <li>• Initial TX power</li> </ul>
	WiMAX	Connection	<p>Provides BS connection status info:</p> <ul style="list-style-type: none"> <li>• BS ID – indicates the BS ID</li> <li>• Frequency – indicates the BS central working frequency</li> <li>• Bandwidth Profile – indicates the radio BW and the TX/RX symbols ration</li> <li>• Preamble ID – indicates the BS preamble ID</li> <li>• No. connected UT’s – indicates the quantity of connected CPE’s to the BS</li> <li>• No. of known NBR Bases – Handover feature / indicates the quantity of recognized by BS other neighbor BS’s</li> </ul> <p>Note: N/A for current BS WEB GUI version</p>

Menu		Section	Description
		<b>Antenna Status</b>	Provides BS antenna configuration status: <ul style="list-style-type: none"> <li>• TX ON/OFF – indicates the BS configuration status of each one transmitter (4 independent transmitters)</li> <li>• RX ON/OFF – indicates the BS configuration status of each one receiver (4 independent receivers)</li> </ul>
	<b>CPE Info</b>	<b>CPE Info Query</b>	Provides ability to obtain fast link status connection parameters of specific CPE per CPE MAC address: <ul style="list-style-type: none"> <li>• UL/DL FEC code type (see table below)</li> <li>• UL/DL CINR</li> <li>• UL RSSI</li> <li>• Max UL subchannel and slots</li> <li>• UL Repetition no.</li> <li>• UL Headroom – remaining CPE TX power</li> </ul>
		<b>CPE List</b>	Provides list of connected CPE's ,theirs ID's and more detailed connection info as link status and SF connection parameters: <ul style="list-style-type: none"> <li>• Double click on "INFO" in order to obtain Radio Link status parameters and SF parameters</li> </ul>

FEC Code Type	Modulation
13	QPSK 1/2
15	QPSK 3/4
16	QAM 16 1/2
17	QAM 16 3/4
18	QAM 64 1/2
19	QAM 64 2/3
20	QAM 64 3/4
21	QAM 64 5/6

Figure 6 Monitoring Status– working screen



Figure 7 Monitoring WiMAX– working screen



Figure 8 Monitoring CPE info /CPE list – working screen



Figure 9 Monitoring CPE info / link status – working screen



**Configuration screen** –The figures below represent the “**Configuration**” working screens and provides the next info as described in the table below:

Menu	Section	Description
<b>Configuration</b>	<b>General</b>	<ul style="list-style-type: none"> <li>• Provides RF parameters and MCS settings</li> <li>• Provides defined neighbors BS for HO</li> </ul> Double click on one of the defined neighbors BS from the list in order to obtain the dialog box for define or update the neighbors BS
	<b>IP Configuration</b>	Provides BS ETH interface IP addresses settings: <ul style="list-style-type: none"> <li>• BS ETH interface LAN configuration – IP /subnet/ GW address</li> <li>• ASN GW interface configuration - GW IP and Authentication address for connection with BS</li> </ul> Note: <ul style="list-style-type: none"> <li>- All ASN related IP configuration in BS should be accordantly to ASN GW configuration</li> <li>- Recommended default BS ASN GW and Authentication IP static address is <b>192.168.0.3</b></li> </ul> <ul style="list-style-type: none"> <li>• BS DHCP client – ENB/DSB(ASN GW is DHCP server)</li> </ul> Note: Normal configuration /static IP configuration DHCP is “DSB”
	<b>Stand Alone</b>	Provide the ability to set the BS network interface operation mode
	<b>Service Flow Profile</b>	Double click on one of the defined Service Flow profiles from the list in order to obtain the dialog box for define or update the Service Flow profiles
	<b>CPE Binding</b>	Double click on one of the defined CPE binding list in order to obtain the dialog box for binding or update the desirable Service Flow profile with CPE
	<b>Multicast Binding</b>	Double click on one of the defined Multicast Binding CPE list in order to obtain the dialog box for Multicast binding or update

Figure 10 Configuration - General screen



Figure 11 Configuration – HO neighbors BS definition screen



Figure 12 Configuration - IP Configuration screen



Figure 13 Configuration – Stand Alone screen

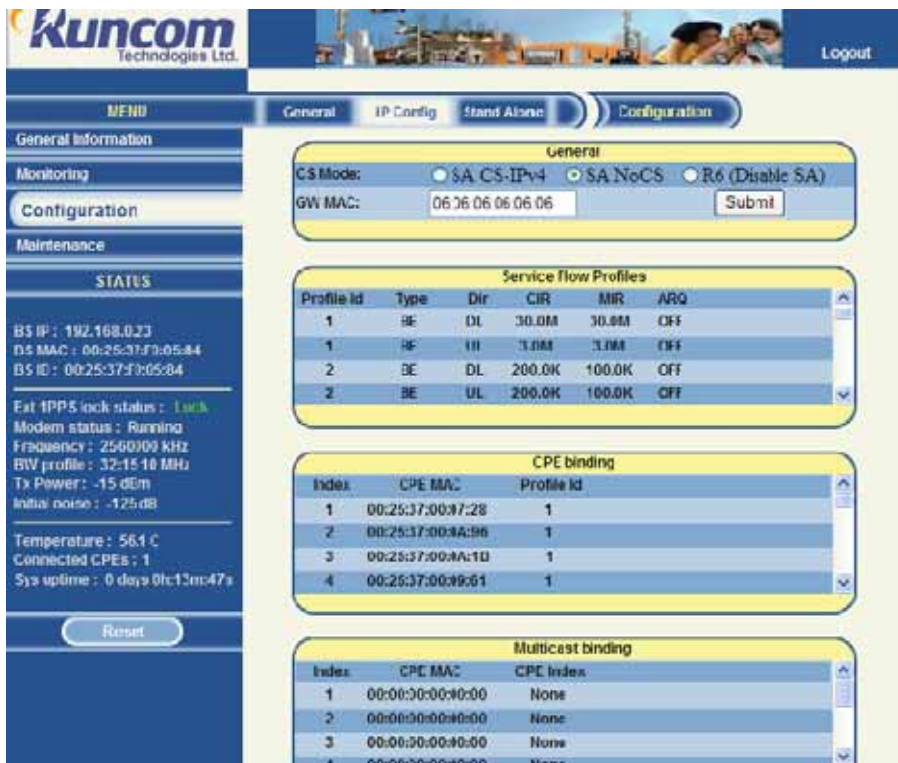



Figure 14 Configuration – Multicast user definition screen



Figure 15 Configuration – CPE network connection screen



Figure 16 Configuration – Service flow profile definition screen

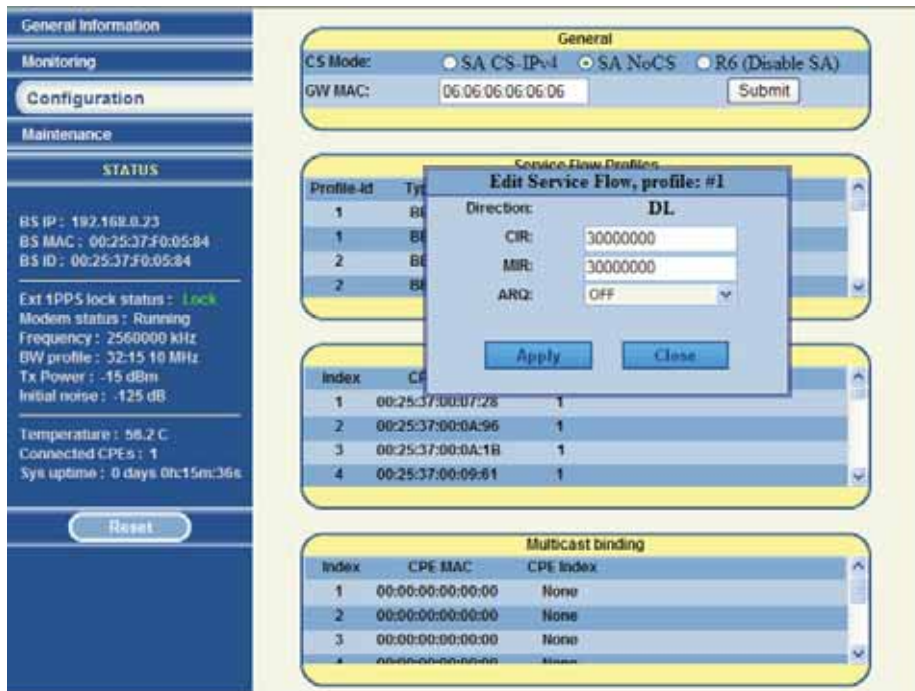

Figure 17 Configuration – CPE to Service flow profile setting screen



**Maintenance screen** –The figures below represent the “Maintenance” working screens and provides the next info as described in the table below:

Menu	Section	Description	
Maintenance	Upgrade	<b>SW Upgrade</b> Allows BS SW upgrade including all SW components: <ul style="list-style-type: none"> <li>• SW bin – BS SW FW file (required)</li> <li>• FPGA – (required)</li> <li>• HTML bundle – (required) WEB GUI application file</li> <li>• Cfg. file – (Optional) BS configuration file which includes the all BS configuration parameters to be set to obtain BS required configuration</li> </ul>	
	Banks	<b>Change Version</b> Allows swap between BS SW version (current running and the previous one)	
	Default	<b>Reset to Default</b>	Allows ability to set the BS to default parameters related to the SW version
		<b>Erase Configuration File</b>	Allows to erase the configuration file in case if such file was downloaded to BS
Configuration File	<b>Configuration File</b>	Allows to upload and viewing the configuration file	

Figure 18 Maintenance Upgrade screen

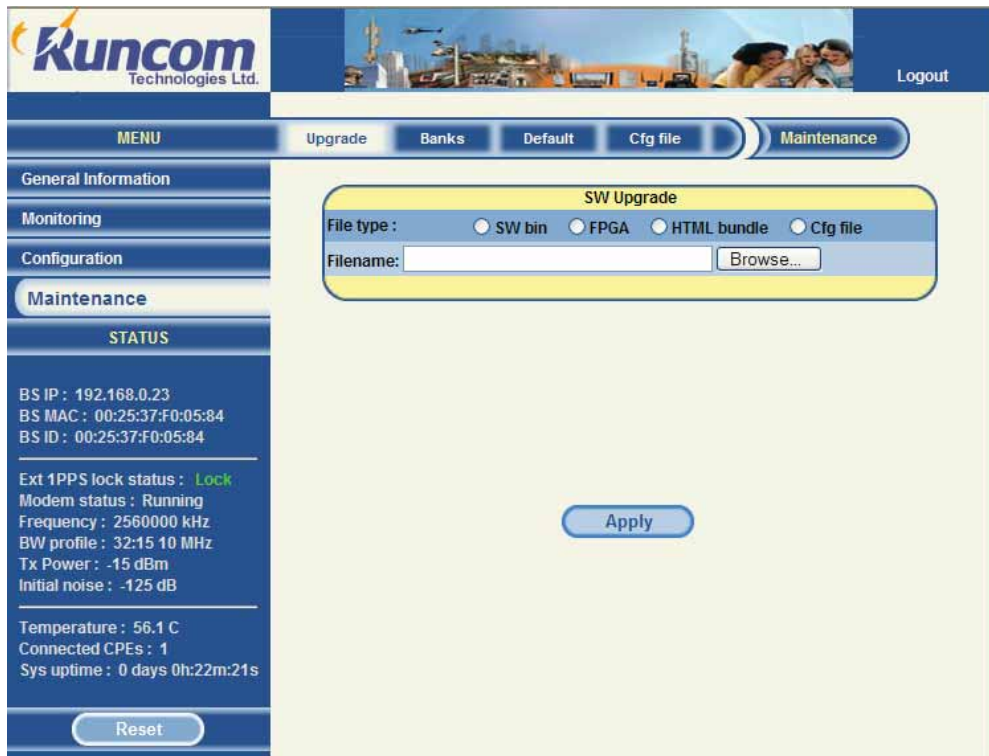

Figure 19 Maintenance Banks screen



Figure 20 Maintenance Default screen



Figure 21 Maintenance – Configuration profile file screen



# 3 Commissioning Procedure

## 3.1 Overview

Before mounting the RNU4000BS BS on a pole or wall, power should be connected to the BS and the basic parameters configured with the basic parameters using the BS WEB GUI.

**ATTENTION!!! BE SURE THE RF ANTENNAS ARE CONNECTED OR THE RF PORTS ARE TERMINATED BEFORE CONNECTING POWER TO THE UNIT.**

The BS commissioning procedure consists of the following steps:

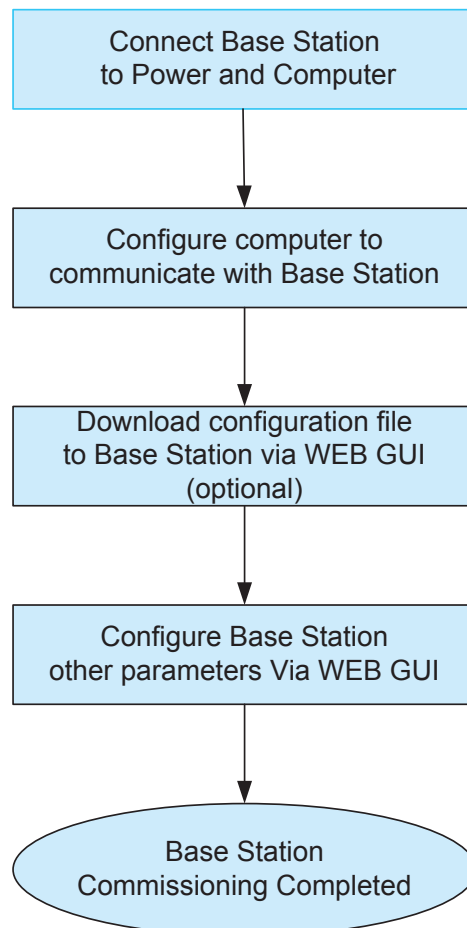

## 3.2 Connect BS to Power and Computer

---

**ATTENTION!!! BE SURE THE RF ANTENNAS ARE CONNECTED OR THE RF PORTS ARE TERMINATED BEFORE CONNECTING POWER TO THE UNIT.**

To commission the BS unit two setup connections are required:

- Power - Use the provided (BS) power cable to connect the BS **VDC Power** connector to an indoor 48 VDC power supply.
- Computer – Connect the BS **ETHER** port to the computer running the WEB GUI application.

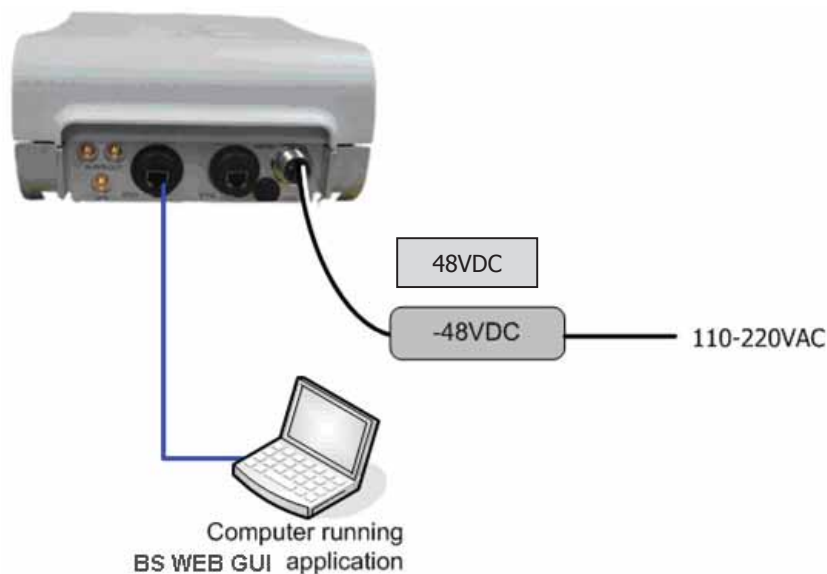

Figure 22 **BS Commissioning Setup**

### 3.2.1 Configure the Computer's Network Parameters

In order to establish communication between the computer and the BS perform the following:

- Assign computer IP address in the same subnet as the BS
- Disable Firewall

#### 3.2.1.1 Configure Computer IP Address

To configure IP address follows the next steps:

---

Note: The procedure may vary slightly depending on the operating system installed on the computer. The following procedure is for Windows XP.

---

1. Click the **Start** menu and choose **Network Connections**.
2. Right-click the **Local Area Connection** corresponding to the BS connection and select **Properties**.

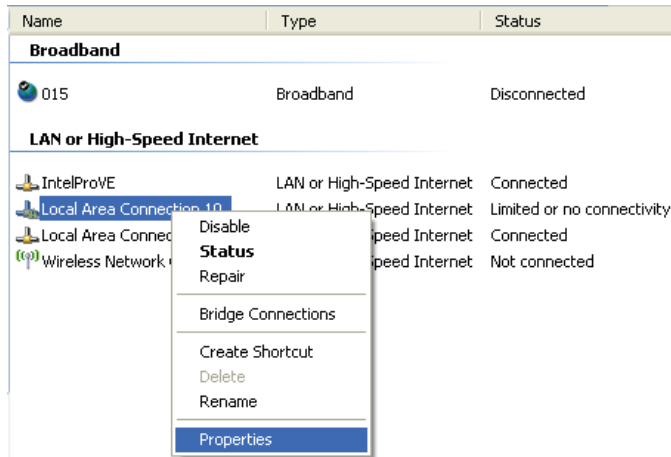

The *Local Area Connections* Properties dialog appears with the General tab displayed by default.

3. In the Items list, select **“Internet Protocol (TCP\*IP)”** and click the **Properties** button.

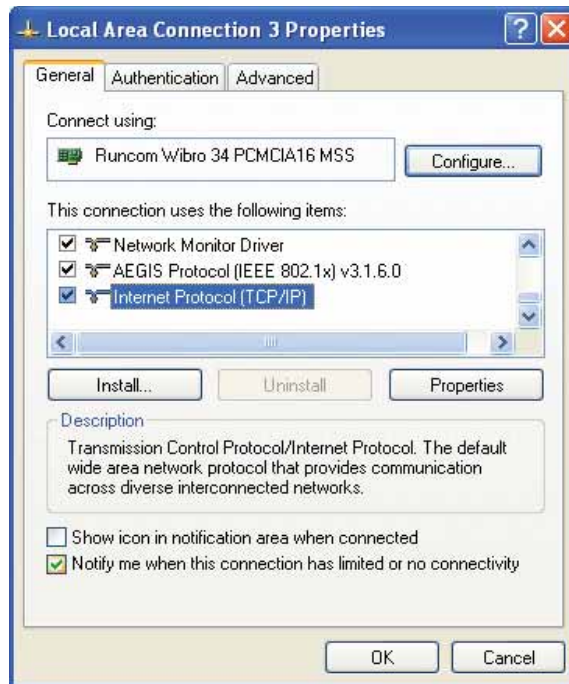

The “Internet Protocol (TCP/IP) Properties” dialog appears.



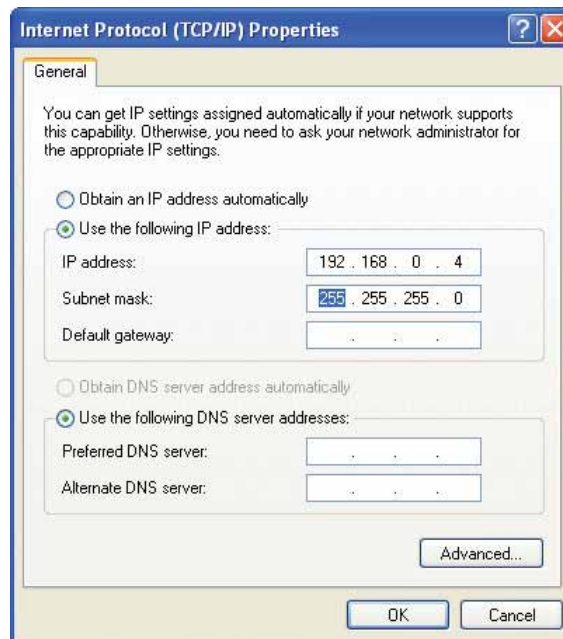

4. In the **IP Address** display area:
  - In the **IP address** field assign an IP address other than the BS IP address (Default BS IP Address: 192.168.0.20).
  - In the **Subnet mask** – set the subnet to the same subnet as the BS (Default BS Subnet: 255.255.255.0).  
(It is not required to define the Default Gateway).
5. Click **OK**.

### 3.2.1.2 Disable Firewall

To disable firewall follow the next steps:

1. In the **Local Area Connection** dialog, click the **Advanced** tab. The following dialog appears.

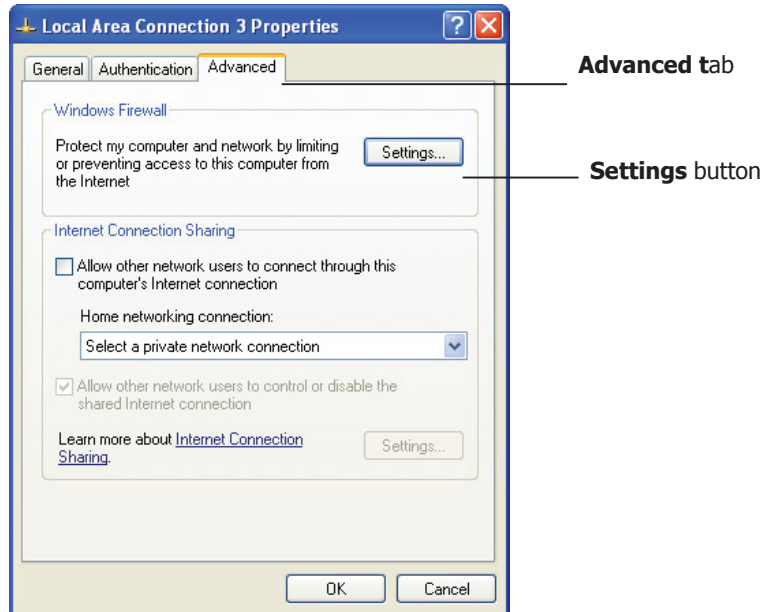

2. In the *Windows Firewall* display area click the **Settings** button. The **Windows Firewall** dialog appears.



3. Select the **Off** option and click **OK**.

## 4 Installing the RNU4000BS BS

---

After commissioning the RNU4000BS BS, the unit is ready for installation.

### The procedure consists of the following steps:

- Choosing the installation location and mounting the BS on a pole or on a wall
- For models with external RF antennas, mounting the RF antennas in the appropriate locations
- Mounting the GPS antennas in the appropriate locations
- Connecting the RF antenna to the BS
- Assembling the GPS antennas to the BS using the provided bracket
- Connecting Ground, Power and ETH cables to the BS
- Performing an End-to-End traffic test

### 4.1 Mounting the Base Station

---

The RNU4000BS BS is provided with a mounting kit which includes all the mounting elements (e.g. mounting-bracket, torques, screws etc.). The BS can be mounted either on a pole or on a wall.

---

Note: The same mounting bracket is used for the wall and the pole installation.

---

#### When mounting the BS, note the following

- The RNU4000BS BS is typically installed in an upright vertically aligned position with the power, Ethernet and GPS connectors facing DOWN.
- The RNU4000BS BS should be installed on the rear side of the RF antenna to prevent self-reflections.

#### 4.1.1 BS Installation Location

This section describes the criteria that should be considered when selecting the RNU4000BS BS installation location. The BS can be mounted on either a pole or a wall.

#### To choose BS Installation location

- Verify that the pole/wall location corresponds to the site plan and takes into account local regulations and maintenance access.
- The unit should be mounted in the highest possible point. Reception will increase according to the height of the antennas.
- The diameter of the pole on which the base station and antenna are to be mounted is either:
  - 1.00-1.75" or
  - 1.75-3.00"
- Verify that the pole is properly grounded.
- Verify that the pole has lightning protection.
- Verify that there is safe access to the pole, free of any obstacles or other danger for installers of the RNU4000BS BS.

- Verify that there are no power lines near the pole.



### 4.1.2 Mounting Bracket Description

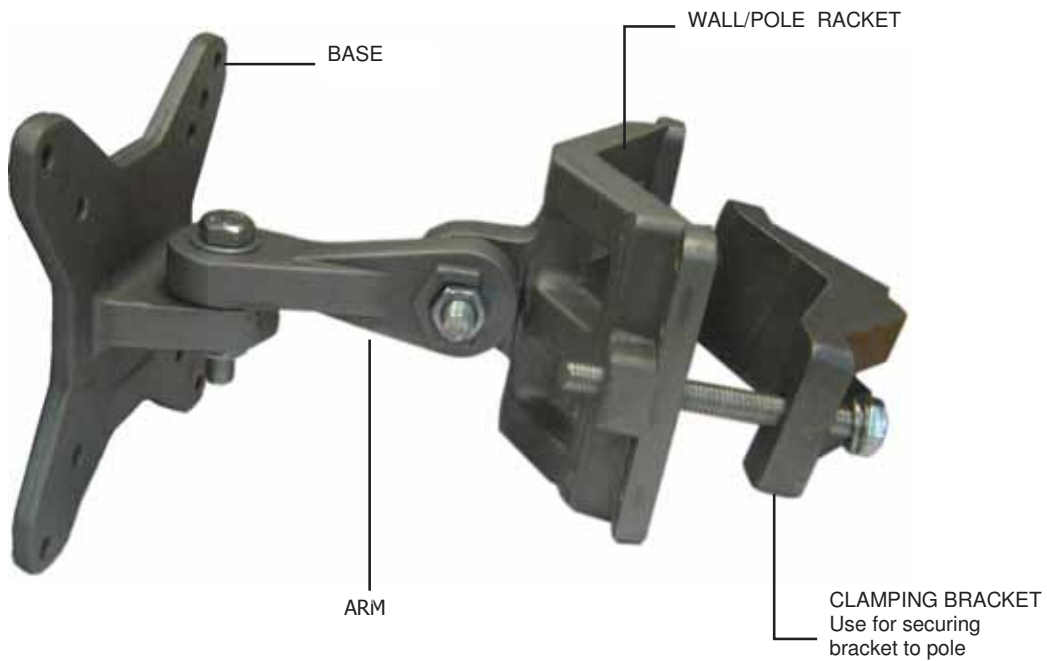

The figure below shows the BS mounting bracket.

**Note:** The same mounting bracket is used for the wall and the pole installation.



The Bracket elements are described in the following table.

Element	Description
	BRACKET BASE. This part is connected to the BS.
	BRACKET ARM. This part provides the tilt ability, and connects between the Bracket BASE and MAIN SUPPORT.

Element	Description
	<p>WALL/POLE BRACKET Used for connecting the bracket to the wall.</p>
	<p>CLAMPING BRACKET Used for securing the bracket to the pole.</p>
	<p>Provided screws, nuts and washers:</p> <ul style="list-style-type: none"> <li>A. 4x flat washer M5</li> <li>B. 4x nut M5</li> <li>C. 4x spring washer M5 (seems as flat washers)</li> <li>D. 4x bolt M8x50</li> <li>E. 4x washer spring M8</li> <li>F. 4x washer flat M8</li> <li>G. 2x nut M8</li> <li>H. 2x bolt M8x70</li> <li>I. 4x bolt M5x16 - missing</li> </ul>

### 4.1.3 Mounting On a Pole

Note: When installing on a pole, leave at least 40cm space between the BS and the top of the pole for lightning protection.

---

#### To install the BS on a pole

1. Secure the **BracketBase** to the BS underside:
  - Secure the **Bracket Base** to the underside of the BS, using the provided screws, as shown below:



- Verify that the orientation of the hole in the **BASE** is aligned with the elevation axis.
- Use a tightening torque of 5.7N/m to tighten.

2. Assemble the bracket elements:
  - Secure the **WALL/POLE BRACKET** to the **Bracket Arm** and then to the **BracketBase** using the provided screws, as shown below:

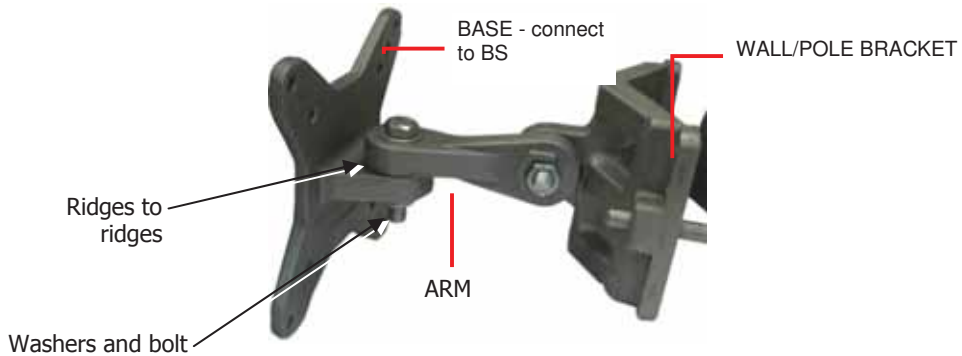

---

**Note:** The bolt head should be positioned in the socket on the Bracket BASE.

---

- Use a tightening torque of 24 N/m to tighten.
3. Mount the BS on the pole, where the procedure varies slightly according to the pole diameter:

**For poles with a diameter of 1.75-3.00”:**

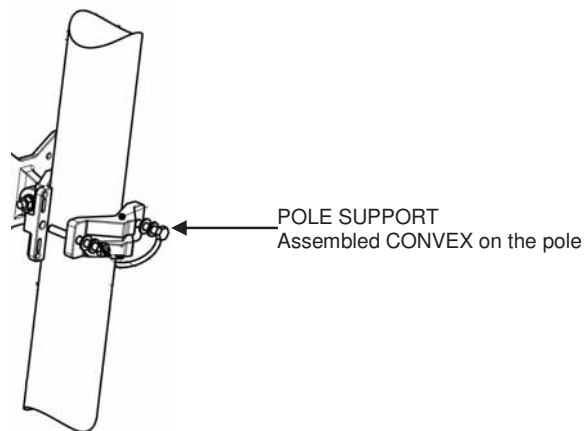

- Mount the BS on the pole using the bracket **Pole Support** as shown above. Assemble the bracket CONVEX as shown.
- Tighten the bracket using the provided screws, according to the pole diameter.
- Use a tightening torque of 14N/m to tighten.

**For poles with a diameter of 1.00-1.75”:**

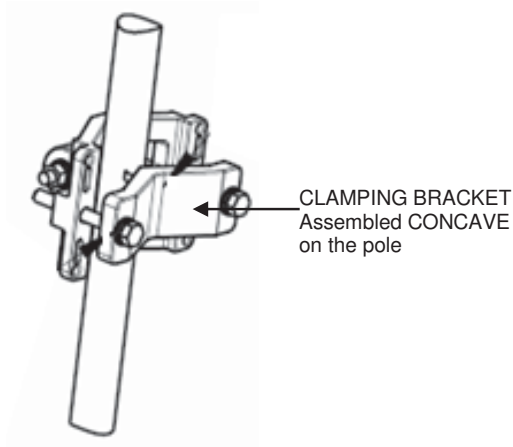

- Mount the BS on the pole using the **Clamping Bracket** as shown above. Assemble the bracket **CONCAVE** as shown.
- Tighten the bracket using the provided screws.
- Use a tightening torque of 14N/m to tighten.

#### 4.1.4 Mounting On a Wall

1. Secure the **BracketBase** to the BS underside:

- Secure **Bracket Base** to the underside of the BS, using the provided screws, as shown below:



- Verify that the orientation of the hole in the **BASE** is aligned with the elevation axis.
  - Use a tightening torque of 5.7N/m to tighten.
2. Assemble the bracket elements:
- Secure the **Bracket Arm** to the **BracketBase** using the provided screws, as shown below:



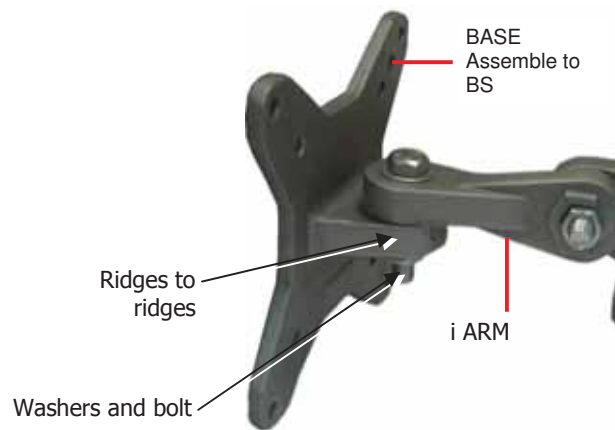

---

**Note:** The bolt head should be positioned in the socket on the Bracket BASE.

---

3. Mount the BS on the wall:
  - Mount the **WALL/POLE BRACKET** on the wall in the appropriate position. Note the azimuth orientation when doing so.

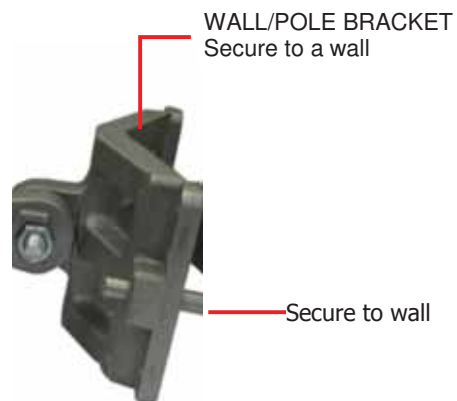

- Attach the **Bracket Arm** to the **WALL/POLE BRACKET** using the provided screws.

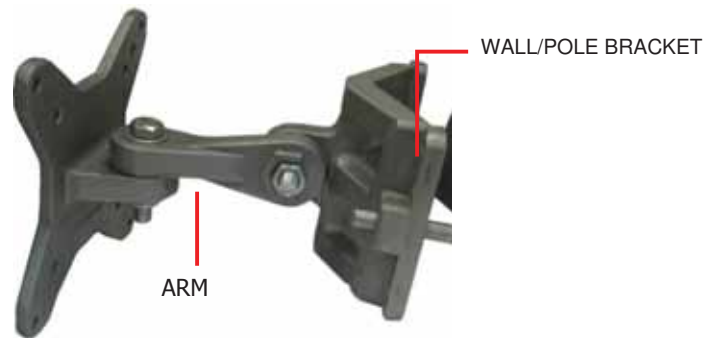

---

**Note:** The bolt head should be positioned in the ARM socket.

---

- Use a tightening torque of 24 N/m to the azimuth and elevation hardware.

## 4.2 Overview of the Cable and Power Connections

---

This section provides a summary of the cable connections. Mounting and connections are described in detail in the following sections.

### BS Connections:

**ATTENTION!!! BE SURE THE RF ANTENNAS ARE CONNECTED OR THE RF PORTS ARE TERMINATED BEFORE CONNECTING POWER TO THE UNIT.**

- **RF Antennas:**(For models with external RF antennas). Connect coax cables from each RF antenna to the base station ports **ANT1/ANT2/ANT3/ANT4**.
- **GPS Antenna:** Connect a coax cable (10 meters max) from the **GPS** antenna to the **BS GPS** connector.
- **Ground:** Use the provided grounding cable to **ground** the BS to the pole (if pole is grounded), or to a grounding point.
- **Power:** Run the 5-10 meter power cable from the BS **Power** connector down the pole, to the provided 48 V power converter that is located indoors (i.e. in a building or in a caravan).

---

Note: It is recommended to connect a battery (for backup) to the 48VDC power supply.

---

- **Ethernet:** Run the 5-10 meter Ethernet cable of the base station from the **ETH** connector at the bottom of the base station down the pole and connect it to an indoor Ethernet connector, such as in a building or in a caravan

If necessary, secure the cables to the pole so that it is not loose using plastic strips.

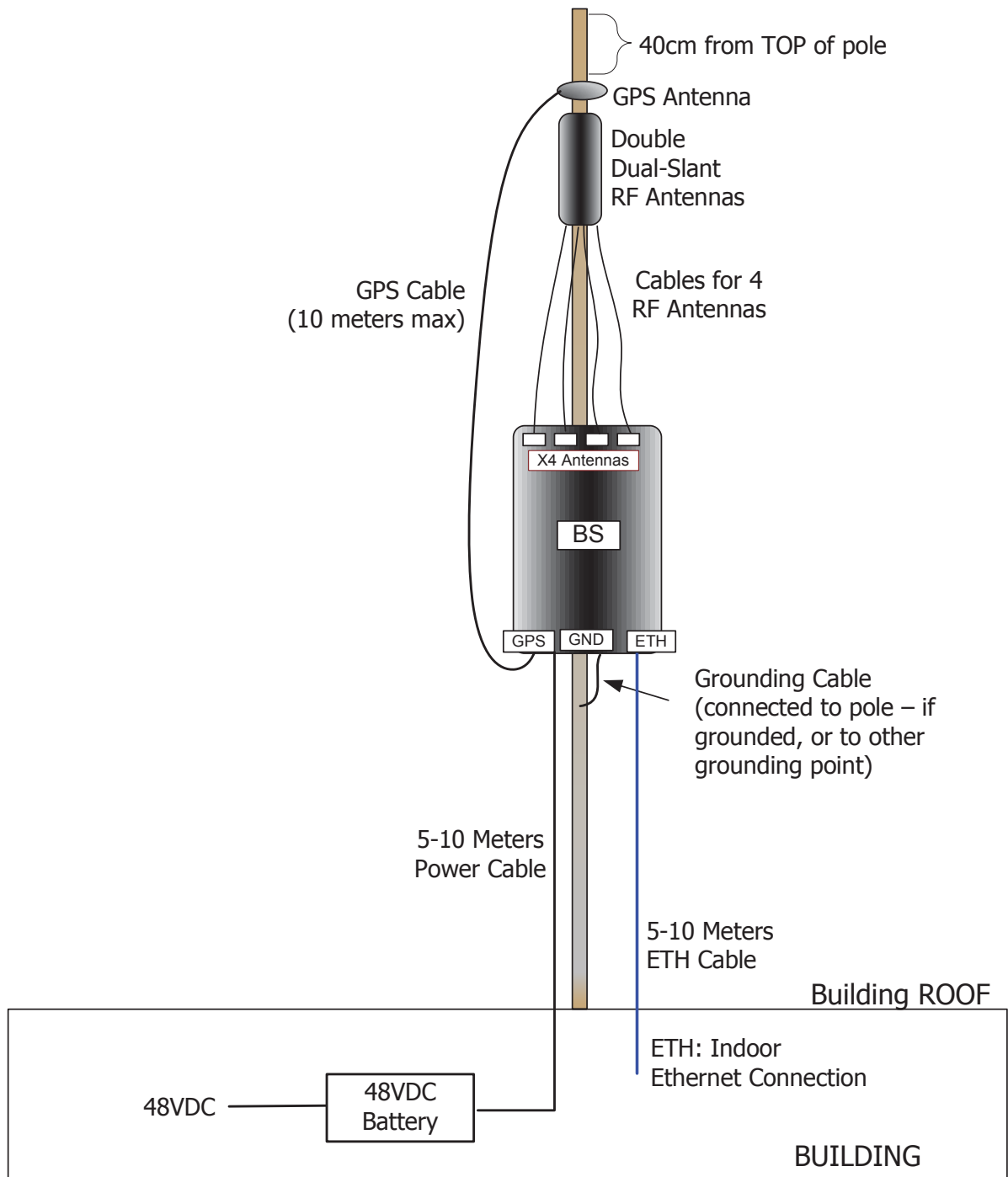

Figure 23 Overview BS Connections

---

## 4.3 Mounting the RF Antennas

---

After mounting the base station on a pole or wall:

- For models with external RF antennas, mount the RF antennas in the selected locations according to the instructions given in this section.
- Mount the GPS Antenna in the selected locations according to the instructions given in this section.

### 4.3.1 Mounting the RF Antenna

---

Note: This section is relevant only for installations of BSs with external antennas.

---

Refer to section 1.1 for more information on antenna configurations.

#### 4.3.1.1 RF Antenna Location Criteria

- To avoid frequency reuse problems caused by unwanted reflections, the main part of the antenna must be clear of any metal objects for a range of parameter to 20 meters.
- Make sure that there are no obstacles located in front of the RF antenna, such as poles, transmission equipment from other vendors or another Runcom RF antenna.

#### 4.3.1.2 RF Antenna Mounting

---

Note: The antenna is mounted and adjusted using the provided antenna mounting kit.

---

##### To mount the RF Antennas:

- Use the supplied **RF antenna (pole) mounting kit** to attach the antenna to the pole.
- Connect the antennas to the BS using the provided **0.5 -1 meter coax cables**.
- Tilt the antenna as required. The antenna's mounting kit enables the antenna to be tilted along two axes.
- The antenna position can be fine-tuned at a later stage.



Figure 24 **RF Antennas Mounting**

### 4.3.1.3 4x4 antennas Outdoor Connection Requirements

Pico BS 4x4 antennas require using Antennas Dual Slant type (with polarization).

Antennas connection should be accordingly:

- BS "Ant 1" connector → connected via RF cable →to Antenna 1 "Port 1" or "ANT1" connector
- BS "Ant 2" connector → connected via RF cable →to Antenna 2 "Port 1" or "ANT1" connector
- BS "Ant 3" connector → connected via RF cable →to Antenna 1 "Port 2" or "ANT2" connector
- BS "Ant 4" connector → connected via RF cable →to Antenna 2 "Port 2" or "ANT2" connector

Note: Reason for Requirement is to obtain proper downlink throughput ,each BS TX stream should be with different polarity

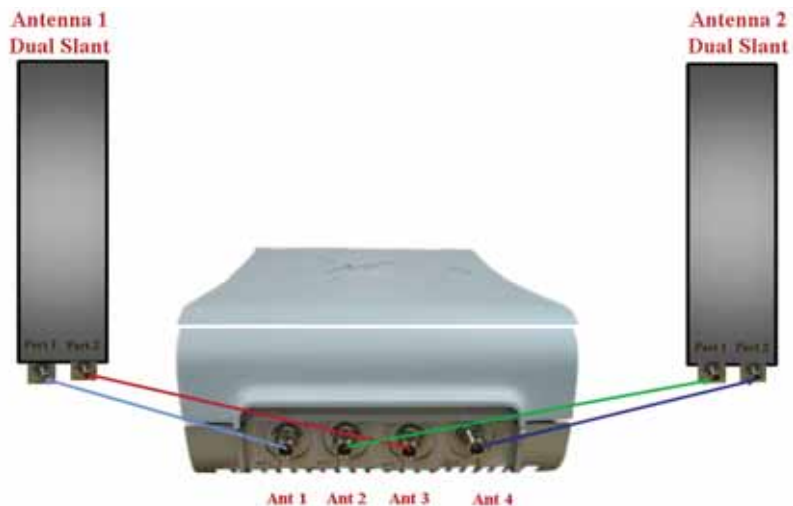

Figure 25 **BS Antennas Connection**

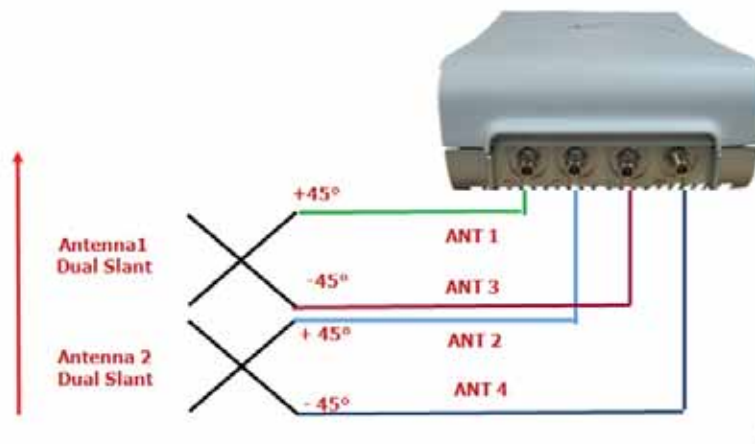
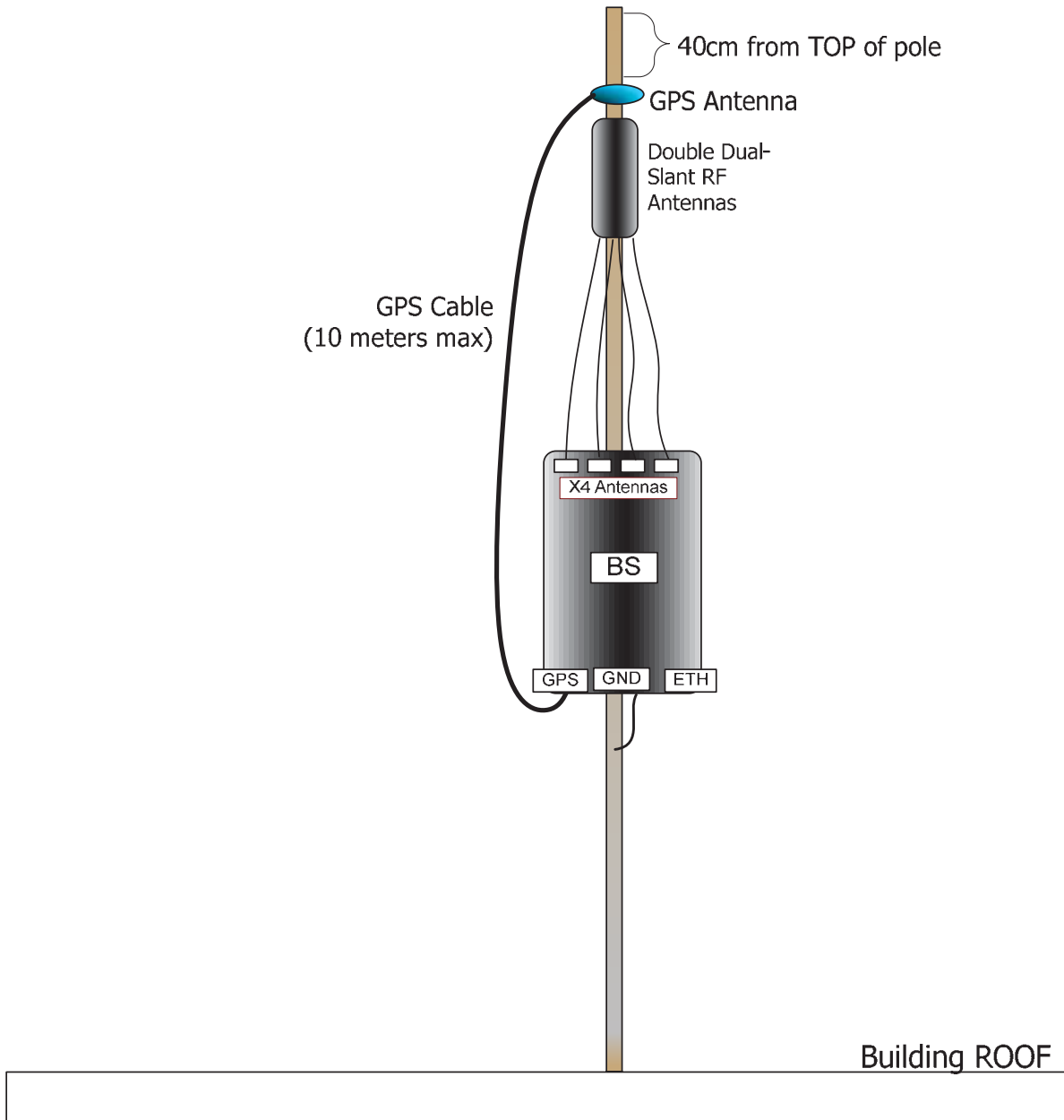

Figure 26 **BS Antennas Polarization Connection Description**

## 4.4 Pole Mounted GPS Antenna

The following is an example of a pole mounted GPS antenna for single-sector coverage.



#### 4.4.1 GPS Antenna Installation

The GPS active antenna may be mounted using two different methods:

- Attached to a pole or other hosting surface using a magnet
- Mounted to the RNU4000 unit using the supplied bracket.

For coverage of multi-sector sites using a number of BSs, one GPS antennas can serve a number of interconnected and synchronized BSs.

The Pole and bracket mounting methods as well as the multi-sector GPS coverage are described in this section.

---

Note: The Holdover time (duration that BS synchronization is retained – from the point in time in which the GPS antenna is disconnected) is determined by the internal GPS. Currently – approximately 8 hours.

---

#### 4.4.2 Criteria for selecting the GPS antenna location

- The whole **antenna area** is exposed to the sky.
- GPS antenna should not be more than 10 meters from the RNU4000BS (excessive cable length may cause interference). Bracket Mounted GPS Antenna

The GPS antenna can be assembled on to the RNU4000BS unit using the supplied.

#### 4.4.3 GPS antenna mounted to the RNU4000BS body

- Assemble the bracket to the underside of the unit as illustrated in the following image.
- Connect the GPS antenna to the RNU4000BS **GPS** connector using a coax cable.
- Assemble the GPS antenna to the bracket as illustrated.



Figure 27 **GPS Antenna to Bracket Connections**

#### 4.4.4 Multi-sector Daisy-chained GPS Antennas

This section describes how to connect and synchronize GPS antennas for multi-sector sites covered by a dedicated RNU4000BS unit per site (x4 Tx/Rx channels per site).

The BSs can be connected in two configurations:

- One GPS antenna can serve all the BSs
- For redundancy - each BS can operate with a dedicated GPS antenna.

##### 4.4.4.1 Hardware Interconnections

The figure below illustrates a daisy-chain configuration for a four-sector base station site with four RNU4000 units. Each unit has an integrated GPS module, and an internal holdover circuit responsible for providing a 1PPS signal in case of loss of PPS source (from either the integrated GPS unit or the PPS IN port).

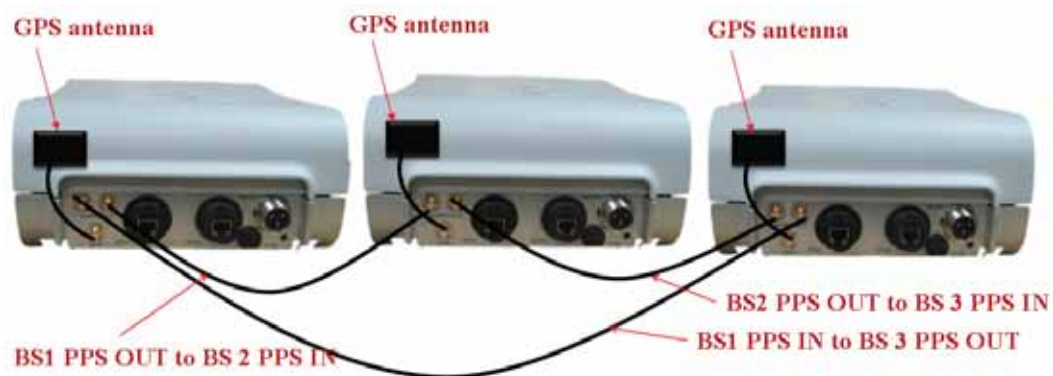

Figure 28 **GPS Synchronization Connection - (daisy-chain)**

##### 4.4.4.2 Configuration Parameters

For synchronization configuration and indication details description parameters refer to "WEB GUI" section.

## 4.5 End-to-End Traffic Test

After the system is installed, it is recommended to perform an End to End (E2E) test to test communication and traffic transference over the link.

In this test, a computer connected to a CPE (that is configured to operate with the BS) sends a ping message towards the NOC (Network Operations Center) and AAA (Authentication, Authorization and Accounting center). Receiving an answer from the NOC/AAA side by the CPE's PC assures that the system is configured and operating properly.

The following figure shows the end-to-end test elements.



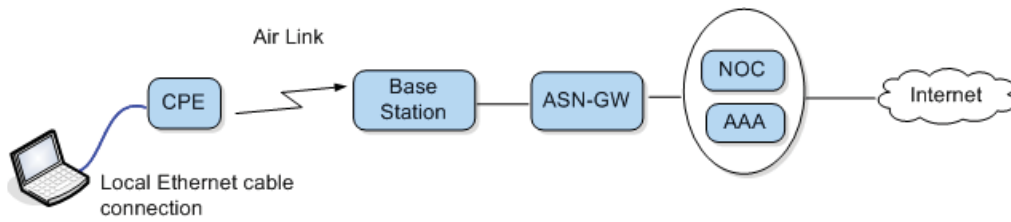

### To perform the test

1. Ensure that the BS is configured with the:
  - Center frequency
  - ASN-GW IP address and security parameters
2. Connect the BS to a CPE configured with the:
  - Center Frequency
3. Connect a computer configured to communicate with the CPE– using the CPE IP address subnet) to the CPE Ethernet port using a cross-cable.
4. Use Telnet to send a ping command from the CPE computer to the NOC IP Address.

## 4.5.1 Performing a PING Test

### To verify connectivity

1. Open a Command Prompt window from the computer connected to the CPE
2. Select Start → Run and enter cmd.
3. Enter a **Ping** command that pings the NOC.

The following shows a **Ping** command:

```

C:\WINDOWS\system32\cmd.exe
Microsoft Windows XP [Version 5.1.2600]
(C) Copyright 1985-2001 Microsoft Corp.

C:\Documents and Settings\Guys>ping 192.168.0.10

Pinging 192.168.0.10 with 32 bytes of data:

Reply from 192.168.0.10: bytes=32 time=5ms TTL=30
Reply from 192.168.0.10: bytes=32 time=8ms TTL=30
Reply from 192.168.0.10: bytes=32 time<1ms TTL=30
Reply from 192.168.0.10: bytes=32 time=3ms TTL=30

Ping statistics for 192.168.0.10:
    Packets: Sent = 4, Received = 4, Lost = 0 (0% loss),
    Approximate round trip times in milli-seconds:
        Minimum = 0ms, Maximum = 8ms, Average = 4ms

C:\Documents and Settings\Guys>
    
```

4. Verify that the link has been established properly according to the reply received from the NOC.
5. If no 'ping' reply is received, check connections and required configuration parameters.

## 5 Field Test Performance Evaluation

The purpose of this document is to validate in the field performance of Runcom system that includes base station and CPEs (with or without NOC) in the operation modes. The field tests cover MIMO-A (Matrix A or SISO) and MIMO B (Matrix B).

This document contains the following main sections that describe the test performance:

- Throughput performance per CINR and MCS (modulation coding scheme)

The table below describes the test equipment list and the associated accessories in order to perform the test as described in this document

Equipment	QTY	Parameters
Outdoor Compact BTS 4x4	1	4x30dbm, 65 or 90 degrees sector antenna 16dbi
IDU CPE	2	2x24dbm, panel antenna 2x7dbi or 2x15dbi
ODU CPE	2	2x24dbi, omni antennas 2x5dbi
USB	2	1x17-20dbm, on board antenna
CNOC	1	License for 100 subscribers
<b>RF Configuration</b>		
BW	10MHz (or 5MHz)	
TX/RX symbols ratio	32/15 (or 26:21 for higher UL)	
TX power	4x0dB MAX 4X30dB MAX	for Lab test for field test
DL Modulation max	QAM 64 2/3	For mobile
UL Modulation max	QAM 16 3/4	For mobile
<b>Network Configuration</b>		
Service Flow Default	BE, UGS, nRTPS CIR 64Kb MIR DL 40Mbs/UL 40Mbs	All users
<b>Advance Configuration</b>		
Special settings	MIMO-B mode BS CINR Threshold table parameters	
BS Synch Configuration	GPS for external use Internal clock	For field test For Lab test

### 5.1 Field Test Overview

The field test testing procedures is used to evaluate the throughput performance and the base station sector coverage performance in LOS and N-LOS environment. To get more robust reliable measurements results for better analysis the recommended conditions for the testing points are LOS environment.

---

Note:

---

1. For MIMO B operation mode the DL CINR should be 25db
2. For maintaining the MIMO B mode the recommended set up is LOS or Near-LOS.

## 5.2 Field Test Setup

The setup presented here is a suggestion for a general setup which allows the operation of the tests as described in this document.

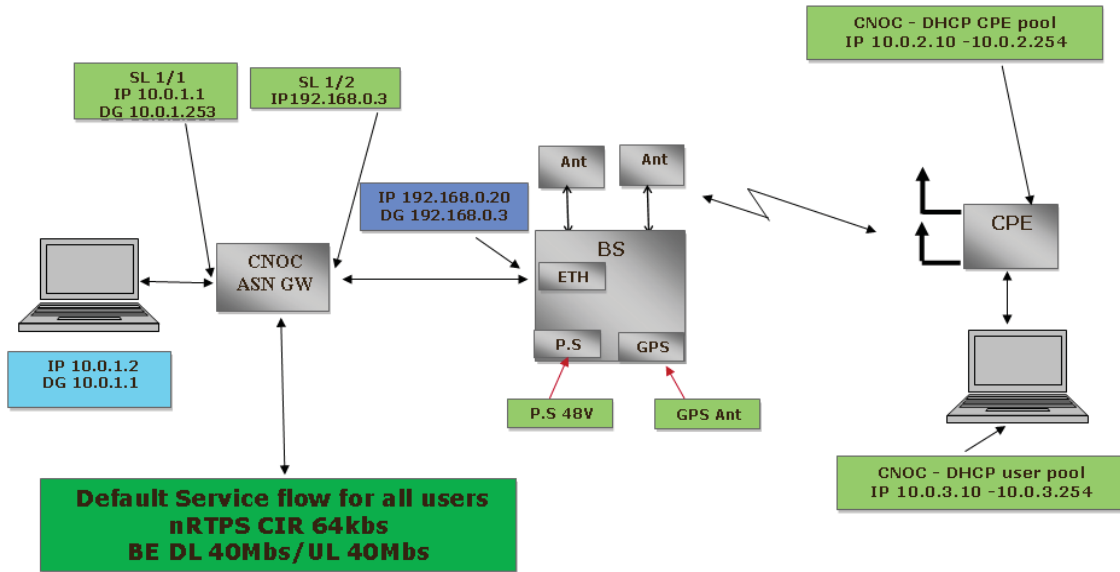

Figure 29 Test Setup Diagram

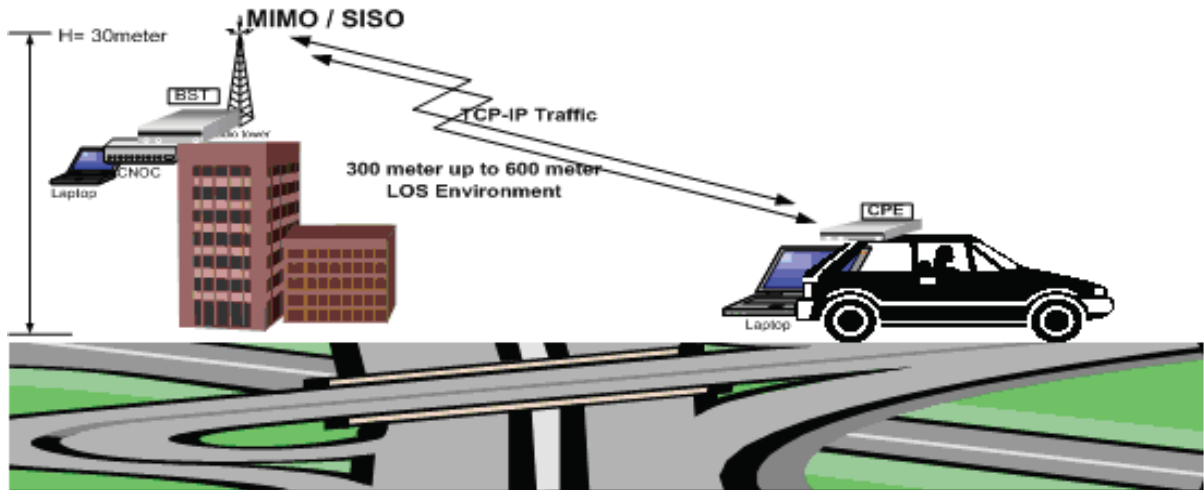

Figure 30 Field Test Setup



Figure 31 **Field Test Point**

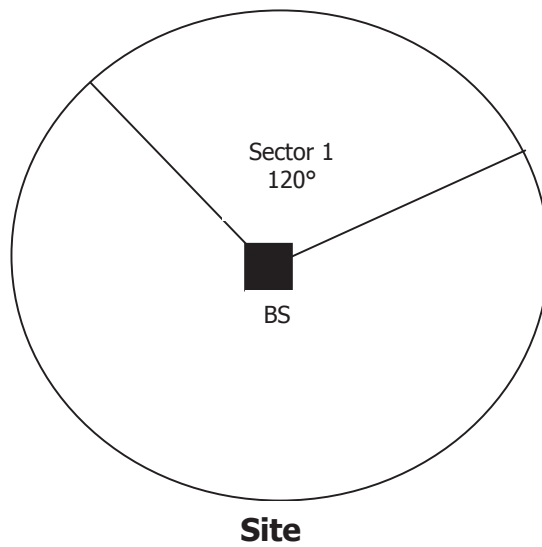

Figure 32 **Sector Radio Coverage**

## 5.3 Field Test Procedure

### Preliminary preparation

1. Establish the test setup and the outdoor installation according to the figure "Field Test Setup" or equivalent
  2. Establish connection between the BS and the CPE and required settings to obtain proper connection
- Perform PC to PC TCP throughput performance using measurement tools:

- FTP "FileZilla Server" (Setting Buffer size = 491520/Socet buffer size=983040)
- 5 sessions (file size 80 Mb each) running simultaneously on CPE in complete LOS

### DL Throughput performance SISO/ MIMO B

DL link Modulation	RSSI[dB]	CINR [dB]	DL Throughput (max) [Mb/s] Radio BW 10MHz TX/RX symbols ratio 32:15
64 QAM 5/6 (MIMO-B)	-55	27	37
64 QAM 2/3 (MIMO-B)	-58	25	30
16 QAM 3/4 (MIMO-B)	-65	22	22
64 QAM 2/3 (SISO)	-70	20	14.5
16QAM 3/4 (SISO)	-75	17	11
16QAM 1/2 (SISO)	-78	14	7.5
QPSK 3/4 (SISO)	-80	11	5.5
QPSK 1/2 (SISO)	-83	8	3.5

Note:

1. Throughput performance measurements values tolerance -5%
2. CINR measure values tolerance  $\pm 2$ dBm
3. RSSI values tolerance  $\pm 3$ dBm

### DL Throughput performance SISO table - theoretical calculation / symbol ratio 32:15

DL Modulation	DL CINR threshold	DL Throughput (max) BW 10MHz [Mb/s]	DL Throughput (max) [Mb/s] Radio BW 5MHz TX/RX symbols ratio 32:15
QPSK 1/2	8	4	2
QPSK 3/4	11	6	3
QAM 16 1/2	14	8	4
QAM 16 3/4	17	12	6
QAM 64 1/2	20	12	6
QAM 64 2/3	22	16	8
QAM 64 3/4	24	18	9
QAM 64 5/6	25	20	10

**UL Throughput performance SISO - theoretical calculation / symbol ratio 32:15**

DL Modulation	DL CINR threshold	DL Throughput (max) BW 10MHz [Mb/s]	DL Throughput (max) BW 5MHz [Mb/s]
QPSK 1/2	3	1.34	0.6
QPSK 3/4	6	2	1
QAM 16 1/2	9	2.68	1.34
QAM 16 3/4	12	4	2

**DL Throughput performance MIMO B table - theoretical calculation / symbol ratio 32:15**

DL Modulation	DL CINR threshold	DL Throughput (max) BW 10MHz [Mb/s]	DL Throughput (max) BW 5MHz [Mb/s]
QAM 16 3/4	20	24	12
QAM 64 2/3	22	32	16
QAM 64 5/6	25	40	20

## 6 Technical Specifications

The RNU4000BS BS installation procedure involves the following accessories:

- RF Antennas
- GPS Antenna (Optional)
- Mounting kit

This section details the specifications for the RNU4000BS BS and accessories.

### 6.1 RNU4000BS BS Specifications

<b>Radio</b>	
<b>Standard compliance complies with 802.16e according to the WiMAX Forum profiles.</b>	
WiMax	Fixed and Mobile
Number of sectors	1, 2 or 4 sectors
System Capability	LOS, Near LOS, Non LOS
Frequency	700 – 750MHz, 1.6-1.8GHz, 2.3-2.7GHz, 3.3-3.8GHz (CBP capability for band 3.675-3.700GHz is required),4.9-5.0GHz, 5.0-5.15GHz, 5.7-5.8GHz, 5.9-6.4GHz(Model Dependent) other frequencies are optional
FFT	512, 1024, 2048
FEC	Convolution Code and Turbo Code
Channel bandwidth	3.5 MHz, 5 MHz, 7 MHz, 8.75 MHz, 10 MHz, optional 20 MHz
Duplex method	TDD, optional FDD/HFDD
Central frequency resolution	125 KHz
Maximum output power (on antenna connector)	+30dBm +28 dBm per antenna in 4.9GHz and above
Antennas:	
Type	Integrated Sectorized 11dbi (90°) External dual slant Single antenna
Number	2 dual-slant;
Connectors	4x N-Type, 50 ohm, lightning protected (Optional)
Modulation and coding rates	DL/UL: QPSK (1/2, 3/4) , 16 QAM (1/2, 3/4), 64 QAM (2/3 , 3/4, 5/6 ) (64 QAM is optional for UL)
Diversity Supported	MIMO A/B , STC, MRC, SISO,
GPS	Integrated
Synchronization	Integrated GPS module with on board synchronization unit

<b>Management</b>	
Network Management	SNMPv2/v3, standard and proprietary MIB
System Configuration	SNMP, FTP, CLI
Software Upgrade	Remote TFTP upgrade of firmware and programming
<b>Interfaces</b>	
Network Interfaces	2x10/100 Base-T, Optional 1xGE and optical interface SX/LX
Northbound Interface	Profile C, R6 per SF GRE tunnel, Profile B is optional
Connectors	2xN-Type for external antenna 50 ohm, External synchronization option, external GPS antenna option, power connector, 2xRJ-45
<b>Electrical Characteristics</b>	
Power Source	-36 to -72 VDC < 60Watt
<b>Physical and Environmental</b>	
Dimensions	39cm (L) x 24cm (W) x 12cm (H)
Weight	5000 grams / not including mounting kit
Operating external temperature	Industrial -40°C to 55° C
Operating humidity	95% non-condensing
<b>Standards Compliance*</b>	
Safety	EN 60950-1, EN 60950-22
Environmental	IEC 60529-1, IP66
Radio	FCC Part 27 , Part 90; EN302 623 , EN302 544
EMC	FCC part 15, class B ; ETSI EN 301489-1



## 6.2 External Dual-Slant RF Antennas Specifications

---

### 6.2.1 698-806MHz, Dual Polarized 65° Sector Antennas Fixed Tilt (AW3052)

<b>Electrical</b>	
Frequency Range	698MHz – 806MHz
Gain	13.5 dBi
Return Loss (VSWR)	>14dB (1.5:1)
Azimuth Beam width @ 13.5dBi	65° (typ)
Polarization	Dual Slant (+/-45°)
Upper Sidelobe Suppression	>18dB
Horizontal 3dB BW	65°
Vertical 3dB BW	17°
Power Handling	300W
Front-to-Back Ratio	>25dB
Isolation	>30dB
Input Impedance	50 (ohm)
Electrical Downtilt	4 °
Lightning Protection	DC grounded
<b>Mechanical</b>	
DIMENSIONS (LxWxD)	1220 x 300 x 150mm
WEIGHT	13 kg
Connector	2 x 7/16 DIN Female
Connection Location	Bottom
RADOME	UV Stabilised Styrosun

## 6.2.2 698-806MHz, Dual Polarized 90° Sector Antennas Fixed Tilt (AW3054)

<b>Electrical</b>	
Frequency Range	698MHz – 806MHz
Gain	12.5 dBi
Return Loss (VSWR)	>14dB (1.5:1)
Azimuth Beam width @ 13.5dBi	90° (typ)
Polarization	Dual Slant (+/-45°)
Upper Sidelobe Suppression	>18dB
Horizontal 3dB BW	65°
Vertical 3dB BW	17°
Power Handling	300W
Front-to-Back Ratio	>25dB
Isolation	>30dB
Input Impedance	50 (ohm)
Electrical Downtilt	4 °
Lightning Protection	DC grounded
<b>Mechanical</b>	
DIMENSIONS (LxWxD)	1220 x 300 x 150mm
WEIGHT	13 kg
Connector	2 x N Female
Connection Location	Bottom
RADOME	UV Stabilised Styrosun

## 6.2.3 Dual-Slant Antenna 2.3-2.7 GHz; 17 dBi;65° (MT-364054/ND)

<b>Electrical</b>	
Gain	16 dBi (min) @ 2.3 - 2.5 GHz 17.5±0.5 dBi @ 2.5 - 2.7 GHz
VSWR	1.5:1 (typ), 1.7 :1(max)
Azimuth Beam width @ 13.5dBi	65° (typ)
Elevation Beam width @ -3 dB	7° (typ)
Polarization	Dual Linear, ± 45°
Cross-polarization	-20 dB (max) @ 2.3 - 2.5 GHz -17 dB (max) @ 2.5 - 2.7 GHz
Side Lobes Level Azimuth and Elevation	Meets ETSI EN 302 326- V1.1.2 (2006-03)

Side Lobes Level for Azimuth in the range (± 100 to ± 180 from Boresight)	-20 dB (max) @ 2.3 - 2.5 GHz -25 dB (max) @ 2.5 - 2.7 GHz
Front-to-Back Ratio	-30 dB (max)
Port-to-Port Isolation	23 dB (min), 30 dB (typ)
Input Impedance	50 (ohm)
Input Power	20 W (CW), 250 W (peak)
Lightning Protection	DC grounded
<b>Mechanical</b>	
DIMENSIONS (LxWxD)	945 x 126 x 37mm (max)
WEIGHT	3.0 kg (max)
CONNECTOR	2 x N-Type Female
RADOME	Plastic UV Resistant
BASE PLATE	Aluminum with chemical conversion coating
MECHANICAL DOWN TILT	0° to (-10°)

## 6.2.4 Double-dual Slant 2300-2700 MHz Remote Tilt-Panel Antenna

<b>Electrical</b>	
Frequency Range	2300-2700 MHz
Gain	17.1 dBi @ 2.4 GHz 17.8 dBi @ 2.6 GHz
Return Loss	> 15 dB
Polarization	Dual Slant $\pm 45^\circ$
Horizontal Beamwidth	65°
Vertical Beamwidth	7° with nullfill
Electrical Downtilt	0° - 10° independently continuously adjustable
Upper Sidelobe Level	< -18 dB
Front to Back Ratio	> 30 dB
Isolation Between Ports	> 30 dB
Power Rating	250 W
Impedance	50 ohm
Lightening Protection	DC Grounded
Connector Type	N-Type Female
RET Type	Internal motor & manual override
RET Interface	AISG 2 Remotely upgradeable
RET Connector	Single AISG 8 pin male
<b>Mechanical</b>	
Antenna Dimensions	1070x300x115 mm
Packed Dimensions	1200x330x200 mm
Antenna Weight	13 kg
Radom Material	Polyester Fiberglass

### 6.2.5 Dual-Slant Antenna 2.3-2.7 GHz; 16 dBi;60° (SP2327-16XP60NUF)

<b>Electrical</b>	
Gain	16 dBi @ 2.3-2.5 GHz 16.5 dBi @ 2.5-2.7 GHz
VSWR	1.5 : 1 (max)
Azimuth Beamwidth @ 13.5dBi	60° +/- 5°
Elevation Beamwidth @ -3 dB	9° (typ)
Polarization	Dual Linear, ± 45°
Front-to-Back Ratio EN 302 326 V.1.1.2 (2006-03)	-25 dB (Min)
Port-to-Port Isolation	30 dB (typ) @ 2.3-2.7 GHz
Null Fill	1st Sidelobe: -15dB 2nd Sidelobe: -18dB
Input Impedance	50 (ohm)
Input Power	20 W (CW), 250 W (peak)
Lightning Protection	DC grounded
<b>Mechanical</b>	
DIMENSIONS (LxWxD)	711x171x90mm (max)
WEIGHT	3.1 kg (max)
CONNECTOR	2 x N-Type Female
RADOME	Gray UV resistant plastic
MECHANICAL DOWN TILT	0° to (-10°)

## 6.2.6 Dual-Slant Antenna 2.3-2.7 GHz; 15 dBi;90° (SP2327-15XP90NUF)

<b>Electrical</b>	
Gain	14.5 dBi @ 2.3-2.5 GHz 15 dBi @ 2.5-2.7 GHz
VSWR	1.5 : 1 (max)
Azimuth Beamwidth @ 13.5dBi	90° +/- 5°
Elevation Beamwidth @ -3 dB	9° (typ)
Polarization	Dual Linear, ± 45°
Front-to-Back Ratio EN 302 326 V.1.1.2 (2006-03)	-25 dB (Min)
Port-to-Port Isolation	30 dB (typ) @ 2.3-2.7 GHz
Null Fill	1st Sidelobe: -15dB 2nd Sidelobe: -18dB
Input Impedance	50 (ohm)
Input Power	20 W (CW), 250 W (peak)
Lightning Protection	DC grounded
<b>Mechanical</b>	
DIMENSIONS (LxWxD)	711x171x90mm (max)
WEIGHT	3.1 kg (max)
CONNECTOR	2 x N-Type Female
RADOME	Gray UV resistant plastic
MECHANICAL DOWN TILT	0° to (-10°)

### 6.2.7 Dual-Slant Antenna 3.3-3.8 GHz; 17 dBi;65° (MT-404067/ND)

<b>Electrical</b>	
Gain	16 dBi (min) @ 3.3-3.4 GHz 17.5 ±0.5 dBi @ 3.5-3.8 GHz
VSWR	1.5 : 1 (typ) 1.8:1 (max)
Azimuth Beamwidth @ 13.5dBi	65° (typ)
Elevation Beamwidth @ -3 dB	7.5° (typ)
Polarization	Dual Linear, ± 45°
Cross-polarization	ETSI EN 302 326 V.1.1.2 (2006-03)
Side Lobes Level Azimuth and Elevation	Meets ETSI EN 302 326- V1.1.2 (2006-03)
Side Lobes Level for Azimuth in the range (± 100 to ± 180 from Boresight)	-25dB (max) @ 3.3-3.5 GHz -30dB (max) @ 3.5-3.8 GHz
Front-to-Back Ratio EN 302 326 V.1.1.2 (2006-03)	-30 dB (max)
Port-to-Port Isolation	25 dB (min) @ 3.3-3.7 GHz 20 dB (min) @ 3.7-3.8 GHz
Input Impedance	50 (ohm)
Input Power	20 W (CW), 250 W (peak)
Lightning Protection	DC grounded
<b>Mechanical</b>	
DIMENSIONS (LxWxD)	600x130x63mm (max)
WEIGHT	2.5 kg (max)
CONNECTOR	2 x N-Type Female
RADOME	Plastic UV Resistant
BASE PLATE	Aluminum with chemical conversion coating
MECHANICAL DOWN TILT	0° to (-10°)

## 6.2.8 Dual-Slant Antenna 3.3-3.8 GHz; 17 dBi;65° (SP3338-17XP65)

<b>Electrical</b>	
Gain	16.5 dBi @ 3.3-3.5 GHz 17dBi @ 3.5-3.8 GHz
VSWR	1.5 : 1 (max)
Azimuth Beamwidth @ 13.5dBi	65° +/- 5°
Elevation Beamwidth @ -3 dB	7° (typ)
Polarization	Dual Linear, ± 45°
Upper Side Lobe Suppression 30 degrees above horizon	-15dB @ 3.3-3.8 GHz
Front-to-Back Ratio EN 302 326 V.1.1.2 (2006-03)	-25 dB (Min)
Port-to-Port Isolation	30 dB (typ) @ 3.3-3.8 GHz
Input Impedance	50 (ohm)
Input Power	20 W (CW), 250 W (peak)
Lightning Protection	DC grounded
<b>Mechanical</b>	
DIMENSIONS (LxWxD)	711x171x90mm (max)
WEIGHT	3.1 kg (max)
CONNECTOR	2 x N-Type Female
RADOME	Gray UV resistant plastic
MECHANICAL DOWN TILT	0° to (-10°)



### 6.2.8.1 Radiation Patterns

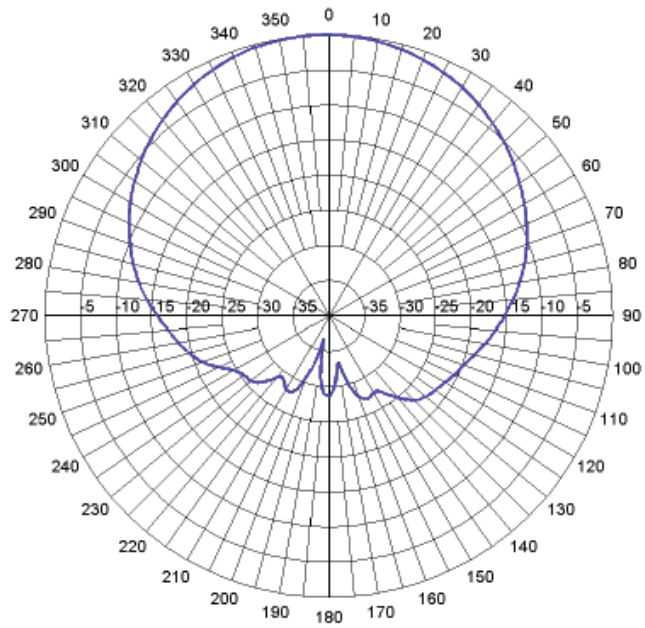

SP3338-17XP65 azimuth plane

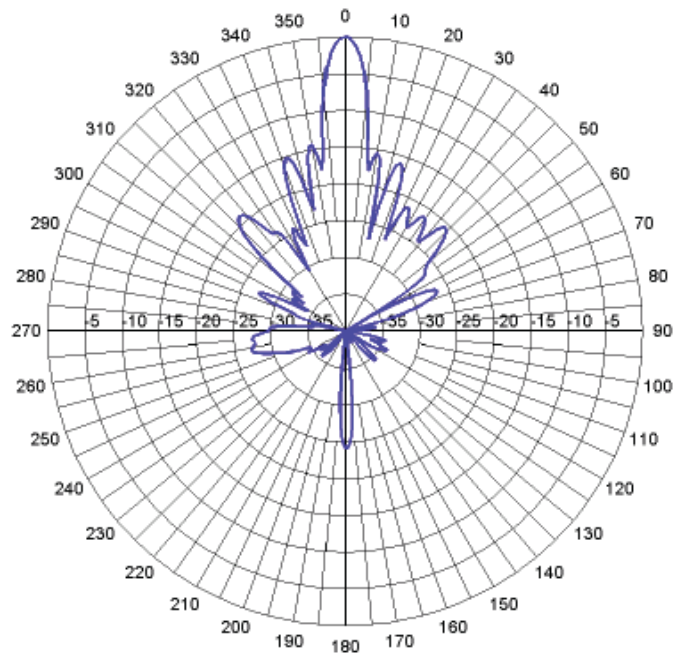

SP3338-17XP65 elevation plane

### 6.2.9 Dual-Slant Antenna 3.3-3.8 GHz; 17 dBi;90° (SP3338-17XP90)

<b>Electrical</b>	
Gain	15.5 dBi @ 3.3-3.5 GHz 16 dBi @ 3.5-3.8 GHz
VSWR	1.5 : 1 (max)
Azimuth Beamwidth @ 13.5dBi	90° +/- 5°
Elevation Beamwidth @ -3 dB	7° (typ)
Polarization	Dual Linear, ± 45°
Upper Side Lobe Suppression 30 degrees above horizon	-15dB @ 3.3-3.8 GHz
Front-to-Back Ratio EN 302 326 V.1.1.2 (2006-03)	-25 dB (Min)
Port-to-Port Isolation	30 dB (typ) @ 3.3-3.8 GHz
Input Impedance	50 (ohm)
Input Power	20 W (CW), 250 W (peak)
Lightning Protection	DC grounded
<b>Mechanical</b>	
DIMENSIONS (LxWxD)	711x171x90mm (max)
WEIGHT	3.1 kg (max)
CONNECTOR	2 x N-Type Female
RADOME	Gray UV resistant plastic
MECHANICAL DOWN TILT	0° to (-10°)

### 6.2.9.1 Radiation Patterns

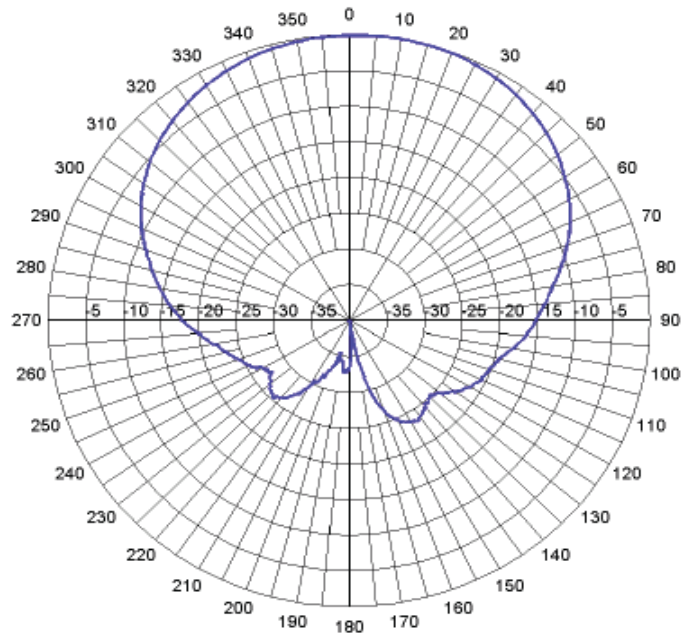

SP3338-17XP90 azimuth plane

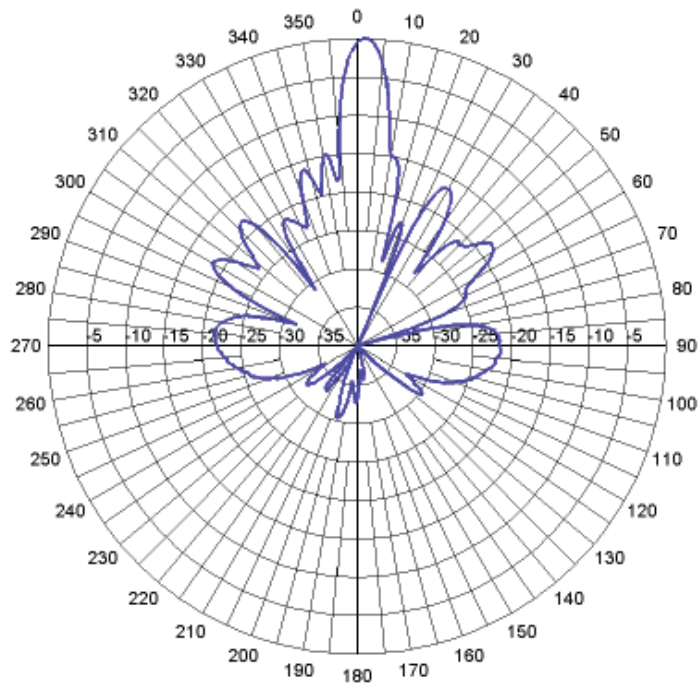

SP3338-16XP90 elevation plane

## 6.2.10 Dual-Slant Antenna 4.9-5.95 GHz; 16 dBi;90° (MT-464018/ND)

<b>Electrical</b>	
Gain	16 dBi (min) @ 4.9-5.95 GHz
VSWR	2 : 1 (max) 1.7:1 (typ)
4dB Azimuth Beam width	90° (typ)
Elevation Beam width @ -3 dB	6.0° (typ)
Polarization	Dual Linear, ± 45°
Cross-polarization	ETSI EN 302 326 V.1.1.2 (2006-03)
EL upper side lobes level	25dB (typ)
Front-to-Back Ratio	-25 dB (max)
Port-to-Port Isolation	25 dB (typ) 22dB (min)
Input Impedance	50 (ohm)
Input Power	20 W (CW), 250 W (peak)
Lightning Protection	DC grounded
<b>Mechanical</b>	
Antenna Dimensions	550x250x17 mm
Connector	2xN-Type Female
Antenna Weight	2.5 kg
Radom Material	Plastic

## 6.3 RNU4000BS Internal Antenna Specifications

<b>Specifications for 2.5 GHz / 3.5 GHz/4.9GHz</b>			
<b>Electrical</b>	<b>2.5 GHz</b>	<b>3.5 GHz</b>	<b>4.9 GHz</b>
Antenna Model	4x Sector	4 x Sector	4 x Sector
Frequency Range	2.3 – 2.7 GHz	3.3 – 3.8 GHz	4.9 - 5.1 GHz
Gain	+ 11.5 dBi x 2	+ 11.5 dBi x 2	+12dBi x 2
VSWR	1.6:1	1.6:1	1.7:1
3 dB Azimuth Beam width	110°	110°	90°
3 dB Elevation Beam width	30°	20°	22°
Polarization	Dual Slant ± 45°	Dual Slant ± 45°	Dual Slant ± 45°
Cross Polarization	-30 dB	-27 ± 3 dB	-35dB
F/B Ratio	-25 dB	-25 dB	-23dB
<b>Mechanical</b>			
Form Factor	RNU4000BS Enclosure Integrated		
Dimensions	236.0 x 79.5 x 48.2 mm (without connectors)		

## 6.4 GPS Antenna Specifications

<b>GPS Active Antenna (BY/GPS/06)</b>	
<b>Dielectric</b>	
Center Frequency	1575.42 MHz $\pm$ 3 MHz
VSWR	1.5:1
Bandwidth	$\pm$ 5 MHz
Impedance	50 ohm
Peak Gain	>3 dBic Based on 7 $\times$ 7cm ground plane
Gain Coverage	>- 4 dBic at $-90^{\circ}$ <0<+90 $^{\circ}$ (over 75% Volume)
Polarization	RHCP
<b>LNA Filter</b>	
LNA Gain (without cable)	28 dB Typical
Noise Figure	1.5 dB
Filter Out of Band Attenuation (f0=1575.42 MHz)	7dB Min f0+/-20MHZ
	20dB Min f0+/-50MHZ
	30dB Min f0+/-100MHZ
VSWR	< 2.0
DC Voltage	3.0V to 5.0V
DC Current	10mA Max
<b>Mechanical</b>	
Weight	< 110 gr
Dimensions D x H	46 mm x 15 mm
Cable	RG174 3m or other
Connector	SMA/SMB/SMC/BNC/FME/TNC/MCX/MMCX or other
Mounting	Screw Mount
Housing	Black
<b>Environmental</b>	
Operating Temperature	-40 $^{\circ}$ ~ +85 $^{\circ}$ C
Storage Temperature	-45 $^{\circ}$ ~ +100 $^{\circ}$ C
Vibration	Sine sweep 1g(0-p)10~50~10Hz each axis

Humidity	95%~100% RH
Weatherproof	100% Weatherproof