

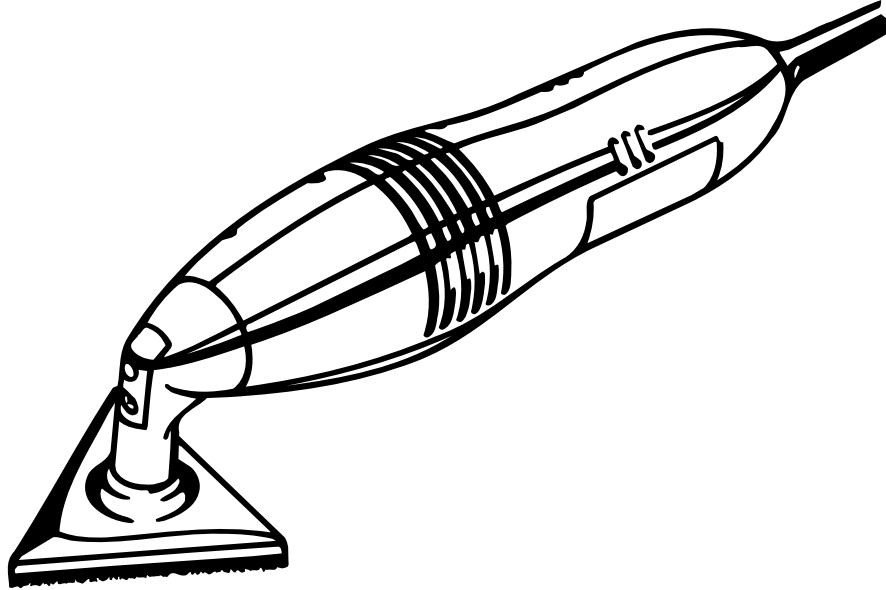

OPERATOR'S MANUAL DETAIL SANDER MODEL DS11008 DOUBLE INSULATED



SPECIFICATIONS:	
Sanding Pad	Triangle shaped
No load speed	12,000 spm
Motion	Oscillating
Rating	120 volts, 60 Hz, AC
Input	.30 amperes
Paper type	Pressure sensitive adhesive backed
Arc size	3.0 mm at tip

THANK YOU FOR BUYING A RYOBI DETAIL SANDER.

Your new Detail Sander has been engineered and manufactured to Ryobi's high standard for dependability, ease of operation, and operator safety. Properly cared for, it will give you years of rugged, trouble-free performance.

⚠ CAUTION: Carefully read through this entire operator's manual before using your new sander.

Pay close attention to the Rules for Safe Operation, Warnings, and Cautions. If you use your sander properly and only for what it is intended, you will enjoy years of safe, reliable service.

Thank you again for buying Ryobi tools.

SAVE THIS MANUAL FOR FUTURE REFERENCE

RULES FOR SAFE OPERATION



WARNING:

Read and understand all instructions. Failure to follow all instructions listed below, may result in electric shock, fire and/or serious personal injury.

SAVE THESE INSTRUCTIONS

Work Area

- **Keep your work area clean and well lit.** Cluttered benches and dark areas invite accidents.
- **Do not operate power tools in explosive atmospheres, such as in the presence of flammable liquids, gases, or dust.** Power tools create sparks which may ignite the dust or fumes.
- **Keep bystanders, children, and visitors away while operating a power tool.** Distractions can cause you to lose control.

Electrical Safety

- **Double insulated tools are equipped with a polarized plug (one blade is wider than the other.)** This plug will fit in a polarized outlet only one way. If the plug does not fit fully in the outlet, reverse the plug. If it still does not fit, contact a qualified electrician to install a polarized outlet. **Do not change the plug in any way.** Double insulation  eliminates the need for the three wire grounded power cord and grounded power supply system.
- **Avoid body contact with grounded surfaces such as pipes, radiators, ranges and refrigerators.** There is an increased risk of electric shock if your body is grounded.
- **Don't expose power tools to rain or wet conditions.** Water entering a power tool will increase the risk of electric shock.
- **Do not abuse the cord. Never use the cord to carry the tools or pull the plug from an outlet. Keep cord away from heat, oil, sharp edges or moving parts. Replace damaged cords immediately.** Damaged cords increase the risk of electric shock.
- **When operating a power tool outside, use an outdoor extension cord marked "W-A" or "W".** These cords are rated for outdoor use and reduce the risk of electric shock.

Personal Safety

- **Stay alert, watch what you are doing and use common sense when operating a power tool. Do not use tool while tired or under the influence of drugs, alcohol, or medication.** A moment of inattention while operating power tools may result in serious personal injury.

- **Dress properly. Do not wear loose clothing or jewelry. Contain long hair. Keep your hair, clothing, and gloves away from moving parts.** Loose clothes, jewelry, or long hair can be caught in moving parts.
- **Avoid accidental starting. Be sure switch is off before plugging in.** Carrying tools with your finger on the switch or plugging in tools that have the switch on invites accidents.
- **Remove adjusting keys or wrenches before turning the tool on.** A wrench or a key that is left attached to a rotating part of the tool may result in personal injury.
- **Do not overreach. Keep proper footing and balance at all times.** Proper footing and balance enables better control of the tool in unexpected situations.
- **Use safety equipment. Always wear eye protection.** Dust mask, nonskid safety shoes, hard hat, or hearing protection must be used for appropriate conditions.

Tool Use and Care

- **Use clamps or other practical ways to secure and support the workpiece to a stable platform.** Holding the work by hand or against your body is unstable and may lead to loss of control.
- **Do not force tool. Use the correct tool for your application.** The correct tool will do the job better and safer at the rate for which it is designed.
- **Do not use tool if switch does not turn it on or off.** Any tool that cannot be controlled with the switch is dangerous and must be repaired.
- **Disconnect the plug from the power source before making any adjustments, changing accessories, or storing the tool.** Such preventive safety measures reduce risk of starting the tool accidentally.
- **Store idle tools out of reach of children and other untrained persons.** Tools are dangerous in the hands of untrained users.
- **Maintain tools with care. Keep cutting tools sharp and clean.** Properly maintained tools, with sharp cutting edges are less likely to bind and are easier to control.
- **Check for misalignment or binding of moving parts, breakage of parts, and any other condition that may affect the tools operation.** If damaged, have the tool serviced before using. Many accidents are caused by poorly maintained tools.
- **Use only accessories that are recommended by the manufacturer for your model.** Accessories that may be suitable for one tool, may become hazardous when used on another tool.

RULES FOR SAFE OPERATION

Service

- **Tool service must be performed only by qualified repair personnel.** Service or maintenance performed by unqualified personnel could result in a risk of injury.
- **When servicing a tool, use only identical replacement parts. Follow instructions in Maintenance section of this manual.** Use of unauthorized parts or failure to follow Maintenance Instructions may create a risk of electric shock or injury.

Specific Safety Rules for Sanders

- **Hold tool by insulated gripping surfaces when performing an operation where the tool may contact hidden wiring or its own cord.** Contact with a “live” wire will make exposed metal parts of the tool “live” and shock the operator.
- **Never use this or any power sander for wet sanding or liquid polishing.** Failure to comply can result in electrical shock causing serious injury or worse.
- **Keep hands away from sanding area.**

Additional Rules for Safe Operation

- **Know your power tool.** Read operator's manual carefully. Learn its applications and limitations as well as the specific potential hazards related to this tool.
- **Always wear safety glasses.** Everyday eyeglasses have only impact-resistant lenses; they are **NOT** safety glasses.
- **Protect your lungs.** Wear a face or dust mask if the operation is dusty.
- **Protect your hearing.** Wear hearing protection during extended periods of operation.
- **Don't abuse cord.** Never carry tool by cord or yank it to disconnect from receptacle. Keep cord from heat, oil and sharp edges.
- **Make sure your extension cord is in good condition.** When using an extension cord, be sure to use one heavy enough to carry the current your product will draw. An undersized cord will cause a drop in line voltage resulting in loss of power and overheating. A wire gage size (A.W.G.) of at least **16** is recommended for an extension cord 100 feet or less in length. A cord exceeding 100 feet is not recommended. If in doubt, use the next heavier gage. The smaller the gage number, the heavier the cord.

- **Inspect tool cords periodically** and if damaged, have repaired at your nearest authorized service center. Stay constantly aware of cord location.
- **Check damaged parts.** Before further use of the tool, a guard or other part that is damaged should be carefully checked to determine that it will operate properly and perform its intended function. Check for alignment of moving parts, binding of moving parts, breakage of parts, mounting, and any other conditions that may affect its operation. A guard or other part that is damaged should be properly repaired or replaced by an authorized service center.
- **Inspect for** and remove all nails from lumber before sanding.
- **Drugs, Alcohol, Medication.** Do not operate tool while under the influence of drugs, alcohol, or any medication.
- **Save these instructions.** Refer to them frequently and use them to instruct others who may use this tool. If you loan someone this tool, loan them these instructions also.



WARNING:

Some dust created by power sanding, sawing, grinding, drilling, and other construction activities contains chemicals known to cause cancer, birth defects or other reproductive harm. Some examples of these chemicals are:

- lead from lead-based paints,
- crystalline silica from bricks and cement and other masonry products, and
- arsenic and chromium from chemically-treated lumber.

Your risk from these exposures varies, depending on how often you do this type of work. To reduce your exposure to these chemicals: work in a well ventilated area, and work with approved safety equipment, such as those dust masks that are specially designed to filter out microscopic particles.

SAVE THESE INSTRUCTIONS

SYMBOLS

Important: Some of the following symbols may be used on your tool. Please study them and learn their meaning. Proper interpretation of these symbols will allow you to operate the tool better and safer.

SYMBOL	NAME	DESIGNATION/EXPLANATION
V	Volts	Voltage
A	Amperes	Current
Hz	Hertz	Frequency (cycles per second)
W	Watt	Power
min	Minutes	Time
~	Alternating Current	Type or a characteristic of current
n_0	No Load Speed	Rotational speed, at no load
	Class II Construction	Designates Double Insulated Construction tools
.../min	Revolutions or Reciprocation Per Minute	Revolutions, strokes, surface speed, orbits etc. per minute



Look for this symbol to point out important safety precautions. It means attention!!! Your safety is involved.

The purpose of safety symbols is to attract your attention to possible dangers. The safety symbols, and the explanations with them, deserve your careful attention and understanding. The safety warnings do not by themselves eliminate any danger. The instructions or warnings they give are not substitutes for proper accident prevention measures.

SYMBOL MEANING



SAFETY ALERT SYMBOL:

Indicates danger, warning or caution. May be used in conjunction with other symbols or pictographs.



DANGER: Failure to obey a safety warning will result in serious injury to yourself or to others. Always follow the safety precautions to reduce the risk of fire, electric shock and personal injury.



WARNING: Failure to obey a safety warning can result in serious injury to yourself or to others. Always follow the safety precautions to reduce the risk of fire, electric shock and personal injury.



CAUTION: Failure to obey a safety warning may result in property damage or personal injury to yourself or to others. Always follow the safety precautions to reduce the risk of fire, electric shock and personal injury.

NOTE: Advises you of information or instructions vital to the operation or maintenance of the equipment.

FEATURES

Your sander is suitable for sanding with coarse, medium, and fine grit sandpaper. It will produce a fine scratch free finish when used to sand with the grain on wood surfaces. By purchasing optional accessories, it can also be used as a polisher or scraper.

Before attempting to use your sander, familiarize yourself with all operating features and safety requirements.

See Figure 1.

DOUBLE INSULATION

In electric power tools, double insulation is a concept in safety which eliminates the need for the usual three-wire grounded power cord. All exposed metal parts are isolated from the internal metal motor components with protecting insulation. Double insulated tools do not need to be grounded.

IMPORTANT

Servicing of a tool with double insulation requires extreme care and knowledge of the system and should be performed only by a qualified service technician. For service we suggest you return the tool to your nearest **RYOBI AUTHORIZED SERVICE CENTER** for repair. When servicing use only identical Ryobi replacement parts.



WARNING:

The double insulated system is intended to protect the user from shock resulting from a break in the tool's internal wiring. Observe all normal safety precautions related to avoiding electrical shock.

OSCILLATING MOTION

The oscillating motion sands 3.0 mm arcs, providing fast cutting action with excellent sanding results. As the name implies, this tool has been designed primarily for detailed and intricate sanding. For example, refinishing furniture, chairs, etc., enabling you to sand in places that are hard to get to.

SWITCH

This tool is equipped with a simple switch control. To turn your sander **ON**, depress the switch button as shown in Figure 1. Depress the switch button in the opposite direction to turn your sander **OFF**.

ELECTRICAL CONNECTION

Your sander has a precision built electric motor. It should be connected to a **power supply that is 120 volts, 60 Hz, AC only (normal household current)**. Do not operate this tool on direct current (DC). A substantial voltage drop will cause a loss of power and the motor will overheat. If your tool does not operate when plugged into an outlet, double-check the power supply.

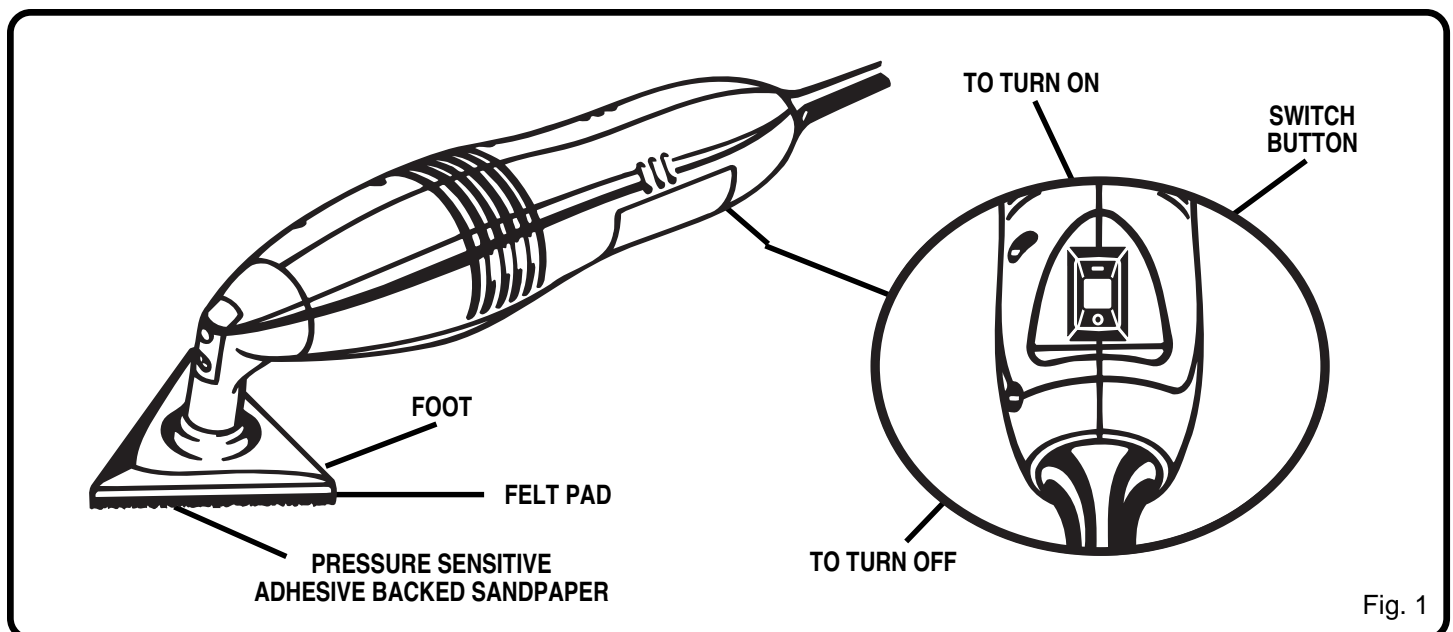

Fig. 1

OPERATION

WARNING:

Your sander should never be connected to a power supply when you are assembling parts, making adjustments, assembling or replacing sandpaper, cleaning, or when not in use. Disconnecting sander will prevent accidental starting that could cause serious personal injury.

APPLICATIONS

(Use only for the purposes listed below)

- Sanding on wood surfaces.
- Removing rust from and sanding steel surfaces.
- Polishing and buffing.
- Scraping paint or glue from window panes.

INSTALLING SANDPAPER

See Figure 2.

The felt pad on your sander accepts pressure sensitive adhesive backed sandpaper. Precut triangle shaped sandpaper in assorted grits is available from your local Ryobi dealer.

- **UNPLUG YOUR SANDER.**

WARNING:

Failure to unplug your sander could result in accidental starting causing possible serious personal injury.

- If installing sandpaper for the first time, proceed as follows. If replacing sandpaper, remove old sandpaper by peeling it off felt pad, then proceed as follows.
- Carefully peel paper backing from new sandpaper.
- Position sandpaper into place, then carefully press sticky side of sandpaper on felt pad.

WARNING:

Before connecting your sander to a power supply source, always check to be sure switch is not in **ON** position. Failure to do so could result in accidental starting of your sander resulting in possible serious injury.

WARNING:

If any parts are missing, do not operate your sander until the missing parts are replaced. Failure to do so could result in possible serious personal injury.

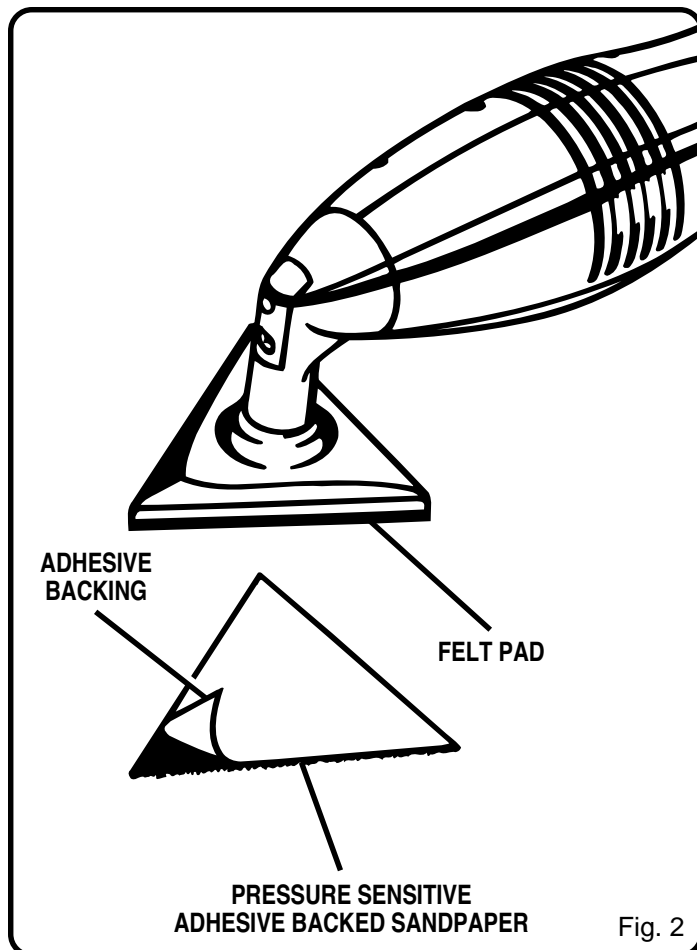

WARNING:

Never use your detail sander for wet sanding or liquid polishing. Failure to comply can result in electrical shock causing serious injury or worse.

WARNING:

Do not allow familiarity with your sander to make you careless. Remember that a careless fraction of a second is sufficient to inflict severe injury.

OPERATION

PREPARING FOR OPERATION

CAUTION:

Be careful not to let your hand cover the air vents.

TO OPERATE

When applicable, clamp or otherwise secure the work to prevent it from moving under your sander.

WARNING:

Unsecured work could be thrown towards the operator causing injury.

SANDING

See Figures 3 and 4.

Hold sander in front and away from you, keeping it clear of the workpiece. Start sander and let the motor build to its maximum speed, then gradually lower on the work with a slight forward movement. Move it slowly over workpiece using forward and backward or side to side strokes. Upon completion of sanding operation, always remove sander from workpiece before turning it off.

DO NOT FORCE. The weight of the unit supplies adequate pressure, so let the sandpaper and sander do the work. Applying additional pressure only slows the motor, rapidly wears sandpaper and greatly reduces sander speed. Excessive pressure will overload the motor causing possible damage from motor overheating and can result in inferior work. Any finish or resin on wood may soften from the frictional heat. Do not allow sanding on one spot too long as sander's rapid action may remove too much material, making the surface uneven.

SANDPAPER SELECTION

Selecting the correct size grit and type sandpaper is an extremely important step in achieving a high quality sanded finish. Aluminum oxide, silicon carbide, and other synthetic abrasives are best for power sanding. Natural abrasives, such as flint and garnet are too soft for economical use in power sanding.

In general, coarse grit will remove the most material and finer grit will produce the best finish in all sanding operations. The condition of the surface to be sanded will determine which grit will do the job. If the surface is rough, start with a coarse grit and sand until the surface is uniform. Medium grit may then be used to remove scratches left by the coarser grit and finer grit used for finishing of the surface. Always continue sanding with each grit until surface is uniform.

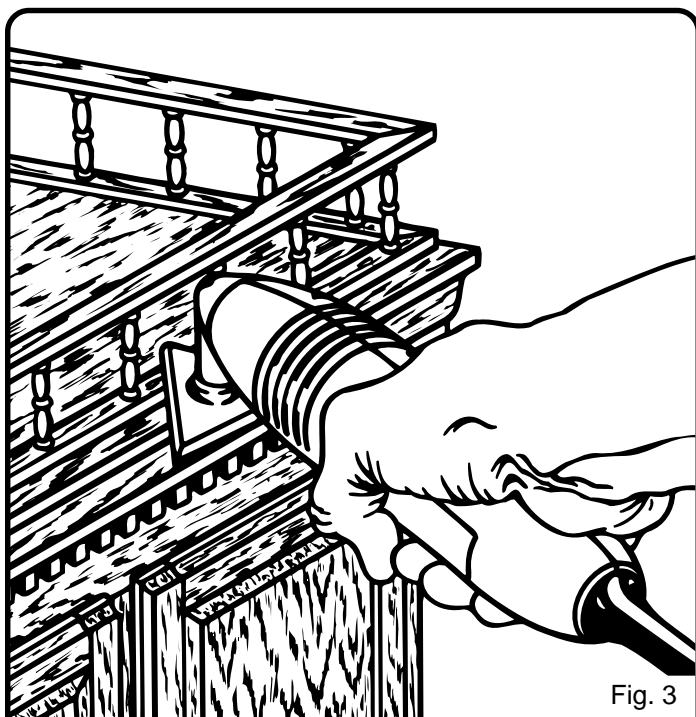

Fig. 3

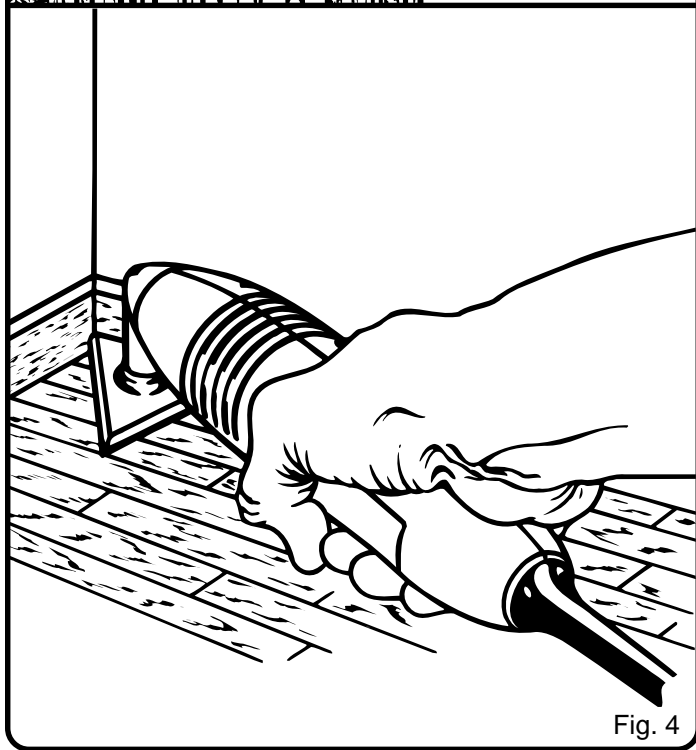

Fig. 4

WARNING:

Do not wear loose clothing or jewelry when operating sander. They could get caught in moving parts causing serious injury. Keep head away from sander and sanding area. Hair could be drawn into sander causing serious injury.

MAINTENANCE



WARNING:

When servicing use only identical Ryobi replacement parts. Use of any other parts may create a hazard or cause product damage.

GENERAL

Avoid using solvents when cleaning plastic parts. Most plastics are susceptible to various types of commercial solvents and may be damaged by their use. Use clean cloths to remove dirt, carbon dust, etc.



WARNING:

Do not at any time let brake fluids, gasoline, petroleum-based products, penetrating oils, etc., come in contact with plastic parts. They contain chemicals that can damage, weaken, or destroy plastic.

When electric tools are used on fiberglass boats, sports cars, wallboard, spackling compounds, or plaster, it has been found that they are subject to accelerated wear and possible premature failure, as the fiberglass chips and grindings are highly abrasive to bearings, brushes, commutators, etc. Consequently, it is not recommended that this tool be used for extended work on any fiberglass material, wallboard, spackling compounds, or plaster. During any use on these materials, it is extremely important that the tool is cleaned frequently by blowing with an air jet.



WARNING:

Always wear safety goggles or safety glasses with side shields during power tool operation or when blowing dust. If operation is dusty, also wear a dust mask.

LUBRICATION

All of the bearings in this tool are lubricated with a sufficient amount of high grade lubricant for the life of the unit under normal operating conditions. Therefore, no further lubrication is required.

EXTENSION CORDS

The use of any extension cord will cause some loss of power. To keep the loss to a minimum and to prevent tool overheating, use an extension cord that is heavy enough to carry the current the tool will draw.

A wire gage size (A.W.G.) of at least **16** is recommended for an extension cord 100 feet or less in length. When working outdoors, use an extension cord that is suitable for outdoor use. The cord's jacket will be marked **WA**.



CAUTION:

Keep extension cords away from any sanding area and position the cord so that it will not get caught on lumber, tools, etc., during sanding operation.



WARNING:

Check extension cords before each use. If damaged replace immediately. Never use tool with a damaged cord since touching the damaged area could cause electrical shock resulting in serious injury.

OPTIONAL ACCESSORIES

The following recommended accessories are current and were available at the time this manual was printed:

4615040	40 Grit Sanding Angles	10 pack
4615060	60 Grit Sanding Angles	10 pack
4615080	80 Grit Sanding Angles	10 pack
4615100	100 Grit Sanding Angles	10 pack
4615150	150 Grit Sanding Angles	10 pack
4615220	220 Grit Sanding Angles	10 pack
4615500	Sanding Angle Assortment	10 pack
4615505	Preparation Pad For Wood	5 pack
4615506	Preparation Pad For Metal	5 pack
4615507	Preparation Pad For Paint	5 pack
4615555	Wax Applicator/Polishing Pad	5 pack
4615510	Scraper Assembly	
4615511	Large Triangular Scraper Blade	
4615520	Scraper Foot Only	
4615521	Teardrop Triangular Scraper Blade	
4615522	Small Triangular Scraper Blade	

Individual sanding grits are available in economical 10 sheet packs.

OPTIONAL POLISHING PADS

The felt pad supplied with your detail sander allows you to easily fit the optional wax applicator/polishing pads for buffing and polishing applications.

OPTIONAL PREPARATION PADS

The felt pad supplied with your detail sander allows you to easily fit the optional preparation pads to dull the surface in preparation for repainting.

OPTIONAL SCRAPER ASSEMBLY

The optional scraper assembly is available to fit to the front of your detail sander. This allows for easy removal of paint from window panes and frames. It is also ideal for removal of built up glue or paint.



WARNING:

The use of attachments not listed above might be hazardous and must not be used.



WARNING:



The operation of any sander can result in foreign objects being thrown into your eyes, which can result in severe eye damage. Before beginning power tool operation, always wear safety goggles or safety glasses with side shields and a full face shield when needed. We recommend Wide Vision Safety Mask for use over eyeglasses or standard safety glasses with side shields.

RYOBI DETAIL SANDER – MODEL NUMBER DS11008

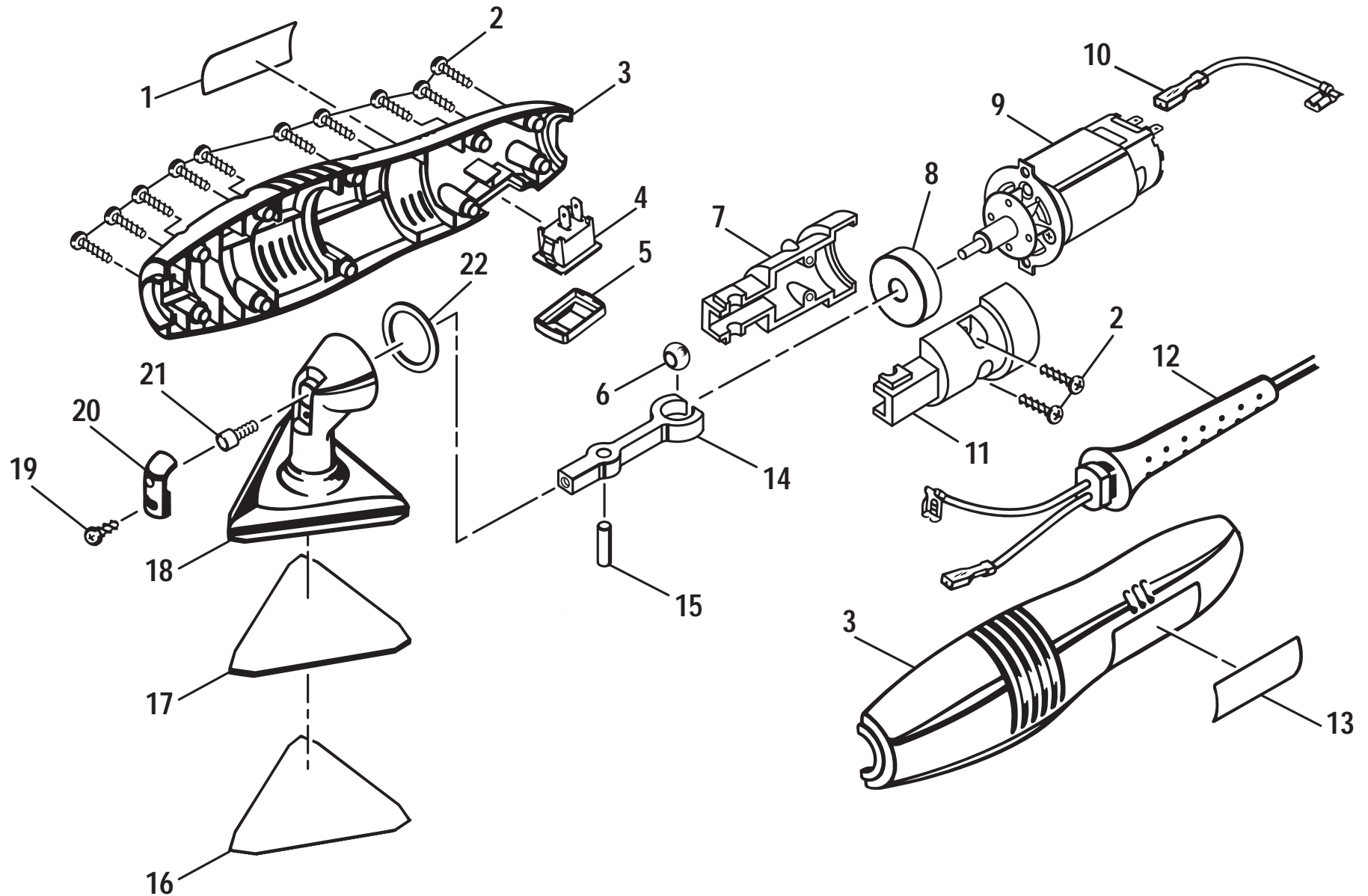

⚠ WARNING:

THE FOOT COVER, KEY NUMBER 20, INSULATES THE CAP SCREW, KEY NUMBER 21, MAKING IT PART OF THE DOUBLE INSULATED SYSTEM. THEREFORE, IT MUST ALWAYS BE REPLACED WHEN REPLACING PARTS OR MAKING REPAIRS TO THIS TOOL.

RYOBI DETAIL SANDER – MODEL NUMBER DS11008

The model number will be found on a plate attached to the motor housing. Always mention the model number in all correspondence regarding your **DETAIL SANDER** or when ordering repair parts.

PARTS LIST

Key No.	Description	Quan.	Key No.	Description	Quan.
1	Data Plate	1	12	Cord Assembly	1
2	Screw (#6-19 x 5/8 in. Pan Hd.)	12	13	Logo Plate	1
3	Housing Assembly	1	14	Arm	1
4	Switch Assembly (Includes Key No. 5)	1	15	Dowel Pin	1
5	Switch Cover	1	16	Sandpaper	1
6	Spherical Ring	1	17	Felt Pad	1
7	Arm Support	1	18	Pad Assembly (Includes No. 17)	1
8	Sleeve Bearing	1	19	Screw (#4-24 x 3/8 in. Pan Hd.)	1
9	Motor Assembly (Includes Key No. 8)	1	20	Foot Cover	1
10	Black Lead	1	21	Cap Screw (#8-32 x 7/16 in. Hex Socket)	1
11	Arm Cover	1	22	Rubber Washer	1
				Owner's Manual	

 **WARNING:**

IMPROPER REPAIR OF A DOUBLE INSULATED TOOL CAN RESULT IN DAMAGES TO THE DOUBLE INSULATION SYSTEM POSSIBLY CAUSING ELECTRICAL SHOCK OR ELECTROCUTION. ANY REPAIRS REQUIRING DISASSEMBLY OF YOUR TOOL REQUIRES SAFETY TESTING AND SHOULD ONLY BE PERFORMED BY AN AUTHORIZED SERVICE CENTER.



OPERATOR'S MANUAL

Detail Sander

Model DS11008

Double Insulated

EXTENSION CORD CAUTION

When using a power tool at a considerable distance from a power source, be sure to use an extension cord that has the capacity to handle the current the tool will draw. An undersized cord will cause a drop in line voltage, resulting in overheating and loss of power. Use the chart to determine the minimum wire size required in an extension cord. Only round jacketed cords should be used.

When working with a tool outdoors, use an extension cord that is designed for outside use. This is indicated by the letters "WA" on the cord's jacket.

Before using any extension cord, inspect it for loose or exposed wires and cut or worn insulation.

** Ampere rating (on tool data plate)						
	0-2.0	2.1-3.4	3.5-5.0	5.1-7.0	7.1-12.0	12.1-16.0
Cord Length	Wire Size (A.W.G.)					
25'	16	16	16	16	14	14
50'	16	16	16	14	14	12
100'	16	16	14	12	10	—

⚠ CAUTION:

Keep the extension cord clear of the working area. Position the cord so that it will not get caught on workpiece, tools, or other obstructions while you are working with a power tool.

***Used on 12 gauge - 20 amp circuit.*

• SERVICE

Now that you have purchased your tool, should a need ever exist for repair parts or service, simply contact your nearest Ryobi Authorized Service Center. Be sure to provide all pertinent facts when you call or visit. Please refer to the Service Center insert or call 1-800-525-2579 in the United States or 1-800-265-6778 in Canada for your nearest Ryobi Authorized Service Center. You can also check our website at www.ryobitools.com for a complete list of Authorized Service Centers.

• MODEL NO. AND SERIAL NO.

The model number and serial number of this tool will be found on a plate attached to the motor housing.

Please record the serial number in the space provided below.

- MODEL NUMBER DS11008
- SERIAL NUMBER _____

RYOBI TECHNOLOGIES INC.

1428 Pearman Dairy Road Anderson, SC 29625
 Post Office Box 1207 Anderson, SC 29622-1207
 Phone 1-800-525-2579

RYOBI TECHNOLOGIES INC.

Post Office Box 910
 Cambridge, Ontario N1R 6K2
 Phone 1-800-265-6778