

SHARP®

ENGLISH

MODEL

CD-BH20

MICRO COMPONENT SYSTEM

OPERATION MANUAL

Thank you for purchasing this SHARP product. To obtain the best performance from this product, please read this manual carefully. It will guide you in operating your SHARP product.

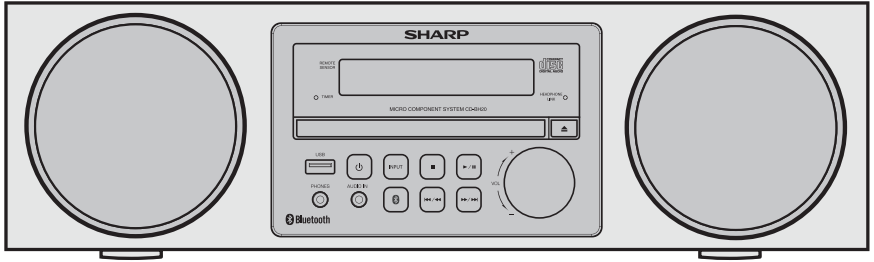



MP3

AM/FM

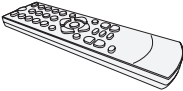

Accessories

Please confirm that only the following accessories are included.

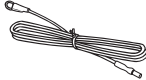
 Remote control x 1 (RRMCGA415AWSA)	 AM loop antenna x 1 (QANTLA016AW01)	 FM antenna x 1 (92LFANT1535A)
--	--	--

Special Note

Supply of this product does not convey a license nor imply any right to distribute content created with this product in revenue-generating broadcast systems (terrestrial, satellite, cable and/or other distribution channels), revenue generating streaming applications (via Internet, intranets and/or other networks), other revenue-generating content distribution systems (pay-audio or audio-on-demand applications and the like) or on revenue-generating physical media (compact discs, digital versatile discs, semiconductor chips, hard drives, memory cards and the like). An independent license for such use is required. For details, please visit <http://mp3licensing.com>

MPEG Layer-3 audio coding technology licensed from Fraunhofer IIS and Thomson.



TINSEAS27AWZZ

SHARP CORPORATION

Printed in Malaysia

18C R KI ①

SPECIAL NOTES

For users in U.S.



CAUTION

RISK OF ELECTRIC SHOCK DO NOT OPEN



CAUTION: TO REDUCE THE RISK OF ELECTRIC SHOCK, DO NOT REMOVE COVER (OR BACK). NO USER-SERVICEABLE PARTS INSIDE. REFER SERVICING TO QUALIFIED SERVICE PERSONNEL.

Explanation of Graphical Symbols:



The lightning flash with arrowhead symbol, within an equilateral triangle, is intended to alert the user to the presence of uninsulated "dangerous voltage" within the product's enclosure that may be of sufficient magnitude to constitute a risk of electric shock to persons.



The exclamation point within an equilateral triangle is intended to alert the user to the presence of important operating and maintenance (servicing) instructions in the literature accompanying the appliance.

WARNING: TO REDUCE THE RISK OF FIRE OR ELECTRIC SHOCK, DO NOT EXPOSE THIS APPLIANCE TO RAIN OR MOISTURE.

This product is classified as a **CLASS 1 LASER PRODUCT**
Caution - Use of any controls, adjustments or procedures other than those specified herein may result in hazardous radiation exposure.

NOTE

This equipment has been tested and found to comply with the limits for a Class B digital device, pursuant to Part 15 of the FCC Rules. These limits are designed to provide reasonable protection against harmful interference in a residential installation. This equipment generates, uses, and can radiate radio frequency energy and, if not installed and used in accordance with the instructions, may cause harmful interference to radio communications. However, there is no guarantee that interference will not occur in a particular installation. If this equipment does cause harmful interference to radio or television reception, which can be determined by turning the equipment off and on, the user is encouraged to try to correct the interference by one or more of the following measures:

- Reorient or relocate the receiving antenna.
- Increase the separation between the equipment and receiver.
- Connect the equipment into an outlet on a circuit different from that to which the receiver is connected.
- Consult the dealer or an experienced radio/TV technician for help.

Warning: Changes or modifications to this unit not expressly approved by the party responsible for compliance could void the user's authority to operate the equipment.

FCC Radiation Exposure Statement

This device complies with the limits for a Class B digital device, pursuant to Part 15 of the FCC Rules. It must not be co-located or operating in conjunction with any other antenna or transmitter.

Operation is subject to the following two conditions:

1. This device may not cause harmful interference, and
2. This device must accept any interference received, including interference that may cause undesired operation.

This equipment should be installed and operated with a minimum distance of 20 cm between the radiator and person's body.

IC Radiation Exposure Statement (For Users In Canada)

This Class B digital apparatus complies with the Canadian ICES-003 Class B specifications. This device complies with Industry Canada license-exempt RSS standard(s).

Operation is subject to the following two conditions:

1. this device may not cause interference, and
2. this device must accept any interference, including interference that may cause undesired operation of the device.

This equipment should be installed and operated with a minimum distance of 20 cm between the radiator and person's body.

Note to CATV system installer:

This reminder is provided to call the CATV system installer's attention to Article 820 of the National Electrical Code that provides guidelines for proper grounding and, in particular, specifies that the cable ground shall be connected to the grounding system of the building, as close to the point of cable entry as practical.

FOR YOUR RECORDS

For your assistance in reporting this unit in case of loss or theft, please record below the model number and serial number which are located on the rear of the unit. Please retain this information.

Model number

Serial number

Date of purchase

Place of purchase

The *Bluetooth*® word mark and logos are registered trademarks owned by the *Bluetooth* SIG, Inc. and any use of such marks by SHARP is under license. Other trademarks and trade names are those of their respective owners.

IMPORTANT SAFETY INSTRUCTIONS

Electricity is used to perform many useful functions, but it can also cause personal injuries and property damage if improperly handled. This product has been engineered and manufactured with the highest priority on safety. However, improper use can result in electric shock and/or fire. In order to prevent potential danger, please observe the following instructions when installing, operating and cleaning the product. To ensure your safety and prolong the service life of this product, please read the following precautions carefully before use.

- 1) Read these instructions.
- 2) Keep these instructions.
- 3) Heed all warnings.
- 4) Follow all instructions.
- 5) Do not use this apparatus near water.
- 6) Clean only with dry cloth.
- 7) Do not block any ventilation openings. Install in accordance with the manufacturer's instructions.
- 8) Do not install near any heat sources such as radiators, heat registers, stoves, or other apparatus (including amplifiers) that produce heat.
- 9) Do not defeat the safety purpose of the polarized or grounding-type plug. A polarized plug has two blades with one wider than the other. A grounding type plug has two blades and a third grounding prong. The wide blade or the third prong are provided for your safety. If the provided plug does not fit into your outlet,

IMPORTANT SAFETY INSTRUCTIONS (continued)

- consult an electrician for replacement of the obsolete outlet.
- 10) Protect the power cord from being walked on or pinched particularly at plugs, convenience receptacles, and the point where they exit from the apparatus.
 - 11) Only use attachments/accessories specified by the manufacturer.
 - 12) Use only with the cart, stand, tripod, bracket, or table specified by the manufacturer, or sold with the apparatus. When a cart is used, use caution when moving the cart/apparatus combination to avoid injury from tip-over.
 - 13) Unplug this apparatus during lightning storms or when unused for long periods of time.
 - 14) Refer all servicing to qualified service personnel. Servicing is required when the apparatus has been damaged in any way, such as power-supply cord or plug is damaged, liquid has been spilled or objects have fallen into the apparatus, the apparatus has been exposed to rain or moisture, does not operate normally, or has been dropped.

Additional Safety Information

- 15) Power Sources - This product should be operated only from the type of power source indicated on the marking label. If you are not sure of the type of power supply to your home, consult your product dealer or local power company. For product intended to operate from battery power, or other sources, refer to the operating instructions.
- 16) Overloading - Do not overload wall outlets, extension cords, or integral convenience receptacles as this can result in a risk of fire or electric shock.
- 17) Object and Liquid Entry - Never push objects of any kind into this product through openings as they may touch dangerous voltage points or short-out parts that could result in a fire or electric shock.
To prevent fire or shock hazard, do not expose this appliance to dripping or splashing. No objects filled with liquids, such as vases, shall be placed on the apparatus.
- 18) Damage Requiring Service - Unplug this product from the wall outlet and refer servicing to qualified service personnel under the following conditions:
 - a. When the AC cord or plug is damaged,
 - b. If liquid has been spilled, or objects have fallen into the product,
 - c. If the product has been exposed to rain or water,
 - d. If the product does not operate normally by following the operating instructions. Adjust only those controls that are covered by the operating instructions as an improper adjustment of other controls may result in damage and will often require extensive work by a qualified technician to restore the product to its normal operation,
 - e. If the product has been dropped or damaged in any way, and
 - f. When the product exhibits a distinct change in performance - this indicates a need for service.
- 19) Replacement Parts - When replacement parts are required, be sure the service technician has used replacement parts specified by the manufacturer or have the same characteristics as the original part. Unauthorized substitutions may result in fire, electric shock, or other hazards.
- 20) Safety Check - Upon completion of any service or repairs to this product, ask the service technician to perform safety checks to determine that the product is in proper operating condition.
- 21) Wall or ceiling mounting - When mounting the product on a wall or ceiling, be sure to install the product according to the method recommended by the manufacturer.
- 22) Power Lines - An outside antenna system should not be located in the vicinity of overhead power lines or other electric light or power circuits, or where it can fall into such power lines or cir-

cuits. When installing an outside antenna system, extreme care should be taken to keep from touching such power lines or circuits as contact with them might be fatal.

- 23) Protective Attachment Plug - The product is equipped with an attachment plug having overload protection. This is a safety feature. See Instruction Manual for replacement or resetting of protective device. If replacement of the plug is required, be sure the service technician has used a replacement plug specified by the manufacturer that has the same overload protection as the original plug.
- 24) Stand - Do not place the product on an unstable cart, stand, tripod or table. Placing the product on an unstable base can cause the product to fall, resulting in serious personal injuries as well as damage to the product. Use only a cart, stand, tripod, bracket or table recommended by the manufacturer or sold with the product. When mounting the product on a wall, be sure to follow the manufacturer's instructions. Use only the mounting hardware recommended by the manufacturer.

Precautions

■ General

- Please ensure that the equipment is positioned in a well ventilated area and ensure that there is at least 6" (15 cm) of free space along the sides, top and back of the equipment.

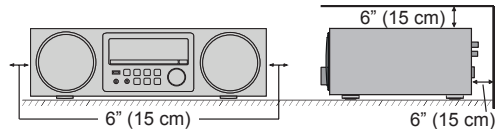

- Use the unit on a firm, level surface free from vibration.
- Place the unit at least 12" (30 cm) away from any CRT TV to avoid color variations across the TV screen. If the variations persist, move the unit further away from the TV. LCD TV is not prone to such variation.
- Keep the unit away from direct sunlight, strong magnetic fields, excessive dust, humidity and electronic/electrical equipment (home computers, facsimiles, etc.) which generate electrical noise.
- Do not place anything on top of the unit.
- Do not expose the unit to moisture, to temperatures higher than 140°F (60°C) or to extremely low temperatures.
- If your system does not work properly, disconnect the AC power cord from the AC outlet. Plug the AC power cord back in, and then turn on your system.
- In case of an electrical storm, unplug the unit for safety.
- Hold the AC power plug by the head when removing it from the AC outlet, as pulling the cord can damage internal wires.
- The AC power plug is used as a disconnect device and shall always remain readily operable.
- **Do not remove the outer cover, as this may result in electric shock. Refer internal service to your local SHARP service facility.**
- This unit should only be used within the range of 41°F - 95°F (5°C - 35°C).

Precautions (continued)

Warning:

The voltage used must be the same as that specified on this unit. Using this product with a higher voltage other than that which is specified is dangerous and may result in a fire or other type of accident causing damage. SHARP will not be held responsible for any damage resulting from use of this unit with a voltage other than that which is specified.

■ Volume control

The sound level at a given volume setting depends on speaker efficiency, location and various other factors. It is advisable to avoid exposure to high volume levels, which occurs while turning the unit on with the volume control setting up high, or while continually listening at high volumes. Excessive sound pressure from earphones and headphones can cause hearing loss.

For U.S. customer only

CONSUMER LIMITED WARRANTY

MIZARI ENTERPRISES, INC. warrants to the first consumer purchaser that this Sharp brand product (the "Product"), when shipped in its original container, will be free from defective workmanship and materials, and agrees that it will, at its option, either repair the defect or replace the defective Product or part thereof with a new or remanufactured equivalent at no charge to the purchaser for parts or labor for the period(s) set forth below.

This warranty does not apply to any appearance items of the Product nor to the additional excluded item(s) set forth below nor to any Product the exterior of which has been damaged or defaced, which has been subjected to improper voltage or other misuse, abnormal service or handling, or which has been altered or modified in design or construction.

In order to enforce the rights under this limited warranty, the purchaser should follow the steps set forth below and provide proof of purchase to the servicer.

The limited warranty described herein is in addition to whatever implied warranties may be granted to purchasers by law. ALL IMPLIED WARRANTIES INCLUDING THE WARRANTIES OF MERCHANTABILITY AND FITNESS FOR USE ARE LIMITED TO THE PERIOD(S) FROM THE DATE OF PURCHASE SET FORTH BELOW. Some states do not allow limitations on how long an implied warranty lasts, so the above limitation may not apply to you.

Neither the sales personnel of the seller nor any other person is authorized to make any warranties other than those described herein, or to extend the duration of any warranties beyond the time period described herein on behalf of MIZARI.

The warranties described herein shall be the sole and exclusive warranties granted by MIZARI and shall be the sole and exclusive remedy available to the purchaser. Correction of defects, in the manner and for the period of time described herein, shall constitute complete fulfillment of all liabilities and responsibilities of MIZARI to the purchaser with respect to the Product, and shall constitute full satisfaction of all claims, whether based on contract, negligence, strict liability or otherwise. In no event shall MIZARI be liable, or in any way responsible, for any damages or defects in the Product which were caused by repairs or attempted repairs performed by anyone other than an authorized servicer. Nor shall MIZARI be liable or in any way responsible for any incidental or consequential economic or property damage. Some states do not allow the exclusion of incidental or consequential damages, so the above exclusion may not apply to you.

THIS LIMITED WARRANTY IS VALID ONLY IN THE FIFTY (50) UNITED STATES, THE DISTRICT OF COLUMBIA AND PUERTO RICO.

Model Specific Section

Your Product Model Number & Description:

**CD-BH20
MICRO COMPONENT SYSTEM**

(Be sure to have this information available when you need service for your Product.)

Warranty Period for this Product:

One (1) year parts and labor from the date of purchase.

Additional Item(s) Excluded from Warranty Coverage (if any):

Accessories, supplies, and consumable items.

What to do to Obtain Service:

Call Sharp toll free at 1-800-BE-SHARP

TO OBTAIN SUPPLY, ACCESSORY OR PRODUCT INFORMATION, CALL **1-800-BE-SHARP**

SHARP is a registered trademarks of SHARP CORPORATION; used under license by SHARP Corporation

MARKETED BY : MIZARI ENTERPRISES, INC.
5455 WILSHIRE BOULEVARD, SUITE 1410,
LOS ANGELES, CA 90036

Manufacturer Address:
S&O ELECTRONICS (MALAYSIA) SDN. BHD.
LOT 202, BAKAR ARANG INDUSTRIAL ESTATE,
08000 SUNGAI PETANI, KEDAH, WEST MALAYSIA.

Controls and indicators

Front panel

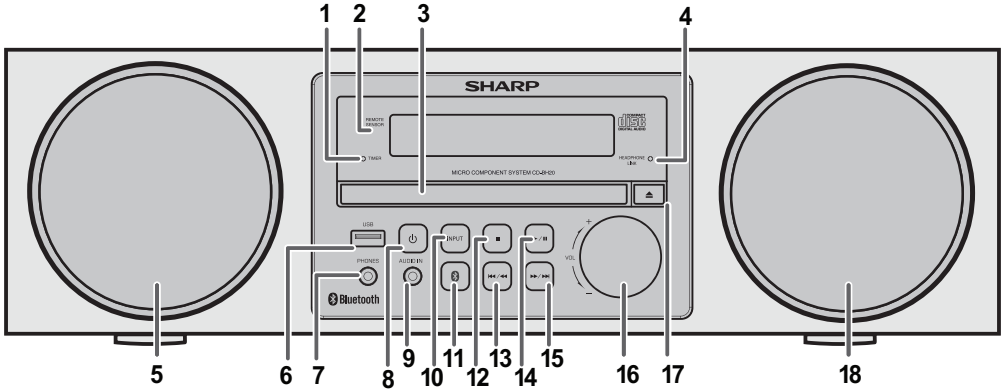

- | | |
|-----------------------------|--|
| 1. Timer Indicator | 11. Bluetooth Pairing Button |
| 2. Remote Sensor | 12. CD/USB Stop Button |
| 3. Disc Tray | 13. Tuner Preset Down, Auto Tuning Down, CD/USB/Bluetooth Skip Down Button |
| 4. Headphone Link Indicator | 14. Disc/USB/Bluetooth Play or Pause Button |
| 5. Left Speaker | 15. Tuner Preset Up, Auto Tuning Up, CD/USB/Bluetooth Skip Up Button |
| 6. USB Terminal | 16. Volume Control |
| 7. Headphone Jack | 17. Disc Tray Open/Close Button |
| 8. ON/STANDBY Button | 18. Right Speaker |
| 9. Audio In Jack | |
| 10. Input Button | |

Rear panel

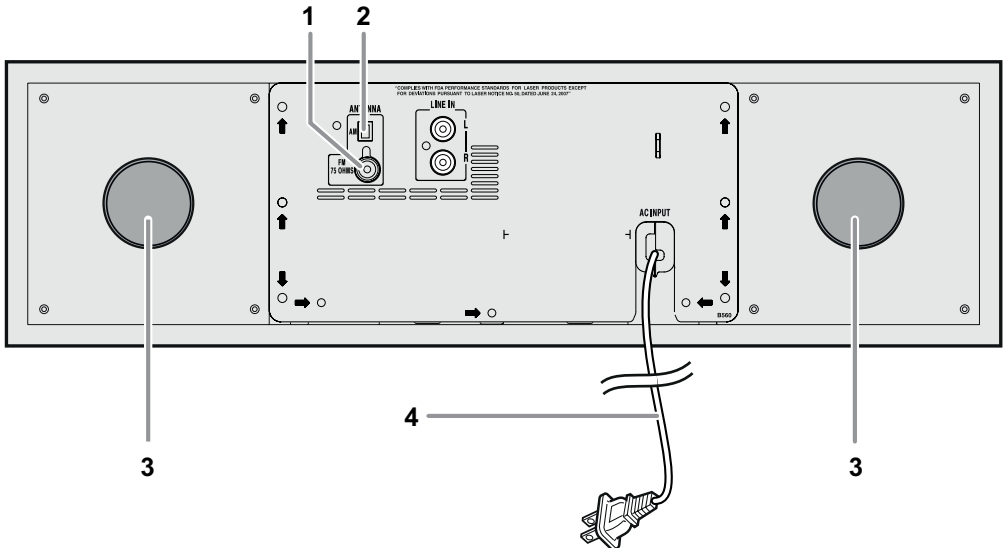

- | | |
|-----------------------------|------------------|
| 1. FM 75 Ohms Antenna Jack | 3. Duct Port |
| 2. AM Loop Antenna Terminal | 4. AC Power Cord |

Controls and indicators (continued)

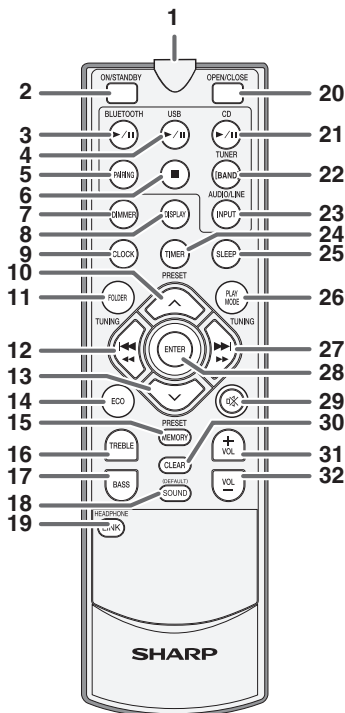

Remote control

- Remote Control Transmitter
- On/Standby Button
- Bluetooth Play / Pause Button
- USB Play / Pause Button
- Pairing Button
- CD/USB Stop Button
- Dimmer Button
- Display Button
- Clock Button
- Tuner Preset Up Button
- Folder Button
- Tuner Preset Down Button
- Eco Button
- Memory Button
- Treble Button
- Bass Button
- Sound (Default) Button
- Headphone Link Button
- Open/Close Button
- CD Play / Pause Button
- Tuner [BAND] Button
- Audio/Line (Input) Button
- Timer Button
- Sleep Button
- Play Mode Button
- Tuning Up, Skip Up, Fast Forward, Time Up Button
- Enter Button
- Mute Button
- Clear Button
- Volume Up Button
- Volume Down Button

Display

- USB Indicator
- CD Indicator
- MP3 Indicator
- RDM (Random) Indicator
- MEM (Memory) Indicator
- Repeat Indicator
- Play/Pause Indicator
- Tuning FM / Bluetooth status Indicator
- FM Stereo Mode Indicator
- Stereo Station Indicator
- Muting Indicator
- Title Indicator
- Artist Indicator
- Folder Indicator
- Album Indicator
- File Indicator
- Track Indicator
- Daily Timer Indicator
- Once Timer Indicator
- Disc Indicator
- Total Indicator
- Sleep Indicator

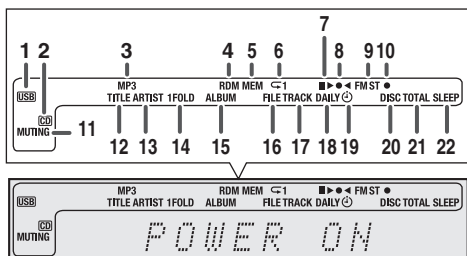

System connection

Make sure to unplug the AC power cord before making any connections.

Installing the AM loop antenna

< Assembling > < Attaching to the wall >

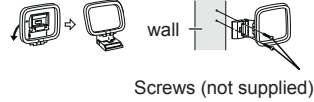

AM loop antenna



Installing the supplied FM antenna

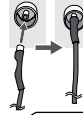

External FM antenna for better reception (not supplied)

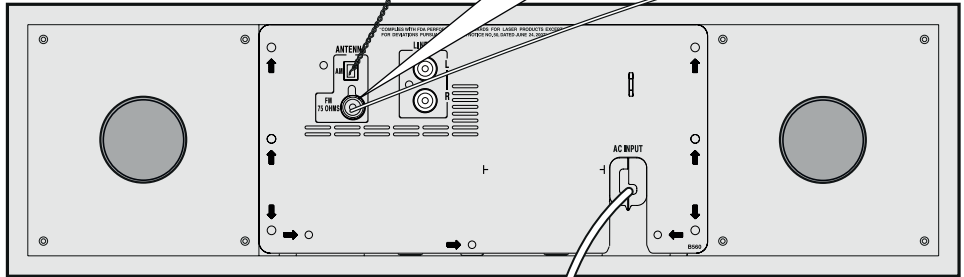

AC outlet
(AC 100 ~ 240 V ~
50/60 Hz)

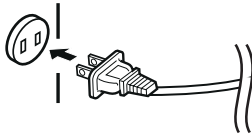

CAUTION:
TO PREVENT ELECTRIC SHOCK,
MATCH WIDE BLADE OF PLUG TO
WIDE SLOT, FULLY INSERT.

■ Line In connection

Connect to the TV using an audio cable.

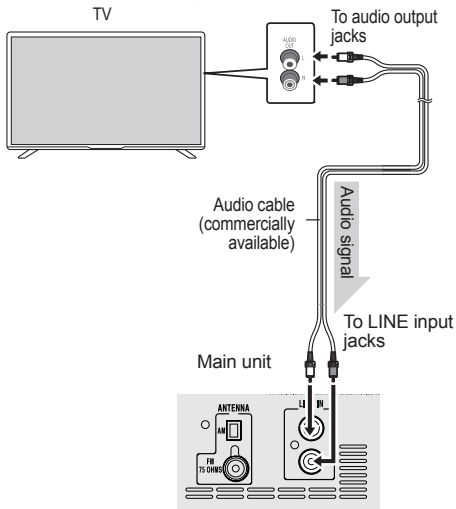

To select Line In function:

- On main unit: Press INPUT button repeatedly until Line In is displayed.
- On remote control: Press AUDIO/LINE (INPUT) button repeatedly until Line In is displayed.

■ Antenna connection

Supplied FM antenna:

Connect to the FM 75 ohms jack and position it where reception is best.

External FM antenna:

Use an external FM antenna (75 ohms coaxial cable) for better reception. Disconnect the supplied FM antenna wire before use.

Supplied AM loop antenna:

Connect to the AM terminal and position it where reception is best. Place it on a shelf, etc., or attach it to a wall with screws (not supplied).

■ Bluetooth standby mode

- The first time the unit is plugged in, it will enter the *Bluetooth* standby mode. "Bluetooth Stby" appears on the display.
- To cancel the *Bluetooth* standby mode, press the ECO button (remote control) during power standby mode. The unit will enter the low power consumption mode.
- To return to the *Bluetooth* standby mode, press the ECO button again.

■ AC power connection

After all connections have been made correctly, plug the AC power cord into the AC outlet.

Note:

Unplug the AC power cord from the AC outlet if the unit will not be in use for a prolonged period of time.

Remote control

Battery installation

Use 2 "AAA" size batteries (UM/SUM-4, R3, HP-16 or similar). Batteries are not included.

- 1 Open the battery cover.
- 2 Insert the batteries according to the terminal indicated in the battery compartment.
When inserting or removing the batteries, push it toward the (-) battery terminals.
- 3 Close the cover.

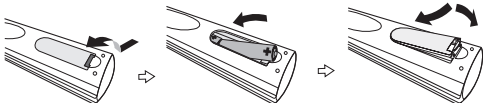

Caution:

- Replace all old batteries with new ones at the same time.
- Do not mix old and new batteries.
- Remove the batteries if the unit will not be used for a long period of time. This will prevent potential damage due to battery leakage.
- Do not use rechargeable batteries (nickel-cadmium battery, etc.).
- Installing the batteries incorrectly may cause the unit to malfunction.
- Batteries (battery pack or batteries installed) shall not be exposed to excessive heat such as sunshine, fire or the like.

Notes concerning use:

- Replace the batteries if the operating distance is reduced or if the operation becomes erratic. Purchase 2 "AAA" size batteries. (UM/SUM-4, R3, HP-16 or similar)
- Periodically clean the transmitter on the remote control and the sensor on the unit with a soft cloth.
- Exposing the sensor on the unit to strong light may interfere with operation. Change the lighting or the direction of the unit if this occurs.
- Keep the remote control away from moisture, heat, shock, and vibrations.

Test of the remote control

The remote control can be used within the range shown below:

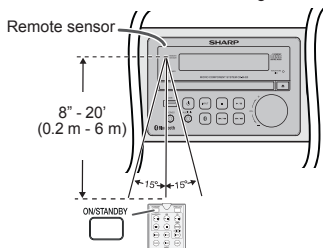

General control

To turn the power on

Press the \odot (ON/STANDBY) button to turn the power on or off.

Display brightness control

Press the DIMMER button (remote control).

- Dimmer 1 (Display is dim).
- ↓
- Dimmer 2 (Display gets dimmer).
- ↓
- Dimmer off (Display is bright).

General control (continued)

Volume auto fade-in

If you turn off and on the main unit with the volume set to 27 or higher, the volume starts at 15 and fades in to the last set level.

Volume control

Turn the volume knob toward VOL +/- (main unit) or press VOL +/- (remote control) to increase or decrease the volume.

Muting

To mute the volume, press the \otimes button (remote control). Press again to restore the volume.

Direct key power on function

When you press any of the following buttons, the unit turns on.

- CD \blacktriangleright /M, USB \blacktriangleright /M, BLUETOOTH \blacktriangleright /M, AUDIO/LINE (INPUT), TUNER [BAND]: Selected function is activated.
- \blacktriangleright /M (main unit): The unit turns on and playback of the last function will start (CD, USB, BLUETOOTH, AUDIO IN, LINE IN, TUNER)
- \blacktriangle (OPEN/CLOSE) (on main unit/remote control): Disc tray opens and the last selected function is activated.

Auto power off function

The main unit will enter the standby mode after approximately 15 minutes of inactivity during:

Audio In/Line In: No detection of input signal.

CD: In the stop mode or no disc.

USB: In the stop mode or no media.

Bluetooth: - No connection after approximately 15 minutes.

- In the pause or stop mode and no incoming signal from device after approximately 15 minutes.

Bass or Treble control

- 1 Press the BASS or TREBLE button to select "Bass" or "Treble" respectively.
- 2 Within 5 seconds, press the VOL (+ or -) button to adjust the bass or treble.

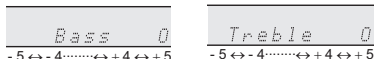

Press SOUND (DEFAULT) button to return sound to default settings. "SOUND DEFAULT" appears on the display.

Sound default settings : Bass = 0, Treble = 0

Function

Press the INPUT button (main unit) repeatedly to select desired function.

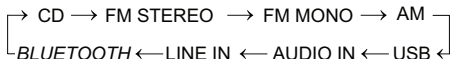

Note:

The backup function will protect the memorized function mode for a few hours should there be a power failure or the AC power cord becomes disconnected.

Setting the clock (Remote control only)

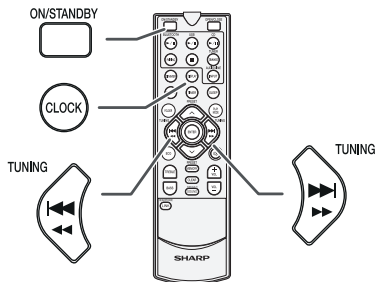

In this example, the clock is set for the 12-hour (AM 12:00) display.

- 1 Press the (ON/STANDBY) button to turn the power on.
- 2 Press the CLOCK button.
- 3 Within 10 seconds, press the ENTER button. To adjust the day, press the or button and then press the ENTER button.
- 4 Press the or button to select 24-hour or 12-hour display and then press the ENTER button.

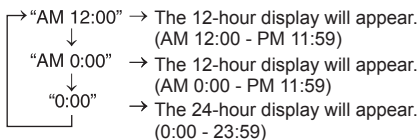

- 5 To adjust the hour, press the or button and then press the ENTER button. Press the or button once to advance the time by 1 hour. Hold it down to advance continuously.
- 6 To adjust the minutes, press the or button and then press the ENTER button. Press the or button once to advance the time by 1 minute. Hold it down to advance the time by 5 minutes interval.

To confirm the time display:

Press the CLOCK button. The time display will appear for about 10 seconds.

Note:

When power supply is restored after unit is plugged in again or after a power failure, reset the clock.

To readjust the clock:

Perform "Setting the clock" from step 1.

To change the 24-hour or 12-hour display:

- 1 Clear all the programmed contents. [Refer to "Factory reset, clearing all memory" on page 18 for details.]
- 2 Perform "Setting the clock" from step 1 onward.

Listening to *Bluetooth* enabled devices

■ *Bluetooth*

Bluetooth wireless technology is a short-range radio technology that enables wireless communication between various types of digital devices, such as mobile phone or computer. It operates within a range of about 30 feet (10 meters) without the hassle of having to use cables to connect these devices.

This unit supports the following:

Communication System: *Bluetooth* Specification version 2.1 *Bluetooth* + Enhanced Data Rate (EDR).
Support Profile : A2DP (Advanced Audio Distribution Profile) and AVRCP (Audio/Video Remote Control Profile)

Notes when using unit with a mobile phone

- This unit cannot be used to talk over the telephone even when there is a *Bluetooth* connection made to a mobile phone.
- Please refer to the operating manual supplied with the mobile phone for details on operation of your mobile phone while transmitting the sound using a *Bluetooth* connection.

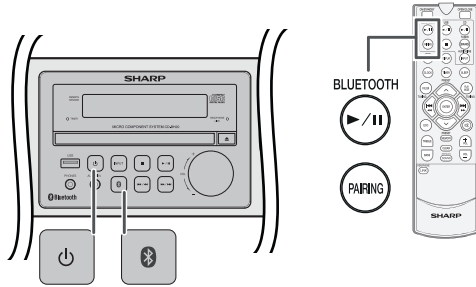

Bluetooth devices need to be initially paired first before they can exchange data. This unit can memorize up to a maximum of 20 devices. Once paired, it is not necessary to pair them again unless:

- pairing is made with more than 20 devices. Pairing can only be made one device at a time. If subsequent device is paired, the oldest device paired will be deleted and replaced with the new one.
- this unit is reset. All pairing information is deleted when unit is reset.

Indicators:

Indicator	Condition	<i>Bluetooth</i> status
▶●◀	Lights up	Connected
No indication		Unconnected

However, the indication status is not displayed during *Bluetooth* standby mode.

■ Pairing with *Bluetooth* source devices

- 1 Press the \odot (ON/STANDBY) button to turn the power on.
- 2 Press the BLUETOOTH button on the main unit or *BLUETOOTH* \blacktriangleright / \blacktriangleleft button on the remote control to select *Bluetooth* function. "*BLUETOOTH*" appears on the display.
- 3 Perform pairing procedure on the source device to detect this unit. "CD-BH20 SHARP" will appear in the detected devices list (if available) in the source device. (Refer the source device operating manual for details).

Notes:

- Place the devices to be paired within 3 feet (1 meter) of each other when pairing.
 - Some source devices are unable to display lists of detected devices. To pair this unit with the source device, refer to the source device operating manual for details.
- 4 Select "CD-BH20 SHARP" from the source list. If Passcode* is required, enter "0000".
 - * Passcode may be called PIN Code, Passkey, PIN number or Password.
 - 5 "Connected" appears on the display once the unit is successfully paired with the source device. (Pairing information is now memorized in the unit.) Some audio source devices may connect with the unit automatically after pairing is completed, otherwise follow the instructions in the source device operating manual to start connection.
 - 6 Press the play button on main unit, remote control or source device to start *Bluetooth* streaming playback.

Notes:



- If a device such as microwave oven, wireless LAN card, *Bluetooth* device or any other device that uses the same 2.4 GHz frequency is placed near the system some sound interruption may be heard.
- The transmission distance of the wireless signal between the device and the main unit is about 32 feet (10 meters), but may vary depending on your operating environment.
- If a steel concrete or metallic wall is between the device and the main unit, the system may not operate at all, because the wireless signal cannot penetrate metal.
- If this unit or the source device is turned off before *Bluetooth* connection is completed, pairing will not be completed and the pairing information will not be memorized. Repeat step 1 onward to start pairing again.
- To pair with other devices, repeat steps 1 - 5 for each device. This unit can memorize up to a maximum of 20 devices. If subsequent device is paired, the oldest device paired will be deleted.
- Once a device is ousted or deleted from the pairing list, the pairing information for the device is also deleted. To listen to the sound from the device again, it needs to be re-paired. Perform steps 1 - 5 to pair the device again.
- Some music applications do not support *Bluetooth* Profile AVRCP 1.4, hence there will be no volume synchronization and no song information will be displayed even if your *Bluetooth* device supports such profile.

Listening to *Bluetooth* enabled devices (continued)

■ Listening to the sound

Check that:

- The source device *Bluetooth* functionality is ON.
- Pairing of this unit and the source device is completed.
- Unit is in connected mode.

- 1 Press the  (ON/STANDBY) button to turn the power on.
- 2 Press the  button on the main unit or *BLUETOOTH* button on the remote control to select Bluetooth function.
- 3 Start the *Bluetooth* connection from the *Bluetooth* audio source device.
- 4 Press the *BLUETOOTH*  button.







Notes:

- If the source device has an extra bass function or equalizer function, set them to off to avoid sound distortion.

Notes:

- Make the *Bluetooth* connection again if the source device is not turned on, or its *Bluetooth* functionality is off or is in sleep mode.
- The volume of this unit may not be controlled as intended depending on the device.

Bluetooth operation buttons

Main unit	Remote control	Operation
		Press the button to play or pause.
		Press the button to skip to next track. Press and hold to fast forward.
		Press the button to skip to previous track. Press and hold to fast reverse.

■ To disconnect the *Bluetooth* device

Perform any of the followings.

- Press PAIRING button until "Disconnected" appears on the display.
- Disconnect or turn off the *Bluetooth* connection on the audio source device. Refer the operating manual supplied with the device.
- Turn off this unit.

■ Auto power on

During *Bluetooth* standby mode, the unit will automatically power on when the *Bluetooth* connection is set up between the main unit and your device.



Note:

This function is not applicable during *Bluetooth* standby mode off.

■ Link to *Bluetooth* headphone

You can connect a set of *Bluetooth* headphones to this unit. Before making the connection, check that:

- The *Bluetooth* headphone to be connected is in pairing mode and within range.

- 1 Select a desired function to listen to, except for *Bluetooth* function.
- 2 Press and hold the HEADPHONE LINK button on the remote control until "Headphone Link" appears on the display.
- 3 Press ENTER button. "Searching" appears on the display.
- 4 After finish searching, the nearby devices' names will be shown on the display. Press  or  to select the desired device and then press ENTER button. "Connected" appears on the display and Headphone Link LED (green) lights up.
 - If your device does not appear on the list, do the following:
 - Make sure the *Bluetooth* headphone is still in pairing mode. Refer to the manual supplied with it.
 - Press  button.
 - Repeat steps 2 - 4.

Notes:

- Connection to *Bluetooth* headphone is valid in all function except *Bluetooth*.
- *Bluetooth* headphone connection will be terminated in *Bluetooth* function.
- When connected with Headphone Link, speaker output is muted.
- Volume can be controlled on both main unit and the connected *Bluetooth* headphone separately.

To disconnect the *Bluetooth* headphone:

Turn off the *Bluetooth* mode on the connected *Bluetooth* headphone. Refer to the manual supplied with it.

"Disconnected" appears and Headphone Link LED (green) lights off.

To re-link with the previous headphone device:

The device must be in pairing mode and within range.

- 1 Press the HEADPHONE LINK button. "Headphone Link" will be blinking depending on the last connection.
- 2 Within 5 seconds press the ENTER button. "Linking" will be displayed. "Connected" appears if re-link process is successful.

Note:

If "Not found" appears, repeat from step 1. Make sure that the device to be connected is within range and in pairing mode.

Listening to a CD or MP3 disc

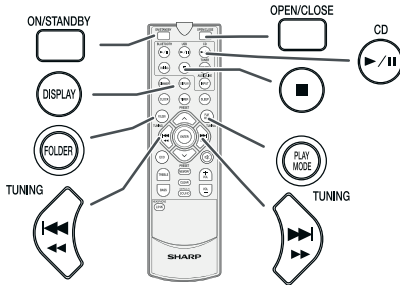
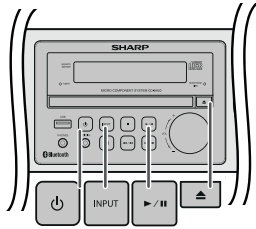

■ Disc playback

- 1 Press the **ON/STANDBY** button to turn the power on.
- 2 Press the **INPUT** button repeatedly on the main unit to select CD function.
- 3 Press the **OPEN/CLOSE** button to open the disc compartment.
- 4 Place the disc on the disc compartment, label side up.
- 5 Press the **OPEN/CLOSE** button to close the disc tray.
- 6 Press the **CD ►/||** button to start playback.

To stop playback:

Press the **■** button.

Caution:

- Do not place two discs in one-disc-tray.
- Do not play discs of special shapes (heart, octagon, etc.) It may cause malfunction.
- Do not push the disc tray while it is moving.
- If the power fails wait until the power is restored.
- If TV or radio interference occurs during CD operation, move the unit away from the TV or radio.
- If using an 3" (8 cm) disc, ensure that it is placed in the center of the disc tray.
- Due to the structure of the disc information, it takes longer to read an MP3 disc than a normal CD (approximately 20 to 90 seconds).

Note for CD or MP3 disc:

- Rewritable multi-session discs with unfinished writing, can still be played.

■ To resume playback after stopping (resume play) (MP3 only)

You can resume playback from the track playback is stopped.

- 1 While a disc is playing, press the **■** button once.
- 2 To resume play, press the **CD ►/||** button. Playback resumes from the track you stopped.

To cancel the resume playback:

Press the **■** button twice.

■ Various disc functions

Function	Main unit	Remote control	Operation
Play			Press in the stop mode.
Pause			Press in the playback mode. Press the ►/ button to resume playback from the paused point.
Stop			Press in the playback mode.
Track up/down			Press in the playback or stop mode. If you press the button in the stop mode, press the ►/ button to start the desired track.
Fast forward/reverse			Press and hold down in the playback mode. Release the button to resume playback.

■ Random play

To random play all tracks:

Press **PLAY MODE** button on the remote control repeatedly until "Random" appears. Press the **►/||** (CD **►/||**) button.

To cancel random play:

Press the **PLAY MODE** button again until "Normal" appears. "RDM" indicator will disappear.



Notes:

- If you press the **►/||** button during random play, you can move to the track selected next by the random operation. However, the **◀/◀◀** button does not allow you to move to the previous track. The beginning of the track being played will be located.
- In random play, the unit will select and play tracks automatically. (You cannot select the order of the tracks.)
- In folder mode on, only tracks in selected folder will be played randomly.

Listening to a CD or MP3 disc (continued)

Repeat play

Repeat play can play one track, all tracks or a programmed sequence continuously.

To repeat one track:

Select desired track using the \lll / \ll or \gg / \ggg button. Press the PLAY MODE button repeatedly until "Repeat One" appears. Press the $\blacktriangleright/\parallel$ (CD $\blacktriangleright/\parallel$) button.

To repeat all tracks:

Press the PLAY MODE button repeatedly until "Repeat All" appears. Press the $\blacktriangleright/\parallel$ (CD $\blacktriangleright/\parallel$) button.

To repeat desired tracks:

Perform steps 1 - 5 in "Programmed play" section on this page and then press the PLAY MODE button repeatedly until "Memory Repeat" appears.

To repeat one folder:

While in Folder mode on (MP3), press PRESET (\surd or \wedge) to select desired folder. Press PLAY MODE button repeatedly until "Repeat Folder" appears. Press the $\blacktriangleright/\parallel$ (CD $\blacktriangleright/\parallel$) button.

To cancel repeat play:

Press the PLAY MODE button repeatedly until "Normal" appears and G disappears.



Caution:

After performing repeat play, be sure to press the \blacksquare button. Otherwise, the disc will play continuously.

Programmed play (CD)

- 1 While in the stop mode, press the MEMORY button on the remote control to enter the programming save mode.
- 2 Press the \lll / \ll or \gg / \ggg button to select the desired track.



Selected track number

- 3 Press the MEMORY button to save the track number.
- 4 Repeat steps 2 - 3 for other tracks. Up to 32 tracks can be programmed. If you want to check the programmed tracks, during stop mode, press the MEMORY button repeatedly. To clear the programmed tracks, press the CLEAR button.
- 5 Press the $\blacktriangleright/\parallel$ (CD $\blacktriangleright/\parallel$) button to start playback.

Programmed play (MP3)

- 1 While in the stop mode, press the MEMORY button to enter the programming save mode.
- 2 Press the PRESET (\surd or \wedge) button on the remote control to select the desired folder.



Then press the \lll / \ll or \gg / \ggg button (remote control) to select the desired tracks.



- 3 Press the MEMORY button to save the folder and track number.
- 4 Repeat steps 2 - 3 for other folder/tracks. Up to 32 tracks can be programmed.
- 5 Press the $\blacktriangleright/\parallel$ (CD $\blacktriangleright/\parallel$) button to start playback.

To cancel the programmed play mode:

During programmed stop mode, press the \blacksquare button. The display will show "Memory Clear" and all the programmed contents will be cleared.

Adding tracks to the program:

If a program has been previously stored, the "MEM" indicator will be displayed. During stop mode, press the MEMORY button once. Within 10 seconds, press and hold the MEMORY button again. Then follow steps 2 - 3 to add tracks.

Notes:

- When the disc compartment is opened, the program is automatically canceled.
- If you press the O (ON/STANDBY) button to enter the standby mode or change the function from CD to another, the programmed selections will be cleared.

Procedure to playback MP3 disc with folder mode on

To play back CD-R/RW.

- 1 In CD function, load an MP3 disc. Press the FOLDER button and disc info will be displayed.



Total number of folder Total number of files

- 2 Press the PRESET (\surd or \wedge) button to select desired playback folder. (Folder mode on)

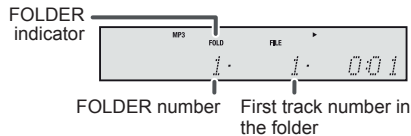

FOLDER number First track number in the folder

- 3 Select desired file to be played back by pressing the \lll / \ll or \gg / \ggg button.
- 4 Press the $\blacktriangleright/\parallel$ (CD $\blacktriangleright/\parallel$) button. Playback will start and file name will be displayed.

- Title, Artist and Album name are displayed if they are recorded on the disc.
- In case of playback with the folder mode on, press the PRESET (\surd or \wedge) button, and the folder can be selected even though it is in playback/pause mode. It will continue playback/pause mode in the 1st track of the selected folder.
- Display content can be changed by pressing the DISPLAY button.

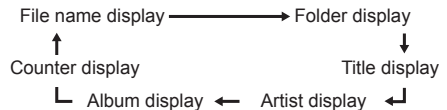

Note:

If "Not Supported" is displayed, it means "Not supported playback file" is selected.

Listening to USB mass storage device/MP3 player

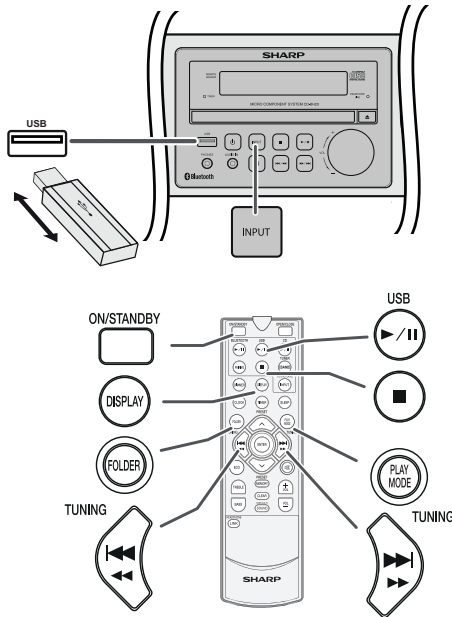

Note:

This product is not compatible with MTP and AAC file systems from USB mass storage device or MP3 player.

■ To play back USB/MP3 player with folder mode on / off

- 1 Press the INPUT button (main unit) repeatedly to select USB function. Connect the USB memory device that has MP3 format files on the unit. When the USB memory is connected to the main unit, the device information will be displayed.
To playback with folder mode on, follow step 2 below.
To playback with folder mode off, skip to step 3 below.
- 2 Press the FOLDER button, and press the PRESET (∨ or ∟) button to select desired playback folder. To start playback, go to step 4. To change the playback folder, press the PRESET (∨ or ∟) button to select another folder.
- 3 Select desired file to be played back by pressing the ◀◀/▶▶ or ▶▶/▶▶ button.
- 4 Press the ▶/|| (USB ▶/||) button. Playback will start and the file name will be displayed.
 - Title, Artist and Album name are displayed if they are recorded in the USB memory device.
 - Display content can be changed by pressing the DISPLAY button.

Note:

To pause playback:
Press the ▶/|| (USB ▶/||) button.

■ To remove USB memory device

- 1 Press the ■ button twice to stop playback.
- 2 Disconnect USB memory device from the USB terminal.

Notes:

- SHARP will not be held liable for the loss of data while the USB memory device is connected to the audio system.
- Files compressed in MP3 format can be played back when connected to the USB terminal.
- This USB memory's format supports FAT 16 or FAT 32.
- SHARP cannot guarantee that all USB memory devices will work on this audio system.
- USB cable is not recommended for use in this audio system to connect to USB memory device. Use of the USB cable will affect the performance of this audio system.
- This USB memory cannot be operated via USB hub.
- The USB terminal in this unit is not intended for a PC connection.
- External HDD-storage cannot be played back via USB terminal.
- If the data inside the USB memory is large, it may take longer time for the data to be read.
- This product can play MP3 files. It will automatically detect the file type being played. If unplayable file is played on this product, "Not Supported" is indicated and the file will be automatically skipped. This will take a few seconds. If abnormal indications appear on the display due to the unspecified file, turn off the unit and then turn it on again.
- This product relates to USB mass storage devices and MP3 players. It may however face some irregularities due to various unforeseen reasons from some devices. Should this happen, turn off the unit and then turn it on again.

The following functions are the same as CD operations:

	Page
Various disc functions	11
Random play	11
Repeat play	12
Programmed play (MP3)	12

Notes:

- If USB memory device is not connected, "USB No Media" will be shown on the display.
- Fast forward/reverse is invalid when playing back a variable bitrate file.

Notes:

- This unit only supports "MPEG-1 Audio Layer-3" format. (Sampling Frequency is 32, 44.1, 48kHz)
- Playback order for MP3 files may differ depending on the writing software used during file download.
- Bitrate which is supported by MP3 is 32~320 kbps.
- Files without MP3 format cannot be played back.
- Playlists are not supported on this unit.
- This unit can display Folder Name or File Name up to 32 characters.
- Total number of folders read is 999 including folder with non-playable file. However, the display shows only folder with MP3 files.
- The display playback time may not be displayed correctly when playing back a variable bitrate file.

Listening to the radio

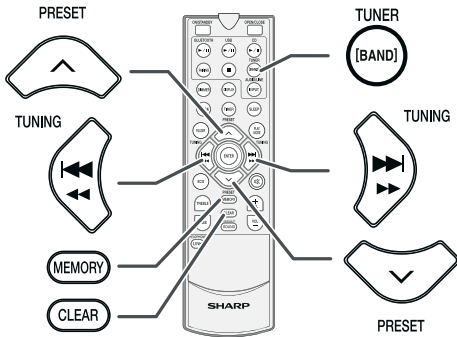
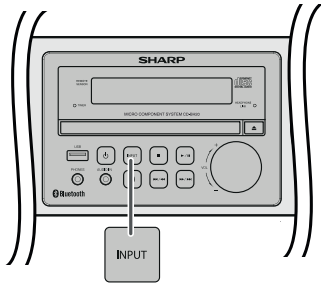

Tuning

- 1 Press the ON/STANDBY button to turn the power on.
- 2 Press the TUNER (BAND) button (remote control) or INPUT button (main unit) repeatedly to select FM Stereo, FM Mono or AM.
- 3 **Manual tuning:**
Press the TUNING ($\text{<-<-< / >>> / >>>$) button (remote control) repeatedly to tune in to the desired station.
Auto tuning:
Press and hold the TUNING ($\text{<-<-< / >>> / >>>$) button. Scanning will start automatically and the tuner will stop at the first receivable broadcast station.

Notes:

- When radio interference occurs, auto scan tuning may stop automatically at that point.
- Auto scan tuning will skip weak signal stations.
- To stop the auto tuning, press the TUNING ($\text{<-<-< / >>> / >>>$) button again.

To receive an FM stereo transmission:

- Press the TUNER (BAND) button to select stereo mode. "ST" indicator will be displayed. "▶◀" and "•" will appear when an FM broadcast is in stereo.
- If the FM reception is weak, press the TUNER (BAND) button to extinguish the "ST" indicator. The reception changes to monaural, and the sound becomes clearer.

Memorizing a station

You can store 40 AM and FM stations in memory and recall them at the push of a button. (Preset tuning)

- 1 Perform steps 2 - 3 in "Tuning".
- 2 Press the MEMORY button.



- 3 Within 30 seconds, press the PRESET ($\text{<-<-< / >>> / >>>$) button to select the preset channel number. Store the stations in memory, in order, starting with preset channel 1.
- 4 Within 30 seconds, press the MEMORY button to store that station in memory. If the "MEM" and preset number indicators disappear before the station is memorized, repeat the operation from step 2.
- 5 Repeat steps 1 - 4 to set other stations, or to change a preset station. When a new station is stored in the memory, the station previously memorized for that preset channel number will be erased.

Note:

The backup function protects the memorized stations for a few hours should there be a power failure or the AC power cord become disconnected.

To recall a memorized station

Press the PRESET ($\text{<-<-< / >>> / >>>$) button to select the desired station.

To scan the preset stations

- 1 Press and hold the PRESET ($\text{<-<-< / >>> / >>>$) button until the preset number flashes. The programmed stations will be tuned in sequentially, for 5 seconds each.
- 2 Press the PRESET ($\text{<-<-< / >>> / >>>$) button again when the desired station is located.

To erase entire preset memory

- 1 Press the ON/STANDBY button to turn the power on.
- 2 Press the INPUT button (main unit) repeatedly or TUNER (BAND) button (remote control) to select Tuner function.
- 3 In Tuner function, press and hold the CLEAR button (remote control) until "Tuner Clear" appears.

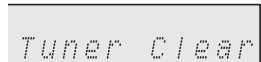

Timer and sleep operation (Remote control only)

Timer playback:

The unit turns on and plays the desired source (CD, TUNER, USB, AUDIO IN, LINE IN) at a preset time.

This unit has 2 types of timer: ONCE TIMER and DAILY TIMER.

Once timer (“⊙” indicator):

Once timer play works for one time only at a preset time.

Daily timer (“DAILY” indicator):

Daily timer play works at the same preset time every day that we set. For example, set the timer as a wake-up call every morning.

Using the once timer and daily timer in combination:

For example, use the once timer to listen to a radio program, and use the daily timer to wake up.

1 Set the daily and once timer (page 15).

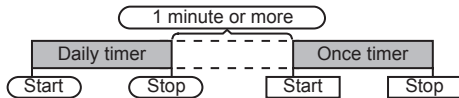

■ Timer playback

Before setting timer:

- Check that the clock is set to the correct time (refer to page 8). If it is not set, you cannot use the timer function.
- For timer playback: Plug in USB or load discs to be played.

- 1 Press the (ON/STANDBY) button to turn the power on.
- 2 Press the TIMER button.
- 3 Press the / button to select “Once” or “Daily”, and press the ENTER button.
- 4 Press the / button to select “Timer Set”, and press the ENTER button.
- 5 To select the timer playback source (CD, TUNER, USB, AUDIO IN, LINE IN), press the / button. Press the ENTER button.
When you select the tuner, select a station by pressing the / button, and then press the ENTER button. If a station has not been programmed, “No Preset” will be displayed and timer setting will be canceled. To memorize a station, refer ‘Memorising a station’ on page 14.
- 6 To adjust the day, press the / button and then press the ENTER button.
- 7 Press the / button to adjust the hour, and then press the ENTER button.
- 8 To adjust the minutes, press the / button and then press the ENTER button.
- 9 Set the time to finish as in steps 7 and 8 above.
- 10 To adjust the volume, press the / button and then press the ENTER button.
- 11 Press the (ON/STANDBY) button to enter the power standby mode. “TIMER” indicator lights up.

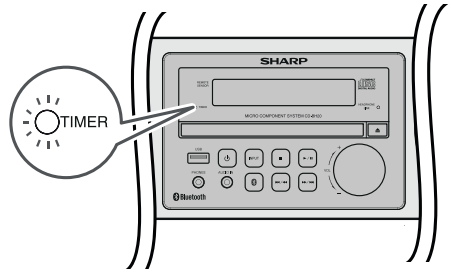

12 When the preset time is reached, playback will start. The volume will increase gradually until it reaches the preset volume. The timer indicator will blink during timer playback.

13 When the timer end time is reached, the system will enter the power standby mode automatically.

Once timer:

The timer will be canceled.

Daily timer:

The timer operates at the same time every selected day. Cancel the daily timer when it is not in use.

Notes:

- When performing timer playback using another unit connected to the USB terminal or AUDIO IN or LINE IN jack, select “USB” or “AUDIO IN” or “LINE IN” in step 5. This unit will turn on or enter the power standby mode automatically. However, the connected unit will not turn on or off.
- To stop the timer playback, follow step “**Cancelling the timer setting**” of this page.

Checking the timer setting:

- 1 Turn the power on. Press the TIMER button.
- 2 Press the / button to select “Once” or “Daily”, and press the ENTER button.
- 3 Press the / button to select “Timer Call”, and press the ENTER button.

Cancelling the timer setting:

- 1 Turn the power on. Press the TIMER button.
- 2 Press the / button to select “Once” or “Daily”, and press the ENTER button.
- 3 Press the / button to select “Timer Off”, and press the ENTER button. Timer will be canceled (the setting will not be canceled).

Reusing the memorized timer setting:

The timer setting will be memorized once it is entered. To reuse the same setting, perform the following operations.

- 1 Turn the power on. Press the TIMER button.
- 2 Press the / button to select “Once” or “Daily”, and press the ENTER button.
- 3 Press the / button to select “Timer On”, and press the ENTER button.
- 4 Press the (ON/STANDBY) button to enter the power standby mode.

Timer and sleep operation (Remote control only) (continued)

■ Sleep operation

The radio, disc, USB, Audio In, Line In, and *Bluetooth* can all be turned off automatically.

- 1 Play back the desired sound source.
- 2 Press the SLEEP button.
- 3 Within 5 seconds, press the SLEEP button repeatedly to select the time.
"Sleep 90" → "Sleep 80" ... → "Sleep 10" →
→ "Sleep Off"
- 4 "SLEEP" indicator will appear.
- 5 The unit will enter the power standby mode automatically after the preset time has elapsed. The volume will be turned down 1 minute before the sleep operation finishes.

To confirm the remaining sleep time:

- 1 While "SLEEP" is indicated, press the SLEEP button.

To cancel the sleep operation:

Press the \cup (ON/STANDBY) button while "SLEEP" is indicated. To cancel the sleep operation without setting the unit to the standby mode, proceed as follows.

- 1 While "SLEEP" is indicated, press the SLEEP button.
- 2 Within 5 seconds, press the SLEEP button repeatedly until "Sleep Off" appears.

■ To use timer and sleep operation together

Sleep and timer playback:

For example, you can fall asleep listening to the radio and wake up to CD the next morning.

- 1 Set the sleep time (see above, steps 1 - 5).
- 2 While the sleep timer is set, set the timer playback (steps 2 - 10, page 15).

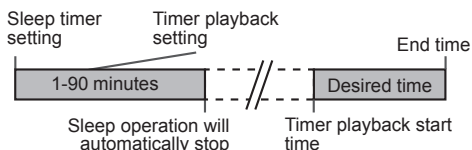

Enhancing your system

The connection cord is not included. Purchase a commercially available cord as shown below.

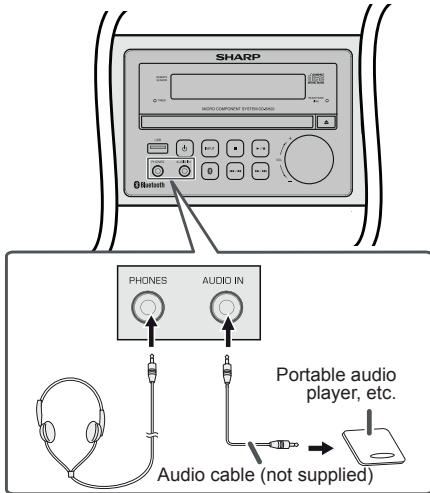

■ Listening to the playback sounds of portable audio player, etc.

- 1 Use a connection cord to connect the portable audio player, etc. to the AUDIO IN jack.
- 2 Press the ON/STANDBY button to turn the power on.
- 3 Press the INPUT (AUDIO/LINE (INPUT)) button (main unit or remote control) repeatedly to select AUDIO IN function.
- 4 Play the connected equipment. If volume level of the connected device is too high, sound distortion may occur. Should this happen, adjust the volume of the connected device.

Note:

To prevent noise interference, place the unit away from the television.

■ Headphones

- Do not set the volume on to maximum at switch on. Excessive sound pressure from earphones and headphones can cause hearing loss.
- Before plugging in or unplugging the headphone, reduce the volume.
- Be sure your headphone has a 1/8" (3.5mm) diameter plug and impedance between 16 and 50 ohms. The recommended impedance is 32 ohms.
- Plugging in the headphone disconnects the speakers automatically.

Troubleshooting chart

If something is wrong with this product, check the following before calling your authorized SHARP dealer or service center.

■ General

Symptom	Possible cause
● The clock is not set to the correct time.	● A power failure occurred. Reset the clock. (Refer page 8)
● When a button is pressed, the unit does not respond.	<ul style="list-style-type: none"> ● Set the unit to the power standby mode and then turn it back on. ● If the unit still malfunctions, reset it. (Refer page 18)
● No sound is heard.	<ul style="list-style-type: none"> ● The volume level set to "Volume Min". ● The headphones are connected.

■ Remote control

Symptom	Possible cause
● The remote control does not operate.	<ul style="list-style-type: none"> ● The AC power cord of the unit is not plugged in. ● The battery polarity is wrong. ● The batteries are dead. ● The distance or angle is incorrect. ● The remote control sensor receives strong light.

■ Tuner

Symptom	Possible cause
● The radio makes unusual noises continuously.	<ul style="list-style-type: none"> ● The unit placed near a TV or computer. ● The FM/AM antenna is not placed properly. Move the antenna away from the AC power cord if it is located nearby.

■ Bluetooth

Symptom	Possible cause
● No sound is heard.	<ul style="list-style-type: none"> ● The unit is too far from the <i>Bluetooth</i> audio source device. ● The unit is not paired with the <i>Bluetooth</i> audio source device.
● <i>Bluetooth</i> sound is interrupted or distorted.	<ul style="list-style-type: none"> ● The unit is too near to a device that generates electromagnetic radiation. ● There is an obstacle between the unit and the <i>Bluetooth</i> audio source device.

Troubleshooting chart (continued)

■ CD player

Symptom	Possible cause
<ul style="list-style-type: none"> ● Playback does not start. ● Playback stops in the middle or is not performed properly. 	<ul style="list-style-type: none"> ● The disc is loaded upside down. ● The disc does not satisfy the standards. ● The disc is distorted or scratched.
<ul style="list-style-type: none"> ● Playback sounds are skipped, or stopped in the middle of a track. 	<ul style="list-style-type: none"> ● The unit is located near excessive vibrations. ● Very dirty disc has been used. ● Condensation has formed inside the unit.

■ USB

Symptom	Possible cause
<ul style="list-style-type: none"> ● Device cannot be detected. ● Playback does not start. 	<ul style="list-style-type: none"> ● There is no MP3 file inside the device. ● The device is not properly plugged in. ● An MTP device is plugged in. ● The device contains AAC file only. ● A copyright-protected or false MP3 file is being played back.
<ul style="list-style-type: none"> ● Wrong time display. ● Wrong file name display. 	<ul style="list-style-type: none"> ● A Variable Bitrate files are being played back. ● The File Name was written in other than English characters.

■ Condensation

Sudden temperature changes, storage or operation in an extremely humid environment may cause condensation inside the cabinet (CD pickup, etc.) or on the transmitter on the remote control. Condensation can cause the unit to malfunction. If this happens, leave the power on with no disc in the unit until normal playback is possible (about 1 hour). Wipe off any condensation on the transmitter with a soft cloth before operating the unit.

■ If problem occurs

When this product is subject to strong external interference (mechanical shock, excessive static electricity, abnormal supply voltage due to lightning, etc.) or if it is operated incorrectly, it may malfunction.

If such a problem occurs, do the following:

- 1 Set the unit to the standby mode and turn the power on again.
- 2 If the unit is not restored in the previous operation, unplug and plug in the unit again, and then turn the power on.

Note:

If neither operation above restores the unit, clear all the memory by resetting it.

■ Factory reset, clearing all memory

- 1 Press the \odot (ON/STANDBY) button to turn the power on.
- 2 Press INPUT button (main unit) repeatedly to enter Audio In mode.
- 3 Press \lll / \lll button (main unit) once.
- 4 Press and hold \blacksquare button (main unit) until "RESET" appears.



Caution:

This operation will erase all data stored in memory including clock, timer settings and tuner preset.

■ Before transporting the unit

Remove all devices connected to the unit. Then, set the unit to the power standby mode. Carrying the unit with other devices left connected or discs left inside might damage the unit.

■ Care of discs

Discs are fairly resistant to damage. However mistracking can occur due to accumulation of dirt on the surface.

- Do not mark on the non-label side of the disc from which signals are read.
- Keep your discs away from direct sunlight, heat, and excessive moisture.
- Always hold the discs by the edges. Fingerprints, dirt, or water on the CDs can cause noise or mistracking. Clean it with a soft, dry cloth, wiping straight out from the center, along the radius.



Maintenance

■ Cleaning the cabinet

Periodically wipe the cabinet with a soft cloth and a diluted soap solution, then with a dry cloth.

Caution:

- Do not use chemicals for cleaning (gasoline, paint thinner, etc.). It may damage the cabinet.
- Do not apply oil to the inside of the unit. It may cause malfunctions.

■ Cleaning the CD pickup lens

In order to ensure proper operation of the CD player, preventative maintenance (cleaning of the laser pickup lens) should be performed periodically. Lens cleaners are commercially available. Contact your local CD software dealer for options.

Specifications

As part of our policy of continuous improvement, SHARP reserves the right to make design and specification changes for product improvement without prior notice. The performance specification figures indicated are nominal values of production units. There may be some deviations from these values in individual unit.

■ General

Power source	AC 100 - 240 V ~ 50/60 Hz
Power consumption	25 W
Dimensions	Width: 16 - 1/2" (420 mm) Height: 5 - 1/8" (130 mm) Depth: 11 - 1/4" (286 mm)
Weight	11.0 lbs. (5 kg)
Bluetooth frequency band	2.402GHz - 2.480GHz
Bluetooth maximum transmit power	+ 4 dBm
Compatible Bluetooth Profile	A2DP (Advanced Audio Distribution Profile), AVRCP (Audio/Video Remote Control Profile) <i>Bluetooth 2.1 +EDR</i>

■ Amplifier

Output power	RMS: Total 50 W (25 W per channel into 4 ohms at 1 kHz, 10% T.H.D.) FTC: 16 W minimum RMS per channel into 4 ohms from 60 Hz to 20 kHz, 10% T.H.D.
Output terminals	Headphones: 16 - 50 Ω (recommended: 32 Ω)
Input terminals	Audio In (audio signal): 500 mV/47 k ohms Line in (Analogue input): 500 mV/47 k ohms

■ CD player

Type	Single disc multi-play compact disc player
Signal readout	Non-contact, 3-beam semiconductor laser pickup
D/A converter	Multi bit D/A converter
Frequency response	20 - 20,000 Hz
Dynamic range	90 dB (1 kHz)

■ USB (MP3)

USB host interface	<ul style="list-style-type: none"> ● Complies with USB 1.1 (Full Speed)/2.0 Mass Storage Class. ● Support Bulk only and CBI protocol.
Support file	● MPEG 1 Layer 3
Bitrate support	● MP3 (32 ~ 320 kbps)
Other	<ul style="list-style-type: none"> ● Maximum total number of MP3 files is 65025. ● Maximum total number of folders is 999 INCLUSIVE of root directory. ● The ID3TAG information supported are TITLE, ARTIST and ALBUM only. ● Supports ID3TAG version 1 and version 2.
File system support	● FAT 16 / FAT 32

■ Tuner

Frequency range	FM: 87.5 - 108.0 MHz AM: 530 - 1,710 kHz
Preset	40 (FM and AM station)

■ Speaker

Type	1-way type speaker system 3" (8 cm) - 4 Ω - Full Range
Maximum input power	50 W / channel
Rated input power	25 W / channel