

SHARP®

ENGLISH

MODEL

CD-BH950

MINI COMPONENT SYSTEM

OPERATION MANUAL

CD-BH950 Mini Component System consisting of CD-BH950 (main unit) and CP-BH950 (speaker system).

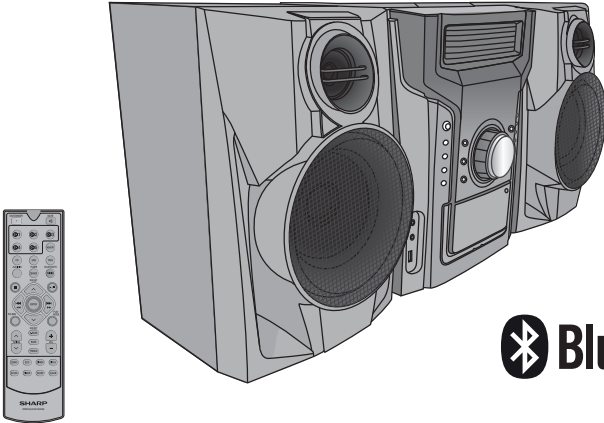

MP3

COMPACT
disc
DIGITAL AUDIO



- This audio system supports devices with Android 4.1, Jelly Bean and higher.
- For device with a lower Android version, refer the operation manual of the device for recommended app (application).

Accessories

Please confirm that only the following accessories are included.

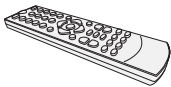

Remote control x 1
(RRMCGA397AWSA)

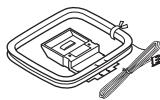

AM loop antenna x 1
(QANTLA016AW01)



FM antenna x 1
(92LFANT1535A)

Special Note

Supply of this product does not convey a license nor imply any right to distribute content created with this product in revenue-generating broadcast systems (terrestrial, satellite, cable and/or other distribution channels), revenue generating streaming applications (via Internet, intranets and/or other networks), other revenue-generating content distribution systems (pay-audio or audio-on-demand applications and the like) or on revenue-generating physical media (compact discs, digital versatile discs, semiconductor chips, hard drives, memory cards and the like). An independent license for such use is required. For details, please visit <http://mp3licensing.com>

MPEG Layer-3 audio coding technology licensed from Fraunhofer IIS and Thomson.



TINSZB995AWZZ

SHARP CORPORATION

Printed in Malaysia

16 G R KI ①

SPECIAL NOTES

For users in U.S.



CAUTION

RISK OF ELECTRIC SHOCK DO NOT OPEN



CAUTION: TO REDUCE THE RISK OF ELECTRIC SHOCK, DO NOT REMOVE COVER (OR BACK). NO USER-SERVICEABLE PARTS INSIDE. REFER SERVICING TO QUALIFIED SERVICE PERSONNEL.

Explanation of Graphical Symbols:



The lightning flash with arrowhead symbol, within an equilateral triangle, is intended to alert the user to the presence of uninsulated "dangerous voltage" within the product's enclosure that may be of sufficient magnitude to constitute a risk of electric shock to persons.



The exclamation point within an equilateral triangle is intended to alert the user to the presence of important operating and maintenance (servicing) instructions in the literature accompanying the appliance.

WARNING: TO REDUCE THE RISK OF FIRE OR ELECTRIC SHOCK, DO NOT EXPOSE THIS APPLIANCE TO RAIN OR MOISTURE.

This product is classified as a CLASS 1 LASER PRODUCT Caution - Use of any controls, adjustments or procedures other than those specified herein may result in hazardous radiation exposure.

NOTE

This equipment has been tested and found to comply with the limits for a Class B digital device, pursuant to Part 15 of the FCC Rules. These limits are designed to provide reasonable protection against harmful interference in a residential installation. This equipment generates, uses, and can radiate radio frequency energy and, if not installed and used in accordance with the instructions, may cause harmful interference to radio communications. However, there is no guarantee that interference will not occur in a particular installation. If this equipment does cause harmful interference to radio or television reception, which can be determined by turning the equipment off and on, the user is encouraged to try to correct the interference by one or more of the following measures:

- Reorient or relocate the receiving antenna.
- Increase the separation between the equipment and receiver.
- Connect the equipment into an outlet on a circuit different from that to which the receiver is connected.
- Consult the dealer or an experienced radio/TV technician for help.

Warning: Changes or modifications to this unit not expressly approved by the party responsible for compliance could void the user's authority to operate the equipment.

FCC Radiation Exposure Statement

This device complies with the limits for a Class B digital device, pursuant to Part 15 of the FCC Rules. It must not be co-located or operating in conjunction with any other antenna or transmitter. Operation is subject to the following two conditions:

1. This device may not cause harmful interference, and
2. This device must accept any interference received, including interference that may cause undesired operation.

This equipment should be installed and operated with a minimum distance of 20 cm between the radiator and person's body.

Note to CATV system installer:

This reminder is provided to call the CATV system installer's attention to Article 820 of the National Electrical Code that provides guidelines for proper grounding and, in particular, specifies that the cable ground shall be connected to the grounding system of the building, as close to the point of cable entry as practical.

FOR YOUR RECORDS

For your assistance in reporting this unit in case of loss or theft, please record below the model number and serial number which are located on the rear of the unit. Please retain this information.

Model number

Serial number

Date of purchase

Place of purchase

The *Bluetooth*[®] word mark and logos are registered trademarks owned by the *Bluetooth* SIG, Inc. and any use of such marks by SHARP is under license. Other trademarks and trade names are those of their respective owners.

The N-Mark is a trademark or registered trademark of NFC Forum, Inc. in the United States and in other countries.

IMPORTANT SAFETY INSTRUCTIONS

Electricity is used to perform many useful functions, but it can also cause personal injuries and property damage if improperly handled. This product has been engineered and manufactured with the highest priority on safety. However, improper use can result in electric shock and/or fire. In order to prevent potential danger, please observe the following instructions when installing, operating and cleaning the product. To ensure your safety and prolong the service life of this product, please read the following precautions carefully before use.

- 1) Read these instructions.
- 2) Keep these instructions.
- 3) Heed all warnings.
- 4) Follow all instructions.
- 5) Do not use this apparatus near water.
- 6) Clean only with dry cloth.
- 7) Do not block any ventilation openings. Install in accordance with the manufacturer's instructions.
- 8) Do not install near any heat sources such as radiators, heat registers, stoves, or other apparatus (including amplifiers) that produce heat.
- 9) Do not defeat the safety purpose of the polarized or grounding-type plug. A polarized plug has two blades with one wider than the other. A grounding type plug has two blades and a third grounding prong. The wide blade or the third prong are provided for your safety. If the provided plug does not fit into your outlet, consult an electrician for replacement of the obsolete outlet.
- 10) Protect the power cord from being walked on or pinched particularly at plugs, convenience receptacles, and the point where they exit from the apparatus.
- 11) Only use attachments/accessories specified by the manufacturer.
- 12) Use only with the cart, stand, tripod, bracket, or table specified by the manufacturer, or sold with the apparatus. When a cart is used, use caution when moving the cart/apparatus combination to avoid injury from tip-over.

IMPORTANT SAFETY INSTRUCTIONS (continued)

- 13) Unplug this apparatus during lightning storms or when unused for long periods of time.
- 14) Refer all servicing to qualified service personnel. Servicing is required when the apparatus has been damaged in any way, such as power-supply cord or plug is damaged, liquid has been spilled or objects have fallen into the apparatus, the apparatus has been exposed to rain or moisture, does not operate normally, or has been dropped.

Additional Safety Information

- 15) Power Sources - This product should be operated only from the type of power source indicated on the marking label. If you are not sure of the type of power supply to your home, consult your product dealer or local power company. For product intended to operate from battery power, or other sources, refer to the operating instructions.
- 16) Overloading - Do not overload wall outlets, extension cords, or integral convenience receptacles as this can result in a risk of fire or electric shock.
- 17) Object and Liquid Entry - Never push objects of any kind into this product through openings as they may touch dangerous voltage points or short-out parts that could result in a fire or electric shock.

To prevent fire or shock hazard, do not expose this appliance to dripping or splashing. No objects filled with liquids, such as vases, shall be placed on the apparatus.
- 18) Damage Requiring Service - Unplug this product from the wall outlet and refer servicing to qualified service personnel under the following conditions:
 - a. When the AC cord or plug is damaged,
 - b. If liquid has been spilled, or objects have fallen into the product,
 - c. If the product has been exposed to rain or water,
 - d. If the product does not operate normally by following the operating instructions. Adjust only those controls that are covered by the operating instructions as an improper adjustment of other controls may result in damage and will often require extensive work by a qualified technician to restore the product to its normal operation,
 - e. If the product has been dropped or damaged in any way, and
 - f. When the product exhibits a distinct change in performance - this indicates a need for service.
- 19) Replacement Parts - When replacement parts are required, be sure the service technician has used replacement parts specified by the manufacturer or have the same characteristics as the original part. Unauthorized substitutions may result in fire, electric shock, or other hazards.
- 20) Safety Check - Upon completion of any service or repairs to this product, ask the service technician to perform safety checks to determine that the product is in proper operating condition.
- 21) Wall or ceiling mounting - When mounting the product on a wall or ceiling, be sure to install the product according to the method recommended by the manufacturer.
- 22) Power Lines - An outside antenna system should not be located in the vicinity of overhead power lines or other electric light or power circuits, or where it can fall into such power lines or circuits. When installing an outside antenna system, extreme care should be taken to keep from touching such power lines or circuits as contact with them might be fatal.
- 23) Protective Attachment Plug - The product is equipped with an attachment plug having overload protection. This is a safety feature. See Instruction Manual for replacement or resetting of protective device. If replacement of the plug is required, be sure the service technician has used a replacement plug specified by the manufacturer that has the same overload protection as the original plug.

- 24) Stand - Do not place the product on an unstable cart, stand, tripod or table. Placing the product on an unstable base can cause the product to fall, resulting in serious personal injuries as well as damage to the product. Use only a cart, stand, tripod, bracket or table recommended by the manufacturer or sold with the product. When mounting the product on a wall, be sure to follow the manufacturer's instructions. Use only the mounting hardware recommended by the manufacturer.

Precautions

■ General

- Please ensure that the equipment is positioned in a well ventilated area and ensure that there is at least 4" (10 cm) of free space along the sides, top and back of the equipment.

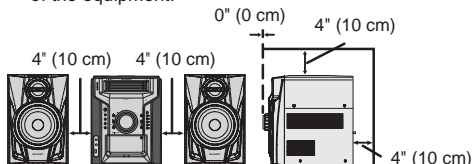

- The unit will start the tape initialization when plugged in to the AC outlet. During this process, initializing sound will be heard and the unit cannot be turned on. Wait until the process is finished.
- Use the unit on a firm, level surface free from vibration.
- Place the speakers at least 12" (30 cm) away from any CRT TV to avoid color variations across the TV screen. If the variations persist, move the speakers further away from the TV. LCD TV is not prone to such variation.
- Keep the unit away from direct sunlight, strong magnetic fields, excessive dust, humidity and electronic/electrical equipment (home computers, facsimiles, etc.) which generate electrical noise.
- Do not place anything on top of the unit.
- Do not expose the unit to moisture, to temperatures higher than 140°F (60°C) or to extremely low temperatures.
- If your system does not work properly, disconnect the AC power cord from the AC outlet. Plug the AC power cord back in, and then turn on your system.
- In case of an electrical storm, unplug the unit for safety.
- Hold the AC power plug by the head when removing it from the AC outlet, as pulling the cord can damage internal wires.
- The AC power plug is used as a disconnect device and shall always remain readily operable.
- **Do not remove the outer cover, as this may result in electric shock. Refer internal service to your local SHARP service facility.**
- This unit should only be used within the range of 41°F - 95°F (5°C - 35°C).

Precautions (continued)

Warning:

The voltage used must be the same as that specified on this unit. Using this product with a higher voltage other than that which is specified is dangerous and may result in a fire or other type of accident causing damage. SHARP will not be held responsible for any damage resulting from use of this unit with a voltage other than that which is specified.

■ Volume control

The sound level at a given volume setting depends on speaker efficiency, location and various other factors. It is advisable to avoid exposure to high volume levels, which occurs while turning the unit on with the volume control setting up high, or while continually listening at high volumes. Excessive sound pressure from earphones and headphones can cause hearing loss.

For U.S. customer only

CONSUMER LIMITED WARRANTY

SHARP ELECTRONICS CORPORATION warrants to the first consumer purchaser that this Sharp brand product (the "Product"), when ship in its original container, will be free from defective workmanship and materials, and agrees that it will, at its option, either repair the defect or replace the defective Product or part thereof with a new or remanufactured equivalent at no charge to the purchaser for parts or labor for the period(s) set forth below.

This warranty does not apply to any appearance items of the Product nor to the additional excluded item(s) set forth below nor to any Product the exterior of which has been damaged or defaced, which has been subjected to improper voltage or other misuse, abnormal service or handling, or which has been altered or modified in design or construction.

In order to enforce the rights under this limited warranty, the purchaser should follow the steps set forth below and provide proof of purchase to the servicer.

The limited warranty described herein is in addition to whatever implied warranties may be granted to purchasers by law. ALL IMPLIED WARRANTIES INCLUDING THE WARRANTIES OF MERCHANTABILITY AND FITNESS FOR USE ARE LIMITED TO THE PERIOD(S) FROM THE DATE OF PURCHASE SET FORTH BELOW. Some states do not allow limitations on how long an implied warranty lasts, so the above limitation may not apply to you.

Neither the sales personnel of the seller nor any other person is authorized to make any warranties other than those described herein, or to extend the duration of any warranties beyond the time period described herein on behalf of Sharp.

The warranties described herein shall be the sole and exclusive warranties granted by Sharp and shall be the sole and exclusive remedy available to the purchaser. Correction of defects, in the manner and for the period of time described herein, shall constitute complete fulfillment of all liabilities and responsibilities of Sharp to the purchaser with respect to the Product, and shall constitute full satisfaction of all claims, whether based on contract, negligence, strict liability or otherwise. In no event shall Sharp be liable, or in any way responsible, for any damages or defects in the Product which were caused by repairs or attempted repairs performed by anyone other than an authorized servicer. Nor shall Sharp be liable or in any way responsible for any incidental or consequential economic or property damage. Some states do not allow the exclusion of incidental or consequential damages, so the above exclusion may not apply to you.

THIS LIMITED WARRANTY IS VALID ONLY IN THE FIFTY (50) UNITED STATES, THE DISTRICT OF COLUMBIA AND PUERTO RICO.

Model Specific Section

Your Product Model Number & Description:

CD-BH950

Mini Component System

(Be sure to have this information available when you need service for your Product.)

Warranty Period for this Product:

One (1) year parts and labor from the date of purchase.

Additional Item(s) Excluded from Warranty Coverage (if any):

Non-functional accessories, supplies, and consumable items.

Where to Obtain Service:

At a Sharp Authorized Servicer located in the United States. To find a location of the nearest Sharp Authorized Servicer, call Sharp toll free at 1-800-BE-SHARP.

What to do to Obtain Service:

Ship prepaid or carry in your Product to a Sharp Authorized Servicer. Be sure to have **Proof of Purchase** available. If you ship the Product, be sure it is insured and packaged securely.

TO OBTAIN SUPPLY, ACCESSORY OR PRODUCT INFORMATION, CALL **1-800-BE-SHARP**

SHARP ELECTRONICS CORPORATION

1 Sharp Plaza, Suite 1, Mahwah, NJ 07495-1123

Controls and indicators

■ Front Panel

1. Disc Trays
2. Timer Indicator
3. CD / USB, Tape Stop Button
4. On/Standby Button
5. Bluetooth Button
6. CD Button
7. Tuner (Band) / Tape Button
8. Audio In / USB Button
9. Track Down or Fast Reverse, Tape Rewind, Tuning Up Button
10. Tuning Down Button
11. Headphone Jack
12. Audio In Jack
13. USB Terminal
14. Volume Control
15. Remote Sensor
16. Play or Pause Button
17. Disc Tray Open / Close Button
18. Disc Number Select Buttons
19. Track Up or Fast Forward, Tape Fast Forward, Preset Up Button
20. Preset Down Button
21. Cassette Compartment
22. NFC detection area

■ Display

1. Disc Number Indicators
2. Folder Indicator
3. Title Indicator
4. Artist Indicator
5. Album Indicator
6. MP3 Indicator
7. WMA Indicator
8. FM Stereo Mode Indicator
9. FM Stereo Receiving Indicator
10. Sleep Indicator
11. Timer Play Indicator
12. Total Indicator
13. Tuning FM/Bluetooth pairing indicator
14. Daily Timer Indicator
15. Memory Indicator
16. Extra Bass Indicator
17. Repeat Play Indicator
18. Pause Indicator
19. Play Indicator

■ Rear Panel

1. AM Loop Antenna Terminal
2. FM 75 Ohms Antenna Jack
3. Speaker Terminals
4. AC Power Cord

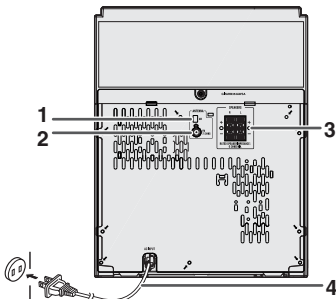
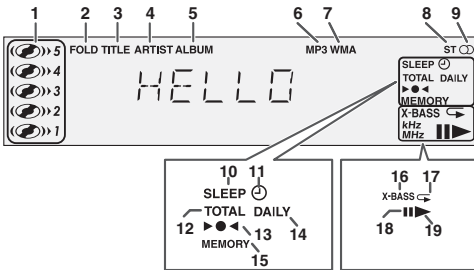
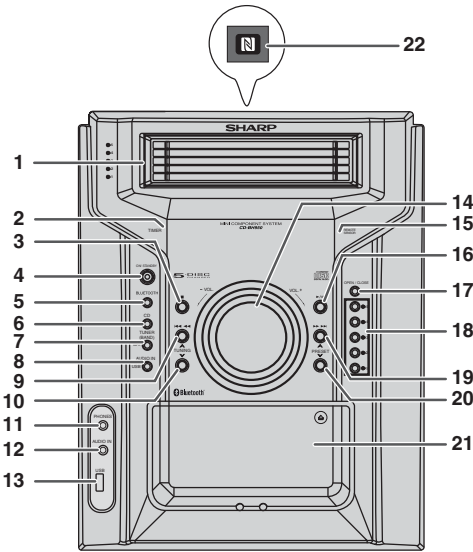

Controls and indicators (continued)

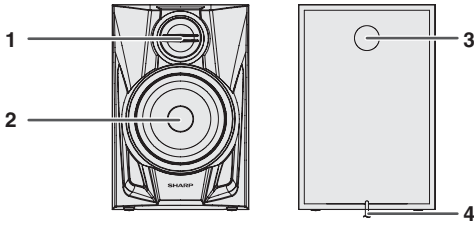

■ Speaker System

1. Tweeter
2. Woofer
3. Bass Reflex Duct
4. Speaker Wire

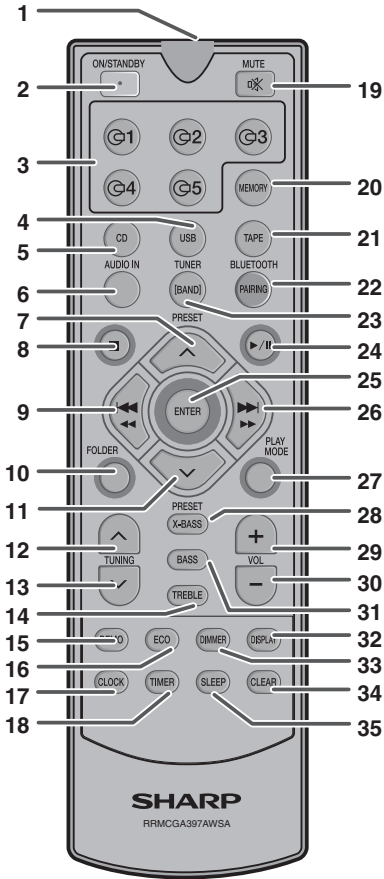

■ Remote Control

1. Remote Control Transmitter
2. On / Standby Button
3. Disc Number Select Buttons
4. USB Button
5. CD Button
6. Audio In Button
7. Preset Up Button
8. Stop Button
9. Disc Track Down or Fast Reverse, Tape Rewind Button
10. Folder Button
11. Preset Down Button
12. Tuning Up Button
13. Tuning Down Button
14. Treble Button
15. Demo Button
16. Eco Button
17. Clock Button
18. Timer Button
19. Mute Button
20. Memory Button
21. Tape Button
22. Bluetooth/Pairing Button
23. Tuner [Band] Button
24. Play/Pause Button
25. Enter Button
26. Disc Track Up or Fast Forward, Tape Fast Forward Button
27. Play Mode Button
28. X-Bass Button
29. Volume Up Button
30. Volume Down Button
31. Bass Button
32. Display Button
33. Dimmer Button
34. Clear Button
35. Sleep Button

System connection

Make sure to unplug the AC power cord before making any connections.

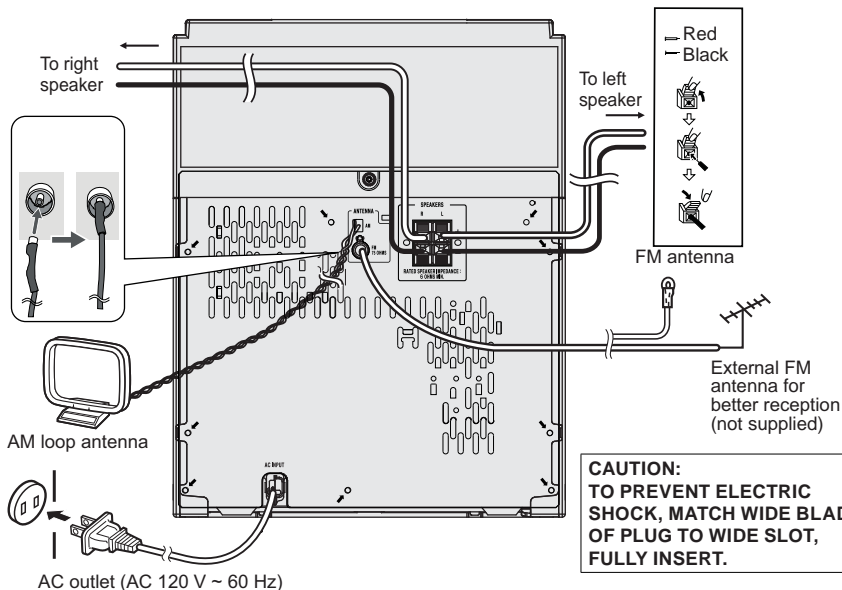

■ Speaker connection

+ speaker terminal	red wire
- speaker terminal	black wire

- Use speakers with an impedance of 6 ohms or more, as lower impedance speakers can damage the unit.
- Do not mistake the right and the left channels. The right speaker is the one on the right side when you face the unit.
- Do not let the bare speaker wires touch each other.
- Do not allow any objects to fall into or to be placed in the bass reflex ducts.
- Do not stand or sit on the speakers. You may be injured.

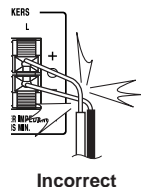

■ Antenna connection

Supplied FM antenna:

Connect to the FM 75 ohms jack and position it where reception is best.

External FM antenna:

Use an external FM antenna (75 ohms coaxial cable) for better reception. Disconnect the supplied FM antenna wire before use.

Supplied AM loop antenna:

Connect to the AM terminal and position it where reception is best. Place it on a shelf, etc., or attach it to a stand or a wall with screws (not supplied).

Installing the AM loop antenna

< Assembling >

< Attaching to the wall >



Note:

Keep the antenna away from the unit or AC power cord to avoid noise pickup.

■ Demonstration mode

- The first time the unit is plugged in, the unit will enter the demonstration mode. You will see words scroll.
- To cancel the demonstration mode, press the DEMO button (remote control) once. The unit will enter the *Bluetooth* standby mode.
- To cancel the *Bluetooth* standby mode, press the ECO button (remote control). The unit will enter the low power consumption mode.
- To return to the demonstration or *Bluetooth* standby mode, press the DEMO button again.
- During demonstration or *Bluetooth* standby mode, NFC function is activated once your device touches the NFC detection area.

■ AC power connection

After all connections have been made correctly, plug the AC power cord into the AC outlet.

Note:

Unplug the AC power cord from the AC outlet if the unit will not be in use for a prolonged period of time.

Remote control

■ Battery installation

Use 2 "AAA" size batteries (UM/SUM-4, R3, HP-16 or similar). Batteries are not included.

- 1 Open the battery cover.
- 2 Insert the batteries according to the terminal indicated in the battery compartment.
When inserting or removing the batteries, push it toward the (-) battery terminals.
- 3 Close the cover.

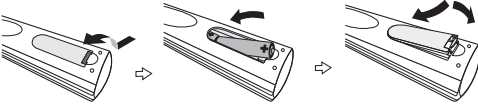

Caution:

- Replace all old batteries with new ones at the same time.
- Do not mix old and new batteries.
- Remove the batteries if the unit will not be used for a long period of time. This will prevent potential damage due to battery leakage.
- Do not use rechargeable batteries (nickel-cadmium battery, etc.).
- Installing the batteries incorrectly may cause the unit to malfunction.
- Batteries (battery pack or batteries installed) shall not be exposed to excessive heat such as sunshine, fire or the like.

Notes concerning use:

- Replace the batteries if the operating distance is reduced or if the operation becomes erratic. Purchase 2 "AAA" size batteries. (UM/SUM-4, R3, HP-16 or similar)
- Periodically clean the transmitter on the remote control and the sensor on the unit with a soft cloth.
- Exposing the sensor on the unit to strong light may interfere with operation. Change the lighting or the direction of the unit if this occurs.
- Keep the remote control away from moisture, heat, shock, and vibrations.

■ Test of the remote control

Check the remote control after checking all the connections. Point the remote control directly at the remote sensor on the unit. The remote control can be used within the range shown below:

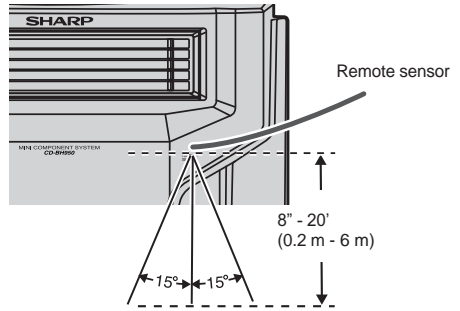

Note:

Exposing the infrared remote control to direct sunlight may cause the remote control to be inoperable.

General control

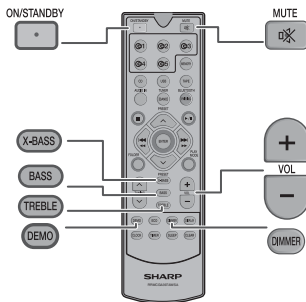
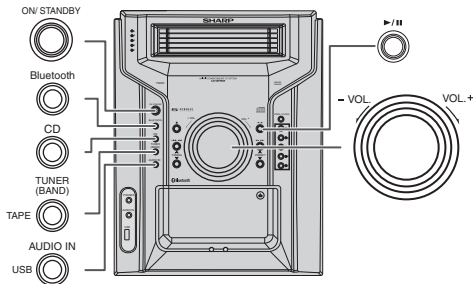

To turn the power on

The first time the unit is plugged in, the unit will enter the demonstration mode.

Function	Main unit	Remote control	Operation
Power on/off	ON/STANDBY	ON/STANDBY	Press to turn the power on or to go to standby mode.
Demo / Bluetooth Standby	—	DEMO	Press to enter demonstration or Bluetooth standby mode.
Eco mode	—	ECO	Press to enter low power consumption mode.

Note:

During demonstration or Bluetooth standby mode, NFC function is activated once your device touches the NFC detection area.

Display brightness control

To dim the display brightness, press the DIMMER button on the remote control.

- DIMMER 1 (Display is dim).
- ↓ DIMMER 2 (Display gets dimmer).
- ↳ DIMMER OFF (Display is bright).

Volume auto fade-in

If you turn off and on the main unit with the volume set to 27 or higher, the volume starts at 16 and fades in to the last set level.

Volume control

Turn the volume knob toward VOL. +/- (on main unit) or press VOL +/- (on remote control) to increase or decrease the volume.

Muting

To mute the volume, press the MUTE (⊘) button (remote control).

Press again to restore the volume.

Bass control (X-BASS)

When the power is first turned on, the unit will enter the extra bass mode which emphasizes the bass frequencies, and "X-BASS" will appear. To cancel the extra bass mode, press the X-BASS button.

Bass control

- 1 Press the BASS button to select "BASS".
- 2 Within 3 seconds, press the VOL (+ or -) button to adjust the bass.

Treble control

- 1 Press the TREBLE button to select "TREBLE".
- 2 Within 3 seconds, press the VOL (+ or -) button to adjust the treble.

Auto power on function

When you press any of the following buttons, the unit turns on.

- Bluetooth, CD, USB, AUDIO IN, TUNER (BAND), TAPE button (main unit/remote control): Selected function is activated.
- ▶/⏸ button (main unit): The unit turns on and playback of the last function will start (Bluetooth, CD, USB, AUDIO IN, TUNER, TAPE).

Auto power off function

The main unit will enter the standby mode after 15 minutes of inactivity during:

AUDIO IN: No detection of input signal or very low sound audibility.

CD / USB / TAPE: In the stop mode.

Bluetooth: In the pause or stop mode and no incoming signal from a source device.

Bluetooth one touch connection via NFC

About NFC technology

Near Field Communication (NFC) is a set of standards for devices (smartphones/tablets) to establish radio communication with each other by touching/tapping them together or bringing them into close proximity. Using NFC in this product simplifies the pairing method of *Bluetooth* connectivity.

Notes for Android Device.

- This audio system supports NFC-enabled device with Android 4.1, Jelly Bean and higher.
- For device with a lower Android version, refer the operation manual of the device for recommended app (application).

Unlike other wireless technology, NFC requires no discovery or pairing.

Simply tap the source device to the NFC detection area to instantly enjoy seamless connectivity between your smart device and the audio system.

NFC detection area

NFC detection area location may vary depending on the device (smartphone/tablet). Refer operation manual of the device for detail.

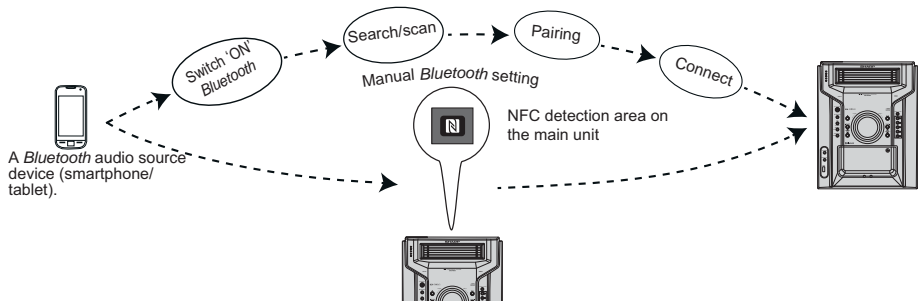

NFC connection for audio playback

Check that:

- Your device (smartphone/tablet) has an NFC function.
- NFC function on your device is enabled.
- Screen lock function of the device is off.
- This unit is not in low power consumption (ECO) mode.
- Your device must be within 10 meters from the unit.

- 1 Touch your device to the NFC detection area on the main unit.

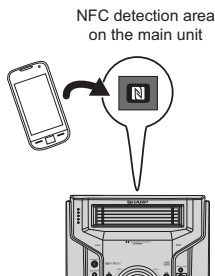

- 2 A pop-up window asking whether to proceed with the *Bluetooth* connection appears on the device. Select <YES>.
 - The 'connected' message appears when the connection is complete.
- 3 Press play (on remote control or source device).
 - Sound will be heard from the speakers of this unit via audio streaming.
 - Your device must be within 10 meters from the unit.

Various *Bluetooth* operation buttons (remote control only)

	Press the button to play or pause.
	Press the button to track up. Press and hold to fast forward.
	Press the button to track down. Press and hold to fast reverse.

Notes:

- To disconnect, simply touch your device to the NFC detection area on the main unit again.
- This product switches to *Bluetooth* function automatically when NFC tagging is done by your device.
- If your device does not support NFC, or if you wish to listen to audio via *Bluetooth* connectivity without NFC; refer "Pairing with other *Bluetooth* source devices" on the next page.
- Some *Bluetooth* devices will connect to this product automatically when the device or its *Bluetooth* mode was turned on. In such case, it will also change the function selection of this product. If you do not want it to connect automatically, please disable *Bluetooth* on your device.
- It takes about 6-8 seconds for a *Bluetooth* enabled device (eg. smartphone) to establish *Bluetooth* connection with this unit via NFC or manual connection.
- If "Empty tag" or similar message appears on your device, touch the device again to the NFC detection area on the main unit.

Listening to Bluetooth enabled devices

■ Bluetooth

Bluetooth wireless technology is a short-range radio technology that enables wireless communication between various types of digital devices, such as mobile phone or computer. It operates within a range of about 10 meters (32 feet) without the hassle of having to use cables to connect these devices.

This unit supports the following:

Communication System: *Bluetooth* Specification version 2.1 *Bluetooth* + Enhanced Data Rate (EDR).

Support Profile : A2DP (Advanced Audio Distribution Profile) and AVRCP (Audio/Video Remote Control Profile)

Notes when using unit with a mobile phone

- This unit cannot be used to talk over the telephone even when there is a *Bluetooth* connection made to a mobile phone.
- Please refer to the operating manual supplied with the mobile phone for details on operation of your mobile phone while transmitting the sound using a *Bluetooth* connection.

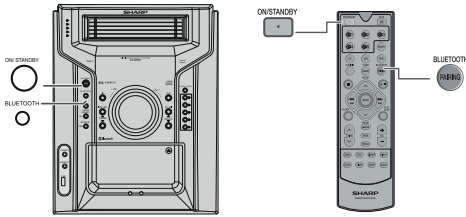

■ Pairing Bluetooth devices

Bluetooth devices need to be initially paired first before they can exchange data. Once paired, it is not necessary to pair them again unless:

- pairing is made with more than 99 devices.
Pairing can only be made one device at a time. This unit can be paired to a maximum of 99 devices. If subsequent device is paired, the oldest device paired, will be deleted and replaced with the new one.
- this unit is reset. All pairing information is deleted when unit is reset.
- pairing information is deleted while repairing, etc.

Indicators:

Indicator	Condition	Bluetooth status
▶ ● ◀	Lights up	Connected
	No indication	Unconnected

However, the indicator status is not displayed during *Bluetooth* standby mode.

■ Pairing with other Bluetooth source devices

- 1 Press the ON/STANDBY button to turn the power on.
- 2 Press the *BLUETOOTH* button on the main unit or *BLUETOOTH (PAIRING)* on the remote control to select *Bluetooth* function. "*BLUETOOTH*" appears on the display.
- 3 Perform pairing procedure on the source device to detect this unit. "CD-BH950 SHARP" will appear in the detected devices list (if available) in the source device. (Refer the source device operating manual for details).

Notes:

- Place the devices to be paired within 3 feet (1 meter) of each other when pairing.
 - Some source devices are unable to display lists of detected devices. To pair this unit with the source device, refer to the source device operating manual for details.
- 4 Select "CD-BH950 SHARP" from the source list. If Passcode* is required, enter "0000".
* Passcode may be called PIN Code, Passkey, PIN number or Password.
 - 5 Pairing indicator light up once the unit is successfully paired with the source device. (Pairing information is now memorized in the unit.)
Some audio source devices may connect with the unit automatically after pairing is completed, otherwise follow the instructions in the source device operating manual to start connection.
 - 6 Press play (on remote control or source device) to start *Bluetooth* streaming playback.

Notes:

- If a device such as microwave oven, wireless LAN card, *Bluetooth* device or any other device that uses the same 2.4 GHz frequency near the system some sound interruption may be heard.
- The transmission distance of the wireless signal between the device and the main unit is about 32 feet (10 m), but may vary depending on your operating environment. If a steel concrete or metallic wall is between the device and the main unit, the system may not operate at all, because the wireless signal cannot penetrate metal.
- If this unit or the source device is turned off before *Bluetooth* connection is completed, pairing will not be completed and the pairing information will not be memorized. Repeat step 1 onward to start pairing again.
- To pair with other devices, repeat steps 1 - 4 for each device. This unit can be paired to a maximum of 99 devices. If subsequent device is paired, the oldest device paired, will be deleted and replaced with the new one.
- Once a device is ousted or deleted from the pairing list, the pairing information for the device is also deleted. To listen to the sound from the device again, it needs to be re-paired. Perform steps 1 - 4 to pair the device again.
- CD-BH950 supports *Bluetooth* profile AVRCP 1.4. If your device supports the same profile (refer to device manufacturer's specification), CD-BH950 is able to control the volume of the device.

Note:

Some music applications do not support this feature, hence there will be no volume synchronisation between your device and the unit even if your *Bluetooth* device supports such profile.

Listening to *Bluetooth* enabled devices (continued)

■ Listening to the sound

Check that:

- The source device *Bluetooth* functionality is ON.
- Pairing of this unit and the source device is completed.
- Unit is in connected mode.

- 1 Press the ON/STANDBY button to turn the power on.
- 2 Press the *BLUETOOTH* button on the main unit or *BLUETOOTH* (PAIRING) button on the remote control to select *Bluetooth* function.
- 3 Start the *Bluetooth* connection from the *Bluetooth* audio source device.
- 4 Press play (on remote control or source device).

Notes:

- For various *Bluetooth* operations, refer "NFC connection for audio playback" on page 9.
- If the source device has an extra bass function or equalizer function, set them to off. If these functions are on, sound may be distorted.

Notes:

- Make the *Bluetooth* connection again if the source device is not turned on, or its *Bluetooth* functionality is off or is in sleep mode.
- The volume of this unit may not be controlled as intended depending on the device.

■ To disconnect the *Bluetooth* device

Perform any of the followings.

- Disconnect the *Bluetooth* connection on the audio source device.
 - Refer the operating manual supplied with the device.
- Turn off the *Bluetooth* audio source device.
- Turn off this unit.
- Press and hold the *BLUETOOTH* (PAIRING) button on the remote control.

■ Auto power on

During *Bluetooth* standby mode, the unit will automatically power on when the *Bluetooth* connection has been set up between the main unit and your device.

Note:

This function is not applicable during low power consumption (ECO) mode.

Listening on Android™ devices

■ Introduction : Open Accessory

Open Accessory support allows external USB hardware (an Android USB accessory) to interact with an Android-powered device in a special accessory mode. When an Android-powered device is in accessory mode, the connected accessory acts as the USB host (powers the bus and enumerates devices) and the Android-powered device acts in the USB accessory role. Android USB accessories are specifically designed to attach to Android-powered devices and adhere to the Open Accessory Protocol, that allows them to detect Android-powered devices that support accessory mode.

■ Android device connection (USB)

1 Insert the connector to the Android device.

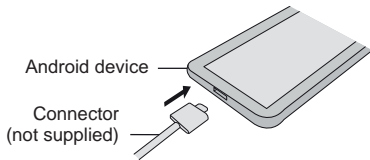

2 Connect the Android device to the unit via USB connector.

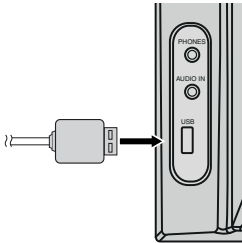

■ Android device playback

- 1 Press the ON/STANDBY button to turn the power on.
- 2 Press the AUDIO IN (USB) button repeatedly on the main unit or USB button on the remote control to select USB function.
- 3 Connect the device to the unit. "USB MEDIA" will be displayed.
- 4 Press play (on remote control or source device).



Notes:

- If the source device has an extra bass or equalizer function, set them to off. If these functions are on, sound may be distorted.
- Incoming calls will pause the playback/application.
- Once the calls are answered, the conversation can only be heard through the built-in speaker of the cellular device. Turn on the device speaker or disconnect the device to start conversation.

■ To disconnect the Android device

- 1 Pause the playback or quit the application (app).
- 2 Disconnect the device from the USB terminal.

■ Various functions

Function	Remote control	Operation
Track up/down		Press in the playback or stop mode. If you press the button in the stop mode, press the ►/ button to start the desired track.
Fast forward/reverse		Press and hold down in the playback mode. Release the button to resume playback.

Notes:

- If non-compatible device is detected "NO MEDIA" will be displayed.
- Controls (play/pause/track up/track down/fast forward / fast reverse) will function based on actual application (app) controls used on Android devices.
- Stop button (■) is invalid during Android device playback.

Android is a trademark of Google Inc.

Listening to a CD or MP3/WMA disc

■ Disc playback

- 1 Press the ON/STANDBY button to turn the power on.
- 2 Press the CD button.
- 3 Press the button and within 5 seconds, press the OPEN/CLOSE button to open the disc tray 1.
- 4 Place the disc on the disc tray 1, label side up.
- 5 Press OPEN/CLOSE button to close the disc tray 1.
- 6 You can place discs on the trays 2 - 5 by following steps 3 - 5.
- 7 Press the button to start playback.

To stop playback completely:

- Press the button twice.

Caution:

- Do not place two discs in one-disc-tray.
- Do not play discs of special shapes (heart, octagon, etc). It may cause malfunctions.
- Do not push the disc tray while it is moving.
- If the power fails wait until the power is restored.
- If TV or radio interference occurs during CD operation, move the unit away from the TV or radio.
- Be sure to place 8 cm (3") disc in the middle of the disc tray.
- Due to the structure of the disc information, it takes longer to read an MP3/WMA disc than a normal CD (approximately 20 to 90 seconds).

Notes for CD or MP3/WMA discs:

- Rewritable multi-session discs with unfinished writing, can still be played.

■ To resume playback after stopping (resume play)

You can resume playback from the point playback is stopped.

- 1 While a disc is playing, press the button once. The system stores the point you stopped.
- 2 To resume play, press the button. Playback resumes from the point you stopped.

To cancel the resume playback:

Press the button twice.

Note:

Depending on the disc, playback may resume from slightly before the stopped position.

■ Various disc functions

Function	Main unit	Remote control	Operation
Pause 			Press in the playback mode. Press the button to resume playback from the paused point.
Track up/ Track down			Press in the playback or stop mode. If you press the button in the stop mode, press the button to start the desired track.
Fast forward/ Fast reverse			Press and hold down in the playback mode. Release the button to resume playback.

■ To specify a disc to play

You can play a disc by specifying the disc number.

- 1 Press one of the buttons to select the desired disc.

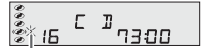

Selected disc number

- 2 Within 5 seconds, press the button.

- Playback will begin from track 1 on the chosen disc.
- After the last track on the last disc is played, the unit stops automatically.

Note:

If a disc tray with no disc is selected, playback will not start and the disc indicator will disappear.

To stop playback: Press the button.

■ Repeat play

Repeat play can play all 5 discs, all tracks on a chosen disc, single track on a chosen disc, or a programmed sequence continuously.

To repeat one track:

Press the PLAY MODE button repeatedly until "I-REPEAT" appears.

To repeat one disc:

Press the PLAY MODE button repeatedly until "DISC REPEAT" appears.

To repeat all tracks on up to 5 discs:

Press the PLAY MODE button repeatedly until "ALL REPEAT" appears.

To repeat desired tracks:

Perform steps 1 - 5 in "Programmed play" section on page 14 and then press the PLAY MODE button repeatedly until "ALL REPEAT" appears.

To repeat one folder:

While in folder mode in MP3/WMA, press the PLAY MODE button repeatedly until "REPEAT FOL" appears.

To cancel repeat play:

Press the PLAY MODE button repeatedly until "NORMAL" appears.

■ Random play

The tracks on the disc(s) can be played in random order automatically.

To random play all tracks on up to 5 discs:

Press the PLAY MODE button repeatedly until "RANDOM" appears.

To cancel random play:

Press the PLAY MODE button repeatedly until "NORMAL" appears.

Notes:

- If you press the button during random play, you can move to the next track by the random operation. On the other hand, the button does not allow you to move to the previous track. The beginning of the track being played will be located.
- In random play, the unit will select and play tracks automatically. (You cannot select the order of the tracks.)

Caution:

After performing repeat or random play, be sure to press the button. Otherwise, the disc(s) will play continuously.

Listening to a CD or MP3/WMA disc (continued)

■ Programmed play (CD)

You can choose up to 32 selections for playback in the order you like.

- 1 While in the stop mode, press the MEMORY button to enter the programming save mode.
- 2 Press the numeric buttons on the remote control or **◀◀** or **▶▶** button to select the desired track.
- 3 Press the MEMORY button to save the track number.
- 4 Repeat steps 2 - 3 for other tracks. Up to 32 tracks can be programmed. If you want to check the programmed tracks, press the MEMORY button repeatedly. If you make a mistake, the programmed tracks can be cleared by pressing the CLEAR button.
- 5 Press the **▶/||** button to start playback.

■ Programmed play (MP3/WMA)

- 1 While in the stop mode, press the MEMORY button to enter the programming save mode.
- 2 Press the PRESET (**∨** or **∧**) button on the remote control to select the desired folder. Then press the **◀◀** or **▶▶** button on the remote control to select the desired tracks.
- 3 Press the MEMORY button to save the folder and track number.
- 4 Repeat steps 2 - 3 for other folder/tracks. Up to 32 tracks can be programmed.
- 5 Press the **▶/||** button to start playback.

To cancel the programmed play mode:

During programmed stop mode, press the **■** button. The display will show "MEM CLEAR" and all the programmed contents will be cleared.

Adding tracks to the program:

If a program has been previously stored, the "MEMORY" indicator will be displayed. During stop mode, press the MEMORY button once. Within 10 seconds, press and hold the MEMORY button again. Then follow steps 2 - 3 to add tracks.

Notes:

- When a disc is ejected, the program is automatically canceled.
- If you press the ON/STANDBY button to enter the standby mode or change the function from CD to another, the programmed selections will be cleared.
- During the program operation, random play is not possible.

■ Procedure to playback MP3/WMA disc with folder mode on

To play back CD-R/RW.

- 1 In CD function, load an MP3/WMA disc. Press the FOLDER button and disc info will be displayed.

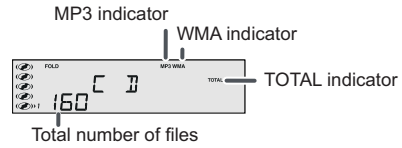

- 2 Press the PRESET (**∨** or **∧**) button to select desired playback folder. (Folder mode on)

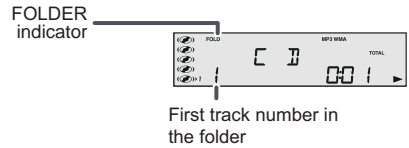

- 3 Select desired file to be played back by pressing the **◀◀** or **▶▶** button.
- 4 Press the **▶/||** button. Playback will start and file name will be displayed.
 - Title, Artist and Album name are displayed if they are recorded on the disc.
 - In case of playback with the folder mode on, press the PRESET (**∨** or **∧**) button, and the folder can be selected even though it is in playback/pause mode. It will continue playback/pause mode in the 1st track of the selected folder.
 - Display content can be changed by pressing the DISPLAY button.

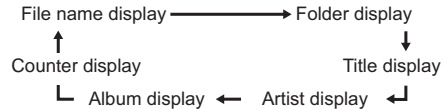

Note:

If "NO SUPPORT" is displayed, it means "Copyright protected WMA file" or "Not supported playback file" is selected.

Listening to USB mass storage device/MP3 player

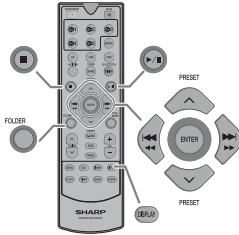
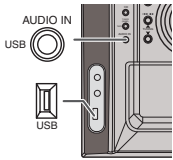

Note:

This product is not compatible with MTP and AAC file systems from USB mass storage device or MP3 player.

■ To play back USB/MP3 player with folder mode on / off

- 1 Press the AUDIO IN (USB) button (main unit) repeatedly to select USB function. Connect the USB memory device that has MP3/WMA format files on the unit. When the USB memory is connected to the main unit, the device information will be displayed.

To playback with folder mode on, follow step 2 below.

To playback with folder mode off, skip to step 3 below.

- 2 Press the FOLDER button, and press the PRESET (∨ or ∧) button to select desired playback folder. To start playback, go to step 4. To change the playback folder, press the PRESET (∨ or ∧) button to select another folder.
- 3 Select desired file to be played back by pressing the ◀◀ or ▶▶ button.
- 4 Press the ▶/|| button. Playback will start and the file name will be displayed.

- Title, Artist and Album name are displayed if they are recorded in the USB memory device.
- Display content can be changed by pressing the DISPLAY button.

Note:

To pause playback:
Press the ▶/|| button.

■ To remove USB memory device

- 1 Press the ■ button to stop playback.
- 2 Disconnect USB memory device from the USB terminal.

Notes:

- SHARP will not be held liable for the loss of data while the USB memory device is connected to the audio system.
- Files compressed in MP3 and/or WMA format can be played back when connected to the USB terminal.
- This USB memory's format supports FAT 16 or FAT 32.
- SHARP cannot guarantee that all USB memory devices will work on this audio system.
- USB cable is not recommended for use in this audio system to connect to USB memory device. Use of the USB cable will affect the performance of this audio system.

- This USB memory cannot be operated via USB hub.
- The USB terminal in this unit is not intended for a PC connection but is used for music streaming with a USB memory device.
- External HDD-storage cannot be played back via USB terminal.
- If the data inside the USB memory is large, it may take longer time for the data to be read.
- This product can play WMA and MP3 files. It will automatically detect the file type being played. If unplayable file is played on this product, "NO SUPPORT" is indicated and the file will be automatically skipped. This will take a few seconds. If abnormal indications appear on the display due to the unspecified file, turn off the unit and then turn it on again.
- This product relates to USB mass storage devices and MP3 players. It may however face some irregularities due to various unforeseen reasons from some devices. Should this happen, turn off the unit and then turn it on again.
- The USB port is only intended for direct connection to a USB memory device without any cable.
- MP3 player will not be charging in other than USB function. However, charging ability depends on type of MP3 player used.

Advanced USB playback

The following functions are the same as CD operations:

	Page
Various disc functions	13
Repeat play	13
Random play	13
Programmed play (MP3/WMA)	14

Notes:

- If USB memory device is not connected, "NO MEDIA" will be shown on the display.
- Fast forward/reverse is invalid when playing back a variable bitrate file.

Notes:

- This unit only supports "MPEG-1 Audio Layer-3" format. (Sampling Frequency is 32, 44.1, 48kHz)
- Playback order for MP3 files may differ depending on the writing software used during file download.
- Bitrate which is supported by MP3 is 32~320 kbps, WMA is 64~160 kbps.
- For MP3/WMA files, please put ".MP3" ".WMA" extension. Files cannot be played back if there is no MP3/WMA extension.
- Playlists are not supported on this unit.
- This unit can display Folder Name or File Name up to 32 characters.
- Maximum total number of MP3/WMA files is 65025.
- Total number of folders read is 999 including folder with non player files. However, the display shows only folder with MP3 files.
- The display playback time may not be displayed correctly when playing back a variable bitrate file.
- The ID3TAG information supported are TITLE, ARTIST and ALBUM only. Title name, artist name and album name can be displayed by pressing the DISPLAY button during file playback or pause mode.
- WMA meta tag also supports title, artist and album name which are recorded in WMA files. Copyright protected WMA files cannot be played back.

Listening to the radio

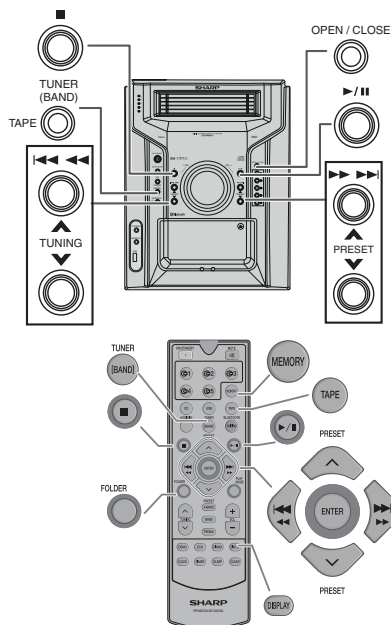

■ Memorizing a station

You can store 40 AM and FM stations in memory and recall them at the push of a button. (Preset tuning)

- 1 Perform steps 1 - 3 in "Tuning".
- 2 Press the MEMORY button to enter the preset tuning saving mode. 
- 3 Within 30 seconds, press the PRESET (∨ or ∧) button to select the preset channel number. Store the stations in memory, in order, starting with preset channel 1.
- 4 Within 30 seconds, press the MEMORY button to store that station in memory. If the "MEMORY" and preset number indicators disappear before the station is memorized, repeat the operation from step 2.
- 5 Repeat steps 1 - 4 to set other stations, or to change a preset station. When a new station is stored in the memory, the station previously memorized for that preset channel number will be erased.

Note:

The backup function protects the memorized stations for a few hours should there be a power failure or the AC power cord become disconnected.

■ To recall a memorized station

Press the PRESET (∨ or ∧) button for less than 0.5 seconds to select the desired station.

■ To scan the preset stations

The stations saved in the memory can be scanned automatically. (Preset memory scan)

- 1 Press the PRESET (∨ or ∧) button for more than 0.5 seconds. The preset number will flash and the programmed stations will be tuned in sequentially, for 5 seconds each.
- 2 Press the PRESET (∨ or ∧) button again when the desired station is located.

■ To erase entire preset memory (In TUNER function)

Press and hold CLEAR button until 'TUNER CLEAR' appears.



■ Tuning

- 1 Press the ON/STANDBY button to turn the power on.
- 2 Press the TUNER (BAND) (TAPE) button repeatedly on the main unit or TUNER (BAND) button repeatedly on the remote control to select the desired frequency band (FM or AM).
- 3 Press the TUNING (∨ or ∧) button to tune in to the desired station.

Manual tuning:

Press the TUNING (∨ or ∧) button as many times as required to tune in to the desired station.

Auto tuning:

When the TUNING (∨ or ∧) button is pressed for more than 0.5 seconds, scanning will start automatically and the tuner will stop at the first receivable broadcast station.

Notes:

- When radio interference occurs, auto scan tuning may stop automatically at that point.
- Auto scan tuning will skip weak signal stations.
- To stop the auto tuning, press the TUNING (∨ or ∧) button again.

To receive an FM stereo transmission:

- Press the TUNER (BAND) button to display the "ST" indicator.
- "CD" will appear when an FM broadcast is in stereo.
- If the FM reception is weak, press the TUNER (BAND) button to extinguish the "ST" indicator. The reception changes to monaural, and the sound becomes clearer.

Listening to a cassette tape

Before playback:

- For playback, use normal or low-noise tapes for the best sound. (Metal or CrO₂ tapes are not recommended.)
- Do not use C-120 tapes or poor-quality tapes, as they may cause malfunctions.
- Before loading a tape into the cassette compartment, tighten the slack with a pen or a pencil.



■ Tape playback

- 1 Press the ON/STANDBY button to turn the power on.
- 2 Open the cassette compartment by pushing the area marked "▲".
- 3 Load a cassette into the TAPE compartment with the side to be played facing toward you.
- 4 Press the TUNER (BAND) TAPE button repeatedly on the main unit to select TAPE.
- 5 Press the ►/|| button to start playback.

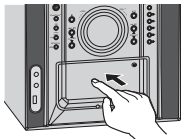

■ Various tape functions

Function	Main unit	Remote control	Operation
Stop			Press in the playback, fast forward or fast rewind mode.
Fast forward/rewind			Press in the playback or stop mode.

Caution:

- Before remove the cassette or changing from one tape operation to another, press the ■ button.
- If a power failure occurs during tape operation, the tape head will remain engaged with the tape and the cassette door will not open. In this case, wait until the power is restored.

■ Cleaning the tape-handling parts

- Dirty heads, capstans or pinch rollers can cause poor sound and tape jams. Clean these parts with a cotton swab moistened with commercial head/pinch roller cleaner or isopropyl alcohol.
- When cleaning the heads, pinch rollers, etc., unplug the unit which contains high voltages.

- Ⓐ Playback head
- Ⓑ Capstan
- Ⓒ Pinch roller

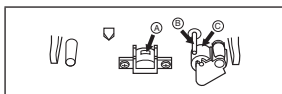

- After long use, the deck's heads and capstans may become magnetized, causing poor sound. Demagnetize these parts once every 30 hours of playing/recording time by using a commercial tape head demagnetizer. Read the demagnetizer's instructions carefully before use.

Setting the clock (Remote control only)

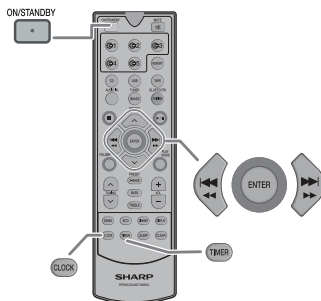

In this example, the clock is set for the 12-hour (AM 12:00) display.

- 1 Press the ON/STANDBY button to turn the power on.
- 2 Press the CLOCK button.
- 3 Within 10 seconds, press the ENTER button. To adjust the day, press the ◀◀◀◀ or ▶▶▶▶ button and then press the ENTER button.
- 4 Press the ◀◀◀◀ or ▶▶▶▶ button to select 24-hour or 12-hour display and then press the ENTER button.

“AM 12:00” → The 12-hour display will appear.
(AM 12:00 - PM 11:59)

↓

“AM 0:00” → The 12-hour display will appear.
(AM 0:00 - PM 11:59)

↓

“0:00” → The 24-hour display will appear.
(0:00 - 23:59)

- 5 To adjust the hour, press the ◀◀◀◀ or ▶▶▶▶ button and then press the ENTER button. Press the ◀◀◀◀ or ▶▶▶▶ button once to advance the time by 1 hour. Hold it down to advance continuously.
- 6 To adjust the minutes, press the ◀◀◀◀ or ▶▶▶▶ button and then press the ENTER button. Press the ◀◀◀◀ or ▶▶▶▶ button once to advance the time by 1 minute. Hold it down to advance the time by 5 minutes interval.

To confirm the time display:

Press the CLOCK button. The time display will appear for about 5 seconds.

Note:

When power supply is restored after unit is plugged in again or after a power failure, reset the clock.

To readjust the clock:

Perform “Setting the clock” from step 1.

To change the 24-hour or 12-hour display:

- 1 Clear all the programmed contents. [Refer to “Factory reset, clearing all memory” on page 20 for details.]
- 2 Perform “Setting the clock” from step 1 onward.

Timer and sleep operation (Remote control only) (continued)

Timer playback:

The unit turns on and plays the desired source (CD, TUNER, USB, AUDIO IN, TAPE) at a preset time.

This unit has 2 types of timer: **ONCE TIMER** and **DAILY TIMER**.

Once timer ("O" indicator):

Once timer play works for one time only at a preset time.

Daily timer ("DAILY" indicator):

Daily timer play works at the same preset time every day that we set. For example, set the timer as a wake-up call every morning.

Using the once timer and daily timer in combination:

For example, use the once timer to listen to a radio program, and use the daily timer to wake up.

1 Set the daily and once timer (pages 18).

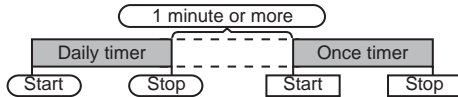

■ Timer playback

Before setting timer:

- Check that the clock is set to the correct time. If it is not set, you cannot use the timer function.
- For timer playback: Plug in USB, load disc or tape to be played.



- 1 Press the ON/STANDBY button to turn the power on.
- 2 Press the TIMER button.
- 3 Within 10 seconds, press the \lll or \ggg button to select "ONCE" or "DAILY", and press the ENTER button.
- 4 Within 10 seconds, press the \lll or \ggg button to select "TIMER SET", and press the ENTER button.
- 5 To select the timer playback source (CD, TUNER, USB, AUDIO IN, TAPE), press the \lll or \ggg button. Press the ENTER button.
When you select the tuner, select a station by pressing the \lll or \ggg button, and then press the ENTER button. If a station has not been programmed, "NO PRESET" will be displayed and timer setting will be canceled.
- 6 To adjust the day, press the \lll or \ggg button and then press the ENTER button.
- 7 Press the \lll or \ggg button to adjust the hour, and then press the ENTER button.
- 8 To adjust the minutes, press the \lll or \ggg button and then press the ENTER button.
- 9 Set the time to finish as in steps 7 and 8 above.
- 10 Adjust the volume using the VOLUME control, and then press the ENTER button.
- 11 Press the ON/STANDBY button to enter the power standby mode. "TIMER" indicator lights up.

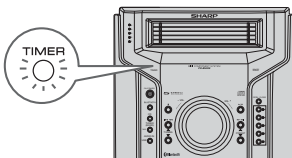

- 12 When the preset time is reached, playback will start. The volume will increase gradually until it reaches the preset

volume. The timer indicator will blink during timer playback.

- 13 When the timer end time is reached, the system will enter the power standby mode automatically.

Once timer:

The timer will be canceled.

Daily timer:

The timer operates at the same time every selected day. Cancel the daily timer when it is not in use.

Notes:

- When performing timer playback using another unit connected to the USB terminal or AUDIO IN jack, select "USB" or "AUDIO IN" in step 5. This unit will turn on or enter the power standby mode automatically. However, the connected unit will not turn on or off.
- To stop the timer playback, follow step "Cancelling the timer setting" of this page.

Checking the timer setting:

- 1 Turn the power on. Press the TIMER button.
- 2 Within 10 seconds, press the \lll or \ggg button to select "ONCE" or "DAILY", and press the ENTER button.
- 3 Within 10 seconds, press the \lll or \ggg button to select "TIMER CALL", and press the ENTER button.

Cancelling the timer setting:

- 1 Turn the power on. Press the TIMER button.
- 2 Within 10 seconds, press the \lll or \ggg button to select "ONCE" or "DAILY", and press the ENTER button.
- 3 Within 10 seconds, press the \lll or \ggg button to select "TIMER OFF", and press the ENTER button.
Timer will be canceled (the setting will not be canceled).

Reusing the memorized timer setting:

The timer setting will be memorized once it is entered. To reuse the same setting, perform the following operations.

- 1 Turn the power on. Press the TIMER button.
- 2 Within 10 seconds, press the \lll or \ggg button to select "ONCE" or "DAILY", and press the ENTER button.
- 3 Within 10 seconds, press the \lll or \ggg button to select "TIMER ON", and press the ENTER button.
- 4 Press the ON/STANDBY button to enter the power standby mode.

■ Sleep operation

The radio, disc, USB and Audio In can all be turned off automatically.

- 1 Play back the desired sound source.
- 2 Press the SLEEP button.
- 3 Within 5 seconds, press the SLEEP button repeatedly to select the time.
"SLEEP 90" → "SLEEP 80" ... → "SLEEP 10" →
→ "SLEEP OFF"
- 4 "SLEEP" indicator will appear.
- 5 The unit will enter the power standby mode automatically after the preset time has elapsed. The volume will be turned down 1 minute before the sleep operation finishes.

To confirm the remaining sleep time:

- 1 While "SLEEP" is indicated, press the SLEEP button.

To cancel the sleep operation:

Press the ON/STANDBY button while "SLEEP" is indicated. To cancel the sleep operation without setting the unit to the standby mode, proceed as follows.

- 1 While "SLEEP" is indicated, press the SLEEP button.
- 2 Within 5 seconds, press the SLEEP button repeatedly until "SLEEP OFF" appears.

Timer and sleep operation (Remote control only) (continued)

■ To use timer and sleep operation together

Sleep and timer playback:

For example, you can fall asleep listening to the radio and wake up to CD in the next morning.

- 1 Set the sleep time (see above, steps 1 - 5).
- 2 While the sleep timer is set, set the timer playback (steps 2 - 10, page 18).

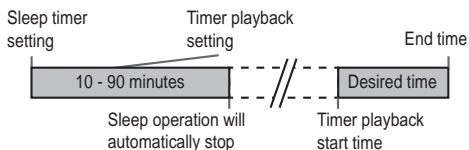

Enhancing your system

The connection cord is not included. Purchase a commercially available cord as shown below.

Portable audio player, etc.

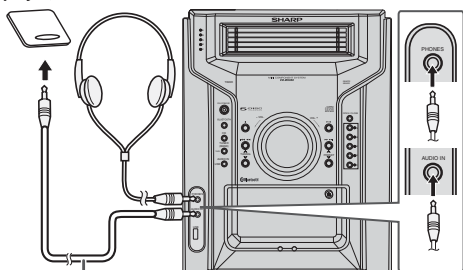

Audio cable (not supplied)

■ Listening to the playback sounds of portable audio player, etc.

- 1 Connect a portable audio player etc. to the front AUDIO IN jack.
- 2 Press the ON/STANDBY button to turn the power on.
- 3 Press the AUDIO IN/USB button repeatedly to select AUDIO IN.
- 4 Play the connected equipment.
If volume level of the connected device is too high, sound distortion may occur. Should this happen, lower the volume of the connected device.
If volume level is too low, increase the volume of the connected device.

Note:

To prevent noise interference, place the unit away from the television.

■ Headphones

- Before plugging in or unplugging the headphones, reduce the volume.
- Be sure your headphones have a 1/8" (3.5 mm) diameter plug and impedance between 16 and 50 ohms. The recommended impedance is 32 ohms.
- Plugging in the headphones disconnects the speakers automatically. Adjust the volume using the VOLUME control.

Troubleshooting chart

Many potential problems can be resolved by the owner without calling a service technician. If something is wrong with this product, check the following before calling your authorized SHARP dealer or service center.

■ General

Symptom	Possible cause
● The clock is not set to the correct time.	● Did a power failure occur? Reset the clock. (Refer page 17)
● When a button is pressed, the unit does not respond.	● Set the unit to the power standby mode and then turn it back on. ● If the unit still malfunctions, reset it. (Refer page 20)
● No sound is heard.	● Is the volume level set to "0"? ● Are the headphones connected? ● Are the speaker wires disconnected?

■ CD player

Symptom	Possible cause
● Playback does not start.	● Is the disc loaded upside down?
● Playback stops in the middle or is not performed properly.	● Does the disc satisfy the standards? ● Is the disc distorted or scratched?
● Playback sounds are skipped, or stopped in the middle of a track.	● Is the unit located near excessive vibrations? ● Is the disc very dirty? ● Has condensation formed inside the unit?
● "ER-CD21" appears on the display.	● Is the disc tray stopped with force? Set the unit to the power standby mode and then turn it back on.

■ Cassette deck

Symptom	Possible cause
● Sound skipping. ● Cannot hear treble. ● Sound fluctuation.	● Is there any slack? ● Is the tape stretched? ● Are the capstans, pinch rollers, or heads dirty?
● Cannot remove the tape.	● If a power failure occurs during playback, the heads remain engaged with the tape. Do not open the compartment with great force.

■ Remote control

Symptom	Possible cause
● The remote control does not operate.	● Is the AC power cord of the unit plugged in? ● Is the battery polarity correct? ● Is the battery dead? ● Is the distance or angle incorrect? ● Does the remote control sensor receive strong light?

Troubleshooting chart (continued)

Tuner

Symptom	Possible cause
<ul style="list-style-type: none"> ● The radio makes unusual noises continuously. 	<ul style="list-style-type: none"> ● Is the unit placed near the TV or computer? ● Is the FM antenna or AM loop antenna placed properly? Move the antenna away from the AC power cord if it is located nearby.

Bluetooth

Symptom	Possible cause
<ul style="list-style-type: none"> ● No sound is heard. 	<ul style="list-style-type: none"> ● The unit is too far from the <i>Bluetooth</i> audio source device. ● The unit is not paired with the <i>Bluetooth</i> audio source device.
<ul style="list-style-type: none"> ● <i>Bluetooth</i> sound is interrupted or distorted. 	<ul style="list-style-type: none"> ● The unit is too near to a device that generates electromagnetic radiation. ● There is an obstacle between the unit and the <i>Bluetooth</i> audio source device.

NFC

Symptom	Possible cause
<ul style="list-style-type: none"> ● NFC-enabled device cannot connect to <i>Bluetooth</i> when tapping on N-Mark. 	<ul style="list-style-type: none"> ● The unit is in Eco mode. ● NFC mode is disabled on your device. ● Your device is in sleep mode.

Open Accessory

Symptom	Possible cause
<ul style="list-style-type: none"> ● No sound is produced. 	<ul style="list-style-type: none"> ● The device is not playing. ● The device is not properly connected to the unit. ● The AC power cord of the unit is not plugged in.
<ul style="list-style-type: none"> ● Device is not charging. 	<ul style="list-style-type: none"> ● The device is not making full contact with the USB terminal.

USB

Symptom	Possible cause
<ul style="list-style-type: none"> ● Device cannot be detected. ● Playback does not start. 	<ul style="list-style-type: none"> ● There is no MP3/WMA file inside the device. ● The device is not properly connected. ● A MTP device is connected. ● The device contains AAC file only. ● A copyright-protected WMA or false MP3 file is being played back.
<ul style="list-style-type: none"> ● Wrong time display. ● Wrong file name display. 	<ul style="list-style-type: none"> ● A Variable Bitrate files are being played back. ● The File Name was written in other than English characters.

If problem occurs

When this product is subjected to strong external interference (mechanical shock, excessive static electricity, abnormal supply voltage due to lightning, etc.) or if it is operated incorrectly, it may malfunction.

If such a problem occurs, do the following:

- 1 Set the unit to the standby mode and turn the power on again.
- 2 If the unit is not restored in the previous operation, unplug and plug in the unit again, and then turn the power on.

Note:

If neither operation above restores the unit, clear all the memory by resetting it.

Factory reset, clearing all memory

- 1 Press the ON/STANDBY button to turn the power on.
- 2 Press AUDIO IN (USB) button (main unit) repeatedly or AUDIO IN button (remote control) to enter Audio In mode.
- 3 Press **◀◀** button (main unit) once.
- 4 Press and hold **■** button (main unit) until "RESET" appears.
- 5 Unplug and plug in the main unit again.



Caution:

This operation will erase all data stored in memory including clock, timer settings, tuner preset, and CD program.

Condensation

Sudden temperature changes, storage or operation in an extremely humid environment may cause condensation inside the cabinet (CD pickup, tape heads, etc.) or on the transmitter on the remote control. Condensation can cause the unit to malfunction. If this happens, leave the power on with no disc (or cassette) in the unit until normal playback is possible (about 1 hour). Wipe off any condensation on the transmitter with a soft cloth before operating the unit.

Before transporting the unit

Remove the USB memory device and disc from the unit. Then, set the unit to the power standby mode. Carrying the unit with USB memory device left connected or discs left inside might damage the unit.

Maintenance

Cleaning the cabinet

Periodically wipe the cabinet with a soft cloth and a diluted soap solution, then with a dry cloth.

Caution:

- Do not use chemicals for cleaning (gasoline, paint thinner, etc.). It may damage the cabinet.
- Do not apply oil to the inside of the unit. It may cause malfunctions.

Cleaning the CD pickup lens

In order to ensure proper operation of the CD player, preventative maintenance (cleaning of the laser pickup lens) should be performed periodically. Lens cleaners are commercially available. Contact your local CD software dealer for options.

Specifications

As part of our policy of continuous improvement, SHARP reserves the right to make design and specification changes for product improvement without prior notice. The performance specification figures indicated are nominal values of production units. There may be some deviations from these values in individual units.

■ General

Power source	AC 120 V ~ 60 Hz
Power consumption	60 W
Dimensions	Width: 10 - 1/4" (260 mm) Height: 13 - 1/16" (332 mm) Depth: 13 - 8/16" (345 mm)
Weight	9.9 lbs. (4.5 kg)

■ Amplifier

Output power	RMS: Total 240 W (120 W per channel into 6 ohms at 1 kHz, 10% Total harmonic distortion.) FTC: 110 W minimum RMS per channel into 6 ohms from 20 Hz to 20 kHz, 10% Total harmonic distortion.
Output terminals	Front Speakers: 6 ohms Headphones: 16 - 50 ohms (recommended: 32 ohms)
Input terminals	Audio In (audio signal): 500 mV/47 k ohms

■ Bluetooth interface

Bluetooth Frequency band	2.400GHz - 2.480GHz
Compatible Bluetooth Profile	A2DP (Advanced Audio Distribution Profile), AVRCP (Audio/Video Remote Control Profile) Bluetooth 2.1 +EDR

■ Tuner

Frequency range	FM: 87.5 - 108.0 MHz AM: 530 - 1,710 kHz
Preset	40 (FM and AM station)

■ CD player

Type	5-disc multi-play compact disc player
Signal readout	Non-contact, 3-beam semiconductor laser pickup
D/A converter	Multi bit D/A converter
Frequency response	20 - 20,000 Hz
Dynamic range	90 dB (1 kHz)

■ Cassette deck

Frequency response	50 - 14,000 Hz (normal tape)
Signal/noise ratio	50 dB (playback)
Wow and flutter	0.3% (WRMS)
Tape speed	4.76 cm/sec. (1 - 7/8" ips)
Heads	Playback

■ USB (MP3/WMA)

USB host interface	Complies with USB 1.1 (Full Speed)/2.0 Mass Storage Class. Support Bulk only and CBI protocol.
Support file	MPEG 1 Layer 3 WMA (Non DRM)
Bitrate support	MP3 (32 ~ 320 kbps) WMA (64 ~ 160 kbps)
Other	Maximum total number of MP3/WMA files is 65025. Maximum total number of folders is 999 INCLUSIVE of root directory. The ID3TAG information supported are TITLE, ARTIST and ALBUM only. Supports ID3TAG version 1 and version 2.
File system support	Support USB devices with FAT 16/ FAT 32.

■ Speaker

Type	2-way type speaker system 2" (5 cm) tweeter 5 - 1/8" (13 cm) woofer
Maximum input power	240 W
Rated input power	120 W
Impedance	6 ohms
Dimensions	Width: 8 - 11/16" (220 mm) Height: 13 - 1/16" (332 mm) Depth: 8 - 3/4" (222 mm)
Weight	6.6 lbs. (3.0 kg)