

# SHARP®

ENGLISH

MODEL

## HT-SB31D

### SOUND BAR HOME THEATER SYSTEM

#### OPERATION MANUAL

Thank you for purchasing this SHARP product. To obtain the best performance from this product, please read this manual carefully. It will guide you in operating your SHARP product.



The *Bluetooth*® word mark and logos are registered trademarks owned by Bluetooth SIG, Inc. and any use of such marks by SHARP is under license. Other trademarks and trade names are those of their respective owners.

The N Mark is a trademark or registered trademark of NFC Forum, Inc. in the United States and in other countries.

**Note:** This product is recommended for flat panel TV (LED, LCD and plasma).



TINSEA512AWZZ

Printed in Malaysia  
SHARP CORPORATION  
16H R AS ①

## Special notes

For Users in U.S.:





**CAUTION**  
RISK OF ELECTRIC SHOCK  
DO NOT OPEN



**CAUTION: TO REDUCE THE RISK OF ELECTRIC SHOCK, DO NOT REMOVE COVER (OR BACK). NO USER-SERVICEABLE PARTS INSIDE. REFER SERVING TO QUALIFIED SERVICE PERSONNEL.**

**Explanation of Graphical Symbols:**

 The lightning flash with arrowhead symbol, within an equilateral triangle, is intended to alert the user to the presence of uninsulated "dangerous voltage" within the product's enclosure that may be of sufficient magnitude to constitute a risk of electric shock to persons.

 The exclamation point within an equilateral triangle is intended to alert the user to the presence of important operating and maintenance (servicing) instructions in the literature accompanying the appliance.

**WARNING: TO REDUCE THE RISK OF FIRE OR ELECTRIC SHOCK, DO NOT EXPOSE THIS APPLIANCE TO RAIN OR MOISTURE.**

### FOR YOUR RECORDS

For your assistance in reporting this unit in case of loss or theft, please record below the model number and serial number which are located on the rear of the unit. Please retain this information.

<b>Model number</b>	.....
<b>Serial number</b>	.....
<b>Date of purchase</b>	.....
<b>Place of purchase</b>	.....

### NOTE

This equipment has been tested and found to comply with the limits for a Class B digital device, pursuant to Part 15 of the FCC Rules. These limits are designed to provide reasonable protection against harmful interference in a residential installation. This equipment generates, uses, and can radiate radio frequency energy and, if not installed and used in accordance with the instructions, may cause harmful interference to radio communications. However, there is no guarantee that interference will not occur in a particular installation. If this equipment does cause harmful interference to radio or television reception, which can be determined by turning the equipment off and on, the user is encouraged to try to correct the interference by one or more of the following measures:

- Reorient or relocate the receiving antenna.
- Increase the separation between the equipment and receiver.
- Connect the equipment into an outlet on a circuit different from that to which the receiver is connected.
- Consult the dealer or an experienced radio/TV technician for help.

**Warning:** Changes or modifications to this unit not expressly approved by the party responsible for compliance could void the user's authority to operate the equipment.

### FCC Radiation Exposure Statement

This device complies with the limits for a Class B digital device, pursuant to Part 15 of the FCC Rules. It must not be co-located or operating in conjunction with any other antenna or transmitter.

Operation is subject to the following two conditions:

1. This device may not cause harmful interference, and
2. This device must accept any interference received, including interference that may cause undesired operation.

This equipment should be installed and operated with a minimum distance of 20 cm between the radiator and person's body.

### Note to CATV system installer:

This reminder is provided to call the CATV system installer's attention to Article 820 of the National Electrical Code that provides guidelines for proper grounding and, in particular, specifies that the cable ground shall be connected to the grounding system of the building, as close to the point of cable entry as practical.

## IMPORTANT SAFETY INSTRUCTIONS

Electricity is used to perform many useful functions, but it can also cause personal injuries and property damage if improperly handled. This product has been engineered and manufactured with the highest priority on safety. However, improper use can result in electric shock and/or fire. In order to prevent potential danger, please observe the following instructions when installing, operating and cleaning the product. To ensure your safety and prolong the service life of this product, please read the following precautions carefully before use.

- 1) Read these instructions.
- 2) Keep these instructions.
- 3) Heed all warnings.
- 4) Follow all instructions.
- 5) Do not use this apparatus near water.
- 6) Clean only with dry cloth.
- 7) Do not block any ventilation openings. Install in accordance with the manufacturer's instructions.
- 8) Do not install near any heat sources such as radiators, heat registers, stoves, or other apparatus (including amplifiers) that produce heat.
- 9) Do not defeat the safety purpose of the polarized or grounding-type plug. A polarized plug has two blades with one wider than the other. A grounding type plug has two blades and a third grounding prong. The wide blade or the third prong are provided for your safety. If the provided plug does not fit into your outlet, consult an electrician for replacement of the obsolete outlet.
- 10) Protect the power cord from being walked on or pinched particularly at plugs, convenience receptacles, and the point where they exit from the apparatus.
- 11) Only use attachments/accessories specified by the manufacturer.
- 12) Use only with the cart, stand, tripod, bracket, or table specified by the manufacturer, or sold with the apparatus. When a cart is used, use caution when moving the cart/apparatus combination to avoid injury from tip-over.
- 13) Unplug this apparatus during lightning storms or when unused for long periods of time.
- 14) Refer all servicing to qualified service personnel. Servicing is required when the apparatus has been damaged in any way, such as power-supply cord or plug is damaged, liquid has been spilled or objects have fallen into the apparatus, the apparatus has been exposed to rain or moisture, does not operate normally, or has been dropped.



### Additional Safety Information

- 15) Power Sources - This product should be operated only from the type of power source indicated on the marking label. If you are not sure of the type of power supply to your home, consult your product dealer or local power company. For product intended to operate from battery power, or other sources, refer to the operating instructions.
- 16) Overloading - Do not overload wall outlets, extension cords, or integral convenience receptacles as this can result in a risk of fire or electric shock.
- 17) Object and Liquid Entry - Never push objects of any kind into this product through openings as they may touch dangerous voltage points or short-out parts that could result in a fire or electric shock. To prevent fire or shock hazard, do not expose this appliance to dripping or splashing. No objects filled with liquids, such as vases, shall be placed on the apparatus.
- 18) Damage Requiring Service - Unplug this product from the wall outlet and refer servicing to qualified service personnel under the following conditions:
  - a. When the AC cord or plug is damaged,
  - b. If liquid has been spilled, or objects have fallen into the product,
  - c. If the product has been exposed to rain or water,
  - d. If the product does not operate normally by following the operating instructions. Adjust only those controls that are covered by the operating instructions as an improper adjustment of other controls may result in damage and will often require extensive work by a qualified technician to restore the product to its normal operation,
  - e. If the product has been dropped or damaged in any way, and
  - f. When the product exhibits a distinct change in performance - this indicates a need for service.
- 19) Replacement Parts - When replacement parts are required, be sure the service technician has used replacement parts specified by the manufacturer or have the same characteristics as the original part. Unauthorized substitutions may result in fire, electric shock, or other hazards.
- 20) Safety Check - Upon completion of any service or repairs to this product, ask the service technician to perform safety checks to determine that the product is in proper operating condition.
- 21) Wall or ceiling mounting - When mounting the product on a wall or ceiling, be sure to install the product according to the method recommended by the manufacturer.

## IMPORTANT SAFETY INSTRUCTIONS (continued)

- 22) Power Lines - An outside antenna system should not be located in the vicinity of overhead power lines or other electric light or power circuits, or where it can fall into such power lines or circuits. When installing an outside antenna system, extreme care should be taken to keep from touching such power lines or circuits as contact with them might be fatal.
- 23) Protective Attachment Plug - The product is equipped with an attachment plug having overload protection. This is a safety feature. See Instruction Manual for replacement or resetting of protective device. If replacement of the plug is required, be sure the service technician has used a replacement plug specified by the manufacturer that has the same overload protection as the original plug.
- 24) Stand - Do not place the product on an unstable cart, stand, tripod or table. Placing the product on an unstable base can cause the product to fall, resulting in serious personal injuries as well as damage to the product. Use only a cart, stand, tripod, bracket or table recommended by the manufacturer or sold with the product. When mounting the product on a wall, be sure to follow the manufacturer's instructions. Use only the mounting hardware recommended by the manufacturer.

## For U.S. customer only

### CONSUMER LIMITED WARRANTY

Hisense USA Corporation warrants to the first consumer purchaser that this Sharp brand product (the "Product"), when ship in its original container, will be free from defective workmanship and materials, and agrees that it will, at its option, either repair the defect or replace the defective Product or part thereof with a new or remanufactured equivalent at no charge to the purchaser for parts or labor for the period(s) set forth below.

This warranty does not apply to any appearance items of the Product nor to the additional excluded item(s) set forth below nor to any Product the exterior of which has been damaged or defaced, which has been subjected to improper voltage or other misuse, abnormal service or handling, or which has been altered or modified in design or construction.

In order to enforce the rights under this limited warranty, the purchaser should follow the steps set forth below and provide proof of purchase to the servicer.

The limited warranty described herein is in addition to whatever implied warranties may be granted to purchasers by law. ALL IMPLIED WARRANTIES INCLUDING THE WARRANTIES OF MERCHANTABILITY AND FITNESS FOR USE ARE LIMITED TO THE PERIOD(S) FROM THE DATE OF PURCHASE SET FORTH BELOW. Some states do not allow limitations on how long an implied warranty lasts, so the above limitation may not apply to you.

Neither the sales personnel of the seller nor any other person is authorized to make any warranties other than those described herein, or to extend the duration of any warranties beyond the time period described herein on behalf of Hisense.

The warranties described herein shall be the sole and exclusive warranties granted by Hisense and shall be the sole and exclusive remedy available to the purchaser. Correction of defects, in the manner and for the period of time described herein, shall constitute complete fulfillment of all liabilities and responsibilities of Hisense to the purchaser with respect to the Product, and shall constitute full satisfaction of all claims, whether based on contract, negligence, strict liability or otherwise. In no event shall Hisense be liable, or in any way responsible, for any damages or defects in the Product which were caused by repairs or attempted repairs performed by anyone other than an authorized servicer. Nor shall Hisense be liable or in any way responsible for any incidental or consequential economic or property damage. Some states do not allow the exclusion of incidental or consequential damages, so the above exclusion may not apply to you.

THIS LIMITED WARRANTY IS VALID ONLY IN THE FIFTY(50) UNITED STATES, THE DISTRICT OF COLUMBIA AND PUERTO RICO.

#### Model Specific Section

##### Your Product Model Number & Description:

##### HT-SB31D Sound Bar Home Theater System

(Be sure to have this information available when you need service for your Product.)

##### Warranty Period for this Product:

One (1) year parts and labor from the date of purchase.

##### Additional Item(s) Excluded from Warranty Coverage (if any):

Non-functional accessories, supplies, and consumable items.

##### Where to Obtain Service:

At a Hisense Authorized Servicer located in the United States. To find a location of the nearest Hisense Authorized Servicer, call Hisense toll free at 1-888-935-8880

##### What to do to Obtain Service:

Ship prepaid or carry in your Product to a Hisense Authorized Servicer. Be sure to have **Proof of Purchase** available. If you ship the Product, be sure it is insured and packaged securely.

Hisense is the authorized distributor for SHARP SOUND BAR HOME THEATER SYSTEM.  
TO OBTAIN SUPPLY, ACCESSORY OR PRODUCT INFORMATION, CALL 1-888-935-8880

HISENSE USA CORPORATION  
7310 McGinnis Ferry Road Suwanee, GA 30024

## Precautions

### General

- Please ensure that the equipment is positioned in a well ventilated area and ensure that there is a free space along the sides, top and back of the equipment as below.

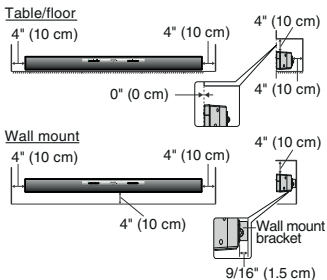

- Use the unit on a firm, level surface free from vibration.
- Keep the unit away from direct sunlight, strong magnetic fields, excessive dust, humidity and electronic/electrical equipment (home computers, facsimiles, etc.) which generate electrical noise.
- Do not place anything on top of the unit.
- Do not expose the unit to moisture, to temperatures higher than 140°F (60°C) or to extremely low temperatures.
- If the unit does not work properly, unplug and plug it in again. Then turn on the unit.
- In case of an electrical storm, unplug the unit for safety.
- Hold the AC power plug by the head when removing it from the AC outlet, as pulling the cord can damage internal wires.
- The AC power plug is used as a disconnect device and shall always remain readily operable.
- **Do not remove the outer cover, as this may result in electric shock. Refer internal service to your local Hisense service facility.**
- This unit should only be used within the range of 41°F - 95°F (5°C - 35°C).
- SHARP/Hisense are not responsible for damage due to improper use. Refer all servicing to a Hisense authorized service center.

### Warning:

- The supplied AC/DC adaptor contains no user serviceable parts. Never remove covers unless qualified to do so. It contains dangerous voltages, always remove mains plug from the main outlet jack before any service operation or when not in use for a long period.
- The AC/DC adaptor supplied with the HT-SB31D must not be used with other equipment.
- Never use an AC/DC adaptor other than the one specified. Otherwise, problem or serious hazards may be created.
- The voltage used must be the same as that specified on this unit. Using a higher voltage is dangerous and may result in a fire or other type of accident causing damage. SHARP/Hisense will not be held responsible for any damage resulting from such usage.

### Volume control

The sound level at a given volume setting depends on speaker efficiency, location and various other factors. It is advisable to avoid exposure to high volume levels, which occurs while turning the unit on with the volume control setting up high, or while continually listening at high volumes.

## Accessories

The following accessories are included.



Remote control x 1  
(RRMCGA399AW01)



AC/DC adaptor x 1  
(RADPAA102AWZZ)



AC power cord x 1  
(QACCDAA005AWZZ)



Optical cable x 1  
(QCNWGA125AWPZ)



Pattern paper x 1  
(TCAUHA034AWZZ)

## Controls and indicators

### ■ Front Panel

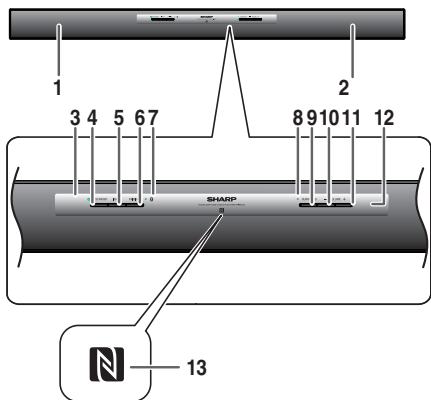

1. Left Channel Speakers
2. Right Channel Speakers
3. On/Standby/Input Indicator
4. On/Standby Button
5. Input Button
6. Pairing Button
7. Pairing Indicator
8. Surround Indicator
9. Surround Button
10. Volume Down Button
11. Volume Up Button
12. Remote Sensor
13. NFC detection area

### ■ Rear Panel

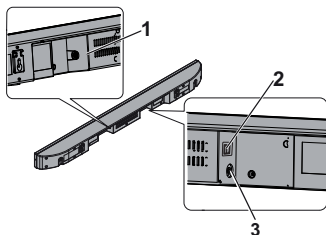

1. DC In Jack
2. Optical In Jack
3. Audio In Jack

## Controls and indicators (continued)

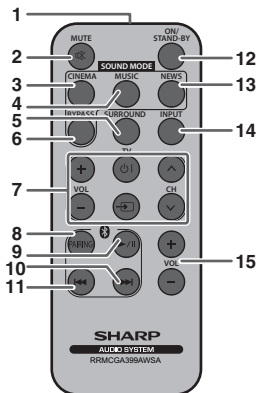

### Remote Control

1. Remote Control Transmitter
2. Mute Button
3. Cinema (Sound Mode) button
4. Music (Sound Mode) button
5. Surround Button
6. Bypass (Sound Mode) button
7. TV Operation Buttons (only SHARP TV)
8. Bluetooth Pairing Button
9. Bluetooth Play/Pause Button
10. Bluetooth Skip Up Button
11. Bluetooth Skip Down Button
12. On/Standby Button
13. News (Sound Mode) button
14. Input Button
15. Volume Up/Down Buttons

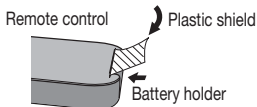

#### Note:

Before using remote control, please remove plastic shield at battery holder.

#### TV Operation Buttons (Only SHARP TV):

On/Standby Button		Sets the TV power to "ON" or "STANDBY".	Input Select Button (TV)		Press the button to switch the input source.
Volume Up and Down Buttons		Turn up/down the TV volume.	Channel Up and Down Buttons		Switch up/down the TV channels.

- Note:**
- Some models of SHARP TV may not be operable.
  - SHARP TV remote control will not work with HT-SB31D system.



## System preparation

Make sure to unplug the AC power cord before installing the sound bar or changing the position.

### To mount the sound bar on the wall

#### Caution:

- Be very careful to prevent the sound bar [P lbs. (P kg)] from falling when mounting on the wall.
- Before mounting, check the wall strength. (Do not put on the veneer plaster or whitewashed wall. The sound bar may fall.) If unsure, consult a qualified service technician.
- Mounting screws are not supplied. Use appropriate ones.
- Check all wall mount angle screws for looseness.
- Select a good location. If not, accidents may occur or the sound bar may get damaged.
- **SHARP/Hisense are not responsible for accidents resulting from improper installation.**

### ■ Driving screws

SHARP designed the sound bar so you may hang it on the wall. Use proper screws (not supplied). See below for size and type.

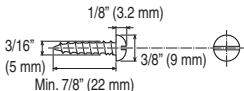

### ■ Installing the sound bar

- 1 Fix the pattern paper to the wall in horizontal position as below.

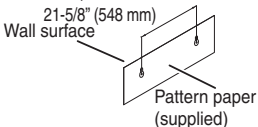

- 2 Make a hole in the wall following the screw point marks on the pattern paper by using a drill.

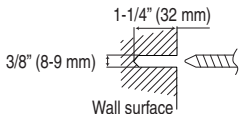

- 3 Fix a wall mount plug into the hole using a hammer, until it is flush with the wall surface.

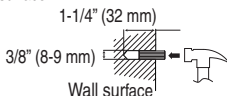

- 4 Fasten the screws to the wall as shown below. (Total screw is 2 pieces)

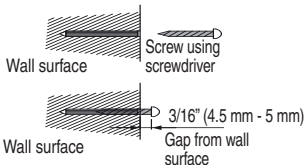

- 5 Hang the sound bar onto the screws.

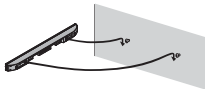

## Placing the sound bar

Installation image:

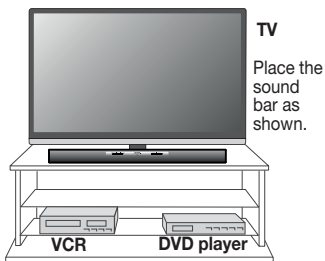

### Notes:

- Remove the protective film covering the sound bar before turning on the system.
- The front panel of the sound bar is not removable.

### Caution:

- Do not change the installation direction when the sound bar is turned on.
- Do not stand or sit on the sound bar as you may be injured.

## Falling prevention

- Safety wires (not supplied) are useful to prevent the sound bar from falling.

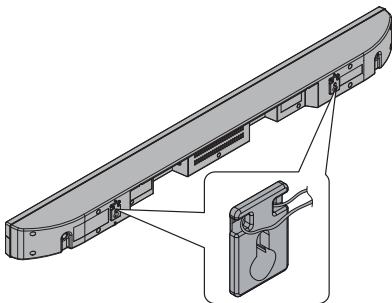

## Falling prevention (continued)

### ■ When mounting on the wall

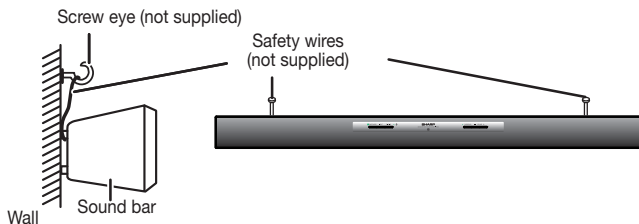

### ■ When placing on the shelf/table

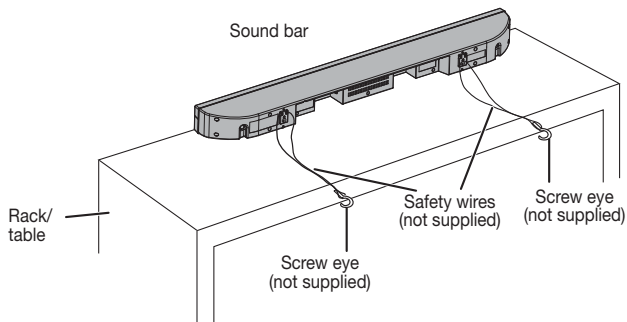

## Sound bar connections to TVs

### Caution:

Turn off all other equipment before making any connections.

### Notes:

- To connect to TV/player, use AUDIO IN or OPTICAL IN terminals located at the rear of the sound bar.
- Refer the operation manual of the equipment to be connected.
- Fully insert the plugs to avoid fuzzy pictures or noises.
- If the TV volume is continuously at low level, the sound bar will automatically power off. Increase the TV output volume to enjoy the sound from the speaker.
- To avoid desynchronized audio and video when using an external player, connect the output signal from the player to TV and the audio output (from TV) to the sound bar.

### ■ Connecting a TV, or DVD player, etc.

If the TV/monitor has an audio or optical output, connect it to the AUDIO IN jack or OPTICAL IN jack on the rear of the sound bar.

Press the INPUT button repeatedly to select:

Function	On/Standby/Input Indicator
OPTICAL IN	Turns green
AUDIO IN	Turns cyan
<i>Bluetooth</i>	Turns blue

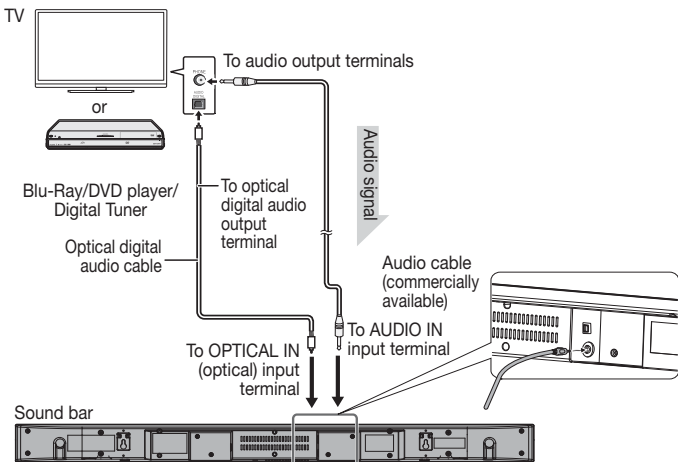

## AC power connection

After checking all the connections have been made correctly, connect the AC power cord to the AC power input jack, then to the AC outlet.

### ■ Using with the AC/DC adaptor

- ① Plug the AC power cord into the AC/DC adaptor.
- ② Plug the AC/DC adaptor cable into the DC INPUT jack on the sound bar.
- ③ Plug the AC power cord into an AC outlet. The PAIRING indicator turns BLUE.

#### Notes:

- Unplug the AC/DC adaptor from the AC outlet if the sound bar will not be used for a prolonged period of time.
- Use only the supplied AC/DC adaptor. Using other AC/DC adaptor may cause an electric shock or fire.

**Make sure to unplug the AC power cord before making any connections.**

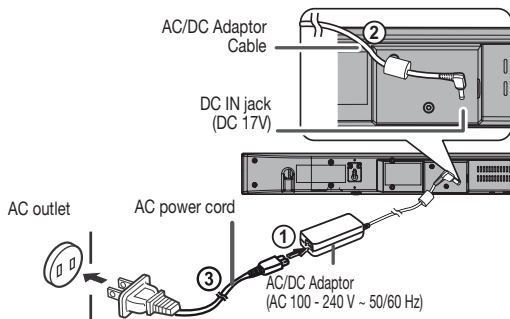

**CAUTION:**  
TO PREVENT ELECTRIC SHOCK, MATCH WIDE BLADE  
OF PLUG TO WIDE SLOT, FULLY INSERT.

## Remote control



### WARNING

#### DO NOT INGEST BATTERY, CHEMICAL BURN HAZARD

- The remote control supplied with this product contains a coin/button cell battery. If the coin/button cell battery is swallowed, it can cause severe internal burns in just two (2) hours and can lead to death.
- Keep new and used batteries away from children. If the battery compartment does not close securely, stop using the product and keep it away from children.
- If you think batteries might have been swallowed or placed inside any part of the body, seek immediate medical attention.

This product contains a CR Coin Lithium Battery which contains Perchlorate Material – special handling may apply.

California residents, see

[www.dtsc.ca.gov/hazardouswaste/perchlorate/](http://www.dtsc.ca.gov/hazardouswaste/perchlorate/)

### ■ Battery installation

- 1 While pushing the locking tab towards the center of the remote control, slide out the battery holder.

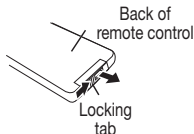

- 2 Remove the old battery from the battery holder, insert the new battery and then slide the battery holder back into the remote control.

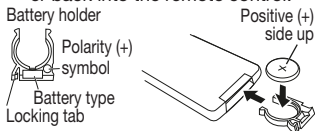

### Precautions for battery use:

Remove the battery if the sound bar will not be used for a long period of time. This will prevent potential damage due to battery leakage.

### Caution:

- Do not use rechargeable battery (nickel-cadmium battery, etc.).
- Danger of explosion if battery is incorrectly replaced.
- Replace only with the same or equivalent type.
- Batteries (battery pack or batteries installed) shall not be exposed to excessive heat such as sunshine, fire or the like.
- Installing the battery incorrectly may cause the sound bar to malfunction.

### Notes concerning use:

- Replace the battery if the operating distance is reduced or if the operation becomes erratic. Purchase "CR 2025", coin lithium battery.
- Periodically clean the transmitter on the remote control and the sensor on the sound bar with a soft cloth.
- Exposing the sensor on the sound bar to strong light may interfere with operation. Change the lighting or the direction of the sound bar if this occurs.
- Keep the remote control away from moisture, heat, shock, and vibrations.

### ■ Test of the remote control

The remote control can be used within the range shown below:

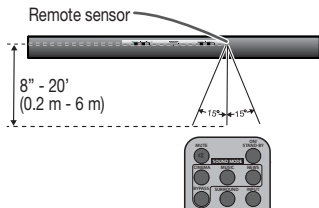

## General control

### ■ To turn the power on

#### Press the ON/STANDBY button.

The On/Standby/Input Indicator lights up according to input source:

Input source	On/Standby/Input Indicator
OPTICAL IN	Turns green
AUDIO IN	Turns cyan
Bluetooth	Turns blue

#### Note:

If the power does not turn on, check whether the power cord is plugged in properly.

#### To set the sound bar to standby mode:

Press the ON/STANDBY button again. The PAIRING indicator turns BLUE.

### ■ Bluetooth standby mode

- The first time the unit is plugged in, it will enter the *Bluetooth* standby mode (PAIRING indicator turns BLUE).
- To cancel the *Bluetooth* standby mode, press and hold the ON/STANDBY button during *Bluetooth* standby mode. The unit will enter the low power consumption mode (PAIRING indicator turns off).
- During low power consumption mode, to return to the *Bluetooth* standby mode, press the ON/STANDBY button twice.
- During *Bluetooth* standby condition, NFC function is activated once your device touches the NFC detection area.

### ■ Volume auto fade-in

If you turn off and on the sound bar again, volume will start at lower level and gradually increase to the last set level.

### ■ Volume control

#### Sound bar operation:

Press volume up (VOLUME +) to increase the volume and press volume down (VOLUME -) to decrease the volume.

#### Remote control operation:

Press the VOL + button to increase the volume and the VOL - button to decrease the volume.

#### Notes:

- When volume is maximum or minimum the SURROUND indicator blinks 3 times
- To increase or decrease the volume continuously, press and hold the VOLUME +/- buttons (main unit) or VOL +/- buttons (remote control).

### ■ Muting

The volume is muted temporarily when pressing the MUTE button on the remote control (SURROUND indicator blinking). Press again to restore the volume.

### ■ Surround

When the SURROUND button is pressed, the SURROUND sound is ON. (SURROUND indicator lights up (ORANGE))

### ■ Sound Mode

#### Remote control operation:

Press the desired sound mode button on the remote control.

The SURROUND indicator blinks once.

CINEMA	(for cinema sound effect)
MUSIC	(for standard sound effect)
NEWS	(for news)
BYPASS	(for flat sound effect)

### ■ Function

When the INPUT button is pressed, the input source will change.

#### ① Optical In Function

On/Standby/ Input Indicator	Condition
Lights up	Supported audio format.
Blinks	Unsupported audio format or no input signal.

② **Audio In Function** - the On/Standby/ Input indicator turns cyan.

③ **Bluetooth Function** - the On/Standby/ Input indicator turns blue.

## General control (continued)

### Note:

- This product supports only “PCM” signal format for optical input. If there is no sound from optical input, please set your optical source equipment to output “PCM” signal format.
- The backup function will protect the memorized function mode for a few hours should there be a power failure or the AC power cord becomes disconnected.

### ■ Auto power on function

- Auto power on function works only during *Bluetooth* standby mode (PAIRING indicator is blue). It will not work if the sound bar is in low power consumption mode (PAIRING indicator is off).

**Optical In:** Turn off the external source. The sound bar will automatically power ON if the external source is turned ON again.

**Audio In/Bluetooth:** The sound bar will automatically power ON if it detects audio signal from connected equipment.

### ■ Auto power off and auto detect signal

- The sound bar will automatically go to standby mode (PAIRING indicator turns blue) if:

**Optical In:** No audio signal is detected after approximately 15 minutes.

**Audio In:** No audio signal is detected after approximately 15 minutes.

**Bluetooth:**

- No connection after approximately 1 minute.
- In the pause or stop mode and no incoming signal from device after approximately 15 minutes.



## Bluetooth one touch connection via NFC

### ■ About NFC technology

Near Field Communication (NFC) is a set of standards for devices (smartphones/tablets) to establish radio communication with each other by touching/tapping them together or bringing them into close proximity.

Using NFC in this product simplifies the pairing method of *Bluetooth* connectivity.

#### Notes for Android devices

- This audio system supports NFC-enabled device with Android 4.1, Jelly Bean and higher.
- For device with a lower Android version, refer the operation manual of the device for recommended app (application).

Unlike other wireless technology, NFC requires no discovery or pairing.

Simply tap the source device to the NFC detection area on the main unit to instantly enjoy seamless connectivity between your smart device and the audio system.

### ■ NFC detection area

NFC detection area location may vary depending on the device (smartphone/tablet). Refer operation manual of the device for detail.

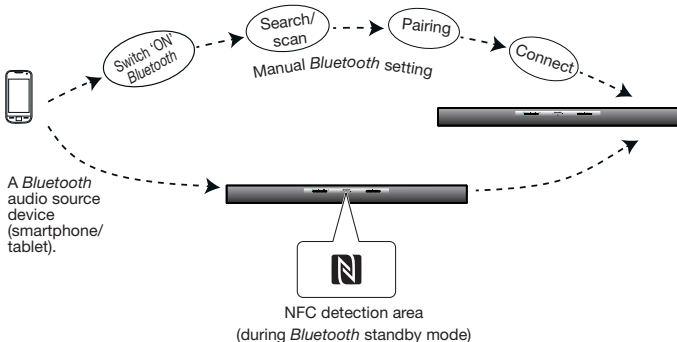

## Bluetooth one touch connection via NFC (continued)

### NFC connection for audio playback

#### Check that:

- Your device (smartphone/tablet) has an NFC function.
- NFC function on your device is enabled.
- Screen lock function of the device is off.
- This unit is not in low power consumption mode.

- 1 Touch your device to the NFC detection area on the main unit. (NFC detection area of your device must touch to the NFC detection area of the main unit.)

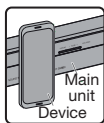

- 2 A pop-up window asking whether to proceed with the *Bluetooth* connection appears on the device. Select <YES>.
- The 'connected' message appears when the connection is complete.
- 3 Playback will start automatically, otherwise press play (on remote control or source device).
- Sound will be heard from the speakers of this unit via audio streaming.
- Your device must be within 32 feet (10 meters) from the unit.

#### Bluetooth operation buttons (remote control only)



Press the button to play or pause.



Press the button to skip up.



Press the button to skip down.

#### Notes:

- This product switches to *Bluetooth* function automatically when NFC tagging was done by your device.
- If your device does not support NFC, or if you wish to listen to audio via *Bluetooth* connectivity without NFC; refer "**Pairing with other Bluetooth source devices**" on the next page.
- Some *Bluetooth* devices will connect to this product automatically when the device or its *Bluetooth* mode was turned on. In such case, it will also change the function selection of this product. If you do not want it to connect automatically, please disable *Bluetooth* on your device.
- It takes about 6-8 seconds for a *Bluetooth* enabled device (eg. smartphone) to establish *Bluetooth* connection with this unit via NFC or manual connection.
- If "Empty tag" or similar message appears on your device, touch the device again to the NFC detection area on the main unit.

## Listening to *Bluetooth* enabled devices

*Bluetooth* wireless technology is a short-range radio technology that enables wireless communication between various types of digital devices, such as mobile phone or computer. It operates within a range of about 32 feet (10 meters) without the hassle of having to use cables to connect these devices.

### This sound bar supports the following:

Communication System: *Bluetooth* Specification version 2.1 *Bluetooth* + Enhanced Data Rate (EDR).

Support Profile : A2DP (Advanced Audio Distribution Profile) and AVRCP (Audio/Video Remote Control Profile)

### Notes when using unit with a mobile phone

- This unit cannot be used to talk over the telephone even when there is a *Bluetooth* connection made to a mobile phone.
- Please refer to the operating manual supplied with the mobile phone for details on operation of your mobile phone while transmitting the sound using a *Bluetooth* connection.

### ■ Pairing *Bluetooth* devices

*Bluetooth* devices need to be initially paired first before they can exchange data. Once paired, it is not necessary to pair them again unless:

- pairing is made with more than 99 devices. Pairing can only be made one device at a time. This sound bar can be paired to a maximum of 99 devices. If subsequent device is paired, the oldest device paired, will be deleted and replaced with the new one.
- pairing information is deleted while repairing, etc.

### *Bluetooth* indicators

Status	PAIRING indicator (blue)
Unconnected	Blinks
Pairing mode	Blinks quickly
Connected	Lights up

However, the indicator status is not displayed during low power consumption mode.

### ■ Pairing with other *Bluetooth* source device

- 1 Press the ON/STANDBY button to turn the power on.
- 2 Press the INPUT button to select *Bluetooth* function. (PAIRING indicator blinks.)
- 3 Press and hold the PAIRING button for 3 seconds or more.  
  
PAIRING indicator blinks quickly. The sound bar is now in pairing mode and is ready to be paired with other *Bluetooth* source device.
- 4 Perform pairing procedure on the source device to detect this sound bar. "HT-SB31D SHARP" will appear in the detected devices list (if available) in the source device. (Refer the source device operating manual for details).

Notes:

- Place the devices to be paired within 3 feet (1 meter) of each other when pairing.
- Some source devices are unable to display lists of detected devices. To pair this sound bar with the source device, refer to the source device operating manual for details.

- 5 Select "HT-SB31D SHARP" from the source list. If Passcode\* is required, enter "0000".  
\* Passcode may be called PIN Code, Passkey, PIN number or Password.
- 6 Pairing indicator (blue) will stop blinking once the sound bar is successfully paired with the source device. (Pairing information is now memorized in the sound bar.)  
  
Some audio source devices may connect with the sound bar automatically after pairing is completed, otherwise follow the instructions in the source device operating manual to start connection.
- 7 Press the play button on remote control or source device to start *Bluetooth* streaming playback.

## Listening to *Bluetooth* enabled devices (continued)

### Notes:

- If a device such as microwave oven, wireless LAN card, *Bluetooth* device or any other device that uses the same 2.4 GHz frequency is placed near the system some sound interruption may be heard.
- The transmission distance of the wireless signal between the device and the sound bar is about 32 feet (10 meters), but may vary depending on your operating environment. If a steel concrete or metallic wall is between the device and the sound bar, the system may not operate at all, because the wireless signal cannot penetrate metal.
- If this sound bar or the source device is turned off before *Bluetooth* connection is completed, pairing will not be completed and the pairing information will not be memorized. Repeat step 1 onwards to start pairing again.
- To pair with other devices, repeat steps 1 - 5 for each device.

This sound bar can be paired to a maximum of 99 devices. If subsequent device is paired, the oldest device paired, will be deleted and replaced with the new one.

- Once a device is ousted or deleted from the pairing list, the pairing information for the device is also deleted. To listen to the sound from the device again, it needs to be re-paired. Perform steps 1 - 5 to pair the device again.
- HT-SB31D supports *Bluetooth* profile AVRCP 1.4. If your device supports the same profile (refer to device manufacturer's specification), HT-SB31D is able to control the volume of the device.

### Note:

Some music applications do not support this feature, hence there will be no volume synchronisation between your device and the sound bar even if your *Bluetooth* device supports such profile.

## ■ Listening to the sound

### Check that:

- The source device *Bluetooth* functionality is ON.

- Pairing of this sound bar and the source device is completed.
- Sound bar is in connected mode (pairing indicator (BLUE) lights up.)
- Any device connected to the AUDIO IN or OPTICAL IN jack is turned off.

**1 Press the ON/STANDBY button to turn the power on.**

**2 Press the INPUT button to select *Bluetooth* function.**

**3 Start the *Bluetooth* connection from the *Bluetooth* stereo audio source device.**

**4 Playback will start automatically, otherwise press play (on the remote control or the source device).**

### Notes:

- For various *Bluetooth* operations, refer "NFC connection for audio playback" on page 17.
- If the source device has an extra bass function or equaliser function, set them to off. If these functions are on, sound may be distorted.

### Notes:

- Make the *Bluetooth* connection again if the source device is not turned on, or its *Bluetooth* functionality is off or is in sleep mode.

## ■ To disconnect the *Bluetooth* device

Perform any of the followings.

- Disconnect the *Bluetooth* connection on the audio source device.  
Refer the operating manual supplied with the device.
- Turn off the *Bluetooth* stereo audio source device.
- Turn off this sound bar.

### Note:

The volume of this sound bar may not be controlled as intended depending on the device.

## Troubleshooting chart

Many potential problems can be resolved by the owner without calling a service technician. If something is wrong with this product, check the following before calling your authorized dealer or service center.

### ■ General

Symptom	Possible cause
No sound is heard.	<ul style="list-style-type: none"> <li>● Is the input signal (selection) set properly?</li> <li>● Is the volume level set to minimum?</li> <li>● Is muting activated?</li> <li>● Are the connections made correctly?</li> </ul>
Noise is heard during playback.	<ul style="list-style-type: none"> <li>● Move the sound bar away from any computers or mobile phones.</li> </ul>
Sound is distorted.	<ul style="list-style-type: none"> <li>● TV output sound is distorted. Reduce the TV volume or sound bar volume.</li> </ul>
When a button is pressed, the sound bar does not respond.	<ul style="list-style-type: none"> <li>● Set this sound bar to the standby mode and then turn it back on.</li> <li>● If the sound bar still malfunctions, reset it. (Refer to page 21.)</li> </ul>
The power is not turned on.	<ul style="list-style-type: none"> <li>● Is the sound bar unplugged? (Refer to page 12.)</li> <li>● The protection circuit may be activated. Unplug and plug in the power cord again after 5 minutes or more.</li> </ul>

### ■ NFC / Bluetooth

Symptom	Possible cause
NFC-enabled device cannot connect to Bluetooth via NFC.	<ul style="list-style-type: none"> <li>● Main unit is not in Bluetooth pairing mode. Perform "NFC connection for audio playback". (Refer page 17.)</li> </ul>

No sound is heard.	<ul style="list-style-type: none"> <li>● Is the sound bar too far from the Bluetooth stereo audio source device?</li> <li>● Is the sound bar paired with the Bluetooth stereo audio source device?</li> <li>● Is the Bluetooth stereo audio source device in playback condition?</li> <li>● Is a headphone plugged to the Bluetooth stereo audio source device?</li> </ul>
Bluetooth sound is interrupted or distorted.	<ul style="list-style-type: none"> <li>● Is the sound bar too near to a device that generates electromagnetic radiation?</li> <li>● Is there any obstacle between the sound bar and the Bluetooth stereo audio source device?</li> </ul>

### ■ Remote control

Symptom	Possible cause
The remote control does not operate properly.	<ul style="list-style-type: none"> <li>● Is the battery polarity correct?</li> <li>● Is the battery dead?</li> <li>● Is the distance or angle incorrect?</li> <li>● Are there any obstructions in front of the sound bar?</li> <li>● Is there a strong light shining on the remote sensor?</li> <li>● Is the remote control for another equipment used simultaneously?</li> </ul>
The sound bar cannot be turned on with the remote control.	<ul style="list-style-type: none"> <li>● Is the AC power cord of the sound bar plugged in?</li> <li>● Is the battery inserted?</li> <li>● Has the plastic shield at the remote control battery holder been removed?</li> </ul>

## Troubleshooting chart

### ■ Condensation

Sudden temperature changes, storage or operation in an extremely humid environment may cause condensation inside the cabinet or on the transmitter on the remote control.

Condensation can cause the sound bar to malfunction. If this happens, leave the power on until normal operation is possible (about 1 hour). Wipe off any condensation on the transmitter with a soft cloth before operating the sound bar.

### ■ Factory reset, clearing all setting

Make sure to disconnect all audio input cables attached to the sound bar before performing the factory reset.

1. Press ON/STANDBY button to enter the power standby mode.
2. While pressing down the PAIRING button, press the ON/STANDBY button.
3. Press the ON/STANDBY button again. (PAIRING indicator will turn BLUE.)

#### Caution:

This operation will erase all data stored in memory.

### ■ If problem occurs during operation

When this product is subject to strong external interference (mechanical shock, excessive static electricity, abnormal supply voltage due to lightning, etc.) or if it is operated incorrectly, it may malfunction.

If such a problem occurs, do the following:

1. Set the sound bar to the standby mode and turn the power on again.
2. If the sound bar is not restored in the previous operation, unplug and plug in the sound bar, and then turn the power on.

## Maintenance

### ■ Cleaning the cabinet

Periodically wipe the cabinet with a soft cloth.

#### Cautions:

- Do not use chemicals for cleaning (gasoline, paint thinner, etc.). It may damage the cabinet finish.
- Do not apply oil to the inside of each component. It may cause malfunctions.

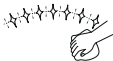

## Specifications

As part of our policy of continuous improvement, SHARP reserves the right to make design and specification changes for product improvement without prior notice. The performance specification figures indicated are nominal values of production unit. There may be some deviations from these values in individual unit.

### ■ General

Power source	DC IN 17V  2.8A: AC/DC adaptor (AC 100 - 240V ~ 50/60Hz)
Power consumption	10 W
Maximum output power	RMS: Total 40 Watts 20 Watts per channel into 6 ohms at 1 kHz, 10% total harmonic distortion FTC: Minimum P watts per channel into 6 ohms at 100 Hz to 20 kHz, 1% total harmonic distortion
Speaker	1-way Speaker System 2-1/4" (5.7cm) Full Range
Input terminals	Analog input (AUDIO IN): Stereo mini jack Ø 3.5mm 500mV / 47kΩ Optical digital input (OPTICAL): Square type x 1
Bluetooth Frequency Band	2.400GHz - 2.480GHz
Compatible Bluetooth Profile	A2DP (Advanced Audio Distribution Profile), AVRCP (Audio/Video Remote Control Profile) Bluetooth 2.1 +EDR
Dimensions	Width: 37" (940mm) Height: 2-7/8" (73mm) Depth: 3-1/4" (83mm)
Weight	P lbs. (P kg)