

Register your product and get support at
www.philips.com/welcome

Screeneo



HDP1590
HDP1690

EN User Manual

PHILIPS

Table of Contents

Overview	3	8 Media Playback.....	23
Dear Customer	3	Navigating in the media Playback	23
About this User Manual	3	Video playback	24
What's in the Box	3	Photo Playback	24
Product Highlights	3	Music Playback	26
		Managing Files	27
1 General Safety Information.....	4	9 Digital TV Playback	
Setting up the Device	4	(Depending on model).....	28
Automatic device temperature control	4	Connecting the Aerial	28
Repairs	4	First Playback	28
Power Supply	5	Television	29
Wireless Network (WLAN)	5	Modifying the DVB-T settings	29
3D glasses use	5	10 Android.....	30
Dolby Digital	5	Starting Android Apps	30
		Exiting Android	30
2 Overview.....	6	Installing Android-Apps	30
Front View	6	11 Settings.....	31
Rear View	6	Overview of the Menu Functions	31
Remote Control	7	12 Service	33
Browsing the user interface	8	Cleaning	33
Overview of the Menu Functions	8	Device Overheated	33
Symbols in the Statusbar	9	Update Firmware with Memory Card	33
		Troubleshooting	34
3 Initial Operation	10	13 Appendix	36
Setting up the Device	10	Technical Data	36
Connect Power Supply	10	Accessories	36
Installing or Changing the Batteries of the			
Remote Control	10		
Using the Remote Control	11		
Initial Installation	12		
4 Connect to the Playback Device	13		
Connecting to Devices with HDMI Output	13		
Connecting to a Computer (VGA)	13		
Connecting Using an Audio/Video (CVBS)			
Adapter Cable	14		
Connecting to a home cinema amplifier	14		
Connecting to a Hi-Fi unit	14		
Connecting the headphones	15		
WiFiDisplay (Miracast)	15		
5 Memory.....	16		
Inserting a Memory Card	16		
Connecting USB Storage Medium	16		
6 Network.....	17		
LAN Network	17		
Wireless Network (WLAN)	18		
Switching Wireless Networking (WLAN) on/off	18		
Setting up a Wireless Network (WLAN)	18		
Setting up a Wireless Network (WLAN) using			
the Wizard	19		
Wifi Hotspot	19		
Digital Living Network Alliance (DLNA)	20		
7 Bluetooth.....	21		
Activating the Bluetooth connection	21		
Setting up Bluetooth parameters	21		
Bluetooth speaker	21		

Overview

Dear Customer

Thank you for purchasing our projector.

We hope you enjoy your device and its many functions!

About this User Manual

With the installation guide on the following pages, you can start using your device quickly and easily. Detailed descriptions can be found in the following sections of this user manual.

Read the entire user manual carefully. Follow all safety instructions in order to ensure proper operation of your device. The manufacturer accepts no liability if these instructions are not followed.

This user manual describes several versions of the product. Only the models HDP1590 and HDP1590TV have the WiFi (Miracast, DLNA,..) and Bluetooth functions.

Only the models HDP1550TV and HDP1590TV have the DVB-T function.

Symbols Used

Notice



Troubleshooting

This symbol designates tips that will help you to use your device more effectively and easily.

CAUTION!



Damage to the Device or Loss of Data!

This symbol gives warning of damage to the device and possible loss of data. This damage can result from improper handling.

DANGER!



Danger to Persons!

This symbol gives warning of danger to persons. Physical injury or damage can result from improper handling.

What's in the Box

- 1 – Projector
- 2 – Remote Control (with 2AAA battery)
- 3 – A/C power cable
- 4 – HDMI A to A cable
- 5 – 3D Glasses with his quick start guide, a warning label and a protection bag (depending on model)
- 6 – Quick Start Guide
- 7 – Warranty Guide
- 8 – Bag

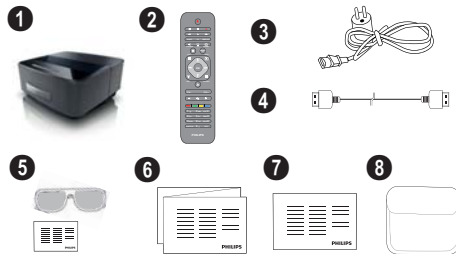

Product Highlights

Connecting to devices with HDMI output

With the HDMI cable you can connect the projector to a computer or laptop (see Connect to the Playback Device, page 13).

WiFiDisplay (Miracast)

With the Miracast™ solution you can display video between Wi-Fi devices, without cables or a network connection. You can do things like view pictures or videos from a smartphone or laptop on your projector.

1 General Safety Information

Do not make any changes or settings that are not described in this user manual. Physical injury or damage to the device or loss of data can result from improper handling. Take note of all warning and safety notes indicated.

Setting up the Device

The unit is for indoor use only. The device should be placed securely on a stable, flat surface. Position all cables in such a way that no one will stumble on them, thus avoiding possible injuries to persons or damage to the device itself.

Do not plug in the device in moist rooms. Never touch the mains cable or the mains connection with wet hands.

The device must have sufficient ventilation and may not be covered. Do not put your device in closed cabinets or boxes.

Do not place the machine on soft surfaces such as tablecloths or carpets and do not cover the ventilation slits. Otherwise the device could overheat or catch fire.

Protect the device against direct sunlight, heat, large temperature fluctuations and moisture. Do not place the device in the vicinity of heaters or air conditioners. Observe the information on temperature and humidity in the technical data.

Do not allow liquids to enter into the device. Switch off the device and disconnect it from the mains supply if liquids or foreign substances end up inside the device. Have the unit inspected by a technical service department.

Always handle the unit with care. Avoid touching the lens. Never place heavy or sharp objects on the projector or the power cable.

If the projector gets too hot or emits smoke, shut it down immediately and unplug the power cable. Arrange for your device to be investigated by a technical service centre. To prevent the spread of fire, open flames should be kept away from the device.

Under the following conditions, a layer of moisture can appear inside the device which can lead to malfunctions:

- if the device is moved from a cold to a warm area;
- after a cold room is heated;
- when this device is placed in a damp room.

Proceed as follows to avoid any moisture build-up:

- 1 Seal this device in a plastic bag before moving it to another room, in order for it to adapt to room conditions.
- 2 Wait one to two hours before you take the device out of the plastic bag.

The device should not be used in a very dusty environment. Dust particles and other foreign objects may damage the unit.

Do not expose the device to extreme vibrations. It may damage the internal components.

Do not allow children to handle the device without supervision. The packing materials should be kept out of the hands of children.

Automatic device temperature control

This device include an automatic thermal management controller. If the internal temperature gets too hot, the Fan speed will automatically increase (noise increase), if the temperature still continue to growth, the brightness of your product will decrease and in worst case the current symbol will appear.



The product will automatically switch off the display after displaying this message during 5s.

This kind of behaviour should not arrive except if the outside temperature is very high (>35°C). In such case return the product to the manufacturer would be recommended.

Repairs

Do not repair the device yourself. Improper maintenance can result in injuries or damage to the device. Your device must be repaired by an authorised service centre.

Find details of authorised service centres on the warranty card.

Do not remove the type label from your device; this would void the warranty.

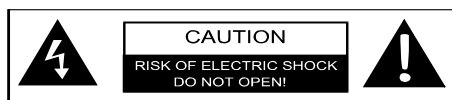

Power Supply

Before turning on your device, check that the outlet that you are going to plug it into conforms to the indications shown on the information plate (voltage, current, power network frequency) located on your device. This device shall be connected to a single phase power network. The device shall not be installed on bare ground.

Only use the power cable that is supplied with your device. Your device is delivered with a grounded power cord. It is imperative to connect a grounded connector to a grounded outlet connected to the building earthing.

The socket outlet shall be installed near the equipment and shall be easily accessible.

In case of failure, the power cable is the disconnect device for this equipment. To remove all electrical power from the equipment, disconnect the power cable from the electrical outlet.

Turn off the device and unplug from the power outlet before cleaning the surface. Use a soft, lint-free cloth. Never use liquid, gaseous or easily flammable cleansers (sprays, abrasives, polishes, alcohol). Do not allow any moisture to reach the interior of the device.

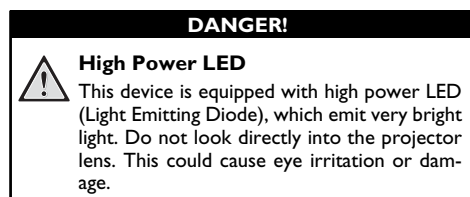

Wireless Network (WLAN)

The functioning of security systems, medical equipment or sensitive devices can be disrupted by the transmission power of the device. Observe any usage regulations (or restrictions) in the vicinity of such equipment.

The use of this device can affect the operation of insufficiently shielded medical devices and hearing aids and pacemakers through the release of high frequency radiation. Also consult a doctor or the manufacturer of the medical device to establish whether these are sufficiently shielded from external high frequency radiation.

3D glasses use

The use of 3D glasses in home for watching TV shows:

- is contraindicated for children less than 6 years old;
- for subjects from 6 years old to adulthood, should be limited to the vision for a maximum time equal to the duration of a film show;
- the same time limit is also recommended for adults;
- must be restricted to watching only 3D content

- how to make a proper and regular cleaning and disinfection in the case of any particular eventualities-ocular infections, infestations of the head, mixed use, etc. ... where disinfection of the glasses is not possible as it may damage the functionality of the 3D glasses must be communicated to the consumer that in presence of these eventualities-infections is contraindicated the use of 3D glasses for the person concerned until the disappearance of the above circumstances;
- 3D glasses must be kept out of children if there is the presence of small moving parts ingestible;
- 3D glasses are to be used together with the instruments of vision correction in case the consumer is the bearer of lenses (eyeglasses or contact lenses);
- You should stop watching 3D in the event of the occurrence of eye problems or discomfort, and in the event of a persistence of the same, consult a doctor.

Dolby Digital

Manufactured under license from Dolby Laboratories. Dolby and the double-D symbol are trademarks of Dolby Laboratories.

2 Overview

Front View

- ❶ Control panel for navigation and operation
 - ⊛ – To display the home menu
 - ⏪ – One menu step back, one directory level back / cancelling a function
 - ⬆/⬇/⬅/⬆ – Navigation keys / navigate the menu / modify settings
 - OK – Confirms selection
 - ⏻ – Long press: Power on /off the projector
Short press: ECO mode on / off
- ❷ 🎧 – Audio output – headphone connection or connection for external speakers
- ❸ **HDMI 3** – HDMI port for a playback device
- ❹ **SD** – Memory card slot
- ❺ ⏪ – USB port for a USB storage medium or to connect accessories (mouse or keyboard).
- ❻ Focus wheel for image sharpness

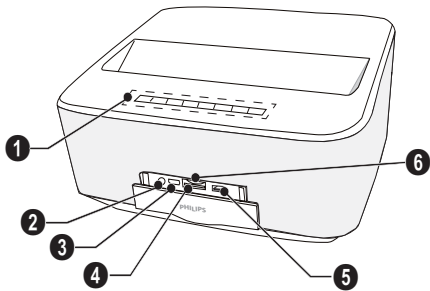

Rear View

- ❶ – Power supply outlet
- ❷ ⏪ – 2 USB ports for a USB storage medium
- ❸ **SPDIF OPTICAL** – Digital audio connector
- ❹ **HDMI** – HDMI 1 and 2 ports for a playback device
- ❺ Kensington Security System Connector
- ❻ **VGA** – Personal Computer input
- ❼ **LAN** – LAN network connector
- ❽ **AUDIO** – Analog audio connectors
- ❾ **A/V IN** – A/V port for a playback device
- ❿ **TRIG OUT** – Remote screen connection
- ⓫ **ANTENNA** – Aerial socket for TV connection
- ⓬ – Lens

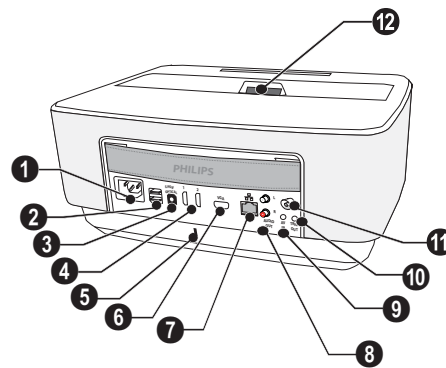

Remote Control

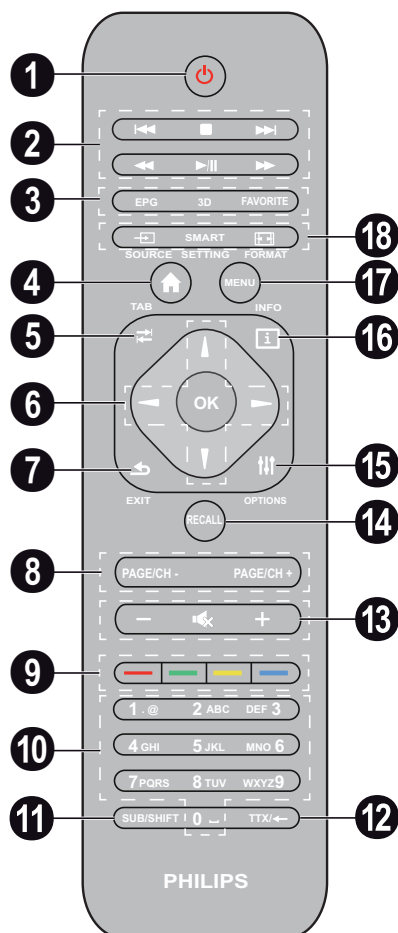

1 Long press: Power off the projector. To power the projector on use the key on the control panel.
Short press: ECO mode on / off

2 Playback keys

– Skip backward (music only)

– To stop playback

– Skip forward (music only)

– To rewind

– To start / pause playback

– To fast-forward

3 **EPG** – To display the electronic program guide.

3D – To display the 3D menu.

Favorite – To display the favourite list in DVB-T mode.

4 To display the home menu.

5 **TAB** key or Toggle between TV and Radio channels in DVB-T mode and browsing the Internet without external keyboard.

6 Navigation keys

OK – Confirms selection

/, / – Navigation keys / navigate the menu / modify settings.

7 **EXIT** – One menu step back, one directory level back / cancelling a function.

8 **PAGE/CH- PAGE/CH+** – To select the previous channel/page or the next channel/page.

9 Color keys - On-screen options.

10 Number keys and text keypad.

Short press for numbers and long press to switch "letters"

11 **SUB/SHIFT** – To display subtitles in DVB-T mode or shift key in input mode.

12 **TTX/←** – To display Teletext pages when available in DVB-T mode or backspace key in input mode.

13 **- / +** – To adjust the volume level (to decrease/increase and to mute the sound).

14 **RECALL** – To recall the last function or the last channel viewed in DVB-T mode.

15 **OPTIONS** – To call the option menu.

16 **INFO** – To display program information on current program in DVB-T mode.

17 **MENU** – To display the settings menu in DVB-T mode.

18 **SOURCE** – To display the list of input connections.

SMART SETTINGS – To display the Smart settings menu

FORMAT – To change the aspect ratio.

Browsing the user interface

Navigation for setting menu

Navigation can be done by navigation keys (▲, ▼, ◀, ▶, **OK** and ⏪) on the control panel or the remote control, as well as by an air mouse.

Navigation by keys:

- ▲/▼ scrolls through the menu level up and down.
- **OK**/▶ goes one level down, with ◀ / ⏪ one level up.
- ⏪ goes back to the main screen.
- In the final level, **OK** accepts a setting and goes back to the last sub menu.
- The ⏪ key aborts a setting and goes back to the last sub menu (or exits the menu depending on which menu)

Navigation by (air) mouse: (like standard mouse operation within Android)

CAUTION!



Air mouse

The air mouse is not provided.

Select an icon by pointing with the mouse pointer and clicking with the left mouse key.

If there are more menus listed than displayed you can scroll the list by clicking into the list and move up and down without releasing the left mouse button.

With the right mouse key you can exit the menu and go back to the next top level menu.

Software Keyboard

Notice



To enter text, you can also use standard computer keyboard or mouse. It is possible to use wired models (USB) as well as wireless models with 2.4 GHz USB-connectors.

When you need to enter data, the projector displays a virtual keyboard which allows you to enter text, numbers and punctuation marks, etc.

- 1 Select the input field using the ▲, ▼, ◀ and ▶ keys, then press the **OK** key to display the keyboard or click in the input field using the air mouse.
- 2 The software keyboard appears.
- 3 Enter the text on the software keyboard.

Overview of the Menu Functions

- 1 After switching on the device the main menu appears.
- 2 Select the desired menu using the navigation keys ▲/▼, ◀/▶.
- 3 Confirm with **OK**.
- 4 By pressing the ⏪ key you will return to the main menu.



HDMI 1, 2, & 3 – Switch to the external video input HDMI.

TV¹ – Television

DLNA – Displays the list of the devices found on the Network.

Memory – Display the content of the internal memory and the inserted memory SD-Card (movies, pictures, musics, folderview).

USB – Display the content of the connected USB media (movies, pictures, musics, folderview).

WWW – Open an Internet web browser.

VGA – Switch to the Personal computer input.

AV-in – Switch to the Audio Video input.

APPs – Call the android operating system.

Settings – Configure settings for the wished used of the device.

1. Depending on the device model, TV can be replaced by BT speaker.

Symbols in the Statusbar



- ① – Time
- ② – Date
- ③ – LAN status display
- ④ – Bluetooth status display
- ⑤ – WiFi status display

3 Initial Operation

Setting up the Device

Before installing your device, make sure that the projector is turned off and the power cord is unplugged from the power outlet.

You can position the device so that it lies flat on a table in front of the projection surface; it is not necessary to tilt it towards the projection surface. The device compensates for the distortion from the slanted projection (pincushion distortion).

Check that the projection surface is appropriated to the projector. The distance between the projector and the screen determines the actual size of the image.

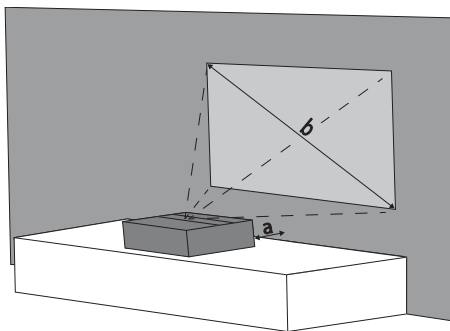

To change the size of the screen, just move the projector towards or away from the wall.

The size of the screen (b) is comprised between 50 and 100 inches depending on the projection distance (a), as described in the following table.

Diagonal size (b) (mm) [inch]	Projection distance (a) (mm)
1270 [50]	108
2540 [100]	441

Connect Power Supply

CAUTION!

 The power cord is used as a power unit cut off. As a precaution, the outlet shall be located close to the device and be of easy access in case of danger.

- 1 Connect the power cord into the socket on the rear side of your device (1).
- 2 Plug the power cord to outlet on the wall (2).

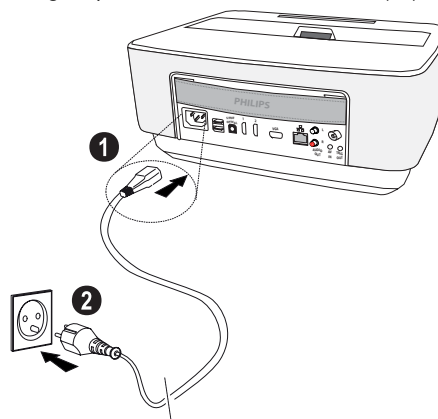

Installing or Changing the Batteries of the Remote Control

DANGER!

 **Risk of Explosion with Incorrect Type of Batteries**
Only use the AAA type battery.
There is a risk of explosion if the incorrect battery type is used.

- 1 To access the battery, press to unlock the locking mechanism (1) and slide out the battery compartment (2).

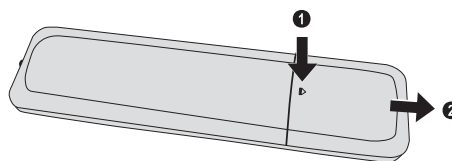

- 2 Insert the new batteries into the battery compartment with the positive and negative poles as shown. Make sure the polarities (+ and -) are aligned correctly.

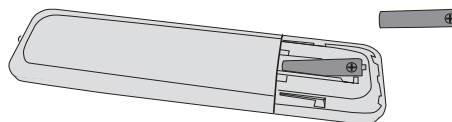

- 3 Push the battery compartment back into the remote control until the locking mechanism engages.

Notice

 Normally the batteries will last for around one year. If the remote control stops working, please replace the batteries. If the device is not used for a long time, take out the batteries. This will prevent leakage and possible damage to the remote control.

The used batteries should be disposed of according to the recycling regulations of your country.

Using the Remote Control

The remote control can be used within an angle of 22.5 degrees and up to 10 meters from the device. When using the remote control, no obstacle should be placed between the remote control and remote sensor.

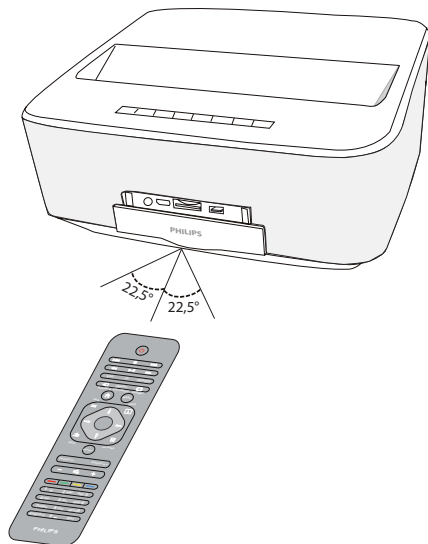



CAUTION!



















-  The improper use of batteries can lead to overheating, explosion, risk of fire and injury. Leaking batteries can possibly damage the remote control.
- Never expose the remote control to direct sunlight.
- Avoid deforming, dismantling or charging the batteries.
- Avoid exposure to open fire and water.
- Replace empty batteries immediately.
- Remove the battery from the remote control if not in use for long periods of time.

Initial Installation

- 1 Push the POWER  button for 5 seconds till the power indicator turns to red to turn the device on.
- 2 Turn the device towards a suitable projection surface or wall. Note that the distance to the projection surface must be a minimum of 0.1 meter and a maximum of 0.5 meter (see Setting up the Device, page 4). Make sure the projector is in a secure position.
- 3 Use the focus wheel on the front of the device to adjust the image sharpness.
- 4 The first time you turn on the device, you should set the following settings.

Notice

 During the first installation, use **OK** key to validate your choice and continue to the next step, and the  key to return on the previous step.

- 5 Use the keys / to select the language and confirm with **OK**.
- 6 Use the keys /// to select the symbol + or - to set the date (day, month and year) and confirm with **OK**.
- 7 Use the keys / to select the date format and confirm with **OK**.
- 8 Use the keys / to select the time zone and confirm with **OK**.
- 9 Use the keys /// to select the symbol + or - to set the date (hour and minute) and confirm with **OK**.
- 10 Use the keys / to select the time format (12h or 24h) and confirm with **OK**.
- 11 Use the keys / to select the location (Home or Shop) and confirm with **OK**.

Home: for normal use.

Shop: when you choose this option, the projector starts in demonstration mode. In this mode, the projector automatically displays the pictures or videos stored in the internal memory in loop.

Notice

 The demonstration mode can be activated or deactivated on the menu **Setting/Maintenance/Demo mode**.

- 12 A message is displayed to give the address web site where the user manual can be downloaded. Press **OK** to continue.

Turning off the projector

Press the  button on the panel control of the device or on the remote control more than 5 seconds.

ECO mode

Press shortly the  button on the panel control or on the remote control to put the device in ECO mode.







To wake up the device, press shortly again on the  button.

Setting up the Language

The device has already been installed. In order to change the menu language, proceed as follows:

- 1 Use the navigation keys to select **Settings**.



- 2 Confirm with **OK**.
- 3 Select **Language/ Language** with /.
- 4 Confirm with **OK**.
- 5 Select **Menu Language** with /.
- 6 Confirm with **OK**.
- 7 Select your desired language with /.
- 8 Confirm with **OK**.
- 9 Exit with .

4 Connect to the Playback Device

Supplied cables

HDMI cable

Connecting to Devices with HDMI Output

Use the HDMI cable to connect the projector to a computer, laptop or others devices.

Notice

 Use the HDMI socket 1 or 2 to connect the projector to a DVD player when a 3D signal is broadcasted.

- 1 Switch the device on using the on/off key.
- 2 Connect the cable to the projector's **HDMI** socket.

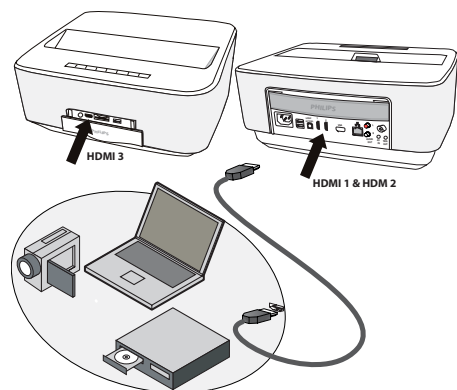

- 3 Connect the cable to the HDMI socket of the playback device.
- 4 From the main menu, select **HDMI 1, 2 or 3** depending on the external device is connected.

Connecting to a Computer (VGA)

Notice

 Many laptops do not activate the external video output automatically when you connect a second display such as a projector. Check your laptop's manual to find out how to activate the external video output.

Use the VGA cable (not included) to connect the projector to a computer, laptop, or some PDAs. The projector supports the following resolutions: VGA/SVGA/XGA. For best results, please check the best resolution.

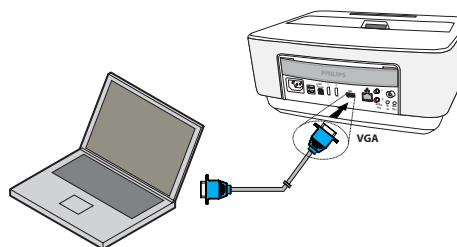

- 1 Switch the device on using the on/off key.
- 2 Connect the VGA cable to the projector's **VGA** socket.
- 3 Connect the VGA plug to the VGA socket of the computer.
- 4 Adjust the computer's resolution to the correct setting and switch the VGA signal to an external monitor. The following resolutions are supported:

	Resolution	Image refresh rate
VGA	640 x 480	60 Hz
SVGA	800 x 600	60 Hz
XGA	1024 x 768	60 Hz
WXGA	1280 x 768	60 Hz
FULL HD	1920 x 1080	60 Hz

Notice

 **Screen Resolution**
For best results, please check the best resolution.

- 5 From the main menu, select **VGA**.

Connecting Using an Audio/Video (CVBS) Adapter Cable

Use the projector's audio/video adapter cable (A/V cable) (not included) to connect camcorders, DVD players or digital cameras. The jacks for these devices are yellow (video), red (audio right) and white (audio left).

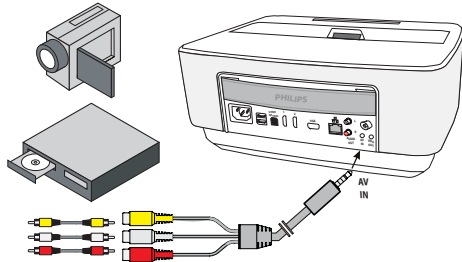

- 1 Connect the A/V adapter to the **AV** socket of the projector.
- 2 Connect the video device's audio/video sockets to the A/V cable using a conventional composite video (RCA) cable.
- 3 From the main menu, select **AV-in**.

Connecting to mobile multimedia devices

Some video devices (e.g.: pocket multimedia players, ...) require specific connection cables. There are either supplied with the device or acquired from the manufacturer of the multimedia device. Please note that only the original cables from the device manufacturer may function.

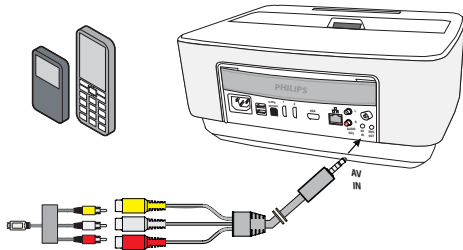

Notice

Switching to the Multimedia Device Signal Output

See the multimedia device instruction manual to find out how to switch the signal output to this jack.

Connecting to a home cinema amplifier

Use a S/PDIF optical cable (cable not provided) to connect the DIGITAL AUDIO output on the projector to the input of your home cinema amplifier.

For example, to show digital channels in DTS or DOLBY DIGITAL quality sound.

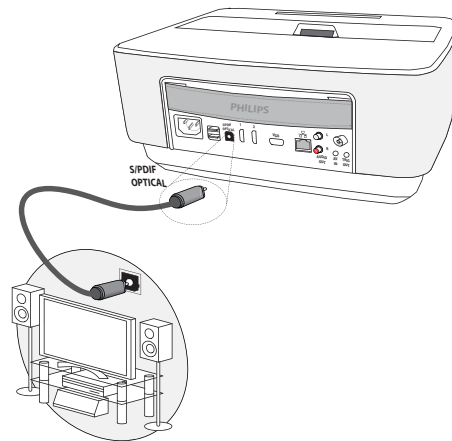

Connecting to a Hi-Fi unit

It is possible to use an analog audio connection, just connect the right and left audio outputs of the Projector to the auxiliary input of your Hi-Fi system (cable not provided).

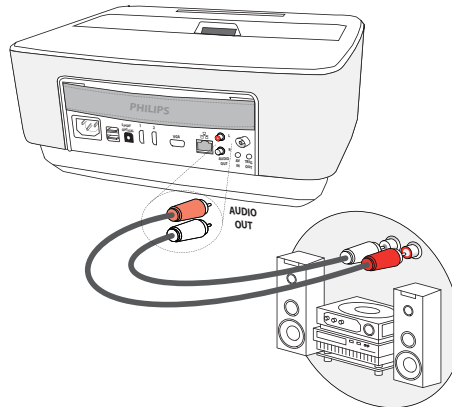

Connecting the headphones

- 1 Before connecting the headphones, turn down the volume on the device.
- 2 Connect the headphones to the projector's headphone slot. The device speakers deactivate automatically when the headphones are connected.

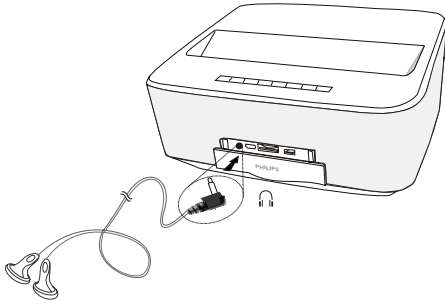

- 3 After connecting the headphones, increase the volume to a comfortable level.

DANGER!

 **Danger of Hearing Damage**

Do not use the device over a longer time at high volume – especially when using headphones. This could lead to the risks of hearing damage. Before connecting the headphones, turn down the volume on the device. After connecting the headphones, increase the volume to a comfortable level.

WiFiDisplay (Miracast)

Notice

-  Only the Miracast-certified devices can be used with this function.

- 1 Switch the device on using the on/off key.
- 2 After the initial screen the main menu appears.

Notice

-  The projector must be connected to a WiFi network.

- 3 Use the navigation keys to select **APPs**.
- 4 Confirm with **OK**.
- 5 Use the navigation keys to select **WifiDisplay**.
- 6 Confirm with **OK**.

Notice

-  The name used to identify the projector can be modified in the **Setting** menu.

- 7 Connect the external device (smartphone or tablet) to the same WiFi network that the projector.
- 8 Select on the WifiDisplay application of the external device the name of the projector connection (in the example **Screeneo_5f31**).
- 9 Connect the external device (smartphone or tablet) to the projector, it will show up **connecting**.
- 10 In the WifiDisplay application of the projector, it will show up the message **Invitation to connect, Decline or Accept**, select **Accept**.

5 Memory

Inserting a Memory Card

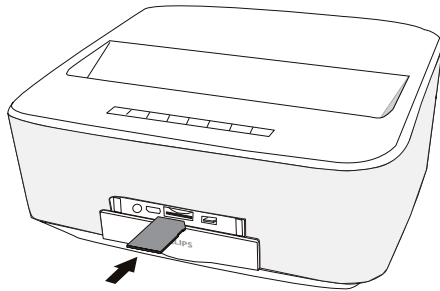

- 1 Insert a memory card with the contacts facing upwards into the **SD/MMC** slot at the back of the device. Your device supports the following memory cards: SD/SDHC/SDXC/MMC.
- 2 Insert the memory card into the slot until it snaps into position.

DANGER!



Inserting a Memory Card!

Never pull out the memory card while the device is accessing it. This could cause data to be damaged or lost.

Switch the device off in order to make sure that the device does not access the memory card.

- 3 Press lightly on the memory card to remove it.
- 4 The memory card is ejected.

Connecting USB Storage Medium

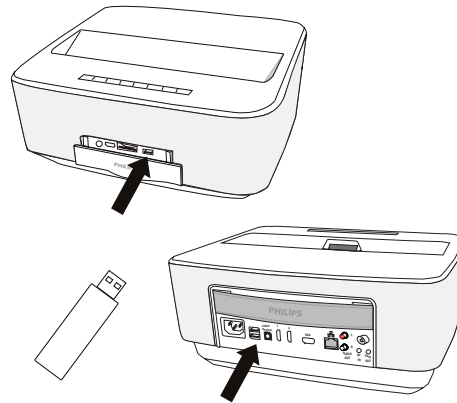

- 1 Connect the USB storage medium to one USB port of the device.

DANGER!



Inserting a Memory Card!

Never pull out the memory card while the device is accessing it. This could cause data to be damaged or lost.

Switch the device off in order to make sure that the device does not access the memory card.

6 Network

The projector can be connected to the network by a network hard-wired cable or through a wireless (Wi-Fi) connection.

Use the procedure below appropriate to the type of connection you want.

LAN Network

Notice



Connection!

The LAN connection takes priority over the Wi-Fi connection.

Connecting to the LAN network

- 1 Connect one end of a LAN cable (not supplied) to the ETHERNET port of your projector.

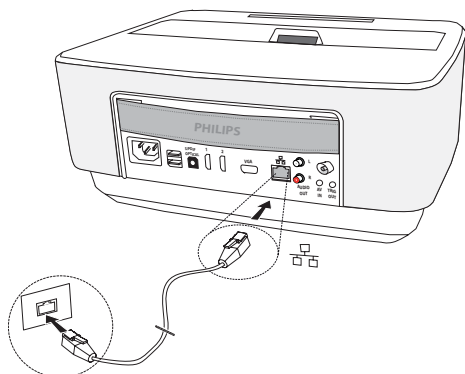

- 2 Connect the other end of the LAN cable to the network.
- 3 Configure the LAN network settings in manual or automatic configuration.

Automatic configuration

The automatic configuration of the local network settings may be considered, if your local network features a DHCP or BOOTP server that can dynamically assign addresses to the peripheral devices present on the LAN.

To automatically configure the local network settings:

- 1 Switch the device on using the on/off key.
- 2 After the initial screen, the main menu appears.
- 3 Use the navigation keys to select **Settings**.
- 4 Confirm with **OK**.
- 5 Using **▲/▼** select **Wireless and Networks**.
- 6 Confirm with **OK**.
- 7 Using **▲/▼** select **Lan**.

- 8 Confirm with **OK**.
- 9 Using **▲/▼** select **On**.
- 10 Confirm with **OK**.
- 11 Using **▲/▼** select **Advanced**.
- 12 Confirm with **OK**.
- 13 Using **▲/▼** select **Network address**.
- 14 Confirm with **OK**.
- 15 Check that **Automatic** is selected.

Manual configuration

To configure your projector manually, you should obtain the usual information used to set a peripheral device (IP address, sub-network mask, network and gateway address).

To configure the local network setting manually:

- 1 Switch the device on using the on/off key.
- 2 After the initial screen the main menu appears.
- 3 Use the navigation keys to select **Settings**.
- 4 Confirm with **OK**.
- 5 Using **▲/▼** select **Wireless and Networks**.
- 6 Confirm with **OK**.
- 7 Using **▲/▼** select **Lan**.
- 8 Confirm with **OK**.
- 9 Using **▲/▼** select **On**.
- 10 Confirm with **OK**.
- 11 Using **▲/▼** select **Advanced**.
- 12 Confirm with **OK**.
- 13 Using **▲/▼** select **Network address**.
- 14 Confirm with **OK**.
- 15 Using **▲/▼** select **Use static IP**.
- 16 Confirm with **OK**.
- 17 Enter the settings **IP-Address**, **Gateway**, **Net-mask**, **DNS1** and **DNS2**.
- 18 Confirm with **OK**.

Wireless Network (WLAN)

In a wireless network (Wireless Local Area Network, WLAN) at least two computers, printers or other additional devices communicate with each other over radio waves (high frequency waves). Data transmission in the radio network is based on the standards 802.11a, 802.11b, 802.11g and 802.11n.

DANGER!

 **Information on Using WLAN!**

The functioning of security systems, medical equipment or sensitive devices can be disrupted by the transmission power of the device. Observe any usage regulations (or restrictions) in the vicinity of such equipment.

The use of this device can affect the operation of insufficiently shielded medical devices and hearing aids and pacemakers through the release of high frequency radiation. Also consult a doctor or the manufacturer of the medical device to establish whether these are sufficiently shielded from external high frequency radiation.

Infrastructure Wireless Network

In an infrastructure network, multiple devices communicate via a central access point (gateway, router). All data are sent to the access point (gateway, router) and distributed from there.

Switching Wireless Networking (WLAN) on/off

Wireless networking is deactivated by default. You have the option of turning this function on.

- 1 Switch the device on using the on/off key.
- 2 After the initial screen the main menu appears.



- 3 Use the navigation keys to select **Settings**.
- 4 Confirm with **OK**.
- 5 Using **▲/▼** select **Wireless and Networks**.
- 6 Confirm with **OK**.
- 7 Using **▲/▼** select **WIFI**.
- 8 Confirm with **OK**.
- 9 Modify the settings with **▲/▼**.
- 10 Confirm with **OK**.

The **◀** key takes you one step back in the menu.

Setting up a Wireless Network (WLAN)

- 1 Switch the device on using the on/off key.
- 2 After the initial screen the main menu appears.



- 3 Use the navigation keys to select **Settings**.
- 4 Confirm with **OK**.
- 5 Using **▲/▼** select **Wireless and Networks**.
- 6 Confirm with **OK**.
- 7 Using **▲/▼** select **WIFI Selection**.
- 8 Confirm with **OK**.
- 9 Use **▲/▼** to select the desired wireless network.
- 10 Confirm with **OK**.
- 11 If your wireless network is password protected, an input window appears. Select the input field (see Navigation for setting menu, page 8) using the navigation keys of the remote control and press **OK**.
- 12 Enter the password with the virtual keyboard using the navigation keys of the remote control or with an external keyboard.
- 13 Click on **Connect**.

The **◀** key takes you one step back in the menu.

Setting up a Wireless Network (WLAN) using the Wizard

You can integrate your device very quickly and easily into an existing wireless network using Wi-Fi Protected Setup (WPS) or using a wireless network scan. Using WPS, all important settings like network name (SSID) are automatically configured and the connection protected with secure WPA Encryption.

Using Wi-Fi Protected Set-up (WPS)

Using Wi-Fi Protected Setup (WPS), you can integrate your device into an existing wireless network in two different ways very quickly and easily. You can activate the login with a pin code or using Push Button Configuration (PBC), if your access point (Access Point, Router) supports this method.

Using WPS with Push Button Configuration (PBC)

- 1 Switch the device on using the on/off key.
- 2 After the initial screen the main menu appears.



- 3 Use the navigation keys to select **Settings**.
- 4 Confirm with **OK**.
- 5 Using **▲/▼** select **Wireless and Networks**.
- 6 Confirm with **OK**.
- 7 Using **▲/▼** select **WiFi Selection**.
- 8 Confirm with **OK**.
- 9 Use **▲/▼** to select the desired wireless network..
- 10 Confirm with **OK**.
- 11 Activate Push Button Configuration on the WLAN access point. The WLAN access point and device connect automatically and create a WPA protected connection.

Wifi Hotspot

Notice



Important!

The projector can work as an access point, if only a wired lan network is installed in the location of use.

Use the portable Wi-Fi hotspot to share the device's network connection with computers or other devices through the Wi-Fi network.

Notice



Connection!

When the WiFi hotspot mode is activated, it takes priority over the other connections.

Activating WiFi hotspot

- 1 Switch the device on using the on/off key.
- 2 After the initial screen, the main menu appears.



- 3 Use the navigation keys to select **Settings**.
- 4 Confirm with **OK**.
- 5 Using **▲/▼** select **Wireless and Networks**.
- 6 Confirm with **OK**.
- 7 Using **▲/▼** select **WiFi Hotspot**.
- 8 Confirm with **OK**.
- 9 Using **▲/▼** select **Portable WiFi Hotspot**.
- 10 Confirm with **OK**.
- 11 Using **▲/▼** select **On**.
- 12 Confirm with **OK**.

The projector is now visible by other Wifi devices.

Setting up a WiFi hotspot

To modify the WiFi hotspot name and define the security level.

- 1 Switch the device on using the on/off key.
- 2 After the initial screen the main menu appears.
- 3 Use the navigation keys to select **Settings**.



- 4 Confirm with **OK**.
- 5 Using **▲/▼** select **Wireless and Networks**.
- 6 Confirm with **OK**.
- 7 Using **▲/▼** select **WiFi Hotspot**.
- 8 Confirm with **OK**.
- 9 Using **▲/▼** select **Setup WiFi hotspot**.
- 10 Confirm with **OK**.
- 11 To modify the settings, use **▲/▼** keys to select the desired parameter.

Item	Description
Network SSID	Name of the WiFi hotspot. This is the name used to identify your projector when it is detected by another WiFi device. To modify the name, select the field and press OK . With the keyboard, enter the new name.
Security	Select among the 3 levels of security. <ul style="list-style-type: none"> • Open (without security) • WPA PSK • WPA2 PSK
Password	Select the field and press OK . With the keyboard, enter the new password.
Show password	Check the box to display the password.

- 12 Using **▲/▼** select **Save**.
- 13 Confirm with **OK**.

Digital Living Network Alliance (DLNA)

This device supports Digital Living Network Alliance (DLNA). Using this standard you can quickly interconnect your multimedia devices.

Switching DLNA on and off

The DLNA function is switched on by default. You have the option of turning this function off.

- 1 Switch the device on using the on/off key.
- 2 After the initial screen the main menu appears.



- 3 Use the navigation keys to select **Settings**.
- 4 Confirm with **OK**.
- 5 Using **▲/▼** select **Wireless and Networks**.
- 6 Confirm with **OK**.
- 7 Using **▲/▼** select **DLNA Sharing**.
- 8 Confirm with **OK**.
- 9 Modify the settings with **▲/▼**.
- 10 Confirm with **OK**.

The **⏪** key takes you one step back in the menu.

Play Media Using DLNA

If DLNA enabled devices are located in the connected network, then you can access them in media playback and file management (see Media Playback, page 23).

DLNA Control

You can control the projector using another device (e.g. a smartphone) using DLNA. To do this, see the instruction manual for the device in question.

7 Bluetooth

Activating the Bluetooth connection

- 1 Switch the device on using the on/off key.
- 2 After the initial screen, the main menu appears.



- 3 Use the navigation keys to select **Settings**.
- 4 Confirm with **OK**.
- 5 Using **▲/▼** select **Wireless and Networks**.
- 6 Confirm with **OK**.
- 7 Using **▲/▼** select **Bluetooth**.
- 8 Confirm with **OK**.
- 9 Use **▲/▼** to select **on**.
- 10 Confirm with **OK**.

The projector is now visible for the near external Bluetooth devices.

Setting up Bluetooth parameters

- 1 Switch the device on using the on/off key.
- 2 After the initial screen, the main menu appears.



- 3 Use the navigation keys to select **Settings**.
- 4 Confirm with **OK**.
- 5 Using **▲/▼** select **Wireless and Networks**.
- 6 Confirm with **OK**.
- 7 Using **▲/▼** select **Bluetooth**.

- 8 Confirm with **OK**.
- 9 Using **▲/▼** select the desired setting.
- 10 Confirm with **OK**.
- 11 Modify the desired settings.

Menu	Description
Select device	The list shows all paired devices.
Paired device	To disconnect or unpair the paired device.

Bluetooth speaker

The projector can be used as Bluetooth speaker. In this mode, you can play music from smartphones or tablets.

The projector can only connect to, and play audio from one device at a time.

Activating Bluetooth speaker

Notice



Bluetooth speaker connection!

Depending on the model of your device, the bluetooth speaker can be activated from the main menu (BT Speaker icon) or from the **APPs** menu.

- 1 Switch the device on using the on/off key.
- 2 After the initial screen, the main menu appears.



- 3 Depending on model, use the navigation keys to select **BT Speaker** or **APPs>BT Speaker**.

Notice



Remote control

You can also use the **SOURCE** or **OPTIONS** key of the remote control.

Press the **SOURCE** key and select **BT Speaker** or press **OPTIONS** key then select **SOURCE** and **BT Speaker**.

- 4 Confirm with **OK**.

- 5 Press the **Red** key to power on the speaker.
- 6 Press the **Green** key to make the speaker discoverable during 60 seconds.
- 7 On your external device, activate the Bluetooth connection and select the speaker name from the list. When the device is connected, his name is displayed on the top of the screen.
- 8 Press the **Green** key to play music.
During music playback, the following actions are available:
Red key: To stop the connection.
Green key: To make a pause.
Yellow key: To play the previous music.
Blue key: To play the next music.

Changing the name of the Bluetooth speaker connection

This is the name used to identify your projector when it is detected by another Bluetooth® device.

- 1 Switch the device on using the on/off key.
- 2 After the initial screen, the main menu appears.



- 3 Depending on model, use the navigation keys to select **BT Speaker** or **APPs>BT Speaker**.
- 4 Press the **Yellow** key to rename the connection.
- 5 Use the keyboard to enter the new name.
- 6 Press **OK** to confirm.

8 Media Playback

Notice



Navigation Keys

All the keys shown are buttons on the remote control.

Notice



Best Settings for Optimal Use

Read the informations on the best settings in the chapter settings (see Settings, page 31) for optimal use of your device.

Navigating in the media Playback

To navigate in the memory media, use the following keys:

Keys	Action
▲ or ▼	To select folders or files in the displayed list.
▶ or OK	For directories, goes one level down. For files, starts the selected media file.
◀ or ↵	Goes one level up in the directory structure.
⏪	Exits to main screen.
Red key of the remote control	Allows to set the repeat mode for movie and music files: <ul style="list-style-type: none"> • : Play mode deactivate (greyed). • : Play only the selected movie in loop. • : Play all movies in the selected directory in loop. • : Play all movies in the media in loop.

Keys	Action
Green key of the remote control	Allows to set the slide show parameters for picture files. or Allows to set the shuffle mode for music files: <ul style="list-style-type: none"> • : Shuffle mode deactivate (greyed). • : Shuffle mode activate.
Yellow key of the remote control	Allows to display the pictures as miniatures or in a list.
Blue key of the remote control	Allows to delete the selected file.

In order to optimize the navigation, you can select a file type on the list:

- FOLDERS to view all files (photo, audio and video).
- MOVIES to view videos files only.
- PICTURES to view photo files only.
- MUSIC to view audio files only.

Video playback

Supported file formats

Supported file formats are *.avi, *.mov, *.mp4, *.mkv, *.flv, *.ts, *.m2ts, *.3gp.

Video Playback (USB/SD Card/Internal Memory/DLNA)

- 1 Switch the device on using the on/off key.
- 2 The main menu appears.



- 3 Use the navigation keys to select the desired media (USB, SD-card or DLNA):

Memory

Internal memory or SD card can be selected.

USB

- If only one USB key is connected the explorer shows only the content of the USB.

- If more than one USB memory is connected, select the desired USB memory first.

DLNA

The explorer searches for servers and shows them in a list. Select the desired DLNA server.

- 4 Confirm with **OK**.
The content of selected media is displayed.
- 5 To only display the movies content, select **Movie** using the keys (▲)/(▼) on the left of the screen.
- 6 Confirm with **OK**.

Notice



The use of color keys

The **Red** key allows to set the repeat mode:

- : Play mode deactivate (greyed).
- : Play only the selected movie in loop.
- : Play all movies in the selected directory in loop.
- : Play all movies in the media in loop.

The **Blue** key allows to delete the selected file.

- 7 Use (▲)/(▼) to select the video file that you wish to play.

Notice



Displaying Video Files

Only those videos that are compatible with the projector will be displayed.

- 8 Press **OK** or (▶) to start playback.
- 9 Press (◀) to end the slide show and return to the overview.
- 10 When you press (◀) again, you will return to the main menu.

Notice



Navigation During Playback

Review / forward: Press (◀◀)/(▶▶) on the remote control.

Press (⏸) to stop or continue playback.

During playback you can adjust the volume using the keys **-** / **+** on the remote control. Press or **-** repeatedly to shut off the volume completely.

Photo Playback

Supported file formats

Supported file formats are JPEG, BMP, PNG and GIF.

Photo Playback (USB/SD Card/Internal Memory/DLNA)

- 1 Switch the device on using the on/off key.
- 2 The main menu appears.



- 3 Use the navigation keys to select the desired media (USB, SD-card or DLNA):

SD-card

Internal memory or SD card can be selected!

USB

- If only one USB key is connected the explorer shows only the content of the USB.

- If more than one USB memory is connected, select the desired USB memory first.

DLNA

The explorer searches for servers and shows them in a list. Select the desired DLNA server.

- 4 Confirm with **OK**.
The content of selected media is displayed.

- To only display the picture content, select **Picture** using the keys / on the left of the screen and confirm with **OK**.

Notice



The use of color keys

The **Green** key allows to set the slide show parameters.

The **Yellow** key allows to display the pictures as miniatures or in a list.

The **Blue** key allows to delete the selected file.

- The list of photos are displayed on the screen as an overview.

Notice



Many Photos on the Memory Card or the USB Medium

If there are a lot of photos on the memory card or the USB storage medium it can take a moment before the overview appears.

- Use / or / to select the image that you want to start the slide show with.
- Press **Green** key to start the slide show.

Notice



The slide show can be started with the **OK** key if the parameters have already been set up.

- To modify the settings, use / keys to select the desired parameter.

Item	Description
Time per slide	To modify the photo display frequency. Off, 0, 2, 5, 10, 20, 30 and 60s
Repeat	Off, Directory or All
Slide transition	To modify the type of transition from one photo to another (random or by theme).
Slideshow order	Random or by order

- Press **Green** key to start the slide show.

- Press **OK** to pause the slide show.

- Press to end the slide show and return to the overview.

- When you press , you will return to the main menu.

Slide Show with Background Sound

- During the slide show, press **OK** to display the menu bar on the bottom of the screen.
- Using / select .
- Confirm with **OK**.
- Use / to select the file that you wish to play.

Notice



Storage Location

Only files from the internal memory/Memory Card/USB Storage Medium can be played.

- To start the background sound confirm with **OK**.
- Adjust the volume level with the volume keys on the remote control.
- If no input is made, the menu bar is hidden after 5 seconds.

Zoom and rotate functions

During the slide show, press **OK** key to display the contextual menu.

To perform a zoom, use the navigation keys to select



the symbol then press **OK**.

To rotate a picture, use the navigation keys to select the



symbol then press **OK** to rotate the picture 90° clockwise.

Press return to the slide show.

Music Playback

Notice



Switch off the Image Playback

You can switch off the screen while playing music in order to save power by a long press on the key.

Supported file formats

Supported file formats are MP3 and WAV.

Music Playback (USB/SD Card/Internal Memory/DLNA)

- 1 Switch the device on using the on/off key.
- 2 The main menu appears.



- 3 Use the navigation keys to select the desired media (USB, SD-card or DLNA):

SD-card

Internal memory or SD card can be selected!

USB

- If only one USB key is connected the explorer shows only the content of the USB.
- If more than one USB memory is connected, select the desired USB memory first.

DLNA

The explorer searches for servers and shows them in a list. Select the desired DLNA server.

- 4 Confirm with **OK**.
The content of selected media is displayed.

- 5 To only display the music content, select **Music** using the keys / on the left of the screen and confirm with **OK**.

Notice



The use of color keys

The **Red** key allows to set the repeat mode:

- : Play mode deactivate (greyed).
- : Play only the selected music in loop.
- : Play all musics in the selected directory in loop.
- : Play all musics in the media in loop.

The **Green** key allows to set the shuffle mode:

- : Shuffle mode deactivate (greyed).
- : Shuffle mode activate.

The **Blue** key allows to delete the selected file.

- 6 Use / to select the file that you wish to play.
- 7 Press **OK** to start playback.
- 8 Press to stop or continue playback.

Notice



Navigating when Image Playback is Switched off

Press / to skip to the previous or next song.

Press to stop or continue playback.

Press to return to the selection.

During playback you can adjust the volume using the keys / on the remote control. Press or repeatedly to shut off the volume completely.

Managing Files

Delete Files

You can delete files from the internal memory, the connected USB storage medium or the memory card.

- 1 Switch the device on using the on/off key.
- 2 The main menu appears.



- 3 Use the navigation keys to select the desired media (USB, Memory or DLNA).
- 4 Confirm with **OK**.
- 5 Use **▲/▼** to select the file that you want to delete.
- 6 Press the **Blue** key on the remote control to delete the file.
- 7 Confirm with **OK**.

Notice



Error

If errors occur during the deletion process, make sure that the storage medium is not write-protected.

9 Digital TV Playback (Depending on model)

Connecting the Aerial

Notice



Aerial Size and Orientation

In some regions it is necessary to connect a larger aerial in order to grant the reception.

In some countries it is necessary to point the aerial horizontally in order to grant the reception.

- 1 Connect the aerial to the aerial socket.

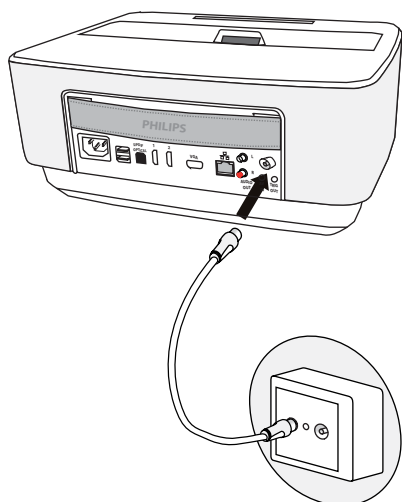

First Playback

Notice



Navigation Keys

All the keys shown are buttons on the remote control.

When the DVB-T function is first started, the automatic channel search must be started.

- 1 Switch the device on using the on/off key.
- 2 The main menu appears.



- 3 Connect the aerial (see Connecting the Aerial, page 28).
- 4 Use the navigation keys to select **TV**.
- 5 Confirm with **OK**.
- 6 Use **▲/▼** to highlight a setting and use the **◀/▶** to select a value.
 - Select the country.
 - Select the level of the parental control.
 - Enter the PIN code for channel lock or parental control. Enter the code with 4 digits (0000 is not accepted) and enter again the same code to confirm.
- 7 Press **OK** to confirm the settings and continue the installation.

The channel search starts automatically.
- 8 At the end of the search, press **OK**.

Your TV is now set. You can start watching and enjoying all your channels.

Television

Notice



Navigation Keys

All the keys shown are buttons on the remote control.

- 1 Switch the device on using the on/off key.
- 2 The main menu appears.



- 3 Use the navigation keys to select **TV**.
- 4 Confirm with **OK**.
- 5 The last viewed channel is played. Change the channel using keys **CH+/CH-**, **▲/▼** or enter directly the number with the keypad.

Notice



Displaying Channel Information

When changing channel, channel information is displayed on the bottom projection edge. The information bar is hidden after 5 seconds.

- 6 Press **⏻** to end playback and return to the main menu.

During playback you can adjust the volume using the keys **—/+** or **◀/▶** on the remote control.

Press **🔇** or **—** repeatedly to shut off the volume completely.

Modifying the DVB-T settings

To modify DVB-T settings, press the **Menu** key on the remote control. Main menus are:

Edit channels: To display and modify the channel and radio lists.

Installation: To launch an automatic or a manual search for channels.

System Setup: To modify the parental lock settings, the display settings and the favorite settings.

10 Android

Your projector uses the Android operating system.

Starting Android Apps

- 1 Switch the device on using the on/off key.
- 2 After the initial screen the main menu appears.



- 3 Use the navigation keys to select **APPs**.
- 4 Confirm with **OK**.

Exiting Android

Press the  key to return to the main menu.

Installing Android-Apps

CAUTION!

 **Trusted Sources!**
Apps from third party sources may be malicious. Only use installation packets from trusted sources.

You can install other apps. Use the APK installation packets, proceed as follows:

- 1 Download the package APK and save it onto a memory card or USB-stick.
- 2 Insert the memory card into the device (see Inserting a Memory Card, page 16).
- 3 Switch the device on using the on/off key.
- 4 After the initial screen the main menu appears.



- 5 Use the navigation keys to select **APPs**.
- 6 Confirm with **OK**.

- 7 Use the navigation keys to select **ApkInstaller**.
- 8 Confirm with **OK**.
- 9 Use the navigation keys to select **Install**.
- 10 Confirm with **OK**.
- 11 Navigate to the memory card and select the APK package you want to install.
- 12 Press **OK** to execute the installation package.
- 13 The APK package is installed.

11 Settings

- 1 Switch the device on using the on/off key.
- 2 After the initial screen the main menu appears.



- 3 Use the navigation keys to select **Settings**.
- 4 Confirm with **OK**.
- 5 Use **▲/▼** to select from the following settings.
- 6 Confirm with **OK**.
- 7 Modify the settings using **OK**, **▲/▼**,
- 8 Confirm with **OK**.

The **⏪** key takes you one step back in the menu.

Overview of the Menu Functions

Wireless and Network

WiFi – switching the wireless network (WLAN) off and on.

Network Selection – select the wireless network with which the device is to connect.

WiFi Hot Spot – activate and deactivate WLAN tethering.

LAN – switching the LAN network (LAN) off and on.

Advanced – (LAN mode only) check the Network actual IP address or change the address by inputting new address. You can also select **Automatic** or **Use static IP**

DLNA Sharing – switching DLNA off and on.

Bluetooth – switching the Bluetooth connection off and on.

Image settings

3D – set the picture modes with 2D/3D options.

Keystone – use **▲/▼** to set the keystone.

Fit Screen – use **▲/▼** to select the screen mode

Projection mode

Front – normal projection; the device is located in front of the projection surface/screen

Rear – rear projection; the device is located behind the projection surface; the image is reflected horizontally.

Front Ceiling – the device is hanging from the ceiling in an upside-down position; the image is rotated by 180 degrees.

Rear ceiling – the device is located behind the projection surface, hanging from the ceiling in an upside-down position; the image is rotated by 180 degrees and reflected horizontally.

Wall color correction – colour correction of the projected image to adjust to coloured projection surfaces

Smart Settings – select predefined settings for brightness / contrast / colour saturation. If you modify these settings, the setting is switched to **Manual**.

Brightness – use **▲/▼** to adjust the brightness and press **OK** to confirm.

Contrast – use **▲/▼** to adjust the contrast and press **OK** to confirm.

Advanced

Colour temperature – set to **Warm** to enhance hotter colors such as red, or set to **Cool** to make picture bluish.

Smart Brightness – use **▲/▼** to adjust the smart brightness and press **OK** to confirm.

Dynamic contrast – adjusts the contrast to keep it at the best level according to the brightness of the screen.

Color space – to convert the color space setting to another standard.

Gamma – adjusts the gamma correction according to the type of the projected image.

Sound Settings:

Volume – adjust the volume

Deep Bass – switching the deep bass on and off

Wide sound – switching the wide sound on and off

Equalizer – select the equalizer mode

Smart volume – turn on/off the volume level automatic control function

Key beep – turn key tones on and off

Speaker – switching the speaker on and off

System settings

Date and time – set date and time

Android Settings – set Android system

Sleep mode – With this function, the projector automatically goes to ECO mode after a specified period of time or at the end of a movie.

Auto Power Down – turn on/off the sleep mode. The default setting is off.

When the parameter is switched on, it works like this:

- If the projector is on, while no video is displayed (e.g. menu open without user action), it should go into off mode after the shortest possible time, by example 30 minutes.

- If a video is displayed, the APD should take place 3h after last user action, meaning that a pop-up will appear after 2h58 for 2 minutes, indicating that the product will go into off mode.

HDMI name – select this item to change the HDMI names. Name that appears on the main screen.

Language/Language

Menu language – use ▲/▼ to select the desired language and press **OK** to confirm.

Soundtrack – use ▲/▼ to select the desired language and press **OK** to confirm.

Sub Title – use ▲/▼ to select the desired language and press **OK** to confirm.

Maintenance

Reset settings – Reset settings to factory defaults.

Firmware Update – Update Firmware

Information – Display free space in the internal memory and information on the device (Capacity: / Free space: / Firmware version: / Device name: / Model:)

Demo mode – switching demo mode on and off.

12 Service

Cleaning

DANGER!

 **Instructions for Cleaning!**
Use a soft, lint-free cloth. Never use liquid or easily flammable cleansers (sprays, abrasives, polishes, alcohol, etc.). Do not allow any moisture to reach the interior of the device. Do not spray the device with any cleaning fluids.
Wipe over the surfaces gently. Be careful that you do not scratch the surfaces.

Cleaning the Lens

Use a brush or lens cleaning paper for cleaning the lens of the projector.

DANGER!

 **Do not use any Liquid Cleaning Agents**
Do not use any liquid cleaning agents for cleaning the lens, to avoid damaging the coating film on the lens.

Device Overheated

An overheat symbol appears if the device is overheated.

Update Firmware with Memory Card

- 1 Use SD memory card in the file system FAT16 or FAT32.

DANGER!

 **All Data will be Deleted!**
This procedure erases all your data that is stored on the memory card.

- 2 Save the latest firmware update file to the root of the memory card.
- 3 Insert the memory card (see Inserting a Memory Card, page 16) and switch the device on.
- 4 Use the navigation keys to select **Settings**.
- 5 Confirm with **OK**.
- 6 Use **▲/▼** to select **Maintenance**.
- 7 Confirm with **OK**.
- 8 Use **▲/▼** to select **Firmware Update**.
- 9 Confirm with **OK**.
- 10 Use **▲/▼** to select **Install**.
- 11 Confirm with **OK**.

- 12 The device turns off and on again. After around 5 minutes the **Language Selection** screen appears. The firmware update is now completed.

DANGER!

 **Inserting a Memory Card!**
Never pull out the memory card while the device is accessing it. This could cause data to be damaged or lost.

Notice



If an error occurs during the firmware update process retry the procedure or contact your dealer.

Troubleshooting

Power Cycling

If a problem occurs that cannot be corrected with the instructions in this user manual (see also the help below), follow the steps given here.

- 1 Switch the device off using the on/off key on the panel control.
- 2 Wait at least ten seconds.
- 3 Switch the device on using the on/off key on the panel control.
- 4 If the problem repeats, please contact our technical customer service or your retailer.

Problems	Solutions
The projector cannot be switched on	<ul style="list-style-type: none"> • Disconnect and Connect the power supply cable and try again.
The projector cannot be switched off	<ul style="list-style-type: none"> • Disconnect the power supply cable.
No sound	<ul style="list-style-type: none"> • check that the speaker is activated (Settings /Sound setting/Speaker). • Adjust the volume using the — / + key on the remote control.
No sound from the external connected device	<ul style="list-style-type: none"> • Check the cables to the external device • Set the volume on the external device • Only the original cables from the device manufacturer may function
No sound from DVB-T program or external HDMI output device.	<ul style="list-style-type: none"> • Set the audio setting to Multichannel (Raw data) & Stereo (PCM).
No sound when you connect your computer via HDMI cable	<ul style="list-style-type: none"> • Check that the sound is activated on the computer.
Video display problem when the source is a 3D signal from a DVD player.	<ul style="list-style-type: none"> • Check that the 3D mode is activated on the projector. • If the DVD player is connected to the projector via HDMI, only use the HDMI sockets (1 or 2) located on the rear of the device.
Only the initial screen appears and not the image from the external device	<ul style="list-style-type: none"> • Check if the cables are connected to the right sockets. • Please check that the external device is switched on • Check if the video output of the external device is switched on. • Check that the HDMI source selected on the user interface corresponds to HDMI connector where the external device is connected.
Only the initial screen appears and not the image from the connected computer	<ul style="list-style-type: none"> • Please check that the VGA-output of the computer is switched on. • Check if the resolution of the computer is set to 1280*800(for VGA connection) or 1080P(for HDMI connection).

Problems	Solutions
The device turns itself off	<ul style="list-style-type: none"> • When the device is running for a long period of time, the surface becomes hot and a warning symbol appears on the projection (see Symbols in the Status-bar, page 9). The device automatically turns off when it gets too hot. After the device has cooled down, you can continue playback. • Check that the power cable is connected correctly. • Check the sleep mode status in the setting menu (). When the sleep mode is activated, the device turns off after the programmed duration.
The device changes from maximum level of brightness to minimum level of brightness when the device is connected over USB to play videos.	<ul style="list-style-type: none"> • When the environment temperature is too high, the device turns automatically from maximum level of brightness to minimum level of brightness in order to protect the high power LED. • Use the device with lower environment temperatures.
The device cannot connect with an Android device (for example a mobile phone/smartphone with the Android operating system) when connected via USB.	<ul style="list-style-type: none"> • Deactivate the function „USB debugging“ in the settings menu of your Android device before connecting the Projector via USB; your Android device should be recognized as USB storage medium.
Bad image or color quality when connecting with HDMI	<ul style="list-style-type: none"> • Use the supplied HDMI cable. Third-party cables may cause signal distortions.
The device cannot read the SD card.	<ul style="list-style-type: none"> • Check that the memory card is compatible (see the list in the chapter Appendix).
The device cannot read the USB stick	<ul style="list-style-type: none"> • The device does not support the exFAT file system. • Format the USB key in FAT format, then use it.
The TV icon doesn't appear while the DVB-T module is installed.	<ul style="list-style-type: none"> • Call the hot-line.

13 Appendix

Technical Data

Dimensions (L×H×W)	287 × 148× 339 mm
Weight	5,3 kg
Recommended Ambient	5 – 35 °C
Relative Humidity	15 – 85 % (non-condensing)
File format	*.avi, *.mov, *.mp4, *.mkv, *.flv, *.ts, *.m2ts, *.3gp
Photo formats	JPEG, BMP, PNG, GIF
Music formats	MP3, WAV
Video Standard (CVBS)	PAL, SECAM, NTSC
Video connection	HDMI sockets
Internal speaker	mono 26 W
Internal memory	4 GB
Compatible Memory Cards	SD/SDHC/SDXC/MMC
USB connection max. power	5V, 500mA

Technology / optical

Display technology	WXGA 0.45" DLP
Light source	RGB LED
Native resolution	1280 x 800 Pixel (16:9)
Supported Resolutions	VGA/SVGA/WVGA XGA/WXGA/FULL HD
Projected image size (inch)	50 up to 100
Screen distance (mm)	108 up to 441
Display refresh rate	60Hz/50Hz/120Hz

Power supply

Input	100V-240V, 4.0 A, 50/60HZ
Power consumption	150W
Off mode power consumption	<0,5W
Manufacturer	JQH Group Co., Ltd.

Accessories

Following accessories are available for your device:
PVideo-(CVBS) cable.....PPA1320 / 253526178

All data are provided for reference purposes only.
Sagemcom Documents SAS reserves the right to make any changes without prior notice.



The CE marking certifies that the product meets the main requirements of the European Parliament and Council directives 1999/5/CE, 2006/95/CE, 2004/108/CE and 2009/125/CE on information technology equipment, regarding safety and health of users and regarding electromagnetic interference.

The declaration of compliance can be consulted on the site www.screeneo.com.

Preservation of the environment as part of a sustainable development plan is an essential concern of Sagemcom Documents SAS. The desire of Sagemcom Documents SAS is to operate systems observing the environment. The desire of Sagemcom Documents SAS is to operate systems observing the environment and consequently it has decided to integrate environmental performances in the life cycle of this products, from manufacturing to commissioning use and elimination.



Packaging: The presence of the logo (green dot) means that a contribution is paid to an approved national organisation to improve package recovery and recycling infrastructures. Please respect the sorting rules set up locally for this kind of waste.

Batteries: If your product contains batteries, they must be disposed of at an appropriate collection point.



Product: The crossed-out waste bin stuck on the product means that the product belongs to the family of electrical and electronic equipment. In this respect, the European regulations ask you to dispose of it selectively;

- At sales points in the event of the purchase of similar equipment.
- At the collection points made available to you locally (drop-off centre, selective collection, etc.).

In this way you can participate in the re-use and upgrading of Electrical and Electronic Equipment Waste, which can have an effect on the environment and human health.

The paper and cardboard packaging used can be disposed of as recyclable paper. Have the plastic wrapping recycled or dispose of it in the non-recyclable waste, depending on the requirements in your country.

Trademarks: The mentioned references in this manual are trademarks of the respective companies. The lack of the trademarks ® and ™ does not justify the assumption that these dedicated terminologies are free trademarks. Other product names used herein are for identification purposes only and may be trademarks of their respective owners. Sagemcom Documents SAS disclaims any and all rights in those marks.

Neither Sagemcom Documents SAS nor its affiliates shall be liable to the purchaser of this product or third parties for damages, losses, costs, or expenses incurred by the purchaser or third parties as a result of accident, misuse, or abuse of this product or unauthorized modifications, repairs, or alterations to this product, or failure to strictly comply with Sagemcom Documents SAS operating and maintenance instructions.

Sagemcom Documents SAS shall not be liable for any damages or problems arising from the use of any options or any consumable materials other than those designated as original Sagemcom Documents SAS / PHILIPS products or Sagemcom Documents SAS / PHILIPS approved products.

Sagemcom Documents SAS shall not be held liable for any damage resulting from electromagnetic interference that occurs from the use of any interface cables other than those designated as Sagemcom Documents SAS / PHILIPS products.

All rights reserved. No part of this publication may be reproduced, stored in a retrieval system or transmitted in any form or by any means, electronic, mechanical, photocopying, recording, or otherwise, without the prior written permission of Sagemcom Documents SAS. The information contained herein is designed only for use with this product. Sagemcom Documents SAS is not responsible for any use of this information as applied to other devices.

This user manual is a document that does not represent a contract.

Errors, printing errors and changes are reserved.

Copyright © 2013 Sagemcom Documents SAS



PHILIPS and the PHILIPS' Shield Emblem are registered trademarks of Koninklijke Philips N.V. and are used by Sagemcom Documents SAS under license from Koninklijke Philips N.V.

© 2013 Sagemcom Documents SAS

All rights reserved

Sagemcom Documents SAS

Documents Business Unit

Headquarters : 250, route de l'Empereur
92848 Rueil-Malmaison Cedex · FRANCE
Tel: +33 (0)1 57 61 10 00 · Fax: +33 (0)1 57 61 10 01
www.sagemcom.com
Simplified Joint Stock Company · Capital 8.479.978 € · 509 448 841 RCS Nanterre

HDP15x0 & HDP15x0TV
EN
253571339-B