

Operating Instructions

**RADARPILOT ATLAS 1000**  
**CHARTRADAR ATLAS 1000**  
**MULTIPILOT ATLAS 1000**

Software Version 2.4

**Radar Functions**  
**Plotting Aids**

This document is our property for which we reserve all rights, including those relating to patents or registered designs. It must not be reproduced or used otherwise or made available to any third party without our prior permission in writing.  
Alterations due to technical progress are reserved.

**STN ATLAS Marine Electronics GmbH**  
D - 22763 Hamburg

**Service**  
**Customer Support Center**

**Phone: + 49 (0) 18 03 00 85 53**  
**Fax: + 49 (0) 18 03 00 85 54**  
**E-mail: [shipservice@sam-electronics.de](mailto:shipservice@sam-electronics.de)**

**General Safety Precautions**

**Particular attention must be paid to the notes and warnings referring to possible faults in the radar display, since such faults can impair the detection of targets.**

The radar can perform its safety function if, and only if, the transmission power and the receiver sensitivity are adequate. Therefore, these characteristics must be checked regularly (by means of the Performance Monitor – see [Section 21](#)).

Connected position receivers must fulfil the standard IEC 61162-1 <sup>1)</sup>.

ARPA target data are directly dependent upon the accuracy and proper functioning of the selected speed sensor and the gyro compass.

**DANGER: High frequency radiation**



**Persons must definitely avoid being present in the radiation danger zone of the rotating antenna.**

**In the case of work being done on the antenna unit, the antenna switch situated there must be set to 0 and the transceiver must be disconnected from the ship's mains.**

There is no international agreement about the danger posed by high frequency radiation of the kind produced by the radar systems. In most countries, a radiation density exceeding 100 W/m<sup>2</sup> is considered to be dangerous; in some countries, values over 10 W/m<sup>2</sup> are regarded as not being completely safe.

Antenna Type	Transceiver A=Up B=Down	Radius of the Radiation Danger Zone	
		Radiation Density 100 W/m <sup>2</sup>	Radiation Density 10 W/m <sup>2</sup>
5 ft X-Band	12.5 kW, Version A	1.4 m	14 m
	25 kW, Version B	1.65 m	16 m
8 ft X-Band	12.5 kW, Version A	0.65 m	7 m
14 ft S-Band	30 kW, Version A	1.3 m	13 m
	30 kW, Version B	0.7 m	7.8 m

<sup>1)</sup> IEC 61162-1 largely corresponds to NMEA 0183 Version 2.30 of 1st March 1998.

**DANGER: Injury caused by a rotating antenna**

When the radar system is switched to "ON", it is possible that, instead of the expected antenna, a different one will begin to rotate. Therefore, it must be ensured beforehand that all antennas can rotate freely and that there are no persons near the antennas.

The units may be opened only by qualified, trained persons.

**DANGER: Dangerous voltage**

Even when the equipment is switched off, there can be a dangerous voltage present at exposed contacts in the units. Therefore, before a unit is opened, it must be ensured that the voltage supply to the unit is disconnected from the ship's mains, and that it remains disconnected.

Because of the capacitors contained in the units, there can be a dangerous voltage present in any unit even several minutes (or several hours in the case of monitors) after switching off and disconnection from the power supply.

☞ If the units are to be disconnected from the ship's mains, it must be remembered that each antenna unit, each transceiver electronics unit and each indicator normally has its own supply of power from the ship's mains.

If, for the transfer of signals (e.g. transfer of the heading signal from the compass system), synchro transmitter are used, a dangerous voltage exists in the units until the reference voltage is switched off.

---

## List of Contents

---

 Please pay attention to the supplement (if any) at the end of the document.

	<b>General Safety Precautions</b> .....	3
	<b>List of Contents</b> .....	5
<b>1</b>	<b>Overview</b> .....	9
1.1	<b>RADARPILOT ATLAS 1000</b> .....	9
1.2	<b>CHARTRADAR ATLAS 1000</b> .....	9
1.3	<b>MULTIPILOT ATLAS 1000</b> .....	10
1.4	<b>The Equipment Components</b> .....	10
1.5	<b>Scope of Applicability of these Operating Instructions</b> .....	11
<b>2</b>	<b>Basic Settings; General Remarks about Operating</b> .....	15
2.1	<b>Switching the Radar System On and Off</b> .....	15
2.2	<b>General Remarks about the Operating and Display Elements</b> .....	16
2.3	<b>Brilliance and Colour Selection</b> .....	21
2.4	<b>Degaussing</b> .....	23
2.5	<b>Display Modes</b> .....	24
2.6	<b>An Overview of the Screen</b> .....	25
2.7	<b>The Menu Structure</b> .....	26
2.8	<b>Activating/Deactivating of Slave Keyboards/Trackballs</b> .....	28
<b>3</b>	<b>PPI Settings</b> .....	29
3.1	<b>Screen Stabilisation of the PPI: True Motion, Relative Motion</b> .....	29
3.2	<b>PPI Orientation: Head-Up, North-Up, Course-Up</b> .....	30
3.3	<b>Centering / Off-Centering of the Display (Center, Off-Center)</b> .....	31
3.4	<b>Range Selection (Range)</b> .....	31
3.5	<b>Range Rings, Grid</b> .....	32
3.6	<b>Own Ship Symbols and Target Symbols, Vectors, Past Position Plots</b> .....	32
3.7	<b>Trails</b> .....	36
3.8	<b>Setting the Display of Pre-planned Tracks</b> .....	37
3.9	<b>Defining the System Track and the Next Waypoint; System Track Display</b> .....	39
3.10	<b>Setting the Display of User Chart Objects on the RADARPILOT</b> .....	41
3.11	<b>Setting the Display of Charts and User Chart Objects on the CHARTRADAR</b> .....	42
3.12	<b>Setting the Display of the Map</b> .....	45
3.13	<b>Adjusting the Chart or Map to the Radar Video</b> .....	46
<b>4</b>	<b>Setting the Radar Function</b> .....	47
4.1	<b>Radar Function On/Off, Interswitch Functions, Master/Slave Switch-Over</b> .....	47
4.2	<b>Basic Setting of the Radar Video</b> .....	49
4.3	<b>Selection of the Antenna Revolution Rate</b> .....	52
4.4	<b>Radar Setting for High Speed of Own Vessel (HSC)</b> .....	53

4.5	Radar Setting for the Display of RACON Codes .....	53
4.6	Radar Setting for SART Detection (X-Band only) .....	53
4.7	Suppression of the Synthetics and Video .....	53
<b>5</b>	<b>Heading, Speed, Position .....</b>	<b>57</b>
5.1	Compass .....	57
5.2	Speed Sensor .....	58
5.3	Position Sensor .....	60
<b>6</b>	<b>Bearing and Range .....</b>	<b>63</b>
6.1	Cursor Display .....	63
6.2	Variable Range Markers (VRM's) .....	63
6.3	Electronic Bearing Lines (EBL's) .....	64
6.4	Operating the VRM and the EBL Jointly .....	65
6.5	Parallel Index Lines .....	66
<b>7</b>	<b>ARPA Functions .....</b>	<b>67</b>
7.1	Symbols Used .....	67
7.2	Procedure of the Target Acquisition .....	68
7.3	Manual Target Acquisition .....	69
7.4	Automatic Target Acquisition; Settings of the Acquisition/Guard Zone .....	69
7.5	Deletion of Targets, Loss of Target .....	70
7.6	Target Data Display .....	70
7.7	Target Labels .....	72
7.8	Selecting the Reference Targets for Reference Target Tracking .....	73
<b>8</b>	<b>EPA Functions (Electronic Plotting Aid) .....</b>	<b>75</b>
8.1	Manual Target Acquisition and Semi-Automatic Plotting .....	75
8.2	Deletion of Targets .....	76
8.3	Target Data Display .....	76
8.4	Target Labels .....	76
<b>9</b>	<b>Collision Avoidance (TCPA, CPA) .....</b>	<b>77</b>
<b>10</b>	<b>Trial Manoeuvres .....</b>	<b>79</b>
10.1	General .....	79
10.2	Switch-On of the Trial Manoeuvre Display .....	79
10.3	Setting the Trial Manoeuvre in Relative Display Mode .....	80
10.4	Checking the Trial Manoeuvre in True Display Mode .....	82
10.5	Switching Off the Trial Manoeuvre Display .....	83
<b>11</b>	<b>Editing of Pre-planned Tracks .....</b>	<b>85</b>
11.1	Generating a New Pre-planned Track .....	86
11.2	Modifying an Existing Track .....	90
11.3	Generating a New Track on the Basis of an Existing Track .....	90

---

11.4	Managing the Pre-planned Tracks .....	91
12	Editing the Map .....	93
12.1	Preparing the Editing of the Map .....	93
12.2	Editing of Symbols .....	94
12.3	Editing of Lines .....	96
12.4	Ending the Editing of a Map .....	97
13	Displays in the Multidisplay .....	99
13.1	Docking Display .....	99
13.2	Zoom Display .....	100
13.3	Depth Display .....	102
13.4	Wind/Set+Drift Display .....	103
14	Quick Info Box .....	105
14.1	Contents of the Quick Info Box .....	105
14.2	Operating Procedure for the Stopwatch .....	106
14.3	Setting the Zone Time .....	106
15	Evaluation of the Radar Video .....	107
15.1	Achievable Radar Range .....	107
15.2	Distortions of the Radar Video .....	108
15.3	Undesirable Echo Displays and Effects .....	109
15.4	Sector Blanking .....	111
16	The Radar Keyboard .....	113
17	Alarm Management .....	117
18	List of Alarms .....	119
19	List of the Alarm Signal Outputs .....	127
20	Care and Maintenance Work .....	129
20.1	Care .....	129
20.2	Maintenance Work .....	129
21	Performance Monitor .....	131
22	System Maintenance Manager .....	133
22.1	Determining the Versions of Software, Hardware and Documentation .....	134
22.2	Listing the System Faults .....	134
22.3	Off-Line Selfcheck .....	136
22.4	Checking / Correcting the Computer Time .....	140
22.5	Distribution and Deletion of Map Data; Data Saving .....	141

---

22.6	Exchanging Track Files between the Indicators; Data Saving .....	143
22.7	The Handling of Diskettes .....	143
22.8	Aborting and Restarting the Program of the Radar System .....	144
	<b>Certificates</b> .....	145
	<b>Notes</b> .....	177



# 1 Overview

## Subjects of this Section:

- ◆ Brief overview of the parts of the system
- ◆ Optional parts and functions

The radar system can be configured in two main versions:

- the basic version, called RADARPILOT ATLAS 1000
- an expanded version, called CHARTRADAR ATLAS 1000 (or MULTIPILLOT ATLAS 1000, see [Section 1.3](#)) which, in addition, offers the possibility to display selected parts of the Electronic Chart on the radar screen in an alternative display mode.

Both versions are approved according to the published radar performance standards.

## 1.1 RADARPILOT ATLAS 1000

From the components of the RADARPILOT, it is possible to assemble radar sets and radar systems for all types of ship.

In a RADARPILOT System, the following components can be combined with each other in any desired manner:

- X-Band or S-Band transceiver and antenna
- Electronics Units with manual (EPA) or automatic (ARPA) plotting aids.
- 12" or 16" indicators
- Radar indicators as console versions or desk-top versions

The scope ranges from single systems to multiple systems consisting of five transceivers and five indicators.

Not only the system configuration but also the manner of use is extremely flexible: with just a few operating steps, each radar indicator can be switched to act as the master indicator of any desired transceiver or as a slave for any transceiver that is operating (interswitch function).

☞ On the master indicator, all functions of the radar can be operated, i.e. both on the transmitter side and on the receiver side. On the slave indicator, most functions on the reception side can be set independently of the master.

All radar sets are suitable for high speed craft (HSC's) too (if the antenna gearboxes are chosen appropriately), and on ships with normal speed they can be operated at twice the antenna rotation rate if this is required by the situation.

## 1.2 CHARTRADAR ATLAS 1000

The CHARTRADAR consists of the same components as those of the RADARPILOT, and also has all the characteristics of the RADARPILOT. In addition, it offers the possibility that the vector charts which exist in the CHARTPILOT can be displayed on the radar. <sup>1)</sup>

<sup>1)</sup> From the point of view of approval, the CHARTRADAR can be configured at service level in such a way that it fulfils the regulation IEC 60936-1, "Shipborne Radar" or the regulation IEC 60963-3, "Radar with Chart Functions". In the latter case, there are limitations in the display of the chart - see footnotes on [page 30](#) and [page 43](#).

The Electronic Charts are vector charts which are provided by a **CHARTPILOT** ATLAS 93xx via a data bus connection.

A CHARTPILOT is therefore necessary for operation of the CHARTRADARs, but is also used together with RADARPILOTs. CHARTPILOT and CHARTRADAR or RADARPILOT exchange a large quantity of data with each other, especially relating to the navigation sensors, the tracks, and the alarms that are generated by the ECDIS which is contained in the CHARTPILOT.

### 1.3 MULTIPILLOT ATLAS 1000

The MULTIPILLOT ATLAS 1000 has a different Electronics Unit. There, it can be specified at service level whether the MULTIPILLOT is to perform the functions of the CHARTRADAR or those of the CHARTPILOT <sup>1)</sup>.

In the first case, the MULTIPILLOT ATLAS 1000 does not differ from the CHARTRADAR as far as the operating procedure and the functions are concerned. All statements made about the CHARTRADAR in these Operating Instructions are also applicable to the MULTIPILLOT ATLAS 1000.

In the second case, the MULTIPILLOT ATLAS 1000 does not differ from the CHARTPILOT ATLAS 9330 as far as the operating procedure and the functions are concerned - see Operating Instructions ED 3032 G 232.

### 1.4 The Equipment Components

The radar systems (RADARPILOT and CHARTRADAR) consist of two segments which are connected to one another via bus systems (CAN Bus) etc. These segments are the radar indicator and the transceiver/antenna.

The **radar indicator** is the central operating and display unit. It consists of

- the **monitor**, with a high-resolution 21" colour screen for the 12" radar or a 29" colour screen for the 16" radar,
- the **trackball**, with which all operating inputs can be made,
- the **radar keyboard**, with which operating steps that are frequently used can be carried out particularly conveniently by means of function keys and rotary knobs,
- the **diskette drive**, which permits very easy servicing and makes it possible to save data and to exchange data with radar systems installed on other ships, and
- the **display electronics unit**, the heart of which consists of a high-performance computer which also performs the communication with the display electronics units of the other radar sets installed. In addition, the interface adaptation for navigation sensors having NMEA interfaces takes place here.
- On the **radar interconnection box**, all ship's cables leading to the radar indicator are connected. If necessary, special Interface electronics is also accommodated here.

The parts of the radar indicator are usually integrated within a **console**. However, they can also be assembled as a **desk-top version** without integrating the display electronics and the interconnection box. The display electronics unit is then installed together with the radar interconnection box to form a single unit.

<sup>1)</sup> In a future version, this selection will be made by means of the normal operating procedure.

In addition,

- **slave monitors** can be installed, which repeat the display shown by the indicator to which they are connected.
- **slave keyboards** or **slave trackballs** can be installed. Each slave keyboard or slave trackball is assigned to a slave monitor. For each slave keyboard/trackball, there is an electronics unit called a keyboard switch which, by means of a single operating step, makes it possible to assign the operating functions to a slave keyboard (trackball) / slave monitor pair.
- a **video buffer** is used, if there is more than one slave monitor connected to an indicator.

The RF components are

- the **transceiver (electronics unit)**, which contains the X-Band transceiver or the S-Band transceiver (transceiver version B = bulkhead), and
- the **antenna (unit)**, consisting of
- the **antenna gearbox** (X-Band or S-Band) and
- the **scanner** (5 ft X-Band or 8 ft X-Band scanner or 14 ft S-Band scanner).

The transceiver can also be accommodated in the antenna gearbox, so that there is no need for a separate transceiver electronics unit (transceiver version A = antenna/mast ahead).

In addition, a unit called

- the **Interface Expander** may be present. When there are more than two radar indicators or more than two transceivers installed, the switch-over between the indicators and transceivers is performed by the **Interswitch** installed in the Interface Expander. If additional interfaces or interfaces having a non-standardised format have to be implemented, the electronics which is additionally installed in the Interface Expander performs the necessary interfacing and data distribution.

Examples of various equipment configurations are given in the following illustrations.

- ☞ The **TVA**<sup>1)</sup> signals entered there are the combined reception signals of the transceivers. In the indicators, these signals are used to generate the radar video signal, as well as the trigger signals and antenna signals.

## 1.5 Scope of Applicability of these Operating Instructions

These operating instructions cover all of the above-mentioned variants of the RADARPILOT and CHARTRADAR equipment and systems. It refers to RADARPILOT ATLAS 1000 and CHARTRADAR ATLAS 1000 systems which are approved under the software version stated on the title page.<sup>2)</sup>

- ☞ Unless the RADARPILOT or CHARTRADAR or MULTIPLOT is mentioned specifically, all statements made in these Operating Instructions apply to these types of equipment.

1) **TVA** = Trigger, Video, Azimuth

2) On [page 134](#), there is a description of how the software version of the radar system can be displayed.

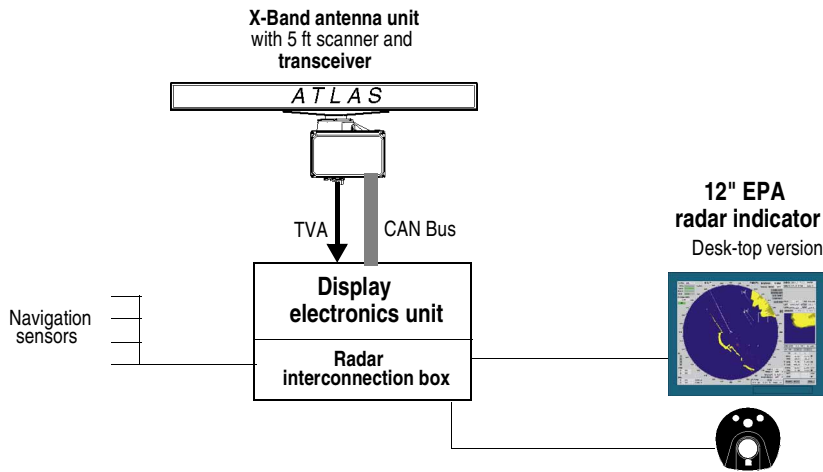

Example of a single installation with minimum scope

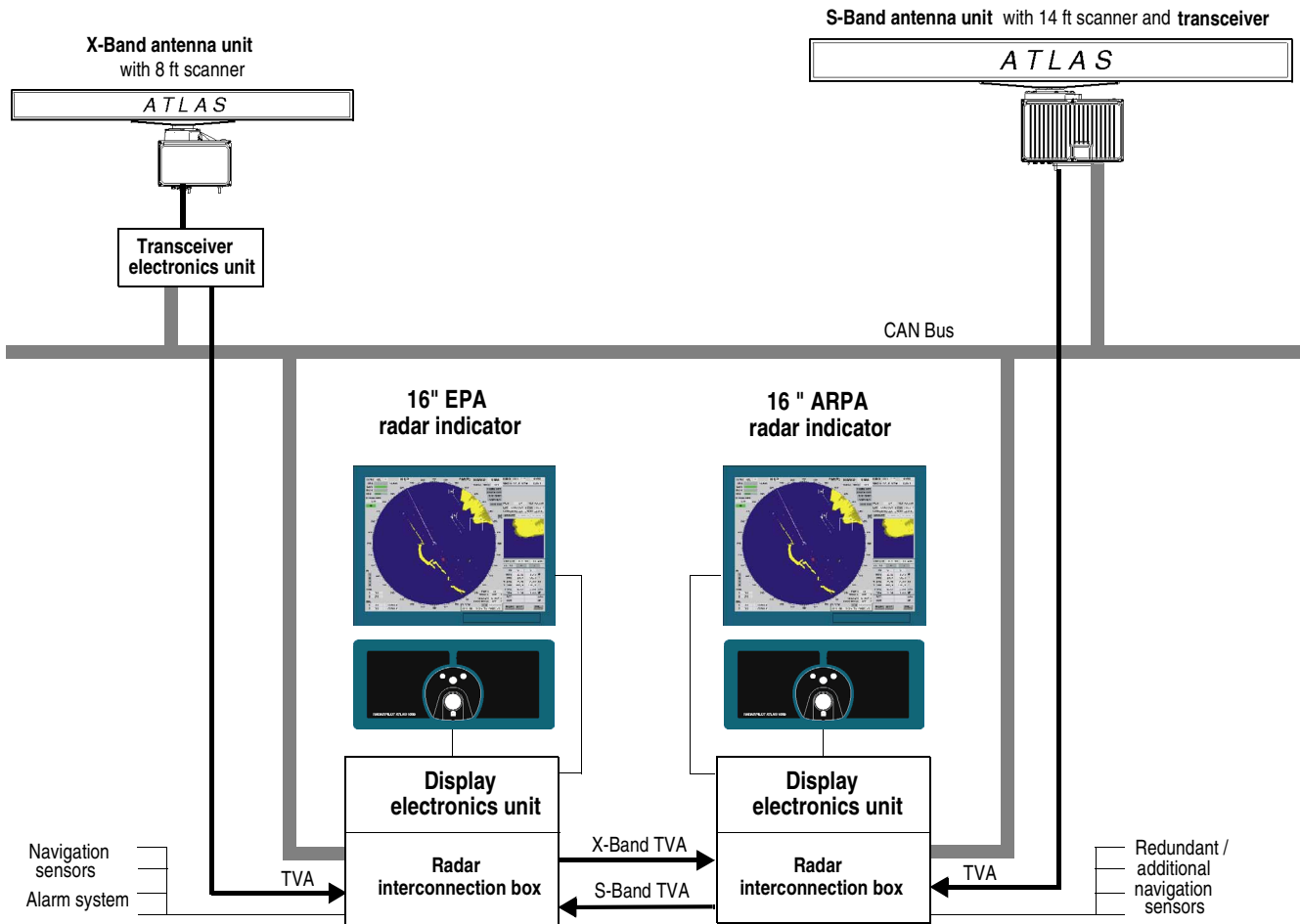

A typical dual installation (IMO pair)

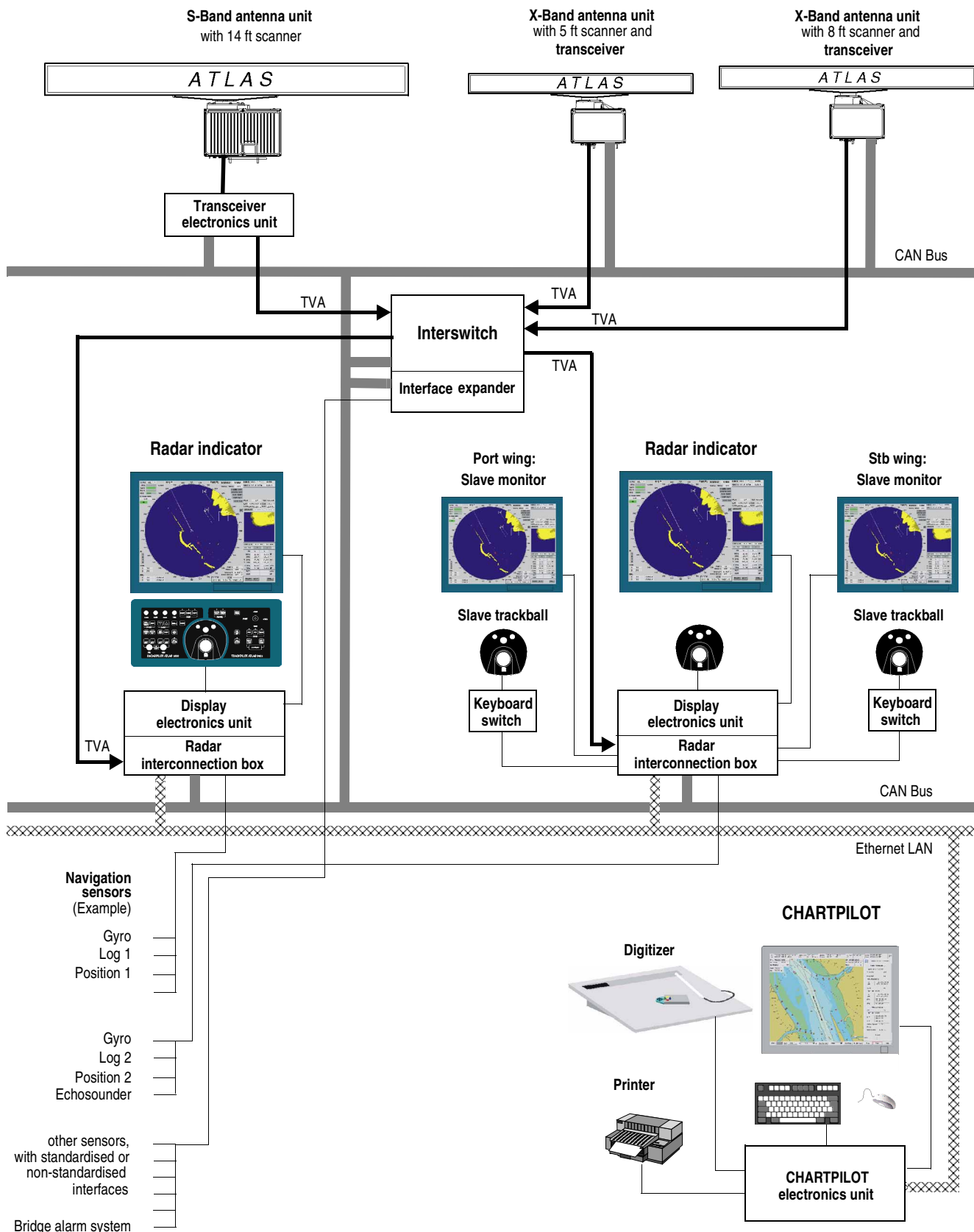

**Radar system and CHARTPILOT**



## 2 Basic Settings; General Remarks about Operating

### Subjects of this Section:

- ◆ Switching the radar system on and off
- ◆ General remarks about the operating and display elements
- ◆ The trackball and its keys
- ◆ General remarks about menus
- ◆ The input of numerical values and text
- ◆ Brilliance and colour settings, degaussing
- ◆ Display modes
- ◆ Overview of the screen
- ◆ The menu structure

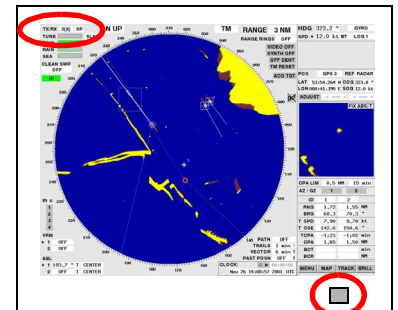

### 2.1 Switching the Radar System On and Off

**Switching the radar system ON** is done by means of one of the **ON/OFF** switches or **POWER** buttons situated on the radar indicators. When this is done, all indicators and transceivers are switched on. <sup>1)</sup> and

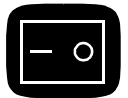

After the warm-up phase of the magnetron - 3 minutes for X-Band and 3.5 minutes for S-Band - stand-by operation is achieved and the radar function can be switched on; see [page 47](#).

- ☞ The act of switching an indicator on never causes a transceiver to be switched directly into radar Mode.
- ☞ If an attempt to switch over to radar operation occurs before stand-by operation is achieved, the indication **WARM UP** appears instead of the list of transceivers.

**Switching the radar system OFF:** Switch off all indicators by means of the **ON/OFF** switch <sup>2)</sup>. As long as there is one of the switches in the ON state, all electronics units of the indicators and transceivers remain switched on and.

#### Stand-By Operation

The main difference between stand-by operation and radar operation is that, during stand-by operation, the transceiver is not transmitting and the antenna is not rotating. Therefore, the radar video is absent on the PPI, and none of the functions that depend on the transceiver can be operated yet.

During stand-by operation, the magnetron is kept at its operational temperature.

<sup>1)</sup> If an display electronics unit is exposed to very low temperatures (around -15°C or less), it can happen that its computer does not start up. The screen of the associated monitor then remains dark, or becomes dark after a short time. In this case, the radar system must remain switched on for about 30 minutes (in spite of the dark screen) so that the display electronics units will warm up. If the radar system is then switched off and is switched on again after a waiting time of a few seconds, the computer will start up in the normal way.

<sup>2)</sup> If a indicator has a **POWER** key, that indicator is switched off by prolonged pressing of this key.

## 2.2 General Remarks about the Operating and Display Elements

On the indicators of the radar system, many screen display fields also act as switching areas or input fields which can be operated quickly and intuitively by means of the trackball and cursor.

With these few elements, the entire radar system can be operated from the radar indicator with the aid of its trackball. In addition, the optional radar keyboard contains function keys and rotary knobs for direct access to some functions that are needed frequently.

 The description of the operating procedure in these Operating Instructions normally refers to the trackball and cursor. In [Section 16](#), the operating procedure using the optional radar keyboard is summarised.

### Trackball and Cursor

 If you are already familiar with graphic man-machine interfaces, you might be able to skip this section. Before doing so, you should have a look at the picture of the trackball beside this text.

Every operating step begins with the operator moving the cursor by means of the trackball to a particular place on the screen (to a text item, a numerical value, a symbol on the PPI or any desired place on the PPI). The next step is always the pressing of one of the trackball keys. In the following, this brief pressing of the key is called **clicking**. What then happens depends on the key used, the element on which clicking took place, and the operating situation, and is the subject of these operating instructions.

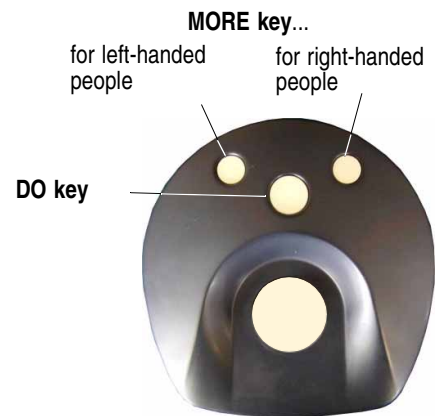

The **cursor** has a **resting position** to which it goes 30 seconds after the last operating process. This position is situated beside the PPI, below the **ACQ TGT** area.

If the cursor is situated outside the PPI, it is shaped like a hand or an arrow. Inside the PPI, it is a set of crosswires.

The trackball has three keys with two different functions:

#### DO Key

The most important key is the middle (bigger) one. Almost all data areas react to this key, which performs the functions that are needed the most frequently. In these operating instructions, it is called the "DO key". In the following, "clicking" always means clicking with the DO key unless stated otherwise.

#### MORE Keys

The two keys situated above the DO key are called "MORE keys" in these operating instructions. They have identical functions <sup>1)</sup> which are not needed as frequently. Not all elements which can be operated by means of the DO key react to the MORE key also, and if they do, then always with functions other than those of the DO key. Furthermore, by pressing of the MORE key, open menus (for menus, see below) can generally be closed without any results, and inputs can be aborted.

#### Data Areas

Some data areas are used only to display numerical values, names or stati.

Example: Target data display

In the case of most data areas, the operating procedure for the functions displayed there is likewise performed by clicking on the data area.

<sup>1)</sup> There are two "MORE" keys so that both left-handed people and right-handed people can operate them ergonomically. Their functions are identical.



Examples:

- Two switch Acquisition/Guard Zone 1 on and off, all that you need to do is to click on the **AK / GZ1** button <sup>1)</sup>.
- If the transfer of the course is to be synchronised, click on the currently existing heading value. A numeric keyboard is then displayed. Input the correct value by means of that keyboard.

And so on.

Basically, the following is true:

**Coloured data areas** indicate the activated state.

In the case of functions which only have an "on" state and an "off" state, the "on" state is indicated by a coloured background. Example: **IR** on a grey background means that Interference Rejection is not switched on; **IR** on a coloured background means that it is switched on.

Areas that are flashing in colour signify that the corresponding function (e.g. ACQ TGT, ADJUST etc.) can be executed.

**Sensitive and Insensitive Data Areas**

Data areas that can be operated can be insensitive in particular operational states, i.e. they cannot be operated. For example, after clicking on the **TUNE** area, tuning can be performed on the master indicator, but not on a unit switched to act as a slave indicator. On the slave indicator, the **TUNE** area is displayed as being insensitive.

☞ Insensitive data area can be recognised from their low-contrast lettering or colouring.

Before pressing of the DO or MORE key, sensitive data areas can be recognised from **the black border** which indicates the boundary of the sensitive area as soon as the cursor is situated in this region. Furthermore, the shape of the cursor changes to that of a hand.

**Operating Procedure for the Context Menus**

Particular data areas react to clicking by presenting a list of further possibilities - the "context menu", as it is called. If clicking takes place on one of the buttons contained in the context menu, the corresponding change in the function takes place and the context menu disappears. In some cases, a further menu is opened. By clicking on the background area, the context menu can be switched off without any change of function.

☞ 30 seconds after the last operating process, the context menu switches off automatically.

**The Function of the Menu Buttons**

Clicking on the buttons **MENU** to **BRILL** situated at bottom right opens menus in which basic settings can be made and which contain other functions that are not needed very often. Most of these menus contain several levels, i.e. from the menu that has been called up, a submenu can be called up, and so on. The higher levels are listed in the menu header. There, you can return to the higher level by clicking. Clicking on the highest level or on the menu button having the same name closes the menu.

☞ 30 seconds after the last operating process on the menu, it switches itself off automatically.

☞ The complete structure of the menu system is shown in [Section 2.7](#).

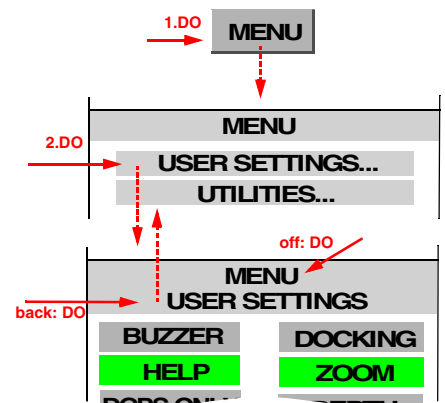

1) Data areas which produce an effect as a result of clicking are also called **buttons** in the following.

### The hidden OTHER button

To switch over the content of entire areas of the screen, e.g. the area containing the Multidisplay or the radar target data, the **OTHER** button is used; this button is not continuously visible.

The **OTHER** button appears in miniaturised form in the top left-hand corner of the display as soon as the cursor is situated in the relevant display. It appears in normal form as soon as the cursor is situated in the area of the normal display of the **OTHER** button. By clicking of this button, a context menu with the possible display-settings opens up.

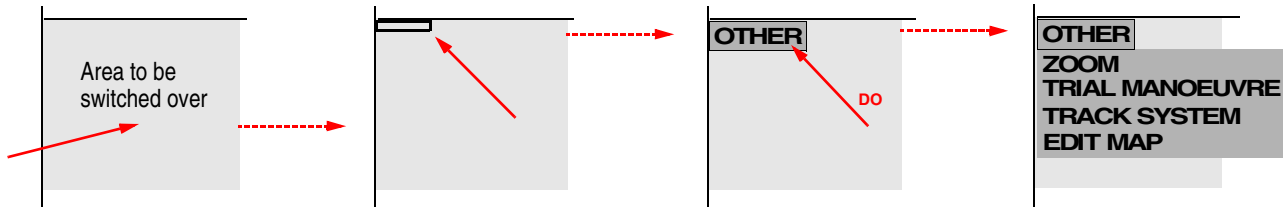

### Input of Numerical Values

In some areas, numerical values can be entered. This is done with the aid of a virtual keyboard which appears on the screen as soon as clicking is performed on an area of this kind. With the MORE key, the input can be aborted without any change occurring.

It is possible to choose between the input of a new value and the changing of the existing value. An exception to this rule is the input of geographical coordinates, for which different algorithms are applicable.

### Entering of a New Value

1. Click on the numerical area; a virtual input-keyboard is opened.
2. Click **numerals** one after another. They appear in the display area of the keyboard.

☞ Before the decimal places, click on the **point** button, unless the point is entered automatically.

☞ Signs, e.g. for the time zone, can be entered by means of the button .

☞ With the button , the character situated on the right in the display area can be deleted.

3. By clicking on the **OK** button, the value displayed is taken over and the keyboard disappears.

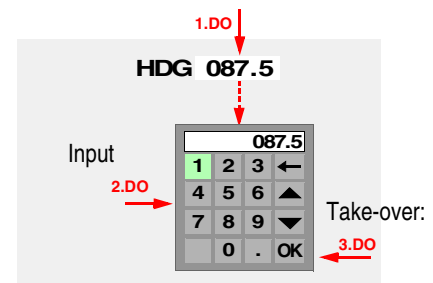

### Changing of an Existing Value

1. Click on the numerical area; a virtual input-keyboard is opened.
2. With the first pressing of the or button, the value which exists at that time appears in the display area of the keyboard.

As long as the button of the virtual keyboard is kept pressed (with the DO key), the existing value increases. As long as the button is kept pressed, it decreases.

3. By means of the **OK** button, the keyboard is made to disappear and the value entered is taken over.

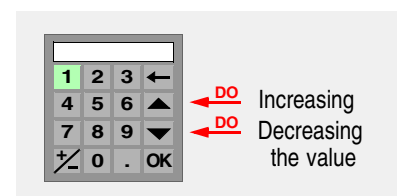

**Input of Geographical Coordinates**

1. Click on the numerical area; a virtual input-keyboard is opened.

Here, the existing value appears on the display area of the keyboard. Instead of the ▲ and ▼ buttons, the keyboard has the buttons needed for the input of the relevant hemisphere.

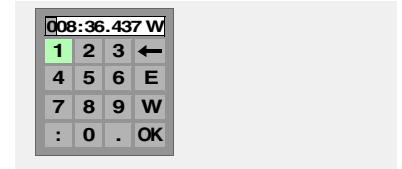

2. By the input of **numerals**, the existing value is overwritten, beginning at the most significant figure.
3. With the "point" button, you go from the "degrees" part to the "minutes" part, from there to the "thousandths of a minute" part, and from there to the W/E, N/S input part.
4. By clicking on the **OK** button, the value displayed is taken over and the keyboard disappears.

**Input of Texts**

In some fields, a text line consisting of large and small letters, numerals and punctuation marks can be entered.

The process corresponds to new input of numbers - see above.

The virtual keyboard which appears after the clicking of these fields is similar to the usual (English) computer keyboard:

- By means of the **Caps** button, a switch-over between large and small letters takes place.
- By means of the **Shift** button, all characters are switched over.
- By means of the ← button, the character situated on the right in the display field is deleted.
- The input is completed by clicking on the **OK** button.

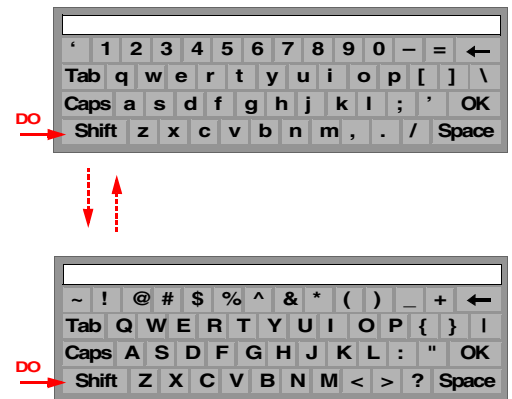

**Help Function**

As soon as the cursor is situated on an area that can be operated, the function of the DO key and (if applicable) the function of the MORE key are displayed in the Quick Info Box at the bottom of the picture if the Help function is switched on.



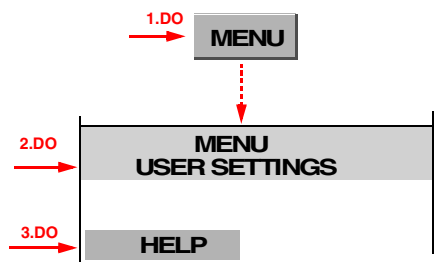

**Switching the Help Function On and Off**

Click on the MENU button, and then, in the **USER SETTINGS** menu, click the **HELP** button.



### Operating Procedure for the Lists

Lists are used for selection and display of the elements contained in them. Marking of a list element is done by clicking.

If the list contains more entries than can be simultaneously displayed, it can be scrolled line-by-line by means of the  and  buttons and from page to page by means of the  and  buttons, or by clicking below or above the scroll bar. Alternatively, click on the scroll bar and scroll by means of the trackball.

Lists often indicate the files which are contained in a catalog. For example, the list shown here indicates the files of tracks which are contained in the catalog ATLANTIC. Other catalogs too can exist. By clicking on the  button, the higher level is displayed, i.e. in this example the list of the catalogs.

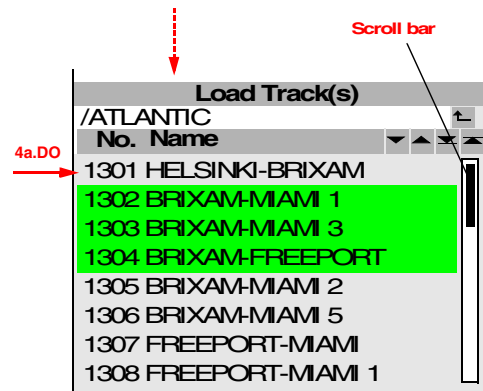

 Many lists also have a **search function**: If you click into the input field (at the top of the list), the virtual keyboard which then opens up enables you to enter the number or the beginning of the name of the list entry that is being searched for. If you click on **ENTER**, the list jumps to the entry that is being searched for.



### Special Features of the Lists of the System Maintenance Manager

The System Maintenance Manager, a subroutine which was created for maintenance purposes and which the operator too needs from time to time (see [page 133](#)), uses a different form of list which is similar to that of other operating systems. Important special features are:

Catalogs and files of the various levels are contained in one and the same display.

Catalogs are designated by the symbol  or , and files by the symbol .

A minus sign in the square in front of the catalog symbol shows that the catalog content is displayed. Clicking on a square with a plus sign causes display of the catalog content.

 At the top of the list, the character "/" stands for the root (the basic list). Marking of this entry selects the sum of all catalogs and files that are present in the list.

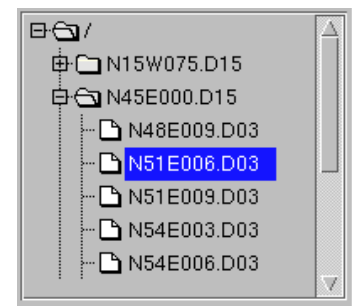

## 2.3 Brilliance and Colour Selection

For the approximate but usually adequate adaptation of the screen brilliance to suit the brightness of the surroundings, there is a choice between 6 colour palettes.

Fine adjustment of the overall brilliance and of the contrast is possible. Furthermore, the brilliance of the PPI element groups can be adjusted individually.

### Selecting the Brilliance and the Colour Palette

Click on the **BRILL** button.

- By clicking on the **DAY** button, the medium daytime colour palette **NORMAL DAY** is switched on. <sup>1)</sup>
- By clicking on the **NIGHT** button, the medium night-time colour palette **NORMAL NIGHT** is switched on.
- To switch on the other daylight colour palettes, click on the **DAY** button with the MORE key and select the desired palette.
- To switch on the other night-time colour palettes, click on the **NIGHT** button with the MORE key and select the palette.

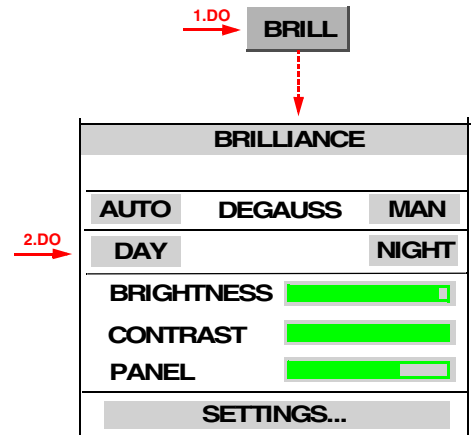

### Displaying Areas of the Electronic Chart in Grey Shades (on the CHARTRADAR only)

On the CHARTRADAR, the **BRILLIANCE** menu in Chart Display Mode additionally contains the **GREY MODE** button. If this function is switched on, the areas of the Electronic Chart are displayed not in colour but in grey shades. In this type of display, the coloured radar video and symbols are visually easier to distinguish from the background.

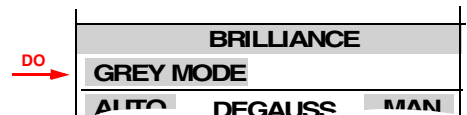

### How to Brighten a Very Dark Screen

If the screen is set very dark in a very bright environment, it might no longer be possible to recognise anything on the screen. Thus, the brilliance can no longer be increased in the manner described. A way out of this "trap" is offered by a brilliance increase by means of the DO and MORE keys:

Press the DO key and a MORE key; with the second MORE key, make the screen brighter step by step.

### Fine Adjustment of the Monitor Brightness and Contrast

These adjustments are performed by means of the brightness and contrast knobs of the monitor. On monitors which do not have these operating elements, the adjustments are performed as follows <sup>2)</sup>:

1. Click on the **BRILL** button.
2. Click on the **BRIGHTNESS** area or on the **CONTRAST** area.
3. Perform the desired adjustment with the trackball.
4. Press the DO key.

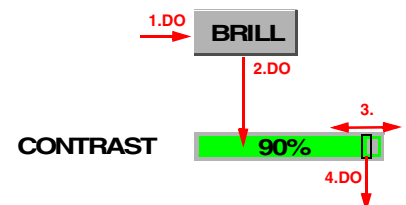

<sup>1)</sup> All colour information in these operating instructions refers to the average colour palette for daytime, namely **NORMAL DAY**.

<sup>2)</sup> Monitors are also used, which only have a brightness control and no contrast control.

### Setting the Brilliance of Individual Elements

1. Click on the **BRILL** button.
2. Click on the **SETTINGS** button.
3. Now, by means of the procedures already described, the following items can be set:
  - After clicking on the **LAMPS** area: the brilliance of the lamps on the keyboard.
  - After clicking on the **DATA** area: the brilliance of the whole area outside the PPI.
  - After clicking on the **SCALE** area: the brilliance of the compass scale.
  - After clicking on the **VIDEO** area: the brilliance of the radar video.
  - After clicking on the **SYMBOLS** area: the brilliance of the target synthetics and of the own ship symbol.
  - After clicking on the **MARKER** area: the brilliance of the cursor, heading line, stern line, EBL's, VRM's and range rings.
  - After clicking on the **MAP** (or **MAP / CHART**) area: the brilliance of the map (or chart), tracks and guard zones.

These settings can independently be made for each colour palette.

### Setting the Optional Illumination of the Optional Keyboard

Setting is performed in the **BRILLIANCE** menu by means of the **PANEL** area. During this process, the procedure already described should be used.

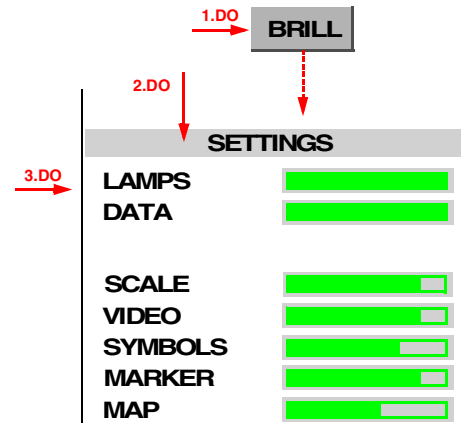

In Chart Display Mode, this area is labelled **MAP / CHART**

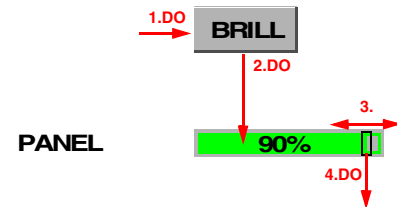

## 2.4 Degaussing

This section is relevant only for monitors with cathode ray tubes, and not for monitors with flat screens.

As a result of changes in the magnetic field at the location of the monitor, the shadow mask of the cathode ray tube might become magnetised, which leads to discolouration over the entire screen or in parts of the display. Because, in the earth's magnetic field, the ship itself acts as a magnet, such changes in the magnetic field can also be caused by changes in the ship's course. The demagnetisation which then has to be performed on the shadow mask ("degaussing") can be performed manually.

☞ If this does not lead to success, the trouble might also be due to magnetic components or magnetised housings, which must then be removed from the environment of the monitor or degaussed.

### Manual Degaussing

Manual degaussing is performed by pressing of the **DEGAUSS** key on the monitor. On monitors which do not have this key, a corresponding button is active:

Click on the **BRILL** button and then on the **DEGAUSS MAN** area.

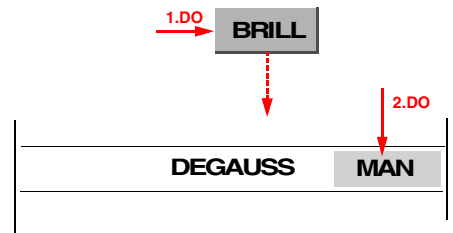

### Automatic Degaussing

With particular types of monitor, it is also possible to set automatic degaussing. When the autodegauss function is switched on, degaussing takes place at adjustable intervals of time, and also when the course has been changed by a predefined amount after the last degauss.

### Switching the Autodegauss Function On and Off

Click on the **BRILL** button and then on the **AUTO DEGAUSS** area.

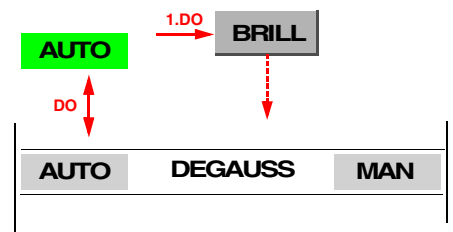

### Setting the Autodegauss Function

1. Click on the **BRILL** button, and then click on the **AUTO DEGAUSS** button by means of MORE.
2. Click on the **TIME** area by means of the MORE key; then, in the menu that is opened as a result, either
  - a) click on the desired time interval, or
  - b) click into the (vertical) bar-area, drag the bar to the desired value, and press the DO key, or
  - c) click into the upper numerical area and enter the value by means of the virtual keyboard.
3. Click on the **TURNING** field by means of the MORE key; then, in the same way, input the course change for which automatic degaussing is to take place.

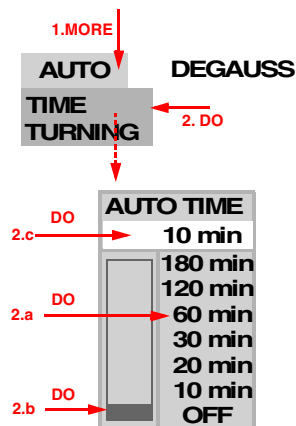

## 2.5 Display Modes

If there is a CHARTPILOT connected, two Display Modes are available on the RADARPILOT:

- **Radar Display Mode:** PPI with all radar and ARPA or EPA functions. The map edited on the radar as per [Section 12](#) can be displayed - see [Section 3.12](#).
- **Chart Display Mode:** PPI with all radar and ARPA or EPA functions. Instead of the map, the User Chart Objects that exist in the CHARTPILOT can be displayed - see [Section 3.10](#).

On the CHARTRADAR, the Chart Display Mode has a significantly extended functionality: in addition to the User Chart Objects, the vector charts that are present on the CHARTPILOT can be displayed also - see [Section 3.11](#).<sup>1)</sup>

### Switch-Over of the Display Modes

Switch-over is performed by means of the keys **RADAR** and **CHART**. The lamp above the keys indicates the Display Mode that is currently switched on.

Alternatively, switch-over can be performed by means of buttons: on the display, click on the **MENU** button, and then click on the desired mode button.

- ☞ When Radar Display Mode is switched on, the button beside the **MENU** button is called **MAP**; when Chart Display Mode is switched on, the name changes to **CHART**.

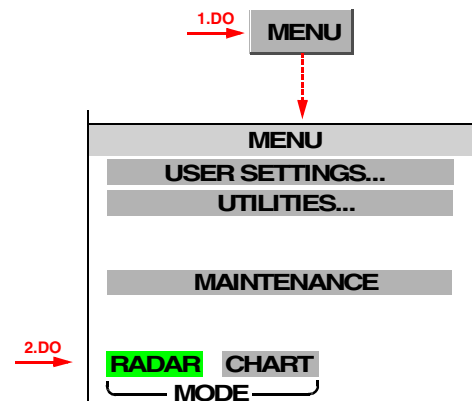

<sup>1)</sup> In the case of a CHARTRADAR configured as per IEC 60936-3 (see footnote on [page 9](#)), while Head-Up Mode is switched on, the display of the chart is not permissible. While Head-Up Mode is switched on, it is not possible to switch over to Chart Display Mode.



2.6 An Overview of the Screen

The following illustration provides an overview of the arrangement of display elements and operating elements on the screen in the **Radar Display Mode** and in the **Chart Display Mode**.

**Transceiver settings:**  
stand-by/radar operation (p. 47)  
master/slave (p. 48)  
transceiver selection (p. 48)  
radar video setting (p. 49)  
antenna revolution rate (p. 52)

**Acquiring targets (p. 69)**  
deleting targets (p. 70)

**Radar PPI:**  
range selection (p. 31)  
centering/off-centering (p. 31)  
suppression of synthetics/radar video (p. 53)

**Alarm symbol for calling up the existing warnings (p. 118)**

**Compass course (p. 57)**  
speed (p. 58)

**Position display:**  
data of position sensor (p. 60):  
system position, course and speed over ground  
or  
cursor position (p. 63),

**Multidisplay:**  
Selectable display of:  
alarm list (p. 119),  
navigation sensor data (p. 58, 61),  
trial manoeuvre (p. 79),  
Zoom Display (p. 100),  
Depth Display (p. 103),  
Wind/Set+Drift display (p. 103),  
Docking Display (p. 99),  
EDIT TRACK menu (p. 85),  
EDIT MAP menu (p. 93),  
track lists/catalogs (p. 37)

**Alarm limit values of collision avoidance (p. 77)**

**Switching on/off the acquisition/guard zone (p. 69)**

**Radar target data (p. 70)**  
system track data (p. 39)

**Brightness setting (p. 21),**  
degaussing (p. 23)

**Setting**  
- display of the tracks (p. 37)  
- system track (p. 39)  
- next waypoint (p. 40)  
editing tracks (p. 85)

**Setting display**  
- of the map (p. 45)  
- of the chart (p. 42)  
- of the User Chart Objects (p. 41 or 42)  
editing maps (p. 93)

**Setting of path prediction (p. 35)**  
trails (p. 36)  
vectors (p. 34)  
past plots (p. 34)

**Quick Info Box (p. 105)**  
with further information:  
ETA to cursor position  
date, time, stop watch,  
help function

**Measurement aids:**  
Parallel Index Lines (p. 66)  
VRM (p. 63)  
EBL (p. 64)

**PPI orientation (p. 30)**

**PPI movement (p. 29)**

**TX/RX 3(X) SP N UP**  
TUNE SLAVE  
GAIN  
RAIN  
SEA  
CLEAN SWP OFF  
IR

**TM RANGE 3 NM**  
RANGE RINGS OFF  
VIDEO OFF  
SYNTH OFF  
OFF CENT  
TM RESET  
ACQ TGT

**HDG 323.2 ° GYRO**  
SPD 12.0 kt BT LOG 1

**POS GPS 3 REF RADAR**  
LAT 53:54.264 N COG 323.0 °  
LON 008:41.395 E SOG 12.0 kt  
ADJUST

**FIX ABS T**

**CPA LIM 0.5 NM 15 min**  
AZ / GZ 1 2  
ID 1 2  
RNG 1.72 1.55 NM  
BRG 68.3 70.3 °  
T SPD 7.90 9.78 kt  
T CSE 142.6 150.6  
TCPA -1:23 -1:02 min  
CPA 1.65 1.50 NM  
BCT min  
BCR NM

**PI R 230**  
1  
2  
3  
4

**VRM**  
1 OFF  
2 OFF

**EBL**  
1 193.7 ° T CENTER  
2 OFF T CENTER

**140 PATH OFF**  
TRAILS 1 min T  
VECTOR 6 min T  
PAST POSN OFF T

**CLOCK: 00:00:00**  
Nov 26 14:08:57/2001 UTC

**MENU MAP TRACK BRILL**

## 2.7 The Menu Structure

The following diagram shows the structure of the menu systems which can be accessed via the button situated at bottom right. <sup>1)</sup>

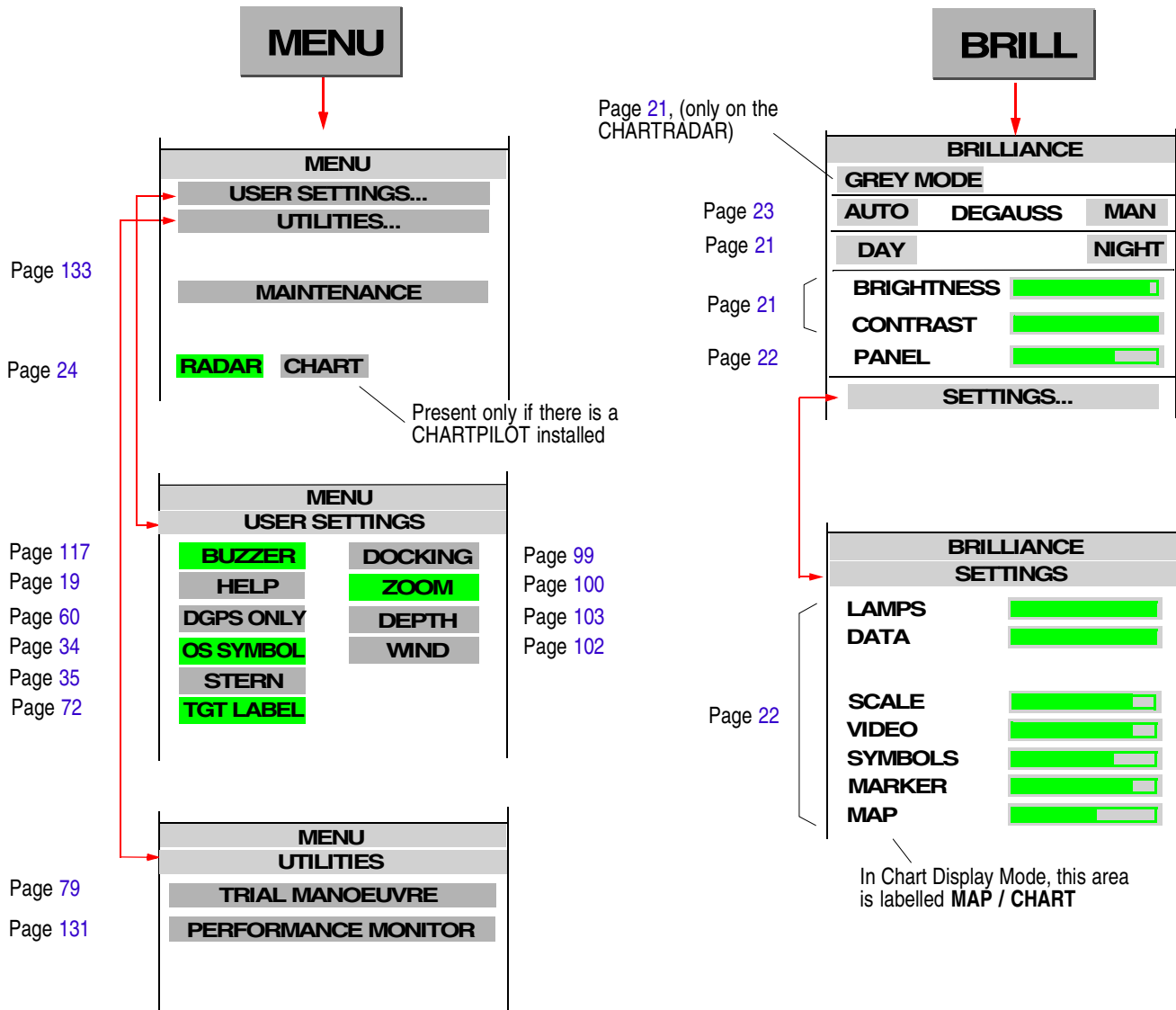

<sup>1)</sup> Because of the individual system configuration, menus might differ from these diagrams. In the descriptions, this is pointed out in individual cases.

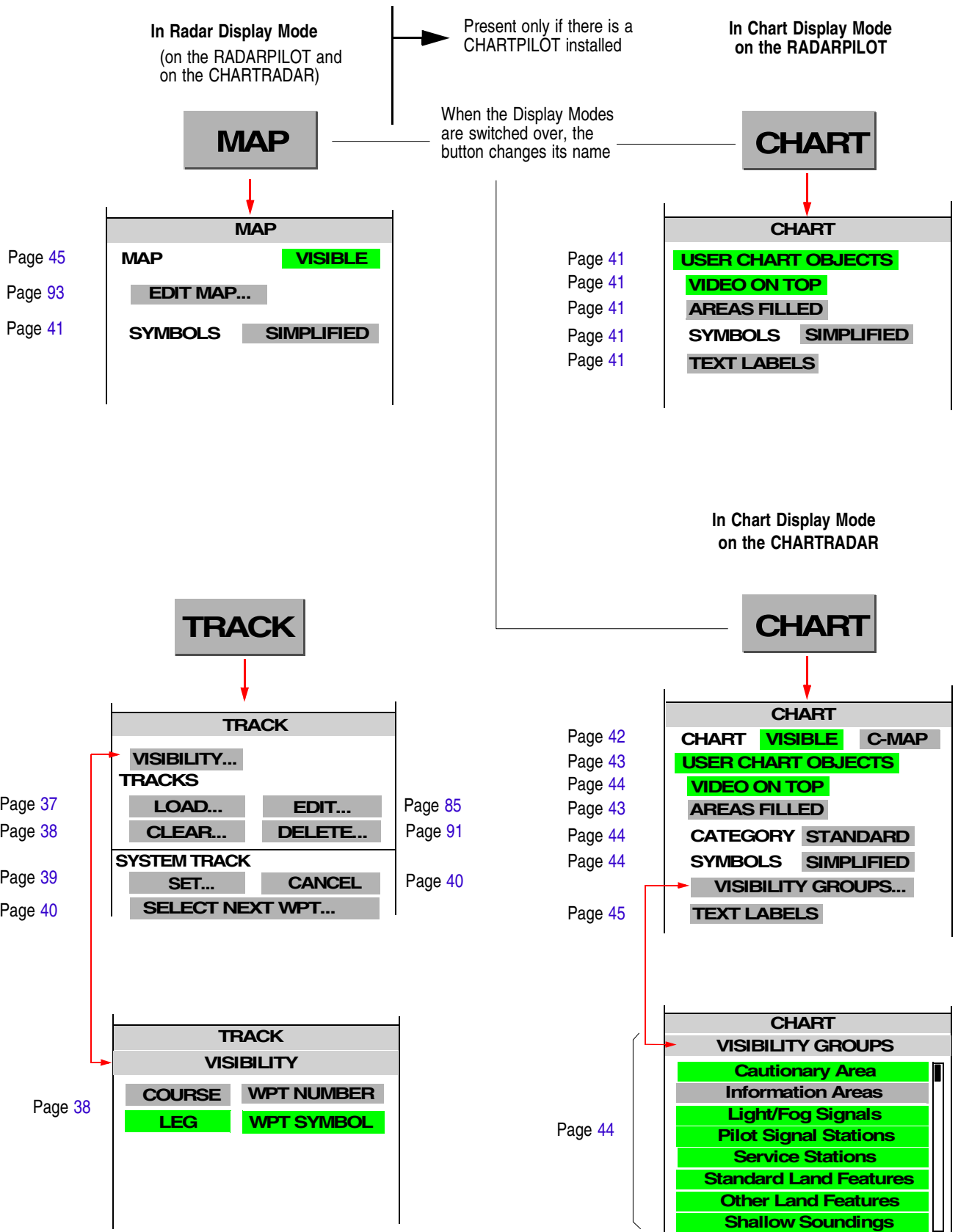

## 2.8 Activating/Deactivating of Slave Keyboards/Trackballs

---

When a slave monitor is installed together with a trackball and (possibly) a keyboard, this combination can perform the same functions as the radar indicator to which these units are connected.

☞ If there are "radar indicators" on the bridge wings, they are often slave monitors and slave keyboards/trackballs.

If there are one or more slave keyboards or slave trackballs connected to an indicator, only one of them is active at a time; operating procedures can be performed only on the one that is active.

### Activating a Keyboard or Trackball

A non-active keyboard or trackball is activated by pressing the DO key for three seconds.

☞ The keyboard/trackball that had been active up until then is thus deactivated. The associated monitor acts as a slave monitor.

If there is a keyboard present, activation can also be performed by pressing one of the keys **RADAR MODE**, **CHART MODE** or **CONN MODE** for three seconds. In this case, when the activation occurs, the switch-over assigned to the key is also performed, see [Section 16](#).

### 3 PPI Settings

**Subjects of this Section:**

- ◆ Basic settings of the PPI
  - Stabilisation of the radar picture: RM, TM
  - PPI orientation: Head-Up, North-Up, Course-Up
  - Centering / off-centering of the radar picture
  - Selection of range
- ◆ Setting of the synthetics elements
  - Own ship symbol: heading line, speed vector, past position plot, path prediction
  - Target synthetics: speed vectors, past position plots, trails
  - Display of the range rings
- ◆ Setting the display of tracks, defining System Track and next waypoint
- ◆ Setting the display of the map and the User Chart Objects
- ◆ Setting the display of the chart on the CHARTRADAR

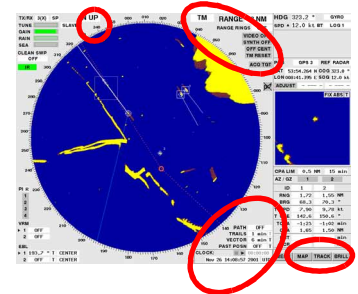

### 3.1 Screen Stabilisation of the PPI: True Motion, Relative Motion

As far as the screen stabilisation of the PPI is concerned, there is a choice between the following:

**True Motion (TM):** The radar video is fixed; the own ship symbol moves across the screen. The PPI orientation is North-Up or Course-Up. Either manually, or automatically by means of a **TM Reset**, the own ship symbol on the PPI is reset in good time before the PPI boundary is reached; this resetting is done in such a way that the larger part of the PPI lies ahead of own ship.

**Relative Motion (RM):** Own ship's position is fixed; the radar video moves relative to own ship in accordance with the movement of own ship. As far as the PPI orientation is concerned, it is possible to choose between Head-Up, North-Up and Course-Up.

**Switching Over between TM and RM**

Clicking on the PPI stabilisation area causes a switch-over between TM and RM.

☞ If the PPI orientation setting is Head-Up, then when switch-over to TM mode takes place there is automatic selection of North-Up and setting of the display of trails to "true". In TM mode, relative trails cannot be displayed.

In RM mode, there is also an indication in the PPI stabilisation area stating whether the trails and vectors are displayed as relative **RM (R)** or true **RM (T)**.

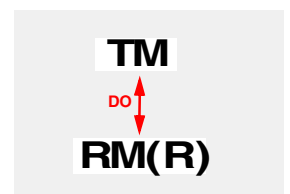

**Manual TM Reset**

A TM reset is performed by clicking of the **TM RESET** area.

☞ The **TM RESET** area appears, instead of the **CENTER** area, only when a switch-over to TM mode is performed.



### Automatic TM Reset

In good time before an automatic TM Reset takes place, the **TM RESET** area begins to flash. If the TM Reset is not then performed manually, it takes place automatically.

## 3.2 PPI Orientation: Head-Up, North-Up, Course-Up

As far as the PPI orientation is concerned, there is choice between the following:

**Head-Up:** The heading of own ship points upwards.

 Head-Up is available only in RM mode.

**North-Up:** Geographic North points upwards.

**Course-Up:** The course which exists at the instant of switch-on or re-orientation of this mode points upwards.

 With every switch-over and re-orientation, the trails are lost; they build up anew in the new mode.

### Switching Over between Head-Up and North-Up

When **H UP** (for "Head-Up") or **N UP** (for "North-Up") is displayed in the PPI orientation area, clicking on this area causes a switch-over between these two modes. <sup>1)</sup>

 When a switch-over to Head-Up mode takes place, there is an automatic switch-over to RM mode, and the display of the trails is set to relative. In Head-Up mode, true trails cannot be displayed.

 In Head-Up Mode, the display of the chart is suppressed if the rate of turn is very large.



### Switch-Over to Course-Up Mode

Click into the PPI orientation area by means of the MORE key, and then click on **C UP**.

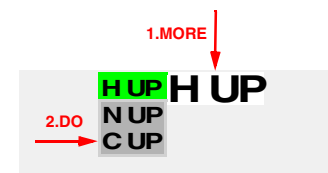

### Re-Orientation in Course-Up Mode

When **C UP** (for "Course-Up") is displayed in the PPI orientation area, clicking on this area causes the PPI to be rotated and fixed in such a way that the course which exists at the instant of clicking points upwards.

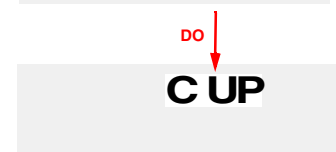

### Switch-Over from Course-Up to Head-Up or North-Up

Click into the PPI orientation area by means of the MORE key, and then click on **H UP** (for "Head-Up") or **N UP** (for "North-Up").

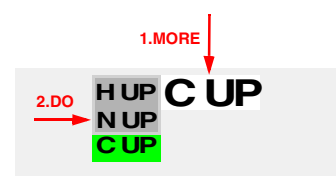

<sup>1)</sup> In the case of a CHARTRADAR configured as per IEC 60936-3 (see footnote on [page 9](#)), while Head-Up Mode is switched on, the display of the chart is suppressed.

### 3.3 Centering / Off-Centering of the Display (Center, Off-Center)

If RM Mode is selected for the screen stabilisation of the PPI, the reference position <sup>1)</sup> can be positioned at the centre of the PPI or can be fixed. Off-centering is possible in all ranges except the 96 NM range.

#### Centering of the Display

By clicking on the **CENTER** area, the reference position is centered in the PPI.



#### Off-Centering of the Display

Click on the **OFF CENT** area; then, in the PPI, click on the place that is wanted as the reference position.

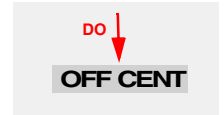

The radar video display can be off-centered up to a maximum of 75% of the PPI radius.

### 3.4 Range Selection (Range)

The display range can be chosen from a selection of ten **nautical ranges** (PPI radius between 0.25 NM and 96 NM) and two **docking ranges** (PPI radius 250 m and 500 m).

In the nautical ranges, all distances are stated in NM and all speeds in kt; in the docking ranges, all distances are stated in metres and all speeds in m/s.

When you switch over to the 96 NM range, a switch-over takes place automatically to relative motion with a centered display.

#### Selecting the Next Larger or Next Smaller Range

Show into the **Range** area, and then click on ▼ for a smaller range (larger scale) or ▲ for a larger range.

The change from the docking ranges to the nautical ranges likewise takes place in this way.

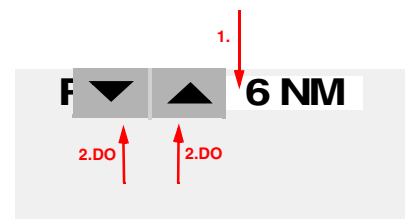

#### Selecting a Range Directly; Switching Over from the Nautical Ranges to the Docking Ranges

With the MORE key, click into the Range area; then click on the desired range (nautical or docking).

If Docking Mode is switched on, the status message **DOCKING MODE** appears on a coloured background beside the PPI settings.

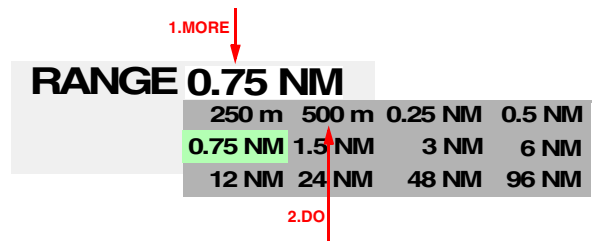

<sup>1)</sup> For reference position, see [page 60](#)

## 3.5 Range Rings, Grid

Fixed range rings or a map grid can be displayed. Range rings are concentric circles with the reference position as their centre, and are situated at equal distances from one another.

### Selection between Range Rings and Map Grid

Click into the **RANGE RINGS / GRID** field by means of the MORE key, and then (with the DO key) click on **RANGE RINGS** or **GRID**.

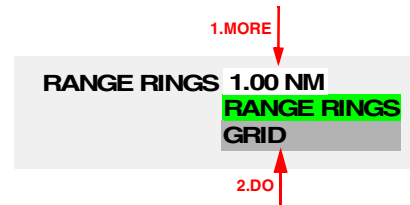

### Switching the Range Rings or Grid On and Off

Clicking of the **RANGE RINGS /GRID** area switches the display on and off.

The distance between the range rings is displayed in the **RANGE RINGS** area.



## 3.6 Own Ship Symbols and Target Symbols, Vectors, Past Position Plots

### Own Ship Symbol

The own ship symbol consists of two concentric circles . In the smaller display ranges up to and including 1.5 NM, the circles are replaced by an **own ship contour**, whose length and width are true to scale.

The display of the own ship symbol can be switched off, see [page 34](#).

The own ship symbol is supplemented by the following elements:

- **Heading line:** It is the extension of the ship's longitudinal axis in the ahead direction and extends to the edge of the PPI. The heading line is displayed at all times.

The origin of the heading line is the **reference position for bearings** <sup>1)</sup>.

- **Speed vector:** The direction of the vector corresponds to the existing course of own ship. The length corresponds to the existing speed of own ship. Together with the speed vectors of the tracked radar targets, the display of the speed vector can be switched on and off, and the time represented by the displayed vectors can be specified. Furthermore, it can be seen from the vector symbol of own ship whether the vector is relative to the sea (**Water Track, WT** = one arrow-head) or relative to the bottom (**Bottom Track, BT** = two arrow-heads).

- **Past position plot** (in the case of the ARPA radar): The past position plot corresponds to the past movement of own ship. On it, there are four time markers, whose distance apart in time can

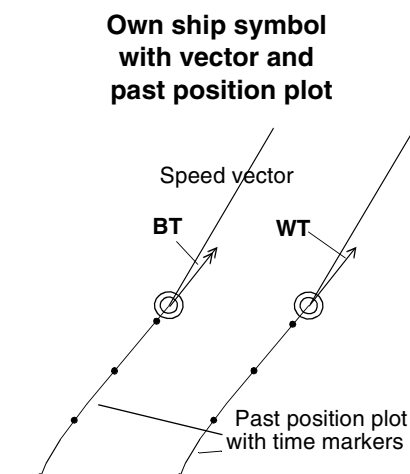
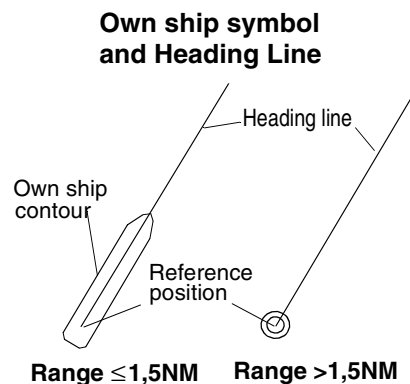

<sup>1)</sup> For the reference position for bearings, see [page 60](#).



be set. The setting of the time marker spacing also defines the length of the plot that is displayed. This setting and the on/off switching of the past plot display take place in common with the past plots and time markers of the radar targets.

- **Stern line:** This extension of the heading line in the aft direction as far as the edge of the PPI can be switched on if necessary. (For the setting procedure, see [page 35](#).)
- **Path Prediction:** In the small display ranges up to 1.5 NM, it is possible to display the probable track along which own ship will travel if it maintains its existing rate of turn and its existing speed. The prediction time can be set, see [page 35](#).

**Path Prediction**

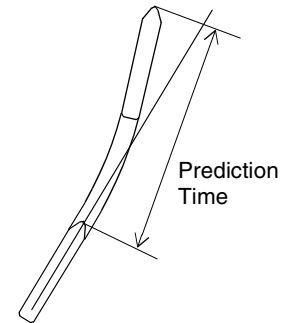

**Radar Target Symbols**

Targets being tracked on the EPA radar or ARPA radar are displayed in all display ranges as circular symbol ○ <sup>1)</sup>. The following elements can be provided for them:

- **Speed vector:** The direction of the vector corresponds to the existing course of the target, and the length corresponds to the existing speed of the target. Together with the speed vectors of the own ship symbol, the display of the speed vector can be switched on and off. The length of the vector is computed from the distance travelled by the vessel in the "vector time", as it is called. The vector time can be adjusted.

In the case of the manual plotting aid (EPA radar), the vector is computed from the last two (manual) plots. Therefore, particular care is required when plotting on the EPA radar: if the target being plotted changes its course or speed between two plots, the vector displayed does not correspond to the actual vector.

- **Past position plot:**  
**In the case of the ARPA radar,** past position plots can be displayed for the targets. The settings for these plots are made jointly with those of own ship's past position plot. They have four time markers at the most, which are set simultaneously on all past position plots.

**In the case of the EPA radar,** the last four plots are joined up by a line. Thus, these markers - in contrast to the time markers of the ARPA radar - are not at constant time-intervals apart from each other, i.e. they also have no relation to each other.

All vectors and past position plots can be displayed jointly either relative to own ship (**R** = relative display) or over ground or through the water (**T** = true display).

In the case of the relative display, the vector and the past position plot of own ship are non-existent by definition.

Furthermore, the radar target symbols are supplemented by symbols of the manual plotting aid or of the automatic target tracking function (see [page 67](#)).

The computation of the vectors is always based on the BT/WT setting which is displayed for the selected speed sensor.

**Target symbol on the ARPA radar**

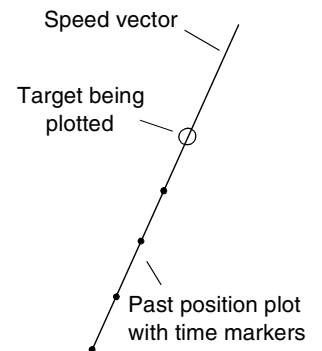

**Target symbol on the EPA radar**

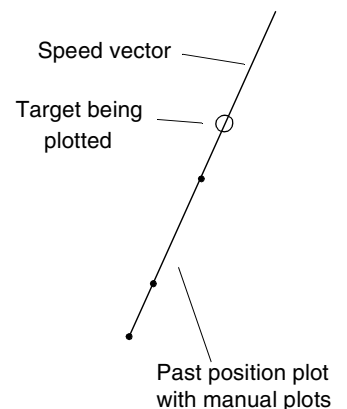

1) Other symbols, see [page 67](#)

**Switching the Own Ship Symbol On and Off**

Click on the MENU button, and then, in the USER SETTINGS menu, click the OS SYMBOL area.

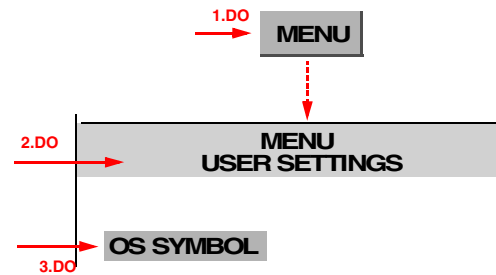

**The Setting of Vectors**

With the operating procedure described, both the speed vectors of the radar targets and the vector of own ship are set.

**Switching the Display of the Vectors On and Off**

The display of the own ship vector and of the target vectors is switched on and off by clicking on the VECTOR area.

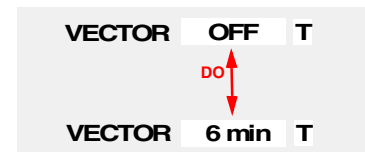

**Specifying the Length of the Vectors**

The procedure for setting the vector length is performed by specifying the travelling time represented by the vectors:

Click on the VECTOR area by means of the MORE key; then, in the menu that is opened as a result, either

- a) click on the desired numerical value, or
- b) click into the (vertical) bar-area, drag the bar to the desired value, and press the DO key, or
- c) click into the upper numerical area and enter the value by means of the virtual keyboard.

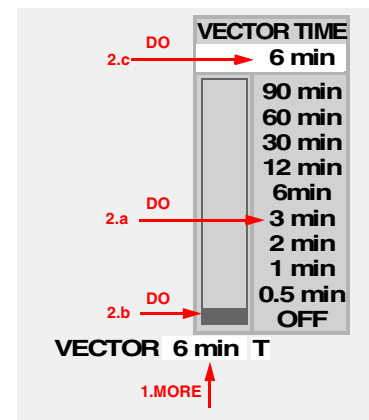

**Switching the Vectors to Relative or True Display**

The switch-over is performed by clicking into the right-hand VECTOR-area.

- ☞ This switch-over takes place jointly for vectors and for past position plots. Therefore, switching over can also be performed by clicking on the right-hand PAST POSN area.
- ☞ If the relative display is set, the vector and the past position plot of own ship are non-existent by definition.

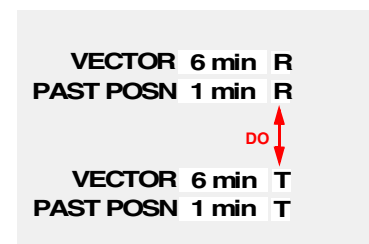

**Setting the Past Position Plot**

**Switching the Past Position Plot On and Off (ARPA radar only)**

The display of the past position plot is switched on and off by clicking on the PAST POSN area.

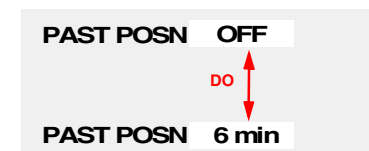

**Specifying the Time Interval between the Time Markers (ARPA radar only)**

Click on the **PAST POSN** area by means of the MORE key, and then click on the desired time value.

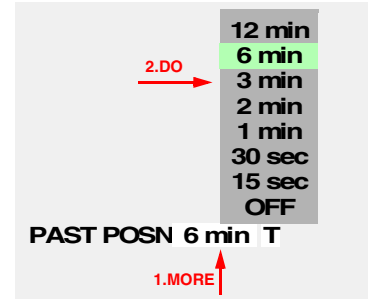

**Switching the Past Position Plots to Relative or True Display.**

The switch-over is performed by clicking into the right-hand **PAST POSN** area

- ☞ This switch-over is performed jointly for past position plots and for vectors. Therefore, switching over can also be performed by clicking on the right-hand **VECTOR**-area.
- ☞ If the relative display is set, the vector and the past position plot of own ship are non-existent by definition.

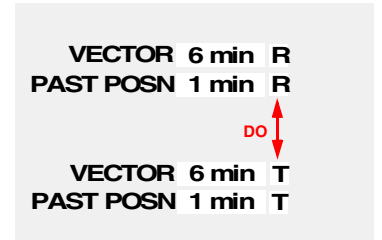

**Setting the Path Prediction Function**

**Switching the Path Prediction Function On and Off**

The Path Prediction function is switched on and off by clicking on the **PATH** area.

- ☞ When the Path Prediction function is switched on, its display is presented only in the display ranges less than 3 NM and only if particular conditions are fulfilled, such as adequate speed and a rate of turn which can be determined.

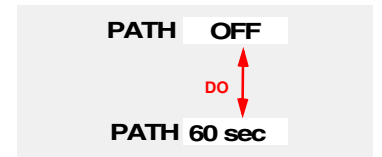

**Specifying the Length of Path Prediction**

With the MORE key, click on the **PATH** area. This causes a menu to open. In that menu, either

- a) click on the desired numerical value, or
- b) click into the (vertical) bar area, pull the bar to the desired value and press the DO key, or
- c) click into the upper numerical area and enter the value by means of the virtual keyboard.

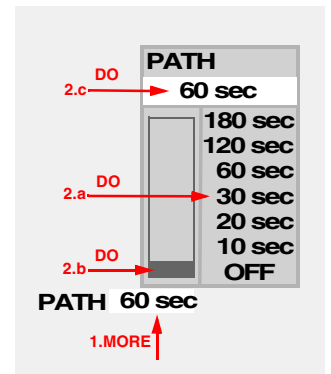

**Switching the Stern Line On and Off**

Click on the MENU button, and then, in the USER SETTINGS menu, click the **STERN** area.

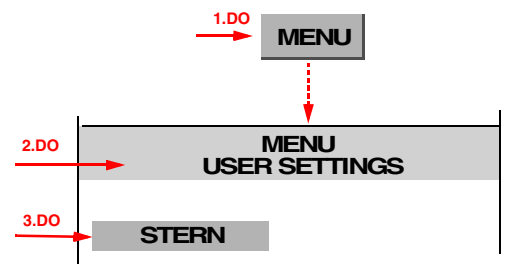

### 3.7 Trails

In the true display, trails make it possible for you to reach a conclusion quickly about the manoeuvre performed by targets. In the relative display, the trails provide a quick overview of the danger situation (a constant bearing). However, only qualitative information can be obtained from them.

For radar echoes moving on the PPI, trails can be displayed. These trails can be varied as follows:

- The display of these trails can be switched on and off.
- Their length can be specified.
- If the screen stabilisation of the PPI is set to RM, the trails can be displayed with the PPI orientation "North-Up" and "Course-Up" **relative** to own ship or with **true** (absolute) orientation, i.e. in relation to the sea bottom <sup>1)</sup>.
- The trails can be deleted so that they have to build up again.

#### Switching the Display of the Trails On and Off

The display of the trails is switched on and off by clicking on the **TRAILS** area.

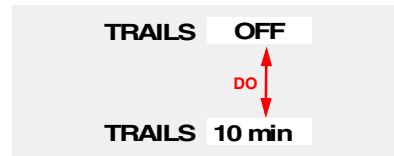

#### Specifying the Length of the Trails

Click on the **TRAILS** area by means of the MORE key; then, in the menu that is opened as a result,

- a) click on the desired time, or
- b) click into the (vertical) bar-area, drag the bar to the desired value, and press the DO key, or
- c) click into the upper numerical area and enter the value by means of the virtual keyboard.

If the trails are lengthened, they reach the new specified length only after the time difference (i.e. in the case of switching over from 12 to 30 minutes, 18 minutes will pass before the trails correspond to a length of 30 minutes).

The reduction of the trail length too takes some time. In the **TRAILS** area, the length currently being displayed is indicated.

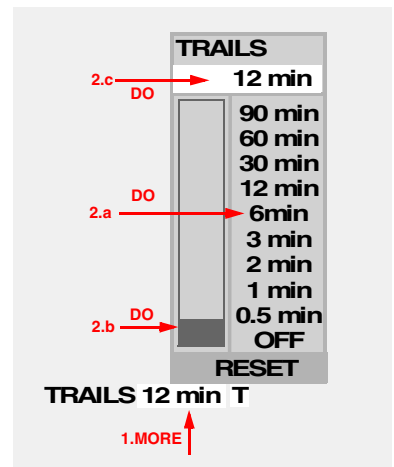

#### Switching the Trails to Relative or True Display

The switch-over is performed by clicking into the right-hand **TRAILS** area.

The switch-over is possible only in the RM modes "North-Up" and "Course-Up". In TM mode, the trails displayed are always true; in the RM mode "Head-Up", they are always relative.



#### Deletion of Trails

Click on the TRAILS area by means of the MORE key; then, in the menu that is opened as a result, click (with the DO key) on **RESET**.

The trails are also deleted whenever a switch-over occurs which changes the entire radar video (RM/TM, PPI orientation, Range, Center/OffCenter), but they then appear again.

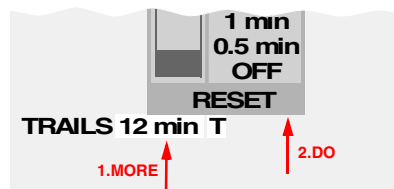

<sup>1)</sup> or in relation to the water, depending on the selected speed sensor

### 3.8 Setting the Display of Pre-planned Tracks

**Pre-planned Tracks** are planned tracks whose routes are defined by the geographical coordinates of the **waypoints** and by the **curve radii** of the curved paths along which the ship has to sail at the waypoints <sup>1)</sup>. These tracks must be generated beforehand on the radar system (see [Section 11](#)) or on a connected CHARTPILOT.

It is possible to specify whether Pre-planned Tracks are to be displayed, and if so, which ones. Furthermore, it is possible to specify which elements of the tracks are to be displayed.

 The selection of the Pre-planned Tracks that are to be displayed and the specifying of the track elements that are to be displayed affect only the item of equipment being operated.

#### Selecting the Track that is to be Displayed

If there is a CHARTPILOT in the system, it must be in the switched-on state, because in this case the track data are physically stored there.

1. Click on the **TRACK** button.
2. When you click on the **LOAD** button, the list of existing track catalogs appears.
3. Click on the desired catalog. As a result, the list of tracks contained in the catalog appears. Tracks which have already been selected for the display are marked in that list.
4. Click on the track that is to be additionally displayed, and then click on the **LOAD** button. This must be repeated for further tracks if necessary.

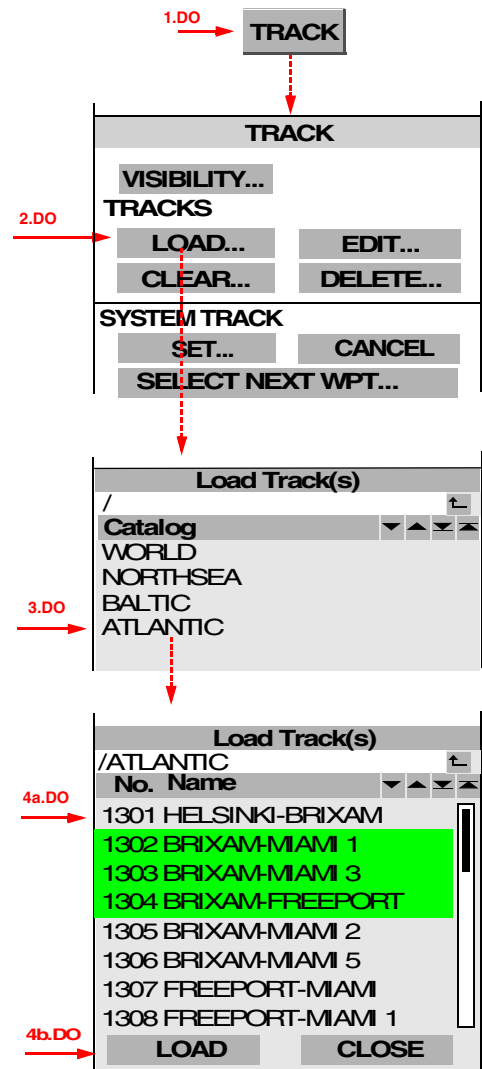

<sup>1)</sup> And also by specifying whether the track sections longer than 20 NM between two waypoints are to be displayed as rhumb lines or as great circles.

### Switching Off the Display of a Track

1. Click on the **TRACK** button and then on the **CLEAR** button. The list of displayed tracks appears.
2. By clicking, mark the tracks that are no longer to be displayed, and click on the **CLEAR** button.

### Display of the Tracks

Pre-planned Tracks appear on the PPI as bold, dashed lines, together with their waypoints and the Wheel Over Points computed by the system, possibly including the waypoint numbers and the courses of the legs <sup>1)</sup>.

The colour of the tracks is orange, except for the System Track, which is displayed in red.

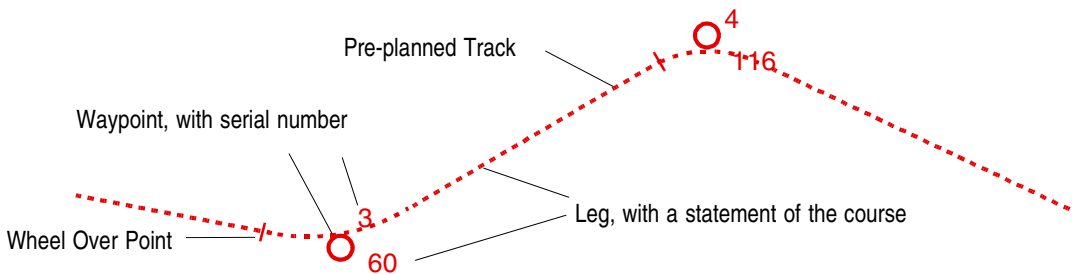
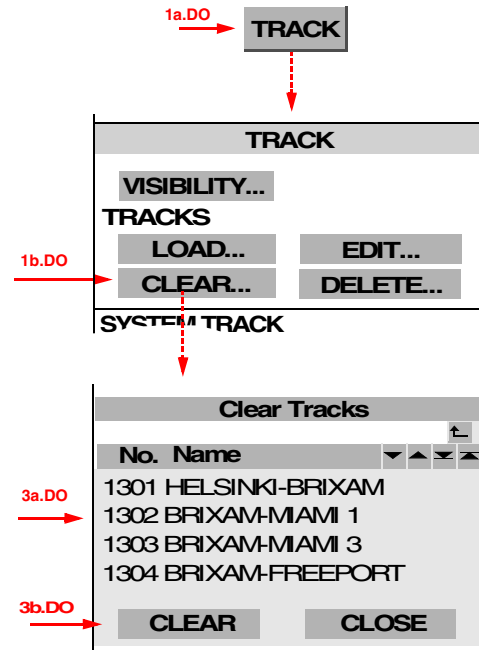

### Defining Track Elements that are to be Displayed

For the individual elements of the displayed tracks, it is possible to define whether they are to be displayed. These definitions are applicable to all displayed tracks.

1. Click on the **MAP** button and then the **VISIBILITY** button.
2. Switch the display of the elements on or off by clicking:
  - **COURSE** for the display of the courses of the legs
  - **LEG** for the display of the lines and symbols of the Wheel Over Point
  - **WPT NUMBER** for the display of the waypoint numbers
  - **WPT SYMBOL** for the display of the waypoint symbols

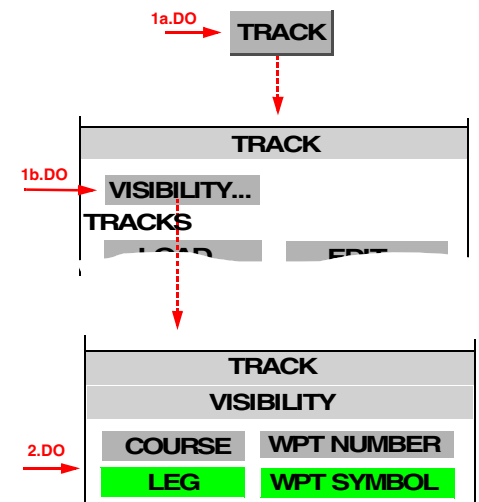

<sup>1)</sup> The track segment defined by two consecutive waypoints is called a leg.

### 3.9 Defining the System Track and the Next Waypoint; System Track Display

The track along which the ship is to sail can be defined as the **System Track** and, as a result, can be highlighted in colour (red instead of orange).

☞ For the connected CHARTPILOT, the System Track has much greater importance: all currently valid track data that are displayed there (e.g. planning data, track deviations, track-related alarms) refer to the System Track. For details, see the Operating Instructions of the CHARTPILOT.

While the ship is approaching the System Track or is sailing along it, it is possible to explicitly define which waypoint of the System Track is to be approached directly. The route to that place is displayed additionally in the same way as the System Track.

☞ The defining of the System Track and of the Next Waypoint is applicable for all items of equipment in the system.

#### Defining the System Track

The track that is to be defined as the System Track must already be selected for the display.

1. Click on the **TRACK** button and then on the **SET** button situated under **SYSTEM TRACK**. As a result, the list of displayed tracks appears. If a System Track has already been defined, it is marked here.
2. By clicking, mark the track that is to become the (new) System Track, and click on the **SET** button.

marked track is now the System Track. Its data appear in the System Track display at the bottom of the side strip.

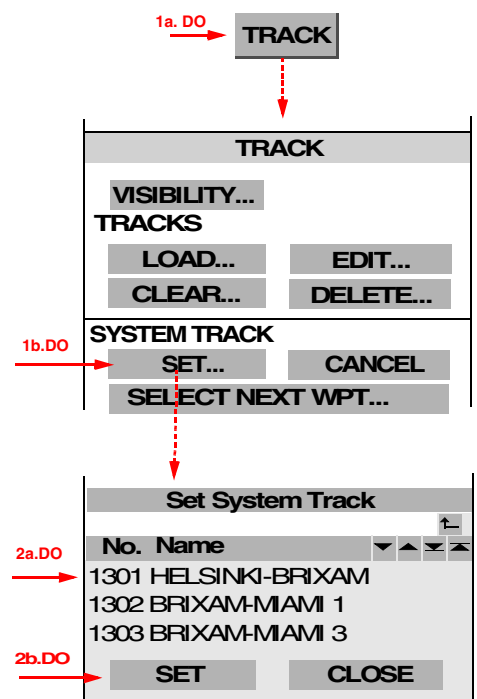

#### The System Track Display

The System Track display contains the number and name of the system track and the numbers and names of the waypoint passed last (**FROM WPT**) and of the currently valid waypoint (**TO WPT**).

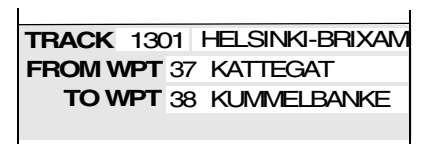

If the System Track display is covered over by the target data display, it can be brought back into the foreground by clicking on the **OTHER** button and **TRACK DATA**.  
 (The **OTHER** button appears in miniaturised form in the top left-hand corner of the target data or System Track data as soon as the cursor is situated in this data area and there is no menu opened there. It is displayed in normal form as soon as the cursor is situated in the area of the normal display of the **OTHER** button - see also [Switching the Displays On and Off](#) on page 99.)

### Defining the Next Waypoint

In order to display the path leading to the System Track, it is necessary to specify the waypoint at which that path meets the System Track. That waypoint is called the "Next Waypoint".

1. Click on the **TRACK** button and then on the **SELECT NEXT WPT** button situated under **SYSTEM TRACK**. As a result, the waypoint list of the System Track appears and the according data displays are cleared.
2. By clicking, mark the waypoint that is to be approached, and click on the **SELECT** button.

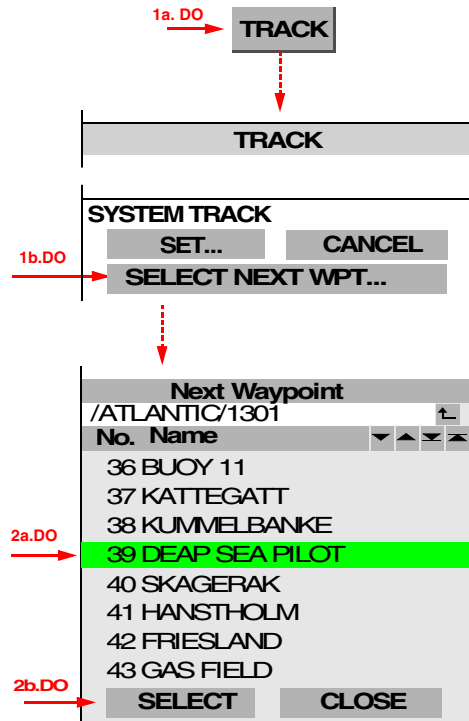
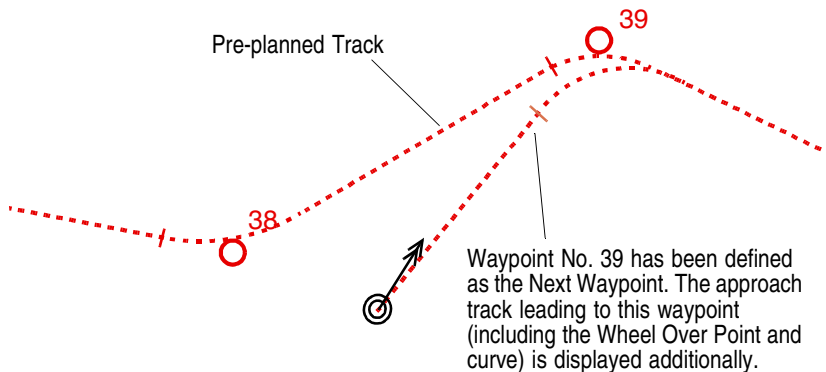

### Cancelling the Definition of the System Track

If a System Track is already defined but is to be deselected:

Click on the **TRACK** button and then on the **CANCEL** button situated under **SYSTEM TRACK**. As a result, the definition of the System Track is cancelled.

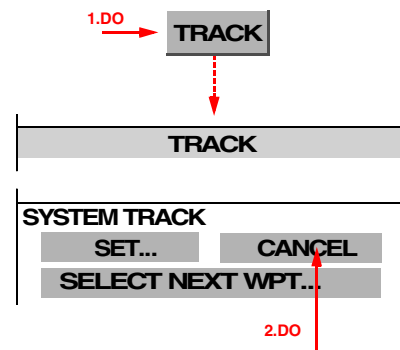



### 3.10 Setting the Display of User Chart Objects on the RADARPILOT

 For display of the User Chart Objects on the CHARTRADAR, see [page 42](#).

If there is a CHARTPILOT, the User Chart Objects that exist in the CHARTPILOT can also be displayed on the RADARPILOT.

#### Switching the Display of User Chart Objects On/Off

1. Chart Display Mode must be switched on, e.g. by pressing the **CHART** key.
2. Open the CHART menu by clicking on the **CHART** button.
3. Click on the **USER CHART OBJECTS** button.

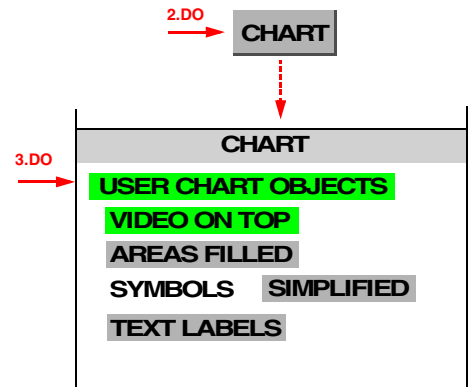

#### Setting the Display of the Areas

As far as the display of the areas is concerned, it is possible to choose between display of the area outlines and display of the area colours.

Setting is performed in the CHART menu by means of the **AREAS FILLED** button.



#### Displaying User Chart Objects Temporarily on Top of the Radar Video

Normally, the video is displayed on top of the User Chart Objects, i.e. User Chart Objects can be covered over by the video.

If only the area contours are displayed (**AREAS FILLED** is switched off), the User Chart Objects are displayed on top of the video (i.e. completely) as long as the **VIDEO ON TOP** button in the CHART menu is pressed.



#### Defining the Symbol Presentation

For the symbols, it is possible to define whether they are to be displayed in the same way as in the paper charts (**PAPER CHARTS**) or in a simplified form more suitable for the screen (**SIMPLIFIED**).

 In the **SIMPLIFIED** presentation, the symbols consist only of contours, and therefore cover the video to a lesser extent than with the **PAPER CHARTS** presentation.

The setting procedure: In the CHART menu, click on the **SYMBOLS** button and then click on the desired presentation.

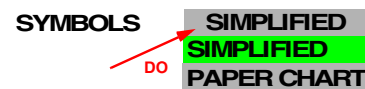

#### Switching Texts On/Off

It is possible to define whether the User Chart Objects designations (entered during editing of the User Chart Objects) can be displayed. This definition process is performed in the CHART menu by means of the **TEXT LABELS** button.



#### Optimum Setting for Radar Video Observation with the Electronic Chart Switched On

- Display of the area contours only
- Setting the symbol presentation to **SIMPLIFIED**
- No display of Text Labels

### 3.11 Setting the Display of Charts and User Chart Objects on the CHARTRADAR

 For display of the User Chart Objects on the RADARPILOT, see [page 41](#)

On the CHARTRADAR, it is also possible to display Electronic Charts if they exist in the system's CHARTPILOT <sup>1)</sup>.

The most important display of the Electronic Charts in the system is the display on the CHARTPILOT, which is usually approved as an ECDIS. There, all of the system's display and operating functions that are relevant for this purpose are available. Some of them are also available on the CHARTRADAR.

#### Important Differences between the CHARTRADAR and the CHARTPILOT

**Additionally present** on the CHARTRADAR:

- The Electronic Chart and the radar video are displayed simultaneously in the PPI.
- The areas of the Electronics Charts can be replaced by their contours (so that the radar video stands out better from the Electronic Chart).

**Not present** on the CHARTRADAR:

- Only vector charts (i.e. no raster charts, e.g. ARCS charts) and User Chart Objects can be displayed.
- The info system (detailed information about the individual chart objects) exists only on the CHARTPILOT. This also contains the information about the date and number of the last ENC update.
- The depth contours (Safety Contour, Shallow Contour and Deep Contour, Safety Depth) are set on the CHARTPILOT and are taken over for the display on the CHARTRADAR.

 The subject of Electronic Charts is described in detail in the CHARTPILOT Operating Instructions. In the Operating Instructions that you are now reading, it is assumed that you already possess the knowledge of operating the CHARTPILOT.

#### Switching the Display of the Electronic Chart On/Off, Selecting the Chart Type

To display the Electronic Chart, Chart Display Mode must be switched on, e.g. by pressing the **CHART MODE** key. The other settings are performed in the CHART menu, which is opened by clicking on the **CHART** button.

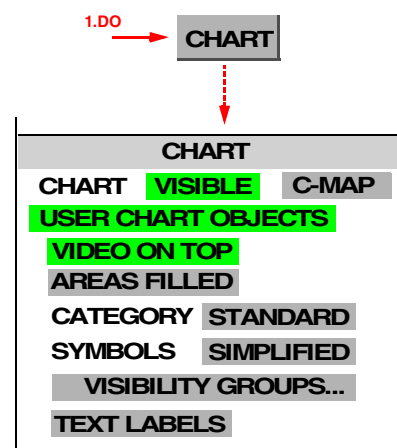

#### Switching the Display of the Vector Chart On/Off

In the CHART menu, click on the **VISIBLE** button.



<sup>1)</sup> If there is more than one CHARTPILOT, the CHARTPILOT from which the data and settings are taken over is specified for each radar at service level.

### Selecting the Chart Type

In the CHART menu, click on the **TYPE** button (the right-hand button in the CHART row) and then click on the desired chart type.

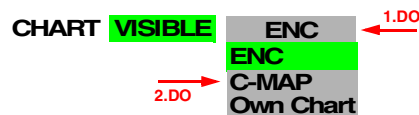

If other than the official approved ENC chart data are selected, an indicator **NO ENC** appears above the **PATH** button.

If the cursor is positioned on the **NO ENC** indicator, additional information is displayed in the **Quick Info Box**.

No official chart data available. Please refer to paper chart.

### Switching the Display of the User Chart Objects On/Off

In the CHART menu, click on the **USER CHART OBJECTS** button.



### Influencing the Form of the Objects Displayed

#### Setting the Display of the Areas

As far as the display of the areas is concerned, it is possible to choose between display of the area outlines and display of the area colours <sup>1)</sup>:

Setting is performed in the CHART menu by means of the **AREAS FILLED** button.



☞ After the switch-over, generation of the new picture might take several seconds.

AREAS FILLED switched on: The areas are displayed with the colours of the Electronic Chart or as grey areas (in Grey Mode - see [page 21](#)).

AREAS FILLED switched off: Only the contours of the areas are displayed, so that the radar video is disturbed as little as possible.

☞ This setting affects not only the display of all areas contained in the vector chart but also the large-area User Chart Objects (Danger Highlights, Feature Areas).

☞ If only the contours of the areas are displayed, the area between safety contour and land area is additionally marked with the shallow water pattern. The land areas are provided with a similar but coloured and much denser pattern.

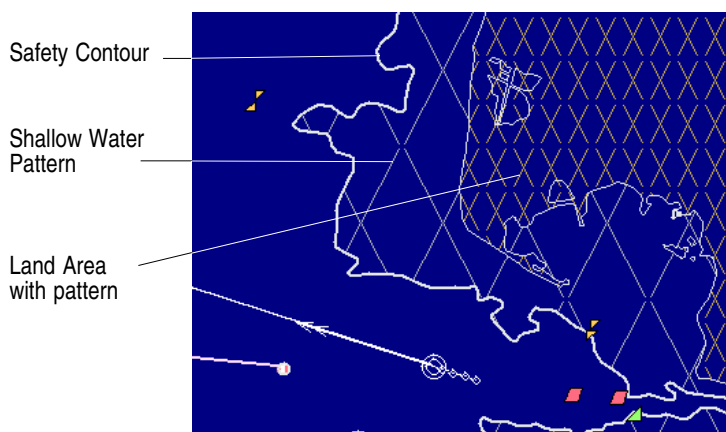

<sup>1)</sup> If the CHARTRADAR is configured as per IEC 60936-3 (see footnote on [page 9](#)), only the display of the area colours is possible. Therefore, in this case the buttons **AREAS FILLED** and **VIDEO ON TOP** are not present.

### Displaying Charts and User Chart Objects Temporarily on Top of the Radar Video

Normally, the radar video is displayed on top of the charts and the User Chart Objects, i.e. objects of the charts and User Chart Objects can be covered over by the video.

If only the area contours are displayed (AREAS FILLED is switched off), the charts and the User Chart Objects are displayed on top of the video (i.e. completely) as long as the **VIDEO ON TOP** button in the CHART menu is pressed (see footnote 1 on page 43).



### Defining the Symbol Presentation

For the symbols, it is possible to define whether they are to be displayed in the same way as in the paper charts (**PAPER CHARTS**) or in a simplified form more suitable for the screen (**SIMPLIFIED**).

Setting: In the CHART menu, click on the **SYMBOLS** button and then click on the desired presentation.

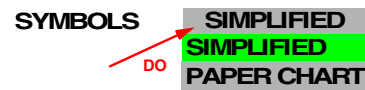

### Specifying the Objects to be Displayed

The various objects contained in the vector chart (symbols, lines, areas, texts) are grouped to form display groups. For the task of selecting the display groups that are to be displayed, IMO has defined the **categories Display Base** and **Display Standard**. On the CHARTRADAR, it is possible to switch over between these categories and the display of all objects contained ("category" **ALL**).

### Switching Over between the Display Group Categories:

Click on the **CHART** button, and select the category by means of the **CATEGORY** button.

In order to ensure a clear display, the program switches back to the category **BASE** or **BASE +** (see below) after three minutes.

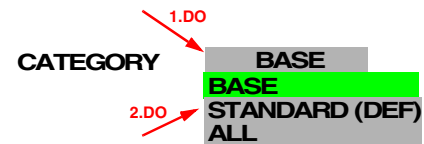

### Displaying Additional Display Groups and Suppressing the Display of Display Groups

For each category, it is possible to define whether particular display groups are to be displayed:

1. In the CHART menu, click on the **VISIBILITY GROUPS** button.
2. In the list which then opens, the display of these display groups can be switched on/off for the selected category by clicking (the list can be scrolled).

If, with the categories "Base" and "Standard", the display of additional display groups is switched on, a **plus sign** appears additionally in the **CATEGORY** button. If, with the categories "Standard" and "All", the display of display groups is suppressed, a **minus sign** appears additionally in the **CATEGORY** button.

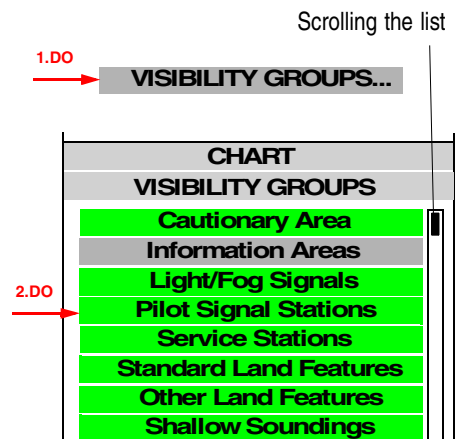

**Resetting the Individual Selection of Display Groups**

The selection for the display groups are stored, i.e. they remain in effect even after switch-over of the category (in contrast to the CHARTPILOT, because there this is not allowed by the ECDIS regulations). However, the groupings can also be reset to the IMO-defined values by switching over.

Click on the **CATEGORY** button and again select the category that is still selected.

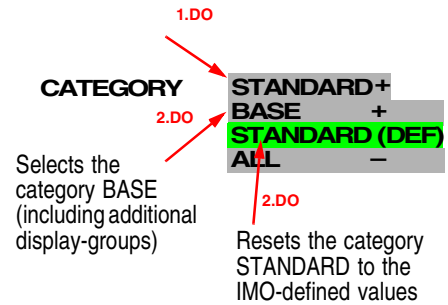

**Switching Names, Designations and Texts On/Off**

Because of the particular importance of the display group "Text Labels", it can be switched on and off directly in the CHART menu by means of the **TEXT LABELS** button.



In this way, the text labels of all objects of the vector chart and of the User Chart Objects are switched on/off.

**Optimum Setting for Radar Video Observation with the Electronic Chart Switched On**

- Display of the area contours only.
- Setting the symbol presentation to SIMPLIFIED.
- Displaying only the necessary objects (category "Base" is recommended).
- Switching on the display of the necessary depth-contours only (on the CHARTPILOT) (i.e. possibly suppressing Shallow Contour and Depth Contour).
- The Grey Mode (see page 21) might produce an improvement in the display.

**3.12 Setting the Display of the Map**

It is possible to display a map which was edited previously on this radar indicator (according to Section 12) or which was transferred from another item of equipment in the system (according to Section 22.5).

Display of the map takes place as an alternative to display of the Electronic Chart. On the CHARTRADAR, for this purpose, it is necessary to switch over to Radar Display Mode.

The map can contain not only lines (for land contours, channel limits etc.) but also various symbols (for buoys, lights etc.). The symbols used are listed in Section 12. The symbols can be displayed either in outline mode, in paper chart mode or in simplified mode, whichever is selected.

**Switching the Display of the Map On and Off**

If there is a CHARTPILOT connected, switch over to Radar Display Mode, e.g. by means of the **RADAR MODE** key.

Click on the **MAP** button and then on the **VISIBLE** button

When the map is switched on, all objects which exist in the map contained in the radar system and are situated in the display area of the PPI are displayed.

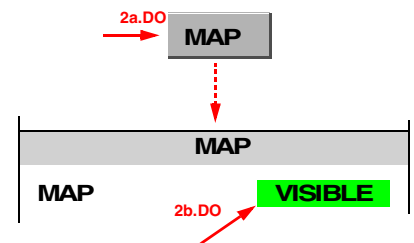

### Specifying the Display Mode of the Symbols

Click on the **MAP** button; then, behind **SYMBOLS**, select the display type:

**PAPER CHART** symbols correspond to the symbols used on paper charts.

The **OUTLINE** symbols derived from the PAPER CHART symbols do not have any filled-in areas.

**SIMPLIFIED** symbols are optimised for the electronic display of maps, and comply with the ECDIS rules, but they are displayed transparently so that radar echoes situated underneath them remain visible.

 During radar observation, the **OUTLINE** symbols should be used, because they do not hide too much of the radar echoes.

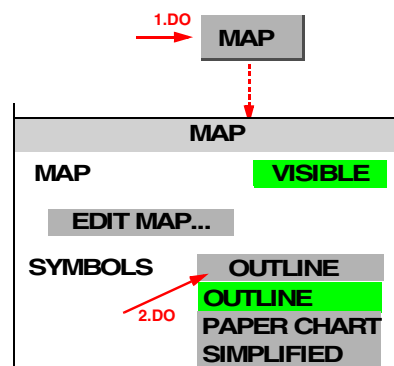

## 3.13 Adjusting the Chart or Map to the Radar Video

If the majority of the symbols of the Electronic Chart are displaced relative to their radar echoes of these targets, it can be assumed that the position transferred from the selected position sensor is incorrect.<sup>1)</sup>

If no position data having greater accuracy are available, then the Electronic Chart together with the User Chart Objects and the map can be shifted in such a way that symbols and the associated echoes coincide. This correction is described on [page 62](#).

 Rotation of the entire video relative to the map indicates that the heading value is incorrect. The cause of this might be a faulty compass, or else non-synchronous transfer of the course (for synchronisation of the course transfer, see [page 57](#)). However, errors of this kind also occur also if the compass does not perform a speed error correction or no dynamic correction; these faults should then be corrected in the compass system, if possible.

<sup>1)</sup> If symbols of the User Chart objects or the symbols of the map are displaced relative to their radar echoes of these targets, it must be considered whether the positions of these symbols have been entered incorrectly.

## 4 Setting the Radar Function

### Subjects of this Section:

- ◆ Switching the radar function on
- ◆ Transceiver selection
- ◆ Defining the master/slave function
- ◆ Switching the radar function off (switching to stand-by)
- ◆ Setting the radar signal:
  - Tuning the frequency (TUNE)
  - Input amplification (GAIN)
  - Sea clutter suppression (SEA)
  - Rain clutter suppression (RAIN)
  - Clean sweep function
  - Interference rejection (IR)
  - Pulse length
- ◆ Selection of antenna revolution rate
- ◆ Suppression of synthetics and video
- ◆ Special radar-settings (HSC, SART detection, RACON identification)

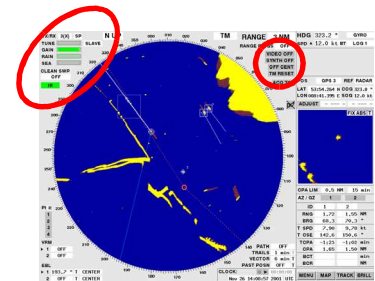

### 4.1 Radar Function On/Off, Interswitch Functions, Master/Slave Switch-Over

On any radar indicator, any transceiver of the system can be switched to act as the master. On the master indicator, the radar is operated completely, i.e. both the transmitter side and the receiver side.

Any radar indicator can also be switched to act as a slave of any transceiver that is operating. On the slave indicator, most of the functions on the reception side can be set independently of the master <sup>1)</sup>.

#### Switch-On of Radar Operation

##### **DANGER:**

**At the instant of switch-on of the radar function, the antenna begins to rotate and the emission of high frequency radiation <sup>2)</sup> is started. In the case of multiple installations, it can also happen that, instead of the expected antenna, a different one begins to rotate. Therefore, it must be ensured beforehand that the antennas can rotate freely and that there is nobody present close to the antenna turning circles.**

The radar transceiver selected last is switched to radar operation by clicking into the transceiver area and then clicking on the transceiver designation that is displayed.

If the selected transceiver was already running in radar operation mode, the result is that the indicator being operated becomes the slave indicator. <sup>3)</sup>

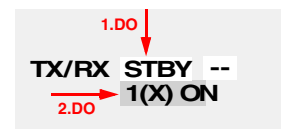

<sup>1)</sup> Tuning, sea clutter suppression, pulse length (and also the antenna revolution rate) are defined only on the master indicator.

<sup>2)</sup> For the danger posed by high frequency radiation, see [page 4](#).

<sup>3)</sup> A slave indicator is marked as such by the entry **SLAVE** behind the **TUNE** area.

If some other transceiver is to be switched on, this is done as follows:

### Selecting a Radar Transceiver

If you click into the transceiver area by means of the MORE key, the numbers of the installed transceivers are listed, together with the information as to whether they are X-Band or S-Band transceivers and a statement of the antenna position <sup>1)</sup>. By clicking, you can specify which transceiver is to be operated from that indicator.

If the transceiver on which you have clicked is not yet in radar operation mode, this action switches it into radar operation mode and the indicator being operated becomes the master indicator.

If the transceiver on which you have clicked was already in radar operation mode, this action switches the indicator being operated so that it acts as a slave indicator of that transceiver.

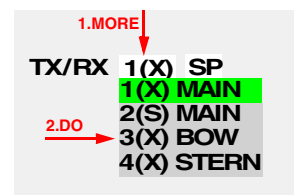

### Switching a Slave Indicator so that it Becomes the Master

On the slave indicator, click into the transceiver area and then click on **MASTER**.

As a result, the previous master indicator becomes a slave.

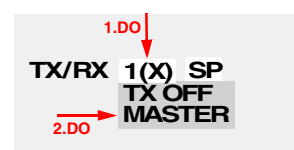

### Switching the Indicator to Stand-By Mode

Click into the transceiver area, and then click on **TX OFF**.

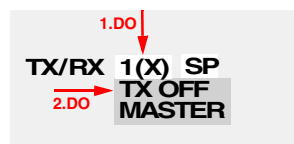

### Switching the Transceiver into Stand-By Mode

If the last indicator which is switched to the transceiver is switched into Stand-By mode, this action switches the transceiver too into Stand-By mode.

## USEFUL INFORMATION

### Danger Posed by High Frequency Radiation

There is no international agreement about the danger posed by high frequency radiation of the kind produced by the radar antenna. In most countries, a radiation density exceeding 100 W/m<sup>2</sup> is considered to be dangerous; in some countries, values over 10 W/m<sup>2</sup> are regarded as not being completely safe.

The distances from the various antennas at which the radiation density is 100 W/m<sup>2</sup> and 10 W/m<sup>2</sup> are stated on [page 3](#).

 The rotation of the antenna is monitored. If, because of a defect or the use of the antenna safety switch, the antenna stops rotating, the transceiver is automatically switched off.

<sup>1)</sup> The designations of the antenna positions can be freely edited at service level.



## 4.2 Basic Setting of the Radar Video

So that radar targets can be detected with certainty, an optimum setting of the radar video is of fundamental importance.

**WARNING:**

An optimum setting of the video is not only important for a clear visual display of the targets on the video but is also a necessary prerequisite for the EPA and ARPA functions.

Especially in the case of heavy rain and/or a rough sea, it is essential that the setting be adapted by trained personnel so that it is suitable for the situation.

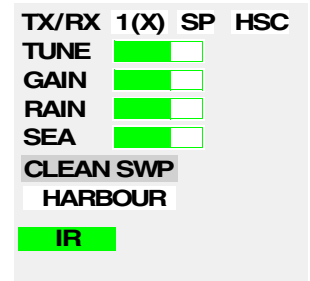

In the following, there is a description of how to set the video of a radar correctly on the master indicator. Only after these settings have been made on the master indicator can activated slave indicators too be set in the same way (parameters that cannot be set on slave indicators are pointed out).

1. Select the 12 NM display range.
2. **Tuning (adjustment of the frequency)** (can be set on the master indicator only)

**Automatic tuning:** With the MORE key, click into the **TUNE** area; then click on **AFC** (Automatic Frequency Control).

☞ If two X-Band or two S-Band systems are being operated simultaneously, disturbance of automatic tuning might occur (if it is being used). In such cases, manual tuning is appropriate.

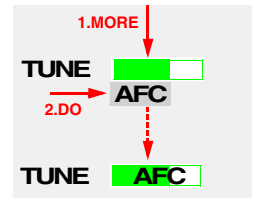

**Manual tuning:** Click into the **TUNE** field. As a result, a window opens in which a setting bar is displayed. With the trackball, set the display bar of the **TUNE** indication to its maximum value and press the DO key.

☞ In the case of manual tuning, the length of the bar in the **TUNE** area corresponds to the amplitude with which the input signal is available for signal processing. Observe more than one antenna rotation to find the maximum.

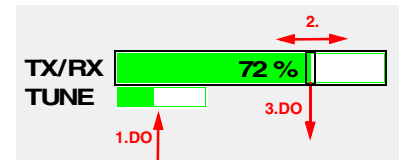

3. **Gain (input amplification)**  
Click into the **GAIN** area, and increase the value by means of the trackball until slight noise is visible on the PPI. Then reduce the value a little until the noise has just disappeared and no more. Then press the DO key.
4. Select the desired **display range**.
5. **Anticlutter Sea (sea clutter suppression)**

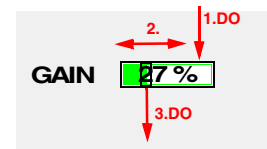

With Anticlutter Sea, the input amplification at close range is reduced depending on the distance.

**WARNING:**

In the case of Anticlutter Sea values that are too large, weak targets can be lost, especially at close range.

If the sea is very rough, it can be expected that radar targets which only produce weak reflections will remain undetected, even if the setting is correct.

**Manual suppression of sea clutter:** Click into the **SEA** area and set the value by means of the trackball so that the clutter caused by a rough sea is as weak as possible but radar targets are still clearly visible. Then press the DO key.

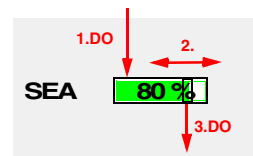

If the Clean Sweep function is switched on, the radar requires several revolutions of the antenna in order to adjust itself to changed Anticlutter Sea values. Therefore, any large changes should only be made slowly (step by step).

**Automatic suppression of sea clutter:** With the MORE key, click into the **SEA** area, and then click on **AUTO**.

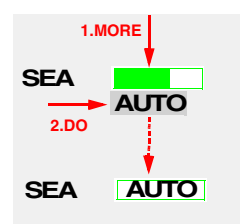

The automatic Anticlutter Sea function has the advantage that the clutter values taken into account in the upwind direction are different from those taken into account in the downwind direction.

To check the display of very small target-echoes, it is necessary to switch over to manual operation.

## 6. Anticlutter Rain (suppression of rain clutter)

**WARNING:**

In the case of heavy rain, snow and hail, it can be expected that, even if the setting is correct, radar targets which only produce weak reflections - especially targets situated behind a strong rain front - will remain undetected. Such targets can appear suddenly when leaving the rainy area.

**Manual suppression of rain clutter:** Click into the **RAIN** area, and set the value by means of the trackball so that the boundary of the rainy area is clearly visible and the clutter in the region behind it is as weak as possible. However, radar targets should still be clearly visible. Then press the DO key.

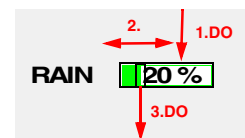

If (on the open sea) there are no radar targets available, set the rain clutter suppression function so that the boundary of the rainy area is clearly visible and the clutter in the region behind it is as weak as possible.

**Automatic suppression of rain clutter:** With the MORE key, click into the **RAIN** area, and then click on **AUTO**.

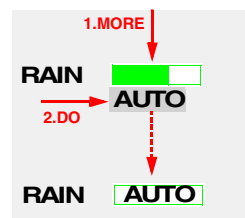

The automatic Anticlutter Rain function has the advantage that it takes place individually for regions with widely differing precipitation.

To check the display of very small target-echoes, it is necessary to switch over to manual operation.

**7. Clean Sweep**

In addition to the Anticlutter Sea and Anticlutter Rain settings already described, individual adaptation to the various environmental conditions is possible with the aid of the Clean Sweep function.

When the Clean Sweep function is switched on, **Scan-to-Scan Correlation** always takes place additionally. This performs a comparison between the sets of radar information from several revolutions of the antenna, and suppresses non-correlating signals.

☞ When the Clean Sweep function is running, the Scan-to-Scan Correlation might have the result that small, fast-moving targets are displayed with reduced intensity.

**Switching the Clean Sweep Mode on and off:** Click on the area CLEAN SWP.

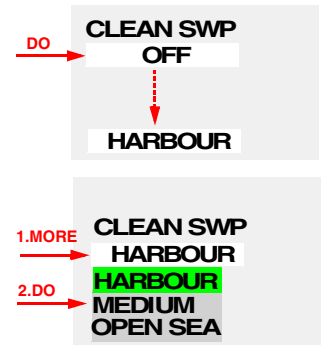

**Selecting the Clean Sweep Mode:** Click on the CLEAN SWP area by means of the MORE key, and then click on the desired mode (with the DO key).

☞ After any change in the Clean Sweep setting, you should adjust the gain setting.

By means of the three available Clean Sweep Modes, the video presentation can be improved to suit the given situation:

**HARBOUR**

Near your own ship <sup>1)</sup>, extremely small target-echoes (which would otherwise only be the size of a single pixel) are enlarged to such an extent that, if observed carefully, they become visible.

**Use:**

- In harbours, fjords, canals and other voyage regions having large land masses in the immediate vicinity
- On the open sea in good to medium weather conditions

**MEDIUM**

1. Echoes from targets which are situated near your own ship <sup>1)</sup> are displayed in highly enlarged form; see also [page 108](#).

☞ If the echoes are too small, set the pulse length to LP (Long Pulse).

2. An adaptive Anticlutter Sea function is switched on additionally. As a result of this function, the decluttering of regions with widely differing intensities of sea clutter takes place individually. This function is optimised for the display of coastlines.

**Use:** Within coastal areas; on the open sea in good to medium weather conditions

**OPEN SEA**

Same as MEDIUM, except that the adaptive Anticlutter Sea function is optimised for the display of single targets. The Anticlutter Rain function is improved. Particularly good results in the case of Long Pulse operation.

**Use:** On the open sea in all weather conditions

**8. Interference Rejection (IR)**

Interference caused by other radars (see [page 110](#)) can usually be eliminated by switch-on of the Interference Rejection function. This function is switched on and off by clicking on the IR area.

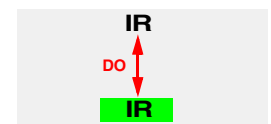

<sup>1)</sup> Up to a distance of one third of the selected range

### 9. Pulse length

After switch-over to a smaller display-range, check whether a better display is obtained by switching to a different pulse length. Switching is done by clicking on the pulse length area (**SP** = Short Pulse, **LP** = Long Pulse).

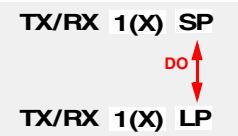

### Orientation values for settings on the open sea

#### Up to sea state 3 - 4, no rain

Gain	90% - 100%
Anticlutter sea	20%
Anticlutter rain	30%
Clean sweep	OPEN SEA
Interference rejection	On
Pulse length	SP

#### Up to sea state 3 - 4, rain medium to heavy

Gain	85% - 95%
Anticlutter sea	20%
Anticlutter rain	50% - 60%
Clean sweep	OPEN SEA
Interference rejection	On
Pulse length	SP or LP

#### Sea state 6 - 9, with rain

Gain	80% - 90%
Anticlutter sea	30% - 50%
Anticlutter rain	40% - 50%
Clean sweep	OPEN SEA
Interference rejection	On
Pulse length	LP

## 4.3 Selection of the Antenna Revolution Rate

In order to increase the update rate of the radar video, the antenna revolution rate can be doubled <sup>1)</sup>.

Switch-over is achieved by clicking on the **HSC** area (HSC = High Speed Craft; "HSC on" = doubling of the antenna revolution rate).

A disadvantage of the high revolution rate of the antenna is the unavoidably higher rate of wear and tear on the antenna gearbox.

On vehicles classified as High Speed Craft, the high revolution rate is a legal requirement. Therefore, on such vessels, the possibility of switching over to the lower revolution rate is not provided.

Grey area = normal revolution rate



Coloured area = high revolution rate

<sup>1)</sup> If the appropriate antenna gearbox is installed. Switching over is possible if the HSC area is present.

## 4.4 Radar Setting for High Speed of Own Vessel (HSC)

1. To prevent blurring of the video, the mode "TM Mode" and "North-Up" or "Course-Up" should be switched on.
2. To reduce the risk of loss of target, the **CLEAN SWEEP** function must be switched off. The risk of loss of target is also increased by fast course-maneuvres performed by own vessel.
3. Target tracking must already begin at long range. In this connection, it must be noted that the target data are correspondingly less accurate - see [Distortions of the Radar Video](#) on [page 108](#).

## 4.5 Radar Setting for the Display of RACON Codes

The code of Racons consists of a radially arranged dash-dot code which begins in the radar video a short distance behind the beacon position. By means of different codes described in the Lists of Lights, the approach points equipped with Racons can be clearly identified.

Most Racons transmit in the X-Band, but there are some Racons installed which transmit in the S-Band. The majority of Racons change their transmission frequency slowly throughout the entire frequency band, and so they are not received in every revolution of the antenna.

For the setting of the radar, the same basic principles are applicable as for SART detection.

## 4.6 Radar Setting for SART Detection (X-Band only)

The information needed for reliable detection of SART's is described in IMO Circular 161. The content of that paper is reproduced on the following pages.

## 4.7 Suppression of the Synthetics and Video

### Suppression of Synthetics

So that a video signal which has a synthetic image (e.g. a target symbol) superimposed on it on the PPI can be assessed more satisfactorily, the display of the entire synthetics can be suppressed. This occurs for as long as the DO key is kept pressed in the **SYNTH OFF** area.

 See also [Displaying User Chart Objects Temporarily on Top of the Radar Video](#) on [page 41](#).

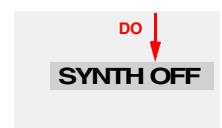

### Suppression of Video

So that the synthetics can be recognised better in the case of superimposition of video signals, the entire video display can be suppressed. This occurs for as long as the DO key is kept pressed in the **VIDEO OFF** area.



## ANNEX

### OPERATION OF MARINE RADAR FOR SART DETECTION

WARNING: A SART will only respond to an X-Band (3 cm) radar. It will not be seen on an S-Band (10 cm) radar.

#### Introduction

1. A Search and Rescue Transponder (SART) may be triggered by any X-Band (3 cm) radar within a range of approximately 8 n.miles. Each radar pulse received causes it to transmit a response which is swept repetitively across the complete radar frequency band. When interrogated, it first sweeps rapidly (0.4  $\mu$ sec) through the band before beginning a relatively slow sweep (7.5  $\mu$ sec) through the band back to the starting frequency. This process is repeated for a total of twelve complete cycles. At some point in each sweep, the SART frequency will match that of the interrogating radar and be within the pass band of the radar receiver. If the SART is within range, the frequency match during each of the 12 slow sweeps will produce a response on the radar display, thus a line of 12 dots equally spaced by about 0.64 n.miles will be shown.

2. When the range to the SART is reduced to about 1 n.mile, the radar display may show also the 12 responses generated during the fast sweeps. These additional dot responses, which also are equally spaced by 0.64 n.miles, will be interspersed with the original line of 12 dots. They will appear slightly weaker and smaller than the original dots.

#### Radar Range Scale

3. When looking for a SART it is preferable to use either the 6 or 12 n.mile range scale. This is because the total displayed length of the SART response of 12 (or 24) dots may extend approximately 9.5 n.miles beyond the position of the SART and it is necessary to see a number of response dots to distinguish the SART from other responses.

#### SART Range Errors

4. When responses from only the 12 low frequency sweeps are visible (when the SART is at a range greater than about 1 n.mile), the position at which the first dot is displayed may be as much as 0.64 n.mile beyond the true position of the SART. When the range closes so that the fast sweep responses are seen also, the first of these will be no more than 150 metres beyond the true position.

#### Radar Bandwidth

5. This is normally matched to the radar pulse length and is usually switched with the range scale and the associated pulse length. Narrow bandwidths of 3-5 MHz are used with long pulses on long range scales and wide bandwidths of 10-25 MHz with short pulses on short ranges.

6. A radar bandwidth of less than 5 MHz will attenuate the SART signal slightly, so it is preferable to use a medium bandwidth to ensure optimum detection of the SART. The Radar Operating Manual should be consulted about the particular radar parameters and bandwidth selection.

Note about item 6: The bandwidth of the radar is not less than 5 MHz. Therefore, the setting described here is not necessary.

**Radar Side Lobes**

7. As the SART is approached, side lobes from the radar antenna may show the SART responses as a series of arcs or concentric rings. These can be removed by the use of the anti-clutter sea control although it may be operationally useful to observe the side lobes as they may be easier to detect in clutter conditions and also they will confirm that the SART is near to own ship.

**Detuning the Radar**

8. To increase the visibility of the SART in clutter conditions, the radar may be detuned to reduce the clutter without reducing the SART response. Radars with automatic frequency control may not permit manual detune of the equipment. Care should be taken in operating the radar in the detuned condition as other wanted navigational and anti-collision information may be removed. The tuning should be returned to normal operation as soon as possible.

**Gain**

9. For maximum range SART detection the normal gain setting for long range detection should be used i.e., with a light background noise speckle visible.

**Anti-Clutter Sea Control**

10. For optimum range SART detection this control should be set to the minimum. Care should be exercised as wanted targets in sea clutter may be obscured. Note also that in clutter conditions the first few dots of the SART response may not be detectable, irrespective of the setting of the anti-clutter sea control. In this case, the position of the SART may be estimated by measuring 9.5 n.miles from the furthest dot back towards own ship.

11. Some sets have automatic/manual anti-clutter sea control facilities. Because the way in which the automatic sea control functions may vary from one radar manufacturer to another, the operator is advised to use manual control initially until the SART has been detected. The effect of the auto sea control on the SART response can then be compared with manual control.

**Anti-Clutter Rain Control**

12. This should be used normally (i.e. to break up areas of rain) when trying to detect a SART response which, being a series of dots, is not affected by the action of the anti-clutter rain circuitry. Note that Racon responses, which are often in the form of a long flash, will be affected by the use of this control.

13. Some sets have automatic/manual anti-clutter rain control facilities. Because the way in which the automatic rain control functions may vary from one radar manufacturer to another, the operator is advised to use manual control initially until the SART has been detected. The effect of the auto rain control on the SART response can then be compared with manual control.

**Note:**

The automatic rain and sea clutter controls may be combined in a single 'auto-clutter' control, in which case the operator is advised to use the manual controls initially until the SART has been detected, before assessing the effect of auto.





## 5 Heading, Speed, Position

### Subjects of this Section:

- ◆ Synchronisation of the gyro compass (Set Gyro)
- ◆ Selection of the speed sensor
- ◆ Specifying whether Speed Through the Water (STW) or Speed Over Ground (SOG) is to be used
- ◆ Input for the Reference Target Speed mode
- ◆ Manual input of speed
- ◆ Input of drift and set
- ◆ Selection of the position sensor
- ◆ Manual correction of the position

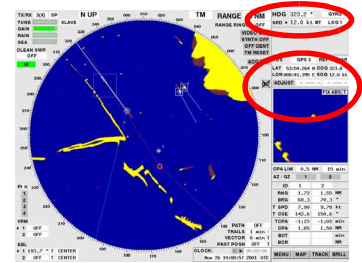

### CAUTION:

The right choice of navigation sensors, the right setting of the navigation data and a continuous overview of the status of the selected navigation sensors are very important for safe navigation.

In the case of multiple installations, the settings described in the following only have to be made on one of the radar indicators. All components of the system are automatically supplied with the navigation data resulting from the settings made on any desired radar indicator. This also applies to the CHARTPILOT, if there is one.

## 5.1 Compass

For the transfer of the heading information, a technique is often used which transfers heading changes only, and not the absolute value. Therefore, in such cases, after switch-on of the radar system and after failure of the signal transfer, the synchronism of the heading transfer process must be checked and, if necessary, corrected.

### Display of the Heading Value Used

The heading value currently being transferred from the compass and used in the entire radar system is displayed in the **HDG** area.

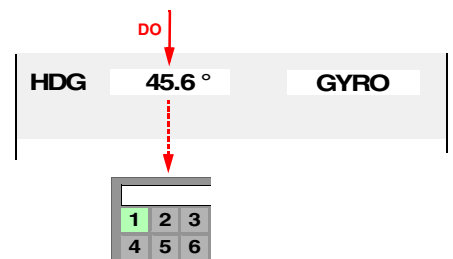

### Synchronisation of the Heading Transfer

Click on the Heading area and, by means of the virtual keyboard, enter the value displayed by the gyro compass.

- ☞ If the ship is yawing, click on the OK button of the virtual keyboard when the heading displayed on the compass has the same value as the value entered on the virtual keyboard.

If the course transfer takes place by means of a serial interface (e.g. according to IEC 61162), the heading value cannot be changed.

## 5.2 Speed Sensor

There may be several speed sensors connected to the radar system. One of them has to be chosen. In the case of speed sensors which transfer the longitudinal speed only, the drift and set can be entered manually. As an alternative to selection of a speed sensor, it is also possible to input the speed manually, if necessary. If fixed radar-targets are available, the speed can be determined by Reference Target Tracking.

 The speed sensors also include position sensors which transfer not only the position but also the speed and course made good. Compared to the present-day state of the art, they generally do not meet the IMO Performance Standards for SDME (Speed and Distance Measuring Equipment). Therefore, they might not be configured in the system, and so it might not be possible to select them for speed input.

### Display of the Speed Data Used

In the **SPD** line, the speed data used in the system are displayed: longitudinal speed, Bottom Track / Water Track status, and the selected sensor.

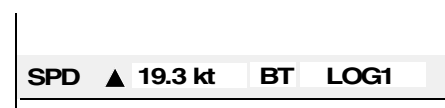

 If the longitudinal speed is computed taking account of data that are entered manually (e.g. Set+Drift), the value has a yellow background.

### Selection of the Speed Sensor

1. Click on the speed sensor area. The list of speed sensors appears. <sup>1)</sup>

2. Preselect the desired sensor by clicking. The data transferred from this sensor are then displayed in the Multidisplay. <sup>2)</sup>

3. Check the sensor data for plausibility.

Check the supplementary values which might be suggested by the system (depending on the type of sensor preselected - see below). <sup>3)</sup>

4. The sensor is selected by clicking on the **SELECT** button.

 If a different sensor is to be preselected, this can be done in the Multidisplay after clicking on the displayed sensor.

 By clicking on the **CANCEL** button, the sensor previously selected remains selected; values entered in the Multidisplay are not taken over.

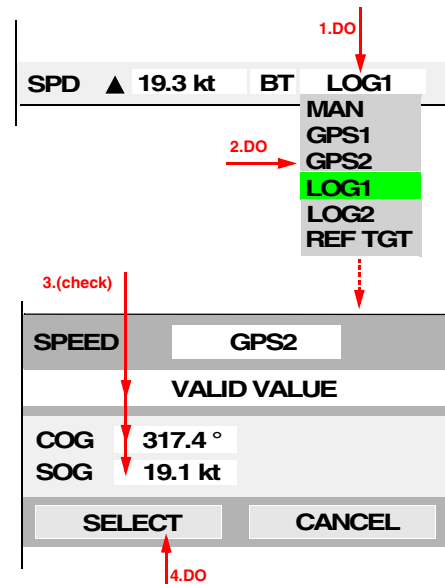

<sup>1)</sup> If there are several sensors of the same type connected to the system, they are each given a sequential number in addition to the statement of sensor type.

<sup>2)</sup> The display indicating whether the speed displayed is over ground or through the water depends on the sensor:

- COG/SOG or SPD + BOTTOM TRACK = speed over ground
- SPD + WATER TRACK = speed through the water.

<sup>3)</sup> The supplementary values suggested are computed by the system in such a way that, when they are taken over, no change occurs in the longitudinal and transverse speeds.

**Settings Depending on the Sensor Type**

**Dual-axis Logs, e.g. ATLAS DOLOG 23**

The longitudinal speed measured is displayed behind **SPD▲**, and the transverse speed measured is displayed behind **SPD▶**. The triangles point in the direction of movement. If the speeds are measured both through the water and over ground, these data are also displayed.

If WT data (speed through the water) and BT data (speed over ground) are both available at the same time, the data whose field is marked in colour are used. Switching over is done by clicking on the **WT** or **BT** field; if the TRACKPILOT is in the activated state, this is possible only on the TRACKPILOT master.

<b>SPEED</b>		<b>LOG1</b>	
<b>BOTTOM TRACK</b>			
	<b>WT</b>		<b>BT</b>
SPD ▲	19.2 kt	▲	18.9 kt
SPD ▶	1.50 kt	▶	1.23 kt

**Single-Axis Logs, e.g. EM Log DEBEG 4675**

The longitudinal speed measured by the preselected log is displayed behind **SPEED**.

The **SET** and **DRIFT** values displayed as a suggestion have been selected such that, together with the longitudinal speed measured by the preselected log, the same speed vector is obtained as the one used previously.

☞ If a drift value (not equal to zero) is entered, the log, as soon as it is selected, is interpreted as being in Bottom Track mode. If the previously selected sensor measured the speed through the water (two-axis log in WT mode), the values must be corrected to take account of the effect of the existing current.

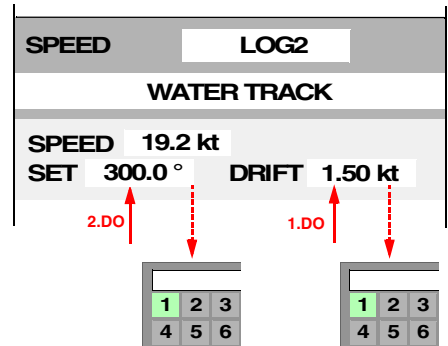

Manual input takes place after clicking on the **DRIFT** or **SET** field by means of the virtual keyboard.

**Sensors which Determine the Speed from Position Data, e.g. GPS, Reference Target Tracking**

The status transferred from the sensor is displayed.

The measured course over ground is displayed behind **COG**, and the measured speed over ground is displayed behind **SOG**.

<b>SPEED</b>		<b>DGPS</b>	
<b>VALID VALUE</b>			
COG	317.4 °		
SOG	19.1 kt		

**Manual Input of Speed (MAN)**

Behind **SPEED**, the longitudinal speed currently known to the system (from the speed sensor selected previously) is entered; if necessary, change the value by means of the virtual keyboard after clicking on the **SPEED** field.

For the set and drift, the same applies as for the single-axis log - see above.

<b>SPEED</b>		<b>MAN</b>	
<b>VALID VALUE</b>			
SPEED	19.2 kt		
SET	300.0 °	DRIFT	1.50 kt

## 5.3 Position Sensor

There are often several position sensors connected to the system. One of them has to be selected. As an alternative to selecting a position sensor, it can - if necessary - also be specified that the system position is to be determined on the radar by dead reckoning (EP = Estimated Position) using the gyro heading and the speed data of the selected speed sensor.

After the position sensor has been selected, the accuracy of the position data must be checked continuously. Constant errors in the transferred position can be compensated manually.

### General Remarks about Position Data

On the radar, it is basically necessary to distinguish between the following positions:

1. **System position:** The display is shown in the position display when the cursor is situated outside the PPI. "System position" is normally defined as a position in the forward part of the ship - usually the location of the transducer of the DOLOG or of another installed log.
2. **Reference position for bearings:** All displays relating to own position (own ship symbol, VRM/EBL, range/bearing of the cursor position, CPA/TCPA) refer to the antenna position of the radar that is being operated. This is made clear in the Position Display by the entry **REF RADAR**.
  - ☞ There is no LAT/LON display of this position, but in the small display-ranges the LAT/LON values can be read off as the cursor position if the cursor is moved to the radar origin.
3. **Cursor position:** The display is shown in the position display when the cursor is situated within the PPI. This display indicates the absolute geographical position.

All LAT/LON values are based on the geodetic datum "WGS 84".

☞ Important: Only position receivers may be connected to the radar system that output the position values in the geographical reference system WGS 84 via an interface as per IEC 61162-1 <sup>1)</sup>.

### Display of the Position Data Used

In the Position Display, the position data used in the system are displayed:

- Behind **POS**: the selected position sensor.
- Behind **LAT** and **LON**: the system position.
- Behind **COG** and **SOG**: the values of course and speed over ground that are transferred from the selected speed sensor.
- Behind **ADJUST**: the value of the manual position-correction in metres N/S and W/E,

☞ If a manual position-correction has been entered, the **LAT** and **LON** values have a yellow background.

<b>POS</b>	<b>GPS1</b>	<b>REF</b>	<b>RADAR</b>
<b>LAT</b>	55:35.285 N	<b>COG</b>	51.6 °
<b>LON</b>	008:36.437 W	<b>SOG</b>	18.3 kt
<b>ADJUST</b>	-----		-----

<sup>1)</sup> IEC 61162-1 largely corresponds to NMEA 0183 Version 2.30 of 1st March 1998.

**Selection of the Position Sensor**

1. Click on the position sensor area. The list of the connected position sensors appears. <sup>1)</sup>
2. Preselect the desired sensor by clicking. The position received from this sensor, manually corrected if necessary (for correction of a constant position-error, see [page 62](#)), is then displayed in the Multidisplay.
3. Furthermore, the bearing (**BRG**) and range (**RNG**) to the position determined by the sensor that has been called up are displayed in the Multidisplay.  
Check whether the values displayed are plausible.
4. By clicking on the **SELECT** button, the sensor is selected.
  - ☞ If a different sensor is to be preselected, this can be done in the Multidisplay after clicking on the displayed sensor.
  - ☞ By clicking on the **CANCEL** button, the sensor previously selected remains selected.

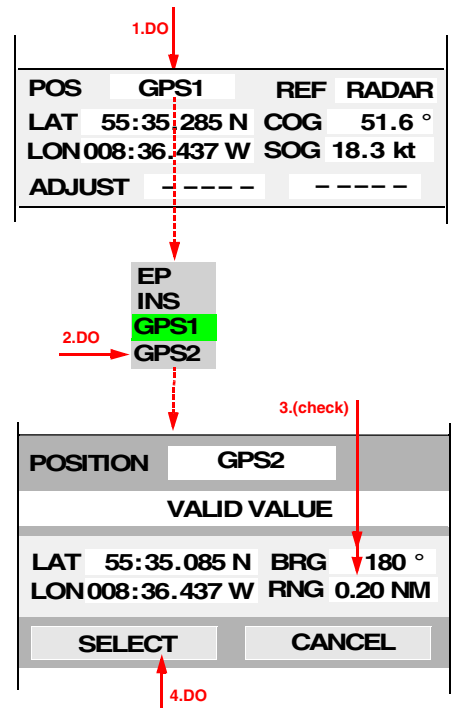

**Using Dead Reckoning to Determine the Position**

If there is no position sensor available, or if the data from the position sensor are invalid or faulty, the only remaining possibility of determining the position is the dead reckoning method, using the gyro heading, the data from the selected speed sensor, and the drift value if such a value is entered.

**WARNING:**

**The accuracy of the dead-reckoned position (display: EP) must be checked continually. For safety reasons, an available position-sensor must be selected as soon as possible.**

The dead reckoning process is switched on in the same way as the selecting of a position sensor - see above. During this process, the "position sensor" **EP** (= Estimated Position) must be selected. The special feature is that, if **EP** is preselected, the starting position displayed in the Multidisplay can be changed. The dead reckoning process begins with this position after pressing of the **SELECT** button.

**Specifying the Use of the GPS Mode**

If a DGPS receiver is selected, it can be specified whether the received position is only to be used when the receiver is operating in differential mode.

Click on the **MENU** button, and then click on **USER SETTINGS**.

If the position data of a DGPS receiver operating in GPS mode (i.e. if differential mode is not possible) are not to be used, the function **DGPS ONLY** must be switched on.

If the position data are to be used even when the differential mode has failed, the function **DGPS ONLY** must be switched off.

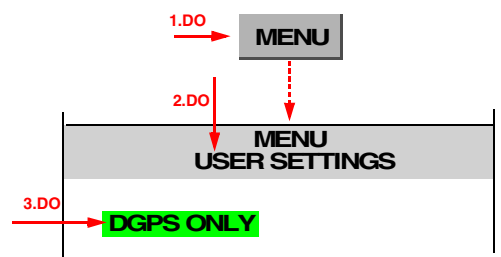

<sup>1)</sup> If there are several sensors of the same type connected to the system, they are each given a sequential number in addition to the statement of sensor type.

### Check of the Accuracy of the Position Data

In the PPI, any inaccuracy in the position data causes displacement between

- the own ship symbol and the radar video on the one hand, and
- the tracks and the maps on the other hand.

The position used by the radar is normally accurate enough if the symbols of a map that may have been generated for this purpose coincide with the videos of the radar targets when the display range is set to a small value.

### Correction of a Constant Position-Error (Position Offset)

If the displayed position is incorrect, the videos of fixed point-targets (e.g. buoys) do not coincide with the symbols of these targets that are entered at the correct positions in a map. The position error is corrected manually by making the video of a fixed target coincide with its map symbol:

1. Switch on a sufficiently small radar range.
2. Click on the **ADJUST** button. By flashing, the button indicates that the cursor in the PPI now has a special function.
3. Click on a map symbol whose radar echo is clearly recognisable and identifiable.

POS	GPS1	REF	RADAR
LAT	55:35.285 N	COG	51.6 °
LON	008:36.437 W	SOG	18.3 NM
ADJUST	-----	-----	-----

DO ↑

If the cursor is now moved, the distances of the cursor position from the clicked symbol in the north/south and east/west directions are displayed behind the **ADJUST** button.

4. Click on the radar echo of the map symbol on which you have clicked. As a result, the correction values displayed behind the **ADJUST** button (= position offset) take effect and is added to the position of the sensor.

☞ The entire track and map synthetics move by an amount equal to the position offset. The position offset that is entered continues to be displayed behind **ADJUST**.<sup>1)</sup>

☞ In this way, each direction can be corrected by up to 999 m.<sup>1)</sup>

5. Check that the other symbols of the map too now coincide as well as possible with their radar echoes. If necessary, processes 2 to 4 can be repeated on the basis of the position offset that exists at that time.

☞ If the entire video has a rotational displacement relative to the map, this indicates that there is probably a compass error. Either the synchronisation with the compass system is inadequate (this must then be corrected – see page 57) or the compass system itself has a static or dynamic course error. This should, if possible, be corrected in the compass system.

### Deleting the Position Offset

The position offset is deleted automatically as soon as a different position-sensor is selected.

The position offset is deleted manually by clicking on the **ADJUST** button by means of the MORE key and by then clicking **RESET ADJUST** by means of the DO key.

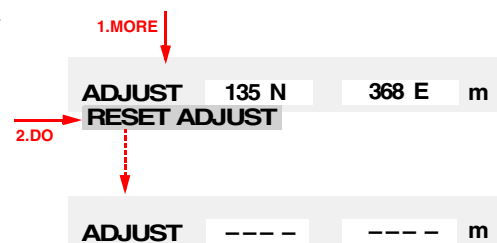

<sup>1)</sup> If the EP position is being used, the position data are modified by an amount equal to the position offset. No limitation takes place.

## 6 Bearing and Range

### Subjects of this Section:

- ◆ Measurement of bearing and range with the cursor display
- ◆ Measurement of range with the variable range marker (VRM)
- ◆ Measurement of bearing by means of the electronic bearing lines (EBL's)
- ◆ Parallel indexing by means of parallel index lines (PI)

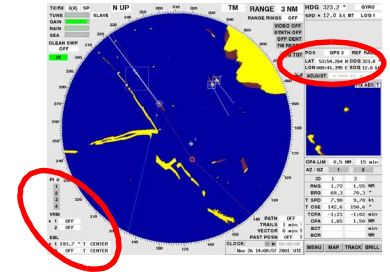

### 6.1 Cursor Display

The bearing and range of an object with respect to own ship can most easily and quickly be read off on the cursor display:

As soon as the cursor is situated in the PPI, the cursor position instead of the own ship position is shown in the position display. **T CURS** (instead of **POS**) then appears in the position display.

<b>T CURS</b>	<b>REF RADAR</b>
<b>LAT 55:35.285 N</b>	<b>BRG 51.6 °</b>
<b>LON 008:36.437 W</b>	<b>RNG 18.3 NM</b>
<b>ADJUST</b>	<b>-----</b>

Behind **BRG** (= bearing), the true bearing of the cursor position with respect to own ship is displayed, and behind **RNG** (= range) the distance from own ship's position to the cursor position is displayed.

- ☞ If the gyro compass fails, the relative bearing is displayed behind BRG. This is indicated by the fact that, instead of **T CURS** (**T** = true), the text **R CURS** (**R** = relative) appears in the heading of the cursor display.

The manually-entered correction value which is taken into account in the displayed position of the cursor (see page 62) is displayed behind **ADJUST**.

- ☞ The sailing time to the cursor position (TTG) and the time of arrival at the cursor position (ETA) are displayed in the Quick Info Box - see page 105.

### 6.2 Variable Range Markers (VRM's)

The radar has two VRM's, which can be adjusted independently of one another. With these markers, the distance from own ship or (in conjunction with the EBL) the distance between two objects can be measured.

<b>VRM</b>	
<b>1</b>	<b>2.00 NM</b>
<b>2</b>	<b>OFF</b>

A VRM that is switched on can be recognised from the fact that the distance is displayed in the VRM area. A VRM that is switched off is indicated by the word **OFF** in the VRM area.

### Switching the VRM On and Off

The display of the VRM is switched on and off by clicking on the desired VRM area.

- ☞ If the display range is reduced when the VRM is in the switched-on state, the VRM might be situated outside the visible range. If you switch the VRM off and then on again, it returns to the visible range.

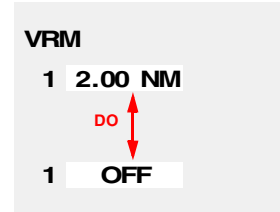

### Setting the Distance

Click on the VRM graphics in the PPI, drag it to the desired distance (e.g. to the object whose range is to be measured). The VRM is fixed by clicking again.

## 6.3 Electronic Bearing Lines (EBL's)

The radar has two EBL's, which can be adjusted independently of one another. With these EBL's, the bearing of an object with respect to own ship or the bearing between two objects can be determined.

An EBL that is switched on can be recognised from the fact that the bearing is displayed in the left-hand EBL-area. An EBL that is switched off is indicated by the word OFF in that area.

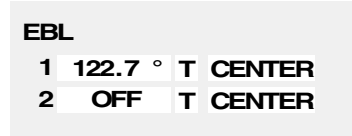

### Switching the EBL On and Off

The display of the EBL is switched on and off by clicking on the desired EBL data area.

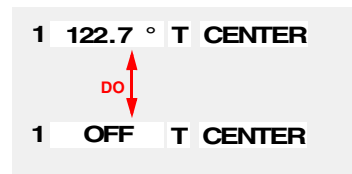

### Setting the Origin of the EBL

For the bearing with respect to own ship:  
Select **CENTER** in the right-hand EBL-area.

For the bearing between two objects:  
To set the EBL origin to a different position, in the PPI click on the EBL origin and position it at the desired place by clicking. In the right-hand EBL-area, select **FIX ABS** if the EBL origin is to be at a fixed position, or select **FIX REL** if the EBL origin is to move along together with own ship.

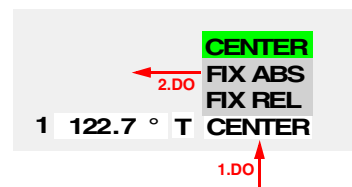

- ☞ The EBL remains intact even if the origin is situated outside the PPI. Switching on and off resets the origin of the EBL to your own ship.

### Setting the Bearing

Click on the EBL graphics in the PPI, set the desired direction, and fix it by clicking.



**Displaying the Relative Bearing**

**PPI Orientation North-Up and Course-Up:**

The values displayed are true bearings. This fact is indicated in the middle EBL-area by the letter **T** (= true). For as long as the DO key is kept pressed in this area, the relative bearing is displayed (indicated by **R** = relative).

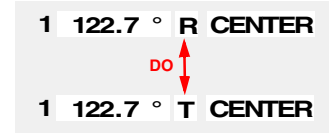

If the compass signal fails, the display is automatically switched over to relative bearing (R).

**PPI Orientation Head-Up:**

The values displayed are relative bearings. For as long as the DO key is kept pressed in this area, the true bearing is displayed.

**USEFUL INFORMATIONS**

**Latitude-Dependent Errors in the Display of the EBL**

With the type of projection used for the longitude/latitude grid in the radar, the parallels of latitude become more strongly curved with increasing latitude, while the meridians converge increasingly with increasing distance from the equator (i.e. the direction of a meridian at the edge of the PPI is not 0° - 180° but might be 358° - 182°); in other words, their directions no longer correspond to the degree scale at the edge of the PPI.

In contrast to this, the EBL is always displayed as a straight line; its bearing displayed as an EBL value has an error.

The following table shows the maximum errors for the various latitudes and range settings.

Distance of EBL from own ship	Geographical latitude			
	20 °	40 °	60 °	80 °
10 NM	< 0.1 °	0.1 °	0.3 °	0.9 °
20 NM	0.1 °	0.3 °	0.6 °	1.9 °
40 NM	0.2 °	0.5 °	1.2 °	3.8 °
60 NM	0.4 °	0.8 °	1.7 °	5.7 °
80 NM	0.5 °	1.1 °	2.3 °	7.5 °

**6.4 Operating the VRM and the EBL Jointly**

If the EBL origin is set to **CENTER**, then after clicking on the point of intersection of VRM1 and EBL1 or of VRM2 and EBL2, both elements are moved jointly.

**Measuring the Range and Bearing between Two Objects**

If the EBL1 origin is set to **FIX ABS** or **FIX REL**, a marker is displayed on EBL1 such that the distance of this marker from the EBL1 origin is equal to the value of VRM1. If you click on this marker, both VRM1 and EBL1 are changed by means of the cursor.

The same applies to EBL2 and VRM2.

By means of this procedure, the range and bearing between two objects can be measured: set the EBL origin on object 1 and drag the marker to object 2.

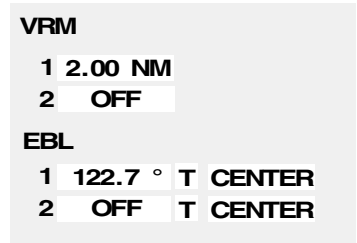

## 6.5 Parallel Index Lines

There are four parallel index lines available, which can be adjusted individually.

### Switching Parallel Index Lines On and Off

The parallel index lines can be switched on and off individually by clicking on their number displayed below **PI**.

 When you switch the parallel index lines on, they appear in the form in which they were set last. If the display range has been reduced in the meantime, they might be situated outside the visible range.

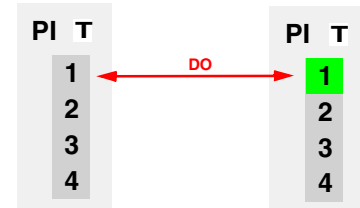

### Changing the Distance of a Parallel Index Line

Click on the parallel index line near the closest point of approach to own ship, drag it to the desired distance, and click again.

### Changing the Bearing of a Parallel Index Line

Click on the parallel index line near the compass rose, drag it into the desired direction, and click it again.

### Displaying Values of a Parallel Index Line

While the parallel index line is being operated on the PPI, its data appear in a dialog box:

**INDEX LINE** Number of the index line  
**RANGE** Distance from own ship (at the closest point of approach)  
**BEARING** Bearings (direction and opposite direction) of the index line

INDEX LINE 1	
<b>RANGE</b>	11.5 NM
<b>BEARING</b>	125.8 ° T
	305.8 ° T

### Switching the Bearing Display of the Parallel Index Lines to Relative or True

The display of the bearings of the parallel index lines can be switched over between true bearing (indicated by **T**) and relative bearing (indicated by **R**).

The switch-over is performed by clicking on the indication **T** or **R**.

 If the compass signal fails, the display is automatically switched to relative bearing (**R**).

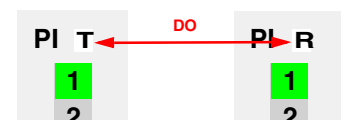

## 7 ARPA Functions





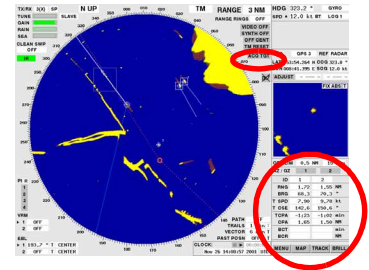



### Subjects of this Section:

- ◆ Symbols used
- ◆ Manual target acquisition
- ◆ Automatic target acquisition by means of acquisition/guard zone
- ◆ Automatic target tracking
- ◆ Deletion of targets, loss of target
- ◆ Target data display
- ◆ Target labels
- ◆ Selection of reference targets for reference target tracking





### 7.1 Symbols Used

Targets that have been acquired and are being tracked are provided with symbols indicating their track status. Targets being tracked can also be provided with speed vectors and with a past position plot as per [Section 3.6](#) (see [page 32](#)).

<b>Target acquired manually</b>	
<b>Target acquired automatically</b> (flashing) (target which has triggered the <b>TARGET IN AZ</b> alarm or the <b>TARGET IN GZ</b> alarm)	
<b>Target</b> (moving) being tracked	
<b>Fixed target</b> being tracked	
<b>Target with target label</b>	
Target with label as <b>reference target</b> (reference target tracking)	
<b>Dangerous target</b> (flashing) (target which has triggered the <b>DANGEROUS TGT</b> alarm)	
Target whose data are being displayed (symbol is displayed additionally)	
<b>Lost target</b> (flashing) (target which has triggered the <b>LOST TGT</b> alarm)	

## 7.2 Procedure of the Target Acquisition

The ARPA radar permits manual and automatic acquisition of up to 50 targets. For automatic target acquisition, there are two combined acquisition and surveillance zones <sup>1)</sup> available. Acquired targets are tracked automatically.

In the case of **manual target acquisition**, the target video is marked manually, and is thus initially provided with the dotted square . The radar then checks during the next three revolutions of the antenna to determine whether the echo occurs twice at this position. If it does, this target is tracked automatically by the radar. If it does not, the radar does not recognise any target at this position, and the **LOST TGT** alarm occurs. The target just acquired but lost is marked with the flashing symbol .



In the case of **automatic target acquisition**, the radar evaluates all radar echoes appearing in the acquisition/guard zones. If the echo appears at a certain position at least six times during ten revolutions of the antenna, it is evaluated as a radar target.

If the echoes do not belong to a target already being tracked, the position is treated as an acquired target and is marked with the flashing symbol . The alarm **TARGET IN AZ** appears, or - if the target was already being tracked when it entered the acquisition/guard zone - the alarm **TARGET IN GZ** appears. After acknowledgement of the alarm, the automatic target tracking begins.

 Automatic target acquisition is switched on and off together with the display of the acquisition/guard zone - see [page 69](#).

 If there are already 50 targets being tracked and another target is then acquired, the **AZ OVERFLOW** alarm appears. In this case, at least one non-critical target must first be deleted.

When the **automatic tracking** begins, the radar determines the movement of the target.

- If the absolute speed determined for the target is less than 1.5  $\kappa$ v, the target is classed as a fixed target; the symbol  appears.
- If the speed of the target exceeds 1.5 kt, it is classed as a moving target and is marked with the symbol .
- If the functions are switched on, also the speed vector is now displayed, the computation of collision risks is performed continuously, and the past position plot is built up.

The target is now tracked automatically until

- it is deleted manually or
- it is lost because, during five revolutions of the antenna, no correlation of the video can be found by the radar, or the detection probability falls below 50%, or
- it leaves the target tracking range of 20 NM.

If a target is lost, a **LOST TGT** alarm appears and the lost target is marked accordingly.

 The number of targets being tracked should be kept as small as possible; the presence of too many targets causes confusion on the screen and distracts the operator's attention from what is really important.

Targets that are no longer relevant should be deleted in order to minimise the number of **LOST TGT** alarms caused by targets leaving the radar range.

 In the case of tracked targets entering a clutter area (rain or sea clutter), a "target swap" might occur; parts of the rain front are suddenly being "tracked". A target swap can also occur if there are targets situated close together or close to land. In the case of target swaps, no warning is given.

### WARNING:

**Automatic target acquisition and tracking are ensured only if the radar video is OK, i.e. if it is adjusted in the same way as would also be necessary for visual evaluation.**

<sup>1)</sup> Called **acquisition/guard zone** in the following

**WARNING:**

Under particularly unfavourable meteorological conditions, it can happen even with an optimum setting of the radar that targets in the radar video cannot be detected automatically.

### 7.3 Manual Target Acquisition

1. Click on the **ACQ-TGT** button (= Acquire Target); the button flashes.
  2. Acquire the target video by clicking. For as long as the **ACQ TGT** button is flashing, more targets can be acquired in the same way.
  3. The acquisition function of the cursor is switched off by clicking into the PPI by means of the MORE key or by clicking again (with the DO key) on the **ACQ TGT** button.
-  When the 48th target is acquired, an indication appears, stating that only another two targets can be acquired. After the 50th target has been acquired, an indication appears, stating that no more targets can be acquired. Now at the latest, uncritical targets should be deleted.



### 7.4 Automatic Target Acquisition; Settings of the Acquisition/Guard Zone

Two acquisition/guard zones are available; they are independent of one another.

Each acquisition/guard zone consists of a segment of a circle which moves along with own ship as its centre. The depth of the segment is 1 NM in each case. Its diameter (range) and angle can be adjusted.

**Switching the Acquisition/Guard Zone On and Off**

The acquisition/guard zone is switched on and off by clicking on the area **1** or **2**.

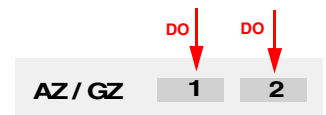

-  If the acquisition/guard zone is switched off, automatic target acquisition does not take place. Targets already acquired continue to be tracked.

**Setting the Range of the Acquisition/Guard Zone**

Click on the inner or outer limit of the acquisition/guard zone, drag the zone to the desired size, and press the DO key.

-  The outer limit can be set to a value between 1.1 NM and 20 NM.

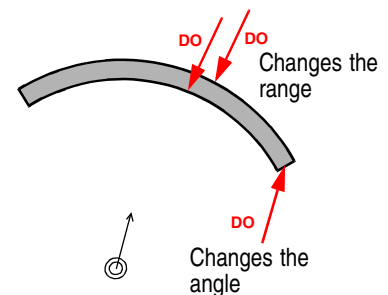

**Setting the Angle of the Acquisition/Guard Zone**

Click on a side limit of the acquisition/guard zone, drag the zone to the desired angle, and press the DO key.

-  The angle can be set to a value between 5° and 360°. The setting takes place relative to the heading direction, i.e. the acquisition/guard zone turns with the ship's heading.

## 7.5 Deletion of Targets, Loss of Target

### Deletion of a Target

Click on the target by means of the MORE key, and then click on **DELETE TARGET** (with the DO key).

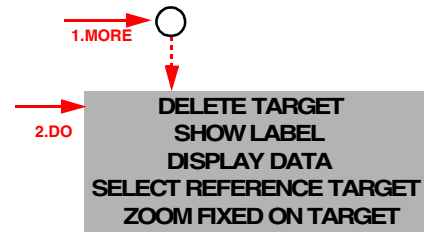

### Deleting Several Targets

1. With the MORE key, click on the **ACQ TGT** area. Then, with the DO key, click on **DELETE TARGETS**. The **ACQ TGT** area becomes the **DEL TGT** area, and it flashes.
2. Delete the target by clicking. As long as the **DEL TGT** area is flashing, other targets can be deleted in the same way.
3. The deletion function of the cursor is switched off by clicking into the PPI by means of the MORE key or by clicking again (with the DO key) on the **DEL TGT** area.

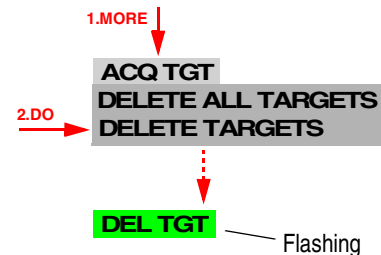

### Deletion of All Targets

Click on the **ACQ TGT** area by means of the MORE key, and then click on **DELETE ALL TARGETS** (with the DO key).

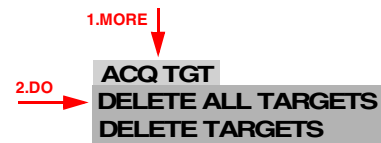

### Loss of Targets

If, in the case of an automatically tracked target situated inside the 20 NM target tracking range, several revolutions of the antenna occur without reception of a radar echo, the target is lost. The **LOST TGT** alarm appears, and the symbol of the target that has triggered the alarm changes to the shape  $\diamond$ . The symbol flashes until the alarm is acknowledged.

### Leaving the Target Tracking Range

If an automatically tracked target leaves the 20 NM target tracking range, the tracking is switched off. No warning is given.

## 7.6 Target Data Display

, either all available data (overall display) can be displayed for two radar targets, or the results of the collision avoidance (TCPA and CPA values) can be displayed (CPA/TCPA display) for eight targets.

### Switching the Target Data Display On, Selecting the Targets

When you click on a target, this switches the target data display on. The data of the clicked target are displayed in the mode that was set last (see below). Furthermore, the target is given the symbol  $\square$  and its target label (see [page 72](#)) is displayed.

If you click on more targets, the data of each of them appear in the display. In all cases, the data of the last selected targets are displayed.

**Switching Off the Target Data Display of Individual Targets**

When you click on a target which is marked with the symbol  , this switches off the display of its data.

**Switch-Over of the Display**

Where the target data are displayed, the System Track data can also be displayed. Furthermore, the menus opened by means of the buttons **MENU** to **BRILL** appear there.

Regardless of the present display, the target data display appears as soon as a target for which the data display has not yet been switched on (a target not yet marked with the symbol  ) is clicked in the PPI. Furthermore, the target data display appears when a target becomes a dangerous target.

After clicking on the **OTHER** button, the switch-over possibilities are listed in the context menu. With the **8 Targets** button, the CPA-TCPA display is brought into the foreground; with the **2 Targets** button, the Overall Display is brought into the foreground.

 The **OTHER** button appears in miniaturised form in the top right-hand corner of the target data or System Track data as soon as the cursor is situated in this data area and there is no menu opened there. It is displayed in normal form as soon as the cursor is situated in the area of the normal display of the **OTHER** button (see also [Switching the Displays On and Off on page 99](#)).

 When you click on the last target whose data are being displayed, this switches off the target data display.

**CPA-TCPA Display**

The following data of the selected 8 (max) targets are displayed:

**CPA** Closest Point of Approach

**TCPA** Time to Closest Point of Approach

ID	CPA	TCPA
9	6.79 NM	10:03 min
13	2.27 NM	4:28 min
SIRIUS	12.59 NM	25:33 min
1	3.67 NM	8:15 min
12	0.479 NM	4:28 min

**Overall Display**

The following data of the selected 2 (max) targets are displayed:

**ID** (= identifier) The target label

**RNG** (= range) The range of the target

**BRG** (= bearing) The bearing of the target

**SPD** (= speed) Speed;  
with prefix **T** (= true): speed over ground / through the water;  
with prefix **R** (= relative): speed relative to your own ship

**CSE** (= course);  
with prefix **T** (= true): course over ground / through the water;  
with prefix **R** (= relative): course relative to your own ship

**TCPA** (= time to closest point of approach) The time up until the closest point of approach

**CPA** (= closest point of approach) The distance at the closest point of approach

**BCT** (= bow crossing time) The time that will pass before the target crosses the heading line of your own ship

**BCR** (= bow crossing range) The range of the point on own ship's heading line at which the target will cross that line

ID	9	13	
<b>RNG</b>	2.01	3.50	<b>NM</b>
<b>BRG</b>	57.9	21.1	<b>°</b>
<b>T SPD</b>	21.1	19.8	<b>kt</b>
<b>T CSE</b>	217.6	190.0	<b>°</b>
<b>TCPA</b>	4:29	14:20	<b>min</b>
<b>CPA</b>	0.13	1.78	<b>NM</b>
<b>BCT</b>	4:09	6:34	<b>min</b>
<b>BCR</b>	0.20	0.46	<b>NM</b>

### Determination of the Data

RNG, BRG, SPD and CSE are determined directly by the radar from the observed motion and the relative position, taking account of own ship's data in some cases. Assuming that the course and speed of the target and of own ship will continue to have the values displayed, the TCPA, CPA, BCT and BCR are computed.

## 7.7 Target Labels

Every target being tracked is automatically given an identification number from 1 to 50. This target label can be displayed at the target symbol in the PPI. You can select whether the target label is to be displayed automatically for new targets. Furthermore, it is possible to specify for each individual target whether the target label is to be displayed.

Regardless of this setting, the target label appears at the target symbol in the PPI as soon as its target data are displayed in the side strip.

 The allocation of the number cannot be influenced. The program ensures that no number is allocated twice.

Instead of the number, it is also possible to use an individual text with up to 4 characters.

### Switching the Automatic Display of the Target Label On and Off

The automatic display of the target label in the case of new targets is switched on and off by clicking on the **TGT LABEL** button in the **USER SETTINGS** menu.

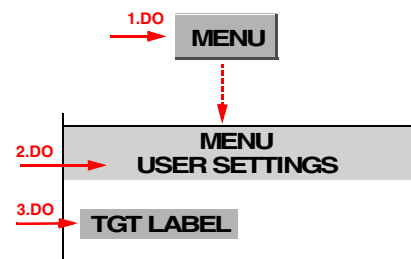

### Switching the Display of the Target Label of a Target On and Off

Switching on: Click on the target by means of the MORE key, and then click on **SHOW LABEL** (with the DO key).

Switching off: Click on the target by means of the MORE key, and then click on **HIDE LABEL** (with the DO key).

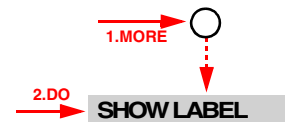

### Inputting a Text as a Target Marker

In the target data display, click on the ID and enter the text by means of the virtual keyboard.

 If the text is to be deleted again, after clicking on the ID click on the ENTER button of the virtual keyboard.

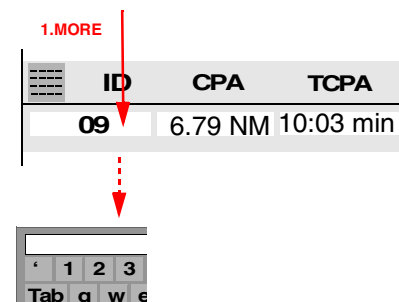



## 7.8 Selecting the Reference Targets for Reference Target Tracking

If at least one fixed target <sup>1)</sup> is selected as a reference target, the radar can determine own ship's speed vector with the aid of this target's relative motion. By means of this "reference target tracking", the radar also acts as a speed sensor, and can be called up as such under **REFERENCE TARGET SPEED**.

**Selecting a reference target:** Click on the fixed target with the MORE key, and then click on **SELECT REFERENCE TARGET** (with the DO key).

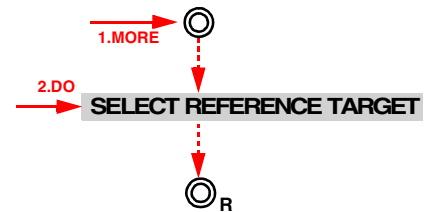

☞ Up to five reference targets can be selected.

☞ The speed input "reference target tracking" is treated as a ground stabilized speed sensor (speed over ground), displayed as COG/SOG data.

The first reference target is given an **R** as its target label. If there is more than one reference target defined, all reference targets are given an independent sequential number in addition to the letter **R**.

**Cancelling the selection:** Click on the reference target with the MORE key, and then click on **DESELECT REFERENCE TARGET** (with the DO key).

**CAUTION:**

**During reference target tracking, it shall be checked repeatedly if the selected reference targets are still displayed as fixed targets.**

<sup>1)</sup> If a moving target is selected by mistake, the own speed determined will be incorrect. To ensure accurate determination of speed, several fixed targets should be checked as references.



## 8 EPA Functions (Electronic Plotting Aid)

### Subjects of this Section:

- ◆ Manual target acquisition on the EPA radar
- ◆ Semi-automatic plotting on the EPA radar
- ◆ Differences between the EPA radar and the ARPA radar

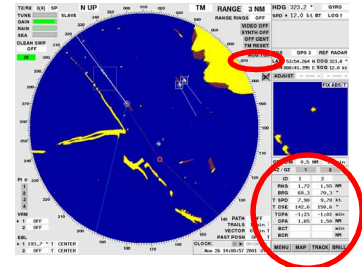

The EPA radar differs from the ARPA radar principally in the fact that, on the EPA radar, targets have to be acquired manually and can only be plotted semi-automatically. Furthermore, on the EPA radar, no targets can be defined as references for reference target tracking.

### 8.1 Manual Target Acquisition and Semi-Automatic Plotting

On the EPA radar, up to 50 targets can be acquired manually and tracked semi-automatically.

In the case of **manual target acquisition**, the presumed target video is marked, and as a result it is initially provided with the dotted square .

For **semi-automatic target tracking**, the same target is marked manually with the second plot several minutes later at its new position. The radar now computes the speed vector of the target and displays that vector (if this function is selected - see [page 34](#)). The first plot is now displayed as the past position plot. The target symbol <sup>1)</sup> changes. It moves along with the target on the computed course at the computed speed.

The plotting must be repeated if the target symbol does not coincide with the target video, but not later than within 15 minutes. After 10 minutes in each case, the operator is reminded by the **PLOT xx NO UPDATE** alarm that a new plot should be set. If the next plot is not then performed within five minutes, the plot is aborted and the alarm **PLOT XX ABORTED** appears.

#### Beginning the Manual Plotting

1. Click on the **ACQ TGT** (= Acquire Target) button; the button flashes.
2. Acquire the target video by clicking. For as long as the **ACQ TGT** button is flashing, more targets can be acquired in the same way.
3. The acquisition function of the cursor is switched off by clicking into the PPI by means of the MORE key or (with the DO key) by clicking again on the **ACQ TGT** area.



<sup>1)</sup> The same symbols are used as with the ARPA radar - see [page 67](#).

### Continuing the Plotting of a Target

30 seconds at the earliest after a plot has been set, another plot can be set for the same target:

Click on the target symbol by means of the MORE key, and then (with the DO key) click on **SET NEXT PLOT** and on the target video.



### Deleting the Last Plot

If a plot is to be corrected, it must first be deleted within 30 seconds after setting of the plot.

Click on the target symbol by means of the MORE key, and then (with the DO key) click on **DELETE LAST PLOT**.

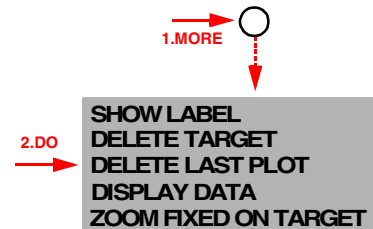

## 8.2 Deletion of Targets

Deletion of one target or of all targets is performed as described in [Section 7.5](#) on [page 70](#).

## 8.3 Target Data Display

The target data display does not differ from that of the ARPA radar - see [Section 7.6](#) on [page 70](#). In addition, the time since the setting of the last plot is displayed behind **PLTIME**.

	4:09	6:34	min
BCT	4:09	6:34	min
BCR	0.20	0.46	NM
PLTIME	1:43	8:33	min

## 8.4 Target Labels

As far as the target labels are concerned, the only difference is that, in the case of the EPA radar, the display of the target label is generally in the switched-on state at first, and if necessary it can be switched off in the USER SETTINGS menu, whereas in the case of the ARPA radar the general display of the target label has to be switched on in the USER SETTINGS menu if necessary - see [Section 7.7](#) on [page 72](#).

## 9 Collision Avoidance (TCPA, CPA)

### Subjects of this Section:

- ◆ Computations for collision avoidance; setting of the TCPA and CPA limits

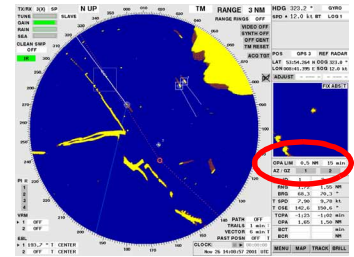

For TCPA (Time to **C**losest **P**oint of **A**pproach) and CPA (**C**losest **P**oint of **A**pproach), limits can be set such that, if the actual values fall short of these limits, the **DANGEROUS TGT** alarm will appear. If the danger computation is switched on, the radar computes the TCPA and CPA values for all targets being tracked. If these values fall short of the set limits,

- the **DANGEROUS TGT** alarm appears,
- the target which has caused the alarm is indicated on the PPI by means of the flashing symbol  $\triangle$ ,
- the target data display is automatically switched on with this target at the first place, and the symbol is marked with the target label.

☞ The computation is performed not only by the ARPA radar but also by the EPA radar. In the latter, however, the results are less reliable because the target data on which the computation is based are old and might therefore be incorrect. A reliable display can be obtained only if plotting is performed frequently enough.

### Switching the Computation for Collision Avoidance On and Off

Click on the **CPA** or **TCPA** area, and then click on **OFF**.

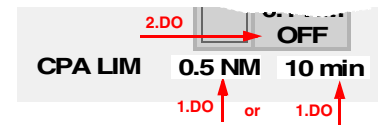

### Changing the TCPA Limit

Click on the **TCPA** area, and then click on the desired value, or click into the upper numerical area and enter the value by means of the virtual keyboard.

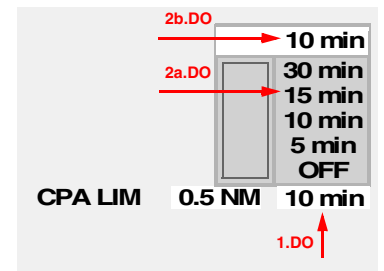

### Changing the CPA Limit

Click on the **CPA** area, and then click on the desired value, or click into the upper numerical area and enter the value by means of the virtual keyboard.

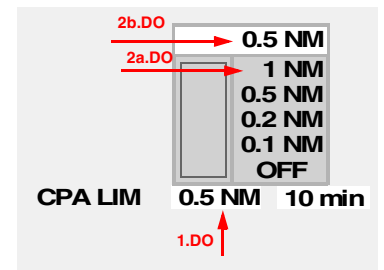



# 10 Trial Manoeuvres

## Subjects of this Section:

- ◆ Setting a trial manoeuvre
- ◆ Relative and true display of the trial manoeuvre

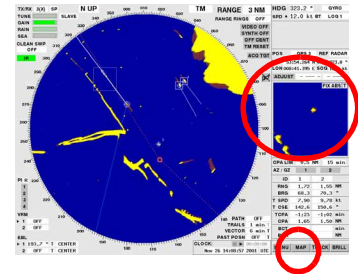

## 10.1 General

Trial manoeuvres are needed mainly for collision avoidance. In this process, a planned manoeuvre of own ship is simulated and the effect of this manoeuvre on the targets being tracked is checked in a graphic display.

The trial manoeuvre can be specified by

- simulation of a course change, including the radius to be used by the ship and
- the period of time up until the beginning of the simulated manoeuvre (the delay) and by
- simulation of a speed change at the instant of the manoeuvre.

There are two display-modes available:

- At the instant when the trial manoeuvre function is switched on, a switch-over to relative display mode takes place. This display mode is used for fast setting of the necessary course-change, of the delay and of the speed change.
- In true display mode, the manoeuvre radius that can then be set and the acceleration <sup>1)</sup> for the set speed-changes are taken into account additionally.

☞ The target tracking and the automatic acquisition of targets are not interrupted during the execution of a trial manoeuvre.

## 10.2 Switch-On of the Trial Manoeuvre Display

Click on the buttons **MENU**, **UTILITIES** and **TRIAL MANOEUVRE** one after the other. This causes switching into the **relative display** of the radar synthetics. The general screen-stabilisation (TM or RM) and the alignment of the heading line remain unchanged.

In the Multidisplay, the trial manoeuvre menu appears, with the following data:

- **CSE:** The currently existing course <sup>2)</sup>
- **SPD:** The currently existing speed <sup>2)</sup>
- **DELAY:** 0 minutes.

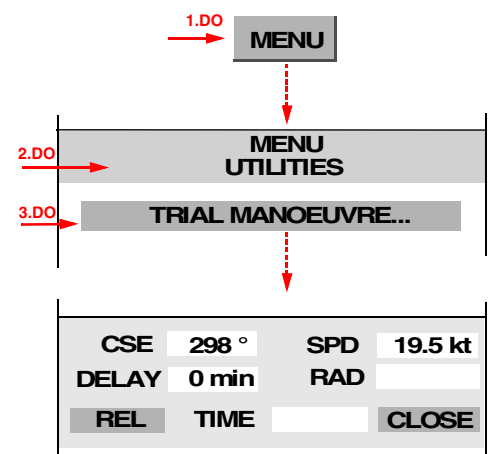

1) The acceleration behaviour of the ship is entered at service level during setting-to-work.  
 2) The resultant value used for the display of the own ship vector

The following changes occur in the PPI:

- In the lower region of the PPI, a large, flashing **T** is shown to draw attention to the fact that the trial manoeuvre display is switched on and that, consequently, the symbols and vectors of the targets being tracked are no longer being displayed in accordance with the real situation that actually exists at that time.
  - The vector display (of the radar targets) is switched on.
  - The vectors are displayed in relative mode.
  - Past position plots, if switched on, are displayed in relative mode.
- ☞ Because the currently existing values were taken over, no manoeuvre has been simulated yet.

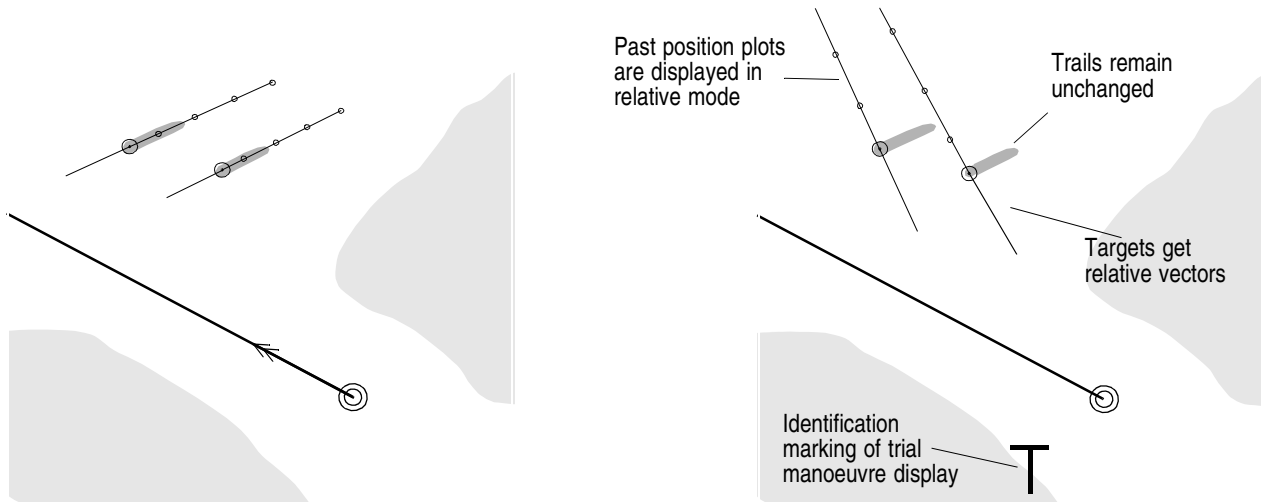

Display before switch-on of the trial manoeuvre (with true vector display)

Display after switch-on of the trial manoeuvre (the target on the right is on a collision course)

### 10.3 Setting the Trial Manoeuvre in Relative Display Mode

Because the vector display during the trial manoeuvre is a relative display, a collision course can be recognised from the fact that the vector of a target is pointing towards the own ship symbol (constant bearing). A manoeuvre must be simulated which avoids this constant bearing while at the same time fulfilling other conditions (e.g. keeping within the channel, avoiding shallow water, etc.).

A suitable vector-length should be set.

#### Simulating a Course Manoeuvre

Click on the **CSE** area, set the trackball to the desired course change, and press the DO key for the second time.

- ☞ Because of the relative display mode, the target vectors are rotated by the simulated course-change.

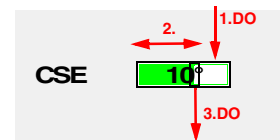



**Setting the Time Instant of the Simulated Manoeuvre**

Click on the **DELAY** area, use the trackball to set the time that is to pass before the simulated manoeuvre begins, and press the DO key for the second time.

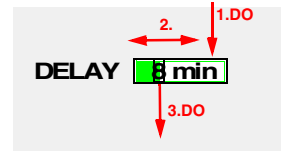

The situation at the point in time defined by the delay value is now displayed. The own ship symbol and the target vectors have been shifted accordingly. If the display of the past position plot is switched on, the shifted target-vectors can be assigned to the targets by means of dashed lines.

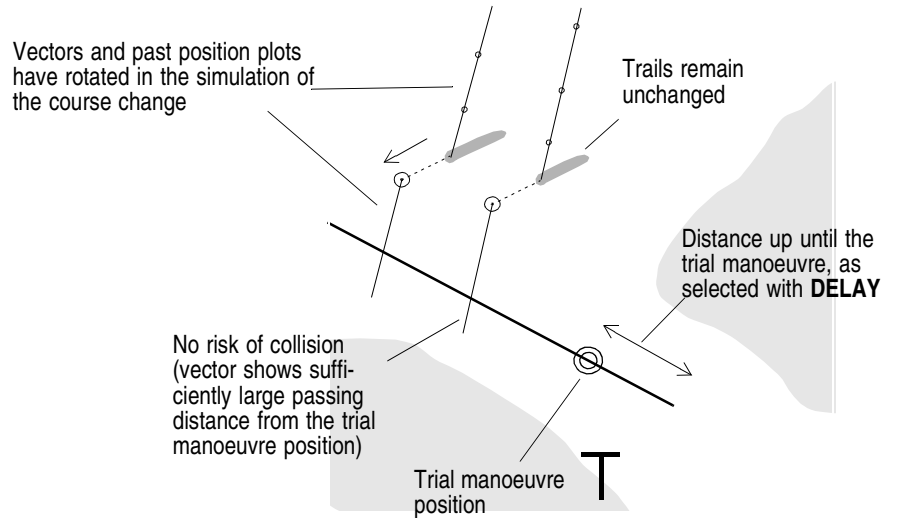

**Relative display after setting of a trial manoeuvre which would prevent a collision**

If no suitable manoeuvre can be found by means of these two settings, a speed change must be simulated:

**Simulation of a Speed Change**

Click on the **SPD** area, use the trackball to set the speed at which the ship is to travel from the beginning of the simulated manoeuvre onwards, and press the DO key for the second time.

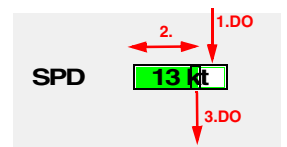

Because of the relative display mode, the simulated course-change causes a change in the directions and lengths of the target vectors. The display is based on the simplifying assumption that, from the beginning of the manoeuvre onwards, the ship travels at the set speed.

**Rules for the Avoidance of Collision Courses:**

1. There must be no target vector pointing towards the own ship symbol of the trial manoeuvre.
2. All manoeuvres and parameter settings must take place in accordance with the collision avoidance rules and good seamanship.

## 10.4 Checking the Trial Manoeuvre in True Display Mode

In true display mode, the trial manoeuvre is displayed with true vectors. Both the radius planned for the manoeuvre and the acceleration behaviour for the speed change that is set are taken into account. All settings made in relative display mode can still be changed in true display mode.

### Switch-On of the True Display Mode

The switch-over between true and relative display mode is performed in the trial manoeuvre menu by clicking on the **REL** or **TRUE** button.

It is possible at any time to switch to and fro between the two display modes without any loss of data or information.

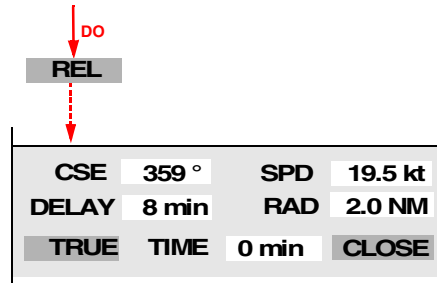

As a result of the switch-over, the following changes occur:

- True vectors are displayed.
- Own ship and targets are shown at their currently existing positions.
- The trial manoeuvre line is displayed. It represents the track on which the ship would perform the simulated manoeuvre. The radius displayed behind **RAD** in the Multidisplay is taken into account.

The simulated manoeuvre-radius can now be changed:

### Changing the Simulated Manoeuvre-Radius

Click on the **RAD** area, use the trackball to set the radius with which the course change is to take place, and press the DO key for the second time.

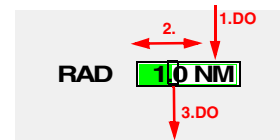

### Checking the Trial Manoeuvre

By means of **TIME**, the instant of time that is to be considered can be set: Click on the **TIME** area and, by means of the trackball, vary the time instant that is to be displayed. By continuous variation, a synchronised display of the simulated own ship positions and target positions takes place. If, for all **TIME** values, an adequate distance between own ship symbol and the target symbol is displayed, the trial manoeuvre will not show a dangerous approach.

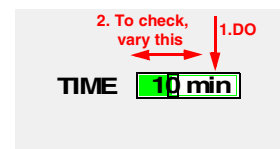

End the check by pressing the DO key.

If necessary, any of the trial manoeuvre settings can now be changed and the check can be repeated.

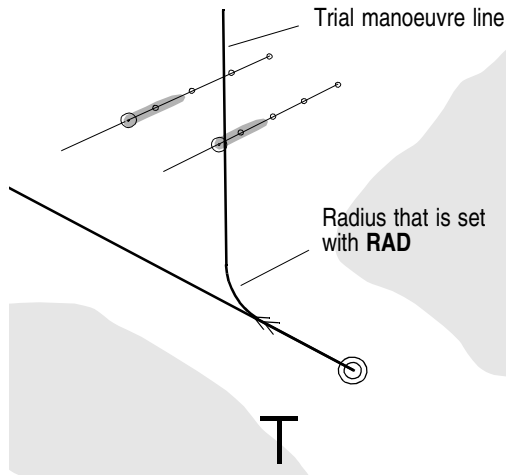

Display after switch-over to true display mode

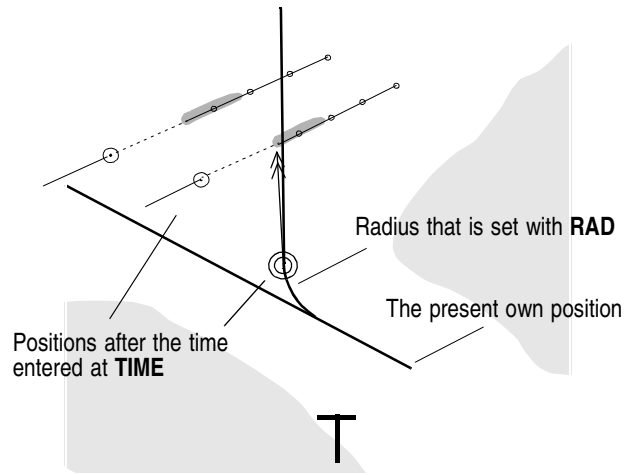

Check by variation of the TIME input

## 10.5 Switching Off the Trial Manoeuvre Display

Switching off is performed by pressing the **CLOSE** button situated in the area where the trial manoeuvre data are displayed.

CSE	359 °	SPD	19.5 kt
DELAY	8 min	RAD	1.0 NM
TRUE	TIME	10 min	<b>CLOSE</b>

DO ↑



# 11 Editing of Pre-planned Tracks

**Subjects of this Section:**

- ◆ Editing and modification of tracks
- ◆ Management of tracks

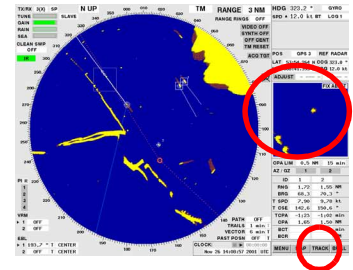

Before a Pre-planned Track can be displayed and used in the PPI, it must be edited on a CHARTPILOT or on a radar indicator. If there is a CHARTPILOT, it can and should be used for this work.

☞ On the CHARTPILOT, e.g. on the basis of the Electronic Chart, tracks can be edited much more conveniently and also - thanks to the test possibilities available there - with greater nautical safety.

Pre-planned Tracks are accommodated in **catalogs**, and can be identified within the catalog by means of a **track number** and a **track name**. Catalogs can be created and also - if necessary - deleted. Tracks can be generated (edited), and existing tracks can have their contents altered, or can be assigned to other catalogs, or can be deleted.

☞ If there is a CHARTPILOT, it must always be in the switched-on state when work on tracks is being done on the radar indicator, since the track data are physically stored in the CHARTPILOT.

☞ If there is no CHARTPILOT in the system and if the tracks are to be used on several radar indicators, the tracks - including the catalogs - must be transferred to the other radar indicators; see [page 143](#).

The menus that are needed in connection with the editing of the tracks are opened from the TRACK menu which is opened by clicking on the **TRACK** button.

**LOAD List**

- Loading of the track that is to be altered or copied
- Determining the track number for new tracks

**EDIT List and EDIT Menu**

- Editing (generating and changing) of tracks
- Creating catalogs
- Assigning tracks to other catalogs

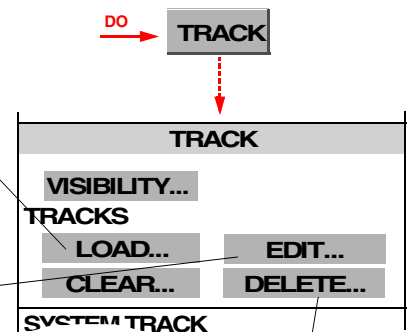

**DELETE List**

- Deletion of tracks
- Deletion of catalogs

The following description is based on this menu.

## 11.1 Generating a New Pre-planned Track

### Input of Management Data

- First of all, it is necessary to define which catalog the track is to be stored in, and under which number:  
**Defining the track number and the catalog:** In the TRACK menu, click on the **LOAD** button, then click on the desired catalog and see which track number is not yet being used. Close the **Load Track(s)** list by means of **CLOSE**.
- Calling up the EDIT TRACK menu:** In the TRACK menu, open the Edit Track list by means of the **EDIT** button.  
 All of the tracks loaded are listed there. Tracks are loaded by calling them up for display - see [page 37](#).  
 Let the marker remain at <NEW>, and open the EDIT TRACK menu by clicking on the **EDIT** button.
- Inputting the track number:** In the small field behind **EDIT TRACK**, enter the number of the track.
- Specifying the catalog:** Click into the **CATALOG** field; in the **Catalog** list which then opens, mark the desired catalog and click on **SELECT**.
- Inputting the track name:** It is entered in the **TRACK** field.

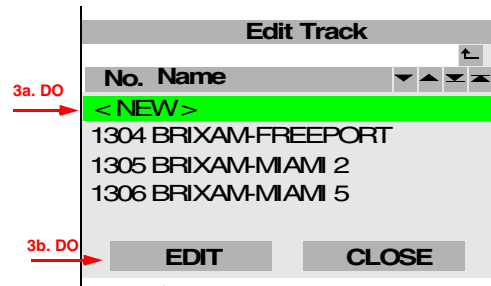

### The EDIT TRACK Menu

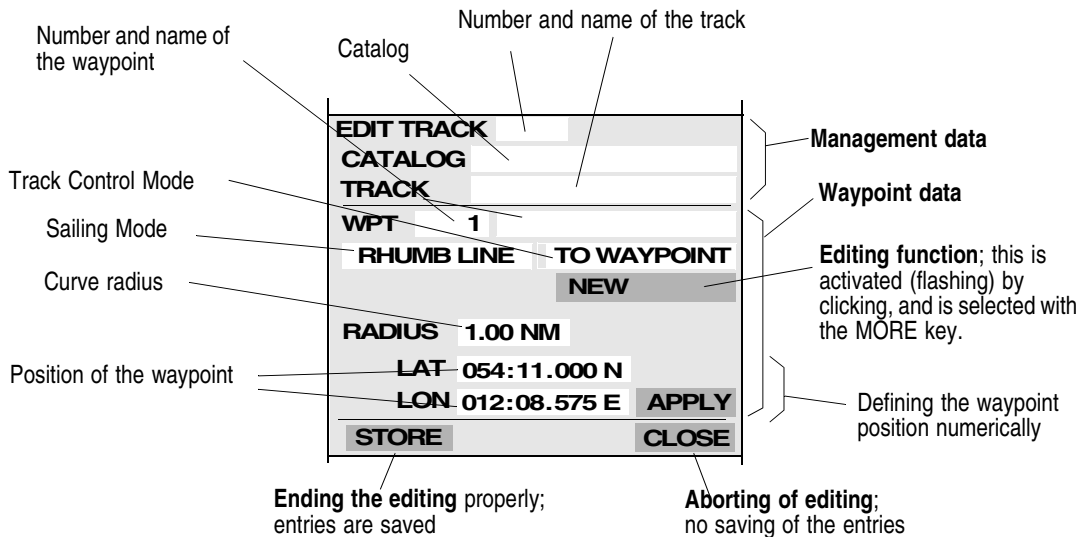

### Waypoint Data

Each waypoint has the following parameters:

- **Number of the waypoint.** This identifies the waypoint, is allocated consecutively within the track, and can be displayed in the PPI.
- **Name of the waypoint.** This appears in the waypoint list when the Next Waypoint is being defined; see [page 40](#). This entry is not obligatory.

- **Position of the waypoint.** Geographical position based on WGS 84.
- **Curve radius.** Radius of the curve along which the ship is to sail at the waypoint
- **Sailing Mode.** This specifies whether a track section longer than 20 NM from this waypoint to the next one is to be displayed as a rhumb line (Sailing Mode = **RHUMB LINE**) or as a great circle (Sailing Mode = **GREAT CIRCLE**) <sup>1)</sup>.
- **Track Control Mode.** (**TO WAYPOINT** or **TO TRACK**). In the system configuration involved here, this parameter is not important.

**General Editor Characteristics**

The position of the waypoints can be defined **graphically or by alphanumeric input** (both when a new waypoint is being inserted and when the waypoint position is being changed).

When a new waypoint is being inserted, **the curve radius, Sailing Mode and waypoint name are taken over from the preceding waypoint** and are also entered for the inserted waypoint.

**Selecting the editing function** is done by clicking on the editing function button by means of the MORE key and then clicking on the desired function by means of the DO key.

The **editing function is activated** by clicking on the editing function button. This is also in the active state immediately after an editing function has been selected. The fact that the editing function is active is indicated by the fact that the **editing function button is flashing**.

The active **editing function is deactivated** by clicking on the (flashing) editing function button or by clicking into the PPI by means of the MORE key.

Every **entry of waypoint parameters** in the EDIT TRACK menu must be completed by pressing the **APPLY** button.

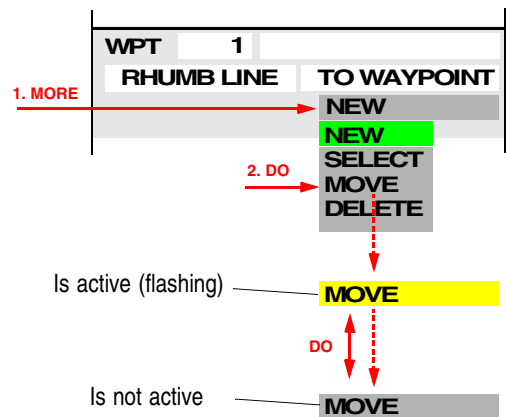

☞ For graphic editing, at least the display of the legs and of the waypoint symbols must be in the switched-on state - see [page 38](#).

**Entering of Waypoint Data**

The sequence in which editing is performed is partly a matter of personal preference and partly dependent on the circumstances. For example, all waypoints can first be inserted graphically; then, in the second step, the position is set alphanumerically to the precise value if necessary. (This procedure is described in the following.)

**WARNING:**

**Naturally, the inserting and moving of the waypoints can also be performed generally by means of alphanumerical inputs. If a track lying outside the radar range is to be edited while the ship is sailing, the graphical methods are usually not appropriate.**

<sup>1)</sup> **Great circle approximation:** If the Sailing Mode **GREAT CIRCLE** has been entered at a waypoint on the Pre-planned Track and the distance from the next waypoint is larger than 20 NM, this track section is automatically approximated to a great circle. For this purpose, the program divides this track section into subsections, each having a length of 10 NM, and places the ends of these subsections on the great circle.

### Entering of Waypoints.

1. Activate the editing function **NEW**
  2. **Specify the Sailing Mode:** The switch-over is performed by clicking on the Sailing Mode field.
  3. Set the waypoint by clicking in the PPI.
-  During this process, the geographical coordinates of the cursor position are displayed in the cursor display.

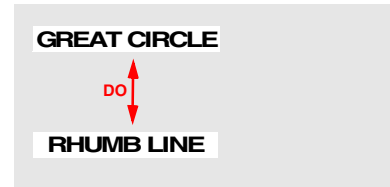

**WARNING:**  
This position might be faulty, e.g. if an incorrect Position Offset has been entered.

4. Each further click creates the next waypoint.
5. If a waypoint is to be inserted at another place, the **MORE** key must first be pressed in the PPI. To set a waypoint between two existing ones, click on the track between these waypoints and insert the new waypoint by clicking.  
To set a waypoint before the first waypoint, click on the first waypoint and proceed accordingly. To then extend the track, click on the last waypoint and proceed accordingly.

### Moving of Waypoints

1. Activate the editing function **MOVE**.
2. In the PPI, click on the waypoint that is to be moved.



Alternatively (e.g. because the waypoint is not situated in the display range): Click into the field of the waypoint number and enter the number of the waypoint that is to be moved.

3. Graphic input of position: Click on the new position.

Alphanumerical input: After clicking on the **LAT** and **LON** fields, enter the geographical position by means of the virtual keyboard and press the **APPLY** button.

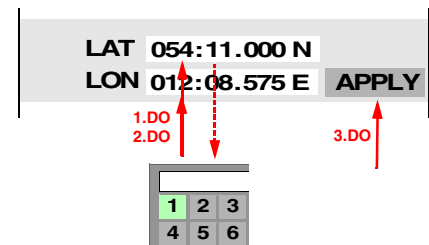

 By pressing of the **APPLY** button again, the waypoint that has just been processed is selected again. In this way, a position that has accidentally been entered wrongly can be corrected.

4. Repeat processes 2 and 3 for the other waypoints that are to be moved.

### Deletion of Waypoints

1. Activate the editing function **DELETE**.
2. In the PPI, click on the waypoints that are to be deleted, one after another.



Alternatively (e.g. because the waypoint is not situated in the display range): Click into the field of the waypoint number and enter the number of the waypoint that is to be deleted. Then click on **APPLY**.



**Entering/Changing of Waypoint Parameters**

1. Activate the editing function **SELECT**.
2. In the PPI, click on the waypoint that is to be processed.  
Alternatively (e.g. because the waypoint is not situated in the display range): Click into the field of the waypoint number and enter the number of the waypoint that is to be processed.
3. **Specifying the curve radius:** Click on the radius field and enter the value by means of the virtual keyboard.  
This entry must be performed
  - at the first waypoint
  - at every waypoint at which the curve radius is to change relative to the preceding waypoint.

 The entry of the radius is cancelled by input of the value 0.
4. If desired, **enter the name of the waypoint:** Click on the name field, and enter the name by means of the virtual keyboard.
5. If the Sailing Mode is to change, make the appropriate change.
6. For each waypoint, put the entries into effect by clicking on the **APPLY** button.

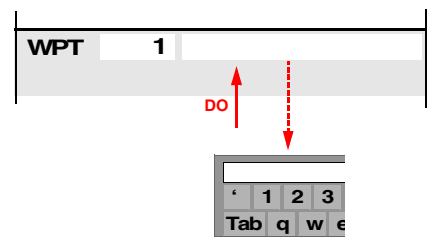
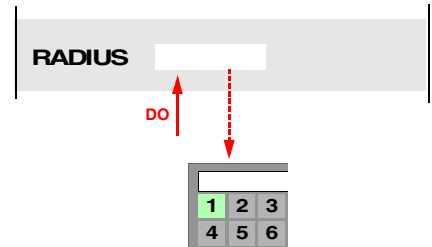

The track is then computed anew. The curves are now displayed. A curve radius that is entered also affects all of the following waypoints up to a waypoint for which a different curve radius has been entered.

If the waypoints have been positioned so unfavourably (short distance between waypoints, acute angles) and/or the radii have been chosen so large that the ship will probably not be able to sail along the track, this situation is indicated by means of a special display of the track:

- The tracklines (the straight lines up to the last waypoint and up to the currently valid waypoint) are extended as far as the waypoints.
- In the display, the circular arc defined by the radius is moved along the trackline to the last waypoint until it fits between the two tracklines.
- This movement takes place up to the last waypoint at the most, but not further than up to a distance of 20 NM between the beginning of the curve and the waypoint.

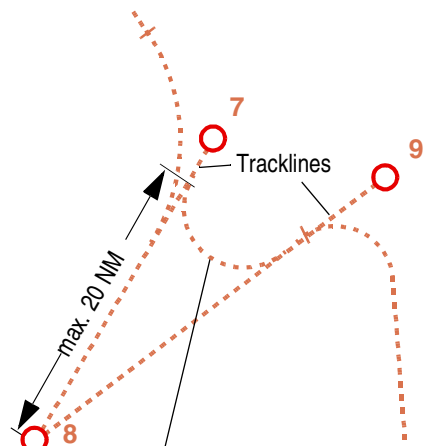

Behind the curve end of waypoint 7, this curve does not fit into the angle formed by waypoints 7, 8 and 9. Therefore, the curve is shown displaced, and the display of the Programmed Track is interrupted by the display of the tracklines.

**Ending the Editing Process**

Editing is ended by clicking on the **STORE** button. All entries are stored <sup>1)</sup>.

 If the entries are not to be stored, the editing can be ended by clicking on the **CLOSE** button.

If there is no CHARTPILOT in the system, data saving should be performed after every change in tracks - see [page 143](#). If the tracks are to be used on several radar indicators, the tracks - including the catalogs - must be transferred to the other radar indicators; see [page 143](#) too.

LAT	054:11.000 N	
LON	012:08.575 E	APPLY
STORE		CLOSE

↑ DO
↑ DO

**11.2 Modifying an Existing Track**

If an existing track is to be modified, this track must be selected for display - see [page 37](#).

1. **Calling up the EDIT TRACK menu:** In the TRACK menu, open the **Edit Track** list by means of the **EDIT** button.
2. By clicking, mark the track that is to be modified.
3. In the **Edit Track** list, open the EDIT TRACK menu by clicking on the **EDIT** button.
4. The changes take place as described in [Section 11.1](#).

**11.3 Generating a New Track on the Basis of an Existing Track**

The track that is to be used as the basis must already be selected for display - see [page 37](#).

1. It is first necessary to define which catalog the track is to be stored in, and under which number.  
**Specifying the track number and the catalog:** In the TRACK menu, click on the **LOAD** button, and then click on the desired catalog and see which track number is not yet being used. Close the list by means of **CLOSE**.
2. **Calling up the EDIT TRACK menu:** In the TRACK menu, open the **Edit Track** list by means of the **EDIT** button.
3. By clicking, mark the track that is to be used as the basis.
4. In the **Edit Track** list, open the EDIT TRACK menu by clicking on the **EDIT** button, and enter the track number, the track name and (if necessary) the catalog - see [page 86](#).
5. By clicking on the **CLOSE** button, a copy of the opened track is saved under the new number.
6. Mark the new track in the **Edit Track** list and open the new track again by means of the **EDIT** button.
7. The changes and additions take place as described in [Section 11.1](#).

<sup>1)</sup> ... on the CHARTPILOT. If the CHARTPILOT is not operable, a message appears.

## 11.4 Managing the Pre-planned Tracks

### Creating a New Catalog

A catalog is created if, in step 4 during the entering of the management data (see page 86) in the process of generating a track, a new catalog-name is entered in the field under **Select Catalog** instead of the marking of a catalog. When the EDIT TRACK menu is closed by means of the **CLOSE** button, a message appears, stating that the new track cannot be stored because the catalog entered does not exist, and a question appears, asking whether the catalog is to be created. If this question is answered with **Yes**, the catalog is created.

### Deletion of Tracks and Catalogs

1. In the TRACK menu, open the **Delete Track(s)** list by means of the **DELETE** button. Initially, all catalogs that have been created are listed there.
2. Mark the desired catalog by clicking, and click on the **DELETE** button. As a result, the list of tracks that are contained in the catalog appears.
3. By clicking, mark the track that is to be deleted, and click on the **DELETE** button. **As a result, the marked track is irretrievably deleted.**
4. Repeat step 3 for any other tracks that are to be deleted. If there are no more tracks present in the catalog that has been opened and if the **DELETE** button is then clicked, **the catalog is deleted.**

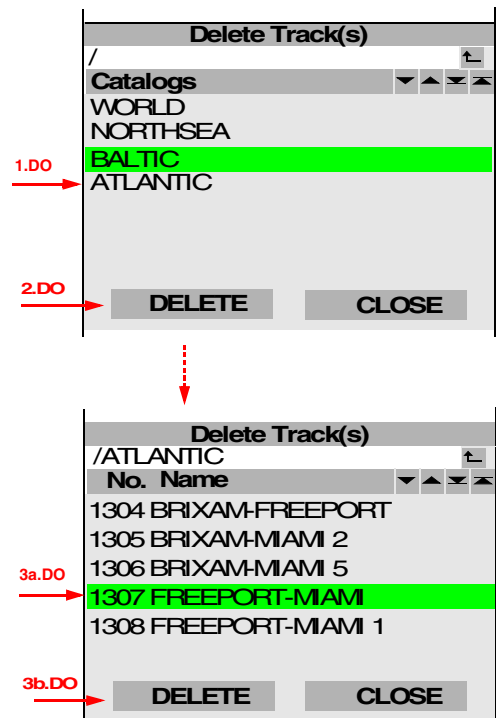

### Giving a Different Number to a Track or Assigning a Track to a Different Catalog

In the first step, the track is copied and is stored under the new number or in a different catalog. The steps needed for this are identical to steps 1 to 5 described in Section 11.3.

In the second step, the track under the old number or in the previous catalog is deleted - see above.



## 12 Editing the Map

### Subjects of this Section:

- ◆ Editing the map
- ◆ Symbols and lines of the map

The elements of the map must be entered (edited) on a radar indicator and then distributed to the other indicators so that these elements will then be available at these other indicators.

Various symbols and one type of line can be edited.

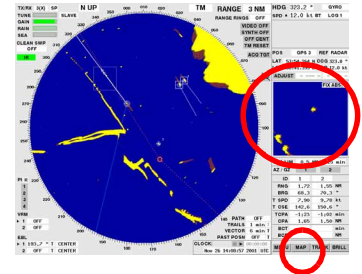

### 12.1 Preparing the Editing of the Map

So that loss of data does not occur during the data distribution which is then necessary, editing should only be performed on the radar indicator having the most recent set of map data.

#### Calling the EDIT MAP Menu

If there is a CHARTPILOT connected, switch over to Radar Display Mode, e.g. by means of the **RADAR MODE** key.

Click on the **MAP** button and then on the **EDIT MAP** button. The EDIT MAP menu appears in the Multidisplay.

The following description is based on this menu.

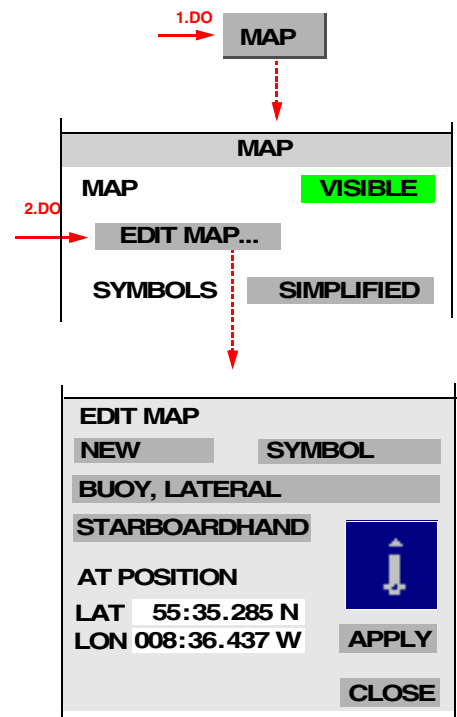

#### Switching the Editing Function of the Cursor On and Off

Behind the button which displays the word **NEW** when the EDIT MAP menu is switched on, there are all of the editing functions of the cursor.

By the clicking of this button, the cursor obtains the editing function displayed on this button. This is indicated by flashing of the button. The editing function can now be executed by clicking into the PPI – see [Section 12.2](#) and [12.3](#).

By clicking again on this button (or by clicking into the PPI by means of the MORE key), the editing function is taken away from the cursor. The button stops flashing.

### Selecting the Editing Function of the Cursor

If, with the MORE key, you click on the button which displays the word **NEW** when the EDIT MAP menu is switched on, a context menu opens, showing a list of all editing functions of the cursor. Click on the desired function.

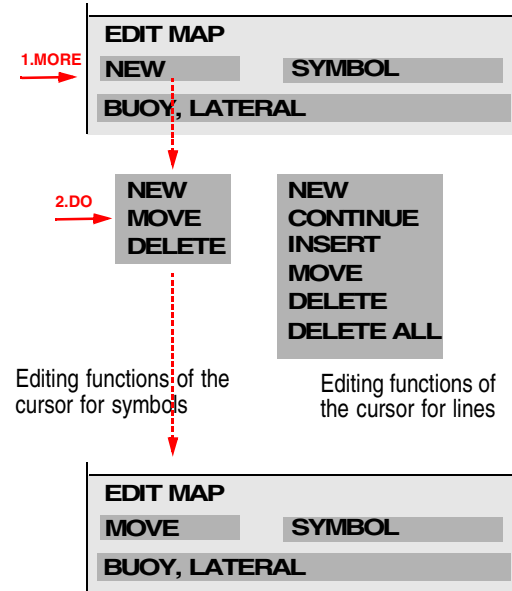

## 12.2 Editing of Symbols

Symbols can be inserted, moved or deleted.

Before a symbol is inserted, it must be defined. It can then be inserted by numeric input of the insertion position or by clicking at the position on the PPI.

Defining can be done by selecting the symbol meaning or by graphic selection.

### Defining the Symbol to be Inserted by Selecting its Meaning

1. Set the **SYMBOL/LINE** button to **SYMBOL**.
2. In the button situated below that, select the symbol.
  - ☞ All symbols that can be edited are listed.
3. If the symbol can be supplemented by the addition of elements, one of these elements is shown in the button situated below that. Correct the element if necessary.
  - ☞ The symbol defined in this way is displayed in the graphics field.
4. Select the editing function **NEW**.

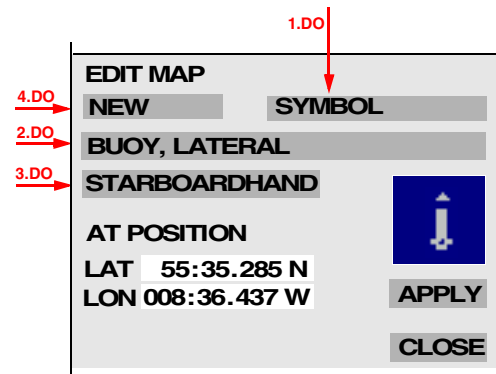

### Selecting Graphically the Symbol to be Inserted

1. Set the **SYMBOL/LINE** button to **SYMBOL**.
2. Click into the graphics field and click on the desired symbol.
  - ☞ The meaning of the selected symbol is displayed in the text fields.
  - All symbols that can be edited are shown.
3. Select the editing function **NEW**.

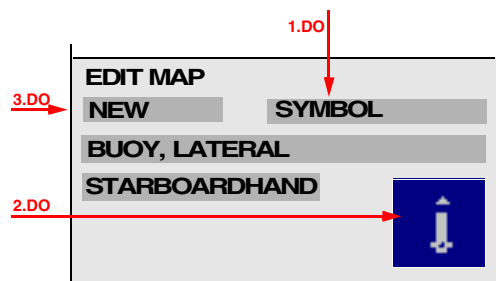

The following symbols can be edited:

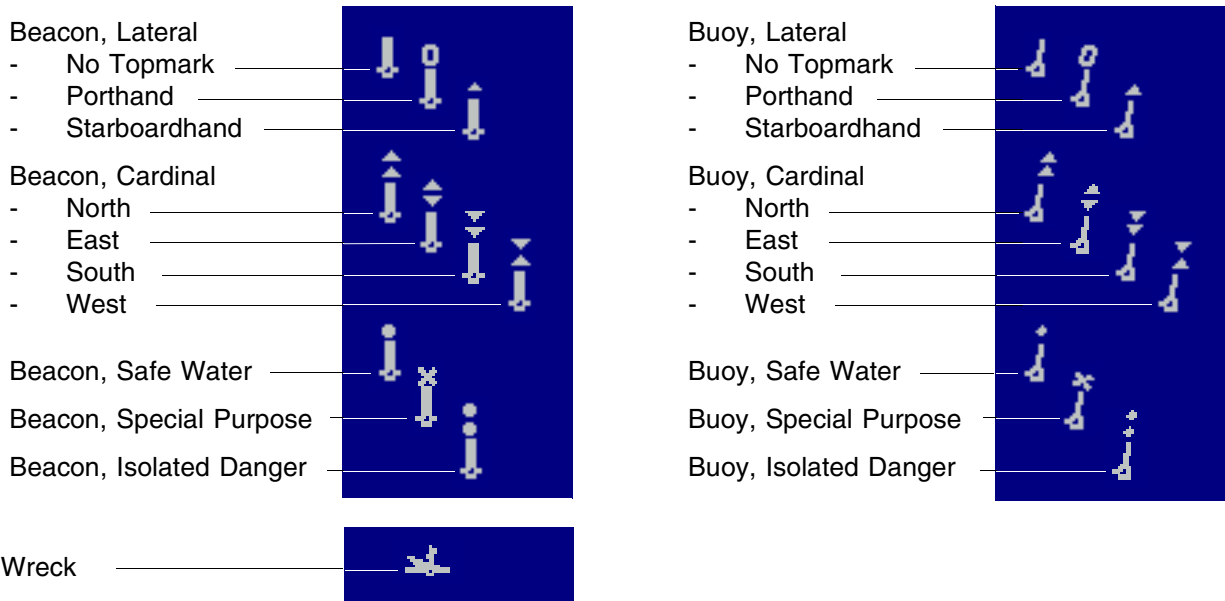

**Inserting a Symbol by Numeric Input of the Position**

1. With the virtual keyboard, input the geographical coordinates behind **LAT** and **LON**.
2. By clicking on the **APPLY** button, the defined symbol is inserted in the map at the position which you have entered.

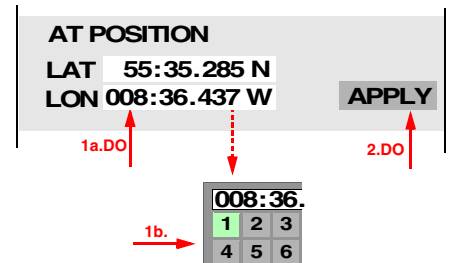

**Inserting a Symbol by Clicking**

On the PPI, click on the insertion position. The specified object is inserted in the map.

**Moving of Symbols**

1. Select the editing function **MOVE**.
2. On the PPI, click on the symbol that is to be moved.
3. Click on the insertion position or input the insertion position numerically (see above).



**Deletion of Symbols**

1. Select the editing function **DELETE**.
2. On the PPI, click on the symbol that is to be deleted.



## 12.3 Editing of Lines

Lines are inserted by entering the line points one after another. These are thin, white, continuous lines. Existing lines can be lengthened or deleted. On these lines, line points can be inserted, moved or deleted.

### Inserting a New Line

1. Set the **SYMBOL/LINE** button to **LINE**.
  2. Select the editing function **NEW**.
  3. Set the starting point of the line by clicking on the PPI, or input the insertion position numerically (see page 95).
-  Each further clicking action sets the next point of the line.

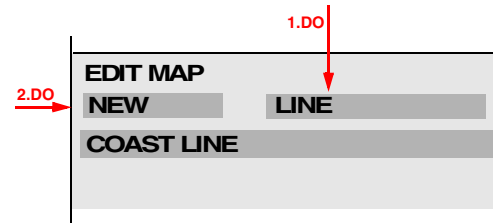

### Lengthening a Line

1. Select the editing function **CONTINUE**.
  2. On the PPI, click on the starting point or end point of the line.
  3. Click on the insertion position.
-  Each further clicking action sets the next point of the line.

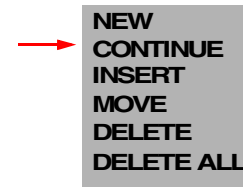

### Inserting a Point on a Line

1. Select the editing function **INSERT**.
  2. Click on the line between the points where a point is to be inserted.
  3. Click on the position of the new point.
-  Begin the next insertion by means of step 2.

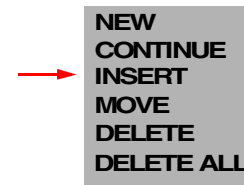

### Moving a Point of a line

1. Select the editing function **MOVE**.
  2. On the PPI, click on the point that is to be moved.
  3. Click on the new position.
-  Begin the next insertion by means of step 2.

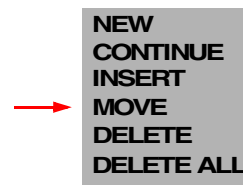

### Deleting a Point on a Line

1. Select the editing function **DELETE**.
  2. On the PPI, click on the point that is to be deleted.
-  Each clicking action on another point of the line deletes that point.

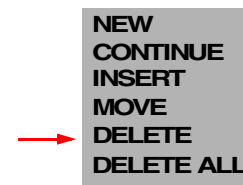



### Deleting a Line Completely

1. Select the editing function **DELETE ALL**.
  2. On the PPI, click on the line that is to be deleted.
- ☞ Each clicking action on another line deletes that line.

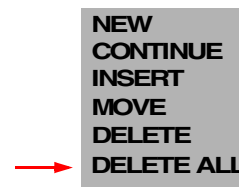

## 12.4 Ending the Editing of a Map

Editing is ended by clicking on the **CLOSE** button. All inputs are stored automatically in the radar indicator that is being operated, and are available there for display.

So that the inputs can be displayed on other indicators too, the processed map data must be transferred to these indicators in accordance with [Section 22.5](#) - see [page 141](#). Furthermore, data saving should be performed (likewise in accordance with [Section 22.5](#)).





## 13 Displays in the Multidisplay

### Subjects of this Section:

- ◆ Preparation and selection of the Multidisplay content
- ◆ Display to support the docking manoeuvre
- ◆ Enlarged display of the target video in the Zoom Display
- ◆ Depth Display
- ◆ Display of wind data, drift and set

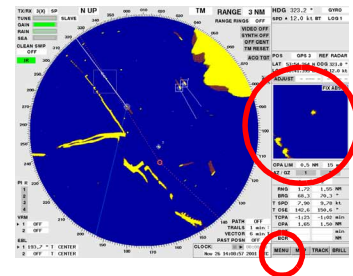

In the Multidisplay, one of the following displays can appear:

- the graphic displays
  - Docking,
  - Zoom,
  - Depth,
  - Wind/Set+Drift
- the menus
  - for the trial manoeuvre,
  - for editing of the map,
  - of the track system (Load Tracks, Clear Tracks, Edit Tracks, Delete Tracks, Set System Track, Select Next Waypoint),
- the alarm list,
- the sensor menus,
  - of the speed sensor,
  - of the position sensor.

### Switching the Displays On and Off

The **graphic displays** are switched on and off in the UTILITIES menu after clicking on the **MENU** button; for details, see the following subsections. How the **menus** are opened and closed is described in the relevant sections. The **alarm list** is opened automatically by the occurrence of an alarm, and is closed automatically when the alarm situation no longer exists. Furthermore, the display of the alarm list can be suppressed and can be called up again at any time - see [Section 17](#).

The display that is called up last covers over the one that already existed. However, the displays that are covered over remain active, except for the sensor menus, which close automatically in any case 30 seconds after the last operating action.

After clicking on the **OTHER** button, all active displays are listed in the context menu. By clicking on the desired display, that display is brought into the foreground.

### Parameterising of the Displays

All display settings mentioned in the following affect only the display on the radar indicator that is being operated.

## 13.1 Docking Display

In the display ranges up to 1.5 NM, the distance and speed to a docking position can be displayed. For this purpose, the docking position must first be defined on the PPI.

**WARNING:**

The computation might be based on faulty data (e.g. the ship contour being displayed, which does not necessarily have to correspond sufficiently accurately to the actual contour, or the data of the navigation sensors), and so this display can only serve as an overview, and not as the sole docking aid.

**Switching the Docking Display On/Off**

Click on the **MENU** button. Then, in the USER SETTINGS menu, click on the **DOCKING** button.

As a result of switching on, the docking position symbol is additionally set at own ship's position on the PPI.

At the same time, the Docking Display appears on the Multidisplay.

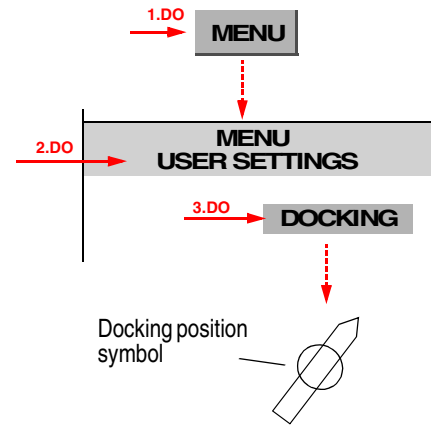

**Specifying the Docking Position**

**Shifting:** Click into the circle of the docking position symbol. Shift the symbol by means of the trackball, and at the desired position press the DO key. The symbol is kept at this geographical position.

**Rotating:** Click on the docking position symbol near to the circle but outside it. Rotate the symbol by means of the trackball, and when the desired direction is reached press the DO key.

**Adapting the Docking Display to Suit the Actual Starboard/Port Situation**

In the Docking Display, click on **STBD** or **PORT**.

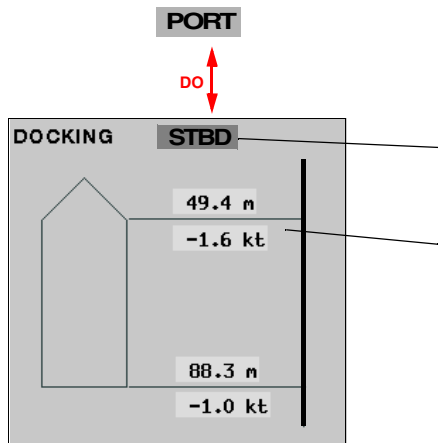

Here, the arrangement in the Docking Display can be adapted to suit the actual starboard/port situation.

**STBD arrangement:**  
The distance and speed between the starboard side at own ship's bow and stern and the starboard side at the bow and stern (respectively) of the docking position symbol

**PORT arrangement:**  
The distance and speed between the port side at own ship's bow and stern and the port side at the bow and stern (respectively) of the docking position symbol

**13.2 Zoom Display**

In modes North-Up and Course-Up, an enlarged video display of a PPI excerpt can be switched on. You can specify whether the excerpt is to remain at a fixed position or is to be moved along together with a target or with own ship's position.

- In this zoom display, the area enlargement factor is 9 (the linear enlargement factor is 3). Only the video is contained in the zoom image, i.e. no synthetics. If the display of trails is switched on for the PPI, the trails in the zoom display are always displayed in true mode. This is indicated by a **T** in the upper right-hand corner of the zoom display.

**Switching the Zoom Display On/Off**

Click on the **MENU** button, and then click on the **ZOOM** button in the **USER SETTINGS** menu.

As a result, the zoom frame is set in the PPI at a fixed position around own ship's position. The frame marks the area displayed in enlarged form in the zoom display.

At the same time, the zoom display appears in the Multidisplay.

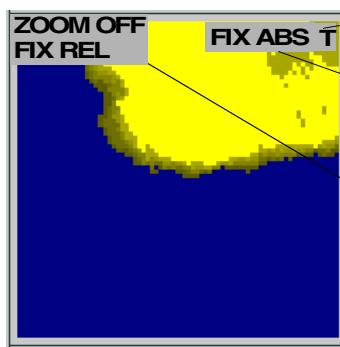
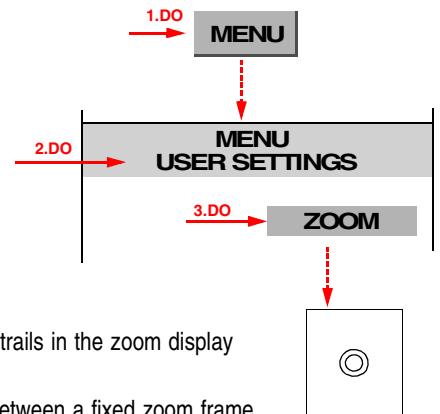

- T** = trails are displayed as true trails in the zoom display
- Clicking causes a switch-over between a fixed zoom frame (display **FIX ABS**) and a zoom display which is carried along (with own ship's position) (display **FIX REL**).
- Display **FIX TGT**: The zoom frame is carried along with a radar target.
- This menu appears after the **MORE** key has been used to click into the zoom display.
  - Clicking on **ZOOM OFF** switches off the zoom display.
  - Clicking on **FIX REL** or **FIX ABS** switches over between a fixed zoom display and a zoom display which is carried along (with own ship's position).

**Positioning the Zoom Frame**

Click into the zoom display; then, at the desired position in the PPI, press the **DO** key.

Alternatively: In the PPI, click on the zoom frame at its contour, position the zoom frame by means of the trackball, and press the **DO** key.

- When the zoom frame reaches the PPI boundary, it is kept there so that it can be accessed at any time. In this case too, the area marked by the frame is displayed in the zoom display.

**Switching Over between a Fixed Zoom Display and a Zoom Display being Carried Along with Own Ship**

The switch-over is done by clicking on the **FIX ABS / FIX REL** button situated in the zoom display.

**FIX ABS** = the zoom frame has a fixed position.

**FIX REL** = the zoom frame is carried along with own ship, maintaining a constant distance and bearing relative to own ship.

**Carrying the Zoom Display Along with a Target**

Click on the target with the **MORE** key, and then click on **ZOOM FIXED ON TARGET** (by means of the **DO** key). The **FIX ABS / FIX REL** button situated in the zoom display now indicates by means of **FIX TGT** that the zoom frame is being carried along with the radar target displayed in the frame.

- By clicking on the **FIX ABS / FIX REL** button or by positioning the zoom frame, the zoom frame is set at a fixed position.

### 13.3 Depth Display

If there is an echosounder connected, the actual and past depth can be displayed in the Depth Display.

#### Switching the Depth Display On/Off

Click on the **MENU** button. Then, in the USER SETTINGS menu, click on the **DEPTH** button.

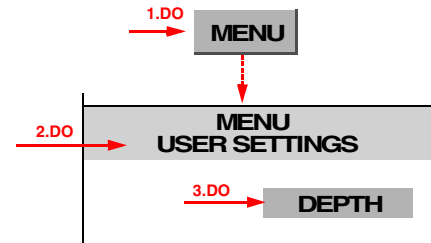

#### Setting the Display Range

Click into the depth scale, then click on the desired display range. If you click on AUTO there, the display range is automatically adapted to suit the measured values.

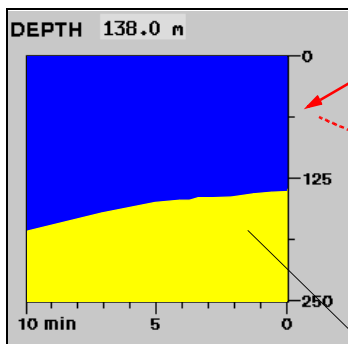

DO

- AUTO**
- 10 m
- 50 m
- 100 m
- 150 m
- 500 m
- 1000 m

The depth range is automatically adapted to suit the measured depth.

Water depth under the keel measured by the navigation echosounder at the location of the selected transducer including the depth history of the past 10 minutes

### 13.4 Wind/Set+Drift Display

If there is a wind sensor connected, the wind data and the set and drift caused by the current can be displayed numerically and graphically on the Wind/Set+Drift Display.

#### Switching the Wind/Set+Drift Display On/Off

Click on the **MENU** button. Then, in the USER SETTINGS menu, click on the **WIND** button.

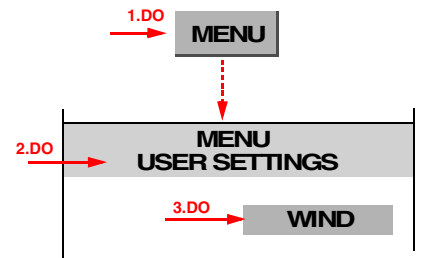

#### Specifying whether the Wind is to be Displayed True or Relative

Switch-over is performed by clicking into the top right-hand area (T or R) of the Wind/Set+Drift Display.

#### Specifying whether the Wind Speed is to be Displayed in kt or in m/s

The switch-over is performed by clicking into the numerical field of the wind speed.

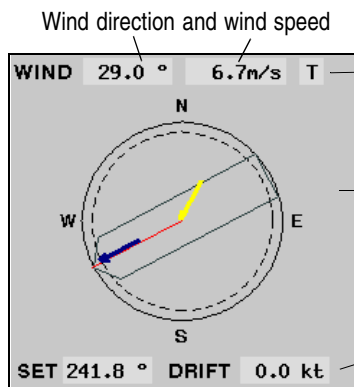

R = relative wind, T = true wind; switch-over by clicking

Ship symbol represents the present Gyro Heading  
 Yellow arrow pointing inwards: Wind direction  
 Blue arrow pointing outwards: Direction of the current  
 Red line: Actual course = Gyro Heading + drift angle

Direction and speed of the current,  
 The values are determined from the available sensor data. If not all of the necessary data are available, the data displayed do not correctly represent the drift vector.  
 Example: If only the longitudinal speed through the water (from an EM log) and the speed vector over ground (from GPS) are available, the displayed set and drift values indicate the offset caused by the current and wind.





# 14 Quick Info Box

## Subjects of this Section:

- ◆ Contents of the Quick Info Box
- ◆ Operating procedure for the stopwatch
- ◆ Setting the Zone Time

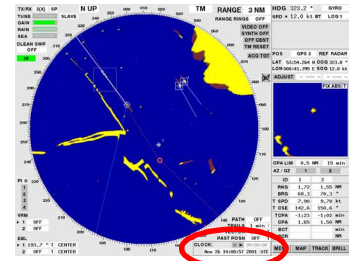

## 14.1 Contents of the Quick Info Box

The position of the cursor defines which data are to be displayed in the Quick Info Box:

### If the cursor is situated in the PPI:

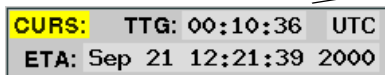

Time that would be needed in order to reach the cursor position at the present speed.

Time of arrival at the cursor position if own ship approaches the cursor position at its present speed

### If the cursor is not situated in the PPI:

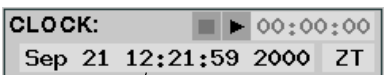

Stopwatch (for operating procedure, see [Section 14.2](#))

Zone Time (for setting see [Section 14.3](#))

Date, time (see also [page 140](#))

### If the cursor is situated on an area that can be operated and the "Help" function is switched on:

☞ For switching on the "Help" function, see [page 19](#)





Actual Function of the DO key

Actual Function of the MORE key

## 14.2 Operating Procedure for the Stopwatch



### Starting the Stopwatch

The stopwatch is started by clicking on the start symbol . The previous timing value is reset to zero. Now, the time which has elapsed since the stopwatch was started is displayed.

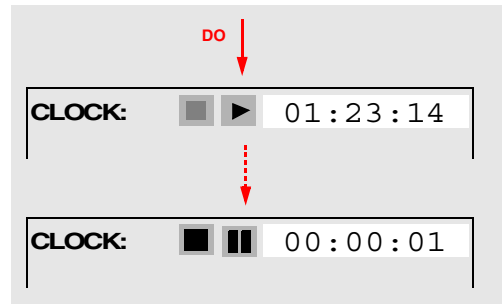
-  The fact that the stopwatch is running can be recognised from the fact that the rectangular symbol is displayed black and not grey (insensitive).



### Displaying the Intermediate Time

- An intermediate time can be displayed by clicking on the pause symbol . The stopwatch continues to run in the background.
- To again display the time which has elapsed since the starting of the stopwatch, you must click on the start symbol  again.



### Stopping the Stopwatch

The stopwatch is stopped by clicking on the stop symbol . The time period measured is now displayed in grey and remains unchanged until the stopwatch is started again.

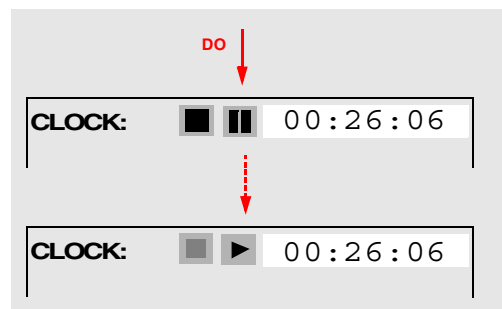

## 14.3 Setting the Zone Time

After clicking on the **ZT** field, the Zone Time can be entered. This setting acts throughout the entire system and can be set between -12 to +12 hours.

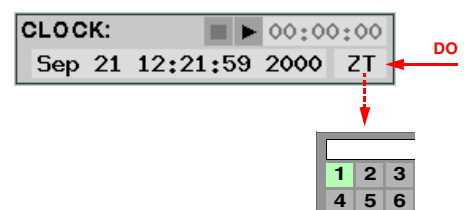

## 15 Evaluation of the Radar Video

### Subjects of this Section:

- ◆ Achievable radar range
- ◆ Radial and azimuthal distortions of the radar video
- ◆ Influences of fog, rain, snow, hail
- ◆ Reflections from the sea surface
- ◆ Disturbances caused by other radars
- ◆ False or indirect echo displays
- ◆ Sectors of reduced radar visibility
- ◆ Superrefraction - subrefraction
- ◆ Sector Blanking

### 15.1 Achievable Radar Range

The **theoretically achievable radar range** limited by the curvature of the earth depends on the height of the antenna above the water surface and the height of the target, and is applicable under normal atmospheric conditions - see the following table.

Antenna Height Above Water Surface	Theoretically Achievable Radar Range at a Target Height of						
	1 m	3 m	10 m	30 m	100 m	300 m	1000 m
8 m	9 NM	12 NM	13 NM	18 NM	28 NM	44 NM	76 NM
15 m	11 NM	13 NM	16 NM	21 NM	31 NM	47 NM	79 NM
30 m	12 NM	16 NM	19 NM	23 NM	34 NM	50 NM	82 NM

Whether radar targets can be detected up to this theoretical range, even with optimum video setting, depends not only on the atmospheric conditions but also on the characteristics of the target:

- Large targets with good reflection characteristics produce strong echo signals and are displayed with corresponding clarity on the screen.
- Smaller targets situated in the shadow of large objects are not illuminated by the radar pulses and are therefore not displayed.
- Flat coasts have an unfavourable reflection cross-section and cannot be recognized until they have been approached more closely. On the other hand, high coastlines and mountainous regions further inland are recognised at a very early stage.
- In the coastal approaches, the tide rip lines and surf areas are displayed similarly to coastlines. However, this rather irritating display can be a valuable orientation aid for the coastal navigator.

- The reflections of radar waves from ice depend largely on the surface structure of the areas illuminated by the radar. Rough and jagged surfaces produce good echo displays, whereas smoothly frozen-over surfaces, rounded surfaces and surfaces at an oblique angle generally reflect the transmitted pulses away from the ship. Thus, for example, the echo display of large icebergs can fluctuate extremely severely, depending on the existing aspect.
- The detection of low-lying blocks of ice (growlers) probably presents the greatest uncertainty:

**WARNING:**

**Even if the anticlutter facilities are operated carefully, the echoes from growlers can no longer be definitely identified if moderate disturbances from the sea surface are present.**

## 15.2 Distortions of the Radar Video

Because of the physical characteristics of the radar principle used, the video displayed does not correspond exactly to the position and form of the reflecting target. A distinction must be drawn between radial distortions (in the direction of the target) and azimuthal distortions (perpendicular to the target direction) - see figure on next page.

### Radial Distortions

Radial distortions in the direction of transmission are caused by the fact that a target reflects the transmitted pulse for as long as the pulse is moving past the target<sup>1)</sup>. Thus, radial lengthening depending on the pulse duration occurs on the screen. In the case of range measurements, it must be noted that the echo edge facing own ship corresponds to the true front edge of the target.

If there are several targets behind one another with small (radial) distances between them, they are shown separately on the screen if, and only if, their distance apart is so large that the radial lengthened echoes do not overlap.

### Azimuthal Distortions

Azimuthal distortions are caused by the width of the beam radiated by the antenna. A point target appears wider the further away it is. At a distance of 10 NM with a horizontal antenna-beamwidth of 1.5°, an individual target is displayed as an arc with a length of 480 m. Because of this effect, individual targets situated beside one another can merge to form a single target.

Not only individual targets but also small spits of land aligned in the radial direction appear wider than they really are, and radially oriented entrances appear narrower than in reality.

 As a result of azimuthal distortions and/or changes in the target position, the radar centroid of a target can change, especially at short range. In the case of a target being tracked, this can lead to a sudden change in the displayed vector.

In addition to these undesirable azimuthal distortions, targets can also be deliberately widened with increasing distance, so that narrow, close-range targets too can be seen clearly. This function is used in the Clean Sweep Modes MEDIUM and OPEN SEA. It ensures that the azimuthal distortion corresponds to the radial distortion over a wide range of distances. Because the radial distortion depends on the pulse length, when Target Enhancement is switched on the targets are displayed particularly large by the selection of **Long Pulse**.

<sup>1)</sup> The pulse length setting **LP** thus generates larger radial distortions than **SP**.

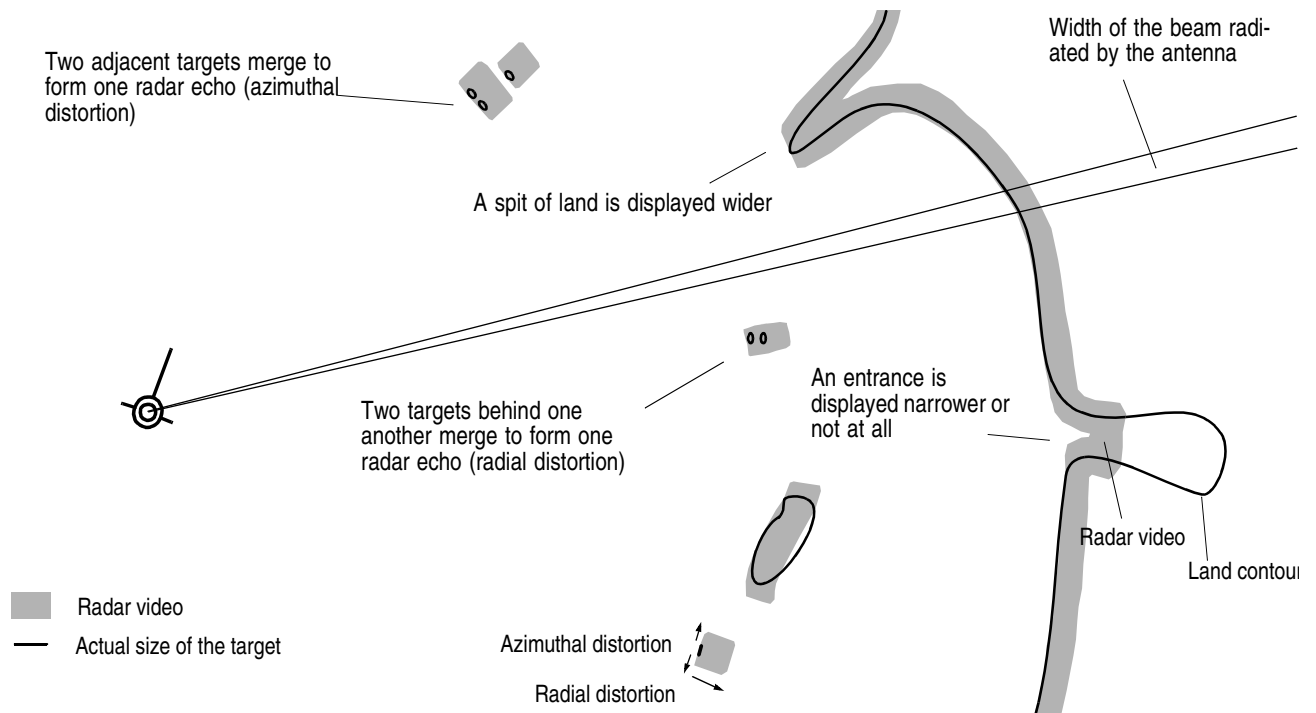

**Radial and azimuthal distortions of the radar video**

### 15.3 Undesirable Echo Displays and Effects

Disturbances of the radar video are caused by

- meteorological processes,
- reflections from the sea surface,
- radar signals from other transmitters,
- false echo displays,
- sectors of reduced radar visibility,
- superrefraction and subrefraction.

#### Influences of Meteorological Processes

The influence of meteorological phenomena such as fog, rain, snow or hail on the radar video increases with the size of the droplets in relation to the radar wavelength, and with the density of the droplets. The shorter-wave X-band radar (with a wavelength of 3 cm) is therefore generally impaired more severely by meteorological influences than is the longer-wave S-band radar (10 cm wavelength).

#### X-Band Radar

Even in the X-band radar, fog causes practically no disturbances, whereas precipitations with larger droplets attenuate the transmitted radar pulses and thus weaken to a greater or lesser extent the display of targets situated behind extensive areas of precipitation. Furthermore, throughout their entire extent, rain, snow and hail reflect part of the transmitted energy and produce echoes in the form of milky areas in the radar video (backscatter).

Because of the very different signal structures of useful targets and rain areas, rain clutter can be noticeably reduced by the rain clutter suppression function.

In the case of strong, extended areas of rain, the losses become so great that the achievable range is reduced very severely. Useful targets might be completely concealed.

### **S-Band Radar**

The S-band radar „sees“ through the rain with practically no attenuation losses, and even detects targets in and behind a rain area. The echo signals caused by the rain are only displayed weakly. Similar behaviour is exhibited in the case of hail and snow.

In this case too, unusually heavy rain can reduce the achievable ranges and thus cause sudden loss of targets.

### **Reflections from the Sea Surface**

Clutter echoes from the surface of the sea can be recognised from the fact that a mostly circular but eccentric area displaced in the wind direction and having non-uniform brightness is formed around the own ship symbol (sea clutter). These echoes make targets in this region more difficult to detect and track, but they have no effect on the display of targets situated behind the reflection zone.

These disturbances are more severe in the case of a radar antenna mounted high up than for one mounted lower down. The area covered by these disturbances increases with increasing sea state, and is increased particularly by steeper waves.

With the aid of the sea clutter suppression function, the disturbance echoes described above can be reduced. However, since this also weakens the display of targets and because the target might not be displayed with every revolution of the antenna, maximum concentration by the observer is necessary. In the case of automatic target tracking, the sea clutter suppression function can lead to the loss of targets due to the attenuation of the signals.

### **Disturbances Caused by Other Radars**

Transmissions from other radars working in the same electrical frequency band occur as disturbances in the form of small points or dashes. These move in rapid succession along straight or curved tracks to the centre of the screen or in the opposite direction.

These disturbances appear particularly clearly at the larger range settings, but they impede radar observation to an insignificant extent only. They can be almost completely eliminated by means of the **Interference rejection** function.

### **False or Indirect Echo Displays**

False or indirect echo displays ("ghost echoes") occur as a result of reflection of the radar pulses by the ship's own superstructures of all kinds and by nearby objects that reflect very well. Therefore, a typical feature of these echoes is that they appear at the bearing of the reflecting surface, regardless of the real position of the targets.

When two ships pass one another on parallel courses, multiple echoes can often be observed as a result of pulses reflected to and from several times between the ships' sides. On the screen, a series of equispaced echo displays of decreasing intensity appears at the bearing of the object.

### **Sectors of Reduced Radar Visibility**

Sectors of reduced radar visibility occur as a result of own ship's superstructures which impair and prevent rectilinear propagation of the radar pulses. Theoretical determination of the geometry of these sectors and of their influence on the display of targets is possible to an inadequate extent only. An effective practical method consists of determining the shadow sectors against the background of disturbance signals from the sea surface (sea clutter).







## 16 The Radar Keyboard

### Subjects of this Section:

- ◆ Functions of the keys and rotary knobs on the optional radar keyboard
- ◆ The operating panel of the flat screen monitors AZ3056 and AZ3063

The radar keyboard is used to provide fast, convenient access to those functions that are used frequently. When this keyboard is used, the operating possibilities described in the other sections of these operating instructions continue to be available in full. Alternating operating actions are possible at all times.

- ☞ In the configuration described in these Operating Instructions, the **CONN MODE** button has no function.

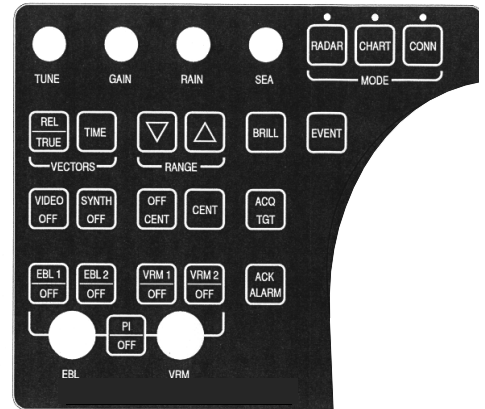

For [Section 2.3, Brilliance and Colour Selection](#) (see [page 21](#)):

### Brilliance, Colour Selection

By pressing of the **BRILL** key, the BRILLIANCE menu is opened; then use the procedure described in [Section 2.3](#).



### Setting the Illumination of the Keyboard

Press the **BRILL** key or click on the **BRILL** button. Then click on the **PANEL** area, and use the trackball to make the desired setting. Then press the DO key.

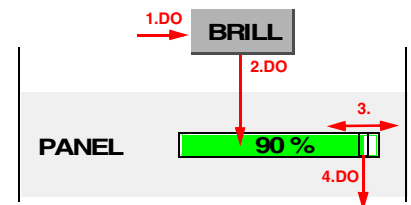

For [Section 2.4, Degaussing](#) (see [page 23](#)):

### Degaussing

By pressing of the **BRILL** key, the BRILLIANCE menu is opened; then use the procedure described in [Section 2.4](#).



For [Section 2.5, Display Modes](#) (see [page 24](#)):

Only if there is a CHARTPILOT installed:

### Switching the Radar Display Mode on

By pressing of the **RADAR MODE** key, the Radar Display Mode is switched on. The radar PPI is displayed. In addition, a map can be displayed.

The green lamp above the key indicates this setting.

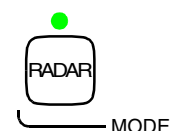

For [Section 2.5, Display Modes](#) (see [page 24](#)):

Only if there is a CHARTPILOT installed:

**Switching the Chart Display Mode on**

By pressing of the **CHART MODE** key, the Chart Display Mode is switched on. The radar PPI is displayed. In addition, User Chart Objects can be displayed. On the CHARTRADAR, the vector charts that exist on the CHARTPILOT can be displayed additionally.

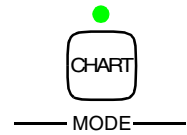

The green lamp above the key indicates this setting.

For [Section 3.3, Centering / Off-Centering of the Display \(Center, Off-Center\)](#) (see [page 31](#)):

**Centering the Display**

By pressing of the **CENT** key, own ship is centered in the PPI.





**Off-Centering the Display**

Move the cursor to the intended position of own ship's symbol within the PPI on the screen, and press the **OFF CENT** key.



For [Section 3.4, Range Selection \(Range\)](#) (see [page 31](#)):

**Selecting the Next Larger or Next Smaller Range**

The next smaller range is switched on by means of the key , and the next larger range is switched on by means of the key .



 The change-over from the docking ranges to the nautical ranges is also performed in this way.

For [Section 3.6, The Setting of Vectors](#) (see [page 34](#))

**Setting the Length of the Vectors**

Press the **TIME** key, and use the trackball to set the vector length.

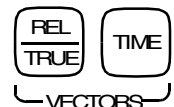

**Switching the Vectors to Relative or True Display Mode**

The switch-over is performed by pressing the key **REL/TRUE**.

As a result, the past position plots too are switched over to relative or true display mode.

For [Section 4.2, Basic Setting of the Radar Video](#) (see [page 49](#)):

**Tuning, Gain, Rain Clutter Suppression and Sea Clutter Suppression**

These settings can be made at any time by means of the rotary knobs **TUNE**, **GAIN**, **RAIN** and **SEA**. If an automatic function is switched on (**AFC**, **AUTO RAIN**, **AUTO SEA**), it is automatically switched off when the corresponding rotary knob is operated.

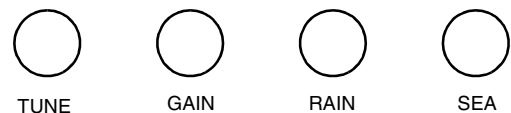

For [Section 4.7, Suppression of the Synthetics and Video](#) (see [page 53](#)):

**Suppression of the Synthetics or Video**

If the **SYNTH OFF** key is pressed, no synthetics are displayed on the PPI.  
 For as long as the key **VIDEO OFF** is pressed, no video is displayed.



For [Section 6.2, Variable Range Markers \(VRM's\)](#) (see [page 63](#)):

**Using One VRM**

If the VRM is in the switched-off state, it is switched on by pressing of the key **VRM1** or **VRM2**, and the rotary knob **VRM** is assigned to that VRM. The desired distance can now be set by means of the rotary knob. If the **VRM** key that was pressed previously is pressed again, this switches the VRM off.

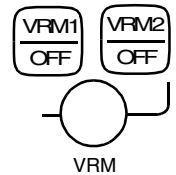

**Switching the Second VRM On and Using It**

If one VRM is in the switched-on state, the second VRM too is switched on by pressing of the other **VRM** key, and the rotary knob **VRM** is assigned to the second VRM. The desired distance of the second VRM can now be set by means of the rotary knob.

**Using Both VRM's**

If both VRM's are switched on, the first pressing of a **VRM** key assigns the rotary knob to that VRM, and the second pressing in succession causes switch-off of the VRM.

- ☞ The arrow in front of the **VRM** area indicates the VRM which can currently be altered by means of the rotary knob.
- ☞ If the display range was reduced when the VRM was in the switched-on state, it may be that the VRM is situated outside the visible range. When the **VRM** knob is operated, the VRM appears at the edge of the PPI.

For [Section 6.3, Electronic Bearing Lines \(EBL's\)](#) (see [page 64](#)):

**Using One EBL**

If the EBL is in the switched-off state, it is switched on by pressing of the key **EBL1** or **EBL2**, and the rotary knob **EBL** is assigned to that EBL. The desired bearing can now be set by means of the rotary knob. If the **EBL** key that was pressed previously is pressed again, this switches the EBL off.

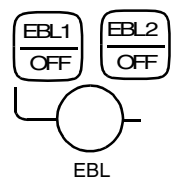

**Switching the Second EBL On and Using It**

If one EBL is in the switched-on state, the second EBL too is switched on by pressing of the other **EBL** key, and the rotary knob **EBL** is assigned to the second EBL. The desired bearing of the second EBL can now be set by means of the rotary knob.

**Using Both EBL's**

If both EBL's are switched on, the first pressing of an **EBL** key assigns the rotary knob to that EBL, and the second pressing in succession causes switch-off of the EBL.

- ☞ The arrow in front of the **EBL** area indicates the EBL which can currently be altered by means of the rotary knob.  
 The setting of the EBL origin and the display of the relative bearing can be performed only by means of an operating procedure on the display.

For [Section 6.5, Parallel Index Lines](#) (see [page 66](#)):

### Selection of the Parallel Index Line that is to be Operated

Click on the PI key once or several times until the triangle is positioned beside the parallel index line that is to be operated.

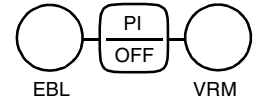

### Switching On and Off the Display of Parallel Index Lines

By pressing the **PI** key for a longer time, the display of the selected parallel index line is switched on and off.

### Moving a Parallel Index Line

The distance of the parallel index line is set by means of the VRM knob, and its direction is set by means of the EBL knob.

For [Section 7.3, Manual Target Acquisition](#) (ARPA radar) (see [page 69](#)):

### Manual Target Acquisition

Move the cursor to the target video, and press the **ACQ TGT** key.



For [Section 8.1, Manual Target Acquisition and Semi-Automatic Plotting](#) (EPA radar) (see [page 75](#)):

### Beginning the Plotting of a Target

Move the cursor to the target video, and press the **ACQ TGT** key.



For [Section 17, Alarm Management](#) (see [page 117](#)):

### Acknowledging an Alarm

If there is an acoustic signal, it is switched off by pressing of the **ACK ALARM** key. If there is no acoustic signal (or if there is no longer an acoustic signal), the alarm marked in colour is acknowledged with the **ACK ALARM** key.

The red lamp above the key lights up if there is an alarm which has not been acknowledged.



# 17 Alarm Management

## Subjects of this Section:

- ◆ Display of alarms
- ◆ Switching the acoustic signal off
- ◆ Acknowledgement of alarms
- ◆ Setting the sounding of the acoustic signal
- ◆ Monitoring of the Computer

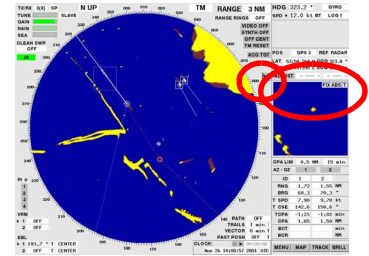

If the radar wants to draw the operator's attention to a situation which might require his intervention, it generates an **alarm**. This alarm is displayed in the alarm list which opens automatically in the Multidisplay.

Many alarms are supplemented by an acoustic signal - see [Section 18](#).

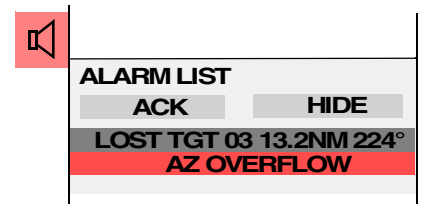

### Behaviour when an Alarm Occurs

1. **Switch off the acoustic signal** (if there is one) as follows:  
In the alarm list, click on the **ACK** (= acknowledge) button or on the coloured horn symbol. As a result, the acoustic signal is switched off on the radar indicator that is being operated.
2. Immediately obtain information about the **causes of the alarm**, about the **system status** and about possible **system reactions**, and - if necessary - immediately **perform all necessary actions for the avoidance of possible danger**.
3. **Removing the cause of the alarm:** If the alarm has occurred due to a cause that can be removed, that cause must be removed as quickly as possible; see also [Section 29](#). Many alarms disappear when the cause disappears. Acknowledgement is then unnecessary.
4. **The alarm must be acknowledged if the situation allows or requires such acknowledgement:**  
In the alarm list, press the **ACK** button or click on the coloured horn signal. As a result, the alarm which is marked in colour is usually acknowledged, i.e. it is removed from the alarm list. As a result of this, alarms which have also been distributed to other items of equipment within the system are acknowledged there too. If some other alarm is marked, the alarm which is to be acknowledged must be marked beforehand by clicking. <sup>1)</sup>

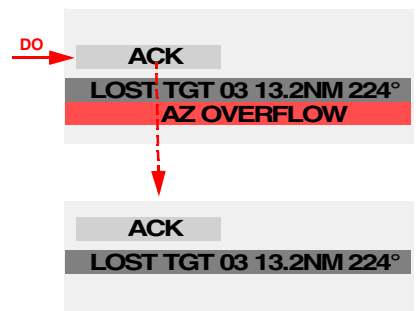
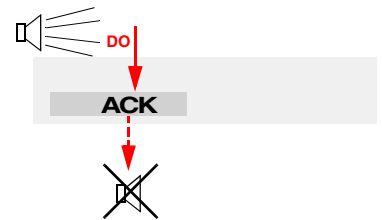

If alarms are also distributed to other items of equipment within the system, or if the system deviates from the behaviour described above, e.g.

- if the alarm cannot be acknowledged at all or throughout the entire system, or
- if acknowledgement causes something to be initiated or enabled, or
- if an acknowledged alarm is repeated for as long as the cause of the alarm continues to exist,

<sup>1)</sup> If the display of the list has been switched off even although an alarm that can be acknowledged has not been acknowledged, that alarm is automatically marked as soon as the list is opened again. Only in this case is it necessary, after opening of the alarm list, to mark the most recent alarm by clicking before acknowledgement.

this situation is mentioned in [Section 29](#). In all cases, this second pressing of the **ACK** button or of the coloured horn symbol switches off on all items of equipment the acoustic signal caused by the alarm.

**Generally Switching On and Off the Acoustic Signal for Particular Alarms**

For the alarms marked with the symbol  in [Section 18](#), it is possible to specify whether or not there should be an acoustic signal when these alarms occur. This setting applies jointly to all alarms marked in this way.

The switch-over is triggered by clicking on the **BUZZER** button in the USER SETTINGS menu.

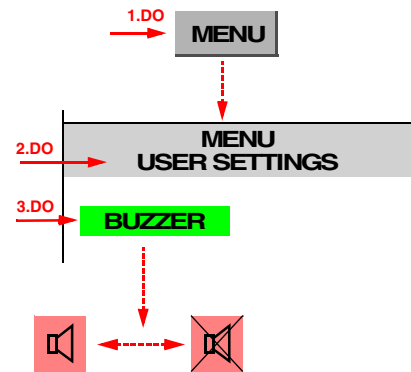

 When the alarm tone is switched off, the horn symbol has a cross superimposed on it.

**Switching Off the Display of the Alarm List**

When the last remaining alarm shown in the alarm list is acknowledged, the display of the alarm list is switched off automatically. The horn symbol appears on a grey background, indicating that there are no alarms that have not been acknowledged.

The display of the alarm list can be switched off even when there are one or more alarms. This is done by clicking on the **HIDE** button in the alarm list. The **horn symbol** meanwhile continues to be coloured. This indicates that there is at least one alarm that has not been acknowledged.

 Even if the display of the alarm list has been switched off by means of the **HIDE** button, the alarm list opens automatically as soon as another alarm occurs.

**Switching the Display of the Alarm List On**

If there is an alarm that has not been acknowledged, the display of the alarm list can be switched on at any time by clicking on the **horn symbol**.

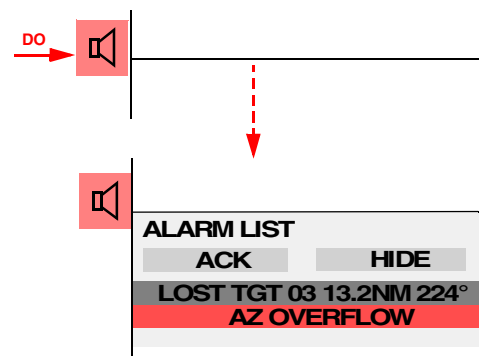

**Monitoring of the Computer**

If the computer of the display electronics unit fails completely, the **PPI is covered by a red square**. If this display continues to exist even after the radar system has been switched off and then switched on again, there is a fault which can be corrected only by service personnel.

**Prevention of Triggering of the Watch Alarm**

If the installation has been performed appropriately, any operating action performed on the radar indicator will have the same effect as the operating of a watch alarm key.

# 18 List of Alarms

## Subjects of this Section:

- ◆ The meaning of the individual alarm indications possible remedies
- ◆ Special features in the case of acknowledgement
- ◆ Possible remedies

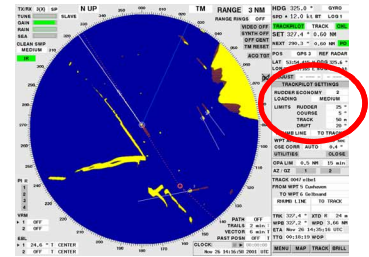

The sounding of an **acoustic signal** is defined by the following symbols:

- 🔊 The acoustic signal is sounded regardless of how the **BUZZER function** is set in the USER SETTINGS menu; see [page 118](#).
- 🔊 The acoustic signal is sounded only if the **BUZZER function** is switched on in the USER SETTINGS menu.
- (🔊) Whether an acoustic signal is sounded depends on the factors described.

If no symbol is stated, the alarm appears without an acoustic signal.

### AZ OVERFLOW

The number of targets which can be tracked in the acquisition/guard zone is exceeded.

**Remedy:** Check the acquisition/guard zone; delete targets.

### CHART SERVER OFFLINE

- 🔊 The CHARTPILOT from which the chart data are taken is no longer sending any data. Therefore, chart data are no longer available.

**Remedy:** Check the CHARTPILOT or switch to Radar Display Mode.

### DANGEROUS TGT yy.yNM zzz° (yy.y=distance zzz=true bearing)

- 🔊 The tracked target situated at the displayed distance and bearing has become a dangerous target, because the CPA and TCPA values have become smaller than the limits that were set for them.

### ECDIS APPROACHING WAYPOINT

- 🔊 The ECDIS has detected that the next Wheel Over Point will be reached soon. Details are displayed on the CHARTPILOT. For explanations, see the Operating Instructions of the CHARTPILOT.

### ECDIS CHECK LEG

The ECDIS has detected that the existing track segment of the System Track is touching a potentially dangerous region or object. For explanations, see the Operating Instructions of the CHARTPILOT. <sup>1)</sup>

<sup>1)</sup> This alarm should be acknowledged on the CHARTPILOT after the nautical situation has been checked there with the aid of the Electronic Chart.

**ECDIS CHECK NEXT LEG**

The ECDIS has detected that the next track segment of the System Track is touching a potentially dangerous region or object. For explanations, see the Operating Instructions of the CHARTPILOT. <sup>1)</sup>

**ECDIS COURSE LIMIT**

 The ECDIS has detected that the actual course is deviating too much from the set course defined by the System Track. Details are displayed on the CHARTPILOT.

**ECDIS DEPTH ALARM**

 The ECDIS has detected that the water is not deep enough. Details are displayed on the CHARTPILOT.

**ECDIS OBJECT OF INTEREST**

 The ECDIS has detected that an Electronic Chart object being monitored is being touched by the Guard Sector or that the ship is situated over such an object. Details are displayed on the CHARTPILOT. For explanations, see the Operating Instructions of the CHARTPILOT. <sup>1)</sup>

**ECDIS SAFETY CONTOUR**

 The ECDIS has detected that the Safety Contour is being touched by the Guard Sector or that the ship is situated in an excessively shallow region defined by the Safety Contour. Details are displayed on the CHARTPILOT. For explanations, see the Operating Instructions of the CHARTPILOT. <sup>1)</sup>

**ECDIS TRACK LIMIT**

 The ECDIS has detected that the ship is too far away from the System Track. Details are displayed on the CHARTPILOT.

**Remedy:** Increase the Track Limit, if the nautical situation allows this.

**ECDIS USER CHART OBJECT**

 The ECDIS has detected that a User Chart Object of the class "Own Safety Line" or "Danger Highlight" is being touched by the Guard Sector, that the ship is situated over such an object, or that the System Track is touching such an object. Details are displayed on the CHARTPILOT. For explanations, see the Operating Instructions of the CHARTPILOT. <sup>1))</sup>

**GYRO FAULT**

 The compass is switched off, or has failed, or is reporting incorrect data.

- or -

The gyro interface has failed.

**Remedy:** Check the compass, the signal transmission and the gyro interface.

**GYRO VALID**

 The compass is again sending valid data.

If a compass is installed which sends heading changes only, the heading transfer must be synchronised again.

 For this purpose, after the acoustic signal is switched off, the virtual keyboard appears automatically, showing the heading that was sent last; for further procedure, see [page 57](#).



**INTERSWITCH OFFLINE**

The computer of the display electronics has no contact with the Interswitch.

- or -

The Interswitch is reporting a malfunction.

**LATITUDE EXCEEDED**

The 85th parallel of latitude has been exceeded. The radar is no longer processing position-data. Any functions which require position data, e.g. Track Mode, may no longer be used here.

**LOG STATUS CHANGED**

The log selected as the speed sensor has changed its status, e.g. from Bottom Track to Water Track. It is sending valid data.

**Remedy:** Check what change of status is involved; if necessary, select some other speed sensor.

**LOST TGT xx yy.yNM zzz° (xx=target label yy.y=distance zzz=true bearing)**

The tracked target situated at the displayed range and bearing has got lost.

**MAGNETRON FAULT**

The selected transceiver is reporting magnetron overcurrent.

Acknowledgement is performed by switching the radar over to stand-by.

**Remedy:** Switch the transceiver over to stand-by, and then switch it back to radar operation. If the alarm occurs repeatedly, request service.

**MAINTENANCE ACTIVE**

The System Maintenance Manager is switched on. Its menu might cover the PPI (partially).

**MAP FILE SYSTEM OVERFLOW**

The file system provided for the maps is full. An attempt to store a map has failed.

**Remedy:** Delete map data no longer used.

**NO ANTENNA AZIMUTH**

The azimuth angle information of the antenna is missing.

**Remedy:**

- If the antenna is not rotating: check the ship's mains and/or the antenna fuse or circuit-breaker
- If the antenna is rotating: request service.

**NO HEADMARKER**

The antenna's headmarker signal is missing.

**Remedy:**

- If the antenna is not rotating: check the ship's mains and/or the antenna fuse or circuit-breaker
- If the antenna is rotating: request service.

**NO RADAR VIDEO**

The system is in a faulty condition, such that the radar video cannot be generated.

**Remedy:**

- Check the radar transceiver
- Check the antenna
- Request service.

**NO TRIGGER**

The radar transmission trigger is missing.

**Remedy:** Check the radar transceiver.

**OPERATING UNIT FAILURE**

An active keyboard/trackball unit has failed.

**Remedy:** If installed, reactivate the master keyboard/trackball unit or try to activate another slave keyboard/trackball unit. Otherwise switch the radar off and on again.

**PLANNING SYSTEM OFFLINE**

A track is used whose data are held in storage in the CHARTPILOT, but the CHARTPILOT is no longer sending any data.

**Remedy:** Check the CHARTPILOT.

**PLOT xx ABORTED (xx=target label)**

The permissible period of time for the input of a plot marker (on the EPA radar) has been exceeded; the plot cannot be continued; the marker of the designated target is deleted.

 This indication appears 5 minutes after the indication **PLOT xx NO UPDATE**, unless a plot marker has been input.

**PLOT xx NO UPDATE (xx=target label)**

 For the designated target, no update has taken place within the past 10 minutes. In order to continue the plot, a plot marker must now be set within 5 minutes.

**POSITION STATUS CHANGED**

 The selected position sensor has performed an internal status-change (e.g. from DGPS to GPS) or has changed the reception process (e.g. from DECCA to LORAN).

 The acoustic signal is not sounded if a change takes place from GPS to DGPS and no position offset has been set.

### POSITION INVALID

- ☞ The selected position sensor is sending invalid position data. The position is currently being determined by dead reckoning; therefore, as the position sensor, **EP** is now displayed.
- ☞ After acknowledgement, the system automatically recommends a substitute sensor and displays its data in the Multidisplay. The sensor which is now selected by the operator continues to be treated as a substitute sensor, i.e. as soon as the position sensor which led to the **POSITION INVALID** alarm is sending valid data again, the **POSITION VALID** alarm appears. If the substitute sensor is no longer to be classified as such, that sensor or some other one must be selected anew. After that, the **POSITION VALID** alarm no longer appears. Alternatively, it is possible to switch over to EP = Estimated Position.

### POSITION TIMEOUT

- ☞ Data are no longer being received from the selected position sensor.
- The position is currently being determined by dead reckoning; therefore, as the position sensor, **EP** is now displayed.
- ☞ After acknowledgement, the system automatically recommends a substitute sensor and displays its data in the Multidisplay. The sensor which is now selected by the operator continues to be treated as a substitute sensor, i.e. as soon as the position sensor which led to the **POSITION TIMEOUT** alarm is sending valid data again, the **POSITION VALID** alarm appears. If the substitute sensor is no longer to be classified as such, that sensor or some other one must be selected anew. After that, the **POSITION VALID** alarm no longer appears. Alternatively, it is possible to switch over to EP = Estimated Position.

### POSITION VALID

- ☞ The position sensor which had given the **POSITION INVALID** or **POSITION TIMEOUT** alarm is again sending valid data.
- ☞ After acknowledgement, the system displays the data of the sensor which had given the **POSITION INVALID** or **POSITION TIMEOUT** alarm. After checking the new sensor-data, either confirm this sensor by clicking on the **SELECT** button or select some other sensor.

### SENSOR MASTER CHANGED

- ☞ This radar system has taken over the task of managing the navigation data because the item of equipment which had previously been performing that task has failed. It must be assumed that sensor data which the failed item of equipment had previously been passing on to the system are now missing.

### SENSOR MASTER FAILS

- ☞ The radar system which manages the navigation data has failed. The management task has been taken over by a different radar system. It must be assumed that sensor data which the failed radar system had previously been passing on to the system are now missing.

**SPEED INVALID**

 The speed sensor is sending invalid data. At present, the speed that was last sent as the valid speed is being used. Dashes are shown in the speed area.

 After acknowledgement, the system automatically preselects a substitute sensor and shows its data in the Multidisplay. The sensor which is now selected by the operator continues to be treated as a substitute sensor, i.e. as soon as the speed sensor which led to the **SPEED INVALID** alarm is again sending valid data, the **SPEED VALID** alarm appears.

If the substitute sensor is no longer to be classified as such, then either that sensor or some other one must be selected anew. After that, the **SPEED VALID** alarm no longer appears.

If no other speed sensor is selected, the **SPEED INVALID** alarm is repeated at intervals of one minute.

**SPEED TIMEOUT**

 The selected speed sensor is no longer sending valid data. At present, the speed that was last sent as the valid speed is being used. Dashes are shown in the speed area.

 After acknowledgement, the system automatically preselects a substitute sensor and shows its data in the Multidisplay. The sensor which is now selected by the operator continues to be treated as a substitute sensor, i.e. as soon as the speed sensor which led to the **SPEED TIMEOUT** alarm is again sending valid data, the **SPEED VALID** alarm appears.

If the substitute sensor is no longer to be classified as such, then either that sensor or some other one must be selected anew. After that, the **SPEED VALID** alarm no longer appears.

If no other speed sensor is selected, the **SPEED TIMEOUT** alarm is repeated at intervals of one minute.

Alternatively, it is possible to switch over to manual input of speed.

**SPEED VALID**

 The speed sensor which had given the **SPEED INVALID** or **SPEED TIMEOUT** alarm is again sending valid data.

 After acknowledgement, the system displays the data of the sensor which had given the **SPEED INVALID** or **SPEED TIMEOUT** alarm. After checking the new sensor data, either confirm this sensor by clicking on the **SELECT** button or select some other sensor.

**SYSTEM FAULT xxxxx**

The system fault xxxxx is present (xxxxx = fault code for the system fault).

This alarm indicates that there is a technical fault which is impairing, or could impair, the functioning of the radar or of the system. If such an alarm is occurring frequently or if it persists for some time, the service organisation should be informed of this.

 With the System Maintenance Manager, a list of the existing system faults can be displayed. The System Maintenance Manager records the occurring faults if the **Refresh** function is in the switched-on state - see [page 134](#).

 The brief explanation (intended for the service personnel) contained in the system fault list can also be displayed by clicking on the system fault in the alarm list by means of the MORE key.

**TARGET IN AZ yy.yNM zzz°** (yy.y=distance zzz=true bearing)

 A target which is not yet being tracked has been acquired automatically in the acquisition/guard zone.

**TARGET IN GZ yy.yNM zzz°** (yy.y=distance zzz=true bearing)

A target which is already being tracked has entered the acquisition/guard zone.

**TRANSCIVER OFFLINE**

The indicator electronics has no contact with the selected transceiver.

- or -

The transceiver is reporting a malfunction.



---

## 19 List of the Alarm Signal Outputs

---

The alarm signals mentioned in the following are provided by the radar system in the form of electrical contacts. Whether the signals are displayed in a given case, and if so in what form, depends on the installation and on the type of alarm system involved. Therefore, no statement about this can be made here.

### Radar Alarm

Each radar indicator emits this signal if one of the following alarms is generated:

- **GYRO FAULT,**
- **INTERSWITCH OFFLINE,**
- **MAGNETRON FAULT,**
- **NO ANTENNA AZIMUTH,**
- **NO HEADMARKER,**
- **NO RADAR VIDEO,**
- **NO TRIGGER,**
- **PLANNING SYSTEM OFFLINE,**
- **POSITION TIMEOUT,**
- **SPEED TIMEOUT,**
- **TRANSCEIVER OFFLINE.**

If an appropriate setting has been made at service level, the radar alarm is also emitted if the **SYSTEM FAULT** alarm appears.

The radar alarm is also emitted if switch-off of the display electronics unit occurs or if the supply voltage to the display electronics unit has failed.

### ARPA Alarm

Every radar indicator emits this signal if one of the following alarms is generated <sup>1)</sup>:

- **DANGEROUS TGT,**
- **LOST TGT,**
- **TARGET IN AZ,**
- **TARGET IN GZ.**

### Chart Alarm

Every radar indicator emits this signal if one of the following alarms is generated (by the CHARTPILOT):

- **ECDIS APPROACHING WAYPOINT,**
- **ECDIS COURSE LIMIT,**
- **ECDIS DEPTH ALARM,**
- **ECDIS OBJECT OF INTEREST <sup>2)</sup>,**
- **ECDIS SAFETY CONTOUR <sup>2)</sup>,**
- **ECDIS TRACK LIMIT,**
- **ECDIS USER CHART OBJECT.**

### Dead Man Alarm Trigger

Every radar indicator emits this signal when any operating action is performed on its keyboard. Therefore, if the installation has been performed appropriately, there is no need to operate a special watch-alarm key when a radar indicator is being operated.

---

<sup>1)</sup> For each of the alarm messages mentioned, it is possible to specify at service level that the ARPA alarm should not be triggered.

<sup>2)</sup> This alarm leads to the emission of the Chart Alarm signal if, and only if, the **To Alarm Panel** function is in the switched-on state on the CHARTPILOT (in the Alarm Settings menu in Chart Mode).





---

## 20 Care and Maintenance Work

---

### Subjects of this Section:

- ◆ Care of the system's components
- ◆ Routine maintenance work

### 20.1 Care

---

Care of the components of the radar system is limited to occasional cleaning of the screens on the monitors. This should be done with a soft cloth moistened with alcohol.

### 20.2 Maintenance Work

---

The ship's personnel must regularly carry out the following maintenance work:

#### **The cleaning of the filter pad on the Display Electronics Unit and on the TRACKPILOT Electronics Unit.**

If conditions are normal, this work should be done once every 3 months. If the environment is particularly dusty, it should be done more frequently, and if the air contains very little dust, it can be done less frequently.

1. **Taking out the filter pad:** It is situated on the top of the display electronics unit, and can be gripped and pulled out by its front left-hand corner without unscrewing the covering cap.
  - ✎ If the display electronics unit is installed in the console, the hinged cover situated below the operating unit must first be opened.
2. **Cleaning the filter pad:** Cleaning can be done by washing in soapy water, or by blowing the dust out with compressed air, or - depending on the degree of dirtiness - simply by beating the dust out.
3. **Inserting the filter pad:** When inserting the filter pad, which must have been dried (if necessary, by jolting it thoroughly to get the water out of it), make certain that it is seated properly.

#### **Test of the Transmission Power and Receiver Sensitivity of the Radar Transceiver**

The test described in [Section 21](#) should be performed at the beginning of every sea voyage, and once a week during the voyage.



## 21 Performance Monitor

### Subjects of this Section:

- ◆ Checking the transmitter performance
- ◆ Checking the receiver sensitivity

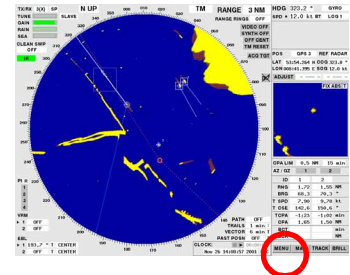

With the Performance Monitor, the transmitter performance and the receiver sensitivity can be checked.

To check the **transmitter performance**, the antenna gearbox contains an auxiliary antenna in the radiating region of the main antenna. The signal received by this auxiliary antenna is processed and produces a "good/bad" display. This check thus covers the entire RF transmitting branch of the transceiver, including the magnetron (which is subject to natural aging), the waveguide and the antenna.

The **receiver sensitivity** is checked by inputting a signal directly at the receiver input, which leads to a "good" display if, and only if, the amplification is adequate.

### Performing the Test

#### IMPORTANT:

During the test, the radar cannot be used for navigation.

1. Perform tuning as described in [Section 4](#).
2. Click on the buttons **MENU**, **UTILITIES** and **PERFORMANCE MONITOR** one after the other. After the safety-related question which then appears has been answered suitably, the radar is automatically switched to the following settings:
  - RANGE = 24 NM
  - RAIN = 0
  - SEA = 0
  - CLEAN SWEEP = OFF
  - IR = OFF

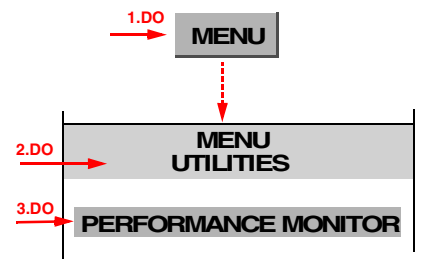

If the high revolution rate of the antenna is switched on, a switch-over to the normal revolution rate takes place automatically.

Beside the **GAIN** area, the coloured symbol **PM** appears, indicating that the Performance Monitor is switched on.

3. Perform tuning and set the gain so that the noise is only just visible and no more.
4. On the PPI, a sector is displayed as the result for the check of the transmitting performance, and a circle is displayed as the result for the check of the receiving performance.

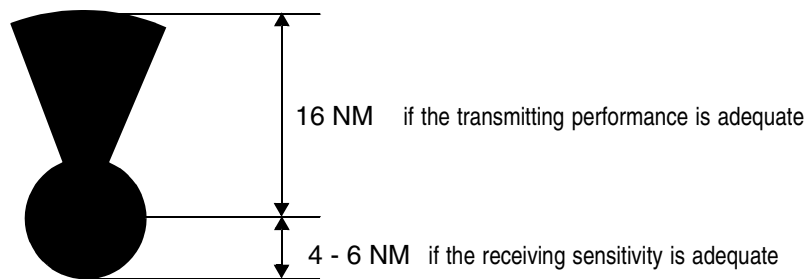

**The desired display produced by the Performance Monitor**

### Evaluation:

If the sector has a radius of about 16 NM, the transmitting performance is adequate.

- ☞ The transmitting performance is permitted to drop by 6 dB relative to the nominal performance and still be regarded as adequate. The sector then still has a radius of approximately 16 NM. If the transmitting performance drops by more than 6 dB, the sector radius is reduced to 6 NM or less.

The receiving sensitivity is adequate if the circle has a radius of at least 4 NM.

- ☞ The receiving sensitivity is permitted to drop by 5 dB relative to the nominal sensitivity and still be regarded as adequate. The radius of 4 NM corresponds to a reduction of 5 dB.

### WARNING:

**If these displays do not have the values mentioned, this means that the performance quality of the radar system is no longer adequate for safe radar operation. Request service!**

- ☞ Not only the magnetron that is being checked with this test but also the toothed belts of the antenna gearing are expendable parts. Therefore, if the test shows that the magnetron has reached the end of its useful life, the toothed belts also must be exchanged during the necessary service work.
5. Switch off the Performance Monitor by clicking on the symbol **PM**.
  6. Perform tuning as described in [Section 4](#).

# 22 System Maintenance Manager

### Subjects of this Section:

- ◆ Determining the versions of software, hardware and documentation
- ◆ Listing the system faults
- ◆ Copying the data of versions and the system faults to a diskette
- ◆ Off-line selfchecks
- ◆ Checking / correcting the computer time
- ◆ Copying and saving the map data
- ◆ The handling of diskettes
- ◆ Aborting and restarting the program of the radar system

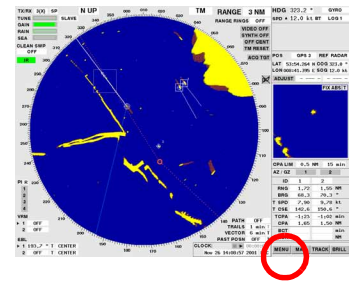

The System Maintenance Manager is a subroutine which is installed for maintenance purposes but also provides the following functions for the operator.

**IMPORTANT:**

The menu of the System Maintenance Manager partly covers the PPI. Therefore, the System Maintenance Manager may be started only if the radar system is not being used for navigation.

This opens the **Selfcheck** index card; for illustration, see [page 136](#)

This opens the **Tools** index card; for illustration, see [page 140](#)

This opens the **Telemonitoring Data** index card; for illustration, see [page 134](#)

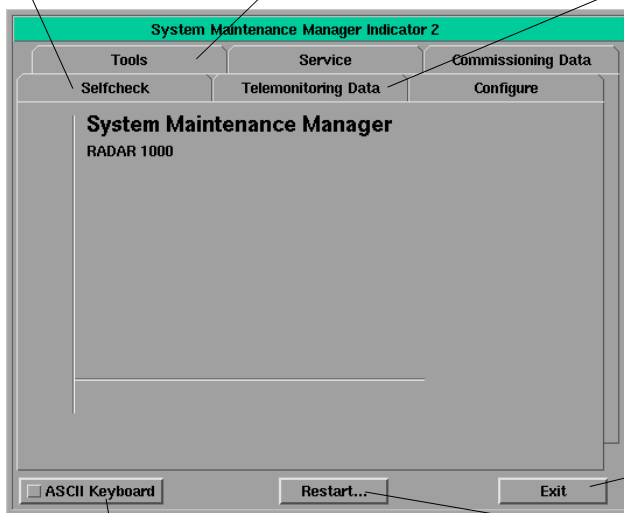

Do not use

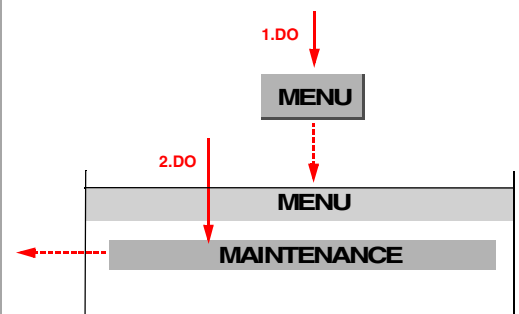

This switches off the System Maintenance Manager.

Aborts the operating program of the radar system and then restarts it., see [page 144](#)

### Switching the System Maintenance Manager On

Click on the **MENU** button and then on the **MAINTENANCE** button. The menu of the System Maintenance Manager appears.

The menu is organised in the form of a card index box. Only the **Selfcheck**, **Telemonitoring Data** and **Tools** index cards contain operator functions. The superordinate key **ASCII Keyboard** shall not be used by the operator.

### Switching Off the System Maintenance Manager

In the menu of the System Maintenance Manager, click on the **Exit** button.

## 22.1 Determining the Versions of Software, Hardware and Documentation

The versions of the unit's software and hardware can be indicated, as well as the appropriate version of the customer documentation: Click on the index card **Telemonitoring Data**, and then click on **Versions**. The following then appears:

- **CHARTRADAR** or **RADARPILOT**: The software version of the unit
- **Documentation**: The number and revision index of the associated documentation. These data must be present on the title pages of the documents used.
- **IMB Image**: Software version of the IMB (the central assembly on which the program is stored).
- **PCB Versions**: The electronics assemblies installed, with their software versions

 These data, together with the system fault lists, can be transferred as a file to diskette - see [page 135](#).

## 22.2 Listing the System Faults

System faults that have occurred (which generate the alarm indication **SYSTEM FAULT xxxxx**) can be listed. The list can be transferred as a file to diskette, and is then available for further transfer. This function, which is provided for service use, is also accessible to the operator because, in the event a fault, a service visit can be better prepared or even omitted if the service station can be informed of the fault codes beforehand.

### Listing the Currently Existing System Faults

Click on the **Telemonitoring Data** index card, and then click on **Faults**. All system faults that exist at the time are listed under **Present Faults**. New faults are added to the list if and only if the square in the **Faults** button is green (can be switched on and off by clicking of the **Faults** button).

### Listing the System Faults that have Occurred

After clicking of the **Fault History** button, two lists appear additionally:

**Fault History**: Contains all faults that have occurred since switch-on of the indicator, in the sequence in which they first appeared. Contents:

**Date/Time**: Time of the most recent occurrence

**Count**: Number of occurrences since switch-on of the unit

**Fault**: Fault code

**Dev, Subdev**: Unit/assembly in which the fault occurred

**Info**: Brief description of the fault

List of system faults

Listing the system faults that have occurred

This produces a list of the system faults that exist

Green: The fault list is continually updated

Display of the versions of software, hardware and documentation; see [Section 22.1](#)

This deletes the display of data

With this, the fault data and information about the versions are transferred to diskette

Fault	Dev	SubDev	Info (Tue Jun 04 17:15:58 2002)
02011	TRM	COMM	checkword timeout
03617	AIS	XPDR	receive timeout

**System Integrity Faults:** If an entire process fails, this event is recorded here. Contents:

- Time:** The time of the most recent failure,
- Count:** Number of failures since switch-on of the unit,
- Task:** The process that has failed.

**Transferring the Fault Data and Version Data to Diskette**

Put a DOS-formatted 3.5" diskette into the diskette drive <sup>1)</sup> and click on **Save to Disk**.

The ASCII file **TMD.txt** is then copied onto the diskette. This file contains

- identification data of the ship, and the current date,
- the version data which can be determined according to [Section 22.1](#),
- the list **Fault History**,
- the list **System Integrity Faults**.

<sup>1)</sup> The write protect function must be in the switched-off state, i.e. the bottom left-hand hole must be closed.

## 22.3 Off-Line Selfcheck

With the selfcheck, important components of the radar system can be checked. The ARPA function test permits periodical checking of the ARPA's performance features.

### Starting the Selfcheck

1. Click on the **Selfcheck** index card.
2. In the list, click on the desired check.
3. Click on the **Start Test** button. The menu of the System Maintenance Manager disappears, and the box of the relevant self-test appears.

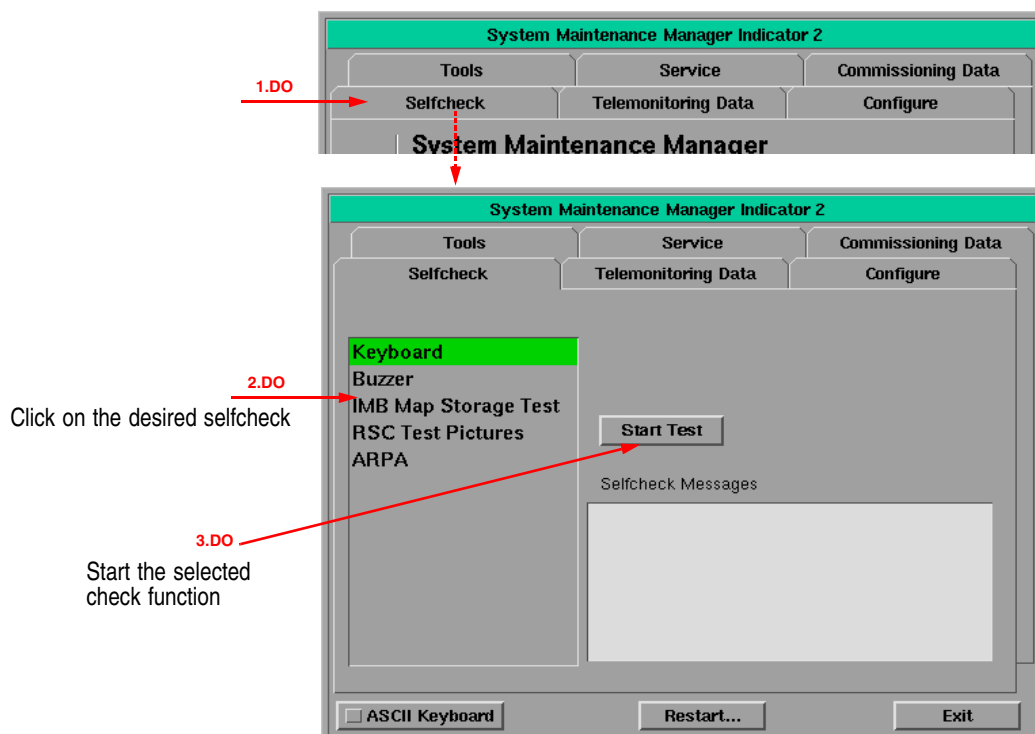

### Ending the Selfcheck

At top right in the boxes of the self-test, there is an area containing a cross. By the clicking of this area, the test is ended.

### Testing the Trackball and the (optional) Keyboard

In the list, select **Keyboard**. After the start, a schematic picture of the operating elements appears.

If, when the keys in that picture are operated, the corresponding area gives a coloured flash of light, this means that the key is functioning properly.

If the coordinate values displayed at the trackball symbol change in accordance with the trackball movement, this means that the trackball is functioning properly.

If the boxes situated at the rotary knob symbols fill up in accordance with the operation of the rotary knobs, this means that the rotary knobs are functioning properly.



**Testing the Acoustic Alarm**

In the list, select **Buzzer**. After the start, a list of the various acoustic alarm signals appears.

If, after you have clicked on the button that exists there, the relevant acoustic signal is sounded, this means that the acoustic alarm is OK.

**Testing the Map Memory**

In the list, select **IMB Map Storage Test**. After the start, the test result appears under **Selfcheck Messages**.

**Checking the Image Processing of the Radar Video**

In the list, select **RSC Test Pictures**. After the start, a list of the various test figures that can be displayed appears. By means of these test figures, you can determine whether the Raster Scan Converter (RSC) is working properly.

 In the case of pictures 1 to 3, only the brilliance adjustment function is acting; in the case of pictures 4 to 6, the adjustment functions for gain and range are acting additionally.

**Picture 1**

In each row of blue to yellow squares, the yellow intensity must increase from left to right.

The squares move slowly downwards.

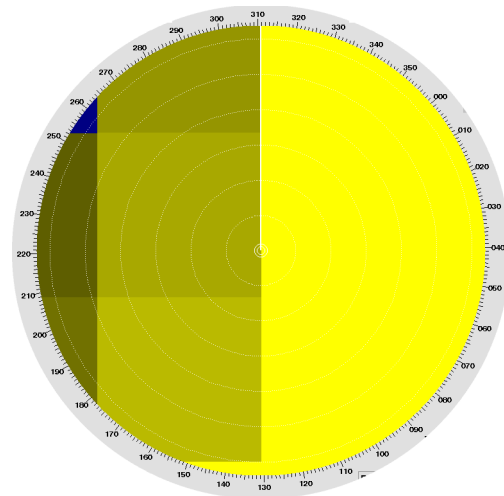

**Picture 2**

In the middle square, 16 colours are displayed cyclically one after another.

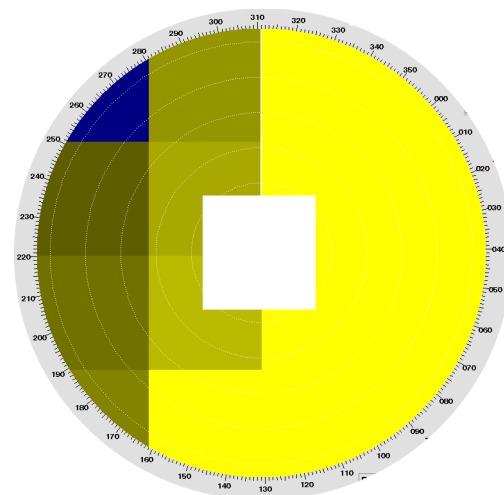

**Picture 3**

Each of the four sectors has eight intensities. They are moved round in the clockwise direction.

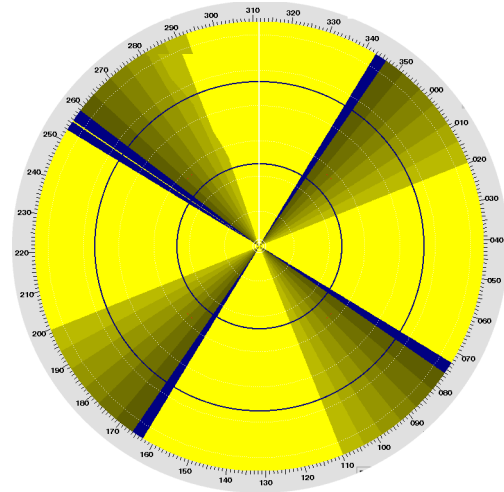
**Picture 4**

The illustration shows the test picture in the following case:

- Range: 6 NM
- Gain: Normal setting

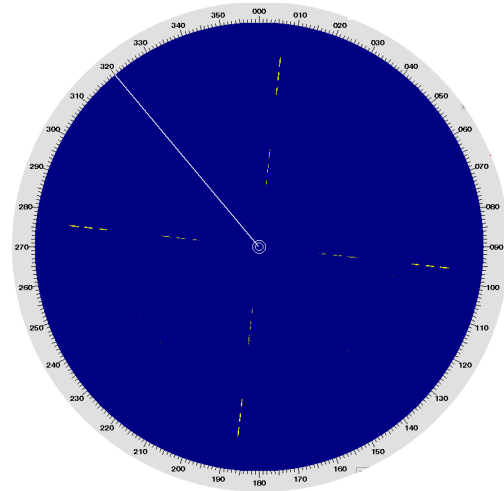
**Picture 5**

The illustration shows the test picture in the following case:

- Range: 6 NM
- Gain: 90%

If the gain is reduced, the intensity of the rings decreases, beginning with the inner rings of the sets of six.

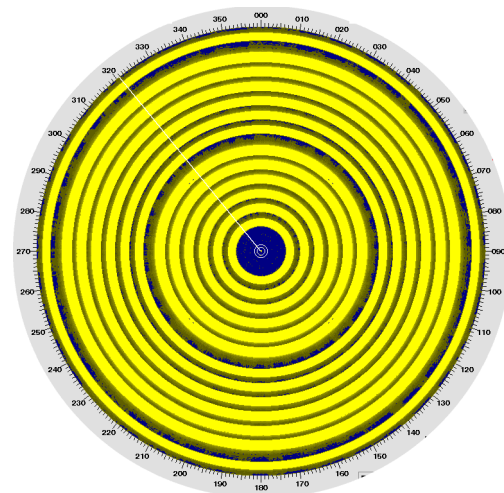

**Picture 6**

The illustration shows the test picture in the following case:

- Range: 24 NM
- Gain: Maximum

Each of the broad rings consists of rings arranged inside each other without gaps. If the gain is reduced, the intensity of these rings decreases, beginning with the inner ring.

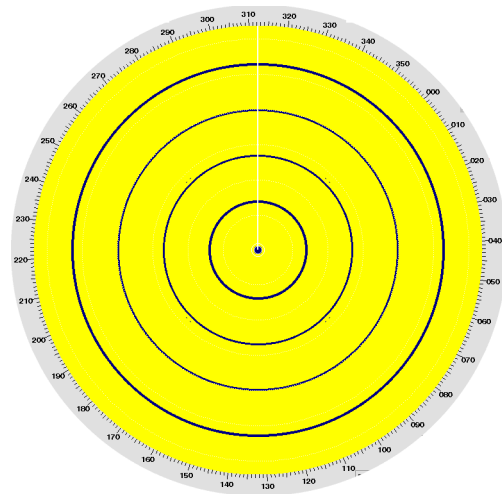
**ARPA Function Test**

By means of the ARPA function test, the overall performance of the ARPA can be assessed. This should be done periodically.

Set Range to 6 NM. In the list, select **ARPA**. After the start, this picture appears. The individual echoes displayed are synthetic targets:

- It must be possible to acquire them manually.
- When the acquisition / guard zone is placed over one or more targets, automatic acquisition must take place, together with the associated symbols and alarms. The targets must be tracked automatically.
- All targets travel along with your own ship. Therefore, their true courses and true speeds must be the same as your own ship's course and speed.

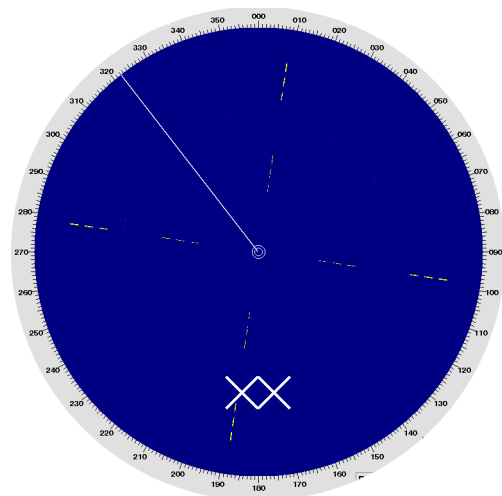

## 22.4 Checking / Correcting the Computer Time

As long as the system is receiving the date and time via a connected sensor (e.g. from a GPS receiver), these data are displayed in the relevant displays of the system, e.g. in the Quick Info Box of the radar indicator <sup>1)</sup>. If this external information is missing, the date and time with which the internal clock of the relevant display electronics unit's computer is running (computer time) are displayed instead.

So that the displayed time does not change if the sensor fails, a check should occasionally be made on all radar indicators to make certain that the computer times are in agreement with UTC. If necessary, the computer times must be corrected.

### Checking the Computer Time

1. Click on the index card **Tools**.
2. Click on **Date & Time**.
3. System time and date are displayed under **Set Time** and **Set Date**.

### Changing the Computer Time

1. Under Set Time or Set Date, click into the numerical areas of the value that is to be changed.
2. Using the small keys in front of the numerical areas, set the values correctly.  
 ☞ The set values have to be valid when the **Apply & Save** button will be clicked finally.
3. The set values are taken over by pressing of the **Apply & Save** button.
4. Abort and restart the program of the radar system, see [page 144](#).

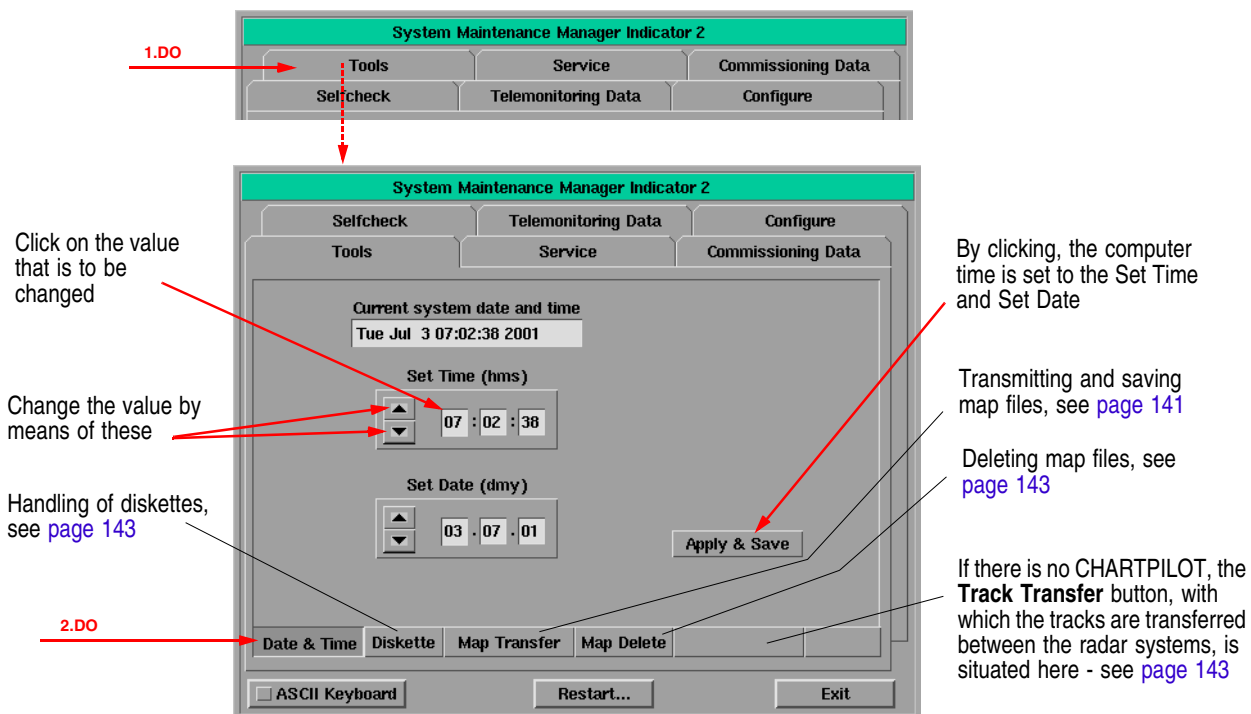

<sup>1)</sup> Plus the Zone Time. The time received is UTC; the computer times too must be UTC.

## 22.5 Distribution and Deletion of Map Data; Data Saving

New or altered map data must be distributed to all radar indicators on which they are to be displayed. If necessary, map data can also be deleted. It is recommended that the most recent set of data should be saved on diskette.

- ☞ The most recent set of data should be available on all radar indicators (unless there are particular reasons opposing this). One of the advantages of this is that it prevents loss of the most recent data, which would occur if map data on an indicator containing old data were edited and if the map data were then distributed.

### File Structure of the Map Data

For the division of the map data into individual files, the earth's surface is divided up into areas measuring 3° by 3°. All symbols and lines situated in such an area are grouped within a file.

- ☞ Lines going beyond one of these boundaries are cut at the boundary during the process of division into files, and are joined together again when the files are called up for the purpose of display or processing.

Furthermore, the earth's surface is divided up into areas measuring 15° by 15°. All map files belonging to such an area are grouped within a catalog.

For the **designation of the files and catalogs**, the south-west corner of the area is used in all cases; files have the file extension **.D03**, and catalogs have the extension **.D15**:

- The file S39E144.D03 contains all map data situated in the area bounded by the 39th and 36th southern lines of latitude and by the 144th and 147th eastern lines of longitude.
- The catalog **N15W075.D15** contains all map files of the data that are situated in the area bounded by the 15th and 30th northern lines of latitude and by the 75th and 60th western lines of longitude.

- ☞ Just as a map file and the catalog are automatically created as soon as a symbol or line is edited for the defined area, so are the file and (if applicable) the catalog deleted again as soon as there are no longer any symbols and lines (or parts of lines) present in the area defined for the file and catalog.

### Transferring Map Files to Other Radar Indicators

1. Click on the index card **Tools**.
2. Click on **Map Transfer**, then on **Transmit**.
3. Click on the field under **Destination**. Mark the indicator to which the data are to be transferred, or **All indicators** if the data are to be transferred to all installed radar indicators.
  - ☞ The indicator designations listed here are identical to those entered in the header bar of the System Maintenance Manager. If in doubt, switch on the System Maintenance Manager of the destination unit, and have a look.
4. In the **Files in Source** list, mark the catalog or file that is to be transferred. If all files are to be transferred, mark the list entry at the top, designated by "/". By clicking on the **Add >>** button, put the marked files and catalogs into the **Files to Transfer** list.
5. Repeat procedure 4 for other files/catalogs that are to be transferred.
  - ☞ If too many files/catalogs have been entered by mistake, the content of the **Files to Transfer** list can be deleted and procedure 4 can be repeated.
6. When all files/catalogs to be transferred have been entered, start the transfer by clicking on the **Transfer** button.

During the transfer, an appropriate message appears below the **Files in Source** list and the data currently being transferred are marked in the right-hand list.

Defining the transfer direction:

**Transmit** pressed: The transfer takes place from the indicator being operated to the unit entered under **Destination**.

**Receive** pressed: The transfer takes place from the unit entered under **Source** to the indicator being operated.

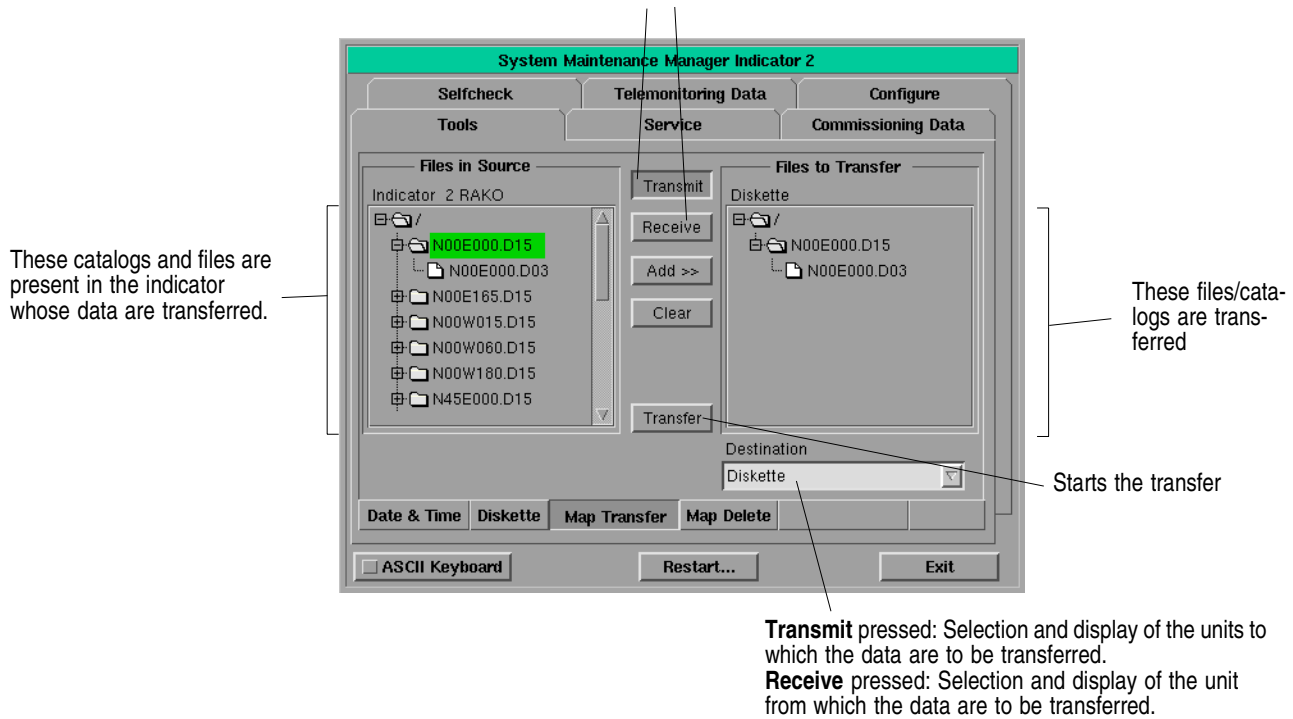

### Transferring Map Files from Another Radar Indicator to the One being Operated

Similar to [Transferring Map Files to Other Radar Indicators](#):

1. Click on the index card **Tools**.
2. Click on **Map Transfer**, then on **Receive**.
3. Click on the field under **Source**. Mark the indicator from which the data are to be fetched.
4. In the **Files in Source** list, mark the catalog or file that is to be transferred. By clicking on the **Add >>** button, put the marked files and catalogs into the **Files to Transfer** list.
5. Repeat procedure 4 for other files/catalogs that are to be transferred.
6. Start the transfer by clicking on the **Transfer** button.

### Deleting Map Files

Similar to [Transferring Map Files to Other Radar Indicators](#):

1. Click on the index card **Tools**.
2. Click on **Map Delete**.
3. Click on the field under **Source**. Mark the indicator (or **Diskette** for the inserted diskette) on which the data are to be deleted.
4. In the **Files in Source** list, mark the catalog or file that is to be deleted. By clicking on the **Add >>** button, put the marked files and catalogs into the **Files to Delete** list.
5. Repeat procedure 4 for other files/catalogs that are to be deleted.
6. Click on the **Delete** button. After the safeguard question which then appears has been answered with Yes, all map files entered in the **Files in Source** list which are contained in the data medium selected in the **Source** field are irretrievably deleted.

### Data Saving and Data Restoration

Data saving is done in the same way as [Transferring Map Files to Other Radar Indicators](#), except that a DOS-formatted 3.5" diskette is inserted in the diskette drive <sup>1)</sup> and that in procedure 3 **Diskette** is selected instead of an indicator.

 If a dialog box containing the remark **File ... does not fit on disk!** opens up, the diskette is full: insert a new diskette and click on **Retry**.

Data restoration is done in the same way as [Transferring Map Files from Another Radar Indicator to the One being Operated](#), except that the saving diskette is inserted in the diskette drive and that in procedure 3 **Diskette** is selected instead of an indicator.

## 22.6 Exchanging Track Files between the Indicators; Data Saving

---

If there is no CHARTPILOT, the track files too must be exchanged between the radar indicators, and the process of saving the data of these track files must be performed on the radar indicator. This is done in almost exactly the same way as the transfer and data-saving of the map files - see [Section 22.5](#); the only difference is that, instead of **Map Transfer**, the **Track Transfer** button is selected for this.

## 22.7 The Handling of Diskettes

---

The most important diskette-handling actions that can be performed on any PC are also possible on the radar indicator:

1. Click onto the index card **Tools**.
2. Put the diskette into the diskette drive and click on **Diskette**.
3. As a result of clicking on **Info**, the currently valid capacity data of the inserted diskette appear in the frame **3.5" Diskette** after a short waiting time.

As a result of clicking on **Erase**, all data on the diskette are erased after confirmation via a safeguard question.

---

<sup>1)</sup> The write protect function must be in the switched-off state, i.e. the bottom left-hand hole must be closed.

As a result of clicking on **Format**, the diskette is DOS-formatted after confirmation via a safeguard question.

## 22.8 Aborting and Restarting the Program of the Radar System

---

If a malfunction occurs in the radar system in the modes mentioned, and if this malfunction cannot be corrected by means of the operating actions described in this document, an attempt can be made to correct the fault by aborting and restarting the radar system program:

In the System Maintenance Manager, click on the **Restart** button, and answer **Yes** to the question which then appears.