



## **Warning**

### **RF Exposure Warning :**

- ※ The radiated output power of this device is below the FCC radio frequency exposure limits. Nevertheless, the device should be used in such a manner that the potential for human contact during normal operation is minimized. In order to avoid the possibility of exceeding the FCC radio frequency exposure limit, human proximity to the antenna should not be less than 6 feet during normal operation.

## **Information to user**

- ※ The user's manual or instruction manual for an intentional or unintentional radiator shall caution the user that changes or modifications not expressly approved by the party responsible for compliance could void the user's authority to operate the equipment. In cases where the manual is provided only in a form other than paper, such as on a computer disk or over the Internet, the information required by this section may be included in the manual in that alternative form, provided the user can reasonably be expected to have the capability to access information in that form.

# Contents

SRG-3150DN Rev.1.1(080409)

<b>SRG-3150DN How to operate basic function and Distress transmitting</b>	
1. Set MMSI ID .....	5
1.1. Self-ID .....	5
2. SSB mode.....	5
2.1. Channel Selection .....	5
2.2. Frequency Selection.....	5
2.3. TX, RX .....	5
3. DSC mode.....	5
3.1. Channel Selection .....	5
3.2. Frequency Selection.....	5
3.3. Call .....	6
3.4. DSC Message RX Auto Reply .....	6
4. Distress transmit .....	6
 <b>How to use SN-100 NBDP Terminal</b>	
1. Selection of Channel.....	6
2. Selection of Frequency .....	6
3. ARQ mode.....	6
4. FEC mode.....	6
 <b>Chapter 1. Overview .....</b>	<b>7</b>
1.1. Features .....	7
1.2. Basic Components.....	8
 <b>Chapter 2. Specifications.....</b>	<b>9</b>
2.1. General specification.....	9
2.2. MF/HF Transmitter.....	9
2.3. MF/HF Receiver.....	9
2.4. DSC (Digital Selective Calling) W/K Receiver .....	10
2.5. MF/HF Control .....	10
2.6. Digital Selective Calling (DSC) .....	10
2.7. Narrow band direct Printing (NBDP).....	11
2.8. Printer (DPU-414).....	11
2.9. Printer (OKI).....	11
 <b>Chapter 3. Power Supply .....</b>	<b>12</b>
3.1. Power On.....	12
3.2. Operation by AC power.....	12
3.3. Operation by DC (BATTERY) power.....	12
3.4. BATTERY Charging.....	12
 <b>Chapter 4. Front Panel .....</b>	<b>13</b>
4.1. About Button, Knob, Lamp .....	13
4.2. LCD display.....	14
4.3. LCD display flow.....	15
 <b>Chapter 5. SSB (TEL) mode.....</b>	<b>16</b>
5.1. SSB Mode.....	16
5.2. SSB Menu .....	16
(1) Scan Type Set .....	16
(2) Scan Channel Set.....	16
(3) Scan Frequency Set.....	16

(4) SQL Set .....	16
(5) LCD Contrast Set .....	17
(6) Tx Power Set .....	17
(7) Manual Tuning .....	17
(8) ATU – Version (ATU Program Version) .....	17
(9) Remote Set .....	17
(10) System Set .....	17
5.3. Additional Functions (ITU Channel, AM mode, Etc.) .....	18
<b>Chapter 6. Digital selective calling (DSC) mode .....</b>	<b>19</b>
6.1. The selection of DSC mode .....	19
6.2. DSC menu display .....	19
(1) Distress msg edit .....	19
(2) Individual msg edit .....	20
(3) Group msg edit .....	21
(4) Geography msg edit .....	22
(5) Auto/Semi-AT msg edit .....	25
(6) Dist ack/rly msg edit .....	26
(7) Ordinary ack msg edit .....	28
(8) Display and print msg .....	28
(9) System Set .....	28
<b>Chapter 7. Transmitter of distress signal .....</b>	<b>32</b>
7.1. Test of Distress alert signal .....	32
<b>Chapter 8. RX of Distress &amp; general call .....</b>	<b>33</b>
8.1. RX of Distress Alarm .....	33
8.2. General call RX .....	34
<b>Chapter 9. How to use print .....</b>	<b>35</b>
9.1. DPU-414 Printer .....	35
9.2. OKI Printer .....	35
<b>Chapter 10. How to use SD-250(Alarm box) .....</b>	<b>36</b>
10.1. Distress transmitting .....	36
10.2. In case of receiving distress signal .....	36
10.3. Operation by DC (Battery) .....	36
<b>Chapter 11. How to use SP-1250ADC .....</b>	<b>36</b>
11.1. Specification .....	36
11.2. Input power shift .....	36
11.3. How to Charge .....	36
11.4. In case of over current .....	36
<b>Chapter 12. Circuit explain .....</b>	<b>37</b>
12.1. Overview of SRG-3150DN .....	37
12.2. CONTROL CIRCUIT (T-1110) .....	38
(1) MF/HF RX Circuit .....	38
(2) MF/HF TX Circuit .....	38
(3) Local Synthesizer Circuit .....	39
(4) Power Supply Circuit .....	39
(5) Control Circuit .....	40
12.3. MH/HF Transmitting Filter Circuit (T-1101) .....	40
12.4. W/K Receiving Circuit (T-1112) .....	41
12.5. Power Amplifier Circuit (T-1113) .....	41

12.6. Front Panel (T-1114) .....	41
12.7. Function Diagram of Rear Side .....	42
<b>Chapter 13. NBDP Terminal .....</b>	<b>43</b>
13.1. NBDP Terminal Main Unit .....	43
13.2. Initial Display of Telex (NBDP) mode .....	43
(1) Initial screen function explanation .....	43
(2) Initial screen function button explanation .....	43
(3) Control function in Keyboard .....	44
13.3. SettingUpTX/RX Frequency .....	44
(1) Setting TX frequency .....	44
(2) Setting Rx frequency .....	44
(3) Coast Radio Station TX/RX frequency set up .....	44
(4) Setting TX/RX Freq. by calling channel .....	44
13.4. [ARQ] mode .....	44
(1) Connecting with the other station by ARQ mode .....	44
(2) Connecting specific station .....	45
(3) Communication in ARQ mode .....	45
(4) Transmitting file .....	46
(5) Transmitting of Macro Command .....	46
13.5. [FEC] mode .....	46
(1) Connecting the other station by Selective FEC mode .....	46
(2) Connecting with the other station by collective FEC mode .....	47
(3) Communication in FEC mode .....	47
(4) Receiving of FEC mode .....	47
(5) Transmitting file .....	48
(6) Transmitting of Macro Command .....	48
13.6. Other sea station or ship station edit & resister frequency .....	48
13.7. Station print (Counter party & Frequency print) .....	49
13.8. Registration of macro command .....	49
13.9. Editor mode .....	49
13.10. Initial setting of system set .....	50
(1) Setting of [0. ARQ/FEC 4~ or 5~digit ID] .....	50
(2) Setting of [1. ARQ/FEC 9-digit ID] .....	50
(3) Setting of [2. Answer Back Code] .....	50
(4) Setting of [3. Collective FEC Receiving] .....	50
(5) Setting of [4. Maximum FEC Error Ratio] .....	50
(6) Selecting of [5. NAVTEX Station Selection] .....	51
(7) Selecting of [6. NAVTEX Message Selection] .....	51
(8) Selecting of [7. NAVTEX ID Data Clear] .....	51
(9) [8. ID Printing] set up .....	51
(10) [9. Etc. Setting] set up .....	51
13.11. NBDP test .....	52
13.12. LCD Off .....	52
<b>Chapter 14. NBDP Terminal Circuit .....</b>	<b>53</b>
14.1. Overview .....	53
14.2. Connection board T-020 .....	53
14.3. NBDP receiving unit (T-132) .....	53
14.4. Local Synthesizer board (T-133) .....	53
14.5. Power Circuit (T-025) .....	53
14.6. Function Diagram of Rear Side .....	53
<b>Chapter 15. Troubleshooting .....</b>	<b>54</b>

15.1. Overview.....	54
15.2. Measuring Instrument.....	54
15.3. Maintenance & repair of SRG-3150DN .....	54
(1) Antenna .....	54
(2) Power Supply .....	54
(3) Transmitter .....	54
(4) Receiver .....	54
(5) DSC Receiver .....	54
(6) Switch and Display .....	55
15.4. NBDP SN-100.....	55
(1) Power Supply .....	55
(2) Screen Display .....	55
(3) NBDP Data Receiving.....	55
(4) NBDP Data Transmitting.....	55
15.5. Modulation of simple modulator .....	55
15.6. Caution.....	55

**Chapter 16. Circuit Diagram & External Diagram..... 56**

## SRG-3150DN How to operate basic function and Distress transmitting

### 1. Set MMSI ID

(Maritime Mobile Service Identity)

- Press  button and ON, It stop at the below initial display,
- Then input **SELF ID** or handle dial/key of the front panel to be operated regularly.

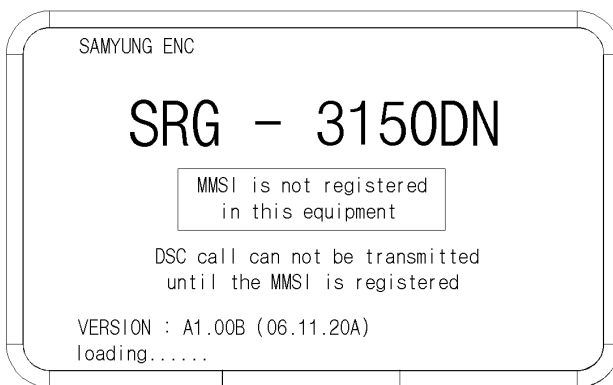













< ↑ Initial Screen >

#### 1.1. Self-ID

- [DSC] mode  / '9. SYSTEM SET' / '1. Self ID set'





#### Ex) Input ID 111100000 :

Press any key on the initial screen



- Press  to go to [DSC] mode
-  →  →  →  →  →  →  →
-  →  → twice Press( → ) and then go out to 'Main Menu'. (Indicated MMSI Number in the right side on the bottom)



### 2. SSB mode

#### 2.1. Channel Selection

- Press  to go to [SSB] mode
- select to the channel by dial [CH]
- [ Ref. ]  Press twice ( → ) and select to [CH] → input channel with [No. button] and then press → .

#### 2.2. Frequency Selection

- 1) Press twice ( → ) and select to [TX]
- Input frequency by [No. button]
- press .

- 2) Press twice ( → ) and select to [RX]
- Input frequency by [No. button]
- press .

[ Ref. ]  Missing frequency range, Cannot be input with alarm sound.

#### 2.3. TX, RX

##### 1) TX

- Can use it after inputting to the frequency TX/RX that want to communicate.
- Press  to go to [SSB] mode
- input the frequency that want to communicate
- Press [Mike switch(PTT)] and communicate.





[ Ref. ]  Don't have a ATU Tuning date valor of the first channel, ATU Tuning run automatically to the emergency TX(2,182 / 2,1875 / 4,2075 / 6,312 / 8,4145 / 12,477 / 16,8045 kHz).

##### 2) Received gain adjustment



- Be easy to hear on condition of low noise as down GAIN and up VOLUME.

### 3. DSC mode

#### 3.1. Channel Selection



- Press  to go to [DSC] mode
- select to the channel by dial [CH]
- [ Ref. ]  Press twice ( → ) and select to the channel [CH] and input the wanted channel by [Number] and then press .

#### 3.2. Frequency Selection

- Press twice ( → ) and select [TX]
- Input the wanted frequency by [No. button]
- press .

[ Ref. ]  Missing frequency range, Cannot be input with alarm sound.

### 3.3. Call

- Press  to go to [DSC] mode
- select to the channel by dial [CH]
- 

### 3.4. DSC Message RX Auto Reply

- When receive DSC message and Auto ACK on, can work automatic answer.
- When receive DSC but Auto ACK off and then don't work automatic answer.

#### (1) How to set

[DSC] mode press  / '9.SYSTEM SET' / '0.Etc Set' / '4.Auto Ack' and finished setting.

## 4. Distress transmit

### 4.1. Transmit signal(DISTRESS) by Emergency Transmitter KEY

(1) Hold on 3 seconds  [DISTRESS] and then transmit signal.

(2) If you don't have any reply, flicker the red[DISTS]display as follow on screen and transmit channel from 1 to 6 after 4 minutes(3min.and 30sec ~ 4min.40sec.).

(3) Press  and then stop to transmit.

## How to use SN-100 NBDP Terminal

## 1. Selection of Channel

1.1. Change [CH] on screen  
 →Select wanted channel by [No. button]  
 → and press [Enter]

1.2. Press [F6]  
 →Input the wanted channel by [No. button]  
 → Press [Enter]

## 2. Selection of Frequency

2.1. TX  
 • Press[F7]  
 →input the wanted communicate frequency by [Number]  
 →press[Enter]

### 2.2. RX

• Press[F8]  
 →input the wanted communicate frequency [Number]  
 → press[Enter]

## 3. ARQ mode

• Hold [F2], Select [ARQ] You can access to one by ARQ MODE.

## 4. FEC mode

• Hold [F2], Select [FEC] You can access to one by FEC MODE.

## Chapter 1. Overview

- GMDSS(Global Maritime Distress and Safety System) is an internationally recognized distress and radio communication safety system for ships replacing the previous ship to ship safety system, which relied on a manual Morse code system on 500 kHz and voice radiotelephony on Channel 16 and 2182 kHz. The GMDSS is an automated ship to shore system using satellites and digital selective calling technology.

The GMDSS is mandated for ships internationally by the International Maritime Organization (IMO) Safety of Life at Sea Convention (SOLAS), 1974, as amended in 1988, and carries the force of an international treaty.

- SRG-3150 and SN-100 are composed of MF/HF transceiver, DSC, DSC W/K Receiver, NBDP, Automatic alarm telephone for suitable automatic digital communication at the distress and safety/normal situation.

SN-100 uses being connected to Transceiver(SRG-3150DN), output sub-carrier signal to transmit NBDP data, displays the information on the display which is demodulated RX signal receiving from antennas.

- SRG-3150DN frequency range :  
TX : 1.6MHz~27.5MHz  
RX : 500kHz~29.99999MHz
- Type of Frequency/Power :  
J3E : 150W(HIGH)/100W(MID)/50W(LOW),  
F1B : 100W(HIGH&MID)/75W(LOW).

### 1.1. Features

#### (1) Possible Range

- Because MF/HF Transceiver(SRG-3150DN), DSC W/K Receiver, DSC, Distress alarm telephone is built in SRG-3150DN, You are able to use itself without NBDP terminal(SN-100). NBDP function is worked by connecting SN-100 terminal, However it is not available to use NBDP terminal only.

#### (2) Total Control System

- SRG-3150DN is set up with the major modules combined as one unit or circuits within a single cabinet. Thus, it is possible to rationalize the total control system by interlinking the respective module controls.

- And narrow band direct printing is available by connecting NBDP unit(SN-100) to SRG-3150DN simply.

#### (3) User Friendly

- All general operation such as communication, controls and monitoring, are performed by SRG-3150DN, NBDP Terminal and printer which is installed in a convenient place.

#### (4) Configuration

- SRG-3150DN consists of one unit; therefore a large space is not required for installation and operation.

- SN-100 Terminal is able to use by connecting with SRG-3150DN cable.

#### (5) Trustworthy

Adopted new DDS (Direct Digital Synthesize) and improved the quality of sound, trustworthy, stability.

#### (6) Construction

- In order to endure in bad condition of marine environment, hard aluminum body is manufactured.

#### (7) External Shape

- Channel, Frequency, Transmitting and receiving conditions can be seen on large LCD at one sight. And each key is made by soft rubber material. It has stylish shape and makes you feel comfortable when you press the button, Further there is frequency sheet for users. SN-100 NBDP Terminal has large, thin, colorful LCD and convenient keyboard.



## 1.2. Basic Components

- This equipment is composed of SRG-3150DN and SN-100(NBDP), each item is made by functional PCB and sorted by standard and option.

### << Standard Components List >>

No.	Description	Model	Q'ty	Remark
<b>1.</b>	<b>MF/HF-DSC 송 수신기</b>	<b>SRG-3150DN</b>	<b>1set</b>	SRG-3150DN Assembly
(1)	MAIN BOARD	T - 1110	1	
(2)	TX FILTER	T - 1101	1	
(3)	W/K RX	T - 1112	1	
(4)	TX PA	T - 1113	1	
(5)	KEY BOARD	T - 1114	1	
<b>2.</b>	<b>Automatic Antenna Tuner</b>	<b>SAT-100</b>	<b>1</b>	(Installation material included)
<b>3.</b>	<b>HAND MIC</b>	<b>SM-1150</b>	<b>1</b>	
<b>4.</b>	<b>Accessory</b>	SSB-A-C,SRG-2050D-PC	<b>1set</b>	
<b>5.</b>	<b>User, Installation Manual</b>	<b>SRG-3150DN(Eng)</b>	<b>1</b>	

### << Options Components List >>

No.	Description	Model	Q'ty	Remark
<b>1.</b>	<b>EMG Light</b>	<b>EMG-Light</b>	<b>1</b>	
<b>2.</b>	<b>External Speaker</b>	<b>SS-6000</b>	<b>1</b>	
<b>3.</b>	<b>Power Supply</b>	<b>SP-1250ADC</b>	<b>1</b>	
<b>4.</b>	<b>NBDP Teminail</b>	<b>SN-100</b>	<b>1set</b>	SN-100 Assembly (Installation material included)
(1)	Connection Board	T - 130	1	
(2)	NBDP 수신부	T - 132	1	
(3)	NBDP PLL	T - 133	1	
(4)	전원부	T - 025	1	
(5)	CPU Board	G-1151	1	
<b>5.</b>	<b>KEY Board</b>	<b>SPR8695</b>	<b>1</b>	
<b>6.</b>	<b>MF/HF Distress Box</b>	<b>SD-250</b>	<b>1</b>	(SCN-16-5P included)
<b>7.</b>	<b>Printer</b>	<b>DPU-414</b>	<b>1</b>	(Installation material included) (or OKI Printer)
<b>8</b>	<b>WHIP ANT (TX)</b>	<b>SAN-308</b>	<b>1</b>	(8m)
<b>9.</b>	<b>WHIP ANT (RX)</b>	<b>SAN-30R</b>	<b>1</b>	(6m)

## Chapter 2. Specifications

### 2.1. General specification

• This radio equipment SRG-3150DN has been tested by the recommendation standard of IMO.

- (1) Power Supply (SP-1250ADC)  
AC 100-120/200-240V, 50/60Hz, 6% single-phase,  
DC24V Power Supply : 1200VA (Max)
- (2) Consumption Current: DC24V  $\pm$ 15%  
Receiving: 2.5A, at transmitting: 15A (Max)
- (3) Frequency Selection
  - a) ITU CHANNEL (Maritime Mobile) 271
  - b) 299 USER CHANNEL (Editable at the screen)  
or set frequency directly by keyboard.
  - c) DSC CHANNEL 2187.5, 4207.5, 6312, 8414.5,  
12577, 16804.5 kHz (F1B) is scan receiving all  
the time.
  - d) DSC Channel 13EA (Editable).
- (4) Frequency Switching Time:  
Between CHANNEL - within 5sec,  
Between BAND - within 15sec  
(Including ANTENNA MATCHING TIME)
- (5) Ambient Condition  
Temperature : -15°C ~ +55°C  
Humidity: 95%, +55°C  
Oscillation : Full amplitude 3.2mm at 5 ~ 12.5Hz  
Full amplitude 0.8mm at 12.5 ~ 25Hz  
Full amplitude 0.2mm at 25 ~ 50Hz
- (6) Dimensions (mm)  
SRG-3150DN : 324(W) X 170(H) X 347(D)  
SN-100 : 300(W) X 255(H) X 125(D)
- (7) Weight  
SRG-3150DN about 8.1Kg  
SN-100 about 5 Kg  
SAT-100 about 3.4Kg

### 2.2. MF/HF Transmitter

- (1) Type of Emission : J3E (USB), F1B (FSK)
- (2) Type of Communication  
: SIMPLEX & SEMI DUPLEX
- (3) Frequency Range : TX 1.6MHz - 27.5MHz, 10Hz STEP
- (4) Continuous Operating:  
Operating for over 8hrs with transmitting for  
1minute, stand by for 4minutes.
- (5) Output Power:  
50 ohm loaded (MF/HF transmitter output)
  - a) AC : 1.6MHz-27.5MHz 150WPEP
  - b) DC : 1.6MHz-27.5MHz 75WPEP
  - c) Power Reduction: 3steps  
J3E : 50 / 100 / 150W  
F1B : 75 / 100 / 100W
- (6) Frequency Deflection:  
Below 10Hz (within 0.3ppm)

- (7) Number of Channels:  
SSB x 299, ITU x 271, DSC x 19
- (8) Modulation type:  
Low power stage balanced modulation
- (9) Occupied Bandwidth:  
J3E ..... within 3kHz , J2B ... within 0.5kHz
- (10) Carrier Attenuation : 40dB or more (J3E)
- (11) Spurious Attenuation
 

J3E: 1.5 - 4.5 kHz	31dB or more
4.5 - 7.5 kHz	38dB or more
7.5 kHz or more	43dB or more
F1B: 138Hz	15dB or more
76Hz	31dB or more
500Hz	43dB or more
- (12) Overall Frequency:  
Deflection 6db max. At 350 - 2,700Hz
- (13) Overall Distortion and Noise : 20dB or more
- (14) Out Impedance : 50ohm
- (15) Input Low Frequency:  
+10dB/-35dB, IMPEDANCE 600 ohm

### 2.3. MF/HF Receiver

- (1) Type of Emission:  
J3E (USB), H3E (only RX), F1B (FSK)
- (2) Reception method:  
Up conversion double super heterodyne type  
using phase-locked digital frequency synthesizer.  
First intermediate frequency: 49.455MHz  
Second intermediate frequency: 455 kHz
- (3) Frequency Range:  
500 kHz - 29.99999MHz 10Hz STEP
- (4) Voice Output : Max 5.6W or more
- (5) Receiving Sensitivity:  
SSB is less 3 $\mu$ V at the 500kHz~29.9999MHz  
i.e., SSB (S+N+D)/ (N+D) = 20dB,  
BAND width 3 kHz, Output 100mW  
In case of DSC, NBDP Symbol error rate at a  
receiver input voltage of 1 $\mu$ V is less than 1 x 10<sup>-2</sup>  
i.e., Receiving Mode: FSK, BAND width: 0.3 kHz
- (6) 1 signal selectivity
  - a) 3 kHz FILTER (for SSB) in detailed features  
The pass band below 6dB: 2.4 kHz ~ 2.8 kHz  
The pass band at an attenuation of 26dB is less  
than  $\pm$ 1.7kHz  
The pass band at an attenuation of 46dB is less  
than  $\pm$ 1.9kHz  
The pass band at an attenuation of 66dB is less  
than  $\pm$ 2.1kHz
  - b) 0.3 kHz FILTER (for DSC, NBDP)  
Below 6dB of the pass band is 270Hz ~ 300Hz  
Attenuation at  $\pm$ 380Hz is 30dB or more  
Attenuation at  $\pm$ 550Hz is 60dB or more

- (7) Clearness:  $\pm 120\text{Hz}$
- (8) Overall Distortion & Noise :  
With an input voltage of  $30\mu\text{V}$ , the ratio between an audio frequency output of  $1000\text{Hz}$  and its unwanted component is more than  $20\text{db}$ .
- (9) AGC characteristics :  
Change in audio frequency output for antenna between  $3\mu\text{V}$  and  $100\text{mV}$  is  $10\text{db}$  or less.
- (10) Frequency Stability: within  $\pm 10\text{Hz}$
- (11) Image frequency interference ratio :  
Above  $70\text{dB}$
- (12) Intermediate frequency interference ratio:  
Above  $80\text{dB}$
- (13) SPURIOUS RESPONSE : Above  $70\text{dB}$   
In case of DSC, NBDP  
When a wanted signal of  $10\mu\text{V}$  and a  $31.6\text{mV}$  unwanted signal(excluding the range within  $750\text{Hz}$  of the wanted signal) whose range of IF it's three times that of the wanted signal, the symbol error rate is less than  $1 \times 10^{-2}$ .
- (14) Selectivity Suppression : With a wanted signal of  $10\mu\text{V}$  and an unwanted signal that is effect than  $3\text{kHz}$  from the wanted signal, an unwanted signal input voltage of  $10\text{m}$  suppresses the wanted scanning output to  $3\text{db}$ .  
In case of DSC, NBDP With a wanted signal of  $10\mu\text{V}$  and  $1\text{mV}$  unwanted signal  $500\text{Hz}$  from the wanted signal, the character error rate is less than  $1 \times 10^{-2}$ .
- (15) Spurious Emission :  
The power of emission from air antenna terminal is less than  $4000\mu\text{W}$ .
- (16) Nominal input load :  $50\text{ ohm}$  unbalanced

## 2.4. DSC (Digital Selective Calling) W/K Receiver

- (1) Type of Emission : F1B
- (2) Frequency : 2 187.5, 4 207.5, 6 312, 8 414.5, 12 577, 16 804.5 kHz
- (3) Frequency Stability : within  $\pm 10\text{Hz}$
- (4) SCANNING Reception :  
Scanning reception of above frequencies is continued up to  $2\text{sec}$  for each frequency and stop only when detects a  $100\text{ baud}$  dot pattern.
- (5) Receiving Sensitivity :  
Character error rate is  $1 \times 10^{-2}$  or less at receiving input voltage  $1\mu\text{V}$ .
- (6) 1 signal selectivity  
6dB bandwidth :  $270 \sim 300\text{Hz}$   
30dB bandwidth : within  $\pm 380\text{Hz}$   
60dB bandwidth : within  $\pm 550\text{Hz}$
- (7) Nominal input load :  $50\text{ ohm}$  unbalanced
- (8) Display DSC received word :  
Maximum  $256\text{EA}$  (Figure and word)

## (9) SPURIOUS RESPONSE:

With a wanted signal of  $10\mu\text{V}$  and  $31.6\text{mV}$  zero modulated interference signal which excludes the range within  $750\text{Hz}$  of the wanted signal, the character error rate is less than  $1 \times 10^{-2}$ .

## (10) Spurious emission:

The power of emission from air antenna terminal is less than  $4000\mu\text{W}$ .

## 2.5. MF/HF Control

- (1) Control Items :  
MF/HF Transceiver,  
DSC, WATCH-KEEPING Receiver,  
Frequency Program.
- (2) DISTRESS :  
Transmitting  $2187.5, 4207.5, 6312, 8414.5, 12577, 16804.5\text{ kHz}$
- (3) Miscellany :  
DISPLAY, Remote Interface, NBDP terminal,  
ATU BOX, ALARM BOX, HAND MIC,  
Printer, DIMMER
- (4) MAIN PROCESSOR : HD64F2506
- (5) EEPROM : 24LC512
- (6) Display : LCD BACK-LIGHT DISPLAY
- (7) INTERFACE  
RS-232 INTERFACE : 1 CHANNEL (NBDP)  
RS-422/232 INTERFACE : 1 CHANNEL (GPS)  
PRINTER INTERFACE : 1 CHANNEL  
(CENTRONICS INTERFACE)

## 2.6. Digital Selective Calling (DSC)

- (1) PROTOCOL : CCIR recommendation 493-3 & 541-2
- (2) EMISSION : F1B/J2B 100BAUD
- (3) Modulator : Output frequency  $1700\text{Hz} \pm 85\text{Hz}$   
Output max LEVEL  $+10\text{dBm}$   
( $600\text{ ohm}$  Unbalance/Balance)
- (4) Demodulator : Input frequency  $1700\text{Hz} \pm 85\text{Hz}$   
Input LEVEL  $-20\text{dBm} \sim +5\text{dBm}$   
( $600\text{ ohm}$  Unbalance/Balance)
- (5) Processor:  
CCIR recommendation 493-3 ERROR mark (10 steps)  
Correct CLOCK transmitting  
CLOCK frequency  $14,000\text{ KHz}$   
CLOCK stability within  $5 \times 10^{-6}$ .
- (6) DSC Memory Function
- Distress Receipt : 50EA
  - Ordinary : 50EA
  - Transmit message : 100EA

## 2.7. Narrow band direct Printing (NBDP)

- (1) Protocol :  
CCIR recommendation 625.476-4.490491.492-3 & CCIR F130
- (2) Calling mode :  
Individual and group calling with 5 digits and 9 digits select call number.
- (3) Operating mode :  
ARQ (Auto Repetition Request)  
CFEC (Collective Forward ERROR correction)  
SFEC (Selective Forward ERROR Correction)
- (4) Status Display :  
POWER ON, STAND-BY, CALLED, CALLING, FREE. SIGNAL, ARQ, CFEC, SFEC, SEND, RECEIVER, PHASING, REPHASING, REPEAT, ERR
- (5) Code :  
7-bit CORD 4B/3Y constant ratio mark signal  
(B:1785Hz, Y:1615Hz)
- (6) Memory : 16M
- (7) SYSTEM PARAMETER:  
OPERATOR DATA is saved at FLASH DISK PROGRAMING and back-up.
- (8) Center frequency : 1700Hz
- (9) Frequency SHIFT width:  $\pm 85$ Hz
- (10) Modulation Speed :  
100BAUD (ARQ, FEC MODE)
- (11) Modulation: phase continuity AFSK
- (12) Frequency Deflection: within 0.5Hz
- (13) Modulation Input :  
0dBm, 600ohm Unbalance/Balance
- (14) Modulation Output:  
0dBm, 600ohm Unbalance/Balance

## 2.8. Printer (DPU-414)

- (1) Specifications
  - Typing : Thermal serial dot matrix
  - Total Dots : 9 x 320 dot / line
  - Composition of Dots: 9 x 7 dots wide
  - Internal Dots : 1 dot
  - Typing Quantity :  
40letters (Standard) 80letters (Shortened)
  - Typing Direction : Single / Both Logical seek
- (2) Bit-image graphics mode
  - Total Dots : 8 x 320 dot / line
  - Typing Direction : Single Logical seek
  - Typing width : 89.6mm
  - Typing speed : Max 52.5cps (Standard)  
Max 80cps (Shortened)
- (3) Ambient
  - Temperature: 0°C ~ 40°C
  - Humidity: 30% ~ 80% RH(no condensation)
- (4) Print Paper
  - Model No : TP411 - 28CL(TP-411L)
  - Width : 112mm

- Diameter : 48mm
- Length : about 28m

- (5) Etc
  - Power Supply : DC 6.5 ~ 13.6V
  - Dimensions : 160mmx 170mmx 66.5mm
  - Weight : about 580g
  - Durability : about 500,000 lines  
("8" 40letters continuously)  
(Color thickness 100%)

## 2.9. Printer (OKI)

- (1) Features
  - Printer Head : 9 pins
  - Speed (CPS) : 300CPS (Max speed)  
240CPS (High speed)  
50CPS (High quality)
  - Carriage width : 80letters (10CPI)
  - Graphic Resolution : 240X216DPI (Max)
  - Paper Space : From top 15mm (CUT SHEET)  
From top 17mm (ROLL)
  - Interval between letters : 10, 12, 17CPI
  - Type of Font: Dark, Stress, Thick, Lean
  - Remember : 1 Line
- (2) Paper
  - Dimensions : 241 ~ 254mm
  - Weight : 35 ~ 52 g/m<sup>2</sup>
- (3) Interface and Standardization
  - Standardization : micro line espon fx ibm  
pro printer
  - Interface : centronics parallel  
serial rs232c, rs422
- (4) Reliability
  - Head Life : 2 billion letters
  - Ribbon Life : 3 million letters
  - MTBF : 6000hrs
- (5) Miscellany
  - Power : DC +24V
  - Dimensions (HXWXD): 80mmX360mmX275mm
  - Weight : 4.5Kg
  - NOTE : DC available (10~30V DC)

## Chapter 3. Power Supply

### 3.1. Power On

- (1) AC power plug put in plug receptacle, connect the battery with rear socket.
- (2) Check the indication of light on: AC IN, DC IN, and DC OUT of front panel.
- (3) Connect cables of SRG-3150DN.
- (4) Switch AC and DC power on.
- (5) Push the  button.

### 3.2. Operation by AC power

- When it comes to supply AC power to the main unit, it works with AC power automatically. W/K LED displays the condition that 6 scanning frequency is working on DSC WKR of the transceiver. (Refer to "Operation of Distress Acknowledge Signal" for operation instructions, If DSC distress or alarm call rings.)

### 3.3. Operation by DC (BATTERY) power

- When AC power is disconnected, the SRG-3150DN switches to DC operation and [DC] LED on MF/HF control panel will light up automatically. When it is transmitted to DSC, AC signal will be changed to DC on upside of transceiver LCD display. Moreover, changing to DC mode will be displayed on downside of that. And receiving output is converted to LOW.

### 3.4. BATTERY Charging

- When connected to AC power, except of switch on of transmitter power supply AMP power, the battery is automatically charged, a low current is supplied to maintain the rated battery voltage. The charge mode indicator between automatic and normal is by the charge switch on the system cabinet.

(1) AUTO MODE: When the battery is out, charged automatically, Full time charged is set general mode.

(2) NORMAL MODE: It is charged battery, regardless battery is status. To use battery longer, it is required to maintain properly for battery. Maintaining battery according to the instruction manual.

(3) OFF MODE: Set the middle of switch between AUTO & NORMAL.

# Chapter 4. Front Panel

## 4.1. About Button, Knob, Lamp

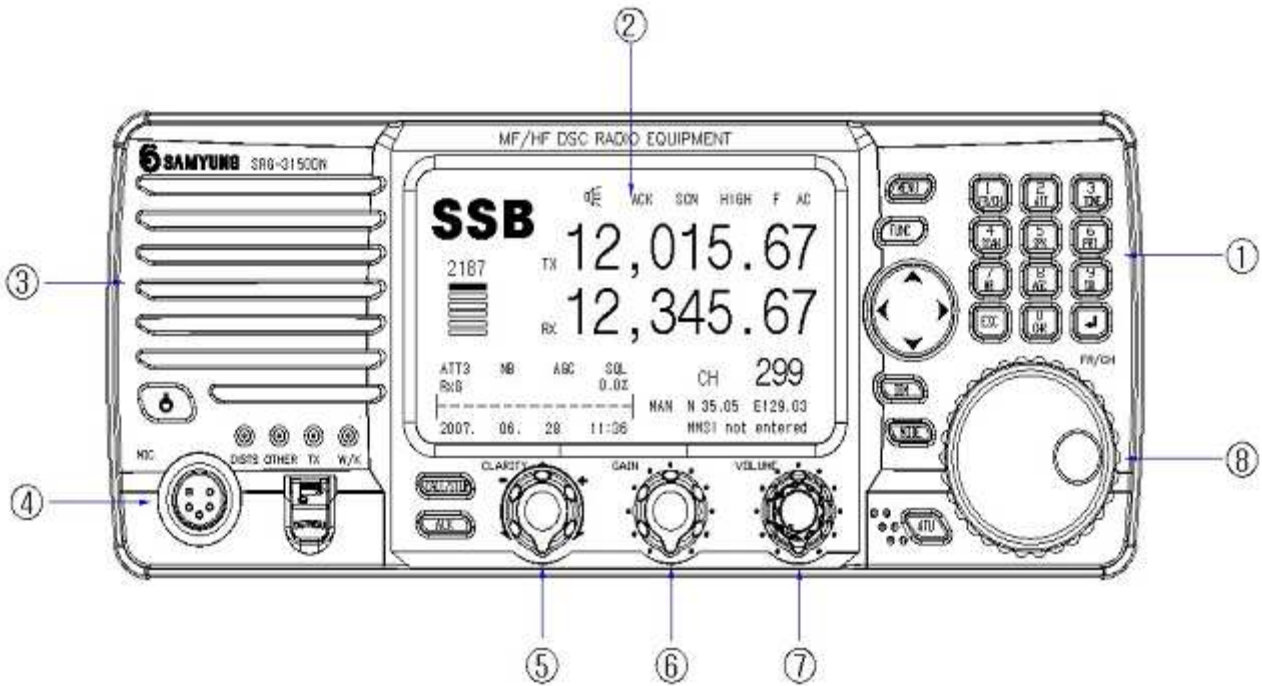

< ↑ SRG-3150DN Main Unit >

- ①. KEY Panel
- ②. Front Panel(LCD) - Mode / Frequency / Channel / Other function.
- ③. Internal Speaker
- ④. MIC connection jack - Connect MIC provided.
- ⑤. Articulation - Adjusting received signal clearly.
- ⑥. Gain - Adjusting Gain of Receiver.
- ⑦. Volume - Adjusting volume of speaker.
- ⑧. Channel - Adjusting channel and frequency up/down.

- (1) : Power ON / OFF in main unit.
- (2) : Hold pressing 3sec, Transmitting Distress signal.
- (3) : Transmitting frequency/channel & message edited by DSC mode or Stop alarm sound, Stop distress and call display also.
- (4) : Auto acknowledge for the received messages ON/OFF in DSC mode.
- (5) : Selecting main menu.
- (6) : Hold this key and extend functions with random keys.

- → : Selecting "CH" "TX" "RX" in Order. (Be available to select Channel and TX/RX Frequency)
- → : Select ATT in order. (Display LCD left-bottom)  
(The part of received diminution can select 3 levels)
- → : ON/OFF internal test tone Signal at 1.4 KHz.
- → : ON/OFF Scan function. (Display LCD on top)  
(Scan function of channel or frequency can be started and finished)
- → : ON/OFF Speaker. (Display LCD on top)
- → : Select printer function. (Can be printed to channel and message that received frequency)
- → : ON/OFF N.B. (Display LCD left-bottom)

**[Ref.]** when it is receiving H3E, Noise Blanker removes noise out of it.  
(Noise Blanker: It works to block high level of impulse of short duration as a device to cut off one stage from middle frequency of receiver.)

- → : ON/OFF AGC.  
(Display LCD left-bottom)  
Adjust automatically gain that bundle of amplification of receiver.  
(Auto Gain Control: It means that system maintain to regardless of changing of strength that input signal by the book of receiver's power. As is higher signaling that incoming to system, diminution degree of gain is increasing, in conclusion low signal much more amplifier than high signal).

- → : ON/OFF SQL.  
(Display LCD left-bottom)  
Delete to noise that occurred on standby receiving according to signal level.

(\*Squelch: mute the equipment and delete to harassing background noise and unwanted signal automatic control to the function of receiver or amplifier exception of incoming signal exceed to a set point)

- → : By check mode, RX set displays RX signal(RxG), Voltage(24V)(VOLT), TX set displays PA currency(Ic), Antenna currency(ANT), standing wave ratio(SWR).
- → : Adjust dimmer 5steps in front panel.
- → : Switch AM receiving mode.
- → : Operating matching channel before input frequency.
- → [▲] or [▼] : Change of TX Frequency take turns HIGH / LOW / MID.

- (7) : this button is for selecting to item of selection on menu mode and for cursor moving on the display.

- (8) ~ : be useful to input the number.
- (9) : Adjust LCD back light (internal) by 4steps. (Holding [FUNC] and press [DIM], Adjust by 5steps.)
- (10) : Switch SSB & DSC mode.  
(Holing [FUNC] and press [MODE], Switch AM mode.)

**[Ref.]** SSB (J3E): use to voice communication  
 DSC (F1B): use to digital selective calling communication

- (11) : Matching with user's antenna then push this button. (Press [FUNC] and hold with [ATU] for 2sec, Matching all channel.)
- (12) : Cancel set or return precious menu.
- (13) : Execute selecting, input, and extend...etc at the menu.

- (14) LED Display  
  - [DISTS]**: When receive a Distress signal by W/K receiver or transmit a Distress alarm signal, be flickered LED indicator.
  - [OTHER]**: when receive DSC without DISTRESS signal, be flickered Green LED Indicator.
  - [TX]** : LED on, transmitting
  - [W/K]**: LED display ..... LED on W/K receiver is operating. (Always Working)

## 4.2. LCD display

- The following information is displayed in general.

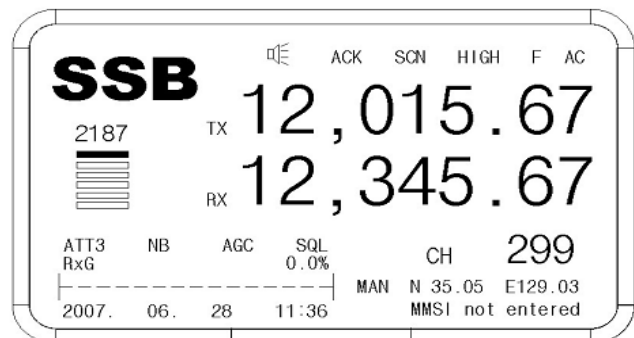

- (1) Communication Mode (SSB, DSC, AM (only RX)), Speaker, Acknowledge, Scan, TX power, Time (UTC GPS being connected)
- (2) W/K receiving channel, TX/RX frequency & channel.
- (3) Attenuator (ATT), Noise Blanker (N.B), AGC, Squelch.
- (4) RX signal level, Voltage/Currency (I-c) / (ANT-c) / Standing-wave ratio (Select [F] + [0]), Date, time (Display UTC, if GPS receiver connected)
- (5) Location mark  
  - "MAN": Manual Input
  - "GPS": GPS location (GPS connected)
  - MMSI (Maritime Mobile Service Identity) ID
- (6) Display according to the key input.

- (7) Display Description

**A) SSB** : Display communication mode in use.

**b)** : → , ON/OFF Speaker

ON - Display

OFF- Display

**c) ACK** : Display if it selected an automatic acknowledge in DSC mode.

**d) SCN** : Press → to start "SCAN" and press → , and then SCAN is finished.

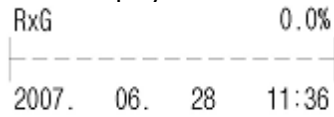

- e) **HIGH** : Display transmitting power.  
**HIGH** : SRG-3150DN (J3E:150W, F1B:100W)  
**MID** : SRG-3150DN (J3E:100W, F1B:100W)  
**LOW** : SRG-3150DN (J3E:50W, F1B:75W)
- f) **F**: Display **FUNC** is in use or not.
- g) **AC** : Indicate currency situation to POWER SUPPLIER (SP-1250ADC).  
**AC** : AC Power Supply.  
**DC** : battery power supply.
- 2187
- H)  : Display scanning W/K frequencies (6 channels).
- i) **TX** : Transmitting Frequency  
j) **RX** : Receiving Frequency
- k) **ATT3** : Level of attenuation.  
ATT1: 10dB, ATT2: 20dB, ATT3: 30dB
- l) **NB** : Display Noise Blanker set.  
m) **AGC** : Display Auto Gain Control.  
n) **SQL** : Display Squelch set.  
o) **CH** : Display channel.

p)  : indicate a received gain and use to button and can select to indictable to **FUNC** → **CHK** SWR(standing wave ratio) / VOLT(PS current) / IC(TX current) / ANT(Antenna currency), indicate to date and time and automatic indicate to UTC when connected GPS, GPS receiver

MAN N 35.05 E129.03  
q) **MMSI not entered** : Indicate GPS received date (latitude, longitude) when input hand – operated coordinate, receive directly date from GPS receiver and indicate screen to "GPS", indicate tuning situation in changing channel with MMSI ID.

### 4.3. LCD display flow

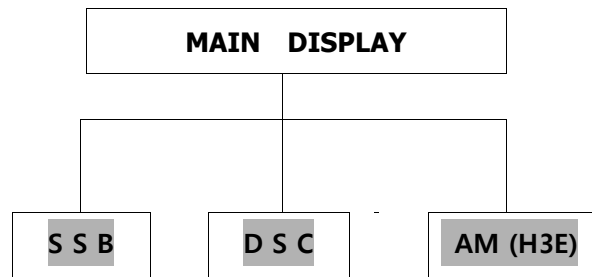

#### SSB

- MAIN MENU
1. Scan Type Set
  2. Scan Channel Set
  3. Scan Frequency Set
  4. SQL Set
  5. LCD Contrast Set
  6. TX POWER Set
  7. Manual Tuning
  8. ATU - VERSION
  9. Remote Set
  0. SYSTEM Set

#### DSC

- MAIN MENU
1. Distress msg edit
  2. Individual msg edit
  3. Group msg edit
  4. Geography msg edit
  5. Auto/Semi-AT msg edit
  6. Dist. ack/rly msg edit
  7. Ordinary ack msg edit
  8. Display & Print msg
  9. System Set

#### AM

\*\*\* Only Receive Function



# Chapter 5. SSB (TEL) mode

## 5.1. SSB Mode

- Press **MODE** button on front panel, and then go to SSB mode.

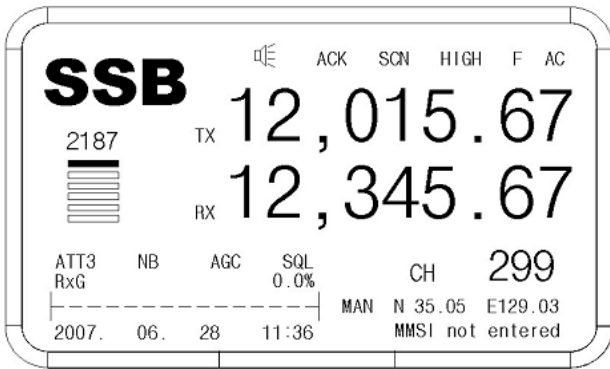

## 5.2. SSB Menu

- On SSB Mode when press display to Menu screen as follow. **MENU**.

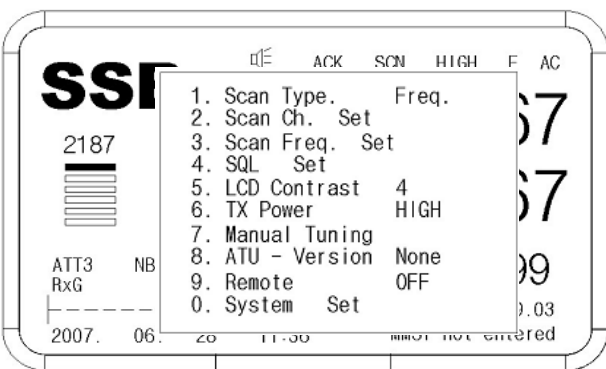

### (1) Scan Type Set

- a) Decision scanning channel or frequency.



**1. Scan Type** is selected.



Select, switching [CH]/ [Freq] in rotation



Return to Main Display.

- B) **FUNC**, **4 SCAN** scan to select SACN Type.

[Ref.] Scan type is [CH], scan channel.

Scan type is [Freq], scan frequency.

### (2) Scan Channel Set

- a) Fix setting value in case of scanning channel.



**2. Scan Ch. Set** is selected.



The below box shows.

Start	: 1
End	: 299
Speed	: 0

- [▲][▼] Move, and select to wanted function,



Selected.

- [Number button] Input the value.



Set up.



Press to back to main screen.

[Ref.] [Start] : Set Start channel.

[End] : Set Last channel.

[Speed] : Set speed of scan channel  
(0~9, 0: Fastest, 9: Slowest)

### (3) Scan Frequency Set

- a) Set value in case of scanning Frequency.



**3. Scan Freq. Set** is selected.



The below box shows.

Start	: 500.00	kHz
End	: 29,999,99	kHz
Speed	: 0	
Step	: 0.1	kHz

- [▲][▼] Move, and select to wanted function,



Selected.

- [Number Button] Input the value.



Set up.



Press to back to main screen.

[Ref.] [Start] : Set Start Frequency.

[End] : Set Last Frequency.

[Speed] : Set speed of scan Frequency.

[Step] : Set step of scan Frequency.  
(100HZ/step)

"10.0"at 10kHz step.

### (4) SQL Set

- a) On standby, if set setting value of SSB particular sound clearance highly, cannot receive slight signal.



**4. SQL Set** is selected.



The below box shows.

SQL Sense	10	Set range : 1 ~ 20
SQL Delay	5	Set range : 1 ~ 20

- [▲][▼] Move, and select to wanted function,



Selected.

- [Number button] Input the value.



Set up.



Press to back to main screen.

[Ref.] [SQL Sense]: Set sensibility of SQL.

[SQL Delay]: Set delay time of SQL circuit.

### (5) LCD Contrast Set



**5. LCD Contrast** is selected.



Press to change the LCD brightness  
From **[1]** ~ **[5]** step.

(Higher value and more thicker)

### (6) Tx Power Set

a) Adjust TX power.



**6. Tx Power** is selected.



Select HIGH / **MID** / LOW

b) If Tx Power

**HIGH**, Display "HIGH",

SRG-3150DN(J3E:150W, F1B:100W)

**MID**, display "MID",

SRG-3150DN(J3E:100W, F1B:100W)

**LOW**, display "LOW".

SRG-3150DN(J3E:50W, F1B:75W)

### (7) Manual Tuning

a) ATU tuning by manual.



**7. Manual Tuning** is selected.



The below box shows.

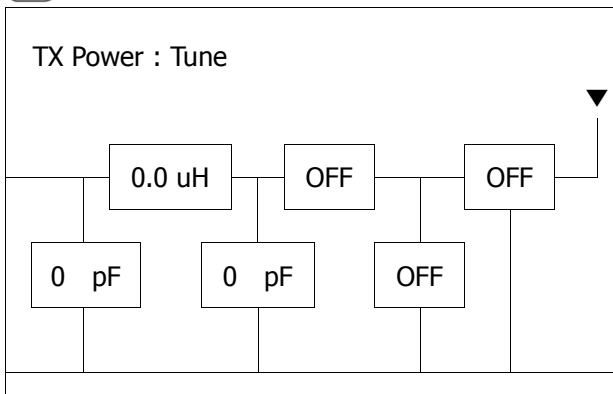

[◀][▶] Select the point which it is to be adjusted by [◀][▶]

[▲][▼] Adjust it's value by [▲][▼]



Selected.

[Ref.] press , the value adjusted is input and return main menu.

☞ On manual tuning, TX power has not changed while switching frequency.

### (8) ATU – Version (ATU Program Version)



**8. ATU---Version** is selected.



Selected.

[Ref.] ☞ if ATU DATA cable has any trouble,  
Display "**Error.**"

### (9) Remote Set

a) Set remote operating.



**9. Remote OFF** is selected.



Press, can be changed **9.Remote ON**,  
Display "**REM**" on the main screen.

b) Press and then change to remote off.

### (10) System Set

a) Select system's value.



**0. System Set** is selected.



The below box shows.

```

1. Tuning Clear
2. SSB-CH Clear
3. Date Set
4. Time Set
5. Key Tone on
6. ADC Value IC
7. Auto Tune
8. Self Test
9. Key Test
0. Reserved
    
```

① **[1.Tuning Clear]**: Clear all the memory tuned.



**1. Tuning Clear** is selected.



The below box shows.

No  
Yes

[▼]

Move to **Yes**



Reboot system.

② **[2.SSB-CH Clear]**: Delete channel data and set channel.



**2. SSB-CH Clear** is selected.



The below box shows.

No  
Yes

[▼]

Move to **Yes**



Reboot system.

③ **[3.Data-Set]**: Set data in system.

In external GPS Data input, UTC (Universal Time Coordinated) is displayed.

④ **[4.Time-Set]**: Set time in system.

In external GPS Data input, UTC (Universal Time Coordinated) is displayed.

⑤ **[5.Key Tone]**



**5. Key Tone** is selected.



Press, can be changed **On/Off**.

⑥ **[6.ADC Value]:** RXG in first display – Show selecting ON/OFF.



**6. ADC Value** is selected.



Press, and then can select IC, ANT, SWR, VOLT.

**[Ref.]** **RxG** : Rx Signal Level

(On setting IC, ANT, SWR, displayed on receiving)

**IC** : End Current,

**ANT** : Antenna Current

**SWR** : Standing Wave Ratio

**VOLT** : it means electricity, voltage and

In case of setting IC, ANT and SWR, display reference to transmitting.

⑦ **[7.Auto Tune]** : Matching all channels automatically.



**7. Auto Tune** is selected.



The below box shows.

Freq	: 2,032.0kHz
Tune	: Tuning - - -

⑧ **[8.Self Test]:** Self test function.



**8. Self Test** is selected.



The below box shows.

Version	: 2.0
Receiver	: good
Watch-R	: good
Exciter	: good
Tuner	: good

⑨ **[9.Key Test]:** Test button the front screen.



**9. Key Test** is selected.



When press selected button and then display title that selected button on the screen.

### 5.3. Additional Functions (ITU Channel, AM mode, Etc.,)

(1) ITU Channel [CH401 - CH2510], it can be selected by [CH] and [Number] on SSB Mode, if it is within reference to range channel, it can be switching channel by dial or button[up/down] of Hand-MIC.

(2) Press **FUNC** → **MODE**, it switches [AM] (H3E) mode, use **MODE**, it switches another mode [SSB or DSC].

**[Ref.]** there's no TX display at the [AM] (only RX), AGC is set automatically.

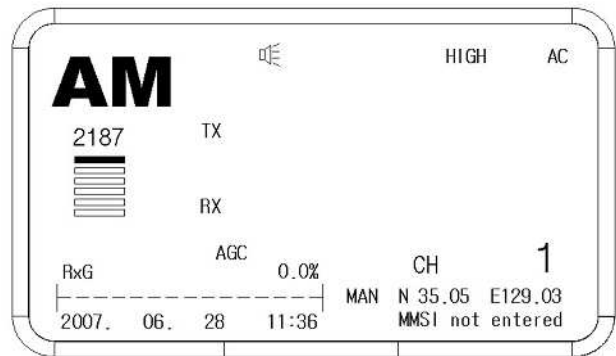

(3) DSC Channel (CH300 ~ CH399), DSC message appears, goes to mode and edit and change DSC channel by front knob, hand MIC up/down

**[Ref.]** DSC mode / MENU > 2.Individual Msg Edit / can be edited in DSC Message by [▲] [▼].

(4) It can be moved by cursor on menu mode by [CH] dial.

(5) If you want to stop on receiving [DISTS] & [OTHER] press **CALL/STOP**.

# Chapter 6. Digital selective calling (DSC) mode

## 6.1. The selection of DSC mode

- Set DSC Mode by **MODE** on the front Panel as follow.

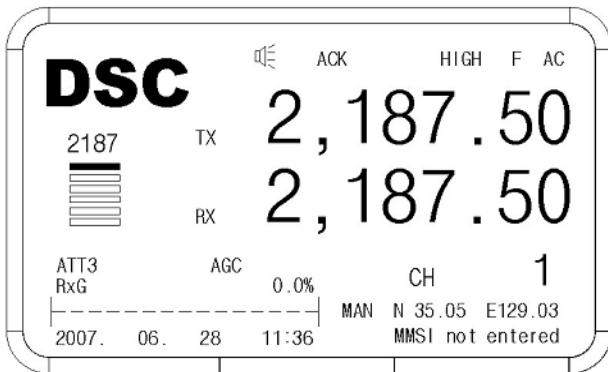

- a) CH1 ~ CH6: In case of emergency only. Not possible to use in a normal condition.
- b) CH7 ~ CH19: Normal can be used by users and pressing [SCAN] key, it can scan only in specified data location within CH7~CH19 channel.

## 6.2. DSC menu display

Press **MENU** on the initial screen of the DSC mode, the sub menu screen is set as follow.

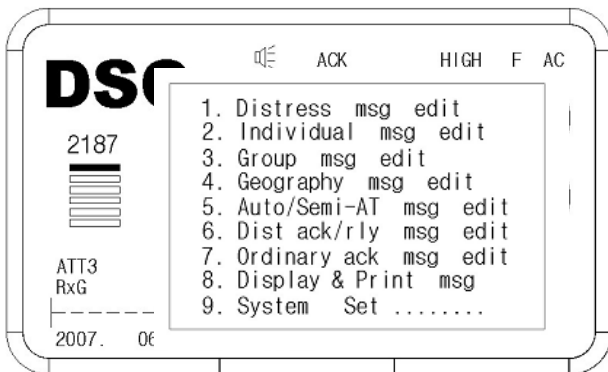

### (1) Distress msg edit

- a) In case of calling distress.



**1. Distress msg edit** is selected.

The below box shows.

CH = 300	:	(NO DATA)
CH = 301	:	(NO DATA)
CH = 302	:	(NO DATA)
.....		.....
CH = 399	:	(NO DATA)

**[Ref.]** **[▲][▼]**: Moving up and down with 1 step channel.

**[◀][▶]**: Moving up and down with 10 step channels.

**[▲][▼][◀][▶]** Select Channel that format is Distress



Press, display can edit msg. on the screen. (Or can be edited what you want.)

```

FORMAT : Distress          300
NATURE  : Undesignated
POSITION : N . . . E . .
DIST-UTC : --:--
TEL CMD  : J3E TP
EOS      : EOS
    
```

- ① **[FORMAT]**: A kind of calling.

Distress : *Distress calling(fixed)*

- ② **[NATURE]**: The type of distress.

**[▲][▼]** Move to **NATURE**



The below box shows.

```

Fire, Explosion
Flooding
Collision
Grounding
Listing
Sinking
Adrift
Undesignated
Abandon ship
Piracy/Attack
Man Overboard
    
```

**[▲][▼]** Go to the menu you want.



Selected.

- ③ **[POSITION]**: Position of distress.

(Auto-set in a connection with GPS)

**[▲][▼]** Move to **POSITION**



The below box shows.

```

N _ _ , _ _ , _ _ _ _ / E _ _ _ , _ _ , _ _ _ _
North latitude(00.00.0000~90.00.0000)
east longitude(000.00.0000~180.00.0000)
S _ _ , _ _ , _ _ _ _ / W _ _ _ , _ _ , _ _ _ _
South latitude(00.00.0000~90.00.0000)
west longitude(000.00.0000~180.00.0000)
    
```

**[Number button]** Input the value.



Set up.

**[Ref.]** Press **[▲][▼]** to change [N -- E --] / [S -- W --] / [S - E --] / [N -- W --] in turns

If the value is beyond the value range, the set up can not be done.

④ **[DIST-UTC]**: Set time of distress.

**[▲][▼]** Move to **DIST-UTC**

 The below box shows.

**---:---** : Time of Distress(00:00 - 23:59)

**[Number. button]** Input the time.

 Selected.

**[Ref.]**  Set automatically in connection with GPS.

⑤ **[TEL CMD]**: Set Telecomm and.

**[▲][▼]** Move to **TEL-CMD**

 Press  to change **[J3E TP]** / **[FIB/J2B T]**.

⑥ **[EOS]**: Completion of DSC message.  
(EOS=End of Sequence)

**EOS – Set automatically. (fixed)**

 shown [.....File Saved.....] and be saved...

b) After setting items press  and then transmit DISTRESS signal as Frequency that before edition on DSC main screen.

**(2) Individual msg edit.**

a) Used in an individual call or coast station call.

 **2. Individual mag edit** is selected.

 The below box shows.

CH = 300 : (NO DATA)  
CH = 301 : (NO DATA)  
CH = 302 : (NO DATA)  
..... : .....  
CH = 399 : (NO DATA)

**[Ref.]**  **[▲][▼]**: Moving up and down with 1 step channel.

**[◀][▶]**: Moving up and down with 10 step channels.

**[▲][▼][◀][▶]** The channel is selected.

 The below box shows.

**1** Save    **2** F/C/SP    **3** Search ID

Tx-Freq : 2,187.50  
FORMAT : Individual  
CATEGORY : Routine  
PARTY\_ID : 000000000  
TEL CMD1 : J3E TP  
TEL CMD2 : No information  
WORK FRQ : 2,182.00 / 2,182.00  
EOS : ACK RQ

① **[TX-Freq]**: Set TX frequency.

**[▲][▼]** Move to **TX-Freq**

 The below box shows.

01	2,187.50
02	4,207.50
03	6,312.00
04	8,414.50
05	12,577.00
06	16,804.50
19	8,414.50

**[Ref.]**  **MENU>9.SYSTEM SET>0.Etc. Set>3.Default Channel** possible to select default TX frequency.

**[▲][▼]** The frequency is selected.

 Selected.

**[Ref.]**  Indicate the frequencies which is memorized by user in DSC mode CH7~19.

② **[FORMAT]**: A kind of calling.

Individual : *an individual calling(fixed)*

③ **[CATEGORY]**: Purpose of calling.

**[▲][▼]** Move to **CATEGORY**

 The below box shows.

Routine  
Safety  
Urgency :

**[▲][▼]** Go to the menu you want.

 Selected.

④ **[PARTY ID]**: Input the ID of counter party.

**[▲][▼]** Move to **PARTY\_ID**

 Selected.

**[Number. button]** Input ID.

 Set up.

⑤ **[TEL CMD1]**: Set Telecommand1.

**[▲][▼]** Move to **TEL CMD1**

 The below box shows.

J3E TP  
F1B/J2B TTY-FEC  
F1B/J2B TTY-ARQ  
Data

**[▲][▼]** Go to the menu you want.

 Selected.

⑥ **[TEL CMD2]**: Fix "No information"

⑦ **[WORK FRQ]**: Operational frequency.

**[▲][▼]** Move to **WORK FRQ**



Selected.

**[Number. button]** Input TX frequency.



Set up.

**[Number. button]** Input RX frequency.



Set up.

⑧ **[EOS]**: Completion of DSC message.

(EOS=End of Sequence)

ACK RQ : *Auto-set.(Fixed)*

**[Ref.]** **ACK RQ**: Function to request other's response. (ACK=Acknowledge=Auto response)

b) Function Keys

1 Save    2 F/C/SP    3 Search ID

① After inputting data press and it is saved.

② select **[PARTY-ID]** → press and registered ID list shows → select by **[▲][▼]** →

```
01 : SAMYUNG 101010000
02 :
03 :
04 :
05 :
06 :
07 :
```

**[Ref.]** How to register ID: **MENU>9.SYSTEM SET>5.ID/FR/TEL Set>1.ID** Edit and register.

③ Select **[WORK FRQ]** → press and registered frequency list shows → select by **[▲][▼]** →

TX FREQ. / RX FREQ.

```
01 : 10,000.0/ 20,000.0
02 : 14,000.0/ 14,000.0
03 :
04 :
05 :
06 :
07 :
08 :
09 :
10 :
```

**[Ref.]** How to register frequency that communicate with voice: **MENU>9.SYSTEM SET>5.ID/FR/TEL Set>3.Work Frequency** Edit and register.

④ select **[WORK FRQ]** → press to change **[WORK FRQ]** / **[POSITION]**.

• Select **[POSITION]** by →

→ Input by **[No. button]** →

c) After setting items, press and "individual call" signal transmits.

d) When ACK response signal is received, communication can be possible with the voice communication frequency.

**(3) Group msg edit**

a) Call specified ships as such a same group or company simultaneously.



**3. Group msg edit** is selected.



The below box shows.

```
CH = 300 : (NO DATA)
CH = 301 : (NO DATA)
CH = 302 : (NO DATA)
.....
CH = 399 : (NO DATA)
```

**[▲][▼][◀][▶]** The channel is selected.



The below box shows.

1 Save    2 F/C/SP    3 Search ID

```
Tx-Freq : 2,187.50
FORMAT : Group
CATEGORY : Routine
PARTY_ID : 000000000
TEL CMD1 : J3E TP
TEL CMD2 : No information
WORK FRQ : 2,182.00 / 2,182.00
EOS : EOS
```

① **[TX-Freq]**: Set TX frequency.

**[▲][▼]** Move to **TX-Freq**



The below box shows.

```
01 : 2,187.50
02 : 4,207.50
03 : 6,312.00
04 : 8,414.50
05 : 12,577.00
06 : 16,804.50
19 : 8,414.50
```

**[▲][▼]** The frequency is selected.



Selected.

**[Ref.]** Indicate the frequencies which is memorized by user in DSC mode CH7~19.

② **[FORMAT]**: A kind of calling.

Group : *Group calling(fixed)*

③ **[CATEGORY]**: Purpose of calling.

Routine : *use general (fixed)*



④ **[PARTY ID]** : Input the ID of counter party.

**[▲][▼]** Move to **PARTY ID**

**[↵]** Selected.

**[Number. button]** Input ID.

**[↵]** Set up.

⑤ **[TEL CMD1]**: Set Telecommand1.

**[▲][▼]** Move to **TEL CMD1**

**[↵]** Press **[↵]** to change **[J3E TP] / [FIB/J2B TTY-FFC]**.

⑥ **[TEL CMD2]**: Fix "No information"

⑦ **[WORK FRQ]**: Operational frequency.

**[▲][▼]** Move to **WORK FRQ**

**[↵]** Selected.

**[Number. button]** Input TX frequency.

**[↵]** Set up.

**[Number. button]** Input RX frequency.

**[↵]** Set up.

⑧ **[EOS]**: Completion of DSC message.  
(EOS=End of Sequence)

**EOS: Auto - set. (fixed)**

b) Function Keys

**[1] Save** **[2] F/C/SP** **[3] Search ID**

① After inputting data press **[1] FR/CH** and it is saved.

② select **[PARTY-ID]**→press **[3] TONE** and registered

ID list shows →select by **[▲][▼]**→**[↵]**

01 :	SAMYUNG	101010000
02 :		
03 :		
04 :		
05 :		
06 :		
07 :		

**[Ref.]** How to register ID: **MENU>9.SYSTEM SET>5.ID/FR/TEL Set>1.ID** Edit and register.

③ Select **[WORK FRQ]**→press **[3] TONE** and registered frequency list shows →select by **[▲][▼]**→**[↵]**

TX FREQ. / RX FREQ.

01 :	10,000.0/	20,000.0
02 :	14,000.0/	14,000.0
03 :		
04 :		
05 :		
06 :		
07 :		
08 :		
09 :		
10 :		

**[Ref.]** How to register frequency that communicate with voice: **MENU>9.SYSTEM SET>5.ID/FR/TEL Set>3.Work Frequency** Edit and register.

c) After setting items, press **[CALLSTOP]** and "group call" signal transmits.

d) When ACK response signal is received, communication can be possible with the voice communication frequency.

**(4) Geography msg edit**

a) calling all ships by coast station call.

- Use for communicating with all ships about safety and others by coast station call.
- When coast station call, will be waited automatically all ships as set voice communication frequency.

b) calling all ships by base of ships.

- It's no use generally.
- Use for emergency or sending important information.



**4.Geography msg edit** is selected.

The below box shows.

CH = 300 :	(NO DATA)
CH = 301 :	(NO DATA)
CH = 302 :	(NO DATA)
.....	.....
CH = 399 :	(NO DATA)

**[▲][▼][◀][▶]** The channel is selected.



The below box shows.

**[1] Save** **[2] F/C/SP** **[3] Search ID**

Tx-Freq :	2,187.50
FORMAT :	Geography
CATEGORY :	Safety
PARTY_ID :	N E DA DO
TEL CMD1 :	J3E TP
TEL CMD2 :	No information
WORK FRQ :	/
EOS :	EOS

① **[TX-Freq]**: Set TX frequency.

**[▲][▼]** Move to **TX-Freq**



The below box shows.

01	2,187.50
02 :	4,207.50
03 :	6,312.00
04 :	8,414.50
05 :	12,577.00
06 :	16,804.50
19 :	8,414.50

**[▲][▼]** The frequency is selected.



Selected.

**[Ref.]**  Indicate the frequencies which is memorized by user in DSC mode CH7~19.

② **[FORMAT]**: A kind of calling.

Geography : *local calling(fixed)*

③ **[CATEGORY]**: Purpose of calling.

**[▲][▼]** Move to **CATEGORY**

 Press  to change **[Safety]** / **[Urgency]**.

④ **[PARTY AD]**: [reference to 24page.](#)

⑤ **[TEL CMD1]**: Set Telecommand1.

**[▲][▼]** Move to **TEL CMD1**

 Press  to change **[J3E TP]** / **[FIB/J2B TTY-FFC]**.

⑥ **[TEL CMD2]**: Set Telecommand2.

- In case of setting **[Safety]**, fix "No information" in [CATEGORY].

- In case of setting **[Urgency]** in [CATEGORY].

 **MENU>9.SYSTEM SET>0.Etc. Set>9.Medi-Trans. Set** and select on)

**[▲][▼]** Move to **TEL CMD2**

 The below box shows.

No information  
Ship and aircraft  
Medical transport

**[▲][▼]** Go to the menu you want.

 Selected.

⑦ **[WORK FRQ]**: Operational frequency.

**[▲][▼]** Move to **WORK FRQ**

 Selected.

**[Number. button]** input TX frequency.

 Set up.



**[Number. button]** input RX frequency.

 Set up.

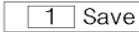

⑧ **[EOS]**: Completion of DSC message.

EOS : *Auto - set.(fixed)*

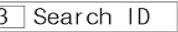
c) Function Keys



  

① After inputting data press  and it is saved.

② select **[PARTY-ID]** → press  and registered ID list shows → select by **[▲][▼]** → 

01	: SAMYUNG	101010000
02	:	
03	:	
04	:	
05	:	
06	:	
07	:	

**[Ref.]**  How to register ID: **MENU>9.SYSTEM SET>5.ID/FR/TEL Set>1.ID** Edit and register.

③ Select **[WORK FRQ]** → press  and registered frequency list shows → select by **[▲][▼]** → 

TX FREQ. / RX FREQ.

↓

01	:	10,000.0/ 20,000.0
02	:	14,000.0/ 14,000.0
03	:	
04	:	
05	:	
06	:	
07	:	
08	:	
09	:	
10	:	

**[Ref.]**  How to register frequency that communicate with voice: **MENU>9.SYSTEM SET>5.ID/FR/TEL Set>3.Work Frequency** Edit and register.

c) After setting items, press  and "Geography call" signal transmits.

d) When ACK response signal is received, communication can be possible with the voice communication frequency.



④ [PARTY AD]: Input location data

[▲][▼] Move to **PARTY\_AD**



Selected.

- N\_\_ : North latitude (00 - 90) ( $\varphi$ )
- S\_\_ : South latitude (00 - 90) ( $\varphi$ )
- E\_\_ : East longitude (000 - 180) ( $\lambda$ )
- W\_\_ : West longitude (000 - 180) ( $\lambda$ )
- DA\_\_ : Latitude range (Offset Value) ( $\Delta\varphi$ )
- Do\_\_ : Longitude range(Offset Value) ( $\Delta\lambda$ )

[Ref.]  $\varphi$  = Latitude  
 $\lambda$  = Longitude  
 $\Delta\varphi$  = Latitude Range  
 $\Delta\lambda$  = Longitude Range

[Number. button] Input the value.



Set up.

[Ref.] every press [▲][▼]

N\_\_E\_\_ / S\_\_W\_\_ / S\_\_E\_\_ / N\_\_W\_\_ be switched in turns.

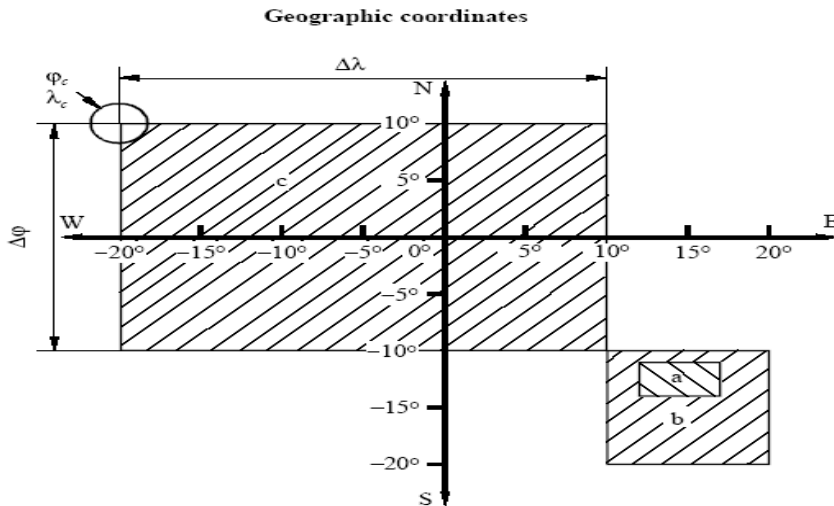

a)  $\varphi_a = -11^\circ$  (South)     $\lambda_a = 12^\circ$  (East)     $\Delta\varphi = 3^\circ$      $\Delta\lambda = 5^\circ$

Format specifier	2	1	1	0	1	2	0	3	0	5	Category
------------------	---	---	---	---	---	---	---	---	---	---	----------

Sector                       $\varphi_a$                        $\lambda_a$                        $\Delta\varphi$                        $\Delta\lambda$

b)  $\varphi_b = -10^\circ$  (South)     $\lambda_b = 10^\circ$  (East)     $\Delta\varphi = 10^\circ$      $\Delta\lambda = 10^\circ$

Format specifier	2	1	0	0	1	0	1	0	1	0	Category
------------------	---	---	---	---	---	---	---	---	---	---	----------

c)  $\varphi_c = 10^\circ$  (North)     $\lambda_c = -20^\circ$  (West)     $\Delta\varphi = 20^\circ$      $\Delta\lambda = 30^\circ$

Format specifier	1	1	0	0	2	0	2	0	3	0	Category
------------------	---	---	---	---	---	---	---	---	---	---	----------

### (5) Auto/Semi-AT msg edit

a) Use for communicating connected with telephone.

**5** **SPK** **5.Auto/Semi-AT mag edit** is selected.



The below box shows.

```
CH = 300 : (NO DATA)
CH = 301 : (NO DATA)
CH = 302 : (NO DATA)
.....
CH = 399 : (NO DATA)
```

**[▲][▼][◀][▶]** The channel is selected.



The below box shows.

1 Save 2 F/C/SP 3 Search ID

```
Tx-Freq : 2,187.50
FORMAT : AT/semi-AT
CATEGORY : Routine
PARTY_ID : 00000000
TEL_CMD1 : J3E TP
TEL_CMD2 : No information
WORK_FRQ : /
TEL_NO. :
EOS : ACK RQ
```

① **[TX-Freq]**: Set TX frequency.

**[▲][▼]** Move to **TX-Freq**



The below box shows.

```
01 : 2,187.50
02 : 4,207.50
03 : 6,312.00
04 : 8,414.50
05 : 12,577.00
06 : 16,804.50
19 : 8,414.50
```

**[▲][▼]** The frequency is selected.



Selected.

**[Ref.]** Indicate the frequencies which is memorized by user in DSC mode CH7~19.

② **[FORMAT]**: A kind of calling.

AT/semi-AT : AT/semi-AT Calling(fixed)

③ **[CATEGORY]**: Purpose of calling.

Routine : use generally (fixed)

④ **[PARTY ID]**: Input ID.

**[▲][▼]** Move to **PARTY\_ID**



Press.

**[Number. button]** Input ID.



Set up.

⑤ **[TEL\_CMD1]**: Set Telecommand1.

**[▲][▼]** Move to **TEL\_CMD1**



The below box shows.

```
J3E TP
F1B/J2B TTY-FEC
F1B/J2B TTY-ARQ
End of call
```

**[▲][▼]** Go to the menu you want.



Selected.

⑥ **[TEL\_CMD2]**: fix "No information".

⑦ **[WORK\_FRQ]**: Operational frequency.

**[▲][▼]** Move to **WORK\_FRQ**



Selected.

**[Number. button]** input TX frequency.



Set up.

**[Number. button]** input RX frequency.



Set up.

⑧ **[TEL\_NO.]**: Input telephone number.

**[▲][▼]** Move to **TEL\_NO.**



Selected.

**[Number. button]** Input telephone number.



Set up.

⑨ **[EOS]**: Completion of DSC message.

ACK RQ : Auto-set.(fixed)

b) Function keys

1 Save 2 F/C/SP 3 Search ID

① After inputting data press **1 FRCH** and it is saved.

② select **[PARTY-ID]** → press **3 TONE** and registered ID list shows → select by **[▲][▼]** →

```
01 : SAMYUNG 101010000
02 :
03 :
04 :
05 :
06 :
07 :
```

**[Ref.]** How to register ID: **MENU>9.SYSTEM SET>5.ID/FR/TEL Set>1.ID** Edit and register.

③ Select **[WORK FRQ]** → press **[3 TONE]** and registered frequency list shows → select by **[▲][▼]** → **[↵]**

TX FREQ. / RX FREQ.

01 :	10,000.0 / 20,000.0
02 :	14,000.0 / 14,000.0
03 :	
04 :	
05 :	
06 :	
07 :	
08 :	
09 :	
10 :	

**[Ref.]** How to register frequency that communicate with voice: **MENU>9.SYSTEM SET>5.ID/FR/TEL Set>3.Work Frequency Edit and register.**

④ select **[WORK FRQ]** → press **[2 ATT]** to change **[WORK FRQ]** / **[POSITION]**.

• Select **[POSITION]** by **[2 ATT]** → **[↵]**  
→ Input by **[No. button]** → **[↵]**

⑤ Select **[TEL NO.]** → press **[3 TONE]** and shown registered Telephone No. List  
→ select by **[▲][▼]** → **[↵]**

**[Ref.]** How to register Telephone No: **MENU>9.SYSTEM SET>5.ID/FR/TEL Set>3.Telephone No. Edit and register)**

c) After setting items, press **[CALL STOP]** and signal transmits.

d) Coast station call by telephone with calling data, connect the signal and send ACK signal to ship and then will be communicated as switching fixed voice communication frequency.

**(6) Dist ack/rly msg edit**

a) After inputting the info. , use this menu to respond to distress signal and manual relay of the distress message.

**[6 PRT]** **6.Dist ack/rly msg edit** is selected.  
**[↵]** The below box shows.

2 Manual	
00,00,00	00:00 Freq: 400
FORMAT :	Distress
PARTY-ID :	000000000
NATURE :	
POSITION :	N , . E , .
DIST-UTC :	
TEL CMD :	
EOS :	ACK RQ

b) It is memory channel using from 400 to 499 as right on the top.

**[Ref.]** **[▲][▼]**: Moving up and down with 1 step channel.

**[◀][▶]**: Moving up and down with 10 step channels.

c) When received recently distress signal from other ship, can check the message.

→ Press **[↵]**, input ID → press **[CALL STOP]** and then transmit to Distress signal.

d) Press **[2 ATT]**, shown new relay message on screen and will be editable.

2 Manual	
Tx-Freq :	2,187.50
FORMAT :	Individual
CATEGORY :	Distress
PARTY_ID :	000000000
TEL CMD :	Distress Relay
DIST-ID :	
NATURE :	Undesignated
POSITION :	N , . E , .
DIST-UTC :	--:--
TEL CMD :	J3E TP
EOS :	ACK RQ

When can not send distress signal, edit and press **[CALL STOP]** and then can be transmitted.

① **[TX-Freq]**: Set TX frequency.

**[▲][▼]** Move to **[TX-Freq]**

**[↵]** The below box shows.

01 :	2,187.50
02 :	4,207.50
03 :	6,312.00
04 :	8,414.50
05 :	12,577.00
06 :	16,804.50
19 :	8,414.50

**[▲][▼]** The frequency is selected.

**[↵]** Selected.

**[Ref.]** Indicate the frequencies which is memorized by user in DSC mode CH7~19.

② **[FORMAT]**: A kind of calling.

**[▲][▼]** Move to **[FORMAT]**

**[↵]** Press **[↵]** to change **[Geography]** / **[Individual]**.

③ **[CATEGORY]**: Purpose of calling.

Distress :	Distress calling(fixed)
------------	-------------------------

④ **[PARTY ID]** : Input the ID of counter party.  
 • In case of selecting **[Individual]** in [FORMAT], input ID

**[▲][▼]** Move to **PARTY\_ID**

 Selected.

**[Number. button]** Input ID.

 Set up.

• Select [FORMAT] In case of **[Geography]**, shown [PARTY-AD], input specific area.

**[▲][▼]** Move to **PARTY\_AD**

 Selected.

**[Number. button]** Input ID.

 Set up.

**[Ref.]**  **MENU>4.Geography msg edit/ PARTY AD** and register.

⑤ **[TEL CMD]**: fix "Distress Relay"

**[Ref.]**  Distress Relay: in case of relaying broadcast cause the distance is far from coast station.

⑥ **[DIST ID]**: Input the ID of the vessel in distress.

**[▲][▼]** Move to **DIST ID**

 Selected.

**[Number. button]** Input ID.

 Set up.

⑦ **[NATURE]**: The type of distress.

**[▲][▼]** Move to **NATURE**

 The below box shows.

Fire, Explosion
Flooding
Collision
Grounding
Listing
Sinking
Adrift
Undesignated
Abandon ship
Piracy/Attack
Man Overboard

**[▲][▼]** Go to the menu you want.

 Selected.

⑧ **[POSITION]**: Input the Position of the vessel in distress.

**[▲][▼]** Move to **POSITION**

 The below box shows.

N _ _ , _ _ , _ _ _ _ / E _ _ _ , _ _ , _ _ _ _
North latitude(00.00.0000~90.00.0000)
east longitude(000.00.0000~180.00.0000)
S _ _ , _ _ , _ _ _ _ / W _ _ _ , _ _ , _ _ _ _
South latitude(00.00.0000~90.00.0000)
west longitude(000.00.0000~180.00.0000)

**[Number button]** Input the value.

 Set up.

**[Ref.]**  Press **[▲][▼]** to change [N -- E --] / [S -- W --] / [S - E --] / [N -- W --] in turns

 If the value is beyond the value range, the set up can not be done.

⑨ **[DIST-UTC]**: Input the time of distress.

**[▲][▼]** Move to **DIST-UTC**

 The below box shows.

- - : - - : Time of Distress(00:00 - 23:59)
---

**[Number. button]** Input the time.

 Selected.

**[Ref.]**  Set automatically in connection with GPS.

⑩ **[TEL CMD]**: Set Telecommand.

**[▲][▼]** Move to **TEL CMD**

 Press  to change **[J3E TP] / [FIB/J2B TTY-FFC]**.

⑪ **[EOS]**: Completion of DSC message.  
 (EOS= End of Sequence)

ACK RQ: Auto - set. (fixed)
-----------------------------

e) After setting items, press  and signal transmits.

f) When other ship or coast station send ACK answer, ship that transmitted distress be going to receive.

**(7) Ordinary ack msg edit**

a) In case of common answer call.



**7. Ordinary ack msg edit** is selected.

The below box shows.

```
07,10,04 12:10 Freq:2,182.00 500
FORMAT : Individual
CATEGORY : Routine
PARTY-ID : 123000000
TEL CMD1 : J3E TP
TEL CMD2 : No information
WORK FRQ : 2,182.00 / 2,182.00
-----
EOS : ACK RQ
```

b) Memory channel is from 500 to 599 and it shows on the right top of the box. You can see the general info. Except distress signal.

**[Ref.]** **[▲] [▼]**: Moving up and down with 1 step channel.

**[◀] [▶]**: Moving up and down with 10 step channels.

c) In this menu press and can be answered.

**(8) Display and print msg**

a) In checking the written messages or auto printing.



**8. Display and print msg** is selected.

The below box shows.

```
FORMAT : Individual No:300
CATEGORY : Routine
PARTY-ID :
TEL CMD1 : J3E TP
TEL CMD2 : No information
WORK FRQ : 2,182.00 / 2,182.00
EOS : ACK RQ
```

b) Channels are 300 to 399, can be confirmed on screen.

**[Ref.]** **[▲] [▼]**: Moving up and down with 1 step channel.

c) If this mode is selected with the printer connected, printing of the message starts automatically.

**(9) System Set**

a) in case of setting the value of SYSTEM.



**9. System Set** is selected.

The below box shows.

1. Self ID Set 000000000
2. Group ID Set 000000000
3. Dist TEL-CMD J3E TP
4. LAT/LON Set
5. ID/FR/TEL Set
6. WKR Scan Set
7. Data Clear
8. ID Printing
9. Data Transmit
0. Etc. Set

① **[1.Self ID Set]**: Input own ship ID.



**1. Self ID Set** is selected.

Selected.

**[Number. button]** Input ID.



Set up.

② **[2.Group-ID Set]**: Input Group ID.



**2. Group ID Set** is selected.

Selected.

**[Number. button]** Input ID.



Set up.

**[Ref.]** it's possible to input just 1 time because ID is proper number of the ship, so if you want to make modification, you can reach in menu by password. Distributor has a password.

**[Ref.]**

**• How to change ID.**

Press to go to **[SSB]** mode

→ → → →

→ [ ] → [ ] → [ ] → [ ] (Password-Contact dealers)

→ → → → (Set as 'ENABLE')

→ → → (Return to main screen)

**• [Self-ID Set]**

Press to go to **[DSC]** mode

→ → → → →

→ Input by **[No. button]** →

**• [Group-ID Set]**

Press to go to **[DSC]** mode

→ → → → →

→ Input by **[No. button]** →

③ **[3.Dist TEL-CMD]**: Set Telecommand.

**3** TONE  
 ↓  
**3. Dist TEL-CMD** is selected.  
 Press ↓ to change  
**[J3E TP] / [FIB/J2B T]**.

④ **[4.LAT / LON Set]**: Set Lat/Lon of GPS by hand-operation.

**4** SCAN  
 ↓  
**4. LAT/LON Set** is selected.  
 The below box shows.

```

POS : N      .      E      .
UTC  : --:--
Date Set
    
```

**[Number button]** Input the value.

↓ Set up.

⑤ **[5.ID/FR/TEL Set]**: Edit ID/Auto answering ID/Operating frequency/Telephone number.

• **[1.ID]** edit

**5** SPK  
 ↓  
**5. ID/FR/TEL Set** is selected.  
 Selected.  
**1** FRICH  
 ↓  
**1. ID** is selected.  
 The below box shows.

```

01 :
02 :
03 :
04 :
05 :
06 :
07 :
08 :
09 :
10 :
    
```

↓ The below box shows.

```

01 :
02 :
03 :
    
```

1	2	3
. QZ	ABC	DEF
4	5	6
GHI	JKL	MNO
7	8	9
PRS	TUV	WXY
esc	0	ent
ESC	-/	ENT

00 :

**[Number button],[▶]** Select Character,  
**move, Select Character, move**

↓ The below box shows.  
 000000000

**[Number. button]** Input ID.

↓ Set up.

ESC If want to return menu.

Ex) How to input ID and ship's name:  
**"SAMYUNG", "101010000"**

• **5** SPK → ↓ → **1** FRICH → ↓ → ↓ → **7** NB → **7** NB  
 → **7** NB → [▶] → **2** ATT → [▶] → **6** PRT → [▶] → **9** SQL → **9** SQL  
 → **9** SQL → [▶] → **8** AGC → **8** AGC → [▶] → **6** PRT → **6** PRT → [▶]  
 → **4** SCAN → ↓ → **1** FRICH → **0** CHK → **1** FRICH → **0** CHK → **1** FRICH  
 → ↓ It is input as below

```

01 : SAMYUNG 101010000
02 :
03 :
04 :
05 :
06 :
07 :
    
```

**[Ref.]** Blank is filling with "0."

• **[2. Auto-ack ID]** edit

**5** SPK  
 ↓  
**5. ID/FR/TEL Set** is selected.  
 Selected.  
**2** ATT  
 ↓, ↓  
**2. Auto-ack ID** is selected.  
 Selected.

**[Number. button]** Input ID.

↓ Set up.

• **[3. Work Frequency]** edit

**5** SPK  
 ↓  
**5. ID/FR/TEL Set** is selected.  
 Selected.  
**3** TONE  
 ↓, ↓  
**3. Work Frequency** is selected.  
 Selected.

**[Number. button]** Input TX frequency.

↓ Set up.

**[Number. button]** Input RX frequency.

↓ Set up.

• **[4. Telephone No.]** Edit

**5** SPK  
 ↓  
**5. ID/FR/TEL Set** is selected.  
 Selected.  
**4** SCAN  
 ↓, ↓  
**4. Telephone No.** is selected.  
 Selected.

**[Number. button]** Input telephone number.

↓ Set up.

⑥ **[6.WKR Scan Set]**

**6 PRT** **6. WKR Scan Set** is selected.  
 The below box shows.

2187.5	on
4207.5	on
6312.0	off
8414.5	on
12577.5	off
16804.5	off

**[▲][▼]** The frequency is selected.  
**[↵]** Press **[↵]** to change **[on] / [off]**.  
**[Ref.]** **[2187.5]** and **[8414.5]** must be on.

⑦ **[7.Data Clear]**: Able to delete the user data and received data.

**7 NB** **7. Data Clear** is selected.  
 The below box shows.

1.DSC Made-File clear	→User DSC data
2.DSC Distress clear	→Distress data among received DSC data
3.DSC Ordinary clear	→Data except Distress data among Received data
4.DSC Channel clear	→Delete all data of DSC Channel
5.DSC All Data clear	→Clear all data of DSC to make an initial

**[▲][▼]** Go to the menu you want.  
**[↵]** The below box shows.

No
Yes

**[▼]** Move to **Yes**  
**[↵]** The data will be deleted

⑧ **[8.ID printing]**: Print ID.

⑨ **[9.Data Transmit]**: Able to select type of transmitting data and can be used in data transmitting.

**9 SQL** **9. Data Transmit** is selected.  
 The below box shows.

1.Dot Transmit	→ Send Dot signal only
2.Mark transmit	→ Send Mark signal only
3.Space Transmit	→ Send space signal only

**[Ref.]** select on of them by **[▼]** **[▲]**  
 →press **[↵]** and then it is transmitted immediately so must be careful.

⑩ **[0.Etc. Set]**: Set etcetera system.

**0 CHK** **0. Etc. Set** is selected.  
 The below box shows.

1. GPS Alarm	off
2. Scan Speed	0
3. Default Channel	
4. Auto Ack	off
5. DSC Msg Receive	off
6. DSC Trans. Mode	SIN
7. DSC Geo. Range	
8. Dist-Key Test	
9. Medi-Trans.	Set on

• **[1. GPS Alarm]**

**1 FR/CH** **1. GPS Alarm** is selected.  
 Press **[↵]** to change **[on] / [off]**.

**[Ref.]** Regardless of "on" don't received GPS signal, display "error" on screen and sound alarm continually.

• **[2. Scan Speed]**: Adjust SCAN speed of usable DSC channel by user.  
 The higher number it is, the slower speed (7~19Ch).

**2 ATT** **2. Scan Speed** is selected.  
 Selected.  
**[Number. button]** Input the value.  
 Set up.

• **[3. Default Channel]**: [SIN] = If set Single MENU>2.Individual msg edit / 3.Group msg edit / 4.Use Geography msg edit.

**3 TONE** **3. Default Channel** is selected.  
 Selected.

2,187.5
4,207.5
6,312.0
8,414.5
12,577.0
16,804.5

**[▲][▼]** The frequency is selected.  
 Selected.

• **[4. Auto ACK]**: Auto answer on distress calling.

**4 SCAN** **4. Auto ACK** is selected.  
 Press **[↵]** to change **[on] / [off]**.

**[Ref.]** showed "ACK" on screen, in case of setting "on."

- **[5. DSC Msg Receive]:** Receive DSC message.



**5. DSC Msg Receive** is selected.



Press  to change **[on]** / **[off]**.

**[Ref.]**  message receiving is not available.

- **[6. DSC Trans. Mode]:** Set DISTRESS TX channels SIN (single) or MUL (multi).



**6. DSC Trans Mode** is selected.



Press  to change **[MUL]** / **[SIN]**.

**[Ref.]**  Select **[MUL]**, transmit 6channels in turns and select **[SIN]** the first channel (2,187.50 KHz) just transmit 5 times repetitively.

- **[7. DSC Geo. Range]:** Set area range Geography message transmitting.





**7. DSC Geo Range** is selected.



Press  to change **[120]** / **[240]**. /

**[360]** / **[500]** / **[600]**. (단위는 NM)

**[Ref.]**  **MENU>4.Geography msg edit** on screen. In case of setting **[PARTY-AD]** area range, just input latitude and longitude and press  and then setting value shown that are inputted of changing value of latitude range and longitude.

- **[8. Dist-Key Test]:** [DISTRESS] button Test.



**8. Dist-Key Test** is selected.



The below box shows.

Press Distress Key

- Press  [DISTRESS] for 3 seconds and the below box shows.

Press Stop Key



Back to Main screen.

- **[9. Medi-Trans. Set]:** Set Medical Transport [on] / [off].



**9. Medi Trans Set** is selected.



Press  to change **[on]** / **[off]**.

**[Ref.]**  in case of setting "on" **MENU>4.Geography msg edit>TEL CMD2** and then can be set.



# Chapter 7. Transmitter of distress signal

## 7.1. Test of Distress alert signal

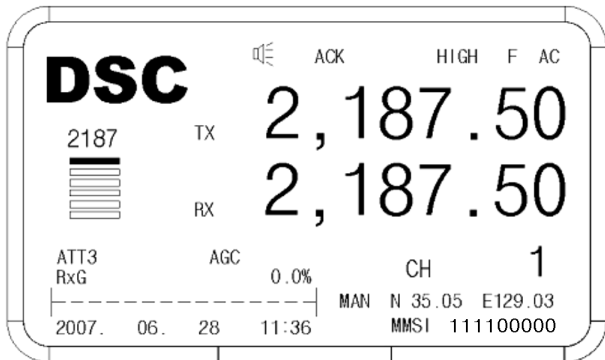

(1) Hold on 3 seconds [DISTRESS] in the panel, flicker [DISTSS] LED with alarm and after 3 seconds shown following screen, [DISTSS] LED is lighted and transmit distress location, distress time, ID.

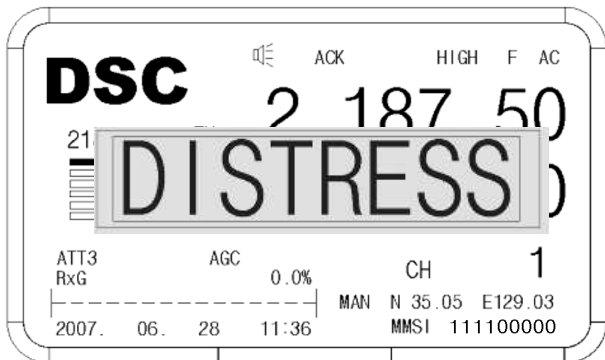

•Transmit channel 1 ~ 6 as follow.

01	:	2,187.5
02	:	4,207.5
03	:	6,312.0
04	:	8,414.5
05	:	12,577.0
06	:	16,804.5

(2) If don't have a answer, flicker [DISTSS] LED and shown following screen and then after 4 minutes(3min 30sec ~4min 40sec), transmit channel 1 ~ 6.

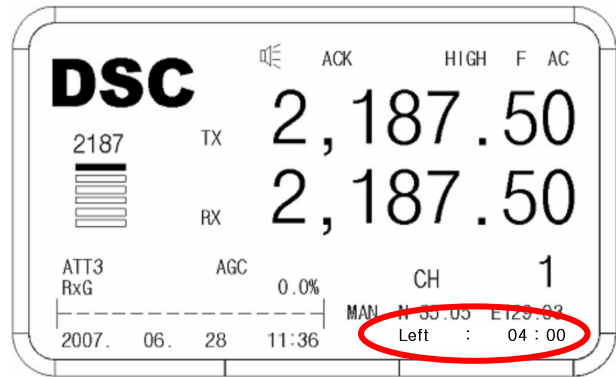

**[Ref.]** begin in countdown "Left 04:00."

(3) If you want to stop to transmit, press **CALLSTOP**. Even you press **CALLSTOP**; channel that is transmitting will be stop after finishing the transmitting.

**[Ref.]** **MENU>9.System Set>1.Self ID Set** If it didn't set and then flicker **[MMSI not entered]** on main screen and can't transmit.

## Chapter 8. RX of Distress & general call

### 8.1. RX of Distress Alarm

(1) Once Distress alarm is received from Distressed vessel, Red color **[DISTS]** LED is blinking and Alarm sounds. To stop the Alarm, press **CALL/STOP**. If the CRS reply to the Distress message, the reply messages appear. (Normally within 3 min.) If the Distressed vessel receives ACK message from CRS, follow the CRS instruction.

(2) Flow Chart

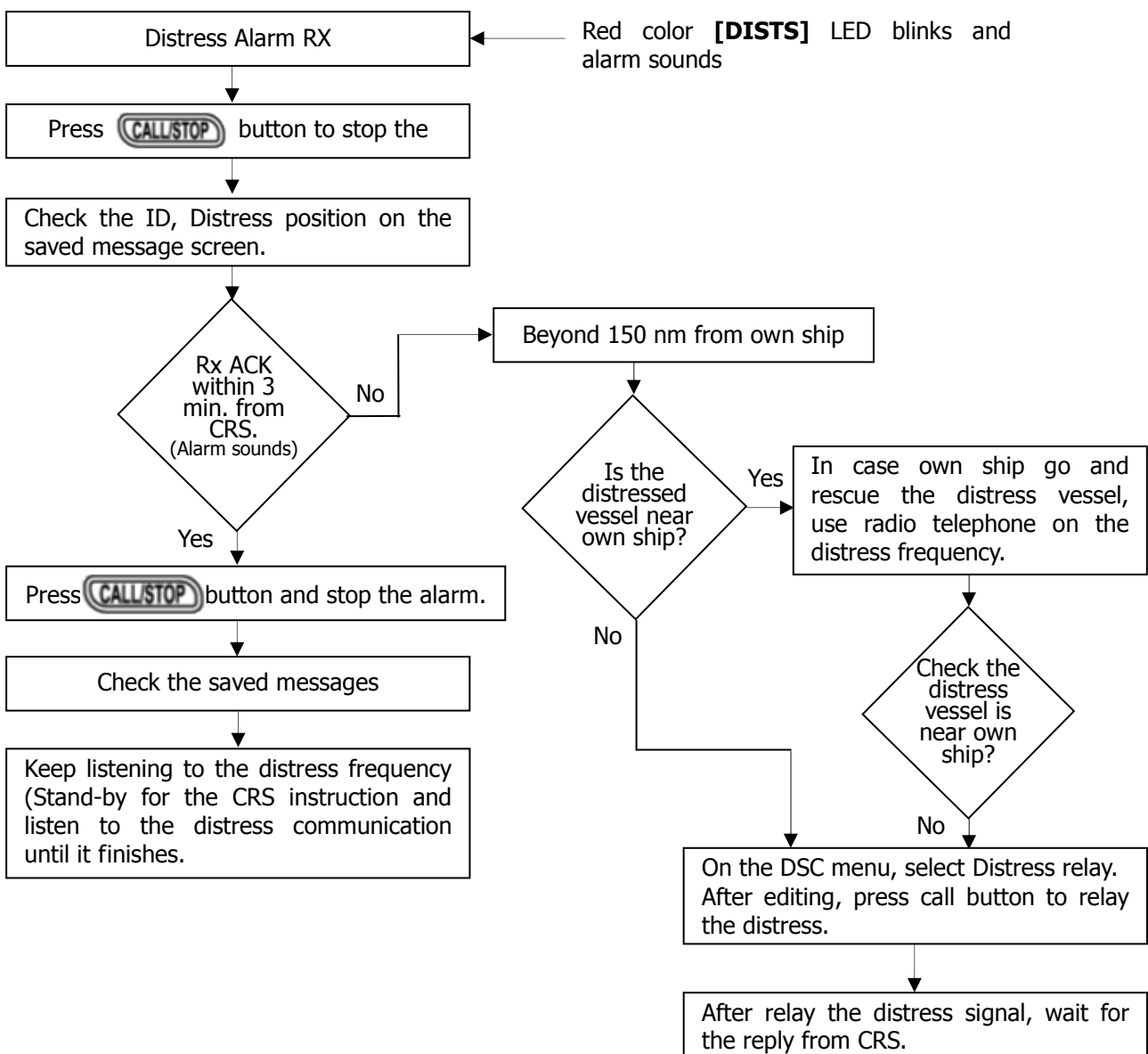

## 8.2. General call RX

(1) In case **[Auto ACK]** is **[on]**, if you receive individual call & group call, automatically, ACK reply transmits and the frequency is set to TX/RX counter party.

(2) Flow Chart

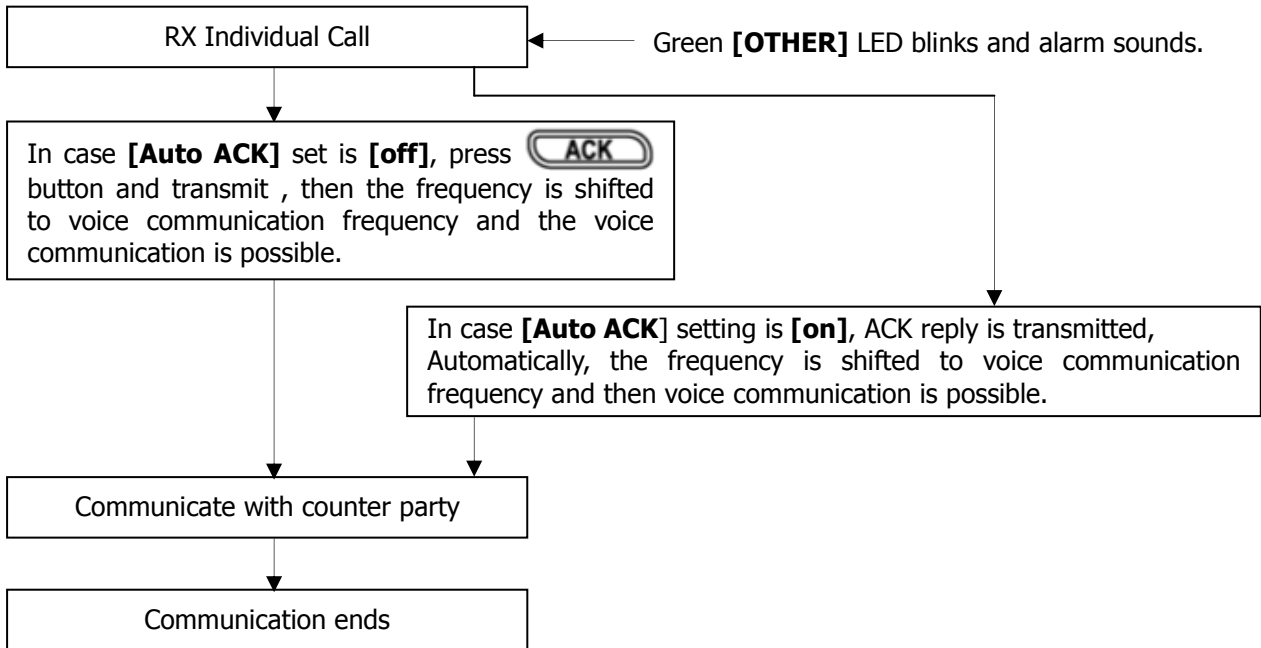

## Chapter 9. How to use print

### 9.1. DPU-414 Printer

#### (1) Caution for use

a) The printing paper used for the DPU-414 is a special kind of paper which turns black by the thermo chemistry reaction.

Take as following precaution when using the paper.

- Store away from Hit, Humidity, light.
- Dry hands before handling with the paper
- Don't rub the paper with any kind of hard or coarse materials.
- Don't use organic adhesive on the paper. (Instead of that, water-based starch adhesives or compound adhesive.)
- Don't use adhesive tape on the paper. (However, using both sides tape is possible.)
- Don't allow the paper to remain in contact with polyvinyl chloride film for a long time.
- Don't leave the paper in contact with freshly coped giazo type or wet process paper.
- Don't allow the paper to come into contact with organic solvents.

#### b) Caution for operation

- Check there is a paper in it before use.
- Don't turn off while operation and turn off after PRINT HEAD is at HOME POSITION.
- Printer test function is built-in.

#### (2) Operation Panels

##### a) POWER Switch

Switch on the turn this unit on. Printer head do going and returning once, the paper is fed by one column.

On condition that main unit of SRG-3150DN is power on.

##### b) FEED Switch

Press FEED switch when feed the paper out by force.

On pressing this switch once, it will be feed once and on pressing this switch continuously, it will be kept feeding.

##### c) CUTTER

Use for cutting the printer paper.

d) Exit of paper - It is the part where the paper is ejected through it.

##### e) PAPER COVER

Store up the paper inside it.

#### (3) Usual operation.

Check the main unit of SRG-3150DN is turned on. If power on, it is able to print TX/RX DSC MESSAGE and DATA from SRG-3150DN automatically.

#### (4) How to store the printer paper roll

a) Cut the printer paper horizontally. If there is the wrinkle on the paper, it may cause the paper jam.

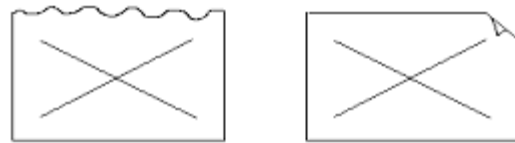
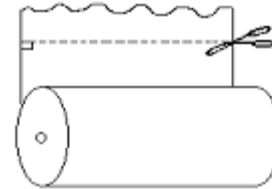

< ↑ PRINTER PAPER HANDLING >

b) Switch off the printer

c) Open the PAPER COVER and pull out the CENTER SHAFT.

d) Insert the CENTER SHAFT in the center of the PAPER ROLL and put the end of the paper into the way-in of the paper.

e) Switch of the PRINTER and press the FEED KEY until the paper is hauled.

f) Store up the center shaft and the paper gets out of the way-out.

g) Press FEED KEY until the end of paper gets out of the way-out.

h) Close the PAPER COVER and put it down to shut.

### 9.2. OKI Printer

#### (1) Common Operation

a) Check out the power of SRG-3150DN connected with a Printer ON.

b) Pull the switch of the POWER up to turn on the power.

c) The DATA and DSC MESSAGE transferred from SRG-3150's transmitting and receiving process is automatically activated.

#### (2) PAPER LOADING

a) Place the printer on a slotted printer stand, carefully aligning the slot in the stand with the opening in the base of the printer.

b) Place the box of paper under the printer stand.

c) Remove the access cover and lift the column indicator bar.

d) Open the paper release lever.

e) Insert the first sheet of paper through the opening in the bottom of the printer.

f) Slide the paper up until it appears in front of the platen.

g) Lower the column indicator bar.

h) Close the paper release lever.

i) Use the platen knob to advance the paper to the first printing line.

j) Replace the access cover.

## Chapter 10. How to use SD-250(Alarm box)

### 10.1. Distress transmitting

(1) If you press 'Distress key' (Red Button) for 3 sec., it alarms for 3 seconds.

After that, the red light is turned on with bip-sound. While Distress Key is blinking, transmitting is started to work and location of disaster, time, ship's ID are sent to DSC 6 CH in order.

If there is no answer, it does sending till getting an answer through CH1 to CH 6.

(2) In order to stop the transmitting, press the 'Reset key'.

- If distress signal is sent by mistakes, contact to marine police or station, SAR.

### 10.2. In case of receiving distress signal

(1) Distress LED blinks and sounds 'bip'.

Check contents displayed on the screen and press Reset key to stop.

### 10.3. Operation by DC (Battery)

(1) If AC power is turned off, POWER LED is blinking with "Bip-" sound and presses the Reset key to stop the sound.

(2) POWER LED keeps blinking while the equipment is operated by DC power.

## Chapter 11. How to use SP-1250ADC

### 11.1. Specification

(1) Input : AC110V / AC220V Conversion Type  
(Basis AC220V)

(2) Output : DC24V 50A AVR

(3) Charging current: 20A (Max)

(4) OFF = Not charging. (Middle of Switch)

(5) NORMAL = Sometimes charge it in the mode.

### 11.2. Input power shift

In case of AC Power stopping, the buzzer is ringing and LED green light of AC OFF is on. In order to stop the buzzer's ringing, you can turn to OFF in the switch of ALARM.

(6) In case of checking the charged current, the switch of CURRENT is turned to CHARGER.

- In case of transmitting SSB, the switch is turned to TX in order to check the current.

- REFERENCE: SP-1250ADC is designed to connect with SSB SRG-3150D only and it is charged as own-battery power according to the regulation of IMO (GMDSS).

If it is connected with other SSB equipment, you should intercept the charging-circuit in SP-1250ADC and use the high-capacity charging.

### 11.3. How to Charge

(1) In case of transmitting SSB, it doesn't be charged.

(2) There is AUTO / OFF / NORMAL in a switch of the Charger.

(3) AUTO = in a long-time charging and it turns to auto-off when it is completed.

- In charging, the LED of CH turns on a light.

### 11.4. In case of over current

- In case of being over than 45A current, the LED red light of OVER CURRENT is on and the buzzer is ringing. On this occasion, intercept the Power Switch AC / DC for over than 1 minute and turn the Power on after deleting the occasion.

- In less 23 voltages, auto-charged and finished for charging in less 0.5 A.

## Chapter 12. Circuit explain

### 12.1. Overview of SRG-3150DN

- SRG-3150DN MF/HF DSC RADIO equipment consists of circuit, PRINTER, ATU (SAT-100).

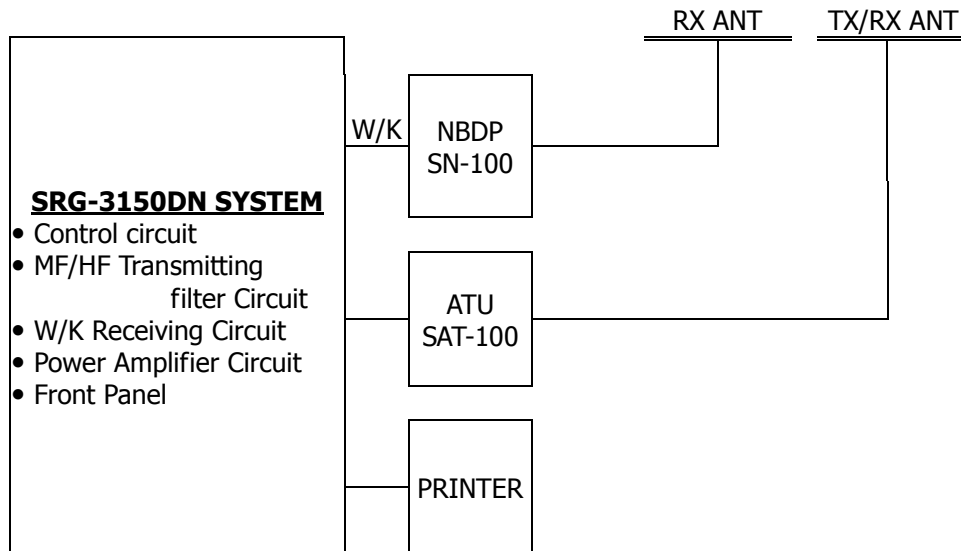

< ↑ SRG-3150DN MF/HF BLOCK DIAGRAM >

- SRG-3150DN consists of Power Amplifier circuit, Control circuit, MF/HF Transmitting filter circuit, Front Interface, W/K Receiving Circuit.
- At the rear side of this equipment, there are connectors connected with ATU BOX (SAT-100), SP-1250, ALARM BOAX (SD-250) and connectors of PL-259 type connected with aerial coaxial cable for MF/HF transceiver / receiver and for W/K receiver, a

terminal for GPS DATA receiving, external BK Connecting, Printer power supply and besides, connectors for power supply, fuse, earth terminal for system earthing, external SPK jack and D-SUB connectors connected with a Printer, Remote Interface, NBDP (SN-100).

## 12.2. CONTROL CIRCUIT (T-1110)

• The Control Circuit consists of MF/HF TX/RX circuit, Local Synthesizer circuit, Power circuit and CPU circuit.

### (1) MF/HF RX Circuit

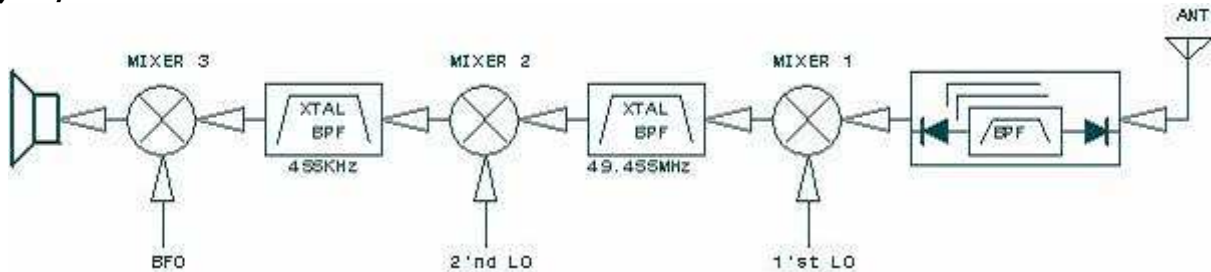

< ↑ RX BLOCK DIAGRAM >

- RX method is a Double Super-heterodyne receiver using two intermediate frequencies, 1st IF=49.455MHz and 2nd IF=455 KHz. Receiving signal in whip antenna pass BPF of 9 bands, then after amplify in RF (Q-53) and
- in 1st MIXER (MX2), it is mixed with 1st LOCAL frequency and demodulated to a first intermediate frequency and the intermediate frequency goes through 49.455MHz X-tal filter (XL5,6) and IF amplifier (Q22) and

- in 2nd MIXER (MX1), it is mixed with 2nd LOCAL frequency and demodulated to a second intermediate frequency and the demodulated frequency goes through 455KHz X-tal filter (FL3) and IF amplifier (Q21,Q23,Q950) and
- In 3rd MIXER (IC15), it is demodulated to a signal of baseband with BFO (Beat Frequency OSC.). The demodulated signal is divided to 3 species as follows.

- ① Amplifiable signal for inner speaker audio.
- ② Amplifiable signal for outer speaker audio.
- ③ FSK MODEM (DSC Signal Demodulation) Signal.

### (2) MF/HF TX Circuit

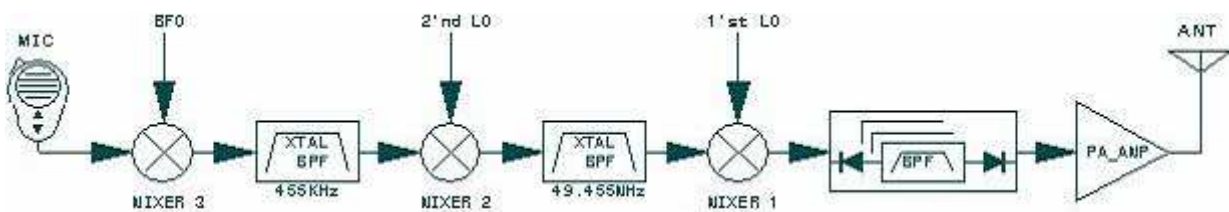

< ↑ TX BLOCK DIAGRAM >

- The baseband signal comes from MIC or NBDP terminal is mixed with BPF, 2nd LOCAL frequency each in MIXER\_3, 2 (IC9, MX1) and goes through each intermediate frequency filters 455KHz (FL3), 49.455MHz (XL1,XL2), each amplifier (Q36,Q35), then is modulated to each intermediate frequencies and the modulated 1st LOCAL frequency in a final MIXER\_1 (MX2) goes through LPF (Low Pass Filter),

BPF of 9bands and then, is input to Power Amplifier (T-1113) and the sufficient amplified signal in PA (Power Amp) goes through a final TX filter (T-1111) and at this time, the harmonic wave (Harmonics) is removed and the signal comes out thru an antenna.

### (3) Local Synthesizer Circuit

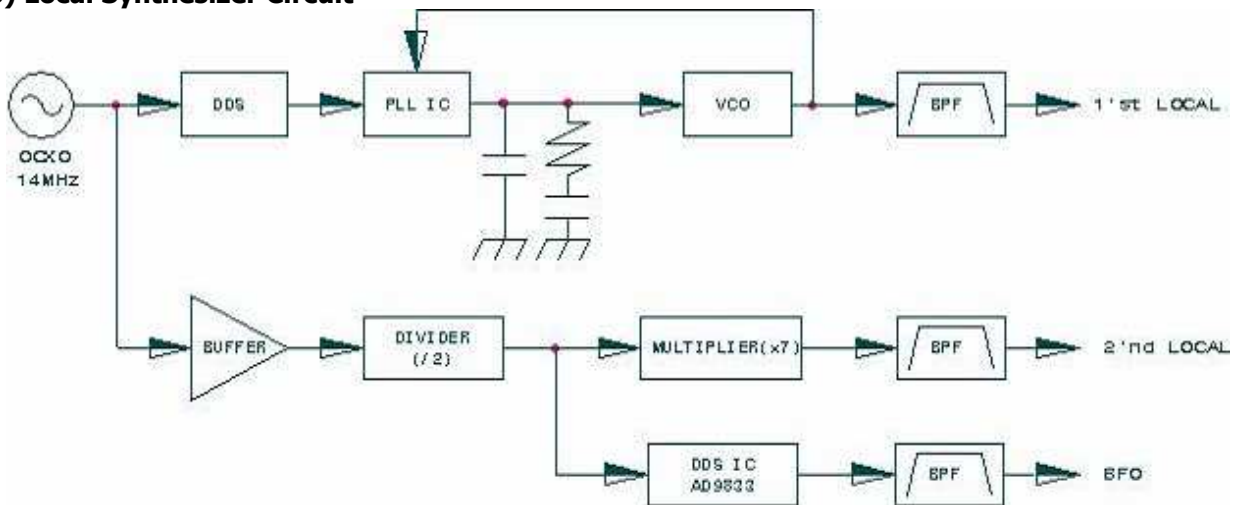

< LOCAL SYNTHESIZER BLOCK DIAGRAM >

- The output of 14MHz OCXO(Over Compensated X-tal Oscillator) is a standard frequency and PLL IC(IC54), VCO(VCO1), DDS(IC56) is output as 1'st LOCAL input signal 49.455~79.4549MHz and 7MHz from output of DDS (IC60) makes 49MHz in 7

frequency multiplier circuit and use as 2'nd LOCAL. 3'rd LOCAL (BFO, Beat Frequency Oscillator) makes 456.4kHz\_125Hz signal directly from DDS (IC62).

### (4) Power Supply Circuit

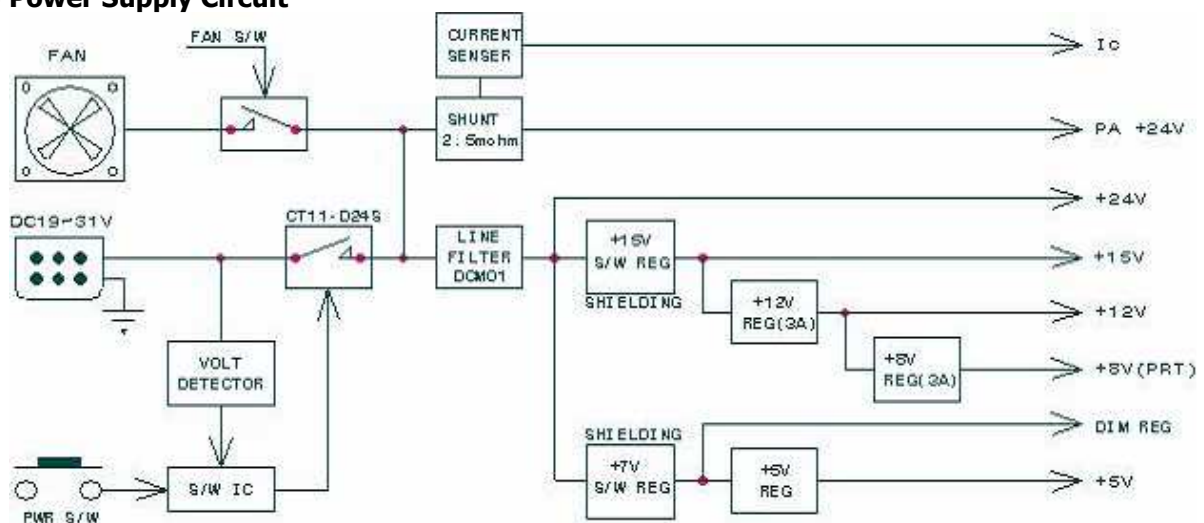

< POWER SUPPLY BLOCK DIAGRAM >

- Power circuit consists of control circuit of power unit to turn on/off DC-24V in power amplifiable unit, constant voltage circuit to supply DC voltage to be constant voltage in each unit. AUDIO AMP for external speaker and operate through DC INPUT (24V BATTERY).

#### ① Main Power Circuit and Power Control Circuit

- When switch on , it controls Relay & goes through Line Filter to supply the power. The output power is +15V / +12V / +8V (voltage for printer) / +7V (Voltage for LCD DIMMER) / +5V. In addition,

it supplies the voltage to NBDP terminal (SN-100), ALARM BOX (SD-25), Printer (OKI or DPU-414).

#### ② Protection / Sensor Circuit

- Operated to turn off the power automatically in a condition of more than +31V or less than +19V owing to built in a Power sensor circuit and it is built in the circuit preventing conversing voltage to avoid damage.

In addition, it is built in Current Sensor to protect the power circuit and power amp with 0.0025Ω resistance.



**(5) Control Circuit**

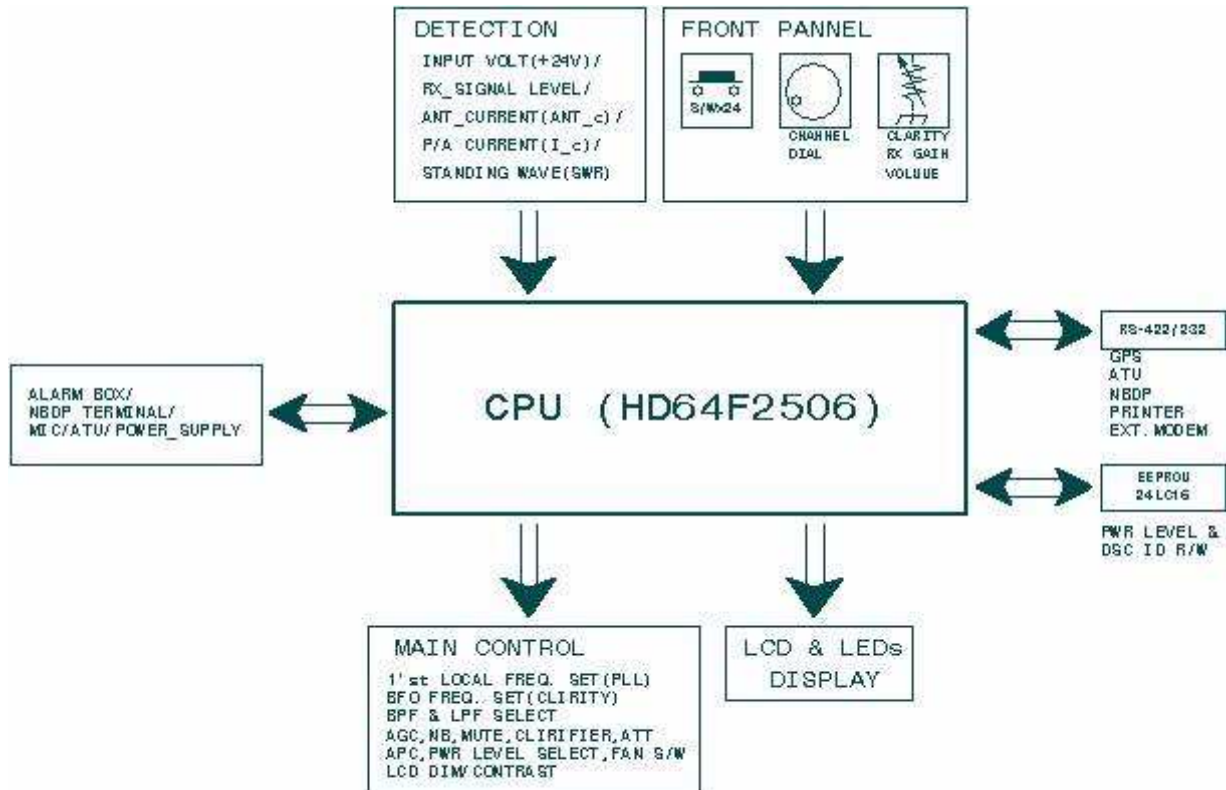

< CONTROL BLOCK DIAGRAM >

- The control part consists of CPU(IC30), EEPROM(IC33,37), REAL TIME CLOCK(IC28), CLOCK Generator(X3), RS-232/422 Data Com-device, MODEM, Audio amplifier(IC32), I/O Amplifier, IC(IC22,IC42,IC46,IC48), LCD Contrast / DIMMER Control Circuit and it controls the whole operation of the unit with the data signals of RS-422/232 from front PANEL operation, external connecting devices, interface.
- CPU device is set by operating PANEL and set synchronizing circuit responded by receiving frequency (selecting channel). Then, according to receiving frequency, set information setting

frequency for SYNTHESIZER or REF/BFO. In addition, the CPU pass signal (LOCAL CONTROL) to indicate various information (receiving frequency, receiving mode, band, width) set by operating panel of controller unit and transmit in control unit. Except this function, in case of interception of power or supply-cease, the CPU control memory degaussing to be back-up by battery built. Memory status before normal of power and in case of normal, possible to rebuild.

**12.3. MH/HF Transmitting Filter Circuit (T-1101)**

- This PCB circuit converts the TX/RX signal as Relay (RY17) by a TX+ (+12V).
- The signal comes from whip antenna is transferred to a main board (T-1110) through Diminishable Relay, BK Relay, Over-input protect

circuit and it receives a TX signal from PA board (T-1113) and select the proper filter in a frequency band and then, remove the harmonic wave and transferred to antenna through power sensor circuit.

## 12.4. W/K Receiving Circuit (T-1112)

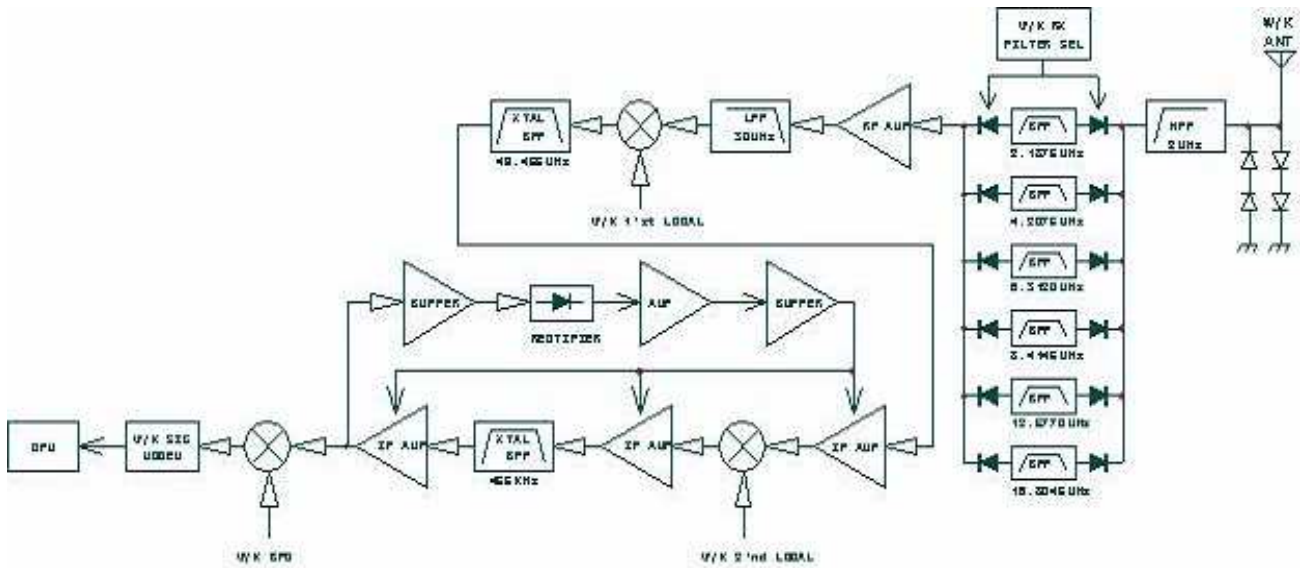

< W/K RECEIVER BLOCK DIAGRAM >

- RX method is a Double Super-heterodyne receiver as such MF/HF receiving method and

1'st intermediate frequency is 49.455MHz and  
2'nd is 455 KHz.

14MHz standard frequency supplied from MAIN (T-1110) is supplied to MIXER making each SYNTHESIZER frequency into a PCB board.

(1) Receiving signal in ANTENNA terminal pass through input over-voltage protecting circuit and BAND-PASS FILTER per frequency (2.187, 5 / 4.207,5 / 6.312 / 8.414,5 / 12.577 / 16.804, 5MHz) and is closing in DSC distress safety frequency. FILTER is response in receiving CHANNEL.

(2) Receiving signal to pass filter is amplified by high-frequency amplifier of width band and is supplied to 1'st MIXER (MX2) through 20MHz LOW

PASS FILTER.

The signal is mixed with 1'st local frequency (W/K 1'st LO) supplied from inner SYNTHESIZER and converted to 1'st intermediate frequency (1'st IF) 49.455MHz and it goes through X-tal filter, IF amplifier, then is supplied to 2'nd MIXER, in 2'nd MIXER, is mixed with 2'nd local frequency (W/K 2'nd LO) 49MHz and converted to 2'nd intermediate frequency (2'nd IF) 455KHz.

(3) It consists of AGC circuit controlling amplify of IF AMP by 2'nd IF and the intermediate frequency supplied to 3'rd MIXER is mixed with BFO signal and demodulated to baseband signal and the output-digitalized signal through MODEM is input to CPU.

## 12.5. Power Amplifier Circuit (T-1113)

- The PCB circuit consists of PA+24V Switching circuit effected by TX+KEY signal, 2 pieces of Drive's part, Power Amp part and after the TX

signal input from a main board (T-1110) is sufficient amplified, sent to the TX Filter board of MF/HF (T-1101).

## 12.6. Front Panel (T-1114)

- The PCB circuit consists of LCD, LED, a kind of tap-switch with a power switch, variable resistance controlling brightness, gain receiving, volume,

channel dial and it is put into a front panel along with the connector for inter speaker, hand Mic (SM-1150).

## 12.7. Function Diagram of Rear Side

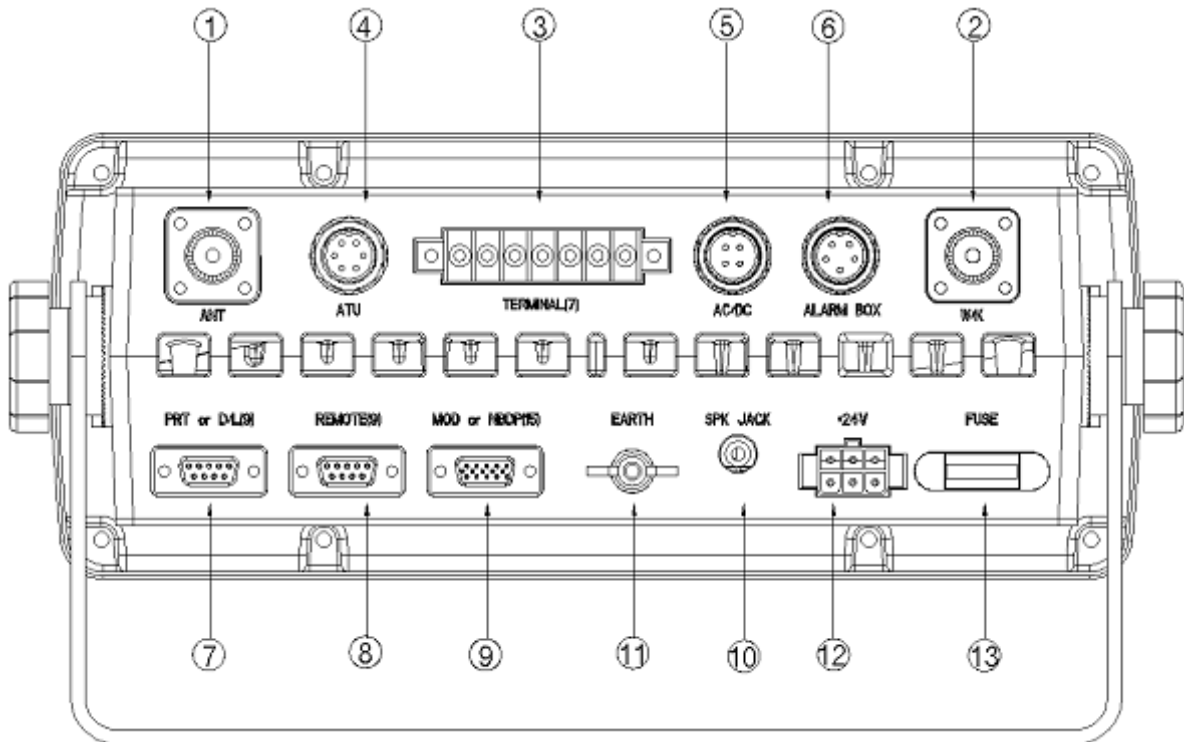

- |  |  |
|--|--|
| <p>① <b>ANT</b> : IMPEDANCE 50Ω MF/HF TX/RX.<br/>ANT. JACK</p> <p>② <b>W/K</b> : IMPEDANCE 50Ω W/K RX. ANT. JACK</p> <p>③ <b>TERMINAL(7)</b> : PRINTER POWER (+8V),<br/>GPS DATA, BK+/- Connector</p> <p>④ <b>ATU</b> : ATU BOX(SAT-100) connector<br/>(Control Cable)</p> <p>⑤ <b>AC/DC</b> : Power Supply (SP-1250) connector<br/>(AC/DC Detect)</p> <p>⑥ <b>ALARM BOX</b> : ALARM BOX(SD-250) connector</p> | <p>⑦ <b>PRT or D/L(9)</b> :<br/>PRINTER (OKI / DPU-414) connector or<br/>PROGRAM Down Load connector</p> <p>⑧ <b>REMOTE(9)</b> : REMOTE INTERFACE connector</p> <p>⑨ <b>MOD or NBDP(15)</b> : Outer MODEM /<br/>NBDP terminal (SN-100) connector</p> <p>⑩ <b>SPK JACK</b> : Outer Speaker connector JACK</p> <p>⑪ <b>EARTH</b> : SYSTEM GROUND</p> <p>⑫ <b>+24V</b> : POWER(+24V) SUPPLY connector</p> <p>⑬ <b>FUSE</b> : 30A FUSE</p> |
|--|--|

# Chapter 13. NBDP Terminal

## 13.1. NBDP Terminal Main Unit

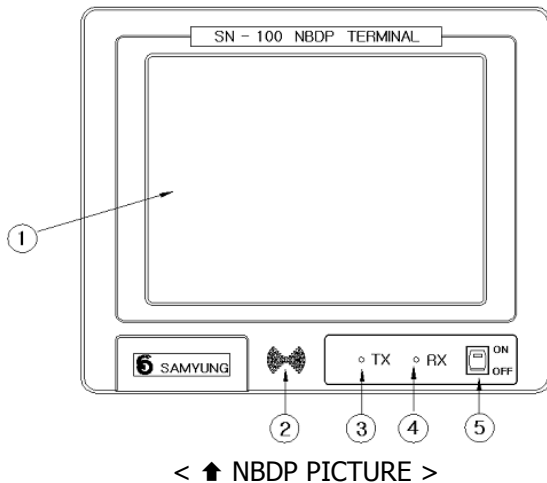

①. **FRONT PANEL (LCD):**

CHANNEL, TX/RX FREQUENCY, RF.GAIN, CLARIFY; ATT, AGC, and FUNCTION KEYS are displayed.

②. **SPEAKER** : Alarm rings when it receives data or warning signal.

③. **TX LED** : Red light on TX LED

④. **RX LED** : Green light blinks while receiving data

⑤. **POWER SWITCH** : SN-100 Power ON/OFF

## 13.2. Initial Display of Telex (NBDP) mode

• Power on, indicate first display as followings

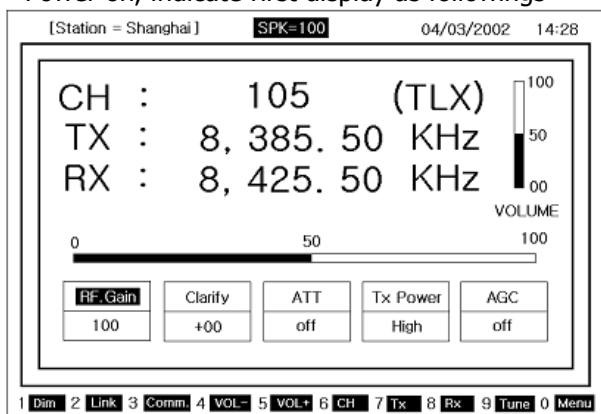

TX Power

Adjust TX power HIGH/MID/LOW

AGC

Profit of input signal ON/OFF automatically.

Vol GRAPH

Volume sound is displayed on Graphic bar (0~100 levels)

(2) **Initial screen function button explanation**

[1 DIM] : Adjust the lightness of back light on LCD display. (5 LEVEL)

[2 LINK] : Automatic Repeat request mode & FEC mode can be set up by [F2] button

[3 COMM] : Call the registered frequency.

[4 VOL-] : Volume down the speaker.

[5 VOL+] : Volume up the speaker.

[6 CH] : Set the frequency channel

[7 TX]: TX : Set TX frequency.

[8 Rx]: RX : Set RX frequency.

[9 Tune] : is used when user want to do matching to antenna.

[0 Menu] : Indicate Main Menu

0. [ARQ] : Communicate with Automatic Repeat Request Mode.

1. [FEC] : Communicate with 1 way Forward Error Correction.

2. [Station Edit] : Register the frequency of the other station.

3. [Station Print] : Print out the frequency of registered the other station.

4. [Macro Command] : Write Macro command. (Write short sentence in 20 words)

5. [Editor] : Edit file and save content.

6. [System set] : Use while adjusting TELEX mode condition.

(1) **Initial screen function explanation**

CH Indicate calling channel and present channel

TX Set transmitting frequency

RX Set receiving frequency

BAR GRAPH Indicate adjusting portion as Bar Graph

RF GAIN Adjust the portion of RF GAIN properly using up/down with direction keys. (0~ 100steps)

CLARIFY The button to adjust the clarity of RX. Using direction button, increase or decrease to gain the best RX. (Adjustment range: ±10Hz)

ATT Function to reduce the RX gain. This function can be adjusted in 4 steps using up/down button.

OFF : 0dBm, 2 : 20 dBm

1 : 10dBm, 3 : 30 dBm

- 7. **[NBDP Test]** : Transmitting signals of Dot, Mark, Space. Use for testing printer and NBDP TX/RX condition.
- 8. **[LCD-off (F12)]** : The function of LCD off and in the case that LCD is off, if any button is pressed, LCD is on.

**(3) Control function in Keyboard**

- [PgUp]** : Adjust channel to next channel. But if next channel is not registered, it moves to next channel of it.
- [PgDn]** : Adjust channel to forward channel. But, if forward channel is not registered, it moves to forward channel of it.

**13.3. SettingUpTX/RX Frequency**

• UNIT: kHz

**(1) Setting TX frequency**

- a) Press **[F7]** button on the keyboard.
- b) Input the frequency with **[Number button]**.  
**[Ref.]** While inputting frequency if press **[←]**, **[→]**, cursor will move.
- c) Press **[Enter]** button.  
**[Ref.]** Available TX Frequency range: 1.6MHz ~ 27.5MHz.

**(2) Setting Rx frequency**

- a) Press **[F8]** button.
- b) Input the frequency with **[Number button]**.  
**[Ref.]** While inputting frequency if press **[←]**, **[→]**, cursor will move.
- c) Press **[Enter]** button.  
**[Ref.]** Available RX Frequency range: 95 KHz ~ 29.99999MHz.

**(3) Coast Radio Station TX/RX frequency set up**

- a) Press **[F3]** button, display as followings.

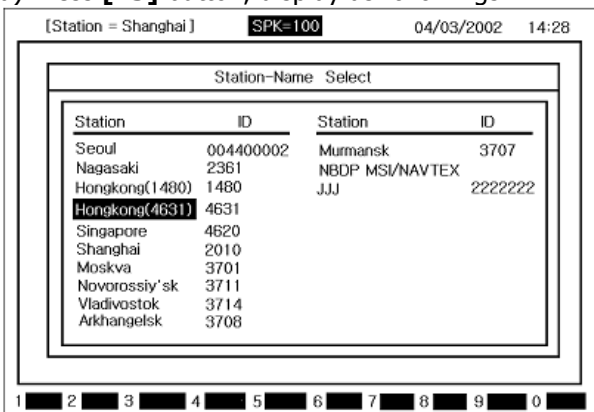

- b) Revert the other station you want to communicate using **[↑],[↓],[←],[→]** button. → press **[Enter]** button, the following screen will show.

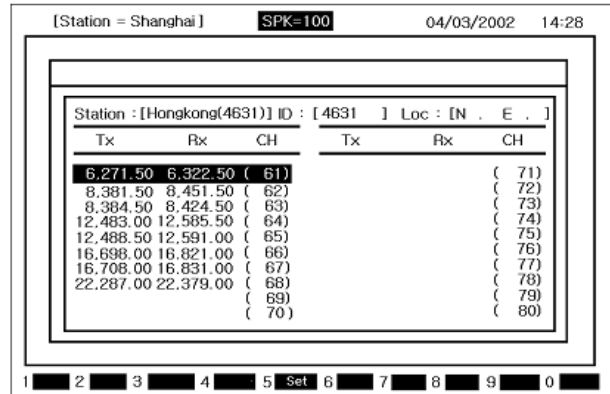

- c) Revert the channel you want to communicate using **[↑],[↓],[←],[→]** button. → press **[Enter]** button. Set TX/RX frequency to registered freq. on channel displaying the first display of NBDP.

**(4) Setting TX/RX Freq. by calling channel**

- a) Press **[F6]**.
- b) Input the channel with **[Number button]**.
- c) Press **[Enter]** button.

**13.4. [ARQ] mode**

**(1) Connecting with the other station by ARQ mode.**

- Connecting by present adjusting channel.
- a) Press **[F2]** button on the keyboard and **Link Menu** screen shows.

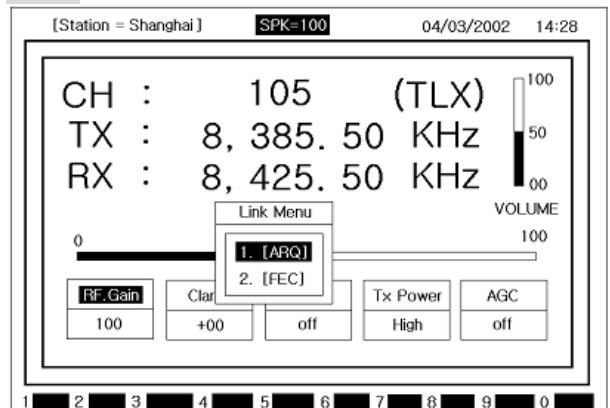

- b) Move the cursor with **[↑],[↓]** button to '1. [ARQ]' → press **[Enter]**, then it will be connected with other party through **[ARQ]** mode in present setting Channel.

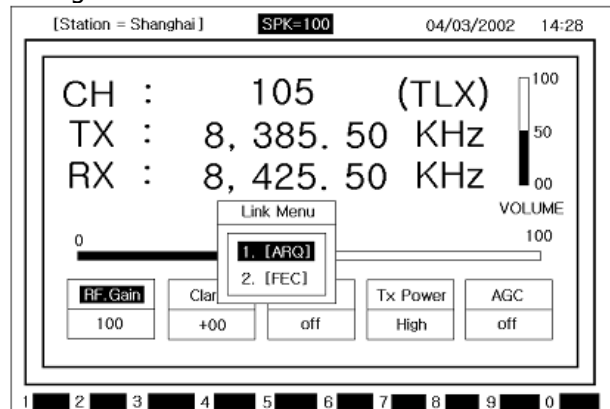

## (2) Connecting specific station

a) Call the menu pressing **[F10]** to call SUB MENU key.

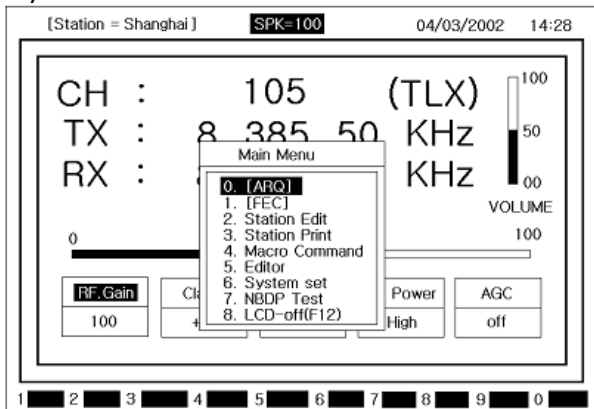

b) Move the cursor with **[↑]/[↓]** button to '0. [ARQ]' → press **[Enter]** and the following screen will appear.

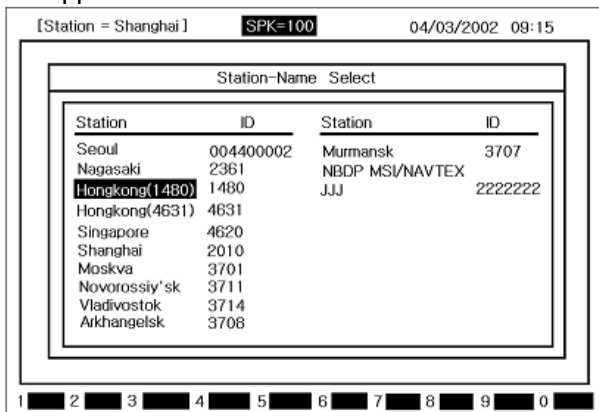

c) Revert the other station you want to communicate using **[↑],[↓],[←],[→]** button. → press **[Enter]** button, the following screen will show.

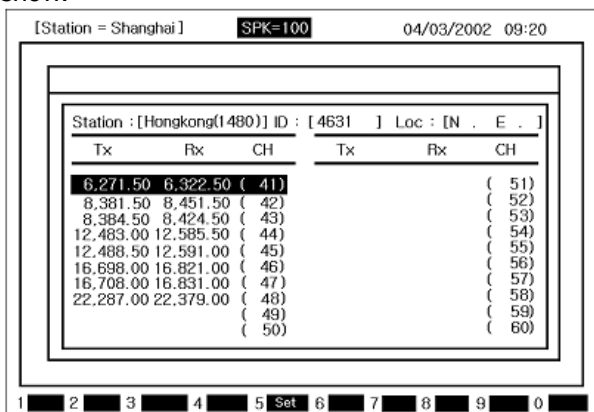

**[Ref.]** can be back to forward display pressing **[ESC]** button.

d) Revert the channel you want to communicate using **[↑],[↓],[←],[→]** button.

→ press **[Enter]** button.

e) Call the other station with selected frequency displaying next **[ARQ]** mode first display.

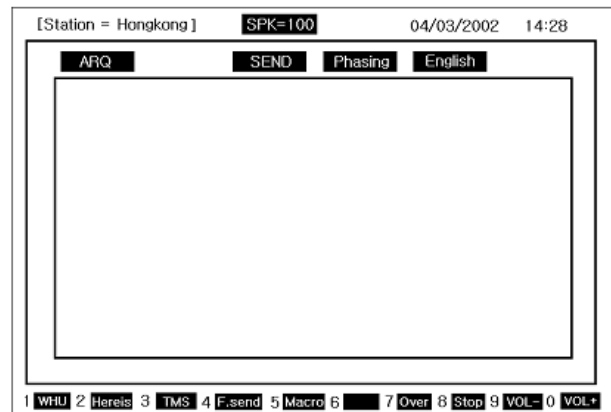

**[Ref.]** to stop calling, press **[F8]** and it will be back to Telex initial screen.

f) If connected, cursor blinks on the left top of the screen.

## (3) Communication in ARQ mode

• Perform **(1)** or **(2)** and operate as below order.

a) As long as you can connect with the other station in **[ARQ]** mode, above screen is displayed. You can keep communicating in this condition.

b) After typing the message with keyboard, press **[Enter]** button.

**[Ref.]** Back space - delete one character on the left. Before you press **[Enter]** button, transmitting is not complete.

c) Usable keys in ARQ mode

• **The usable characters:**

ABDCDEFGHIJKLMNOPQRSTUVWXYZ1234567890  
-? ( ).' =/+abcdefghijklmnopqrstuvwxyz

• **[Back space]** : Delete one character on the left

• **[Enter]** : Send one line.

• **[Left Shift] + [Space]** : Convert language.  
(English, Russian)

[Korean] is selected : [Korean] / [English] shift

[English] is selected : [English]

[Russian] is selected : [Russian]/[English] shift

• **[F1]** : [1 WHU] - Demand Answer back code of the other station.

• **[F2]** : [2 Hereis] - Transmit Answer back code of yourself.

• **[F3]** : [3 TMS] - Transmit the present time

• **[F4]** : [4 F.send] - Transmit the file written in edit mode. (Refer to (4) TX of file)

• **[F5]** : [5 Macro] - You can use the sentence no. Written in Macro Command  
(Refer to '(5) Macro Command RX)

• **[F7]** : [7 Over] - Convert the direction of transmitting the message.

• **[F8]** : [8 Stop] - Stop communication.

• **[F9]** : [9 VOL-] - Volume can be reduced.

• **[F10]** : [0 VOL+] - Volume can be increased.

**(4) Transmitting file**

• After performing '(1)' or '(2)', operate the unit as below order.

a) Press Function button [F4] → Move the cursor to the file you want using [↑]/[↓] button → Press [Enter] button and the file will be transmitted showing the file contents on the screen.

[Ref.] ☞ pressing [F8] button is able to stop transmitting.

**(5) Transmitting of Macro Command**

• After performing '(1)' or '(2)', operate the unit as below order.

a) Press Function button [F5] → Move the cursor to the sentence no. to be transmitted using [↑]/[↓] button → Press [Enter] button and the sentence will be transmitted showing the command contents on the screen.

[Ref.] ☞ pressing [F8] button is able to stop transmitting.

**13.5. [FEC] mode**

**(1) Connecting the other station by Selective FEC mode.**

• Communication with present selecting Channel

a) Press [F2] button on the keyboard and **Link Menu** screen shows.

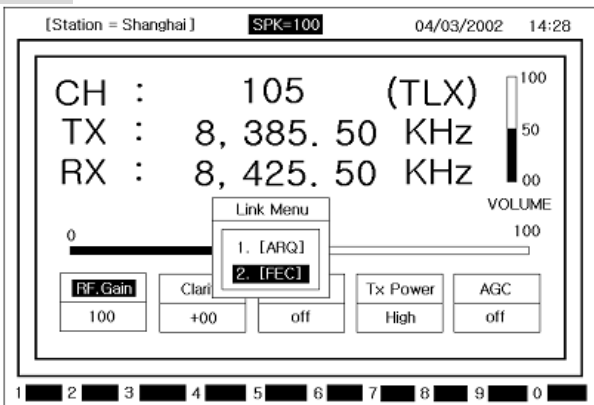

b) Move the cursor to **2. [FEC]** with [↑]/[↓] button → Press [Enter] and the following screen shows.

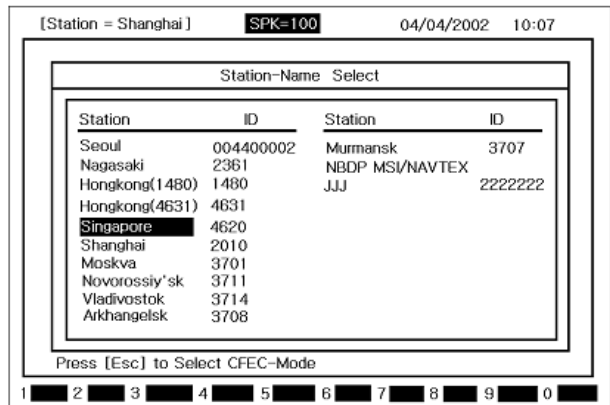

c) Revert the other station you want to communicate using [↑],[↓],[←],[→] button.

→ press [Enter] button, the following screen will show.

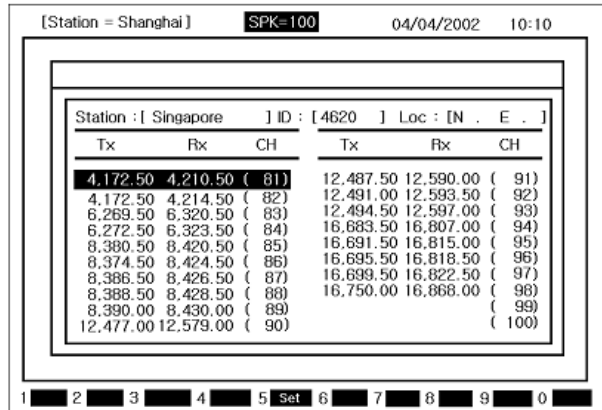

[Ref.] ☞ to be back to forward display. Press [ESC] button.

d) Revert the channel you want to communicate using [↑],[↓],[←],[→] button.

→ press [Enter] button.

e) Call the other station with selected frequency displaying next [SFEC] mode first display.

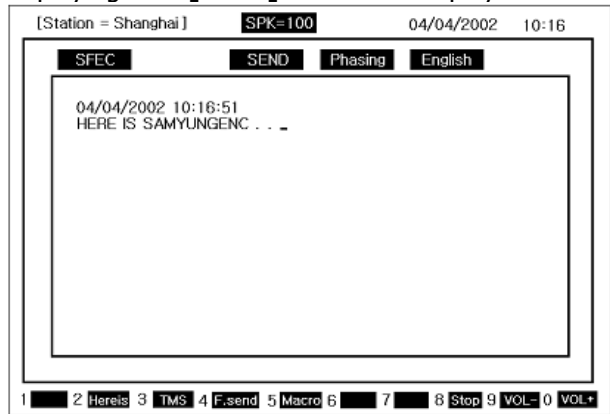

[Ref.] ☞ to stop calling, press [F8] and it will be back to Telex initial screen.

f) If connected, cursor blinks on the left top of the screen.

## (2) Connecting with the other station by collective FEC mode.

a) Press **[F10]** button on the keyboard and **Main Menu** screen shows.

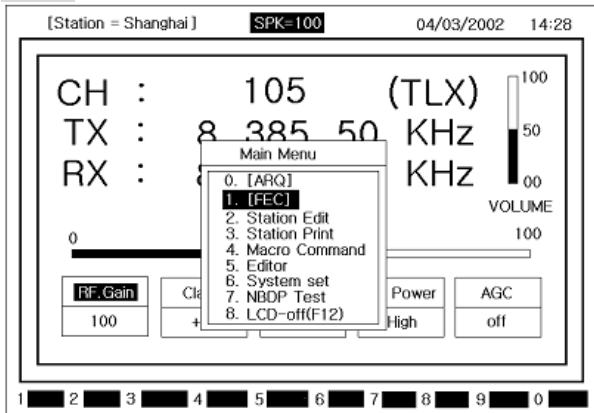

b) Move the cursor to **1. [FEC]** with **[↑]/[↓]** button → Press **[Enter]** and the following screen shows.

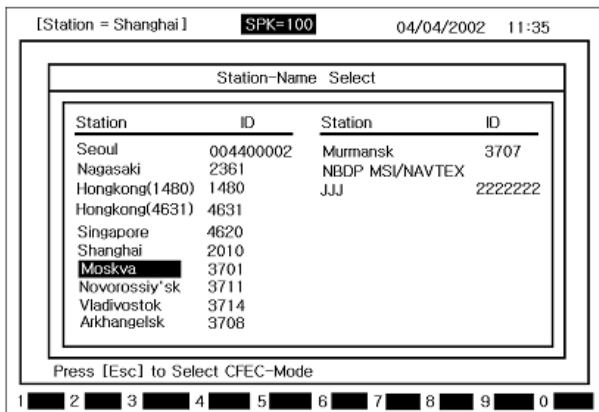

c) Press **[Esc]** button and **[CFEC]** mode initial screen shows. Display counter party with the frequency of the channel which was set up on the Telex initial screen.

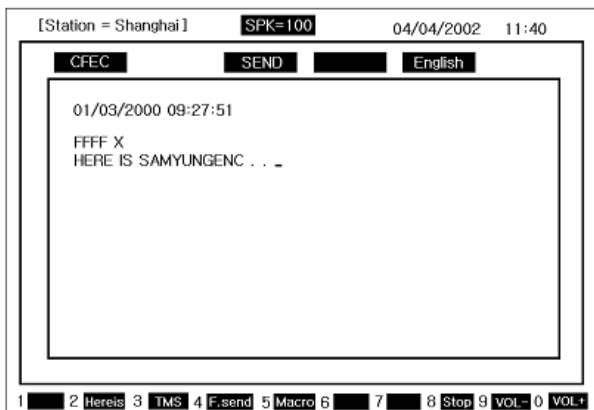

**[Ref.]** to stop calling, press **[F8]**, Then it is changed to first display of Telex.

d) When the call is connected with counter party, cursor blinks on the top left of message screen.

## (3) Communication in FEC mode

• After performing **'(1)'** or **'(2)'** above, operate the unit as following order.

a) When the telex is connected with counter party in FEC mode, initial screen of **[CFEC]** Mode shows and the communication starts on this condition...

b) After typing message with keyboard, press **[ENT]** to send.

**[Ref.]** Transmitting is not available unless you press **[Enter]** button.

c) Usable keys in FEC mode

• **The usable characters:**

ABCDEFGHIJKLMNOPQRSTUVWXYZ1234567890

- ? ( ) . ' = / + abcdefghijklmnopqrstuvwxyz

• **[Back space]** : Delete one character on the left

• **[Enter]** : Send one line.

• **[Left Shift] + [Space]** : Convert language.  
(English, Russian)

[Korean] is selected : [Korean] / [English] shift

[English] is selected : [English]

[Russian] is selected : [Russian]/[English] shift

d) The use of **[Function]** button on the initial screen of **[FEC]** mode.

**[Ref.]** Message can be transmitted by **[Function]** button on the **[FEC]** mode initial screen.

• Press the function button → Press **[Enter]** button to transmit.

• Select the function with material → Press **[Enter]** button to transmit.

• **[F2]** : [2 Hereis] - Transmit Answer back code of yourself.

• **[F3]** : [3 TMS] - Transmit the present time

• **[F4]** : [4 F.send] - Transmit the file written in edit mode. (Refer to (5) TX of file)

• **[F5]** : [5 Macro] - Sentence no. made in Macro Command can be selected and used.

(Refer to (6) Macro Command TX article)

• **[F8]** : [8 Stop] - Stop communication.

• **[F9]** : [9 VOL-] - Reduce speaker volume

• **[F10]** : [0 VOL+] - Increase speaker volume

## (4) Receiving of FEC mode

a) If the data of FEC mode is received, automatically, it is printed. And, when it is completely received, automatically, it is saved.

b) To open the file, on the initial screen, select **[F10]** → **[5. Editor]** mode → **[Enter]** → **[F1]** (1 Lord) → select the file among **RECV 01~RECV 20** → Press **[Enter]** button and you can see the file.



**(5) Transmitting file**

• After done above (1) of (2), follow the operation as below.

a) Press **[F4]** and below screen is displayed.

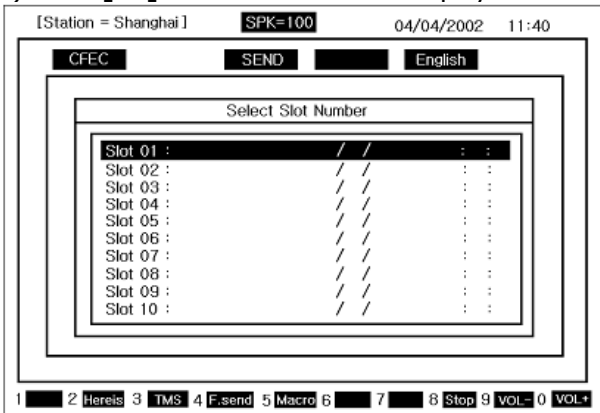

→Select the file to transmit with **[↑]/[↓]** button  
 →press **[Enter]** button and file will be transmitted showing the contents of the file on the screen.

**(6) Transmitting of Macro Command**

• After performing '(1)' or '(2)' above, operate the unit as following order.

a) Press **[F5]**

→moves the cursor & select sentence no. with **[↑]/[↓]** button

→ Press **[Enter]** and the command will be transmitted showing the contents of command.

**[Ref.]** pressing **[F8]** is able to stop transmitting.

**13.6. Other sea station or ship station edit & resister frequency**

a) Press **[F10]** button on the keyboard and **Main Menu** screen shows.

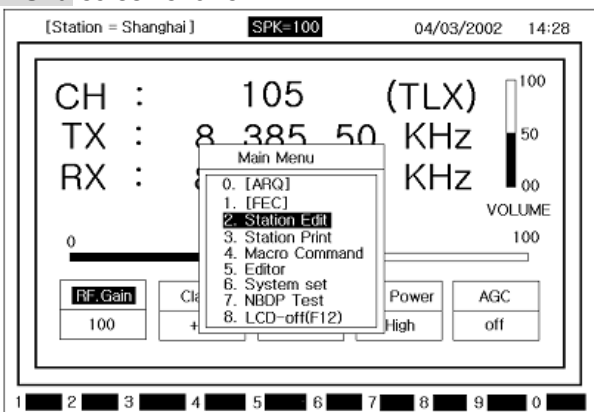

b) Move the cursor to **2. Station Edit** with **[↑]/[↓]** button →Press **[Enter]** and the following screen shows.

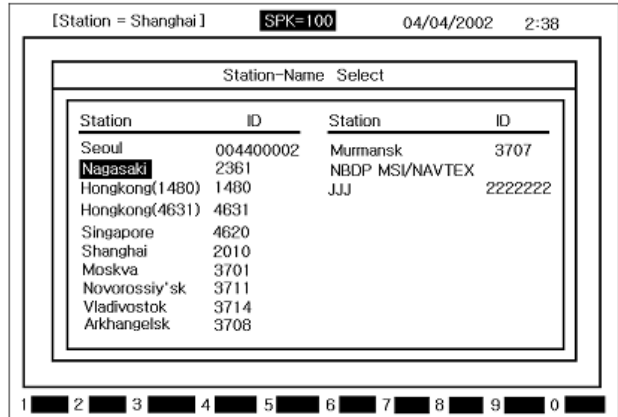

c) Revert the other station you want to communicate using **[↑],[↓],[←],[→]** button.

→ press **[Enter]** button, the following screen will show.

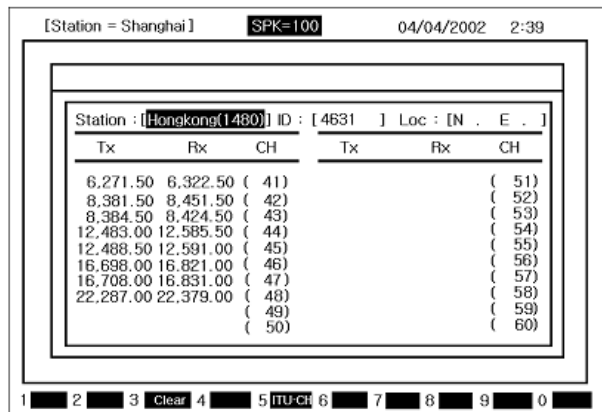

d) Move the cursor to **[Station input part]**  
 →press **[Enter]**.

e) Input **[Station name]**  
 →Press **[Enter]** and it will be saved.

f) Move the cursor to **[ID input part]**  
 →press **[Enter]**

g) Input **[ID]** →Press **[Enter]** and it will be saved.

h) Move the cursor to the **[TX]** of the channel  
 →press **[Enter]** button.

I) Input **[TX Frequency]**  
 →press **[Enter]** and it will be saved...

j) Move the cursor to **[Rx]** of the Channel  
 →press **[Enter]**

k) Input **[RX Frequency]**  
 →Press **[Enter]** and it will be saved.

L) Press **[ESC]** and **Main Menu** screen shows.

### 13.7. Station print (Counter party & Frequency print)

a) Press [F10] button on the keyboard and **Main Menu** screen shows.

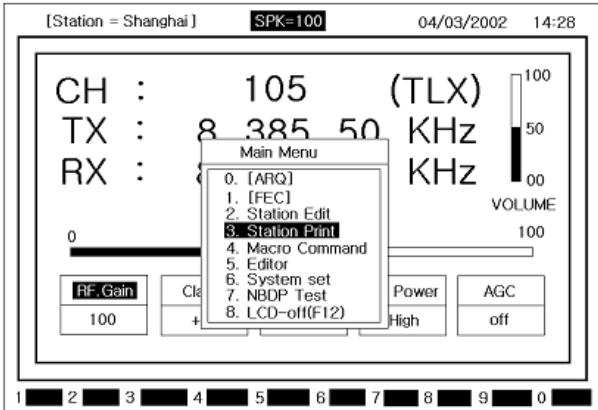

b) Move the cursor to **3. Station Print** with [↑]/[↓] button →Press [Enter] and the following screen shows.

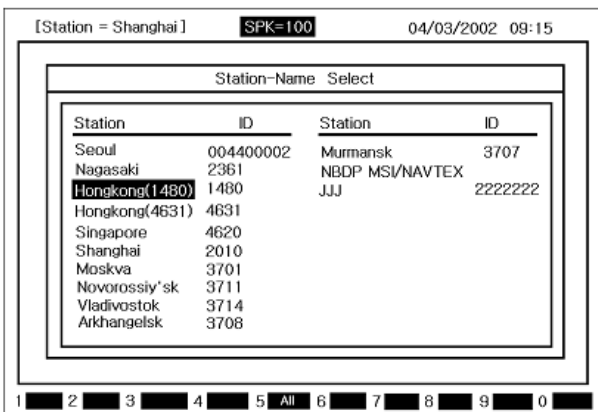

c) Move the cursor to the counter party you **want** with [↑]/[↓] button →Press [Enter] and counter party's registered contents will be printed out and will be back to **Main Menu**.

### 13.8. Registration of macro command

- Can register TXL number (that is often used) or abbreviated words in 20 words.

a) Press [F10] button on the keyboard and **Main Menu** screen shows.

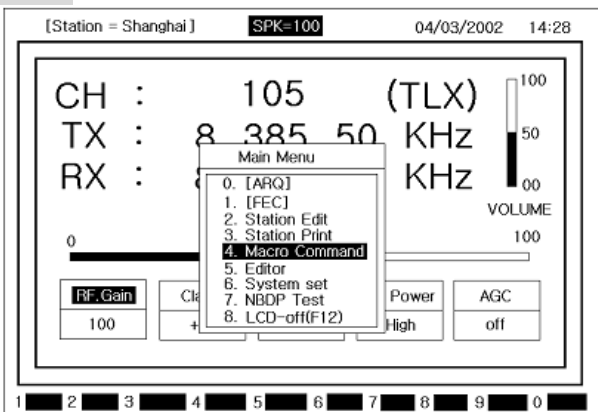

b) Move the cursor to **4. Macro Command** with [↑]/[↓] button →Press [Enter] and the following screen shows.

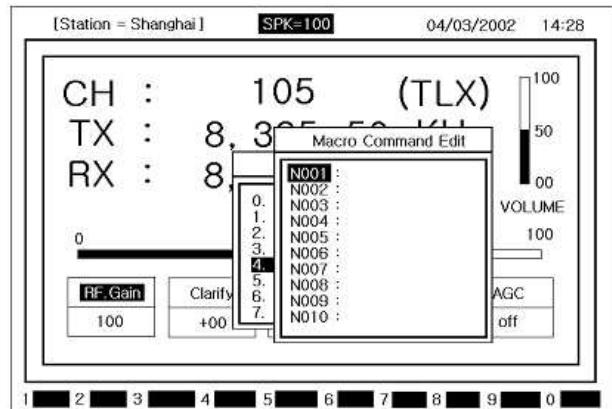

c) Move the cursor & select the command no. with [↑],[↓],[←],[→] button→[Enter]

→Type command with keyboard

→Press [Enter] and it will be saved.

d) Press [ESC] and **Main Menu** screen shows.

### 13.9. Editor mode

a) Press [F10] button on the keyboard and **Main Menu** screen shows.

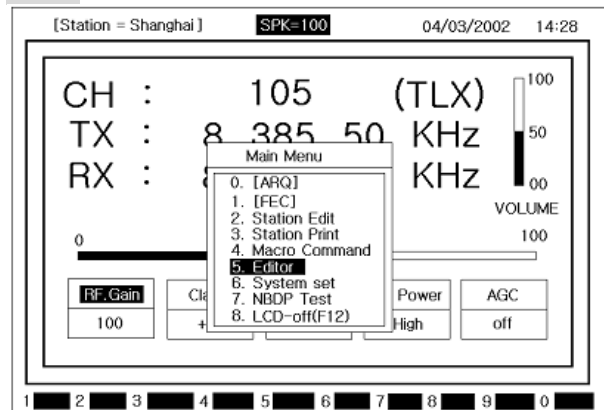

b) Move the cursor to **5. Editor** with [↑]/[↓] button →Press [Enter] and the following screen shows.

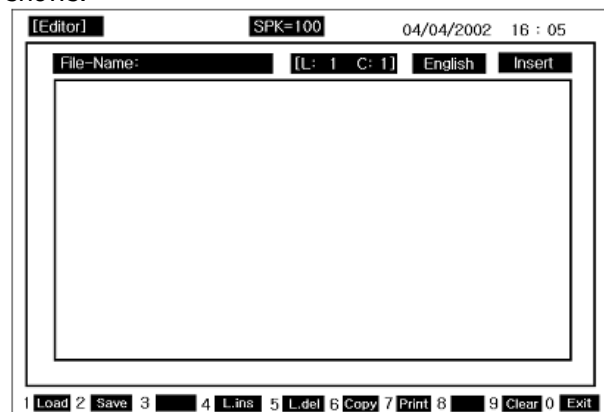

c) Message can be written and revised. Also FEC, NAVTEX, Received DATA is saved here.

**[Ref.]** The Function can be used to make message using **[function key]** on the bottom of Edit message screen.

d) Press **[F2]** →input **File-Name**→**[Enter]**  
 → **Select Slot no.** on the **Slot Number** screen  
 →press **[Enter]** and it will be saved and it will be back to Edit screen message screen.

e) Press **[F1]** and you can call the saved message, FEC, NAVTEX, RX data.

**[Ref.]** From **Slot 01** ~ to **Slot 20** User can save the file, from **RECV 01** to **RECV 20**, **FEC Received Data**, **NAVTEX Received Data** are automatically saved.

**[Ref.]** Press **[ESC]** and back to edit msg screen.

f) Press **[F10]** and **Edit Exit?** Screen shows  
 →select **Yes**→Press **[Enter]** and it will back to **Main Menu**.

### 13.10. Initial setting of system set

a) Press **[F10]** button on the keyboard and **Main Menu** screen shows.

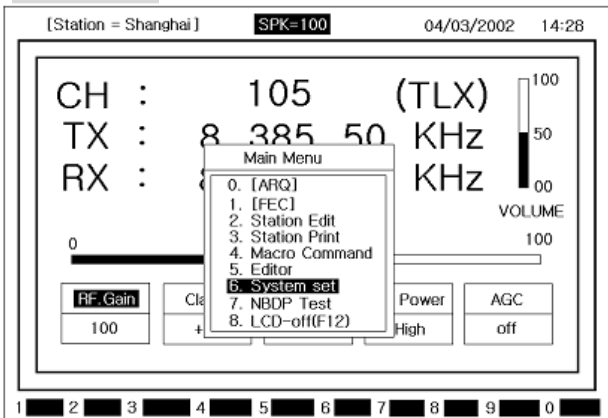

b) Move the cursor to **6. System Set** with **[↑]/[↓]** button →Press **[Enter]** and the following screen shows.

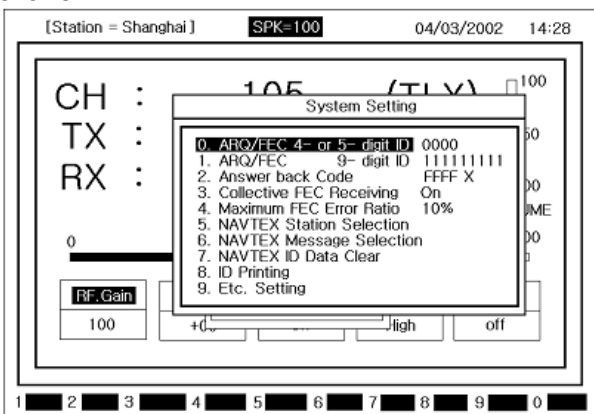

#### (1) Setting of [0. ARQ/FEC 4~ or 5~digit ID]

- After '(b)'
- select **[0. ARQ/FEC 4- or 5-digit ID]**
- [Enter]** →Input the ID with **[Number]** button
- [Enter]** →press **[ESC]** and it will be saved and back to **Main Menu**

**[Ref.]** this will be done during installation and the user can not change.

#### (2) Setting of [1. ARQ/FEC 9-digit ID]

- After '(b)'
- select **[1. ARQ/FEC 9-digit ID]**→**[Enter]**
- input the ID with **[Number]** button→**[Enter]**
- press **[ESC]** button and it will be saved and back to **Main Menu**

**[Ref.]** this will be set up during installation and users can not change.

#### (3) Setting of [2. Answer Back Code]

- After '(b)'
- select **[2. Answer Back Code]**→**[Enter]**
- input the code with **[Number & Alphabet]** button
- [Enter]**→press **[ESC]** button and it will be saved and back to **Main Menu**

ex) MMSINo.9 digit    ANS/Back code    X    ⇒

**123456789\_ABCD\_X**

**[Ref.]** this will be done during installation and users can not change.

#### (4) Setting of [3. Collective FEC Receiving]

- After '(b)'
- select **[3. Collective FEC Receiving]**
- select **[On]** or **[Off]** with **[Enter]** button
- press **[ESC]** and it will be saved and back to **Main Menu**

#### (5) Setting of [4. Maximum FEC Error Ratio]

① If RX character error rate in the FEC MODE is higher than the set up value, the RX will stop. (Example, if error rate set up value is 30%, the error rate is above 30%, the RX will stop.)

② How to set up

- After '(b)'
- select **[4. Maximum FEC Error Ratio]**
- [Enter]**→input the ratio by **[Number]** button
- [Enter]**→press **[ESC]** button and it will be saved and back to **Main Menu** screen.

**[Ref.]** Value ranges from 1 to 100.

## (6) Selecting of [5. NAVTEX Station Selection]

① Function to select NAVTEX station RX. Select the character from A to Z with [←]/[→] button and you can choose whether you receive with the first character of station or not.

② How to set up

After '(b)' → select [5. NAVTEX Station Selection] → [Enter] → NAVTEX Station Selection Set Up screen will show → set up 'O / X' for the first character of the station with [←]/[→] button & [Enter] button → press [ESC] button and it will be saved and back to **System Setting** Menu.

- **O** : Recognized as the station is possible to receive NAVTEX broadcasting.
- **X** : Recognized as the station is not possible to receive NAVTEX broadcasting

## (7) Selecting of [6. NAVTEX Message Selection]

① Function to select whether you receive NAVTEX message or not. From **C, E** to **Z**, select each character with [←]/[→] button and you can select whether you receive or not with the first character.

② How to set up

After '(b)' → select [6. NAVTEX Message Selection] → [Enter] → NAVTEX Message Selection set up screen shows → Set up O/X for the message starting character with [←]/[→] button & [Enter] button → Press [ESC] and it will be saved and back to **System Setting Menu** screen.

- **O** : Recognized as NAVTEX starting message.
- **X** : Not Recognized as NAVTEX starting message.

[Ref.] ☞ **A, B, D** is set up as RX always.

## (8) Selecting of [7. NAVTEX ID Data Clear]

① Use this menu to delete the received Navtex ID

② How to set up

After '(b)' → select [7. NAVTEX ID Data Clear] → [Enter] → NAVTEX ID Data Clear? Screen shows. → Select **Yes** → Press [Enter] and NAVTEX ID Data will be deleted and back to **System Setting Menu** screen.

## (9) [8. ID Printing] set up

After '(b)' → select [8. ID Printing]

→ press [Enter] and own country ID is printed out.

## (10) [9. Etc. Setting] set up

① After '(2)' → select [9. Etc Setting]

→ press [Enter] and the following screen will show.

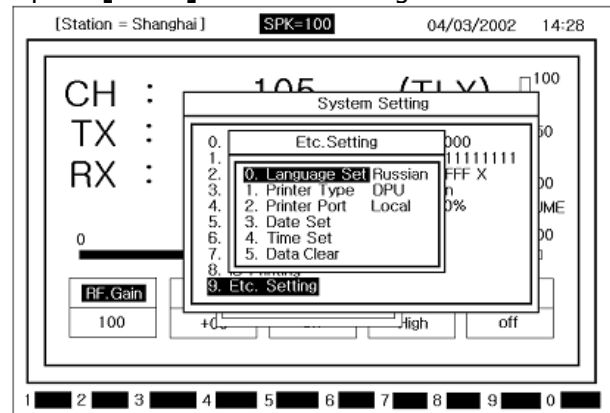

② Items can be reset with [↑]/[↓] button & [Enter] button.

- **0. Language Set** : Set up Language  
Korean  
Russian  
English
- **1. Printer Type** : Set up Printer type  
OKI  
DPU
- **2. Printer Port** :  
Local (Main unit printer)  
Remote (SN-100 printer) can be set up.

[Ref.] ☞ regarding the above '0, 1, 2 article', select the item and press [Enter] to shift the function and select the function you want.

- **3. Date Set** : Set up date
- **4. Time Set** : Set up time

[Ref.] ☞ to set up the above '3, 4', select the item and press [Enter] → input [Number button] → Press [Enter] and it will be saved and input window will disappear.

- **5. Data Clear** : There are sub menu like below.
  - 0. Memory-data Clear**  
→ Delete the Station Name.
  - 1. Edit-File Clear**  
→ Delete the Macro Command File & Editor File.
  - 2. FEC-Recv-File Clear**  
→ Delete the received FEC-Recv-File.

### 13.11. NBDP test

a) Press **[F10]** button on the keyboard and **Main Menu** screen shows.

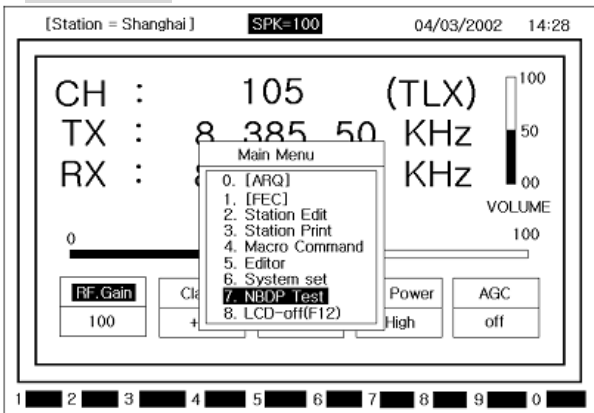

b) Move the cursor to **7. NBDP** with **[↑]/[↓]** button → Press **[Enter]** and the following screen shows.

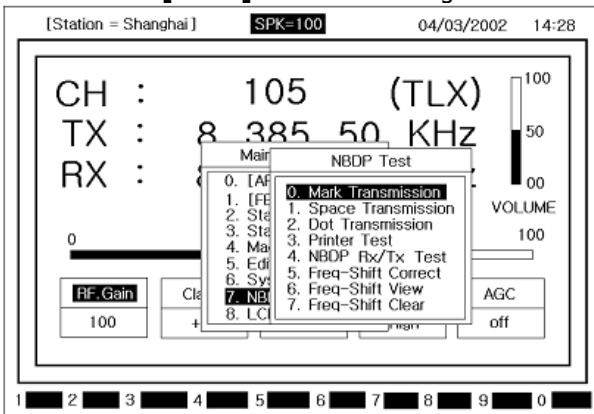

c) How to operate NBDP Test function  
 Select cursor with **[↑]/[↓]** button  
 → Press **[Enter]** and each function operates. If you want to change the function, press **[Enter]**.

- ① **0. Mark Transmission** : 1.7 kHz -85 Hz signal is transmitted for 40 seconds.
- ② **1. Space Transmission** : 1.7 kHz + 85 Hz signal is transmitted for 40 seconds.
- ③ **2. Dot Transmission** : 1.7 kHz - 85 Hz signal is transmitted for 40 seconds.
- ④ **3. Printer Test** : Check the printer status by printing the test print.
- ⑤ **4. NBDP Rx/TX Test** : Test NBDP terminal by TX/RX signal.
- ⑥ **5. Freq-Shift Correct**: Function to compensate 1<sup>st</sup> Local frequency. Transmitter send 14MHz +1400Hz signal and exclusive receiver receives the signal and compensate the 1<sup>st</sup> local frequency.

⑦ **6. Freq-Shift View** : After Freq-Shift Correct, this shows how well the frequency compensation is done.

**[Ref.]** → press **[Enter]** button or **[ESC]** button and it will be back to **NBDP Test Menu** screen.

⑧ **7. Freq-Shift Clear** : Function to clear the frequency compensation.

**[Ref.]** **Freq-Shift Correct precaution**

- ① Operate main unit and terminal after full warm-up
- ② Perform NBDP RX/TX Test and check it is ok.
- ③ Check the Freq-Shift View
- ④ Perform NBDP RX/TX Test and check the test result is ok.

### 13.12. LCD Off

(1) Operation on MENU

a) Press **[F10]** button on the keyboard and **Main Menu** screen shows.

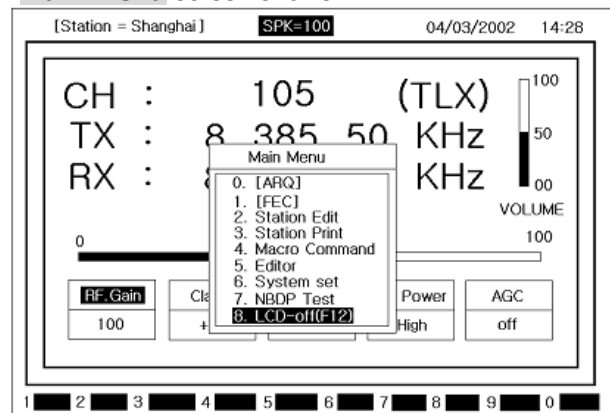

b) Move the cursor to **8. LCD-Off (F12)** with **[↑]/[↓]** button

→ press **[Enter]** button and LCD screen will be **off**.

c) Other function is working except LCD off. If any button is pressed or reception is made, LCD will be on.

(2) How to use this function with function key

a) Press **[F12]** and LCD will be off.

b) Other functions are on except LCD. If any button is pressed or RX is done, LCD screen will be on.

## Chapter 14. NBDP Terminal Circuit

### 14.1. Overview

- SN-100 consists of NBDP Receiver, CONNECTION BOARD, CPU BOARD, PLL BOARD, and POWER SUPPLY.
- There is power input, SRG-3150DN connector, W/K receiving connector, TX AND RX cable connector, EARTH Plate, keyboard connector, EMC LIGHT connector in the down part of rear side.

### 14.2. Connection board T-130

- As T-130 is PCB which is connecting CPU BOARD and other PCBs, when receiving, the signals that come from NBDP receiver pass active filter consisted of IC5, IC6, IC7, IC8 and then, as it is made square wave as clipping through U5, DOT/PATTERN signal is generated. When receiving, 1.7kHz±85Hz signals are generated through DM1 and then it is delivered to SRG-3150DN.

### 14.3. NBDP receiving unit (T-132)

- T-132 PCB is NBDP receiving unit which consists of frequency filter and amplifier, MIXER, ATT, AGC, B.K control circuit.
- After the signals received through MF/HF Antenna amplify with wide amplifier, it is divided into two parts through SPLITTER (SP1)

① The inside of NBDP Receiving unit

The signal that comes into filter selects the filter

assigned each frequency as U4 and U6. And, 1<sup>st</sup> LOCAL through IC2, 2<sup>nd</sup> LOCAL through IC1, and BFO signal through U1 should be mixed. And then, MARK (1.7kHz-85Hz) and SPACE (1.7 kHz + 80 Hz) signals are generated.

② One side is delivered to SRG-3150DN through attenuator and matching tool.

### 14.4. Local Synthesizer board (T-133)

- As T-133 is SYNTHESIZER PLL PCB, PLL IC and VCO (POS-100) make up PLL. And, it is outputted to 1<sup>st</sup> LOCAL input-signal and, as 7 MHz that is generated from output of PLL IC (IC15) generates 49MHz in 7 multiply circuit, it is used as 2<sup>nd</sup> LOCAL. BFO signal is that DM1 received 7MHz generated 456.7 kHz. Besides, as it transmits and receives with CPU BOARD it generates the signal that controls NBDP receiver.

### 14.5. Power Circuit (T-025)

- Power circuit consists of constant voltage circuit. And while power on, it makes ON main power DC 24V, convert constant voltage +12V, +8V, +5V. If it is overpowered +32V, then power off. Prevention to reversing voltage circuit is built-in.

### 14.6. Function Diagram of Rear Side

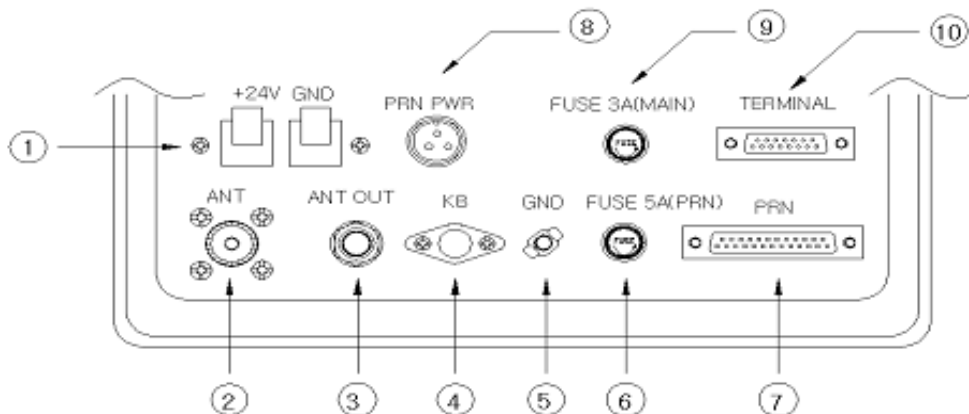

- ① **EMC** : Supply power +24 to emg light.
- ② **RX ANT IN** : Impedance 50Ω MF / HF RX ant Input jack.
- ③ **ANT OUT** : Connect which send W/K signal Received from 'RX /ant in' to main unit
- ④ **Key-Board** : Connect between keyboard and SN-100. Supply +5V. Data. clk etc.
- ⑤ **GND** : Receiver System Ground

- ⑥ **FUSE** : 5A Fuse(Printer +24V Fuse)
- ⑦ **Printer** : Connect to Printer
- ⑧ **Printer Power** : Connector which supplies +24V, +8V, GND to printer
- ⑨ **FUSE** : 3A Fuse(Power Supply Fuse)
- ⑩ **Connector To Main Unit** :  
When connected to SRG-3150DN, transceiver PTT IN, PTT OUT, READY, Data AF+, AF-.

## Chapter 15. Troubleshooting

### 15.1. Overview

- Cause of TROUBLE in equipment, similar to mechanic cause and electronic cause appeared in external and inner of

Equipment. These can be block by periodic check. This function has various protecting circuit for trouble of external or inner and blocking damage of circuit and part.

However, in case of having trouble and damage, users have to find out problem.

i.e., user should recognize first whether badness of equipment-self or external problem. To hold the performance of the initial equipment and the life, it needs regular checking and wrong checking and wrong repair can reduce the performance and life. Therefore, users should know following contents for right checking and repair.

### 15.2. Measuring Instrument

- These equipment products for international radio telephone rule. Maintenance & adjustment of this equipment have to control from correcting test center by rated testers must have testers for maintenance & adjustment daily as follow.

(1) Multi-tester for check for check that don't need to be delicated ohm, Voltage, current.

(2) TEST PROBE that can be change from high-frequency signal to direct current.

(3) High-frequency transit power supply that can be check of traveling wave of until 1.6MHz ~ 27.5MHz band max 150W ~ 500W

(4) 100MHz band max 150W, dummy load of 50Ω

(5) Frequency counter that can be check 100MHz band

(6) OSCILLOSCOPE that can be check 100MHz band

(7) Other testers

### 15.3. Maintenance & repair of SRG-3150DN

#### (1) Antenna

- When happened interface (receiving sensitivity degrees, duplex communication interface) during installation or using, have to check to fault of antenna for the first time.

a) Check that antenna control to vertical bearings (WHIP ANTENNA) correctly.

b) Check that posits metal things around antenna.

c) Is it O.K connect condition & insulation of antenna and connecting parts between transmitter receiver.

d) After connecting the high-frequency wattmeter between this equipment and ATU, measure the progress wave and the reflected wave. If the

VSWR(Voltage Standing Wave Ratio) is less than 2:1, the connection of the antenna, connectors and coaxial cable is stable and the parts have no defect. If the VSWR is more than 2:1, the connection of the antenna, connectors and coaxial cable is bad or the parts have defect.

#### (2) Power Supply

- Check power supply circuit even though volume & squelch control, not appear any sound and display at the front panel after connect power transmitter - receiver

a) Check is cut the fuse after open fuse holder at the rear of transmitter receiver. (Fuse: 30A)

b) Is it correct connects condition power connecting at rear of the transmitter receiver. (Fuse be cut in case of power polarity supply opposite)

c) Check power supply voltage at the power supply connector.

If  $24V \pm 10\%$  is (21.6 ~ 26.4V), it's correct. Have to maintenance if over or less, the badness of power supply equipment (POWER SUPPLY or BATTERY)

d) Change same goods if check power circuit T-1110 PCB (SRG-3150DN), it is badness.

#### (3) Transmitter

- Check follow as when hand set is correct. When transmitter switch hand set can't receiver at the operating, check the connecting condition.

a) Check antenna & power. Can't receiver when channel selecting is incorrect or selected ban channel.

b) Check T-1110(SRG-3150DN) PCB and T-1113(SRG-3150DN) PCB, if this part is not good, have to change.

c) Not able to receive from unmatched channel and error sign is displayed.

#### (4) Receiver

- After check each switch selecting is correct for the first time, check as follow

a) Check connects of speaker after check air antenna or power.

b) Check T-1110 PCB, if this part is not goods, have to change same goods.

c) Check to become OFF MODE, check MAIN or EXTERNAL speaker select correctly.

#### (5) DSC Receiver

- After check each switch selecting is correct for the first time, check as follow.

a) Check air antenna connection for DSC.

b) Check T-1112 or T-1110 PCB of inside of equipment, if this part is not good, have to change same goods.

## (6) Switch and Display

- According to manual, confirm error using or setting value and in case of no error, check as follows.

a) Check T-1114 PCB. In case of error, replacing same product.

b) Check connector and LCD or cable connected to T-1110 PCB of or T-1114 PCB of equipment. In case of error, replacing same product.

## 15.4. NBDP SN-100

- As SN-100 is NBDP terminal, error can happen on transceiver, power supply, CPU BOARD, LCD. When error happens, Check as follow.

### (1) Power Supply

① Power supply is not working.

- Power voltage is +24V in only the case that power supply is connected to SRG-3150DN. And, if there is error, check the power supply switch, the connector cable to SRG-3150DN, fuse (5A), power polarity.

② No power on the screen.

- Firstly, check the +12V on U8 of T-025, +5V on DC-DC CONVERTER and then, check power supply cable that is connected power supply board and screen. If +12V is not supplied, LCD, CPU BOARD is not operated. If +5V is not supplied, CPU BOARD is not operated.

### (2) Screen Display

①. Screen display is not able to turn on.

- Check that power is correctly supplied to LCD

②. Screen is waved or there is white line on the screen.

- If the condition of the connect point of LCD connector or of LCD board are bad, connector and board should be cleaned with detergent material that is volatile.

### (3) NBDP Data Receiving

①. Data is not received.

- Firstly, check that ANT is correctly connected. Check that +12V is generated on U1 of T-025

- Check that SRG-3150DN receive W/K signal. If SRG-3150DN does not receive W/K signal, Check the third pin (IC4 of T-132) is approximately 3.2V (+ 3.2V is normal). And, check 1<sup>ST</sup>, 2<sup>ND</sup>, BFO is supplied.

- Check that 1.7 kHz  $\pm$ 85Hz on CN8 of T-132 is generated.

- Check that DOT/PATTERN signal on 13th of U9 of T-130 is generated.

- Check that DOT/PATTERN signal on 18th of IC3 of T-130 is generated.

### (4) NBDP Data Transmitting

①. Data is not transmitted

- Check the connector that is correctly connected between SRG-3150DN and terminals.

- Check that 1.7 kHz  $\pm$ 85Hz on the 11th of DM1 of T-130 PCB

- Check that the signal is supplied to SRG-3150DN

## 15.5. Modulation of simple modulator

- This equipment is designed to minimize adjust parts and all modulator (except the modulator for power supply) is to be required to manufacturer because it needs an accurate measuring instrument and a skilled technology.

## 15.6. Caution

(1) In case of checking transmitter unit, please contact dummy load.

(2) In case of separating PCB, pay attention to static electronic.

(3) In case of modulating, use tools for modulation.

(4) In case of checking or modulating, when measuring instrument contact in each circuit, user should match signal of the circuit and PROBE of measuring.

(5) In case of checking or modulating, pay attention to the difference when measuring instrument is Connected into each circuit or not.

(6) All maintenance had better be carried out in our agent or SAMYUNG ENC CO., LTD.



## **Chapter 16. Circuit Diagram & External Diagram**